

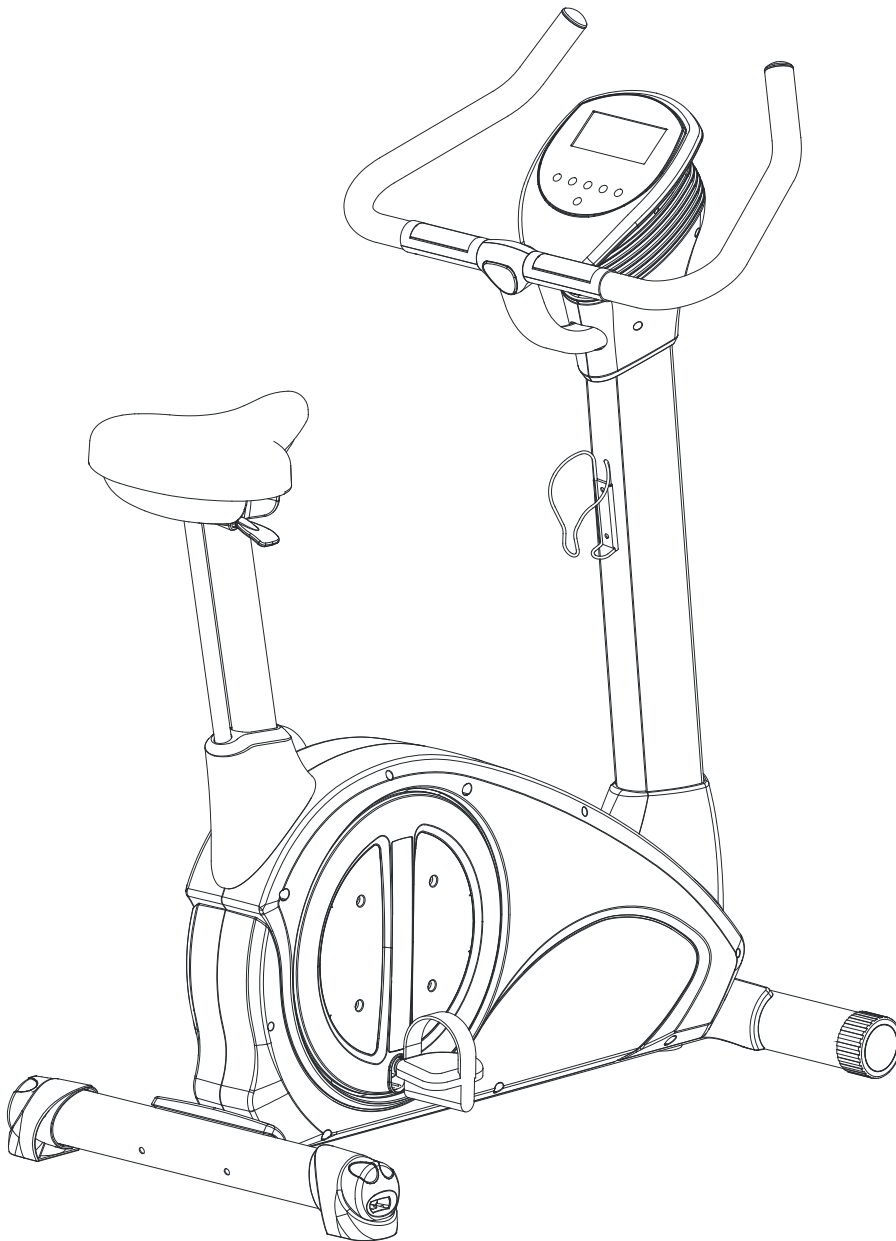

V380 Upright Bike



USER WEIGHT LIMITATION: **300lbs(136kgs)**

SERIAL NUMBER (found on frame):

PRECAUTIONS

For future service or related questions:

Please staple your receipt and/or write in the name and phone number of the retail store where you purchased your bike.

Name: _____ Phone Number: _____ Receipt: _____

Precautions:

WARNING: To reduce the risk of burns, fire, electric shock, or injury to persons, read the following important precautions and information before operating the bike. It is the responsibility of the owner to ensure that all users of this bike are adequately informed of all warnings and precautions.

- Use the bike only as described in this manual.
- Place on a level surface. Do not place the bike on any surface that blocks air openings. To protect the floor or carpet from damage, place a mat under the bike.
- When choosing a location for the bike be sure that the location and position permit access to a plug.
- Keep the bike indoors, away from moisture and dust. Do not put the bike in a garage or covered patio, or near water.
- Do not operate the bike where aerosol products are used or where oxygen is being administered.
- Keep children under the age of 12 and pets away from the bike at all times.
- The bike should not be used by persons weighing more than **300LBS (136 Kgs)**.
- Never allow more than one person on the bike at a time. Wear appropriate exercise clothing when using the bike. Do not wear loose clothing that could become caught in the bike. Athletic support clothes are recommended for both men and women. Always wear athletic shoes. Never use the bike with bare feet, wearing only stockings, or in sandals.
- When connecting the power cord, plug the power cord into a grounded circuit.
- Always examine your bike before using to ensure all parts are in working order.
- Allow the bike to come to a full stop before stepping off.
- Never insert any object or body parts into any opening.
- Follow the safety information in regards to plugging in your bike.
- Keep the power cord away from the incline wheels and do not run the power cord underneath your bike. Do not operate the bike with a damaged or frayed power cord.
- Always unplug the bike before cleaning and/or servicing. Service to your bike should only be performed by an authorized service representative, unless authorized and/or instructed by the manufacturer. Failure to follow these instructions will void the bike warranty.

PRECAUTIONS

Pour réparations futures ou questions connexes :

Please staple your receipt and/or write in the name and phone number of the retail store where you purchased your bike.

Name: _____ Phone Number: _____ Receipt: _____

AVERTISSEMENT : Pour réduire le risque de brûlures, d'incendie, d'électrocution ou de blessures, lire les précautions suivantes et informations importantes avant d'utiliser le vélo. Il est de la responsabilité du propriétaire de s'assurer que tous les utilisateurs de ce vélo sont correctement informés de tous les avertissements et les précautions.

- Utilisez le vélo uniquement comme décrit dans ce manuel.
- Placez-le sur une surface plane. Ne pas placer la moto sur une surface qui bloque les ouvertures d'air. Afin de protéger le plancher ou le tapis de tout dommage, placez un tapis sous la moto.
- Lorsque vous choisissez un emplacement pour le vélo être sûr que l'emplacement et la position de permettre l'accès à un bouchon.
- Gardez le vélo de l'intérieur, loin de l'humidité et la poussière. Ne pas mettre la moto dans un garage ou un patio couvert, ou près de l'eau.
- Ne pas faire fonctionner la moto où des produits aérosols sont utilisés et où l'oxygène est administré.
- Gardez les enfants sous l'âge de 12 ans et les animaux loin de la moto à tout moment.
- Le vélo ne doit pas être utilisé par des personnes pesant plus de 300lbs (136 kg).
- Ne laissez jamais plus d'une personne sur le vélo à la fois. Porter des vêtements exercice approprié lors de l'utilisation du vélo. Ne portez pas de vêtements amples qui pourraient se coincer dans le vélo. Les vêtements de support sont recommandés pour les hommes et les femmes. Portez toujours des chaussures de sport. Ne jamais utiliser le vélo avec les pieds nus, porter des bas seulement, ou en sandales..
- Lorsque vous branchez le cordon d'alimentation, branchez le cordon d'alimentation dans un circuit à la terre.
- Toujours examiner votre vélo avant de l'utiliser pour s'assurer que toutes les pièces sont en ordre de marche.
- Laisser le vélo à venir à un arrêt complet avant ma descente.
- Ne jamais insérer d'objet ou le corps des pièces dans les ouvertures.
- Suivez les consignes de sécurité en ce qui concerne le branchement de votre vélo
- Gardez le cordon d'alimentation loin des roues pente et ne pas courir le cordon d'alimentation en dessous de votre vélo. Ne pas faire fonctionner la moto avec un cordon d'alimentation endommagé ou effiloché.
- Débranchez toujours le vélo avant de le nettoyer et / ou d'entretien. Service pour votre moto ne doit être effectuée par un représentant de service autorisé, sauf autorisation et / ou les instructions du fabricant. Le non respect de ces instructions annule la garantie de vélo

POWER REQUIREMENTS

Power Requirements:

IMPROPER CONNECTION OF THE EQUIPMENT GROUNDING CONNECTOR CAN RESULT IN THE RISK OF AN ELECTRIC SHOCK. CHECK WITH A QUALIFIED ELECTRICIAN OR SERVICE MAN IF YOU ARE IN DOUBT AS TO WHETHER THE PRODUCT IS PROPERLY GROUNDED. DO NOT MODIFY THE PLUG PROVIDED WITH THE PRODUCT, IF IT WILL NOT FIT THE OUTLET; HAVE A PROPER OUTLET INSTALLED BY A QUALIFIED ELECTRICIAN.

This bike can be seriously damaged by sudden voltage changes in your home's electrical power. Voltage spikes, surges and noise interference can result from weather conditions or from other appliances being turned on or off. To reduce the possibility of bike damage, always use a surge protector (not included) with your bike.

Surge protectors can be purchased at most hardware stores. The manufacturer recommends a single outlet surge protector with a UL 1449 rating as a Transient Voltage Surge Suppressor (TVSS) with a UL suppressed voltage rating of 400V or less and an electrical rating 120VAC, 15 amps.

This bike must be grounded to reduce the risk of electrical shock. Grounding provides a path of least resistance for electric current, should the bike malfunction. This bike is equipped with an electrical cord that has an equipment-grounding conductor and a grounding plug. Always plug the power cord into a surge protector, and plug the surge protector into an appropriate outlet that is properly installed and grounded in accordance with all local codes and ordinances.

Alimentation :

UN MAUVAIS BRANCHEMENT DU CONNECTEUR DE MISE À LA TERRE DE L'ÉQUIPEMENT POURRAIT PROVOQUER UN CHOC ÉLECTRIQUE. EN CAS DE DOUTE, CONSULTER UN ÉLECTRICIEN OU UN RÉPARATEUR QUALIFIÉ POUR SAVOIR SI LE PRODUIT EST CORRECTEMENT MIS À LA TERRE. NE PAS MODIFIER LA FICHE FOURNIE AVEC LE PRODUIT. SI ELLE N'ENTRE PAS DANS LA PRISE, FAIRE INSTALLER UNE PRISE APPROPRIÉE PAR UN ÉLECTRICIEN PROFESSIONNEL.

Ce tapis roulant pourrait être gravement endommagé en cas de changement soudain de tension dans votre alimentation électrique. Les conditions météorologiques ou la mise sous tension ou hors tension d'autres appareils électriques peuvent provoquer des pointes de tension, des surtensions ou un brouillage. Pour réduire la possibilité que le tapis soit endommagé, toujours utiliser un limiteur de surtension (non inclus) avec votre tapis roulant.

Il est possible d'acheter des limiteurs de surtension dans la plupart des quincailleries. Le fabricant recommande un limiteur de surtension UL 1449 à prise unique comme suppresseur de tension transitoire (TVSS) ayant un taux de suppression de tension de 400 V ou moins et une tension électrique de 110 V C.A., 15 A.

Ce tapis roulant doit être mis à la terre pour réduire le risque de choc électrique. La mise à la terre fournit une voie de moindre résistance au courant électrique en cas de mauvais fonctionnement du tapis roulant. Ce tapis roulant est équipé d'un cordon électrique avec un conducteur de mise à la terre et une fiche de mise à la terre. Brancher toujours le cordon électrique dans un limiteur de surtension et brancher le limiteur de surtension dans une prise appropriée, correctement installée et mise à la terre conformément à tous les codes locaux et ordonnances.

BEFORE YOU BEGIN

Open the boxes:

Open the boxes of your new equipment. **Inventory all parts included in the boxes, and Supplied Hardware lists on pages 7 for a full count of the parts included.** If you are missing any parts or have any questions contact us directly at 888-800-1167

Gather your tools:

Before you begin, make sure that you have gathered all the necessary tools you may require to assemble the unit properly. Having all of the necessary equipment at hand will save time and make the assembly quick and hassle-free.

Clear your work area:

Make sure that you have cleared away a large enough space to properly assemble the unit. Make sure the space is free from anything that may cause injury during assembly. After the unit is fully assembled, make sure there is a comfortable amount of free area around the unit for unobstructed operation.

Invite a friend:

Some of the assembly steps may require heavy lifting. It is recommended that you obtain the assistance of another person when assembling this product.

User Weight Limitation:

Please note that there is a weight limitation for this product. If you weigh more than 300LBS (Approx. 136 Kgs). It is not recommended that you use this product. Serious injury may occur if the user's weight exceeds the limit shown here. This product is not intended to support users whose weight exceeds this limit.

Care and maintenance:

The safety level can be maintained only if it is examined for damage and wear.

Replace any defective components immediately and stop all use of the equipment until repaired.

Always take care when mounting the equipment. Straddle the equipment by placing your feet on the straddle rails. Step off from the equipment only after all parts have stopped.

Always check the wear and tear components like pulley, belts, etc....To prevent injury.

SUPPLIED COMPONENTS / SUPPLIED HARDWARE

This list identifies the major components you will use to assemble this product.

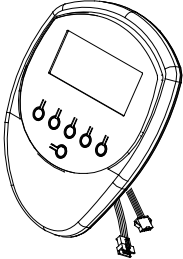
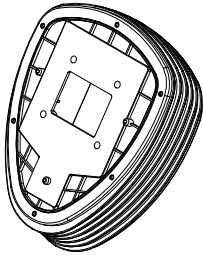
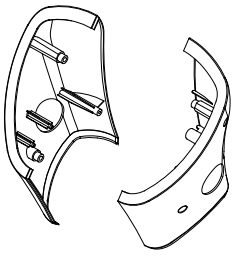
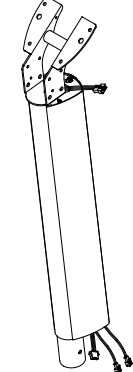
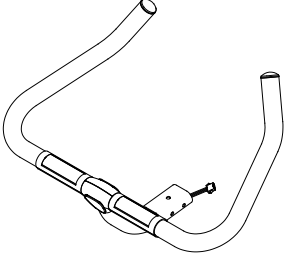
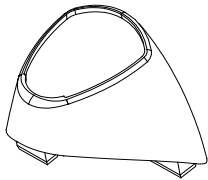
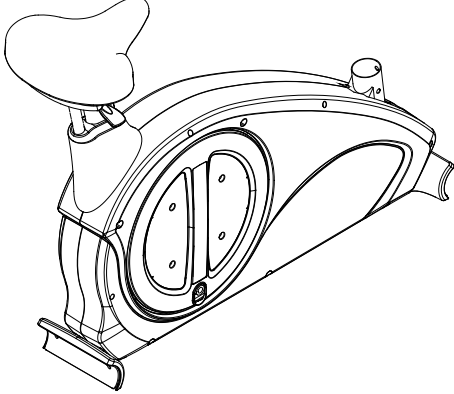
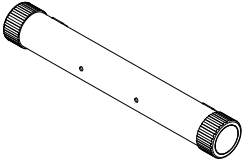
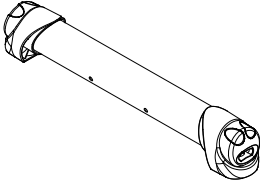
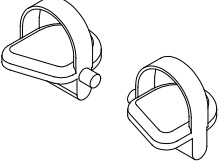
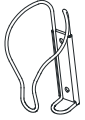
Console Upper Cover	Console Bottom Cover	Console Sleeve	Upright Post Assembly
			
Front Handlebar	Upright Sleeve	Main Frame Assembly	
			
Front Stabilizer	Rear Stabilizer	Pedal	Water Bottle Bracket
			

SUPPLIED COMPONENTS / SUPPLIED HARDWARE

This list identifies the major components you will use to assemble this product.

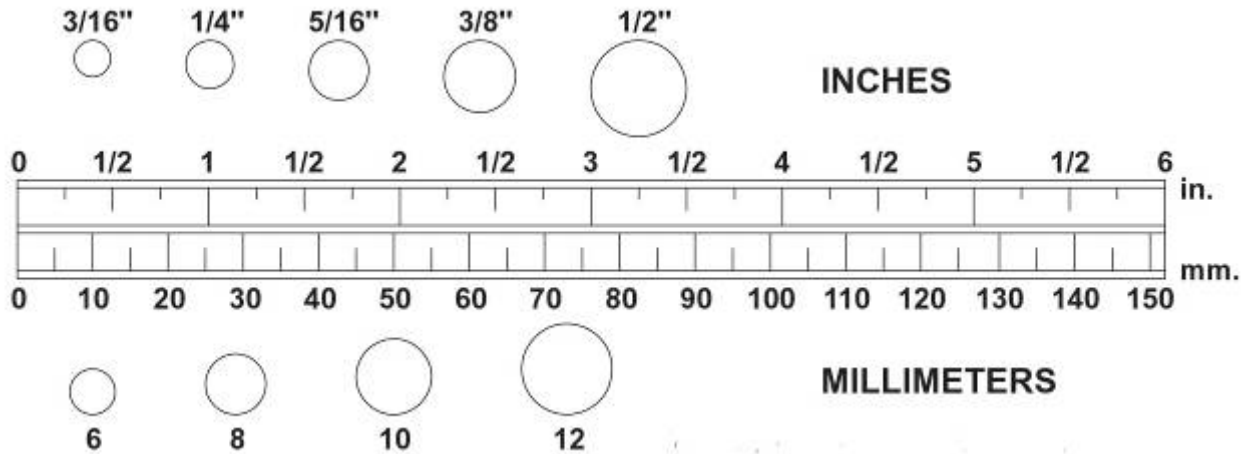

NOTICE: The length of all bolts and screws except those with flat heads is measured from below the head to the end of the bolt or screw. Flat head bolts and screws are measured from the top of the head to the end of the bolt or screw

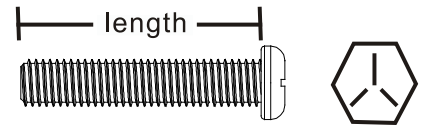

After unpacking the unit, open the hardware bag and make sure that you have all the following items. **Note: Some small parts may have been pre-attached for shipping. If a part is not in the hardware bag, check to see if it has been pre-assembled**

	Part No. and Description	Q'TY
	65 Lock Washer (M8)	9 pcs
	66 Washer (8x16x2.0t)	9 pcs
	72 Screw, Pan Head (M5xp0.8x25mm)	4 pcs
	73 Screw, Round Head (M5xp0.8x15mm)	4 pcs
	81 Bolt, Socket Head (M6xp1.0x15mm)	4 pcs
	82 Bolt, Socket Head (M8xp1.25x16mm)	4 pcs
	83 Bolt, Socket Head (M8xp1.25x45mm)	1 pcs
	84 Bolt, Socket Head (M8xp1.25x90mm)	4 pcs

THE FOLLOWING TOOLS ARE INCLUDED FOR ASSEMBLY:

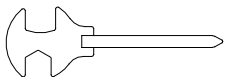

**MULTI WRENCH TOOL W/
PHILLIPS SCREWDRIVER
(13 & 15mm)**



**ALLEN WRENCH
(5 & 6 mm)**

COMPLETE PARTS LIST

NO.	Item Name	Q'TY
V380-1	Main Frame	1
V380-2	Front Stabilizer	1
V380-3	Rear Stabilizer	1
V380-4	Seat Post	1
V380-5	Upright Post	1
V380-6	Front Handlebar	1
V380-7	Left Chain Cover	1
V380-8	Right Chain Cover	1
V380-9	Crank Cover (L&R)	2
V380-10	Left Pedal	1
V380-11	Right Pedal	1
V380-12	Bearing (6300)	1
V380-13	Pulley	1
V380-14	Magnet	1
V380-15	Belt	1
V380-16	Pressure Bracket	1
V380-17	Bushing for Seat Post	1
V380-18	Tube Decoration Cover for Stabilizer (L&R)	2
V380-19	Transportation Wheel (L&R)	2
V380-20	Front Stabilizer EndCap	2
V380-21	Adjusting Rear Stabilizer EndCap	2
V380-22	Seat Cushion	1
V380-23	Seat Bottom Cover	1
V380-24	Seat Cap	1
V380-25	Adjusting Handle	1
V380-26	Upright Sleeve	1
V380-27	Foam Grip (500mm)	2
V380-28	Round Plug (31.8mm)	2
V380-29	Decoration Cover for Handlebar	2
V380-30	Hand Pulse Upper Cover (L&R)	2
V380-31	Hand Pulse Bottom Cover (L&R)	2
V380-32	Console Upper Cover	1
V380-33	Console Bottom Cover	1
V380-34	Left Console Sleeve	1

COMPLETE PARTS LIST

NO.	Item Name	Q'TY
V380-35	Right Console Sleeve	1
V380-36	Flywheel	1
V380-37	Cable	1
V380-38	Fixed Bracket for Motor	1
V380-39	Left Crank	1
V380-40	Right Crank	1
V380-41	Axle for Crank	1
V380-42	Fixed Bracket for Idler	1
V380-43	Pneumatic Lifter	1
V380-44	Axle for U-Shaped Bracket	1
V380-45	U-Shaped Bracket	1
V380-46	Slider	1
V380-47	Curved Washer	1
V380-48	Cable for Slider	1
V380-49	Seat Adjustment Lever	1
V380-50	Fixed Stand for Seat Adjustment Lever	1
V380-51	Spacer for Seat Adjustment Lever	1
V380-52	Upright Cover (L&R)	2
V380-53	Pulse Sensor Plate	4
V380-54	Bearing 6004zz	2
V380-55	Eye Bolt	3
V380-56	Tension Bracket	2
V380-57	Bushing (10.2x14x2mm)	1
V380-58	Bushing (10.2x14x10mm)	1
V380-59	Idler Spring	1
V380-60	Spring for Cable	1
V380-61	Spring for U-Shaped Bracket	1
V380-62	E Ring	1
V380-63	C Ring	1
V380-64	Wave Washer	1
V380-65	Lock Washer (M8)	18
V380-66	Washer (8x16x2.0t)	13
V380-67	Washer (10x23x2.0t)	2
V380-68	Washer (21x30x1.0t)	2
V380-69	Self-Tapping Screw, Round Head (M3x25mm)	4
V380-70	Self-Tapping Screw, Flat Head (M4x16mm)	4

COMPLETE PARTS LIST

NO.	Item Name	Q'TY
V380-71	Self-Tapping Screw, Flat Head (M5x18mm)	21
V380-72	Screw, Pan Head (M5xp0.8x25mm)	4
V380-73	Screw, Round Head (M5xp0.8x15mm)	4
V380-74	Bolt, Round Head (M6xp1.0x10mm)	4
V380-75	Bolt, Round Head (M6xp1.0x25mm)	8
V380-76	Screw, Flat Head (M5xp0.8x12mm)	4
V380-77	Bolt, Pan Head (M8xp1.25x10mm)	4
V380-78	Bolt, Pan Head (M8xp1.25x20mm)	2
V380-79	Bolt, Button Head (M8xp1.25x16mm)	5
V380-80	Bolt, Button Head (M8xp1.5x35mm)	1
V380-81	Bolt, Socket Head (M6xp1.0x15mm)	4
V380-82	Bolt, Socket Head (M8xp1.25x16mm)	4
V380-83	Bolt, Socket Head (M8xp1.25x45mm)	1
V380-84	Bolt, Socket Head (M8xp1.25x90mm)	4
V380-85	Bolt, Hex Head (M8xp1.25x16mm)	4
V380-86	Bolt, Hex Head (M10xp1.5x50mm)	1
V380-87	Nut (M6)	1
V380-88	Nut (M8)	1
V380-89	Nylock Nut (M6)	2
V380-90	Thin Nylock Nut (M8)	8
V380-91	Nylock Nut (M10)	2
V380-92	Flange Nut (M10)	2
V380-93	Flange Nut – Black Color (M10)	2
V380-94	Front Connection Wire	1
V380-95	Rear Connection Wire	1
V380-96	Adaptor Connection Wire	1
V380-97	Adaptor	1
V380-98	Motor w/ Wire	1
V380-99	Sensor Wire w/Stand	1
V380-100	Front Pulse Sensor Wire	1
V380-101	Rear Pulse Sensor Wire	1
V380-102	Spacer (8x12x12mm)	2
V380-103	Lock Washer (M6)	2
V380-104	Self-Tapping Screw, Button Head (M4x16mm)	4
V380-105	Screw, Pan Head (M5x10mm)	4
V380-106	Water Bottle Bracket	1
V380-107	Bolt, Round Head M5x12mm	2

PARTS DIAGRAM

MOST OF THE PARTS SHOWN HERE HAVE BEEN PRE-ASSEMBLED

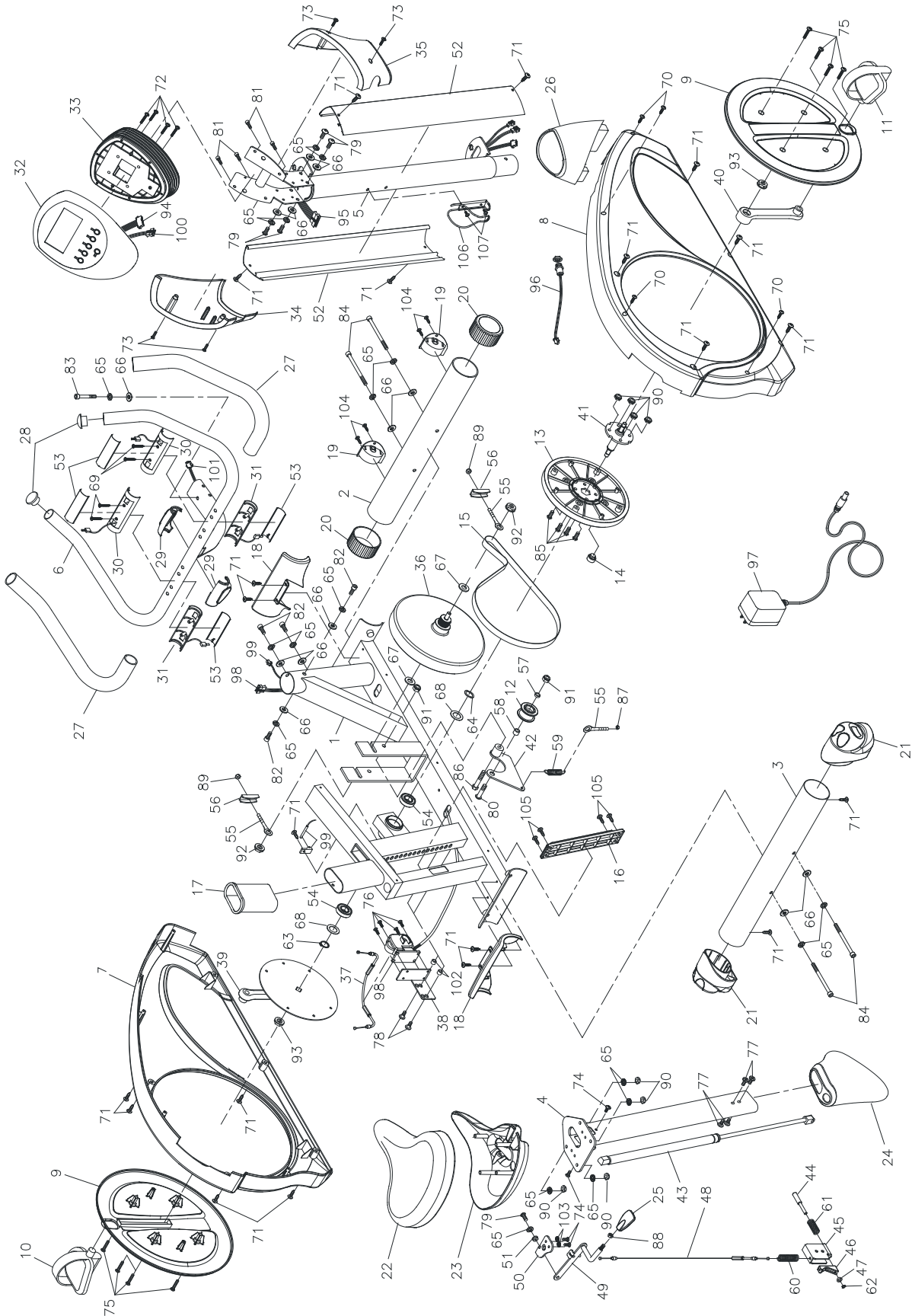

PARTS DISCRIPTION

MOST OF THE PARTS SHOWN HERE HAVE BEEN PRE-ASSEMBLED.

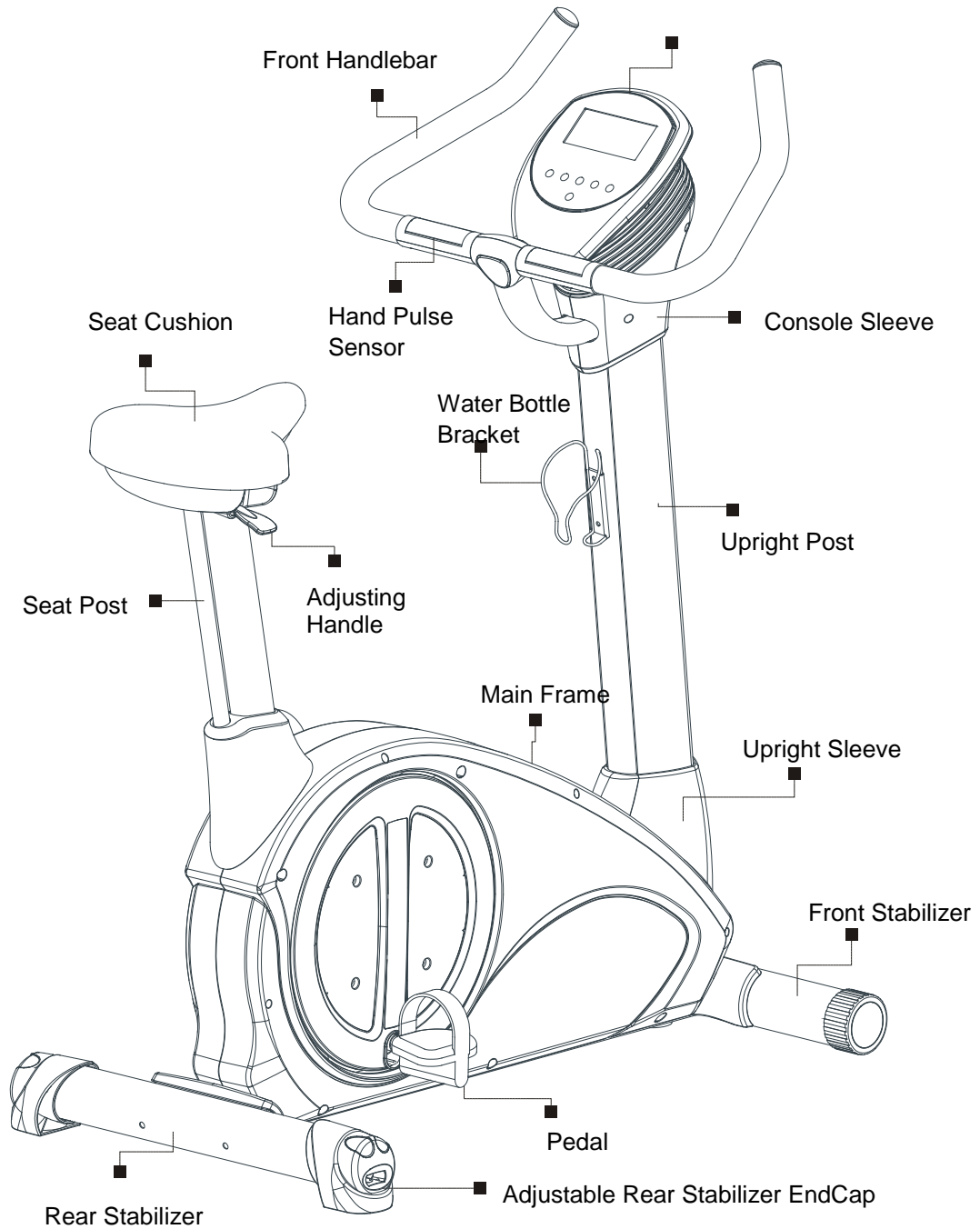

ASSEMBLY**Step 1: Attach the Stabilizers, Leveler and Pedals**

Note: the stabilizer is marked with an R to denote the right side.

Caution: Improperly rotating the pedal threads may cause damage to the equipment

A). Attach the front stabilizer to the main frame using 2x M8x1.25x90mm Socket Head Bolts (84), 2 x M8 Lock Washers (65) and 2 x 8x16x2.0t Washers (66). Slide the bolts through the front stabilizer and thread them in to the main frame.

B). Attach the rear stabilizer to the main frame using 2x M8x1.25x90mm Socket Head Bolts (84), 2 x M8 Lock Washers (65) and 2 x 8x16x2.0t Washers (66). Slide the bolts through the rear stabilizer and thread them in to the main frame.

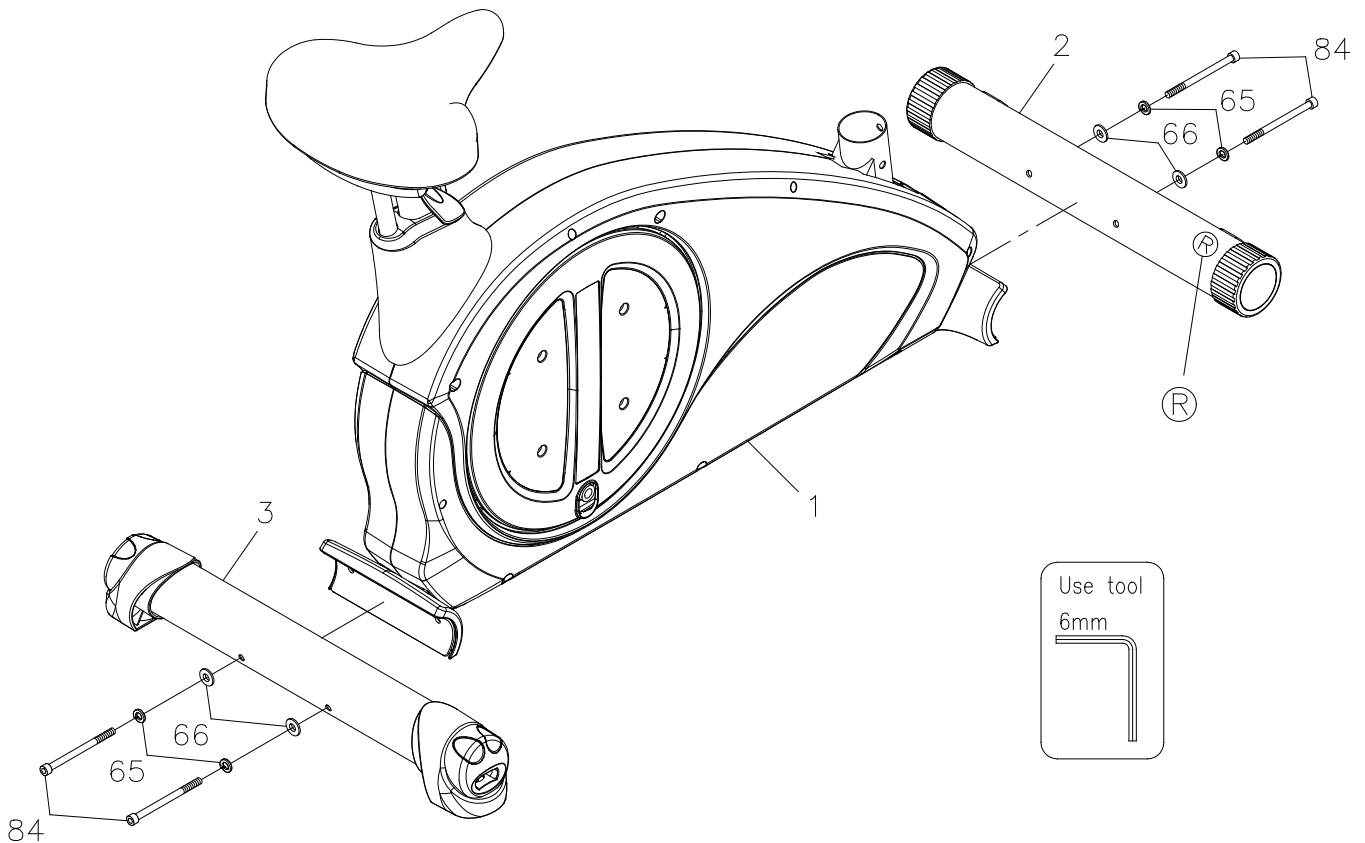

Tighten all bolts and fasteners now

ASSEMBLY

STEP 2: Attach the Upright Post Assembly

Note: Do not tighten the upright post bolts until all four bolts are threaded into the post.

Caution: Do not pinch the wires between the frame

- A). Slid the upright sleeve (26) on to the upright post assembly (5).
- B). Attach the upright post assembly to the main frame using 4 x M8xp1.25x16mm socket head bolts (82), 4 x M8 lock washers (65) and 4 x 8x16x2.0t washers(66).
- C). Connect the **Rear Connection Wire (95A)** to the **Motor Wire (98)**.
- D). Connect the **Rear Connection Wire (95C)** to the **Sensor Wire (99)**.
- E). Connect the **Rear Connection Wire (95A)** to the **Adaptor Connection Wire (95A)**.
- F) Slide the upright post sleeve down until it attaches to the main frame covers.
- G) Remove the 4x M8xp1.25x16mm button head bolts (79), 4 x 8x16x2.0t Washers(66) and 4 x M8 lock washers (65)
- H) Insert the front handlebar through the upright post bracket. Secure with 4x M8xp1.25x16mm button head bolts (79), 5 x 8x16x2.0t Washers (66), 5 x M8 lock washers (65), and 1x M8xp1.25x45mm socket head bolt (83) (this bolt is found in the hardware bag.

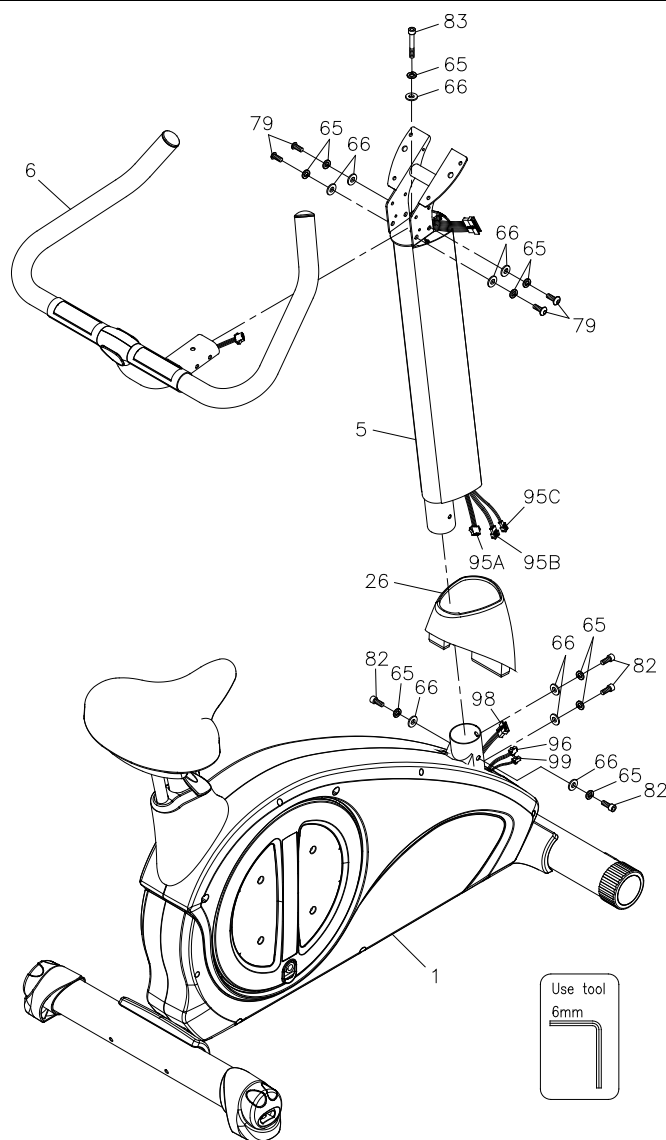

Tighten all bolts and fasteners now

ASSEMBLY**STEP 3: Attach the Console and Front Handlebar**

Make sure all wires are recessed into the frame. DO NOT trap or pinch the wires.

- A). Attach the console bottom cover (33) to the console upper cover (32) and secure using 4 x M5xp0.8x25mm pan head screws (72). See Fig.1
- B) Align the console (32,33) with the console bracket on top of the upright post (5).
- C) Secure the console to the upright post with 5 x (M6xp1.0x15mm) socket head bolts (81).
- D) Tighten all bolts now
- E) Connect the front computer wire (94) to the rear computer wire (95). Do not pinch the wires
- F) Connect the Front Pulse Sensor Wire (100) to the Rear Pulse Sensor Wire (101). Do not pinch the wires

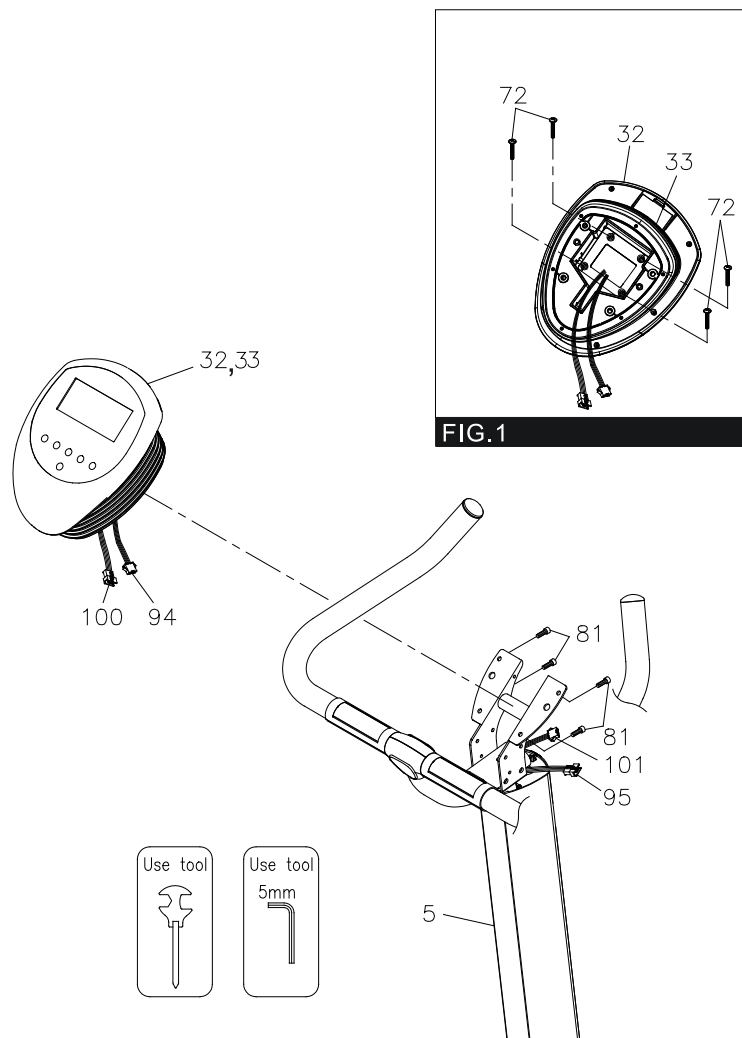

Tighten all bolts and fasteners now

ASSEMBLY**STEP 4: Attach the Console Sleeve Assembly and Water Bottle bracket**

- A). Slide the console sleeve assembly (35) (34) around the upright post.
 B) Be certain that the sleeve assembly aligns together properly and the lowest portion of the console bottom cover (33) is inside the console sleeve assembly.
 C). Secure the two sleeves together using 4 x M5xp0.8x15mm round head screws (73)

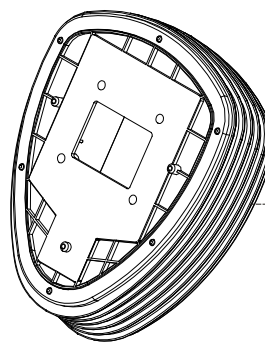
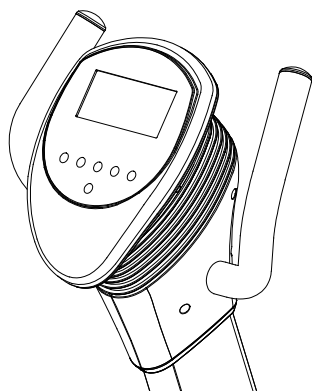
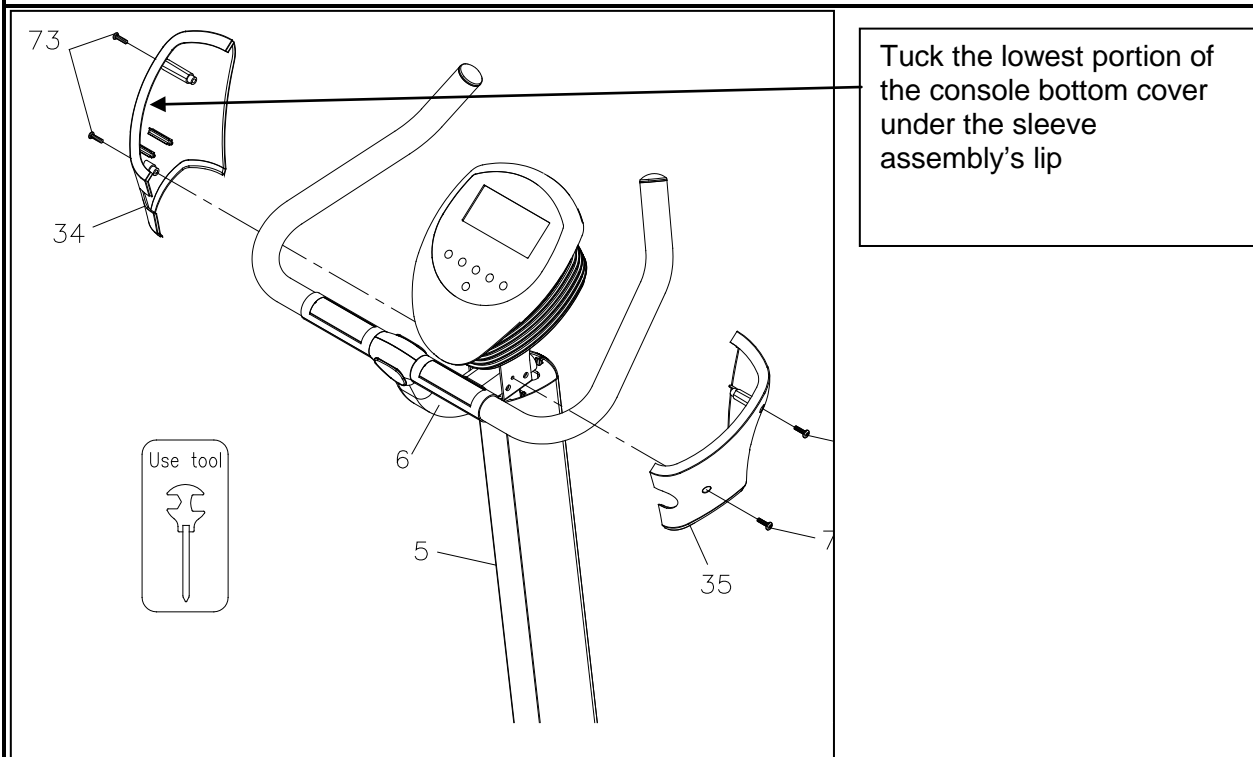

Tighten all bolts and fasteners now

ASSEMBLY**STEP 5: Attach the Inner Seat Carriage Slider**

- A). Remove the pre-installed water bottle bracket screws from the console post
- B). Line up the water bottle bracket with the upright post as pictured below.
- C). Secure the bracket using the previously removed 2 x M5x12mm (107) round head bolts
- D). Attach the right pedal into the right side crank. To tighten, turn the pedal treads clockwise.
- E). Attach the left pedal to the left side crank. To tighten, turn the pedal threads counter clockwise

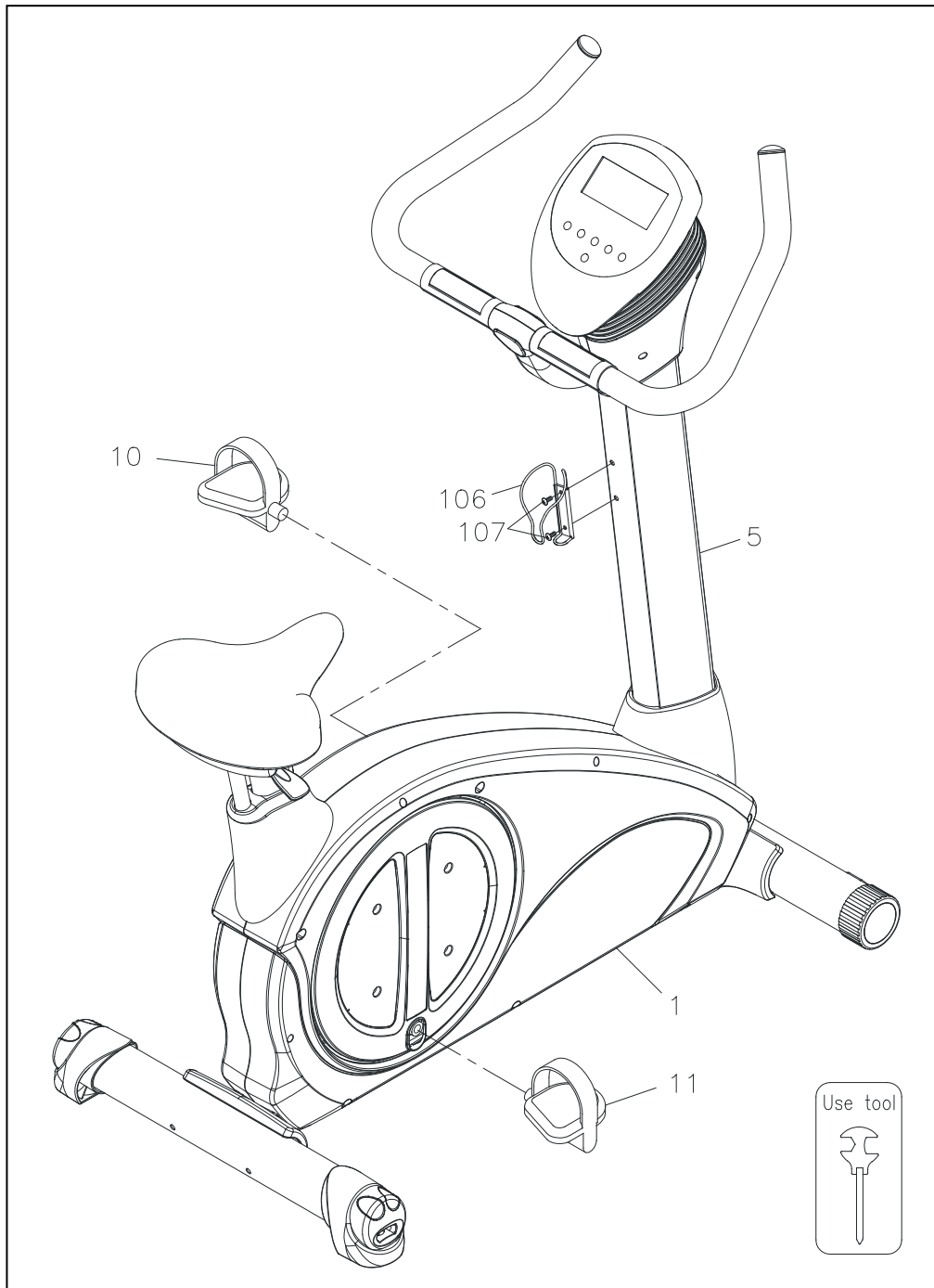

GENERAL INFORMATION

THE POWER SUPPLY

The power input is located at the lower front of the bike

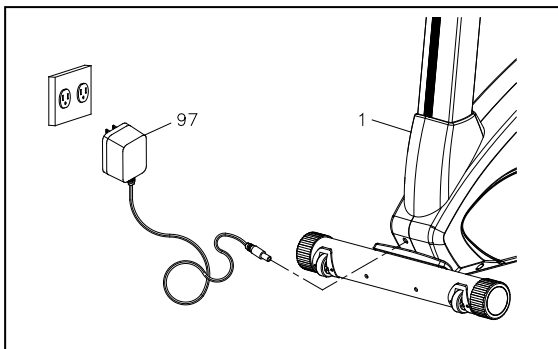

HOW TO ADJUST THE REAR STABILIZER

- After placing the equipment in the intended location for use, it may be necessary to level the equipment.
- To level the equipment turn the dial in the center of the rear stabilizers

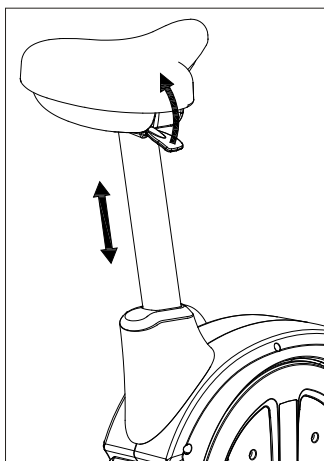

HOW TO ADJUST THE SEAT

- To adjust the seat up, pull up on the seat adjuster lever. The seat will automatically rise.
- To lower the seat, lift up on the seat adjuster lever and push down on the seat.
- Check to see if the seat is locked in place prior to sitting on the seat.

GENERAL INFORMATION

HOW TO ADJUST CONSOLE ANGLE

To get the best console angle, it's suggested to use both hands to hold the upper and lower end of the console and gently adjust the console angle to the proper position

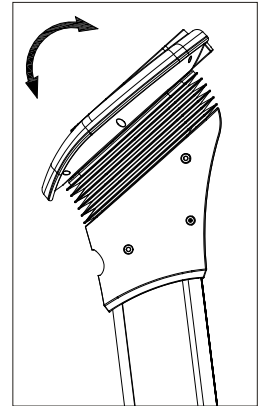

HOW TO MOVE THE ITEM SAFELY

Hold the **Rear Stabilizer (3)** up with two hands and pull the item from one place to the other

- ◆ Make sure the floor is level when moving the item

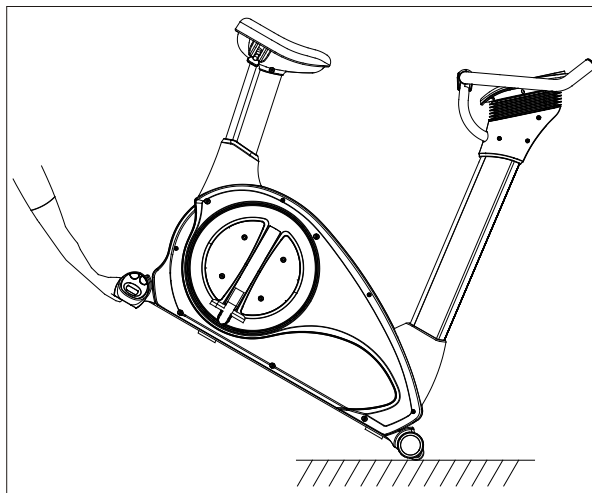

IMPORTANT STEPS**Warning:**

Before using this product, please consult your personal physician for a complete physical examination. Frequent and strenuous exercise should be approved by your doctor first. If any discomfort should result from your use of this product, stop exercising and consult your doctor. Proper usage of this product is essential. Please read your manual carefully before exercising.

Avertissement :

Avant d'utiliser de produit, veuillez consulter votre médecin personnel pour un examen médical complet. Des exercices fréquents et difficiles doivent d'abord être approuvés par votre médecin. Si vous ressentez un malaise par suite de l'utilisation de produit, arrêtez les exercices et consultez votre médecin. Un usage approprié de ce produit est essentiel. Veuillez lire attentivement votre manuel avant de commencer les exercices.

Les enfants doivent rester éloignés de l'équipement pendant son utilisation et lorsqu'il est laissé sans surveillance. Portez toujours des vêtements appropriés pour les exercices, y compris des chaussures d'athlétisme. Ne portez pas de vêtements amples qui pourraient être pris dans l'appareil durant les exercices.

Please keep all children away from the equipment during use and when equipment is unattended.

Always wear appropriate clothing, including athletic shoes, when exercising. Do not wear loose clothing that could become caught during exercising.

Make sure that all bolts and nuts are tightened when equipment is in use. Periodic maintenance is required on all exercise equipment to keep it in good condition.

Before beginning:

How you begin your exercise program depends on your physical condition. If you have been inactive for several years, or are severely overweight, you must start slowly and increase your time gradually, a few minutes per week.

Initially you may be able to exercise only for a few minutes in your target zone. However, your aerobic fitness will improve over the next six to eight weeks. Don't be discouraged if it takes longer. It's important to work at your own pace. Ultimately, you'll be able to exercise continuously for 30 minutes. And the better your aerobic fitness, the harder you will have to work to stay in your target zone. But remember these essentials:

- Contact your physician before starting a workout or training program. Have your doctor review your training and diet programs to advise you of a workout routine you should adopt.
- Begin your training program slowly with realistic goals that have been set by you and your doctor.
- Supplement your program with some type of aerobic exercise such as walking, jogging, swimming, dancing and/or bicycling. Monitor your pulse frequently. If you do not have an electronic heart rate monitor, have your physician show you the proper way to manually check your pulse by using your wrist or neck. Establish your target heart rate based on your age and condition.
- Drink plenty of fluids during the course of your routine. You must replace the water content lost from excessive exercising to avoid dehydration. Avoid drinking large amounts of cold liquids. Fluids should be at room temperature when consumed.

MUSCLE CHART

Targeted muscle groups:

The exercise routine that is performed on this product will develop primarily lower body muscle groups. These muscle groups are shown in gray color on the chart below.

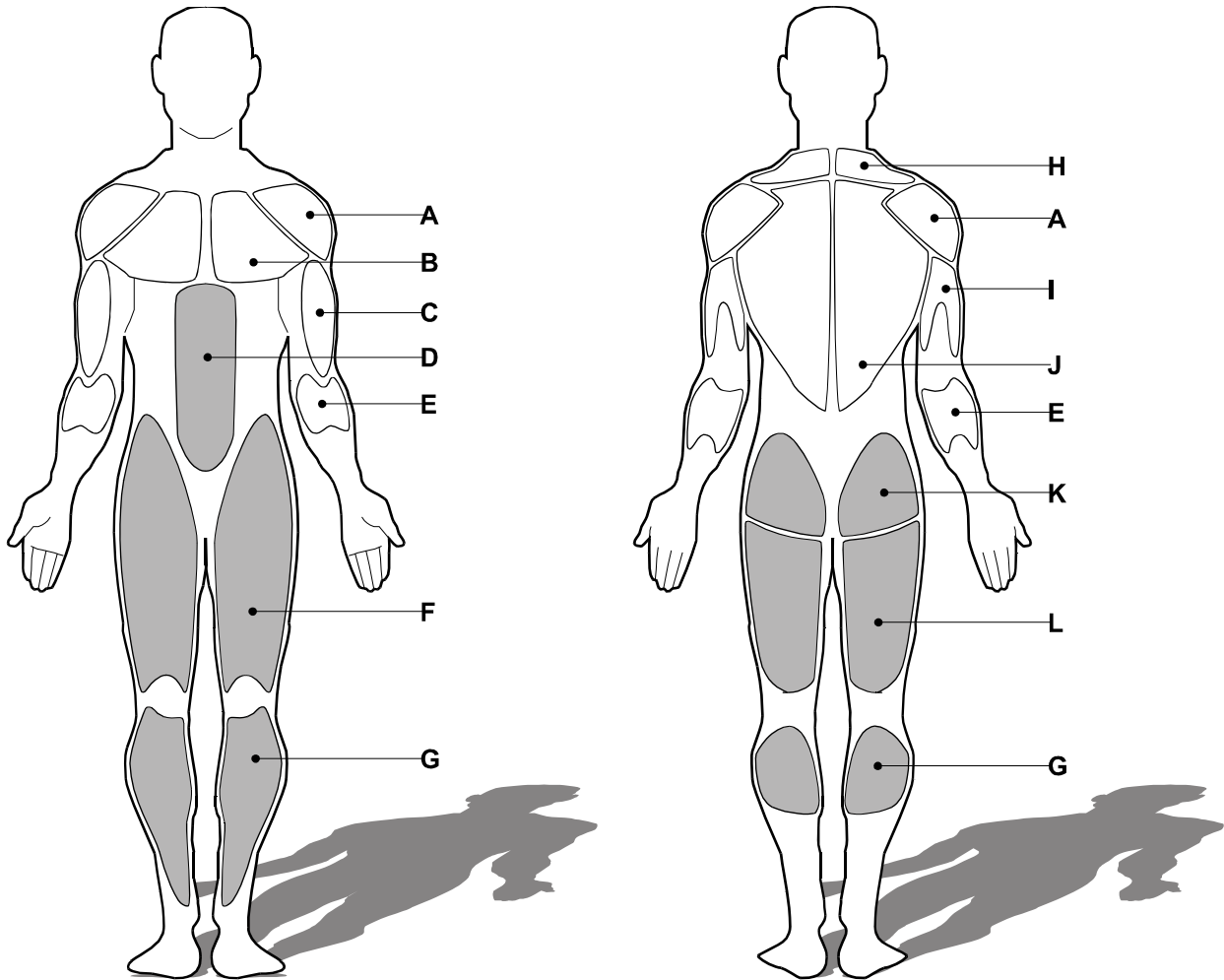

MUSCLE GROUPS

A	Shoulder muscles	Calf muscles	G
B	Pectoral muscles	Trapezius muscles	H
C	Bicep muscle	Tricep muscles	I
D	Abdominal muscles	Back muscles	J
E	Forearm muscles	Gluteal muscles	K
F	Quadricep muscles	Hamstring muscles	L

STRETCHING ROUTINE

Warm up and cool down:

A successful exercise program consists of a warm-up, aerobic exercise, and a cool-down. Do the entire program at least two and preferably three times a week, resting for a day between workouts. After several months, you can increase your workouts to four or five times per week.

Warming up is an important part of your workout, and should begin every session. It prepares your body for more strenuous exercise by heating up and stretching out your muscles, increasing your circulation and pulse rate, and delivering more oxygen to your muscles. At the end of your workout, repeat these exercises to reduce sore muscle problems. We suggest the warm-up and cool-down exercises on the following pages:

Toe Touch:

Slowly bend forward from your waist, letting your back and shoulders relax as you stretch toward your toes. Reach down as far as you can and hold for 15 counts.

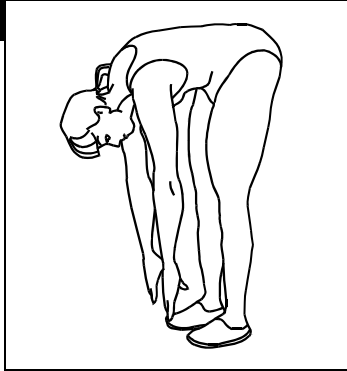

Shoulder Lift:

Lift your right shoulder up toward your ear for one count. Then lift your left shoulder up for one count as you lower your right shoulder.

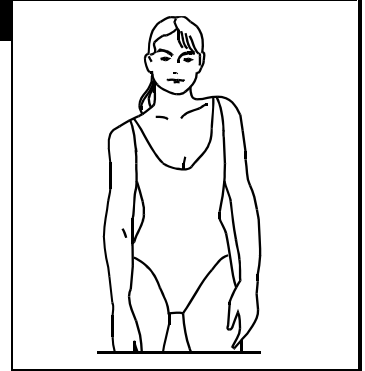

Inner Thigh Stretch:

Sit with the soles of your feet together with your knees pointing outward. Pull your feet as close into your groin as possible. Gently push your knees towards the floor. Hold for 15 counts.

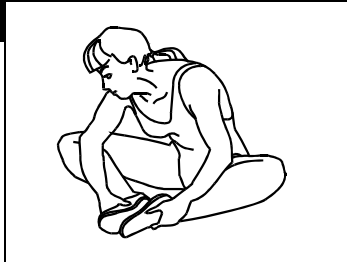

Hamstring Stretch:

Sit with your right leg extended. Rest the sole of your left foot against your right inner thigh. Stretch toward your toe as far as possible. Hold for 15 counts. Relax and then repeat with left leg extended.

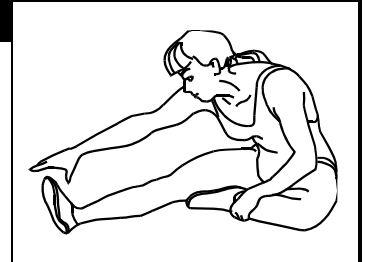

Side Stretch:

Open your arms to the side and continue lifting them until they are over your head. Reach your right arm as far upward toward the ceiling as you can for one count. Feel the stretch up your right side. Repeat this action with your left arm.

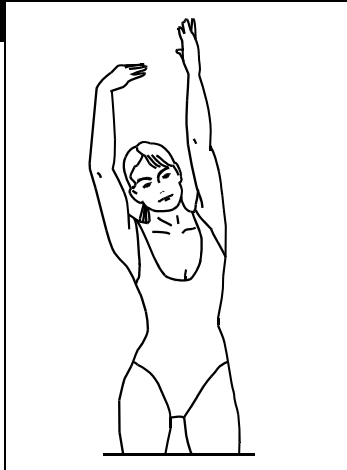

Calf-Achilles Stretch:

Lean against a wall with your left leg in front of the right and your arms forward. Keep your right leg straight and the left foot on the floor; then bend the left leg and lean forward by moving your hips toward the wall. Hold, and then repeat on the other side for 15 counts.

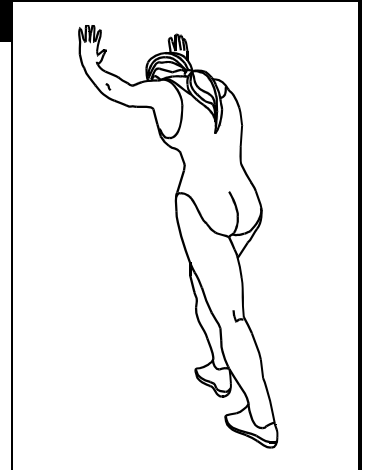

Head Roll:

Rotate your head to the right for one count, feeling the stretch up the left side of your neck. Next, rotate your head back for one count, stretching your chin to the ceiling and letting your mouth open. Rotate your head to the left for one count, and finally, drop your head to your chest for one count.

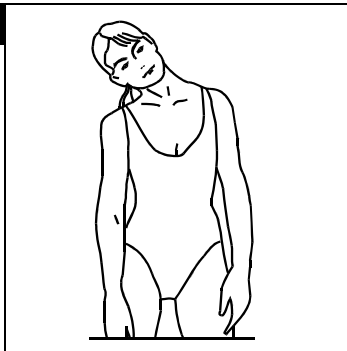

STRETCHING ROUTINE

Read carefully the following before using your bike

- ◆ Always stretch your muscles before exercise program. Warm up slowly by walking at a slow speed. Increase workout intensity gradually until you reach your desired workout pace. Decrease workout intensity gradually to an easy walk, allowing your heart rate to decrease to a normal situation.
- ◆ When starting the bike, always stand with both feet on the step-on side rails.
- ◆ When finishing, allow the running belt to slow down and come to a complete stop before stepping off.
- ◆ Wear comfortable, non-restrictive clothing when using the bike. Never wear anything loose, such as baggy sweat pants, neckties, loose socks or jewelry. Never drape towels on or around the bike during use.

WARNING

If you feel dizzy, nausea, chest pain or other abnormal symptoms, stop immediately. Consult a physician before continuing use.

AVERTISSEMENT: Si vous vous sentez étourdi, la nausée, la douleur de coffre ou d'autres symptômes anormaux, s'arrêtent immédiatement. Consultez un médecin avant de continuer l'utilisation.

- ◆ Always use the handrail when stepping on or off the bike and when changing incline or speed.
- ◆ This bike is equipped with a safety key – always clip the cord attached to the safety key to a part of your clothing so the safety key will properly detach from the computer console, thereby stopping the bike.
- ◆ Wear running or walking shoes with high-traction soles. To avoid injury and unnecessary wear on your bike, be sure your shoes are free of any debris such as gravel and small rocks.

Before completing an exercise session, always:

1. Allow time to slow your pace, cool down, and reduce your heart rate to a normal level before completing your workout.
2. Grasp the handlebars and press the Speed “?” button. Slow your pace to an easy walk.
3. Ensure the running belt has come to a complete stop before exiting the bike.

WARNING

Turn off and unplug the bike before proceeding with any maintenance or visual inspections. Failure to do so may result in serious injury. Note: Failure to perform the required periodic and preventative maintenance can void your warranty.

AVERTISSEMENT

Arrêtez et débranchez le tapis roulant avant de procéder à tout l'entretien ou inspections visuelles. Le manque de faire ainsi peut avoir comme conséquence des dommages sérieux. Note : Le manque d'exécuter l'entretien périodique et préventif exigé peut vider votre garantie.

At the end of every exercise session, always:

1. Remove the Safety Key from the computer console.
2. Use the master power switch to turn the bike off. The master power switch is located at the right side of frame next to the electrical cord.
3. Always position and store the electrical cord where is clear from all pathways.
4. Unplug the electrical cord from the electrical outlet. This is especially important if you are not going to use your bike for extended periods.
5. Wipe all bike surfaces with a dry cloth or towel especially perspiration on the handlebars, con troll panel, running belt or other bike components.







COMPUTER OPERATION

MY SMOOTH

Virtual Fitness Trainer

Congratulations this product is equipped with the MY SMOOTH Virtual Fitness Trainer. Whether you want to lose weight, train for a sporting event, or simply maintain a healthy lifestyle, the MY SMOOTH Virtual Fitness Trainer provides the tools, structure and support you need to be fit and live healthy. The 5 simple steps, outlined in the customer care kit* are proven to help you lose weight, improve your health, and make positive steps to a healthier lifestyle. These five steps combined with the tools built into your online account, will provide you with a great start toward achieving your goals.

To set up your account, refer to the instructions in the Getting Started Guide contained in your Smooth Fitness customer care kit or visit www.mysmoothtrainer.com

<p>Welcome to mySMOOTH!</p> <p>Your personal online account will empower you to take control of your health and fitness to achieve your goals.</p> <p>You can truly consolidate all of your exercise activity and your vital statistics in one place; automatically save and log your exercise, weight and blood pressure; and get exercise programs designed just for you.</p> <p>Your USB storage device provides the connection between your mySMOOTH account and the IHP certified products you use. Once your data is in your account, you can view it in a variety of ways that will help motivate you to stick with your exercise program. mySMOOTH is easy to use and proven to help you stay active, lose pounds, and train for a marathon.</p> <p>780 5th Avenue King of Prussia PA, 19406 800-211-1611 www.SmoothFitness.com</p> <p>2010 Smooth Fitness. All Rights Reserved</p>	<p>1 Create Your Account</p> <p>1. Enroll It takes only minutes to set up your account.</p> <ol style="list-style-type: none"> Go to www.mysmoothtrainer.com and click the Enroll Now button. Follow the online instructions. <ol style="list-style-type: none"> Enter the enrollment ID shown below. Read and accept the Terms and Conditions, then click continue. Fill out the enrollment form. Make sure you enter a valid and accessible email address. <p>After completing the enrollment form, you will be sent an email with your temporary password (check your junk email box if you do not receive it within 10 minutes).</p> <div style="border: 1px solid red; padding: 2px;">Enrollment ID#</div>	<p>2. Log In & Enter Your Baseline Vital Stats</p> <ol style="list-style-type: none"> To log in to your account, go to www.mysmoothtrainer.com and click Member Login. Enter the temporary password emailed to you, and change your password following the on-screen prompts. <p> Health Metrics</p> <ol style="list-style-type: none"> Enter your health metrics (at least the stats you know) to establish a baseline of your information. As you use your mySMOOTH memberships, you can compare your progress to your baseline. <p><small>NOTE: At a minimum, it is important to enter your height and weight. This personal data is used by IHP certified exercise equipment and health monitors to save you time during setup and record accurate data to your USB storage device.</small></p>	<p>3. Set Your Goals</p> <p>A critical step in using your mySMOOTH membership is to enter your health and fitness goals.</p> <p>You'll have an 80% higher success rate of achieving your goals if you record them. Specific, attainable goals for exercise, vital stats and behavioral change provide the foundation for your roadmap to success.</p> <p>Your goals are used to develop a plan that's right for you. Later, when you review your results and compare your progress to your goals, you can re-establish your goals and set them even higher.</p>	<p>4. Pick a Workout Calendar</p> <p> Workout Calendar</p> <p>Using the information you've already provided, mySMOOTH recommends workout calendars that match your goals, physical condition, and exercise preferences. All workout calendars are developed by experienced Exercise Physiologists to help you receive the maximum benefit from your exercise.</p> <p>Your personalized workout calendar combines cardio, strength, flexibility and balance exercises, and tells you which days to exercise, for how long, and at what level of intensity. YOU choose the physical activities you enjoy, whether indoors, outdoors, at home or at the gym.</p> <p>Your personalized workout calendar provides a structured approach to help you achieve your goals.</p>
<p>2 Using Your USB Drive</p> <p>1. Install Your Communications Software</p> <p>If you have a mySMOOTH drive, you must first install the IHP data communicator software on your computer. This allows your computer to recognize the USB drive. This is a quick, one-time process done on each computer you use with your USB drive.</p> <ol style="list-style-type: none"> Click Install Communications Software button at the bottom of your home page. If you are prompted to Open or Save the file, click the Open button. Follow the prompts displayed on the screen. When installation is complete, an IDC icon will be on your desktop (in Windows) or dock (on a Macintosh). <p></p> <p><small>NOTE: Before you use your IHP certified product, make sure the exercise equipment or health monitor has the correct date and time set to your data is accurately recorded (see the product Owner's Manual for details).</small></p>	<p>2. Sync Your Personal Data</p> <p>Synchronize your personal data with your USB drive, and upload exercise and health metrics results from your USB into your account.</p> <p>To Sync for the First Time, or When Logged In</p> <ol style="list-style-type: none"> Insert your USB drive into your computer. Log in and click Update Exercise Results or Update Health Metrics, then USB Update. Click Synchronize USB. Enter your Last Name and Password, then click Remember Me and Sign In. Click Select USB Drive, then choose your computer's USB drive (usually E: F: or G:). Your computer will then recognize your USB and you do not need to perform this step again. Your personal profile, including name, age, height, weight and gender, will sync to your USB drive. Workout data and health metrics, if any on the USB, are uploaded to your account. 	<p>To Sync When Not Logged In</p> <p>After you've synchronized your USB drive, you can sync your data at any time simply by double-clicking the IDC icon on your desktop and following the on-screen prompts. It's simple and convenient, and doesn't require being logged in to update your results.</p> <p><small>All IHP certified products work with your mySMOOTH Account</small></p> <p></p> <p>When you exercise on IHP certified fitness equipment and use IHP certified health monitors, your results are automatically saved to your USB for easy uploading into your account.</p> <p></p>	<p>3 Enter Your Results Manually</p> <p>You can keep track of just about any exercise and health metrics in your mySMOOTH account, whether you have a mySMOOTH USB drive or not! It's simple to log and track all your physical activity - swim, bike outdoors, exercise at the gym, or attend fitness classes. Enter your vital stats as you take them or after you go to the doctor. You'll be rewarded with seeing your exercise results and health improvements in fun and motivating mySMOOTH reports.</p> <ol style="list-style-type: none"> Log in to your account. Click the Update Exercise Results or Update Health Metrics Follow the simple on-screen prompts. <p></p> <p>MY SMOOTH Virtual Fitness Trainer</p>	<p>Online Membership</p> <p>MY SMOOTH Virtual Fitness Trainer</p> <p>BY  SMOOTH FITNESS</p> <p>Enrollment ID# Included</p>

*Not all Smooth Fitness products include the Smooth Customer Care Kit

COMPUTER OPERATION

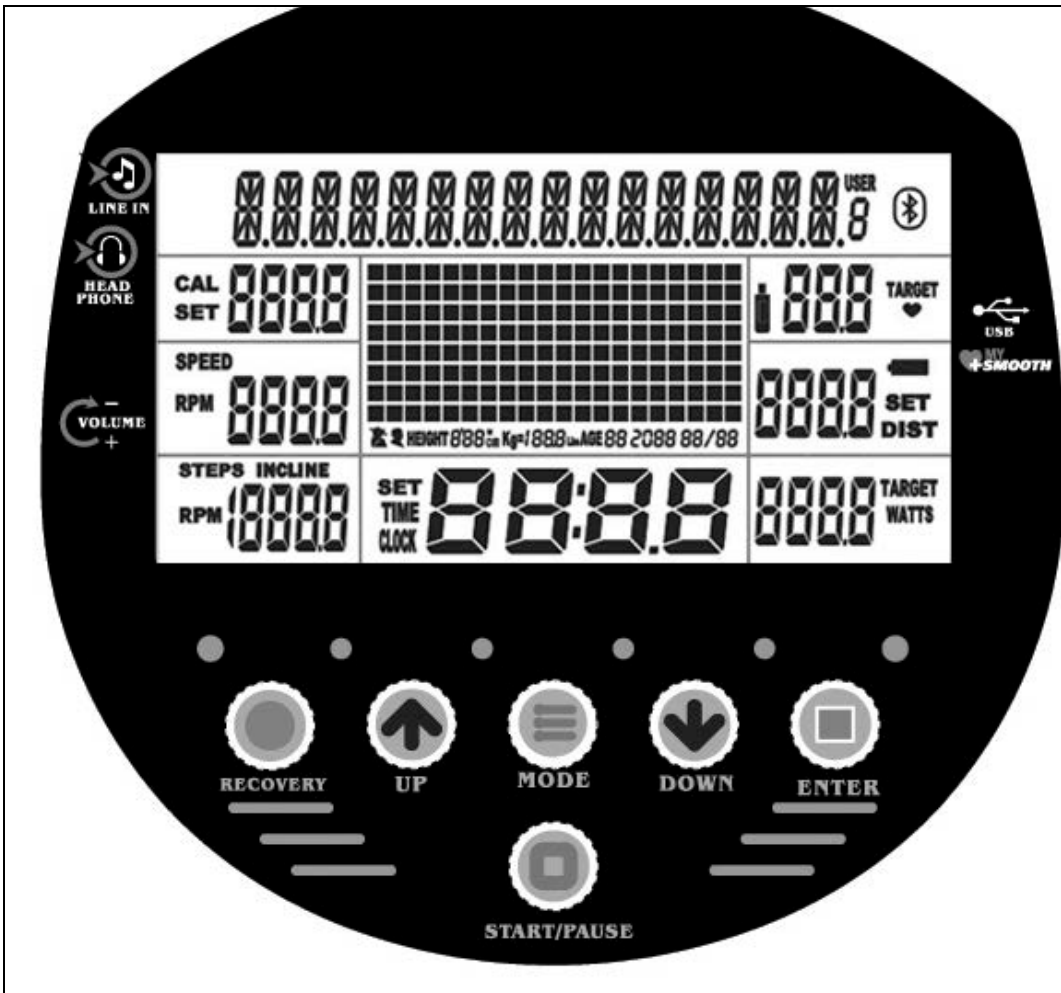

- Take a few minutes to review the console layout. Below is an overview of the console's features and functions
- We recommend that you use the console to help vary your workout routine and keep you focused on your process toward your fitness goals. The console can become an important source of motivation and interest which will help keep you on track

Power ON

- Make sure the item's adaptor is correctly plugged into the socket
- Pedaling or pressing any keys to activate the console. The console display will then light up with a short beep sound, indicating the console will be ready for use

Power Off

The console would automatically shut off after 5 minutes of inactivity









Program List

MANUAL	WEIGHT LOSS	NOV. INTERVAL	INT. INTERVAL	MOUNTAIN CLIMB
HILL CLIMB	ROLLING HILLS	GRAD. INTERVAL	PLATEAU	ADV. INTERVAL
LADDER	USER 1	USER 2	H.R.C.	H.R.C. INTERVAL

MANUAL	P1 WEIGHT LOSS	P2 NOV. INTERVAL	P3 INT. INTERVAL
P4 MOUNTAIN CLIMB	P5 HILL CLIMB	P6 ROLLING HILLS	P7 GRAD. INTERVAL
P8 PLATEAU	P9 ADV. INTERVAL	P10 LADDER	P11 USER 1
P12 USER 2	P13 H.R.C.	P14 H.R.C. INTERVAL	





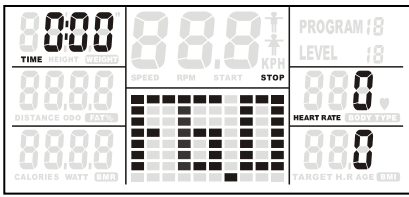



COMPUTER OPERATION

Console Buttons

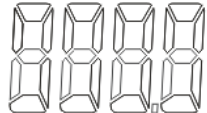
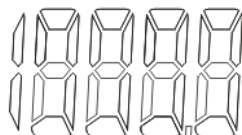
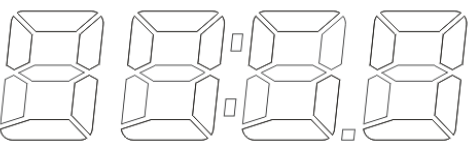
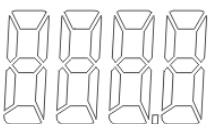
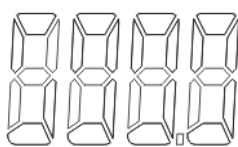
 <p>START/PAUSE</p>	<ol style="list-style-type: none"> Press START/PAUSE to begin your exercise Press START/PAUSE again to stop and pause all functions during your exercise program. All the data on the display will then pause. Press START/PAUSE again to resume the program and all the data displayed will continue until the program has finished. HOLD TO RESET function: Press and hold START/PAUSE, all the data will return to 0 and the console will return to POWER ON status.
 <p>ENTER</p>	<p>Press ENTER to confirm the program function (PROGRAM, TIME, HEIGHT, WEIGHT, AGE, TARGET H.R. and LEVEL in each time interval).</p>
 <p>UP</p>	<p>Press UP to increase the values of the program function (PROGRAM, TIME, HEIGHT, WEIGHT, AGE, TARGET H.R. and LEVEL in each time interval).</p>
 <p>DOWN</p>	<p>Press DOWN to decrease the values of the program function (PROGRAM, TIME, HEIGHT, WEIGHT, AGE, TARGET H.R. and LEVEL in each time interval).</p>
 <p>MODE</p>	<div style="display: flex; align-items: flex-start;"> <div style="flex: 1;">  <p>**The button is only suitable to use when the USB is plugged into the console**</p> <ul style="list-style-type: none"> Press MODE to review <u>Calendar Mode</u>. Hold MODE for a few seconds, to go into <u>Calendar Mode</u> to edit year/month/date/hour/minute. Press Start/ Pause /Hold to reset to return to POWER ON status. </div> <div style="flex: 1;">  </div> </div>
 <p>RECOVERY</p>	<ol style="list-style-type: none"> PULSE RECOVERY button measures how quickly you return to a resting heart rate after exercising. You could use this button to measure improvement as you get into shape. The console will monitor your pulse for 60 seconds and calculate a HEART RATE RECOVERY value from F1.0 to F6.0. <u>F1.0 is the Highest; F6.0 is the Lowest (For Reference Only).</u> The readout should only be used as a comparison between workouts. It's recommended to use right after any aerobic exercise. <u>Stop exercising before starting this function.</u> Your pulse will be displayed in approximately 5 seconds after the heart symbol "♥" is displayed. <div style="display: flex; align-items: flex-start; margin-top: 20px;"> <div style="flex: 1;">  </div> <div style="flex: 1;"> <p>NOTE:</p> <p>If you don't hold the HEART RATE SENSORS on the handrails with both hands properly, <u>the console's HEART RATE value will show "0" and the main screen would show "F6.0" after the console counts down to zero, if the sensor was unable to read your heart rate. Press stop then press the PULSE RECOVERY button again. Replace your hands on the pulse sensors.</u></p> </div> </div>

COMPUTER OPERATION

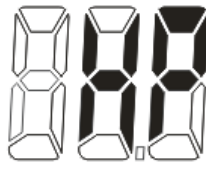
Console Functions

<p>CAL  SET </p>	<p>CALORIES:</p> <ul style="list-style-type: none"> ● Count Up: Measuring total calories your body burned during exercise. ● Display range: <u>0 ~ 9999.</u>
<p>SPEED  RPM</p>	<p>SPEED:</p> <ul style="list-style-type: none"> ● Displays the current speed <u>KM/MILE</u> during exercise.
<p>STEPS INCLINE  RPM</p>	<p>RPM (Rotation Per Minute):</p> <ul style="list-style-type: none"> ● Display range: <u>0 ~ 999.</u>
<p>SET TIME CLOCK </p>	<p>TIME:</p> <ul style="list-style-type: none"> ● Count Up: If a target time was not selected, TIME will count up from <u>0:00 to maximum 99:59 minutes.</u> ● Count Down: If you have set the target time (0:00 ~ 99:00), the console will count down from that selected target time down to 0:00.
<p> TARGET WATTS</p>	<p>WATTS:</p> <ul style="list-style-type: none"> ● Displays the current value of Watt during exercise. ● Display range: <u>0 ~ 9999.</u>
<p> SET DIST </p>	<p>DISTANCE:</p> <ul style="list-style-type: none"> ● Count Up: If a target distance was not selected, this would measure the total distance from <u>0:00 to 999.9 km/mile.</u> ● Count Down: If you have set the target distance, the console will count down from that selected target distance down to 0. <p> : Display POWER SUPPLY status.</p>
<p>  TARGET </p>	<p>HAND PULSE / HEART RATE:</p> <ul style="list-style-type: none"> ● To display your heart rete you must wear the chest belt or place both of your hands on the Pulse Sensors located on the Handlebars. Your pulse will be displayed approximately 5 seconds after the heart symbol “♥” is displayed. ● If you do not wear the chest belt or place your hands correctly on the pulse sensors, the computer will shut off the pulse circuit. To reactivate the pulse feature, properly place your hands back on the Pulse Sensors and the pulse readout will appear again. <p> : When the MY SMOOTH USB is plugged into the console, the USB signal will be displayed on the console.</p>

COMPUTER OPERATION

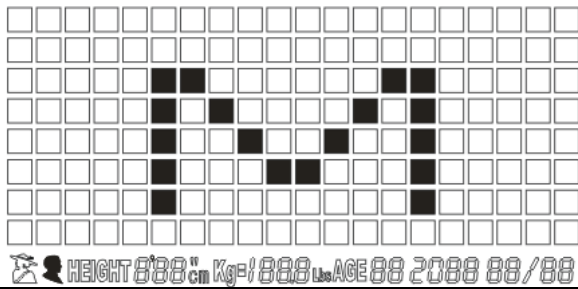
**GENDER:**

- Display range:

Male: 

Female: 

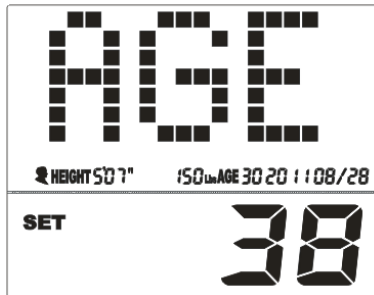
**AGE:**

- Display range:

10 ~ 99 years old; in 1 year increments

NOTE: Although the console allows input for age beginning at 10 years old, the product is not recommended for use by children.

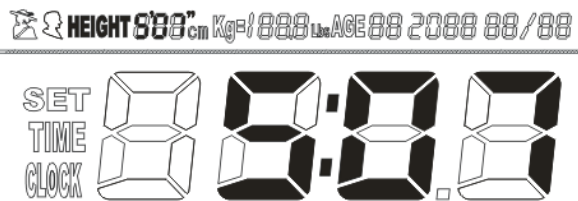
**HEIGHT:**

- Display range:

3 FEET 4 INCHES ~ 7 FEET; 1 INCH increments / 101 ~ 214 CM; 1 CM increments; **the product is not recommended for use by children.**

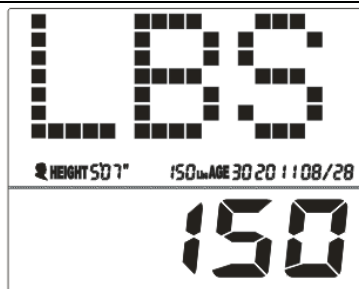
**WEIGHT:**

- Display range:

45 ~ 400LBS; 1 LB increments / 20 ~ 181 KGS; 1 KG increments; **the product is not recommended for use by children.**

**TARGET H.R.:**

- Display range:

50 ~ 180 BPM (beats per minute) ; 1 BPM increments.

COMPUTER OPERATION

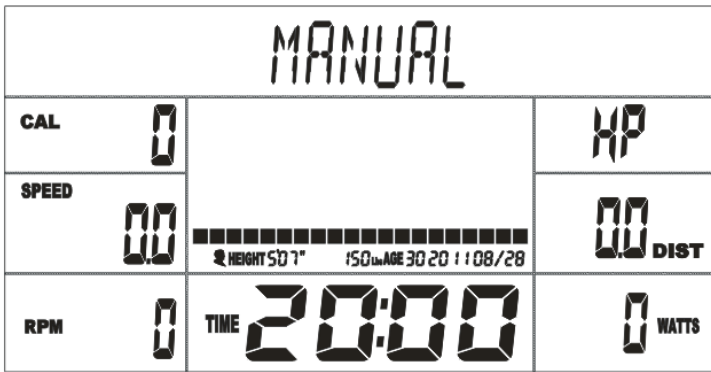

1 Press any button on the console to turn on the console

- a. Make sure that the power cord is properly plugged into the socket.
- b. The console would automatically shut off after 5 minutes of inactivity.
- c. Press any button on the console or begin pedaling to turn on the console. After a few seconds, the console will then light up with a short beep sound, indicating the console will be ready for use.

2 "Start Pause" button, as an easy way to reset the computer and enter into POWER ON status

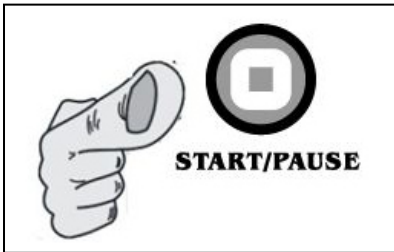

Hold the **START/PAUSE** button for a few seconds to reset the computer and returning all workout values to zero, and enter into **POWER ON** status.

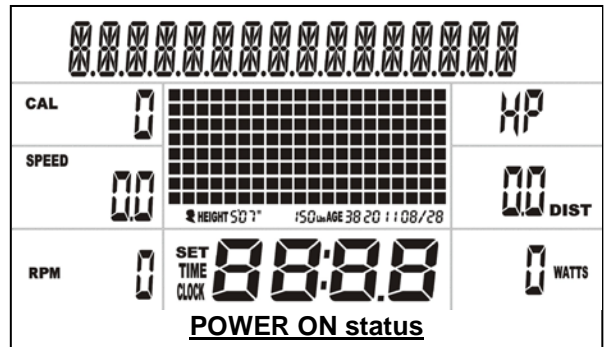

3 MANUAL PROGRAM

A. ENTER MANUAL PROGRAM

QUICK START:

Pressing When in Power on status press the start button to immediately start a manual program

OR



ENTER the USER DATA

Press the UP or Down Button until MANUAL is displayed. Press Enter to confirm. Once the MANUAL program has been chosen you will enter your personal information by following the directions on the next page.

COMPUTER OPERATION

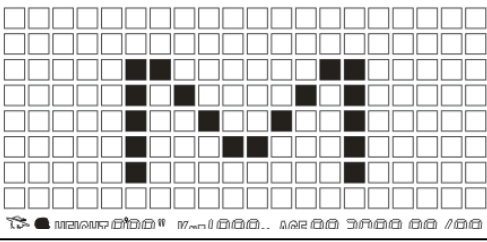
B. SET YOUR GENDER



- After pressing **UP** or **Down** button to enter into **MANUAL PROGRAM** press **ENTER** to Confirm, the **GENDER** function mode will appear with  /Male icon display flashing.
- Use **UP** or **DOWN** buttons to set your gender (Male:  or Female: ).
- Press the **ENTER** button to confirm.

C. SET YOUR AGE

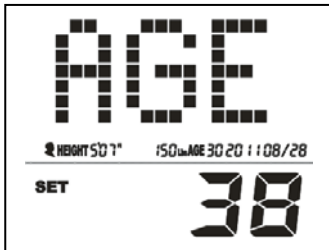

- The **AGE** function will appear with the **AGE** display flashing.
- Use the **UP** or **DOWN** buttons to set your **AGE** (10 ~ 99 YEARS OLD; in 1 YEAR INCREMENTS).
- Press the **ENTER** button to confirm. **NOTE: Although the console allows input for age beginning at 10 years old, the product is not recommended for use by children**

D. SET YOUR HEIGHT

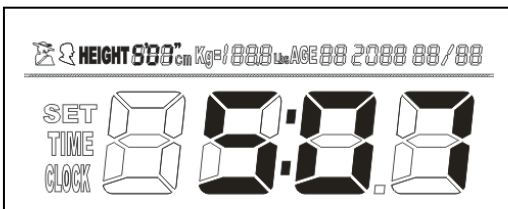

- The **HEIGHT** function will appear with the **HEIGHT** display flashing.
- Use the **UP** or **DOWN** buttons to set your **HEIGHT** (3 FEET 4 INCHES ~ 7 FEET; 1 INCH INCREMENTS/ 101 ~ 214 CM; 1 CM INCREMENTS).
- Press the **ENTER** button to confirm.

NOTE for HEIGHT: The product is not recommended for use by children

E. SET YOUR WEIGHT

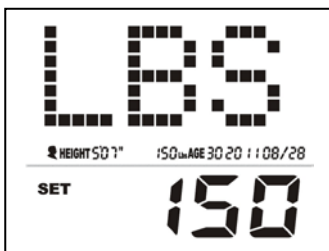

- The **WEIGHT** function will appear with the **WEIGHT** display flashing.
- Use the **UP** or **DOWN** buttons to set your **WEIGHT** (45 TO 400 LBS / 20 TO 181KGS; 1 LBS/KG INCREMENTS).
- Press the **ENTER** button to confirm.

NOTE for WEIGHT: The product is not recommended for use by children

COMPUTER OPERATION

F. SET THE TIME



- The **TIME** function will appear with the **TIME** display flashing.
- Use the **UP** or **DOWN** buttons to set the desired **TIME (00:00 TO 99:00; 1 MINUTE INCREMENTS)**.
- Press the **ENTER** button to confirm.

NOTE for TIME:

- Count Up: If a target time was not selected, the **TIME** will count up from **0:00** to a maximum of **99:59** minutes
- Count Down: If you have set the target time, the console will count down from that selected target time to **0:00**

G. START TO EXERCISE

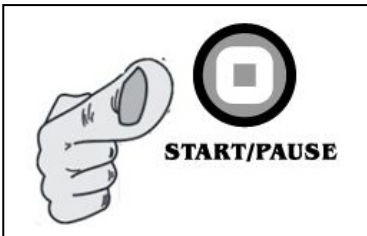

Press **START/ PAUSE** to begin your exercise.

H. CHANGING THE RESISTANCE SETTING

You can change the resistance level (from 1 to 16 levels) at any time during workout by pressing the **UP** or **DOWN** button

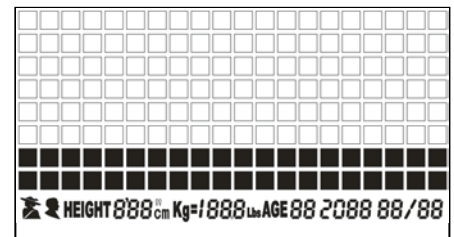

COMPUTER OPERATION

CONSOLE INSTRUCTIONS – PROGRAM (P2 ~ P10)



A. ENTER THE PRESET PROGRAMS

To enter one of the nine preset programs.

- Press any button on the console to turn on the console. After a few seconds, the console will then light up with a short beep sound, indicating the console will be ready for use.
- Make sure that the power cord is properly plugged into the socket.
- The console would automatically shut off after 5 minutes of inactivity.
- Press the UP or DOWN buttons to select program 2 ~ 10 (SEE PROGRAM SELECTION ON PAGE 36)
- Once the preferred program is displayed press enter to confirm.
- Enter your USER Data

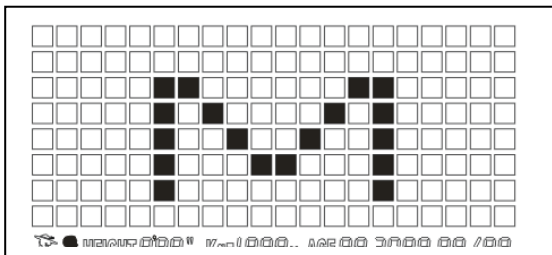
B. SET YOUR GENDER



- After pressing **UP** or **Down** button to enter into **MANUAL PROGRAM** press **ENTER** to Confirm, the **GENDER** function mode will appear with  /Male icon display flashing.
- Use **UP** or **DOWN** buttons to set your gender (Male:  or Female: ).
- Press the **ENTER** button to confirm.

C. SET YOUR AGE

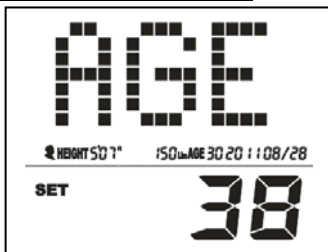

- The **AGE** function will appear with the **AGE** display flashing.
- Use the **UP** or **DOWN** buttons to set your **AGE** (10 ~ 99 YEARS OLD; in 1 YEAR INCREMENTS).
- Press the **ENTER** button to confirm. **NOTE: Although the console allows input for age beginning at 10 years old, the product is not recommended for use by children.**

COMPUTER OPERATION

D. SET YOUR HEIGHT

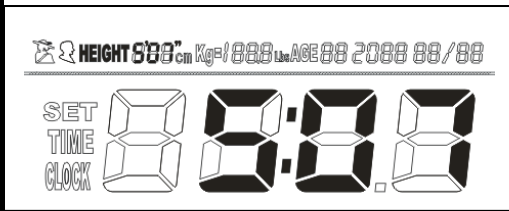

- The **HEIGHT** function will appear with the **HEIGHT** display flashing.
- Use the **UP** or **DOWN** buttons to set your **HEIGHT (3 FEET 4 INCHES ~ 7 FEET; 1 INCH INCREMENTS/ 101 ~ 214 CM; 1 CM INCREMENTS)**.
- Press the **ENTER** button to confirm.

NOTE for HEIGHT: The product is not recommended for use by children

E. SET YOUR WEIGHT

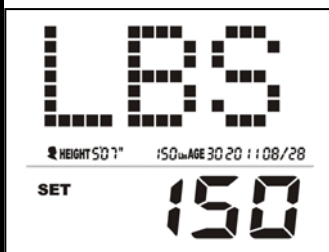

- The **WEIGHT** function will appear with the **WEIGHT** display flashing.
- Use the **UP** or **DOWN** buttons to set your **WEIGHT (45 TO 400 LBS / 20 TO 181KGS; 1 LBS/KG INCREMENTS)**.
- Press the **ENTER** button to confirm.

NOTE for WEIGHT: The product is not recommended for use by children

F. SET THE TIME

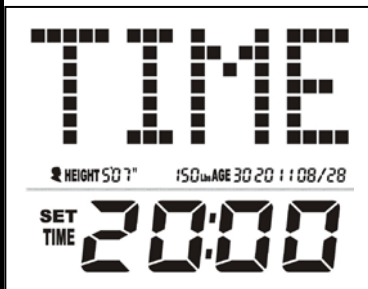

- The **TIME** function will appear with the **TIME** display flashing.
- Use the **UP** or **DOWN** buttons to set the desired **TIME (00:00 TO 99:00; 1 MINUTE INCREMENTS)**.
- Press the **ENTER** button to confirm.

NOTE for TIME:

- Count Up: If a target time was not selected, the **TIME** will count up from 0:00 to a maximum of 99:59 minutes
- Count Down: If you have set the target time, the console will count down from that selected target time to 0:00

COMPUTER OPERATION

G. START TO EXERCISE

Press **START/ PAUSE** to begin your exercise.

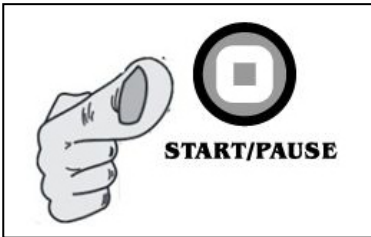

H. CHANGING THE RESISTANCE SETTING

You can change the resistance level (from 1 to 16 levels) at any time during workout by pressing the **UP** or **DOWN** button

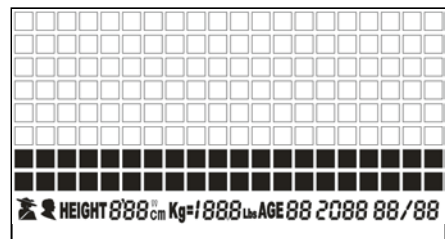

COMPUTER OPERATION

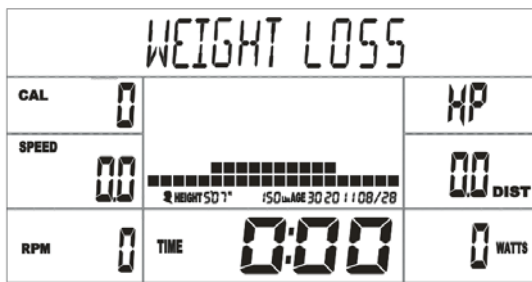

P1 WEIGHT LOSS



P2 NOVICE INTERVAL

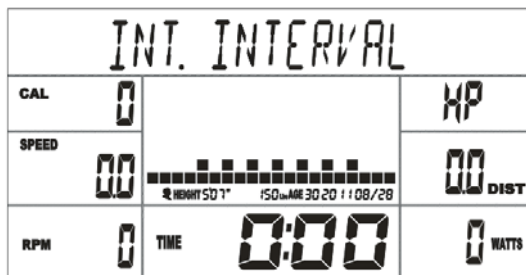

P3 INTERMEDIATE INTERVAL



P4 MOUNTAIN CLIMB

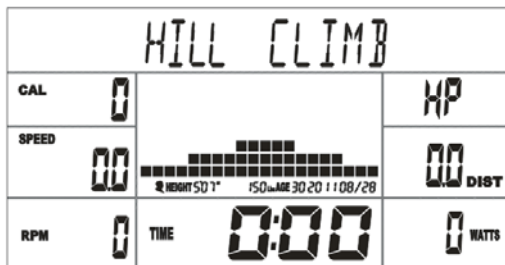

P5 HILL CLIMB

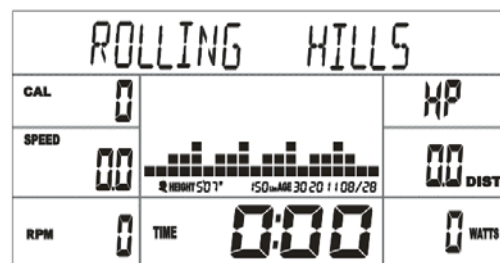

P6 ROLLING HILLS



P7 GRADUATING INTERVAL

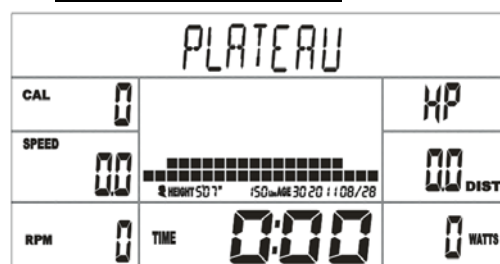

P8 PLATEAU



P9 ADVANCED INTERVAL

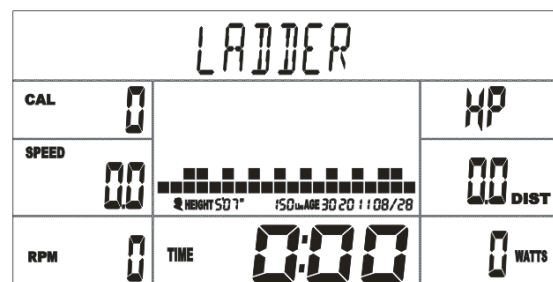

P10 LADDER

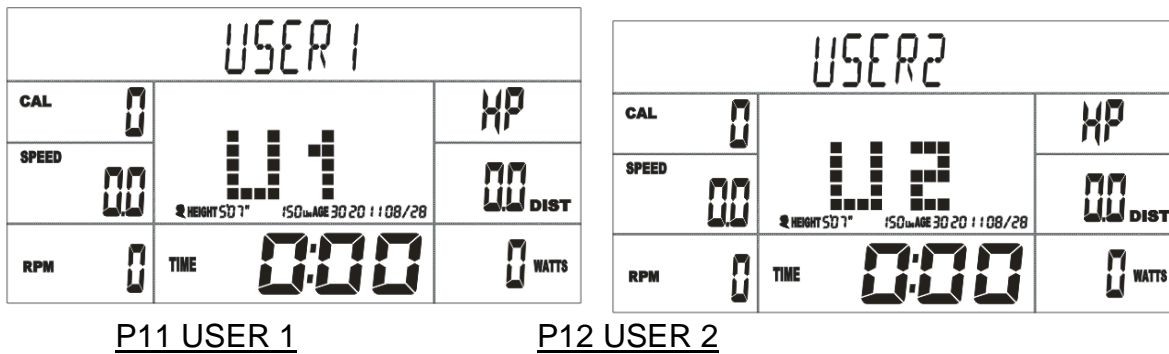

COMPUTER OPERATION

CONSOLE INSTRUCTIONS – PROGRAM (P11 ~ 12)

**1 To enter one of the 2 USER programs.**

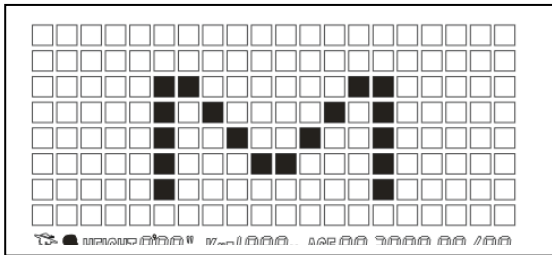
- Press any button on the console to turn on the console. After a few seconds, the console will then light up with a short beep sound, indicating the console will be ready for use.
- Make sure that the power cord is properly plugged into the socket.
- The console would automatically shut off after 5 minutes of inactivity.
- Press the UP or DOWN buttons to select program 11~12
- Once the preferred program is displayed press enter to confirm.
- Enter your USER Data

B. SET YOUR GENDER

- After pressing **UP** or **Down** button to enter into **MANUAL PROGRAM** press **ENTER** to Confirm, the **GENDER** function mode will appear with  /Male icon display flashing.
- Use **UP** or **DOWN** buttons to set your gender (Male:  or Female: ).
- Press the **ENTER** button to confirm.

COMPUTER OPERATION

C. SET YOUR AGE

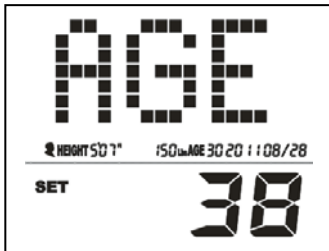

- The **AGE** function will appear with the **AGE** display flashing.
- Use the **UP** or **DOWN** buttons to set your **AGE** (**10 ~ 99 YEARS OLD; in 1 YEAR INCREMENTS**).
- Press the **ENTER** button to confirm. **NOTE: Although the console allows input for age beginning at 10 years old, the product is not recommended for use by children**

D. SET YOUR HEIGHT

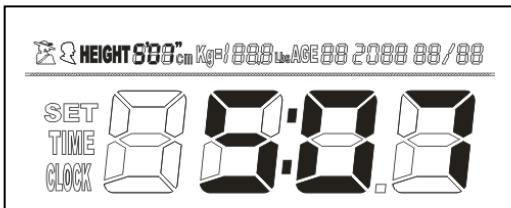

- The **HEIGHT** function will appear with the **HEIGHT** display flashing.
- Use the **UP** or **DOWN** buttons to set your **HEIGHT** (**3 FEET 4 INCHES ~ 7 FEET; 1 INCH INCREMENTS/ 101 ~ 214 CM; 1 CM INCREMENTS**).
- Press the **ENTER** button to confirm.

NOTE for HEIGHT: The product is not recommended for use by children

E. SET YOUR WEIGHT

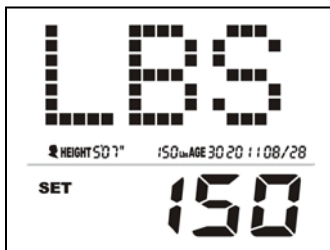

- The **WEIGHT** function will appear with the **WEIGHT** display flashing.
- Use the **UP** or **DOWN** buttons to set your **WEIGHT** (**45 TO 400 LBS / 20 TO 181KGS; 1 LBS/KG INCREMENTS**).
- Press the **ENTER** button to confirm.

NOTE for WEIGHT: The product is not recommended for use by children

COMPUTER OPERATION

F. SET THE TIME



- The **TIME** function will appear with the **TIME** display flashing.
- Use the **UP** or **DOWN** buttons to set the desired **TIME (00:00 TO 99:00; 1 MINUTE INCREMENTS)**.
- Press the **ENTER** button to confirm.

NOTE for TIME:

- Count Up: If a target time was not selected, the **TIME** will count up from **0:00** to a maximum of **99:59** minutes
- Count Down: If you have set the target time, the console will count down from that selected target time to **0:00**

G. START TO EXERCISE

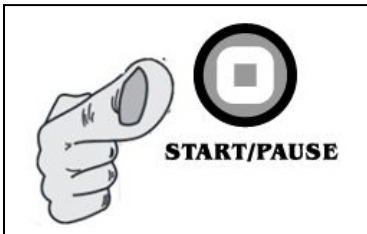

Press **START/ PAUSE** to begin your exercise.

H. CHANGING THE RESISTANCE SETTING

You can change the resistance level (from 1 to 16 levels) at any time during workout by pressing the **UP** or **DOWN** button

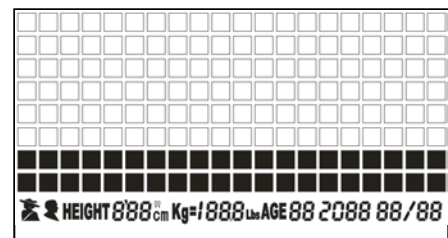

2 Programing the 2 USER programs.

- Once the **USER** data has been entered press the **UP** or **DOWN** buttons to adjust the level of the first segment.
- Press enter to confirm and move to the next segment
- Repeat this process until the preferred program has been completed.
- Press start to save and begin the program
- This program can be overwritten at any time in the set up screen.

COMPUTER OPERATION

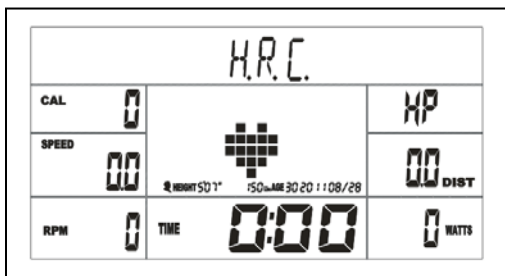

1 Prior information: Press any button on the console to turn on the console

- a. Make sure that the power cord is properly plugged into the socket.
- b. The console would automatically shut off after 5 minutes of inactivity.
- c. Press any button on the console to turn on the console. After a few seconds, the console will then light up with a short beep sound, indicating the console will be ready for use.

2 Prior information: "HOLD TO RESET" button, an easy way to reset and enter into POWER ON status

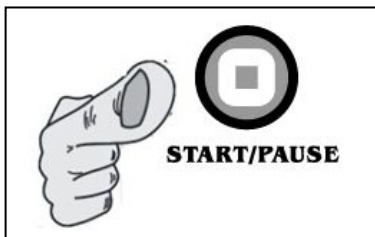

Continue pressing **HOLD TO RESET** button a few seconds, all the date will reset to the initial value and the console will return to **POWER ON** status.

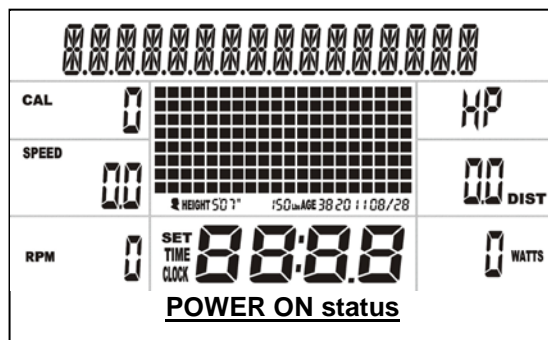

3 PROGRAM (P13)

A. ENTER P13



UP or DOWN button and then ENTER button:

Press UP or DOWN button to select **PROGRAM (P13)** and then press ENTER button to confirm and enter **PROGRAM (P13)**.

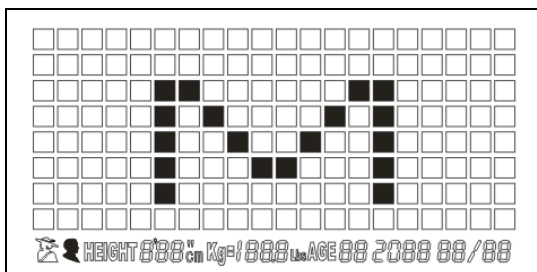
B. SET YOUR GENDER



UP or DOWN button & then ENTER button:

- a. After pressing the ENTER button to enter into **H.R.C. PROGRAM (P13)**, the **GENDER** function mode will appear with  /Male icon display flashing.
- b. Use UP or DOWN buttons to set your gender (Male:  or Female: ).
- c. Press the ENTER button to confirm your **GENDER** and enter the mode to set the **AGE**.

COMPUTER OPERATION

CONSOLE INSTRUCTIONS –H.R.C. PROGRAM (P13)

C. SET YOUR AGE

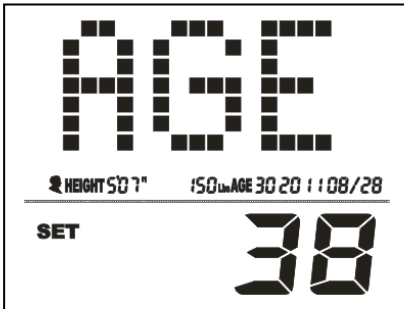

UP or **DOWN** button & then **ENTER** button:

- The **AGE** function mode will appear with the value of **AGE** display flashing.
- Use **UP** or **DOWN** buttons to set your personal **AGE** (**10 ~ 99 YEARS OLD; 1 YEAR-OLD INCREMENT**).
- Press the **ENTER** button to confirm **AGE** value and enter the **HEIGHT** mode. **NOTE: Although the console allows input for age beginning at 10 years old, the product is not recommended for children's use**

D. SET YOUR PERSONAL HEIGHT

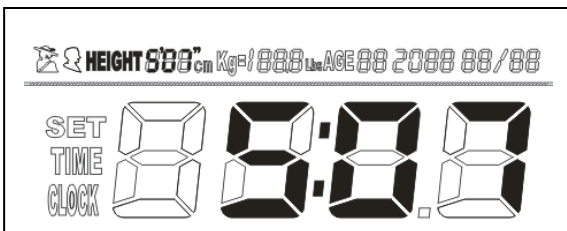

UP or **DOWN** button & then **ENTER** button:

- Press the **ENTER** button to confirm **HEIGHT** value and enter the **WEIGHT** mode.

NOTE for HEIGHT: The product is not recommended for children's use

E. SET YOUR PERSONAL WEIGHT



UP or **DOWN** button & then **ENTER** button:

- The **WEIGHT** function mode will appear with the value of **WEIGHT** display flashing.
- Use **UP** or **DOWN** buttons to set your personal **WEIGHT** (**45 TO 400 LBS / 20 TO 181KGS; 1 LBS/KG INCREMENT**).
- Press the **ENTER** button to confirm **WEIGHT** value and enter the **TIME** mode.

NOTE for WEIGHT: The product is not recommended for children's use

F. SET THE DESIRED TIME



UP or **DOWN** button & then **ENTER** button:

- The **TIME** function mode will appear with the value of **TIME** display flashing.
- Use **UP** or **DOWN** buttons to set the desired **TIME** (**00:00 TO 99:00; 1 MINUTE INCREMENT**).
- Press the **ENTER** button to confirm **TIME** value and enter the **TARGET HEART RATE** mode.

COMPUTER OPERATION

CONSOLE INSTRUCTIONS –H.R.C. PROGRAM (P13)

G. SET THE TARGET HEART RATE



UP or DOWN button & then ENTER button:

- The **TARGET HEART RATE** function mode will appear with the value of **TARGET HEART RATE** display flashing.
- Use **UP** or **DOWN** button to set your desired **TARGET HEART RATE (50 ~ 180 BPM (BEATS PER MINUTE; 1 BPM INCREMENT))**.
- Press the **ENTER** button to confirm **TARGET HEART RATE** value.

H. START EXERCISE

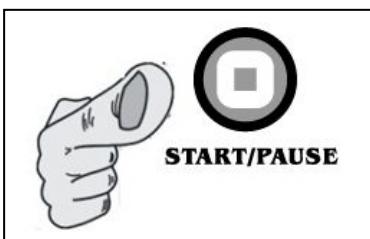

START/ PAUSE button: Press **START/ PAUSE** to begin exercise.

I. MUST-KNOWN HEART RATE PROGRAM INFO.

CONSOLE MONITOR YOUR CURRENT PULSE TO COMPARE WITH YOUR SETTING TARGET HEART RATE:

- 3 minute WARM UP time:** After enter the H.R.C. program, the program will start begin with 3 minute WARM UP time, during the WARM UP mode, the console will detects the user's heart rate through hand pulse sensors or wireless chest belt. During the WARM UP time, the torque/resistance level is available to adjust from 1 ~ 16 levels.
- After the 3-minute warm up is complete, then go into the H.R.C. main program (the time will change to your desired step-up time, the resistance will return to the Level 1). The console at this time will monitor your actual pulse and adjust the resistance/torque level automatically to keep your pulse within your **TARGET HEART RATE ZONE.**
- If you current pulse > (the value of the TARGET HEART RATE + 10), the console would decrease one resistance/torque level automatically.
- If you current pulse < (the value of the TARGET HEART RATE - 10), the console would increase one resistance/torque level automatically.

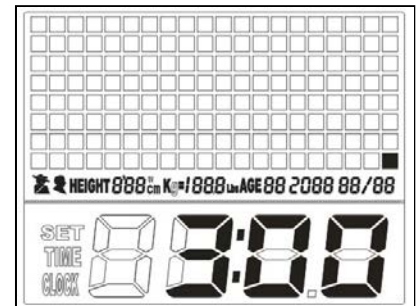

NOTE: During H.R.C. main program, if you do not wear a chest belt or place your hands correctly on the pulse sensors, after 30 seconds, the console will display "NO HEART RATE" message and then turn off the pulse circuit and stop the program. The console will then display an error message "PAUSE". Press **START** button and be sure to wear a chest belt or place your hands back on the Pulse Sensors correctly, the pulse readout will appear again and continue starting the program.

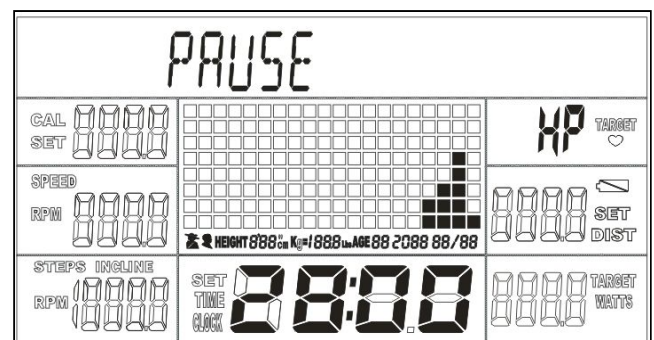

COMPUTER OPERATION

CONSOLE INSTRUCTIONS –H.R.C. INTERVAL PROGRAM (P14)

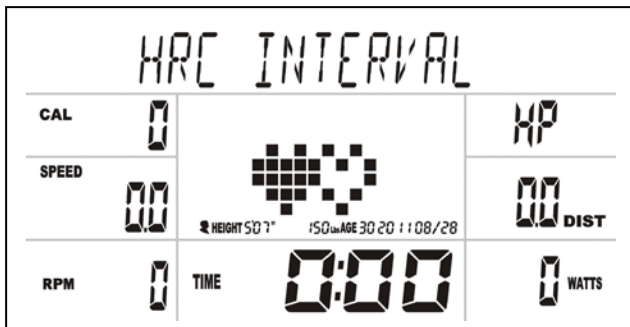
**1 Prior information: Press any button on the console or begin pedaling to turn on the console**

- Make sure that the power cord is properly plugged into the socket.
- The console would automatically shut off after 5 minutes of inactivity.
- Press any button on the console or begin pedaling to turn on the console. After a few seconds, the console will then light up with a short beep sound, indicating the console will be ready for use.

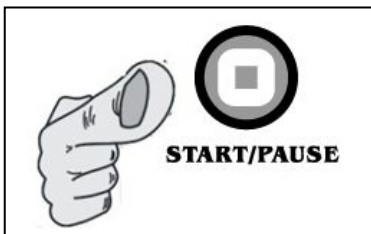
2 Prior information: "HOLD TO RESET" button, an easy way to reset and enter into POWER ON status

Continue pressing **HOLD TO RESET** button a few seconds, all the date will reset to the initial value and the console will return to **POWER ON** status.

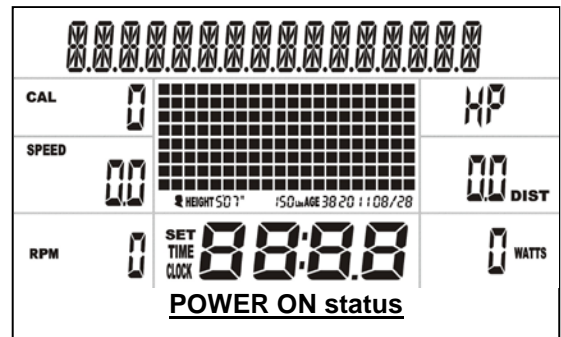
**3 Normal way to operate PROGRAM (P14)****A. ENTER P14**

UP or **DOWN** button and then **ENTER** button:

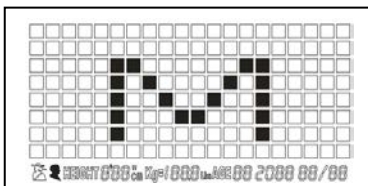

Press **UP** or **DOWN** button to select **H.R.C. INTERVAL PROGRAM (P14)** and then press **ENTER** button to confirm and enter **PROGRAM (P14)**.

B. SET YOUR GENDER

UP or **DOWN** button & then **ENTER** button:

- After pressing the **ENTER** button to enter into **H.R.C. INTERVAL**

PROGRAM (P14), the **GENDER** function mode will appear with  /Male icon display flashing.

- Use **UP** or **DOWN** buttons to set your gender (Male:  or Female: ).
- Press the **ENTER** button to confirm your **GENDER** and enter the mode to set the **AGE**.

COMPUTER OPERATION

CONSOLE INSTRUCTIONS –H.R.C. INTERVAL PROGRAM (P14)

C. SET YOUR AGE

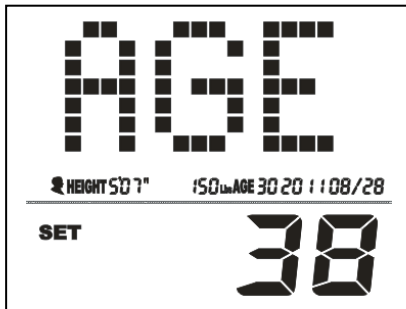

UP or DOWN button & then ENTER button:

- The AGE function mode will appear with the value of AGE display flashing.
- Use UP or DOWN buttons to set your personal AGE (10 ~ 99 YEARS OLD; 1 YEAR-OLD INCREMENT).
- Press the ENTER button to confirm AGE value and enter the HEIGHT mode. **NOTE: Although the console allows input for age beginning at 10 years old, the product is not recommended for children's use**

D. SET YOUR PERSONAL HEIGHT

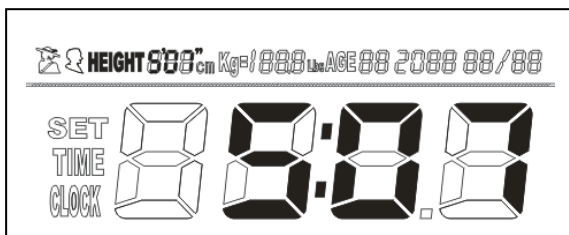

UP or DOWN button & then ENTER button:

- The HEIGHT function mode will appear with the value of HEIGHT display flashing.
- Use UP or DOWN buttons to set your personal HEIGHT (3 FEET 4 INCHES ~ 7 FEET; 1 INCH increment / 101 ~ 214 CM; 1 CM INCREMENT).
- Press the ENTER button to confirm HEIGHT value and enter the WEIGHT mode.

NOTE for HEIGHT: The product is not recommended for children's use

E. SET YOUR PERSONAL WEIGHT

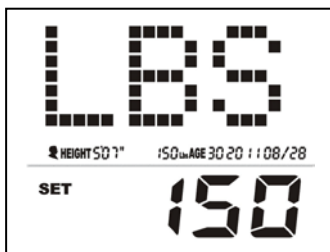

UP or DOWN button & then ENTER button:

- The WEIGHT function mode will appear with the value of WEIGHT display flashing.
- Use UP or DOWN buttons to set your personal WEIGHT (45 TO 400 LBS / 20 TO 181KGS; 1 LBS/KG INCREMENT).
- Press the ENTER button to confirm WEIGHT value and enter the TIME mode.

NOTE for WEIGHT: The product is not recommended for children's use

F. SET THE DESIRED TIME



UP or DOWN button & then ENTER button:

- The TIME function mode will appear with the value of TIME display flashing.
- Use UP or DOWN buttons to set the desired TIME (00:00 TO 99:00; 1 MINUTE INCREMENT).
- Press the ENTER button to confirm TIME value and enter the HIGH TARGET HEART RATE mode.

COMPUTER OPERATION

CONSOLE INSTRUCTIONS –H.R.C. INTERVAL PROGRAM (P14)

G. SET THE HIGH TARGET HEART RATE

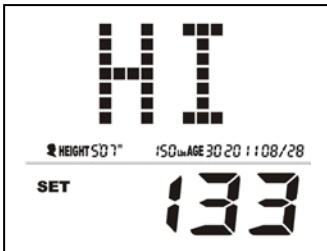

UP or **DOWN** button & then **ENTER** button:

- a. The **HIGH TARGET HEART RATE** function mode will appear with the value of **HIGH TARGET HEART RATE** display flashing. **NOTE: the default value of HIGH TARGET HEART RATE is based on 75% of (220 – your age).**

- b. However, if the default value of HIGH TARGET HEART RATE doesn't match your need, it's able to use **UP** or **DOWN** button to slightly adjust your desired **HIGH TARGET HEART RATE (70 ~ 180 BPM (BEATS PER MINUTE; 1 BPM INCREMENT)). NOTE: HIGH TARGET HEART RATE must higher 10 + value of LOW TARGET HEART RATE** in order to make this program workable.

Make sure that the setting value of HIGH TARGET HEART RATE is reachable to your ideal health condition as the console will monitor your actual heart rate comparing with HIGH TARGET HEART RATE to automatically adjust the resistance level.

- c. Press the **ENTER** button to confirm **HIGH TARGET HEART RATE** value and enter the **LOW TARGET HEART RATE** mode.

H. SET THE LOW TARGET HEART RATE

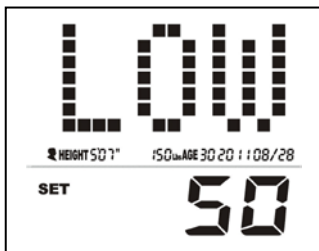

UP or **DOWN** button & then **ENTER** button:

- a. The **LOW TARGET HEART RATE** function mode will appear with the value of **LOW TARGET HEART RATE** display flashing. **NOTE: the default value of LOW TARGET HEART RATE is based on 60% of (220 – your age).**

- b. However, if the default value of HIGH TARGET HEART RATE doesn't match your need, it's able to use **UP** or **DOWN** button to slightly adjust your desired **LOW TARGET HEART RATE (50 ~ 160 BPM (BEATS PER MINUTE; 1 BPM INCREMENT)). NOTE: LOW TARGET HEART RATE must lower 10 + value of HIGH TARGET HEART RATE** in order to make

this program workable. Make sure that the setting value of LOW TARGET HEART RATE is reachable to your ideal health condition as the console will monitor your actual heart rate comparing with LOW TARGET HEART RATE to automatically adjust the resistance level.

- c. Press the **ENTER** button to confirm **LOW TARGET HEART RATE** value.

I. START EXERCISE

START/ PAUSE button: Press **START/ PAUSE** to begin exercise.

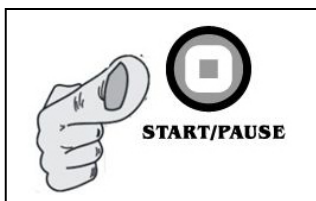

Age	Average Max./High Heart Rate 75%
20	150 beats per minute
25	146 beats per minute
30	142 beats per minute
35	138 beats per minute
40	135 beats per minute
45	131 beats per minute
50	127 beats per minute
55	124 beats per minute
60	120 beats per minute
65	116 beats per minute
70	112 beats per minute

Reference Table

Age	Target Heart Rate Zone (60% of Min./Low Heart Rate)
20	120 beats per minute
25	117 beats per minute
30	114 beats per minute
35	111 beats per minute
40	108 beats per minute
45	105 beats per minute
50	102 beats per minute
55	99 beats per minute
60	96 beats per minute
65	93 beats per minute
70	90 beats per minute

Reference Table

COMPUTER OPERATION

CONSOLE INSTRUCTIONS –H.R.C. INTERVAL PROGRAM (P14)

J. MUST-KNOWN HEART RATE PROGRAM INFO.

CONSOLE MONITOR will help you reach your ideal LOW & HIGH TARGET HEART RATE

HEART RATE

- a. **3 minute WARM UP time:** After enter the H.R.C. Interval program, the program will start begin with 3 minute WARM UP time, during the WARM UP mode, the console will detects the user's heart rate through hand pulse sensors or wireless chest belt. During the WARM UP time, the torque/resistance level is available to adjust from 1 ~ 16 levels. NOTE: During the warm-up time, the console will start monitoring your actual hear rate to see whether could match your ideal value of **LOW TARGET HEART RATE.**
- b. After 3-minute warm up time, the console will start adjusting the resistance level automatically if your actual heart rate couldn't reach your ideal value of **LOW TARGET HEART RATE.** Once you actual heart rate match to your ideal value of **LOW TARGET HEART RATE**, the resistance level would be fixed for about 2 minutes. **NOTE: If your actual heart rate couldn't reach to your ideal value of LOW TARGET HEART RATE, the console will keep increasing the resistance level every 15 seconds until your actual heart rate reaches your ideal value of LOW TARGET HEART RATE.**
- c. Once your actual heart rate is in the **LOW TARGET HEART RATE ZONE** with another 2-minutes workout, the console will start increasing the resistance level in order to help your actual heart rate to reach to your ideal value of **HIGH TARGET HEART RATE.** Once you actual heart rate match to your ideal value of **HIGH TARGET HEART RATE**, the resistance level would be fixed for about 2 minutes. **NOTE: If your actual heart rate couldn't reach to your ideal value of HIGH TARGET HEART RATE, the console will keep increasing the resistance level every 15 seconds until your actual heart rate reaches your ideal value of HIGH TARGET HEART RATE.**
- d. Once your actual heart rate is in the **HIGH TARGET HEART RATE ZONE** with another 2-minutes workout, the console will start decreasing the resistance level in order to help your actual heart rate to reach to your ideal value of **LOW TARGET HEART RATE.** Once you actual heart rate match to your ideal value of **LOW TARGET HEART RATE**, the resistance level would be fixed for about 2 minutes. **NOTE: If your actual heart rate couldn't reach to your ideal value of LOW TARGET HEART RATE, the console will keep decreasing the resistance level every 15 seconds until your actual heart rate reaches your ideal value of LOW TARGET HEART RATE.**
- e. The workout method will follow the above method until the workout time is finished.

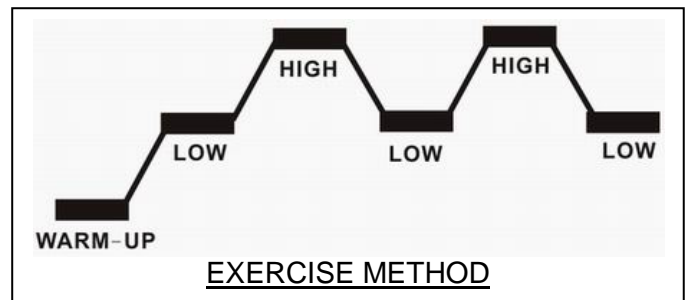
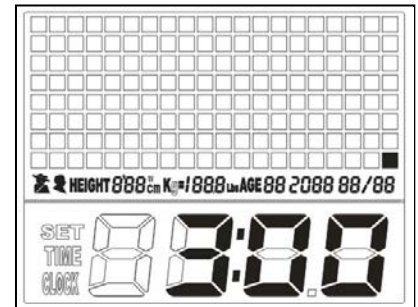

LIMITED WARRANTY

991214(1)

LIMITED HOME USE WARRANTY – SMOOTH FITNESS Bikes Warranty

Warranty Coverage: EVO Fitness and Smooth Fitness, Inc. ("Smooth Fitness") warrants to the original owner that each new product to be free from defects in workmanship and material, under normal use and conditions.

Period of Coverage: The Warranty on this product runs from the date of original purchase using the following schedule:

Model Name	Frame	Break	Parts & Electronics	Labor
V380 USA only	Lifetime	Lifetime	5 years	2 year
V380 Canada	Lifetime	Lifetime	5 years	1 year

Labor: Smooth Fitness will reimburse for labor costs for Two (2) years*. Smooth Fitness reserves the right to either: Hire and reimburse an independent service technician who will come into the home for the repair,
OR

In the event that there is not an available certified Smooth Fitness service technician, Smooth will send the part directly to the consumer and will pay \$75 US per occurrence for the labor costs of such repair. If multiple repair attempts must be made for one reported problem, Smooth will only reimburse once per occurrence.

Smooth Fitness reserves the right to inspect damaged parts for misuse. Your Original Receipt is proof of purchase and should be kept with the product manual. You may be required to show proof of purchase prior to warranty service being initiated.

Remedy Provided by Smooth Fitness: Smooth Fitness will provide a replacement part free of charge if a defect is found during the Warranty period. Smooth Fitness may at its discretion, choose to provide any of following parts or repair options. In the event that a part is determined in need of replacement, upon receipt of the part by Smooth Fitness, Smooth Fitness may send out the part by UPS ground or another such carrier directly to the customer's home.

Any redemption may be by repair or replacement of the affected parts and/or product at the sole discretion of Smooth Fitness, by personnel approved by Smooth Fitness.

Parts repaired or replaced pursuant to this Warranty shall be warranted for the unexpired portion of the Warranty applying to the original product. Any technical advice furnished before or after delivery in regard to the use or application of Smooth Fitness products is furnished without charge and on the basis that it represents Smooth Fitness' best judgment under the circumstances but that the advice is used at your sole risk.

Procedure for Obtaining Your Remedy Under This Warranty: To obtain service on a Smooth Fitness product, call Smooth Fitness. In the instance that service is not available in an area, Smooth Fitness, at its discretion, can either 1) find a service technician in your area to perform warranty service, 2) have a local dealer perform warranty service, or 3) send the warranty parts to you and reimburse as described above. To help the technician assist you, please have the following information ready:

- Model name or number from the cover of the manual;
- Serial number located on the frame of the unit; and
- The part description and the order number.

Limitations on Warranty: This Warranty does not cover any problems, damages or failures that are caused by accident, improper assembly, failure to observe cautionary labels on the product, failure to operate the product correctly, power grid failures or spikes from your local electricity provider, abuse or freight damage. Smooth Fitness does not warrant against any damage or defects that may result from repair or alterations made to the product by an unauthorized repair facility. In order for this warranty to be valid, all Smooth Fitness and EVO Fitness exercise equipment must be stored and used in a fully finished and livable room within the residence (not including an indoor swimming pool room).

This Warranty shall terminate if you sell or otherwise transfer this product. This Warranty does not apply to any product shipped or handled outside of the United States or Canada. This Warranty does not apply if the product is used as a rental product or in commercial use. Consequential and incidental damages are not recoverable under this Warranty. (Some states do not allow the exclusion or limitation of incidental or consequential damages, so the above limitation or exclusion may not apply to you.)

THIS WARRANTY IS EXPRESSLY IN LIEU OF ALL OTHER EXPRESS WARRANTIES. ALL IMPLIED WARRANTIES, INCLUDING WARRANTIES OF MERCHANTABILITY OR FITNESS FOR ANY PARTICULAR PURPOSE, ARE LIMITED IN DURATION TO TWO (2) YEARS* FROM THE EFFECTIVE DATE OF THIS WARRANTY. SMOOTH FITNESS IS NOT LIABLE FOR CONSEQUENTIAL OR INCIDENTAL DAMAGES RESULTING FROM ANY DEFECT IN PARTS NOR FOR ANY BREACH OF EXPRESS OR IMPLIED WARRANTIES. SMOOTH FITNESS' SOLE LIABILITY UNDER THIS WARRANTY IS LIMITED TO THE TERMS DESCRIBED IN THIS FORM. THIS WARRANTY GIVES YOU SPECIFIC LEGAL RIGHTS, AND YOU MAY ALSO HAVE OTHER RIGHTS WHICH VARY FROM STATE TO STATE.

*Two year labor is valid only with the continental United States; Canadian labor warranties are valid for the period of 1 year from date of purchase.

FORM WS-1 (rev. 03/2008)



Smooth Fitness
780 5th Ave
King of Prussia, PA 19406

Toll Free Customer Service:
1.888.800.1167

Website:
www.smoothfitness.com

Free Manuals Download Website

<http://myh66.com>

<http://usermanuals.us>

<http://www.somanuals.com>

<http://www.4manuals.cc>

<http://www.manual-lib.com>

<http://www.404manual.com>

<http://www.luxmanual.com>

<http://aubethermostatmanual.com>

Golf course search by state

<http://golfingnear.com>

Email search by domain

<http://emailbydomain.com>

Auto manuals search

<http://auto.somanuals.com>

TV manuals search

<http://tv.somanuals.com>