

Safety Instructions & Operator's Manual For
TURF CRUISER™
TRAIL CRUISER™

UTILITY VEHICLES†
SERIES 1

UV1621BV (7085668)

UVG1621BV (7085632)

UVGT1621BV (7085903)



UVGT1621BV shown

NOTE: Not all utility vehicle models
come with accessories shown above.

Thank you for buying a Turf Cruiser™/Trail Cruiser™ Utility Vehicle! Before operating your machine, read this manual carefully and pay particular attention to the "IMPORTANT SAFETY INSTRUCTIONS" on Pages 2 thru 6. Remember that all power equipment can be dangerous if used improperly. Also keep in mind that SAFETY requires careful use in accordance with the operating instructions and common sense!

NOTE: Specifications are correct at time of printing and are subject to change without notice.

* Actual sustained equipment horsepower will likely be lower due to operating limitations and environmental factors.

† Turf Cruiser™ & Trail Cruiser™ utility vehicles are manufactured by Snapper Products Inc., McDonough, GA 30253.

MANUAL CONTENT COPYRIGHT © 2004
SNAPPER – A DIVISION OF SIMPLICITY MFG. INC.
ALL RIGHTS RESERVED

MANUAL No. 7026153 (Rev. 2, 11/11/04)
TP 100-5107-2-GC-N

IMPORTANT SAFETY INSTRUCTIONS



WARNING



This machine is a multi-purpose utility vehicle intended for off-road use only. It is not a toy and it is not a recreation vehicle. Careless, reckless operation can cause accidents resulting in damage and injury. Failure to comply with the following SAFETY instructions could result in serious injury or death to the operator or others. The owner of the machine must understand these instructions and only allow persons that understand these instructions to operate the machine. The operator must be an adult or teenager with mature judgment, 16 years old or older, and must possess a valid driver's license. Each operator must evaluate his or her ability to operate the machine safely and is responsible for the safe operation of the machine and the safety of a passenger. Safe operation of the machine limits the number of occupants to one operator and only one passenger. Both the operator and the passenger must be seated in the seats provided with the seat belt buckle securely latched and the seat belt adjusted to a snug fit. The person operating the machine must be of sound mind and body and must not be under the influence of any substance, which might impair vision, dexterity or judgment. If you have any questions pertaining to your machine, which your dealer cannot answer to your satisfaction, call or write the Customer Service Department at SNAPPER, McDonough, Georgia 30253. Phone: 800-935-2967.

PROTECTION FOR CHILDREN

Tragic accidents can occur if the operator is not alert to the presence and safety of children. Children are often attracted to the machine and the work activity. Never assume that children will remain where you last saw them.

1. **KEEP** children out of the work area, away from the machine and under the watchful care of a responsible adult.
2. **DO NOT** allow children or others to ride in the cargo bed, on attachments or towed equipment. The one Passenger must be seated in the passenger seat with the seat belt buckle securely latched and the seat belt adjusted to a snug fit.
3. **DO NOT** allow pre-teenage children to operate the machine. All operators must be properly trained in the safe operation of the machine, be 16 years old or older, and possess a valid driver's license.
4. **ALLOW** only adults or responsible teenagers, 16 years old or older, with mature judgment under close adult supervision to operate machine.
5. **BEFORE BACKING**, stop machine completely. **LOOK** and **SEE** behind and down for children, pets and hazards, before and while backing.
6. **USE EXTRA CARE** and reduce speed when approaching blind corners, shrubs, trees, or other objects that may obscure vision.
7. **SEAT BELTS** are provided for the comfort and safety of the operator and a passenger and must be worn at all times. Lap-style seat belts may not provide adequate protection for small children. Carrying infants or toddlers is not recommended. **USE EXTRA CARE** when carrying a child passenger.

PROTECTION AGAINST TIPOVERS

The machine is equipped with an Operator Protective Structure. The structure when used properly can offer additional security to the operator and a passenger in the event of a tip-over accident. The lap-style seat belts must be worn at all times for proper protection. Slopes, improper loads and towing are major factors related to loss-of-control and tip-over accidents. All slopes require extra **CAUTION**. Loads, attachments and towing affect stability, handling and braking. Reduce speed, avoid sharp turns and sudden changes in speed. Allow extra distance for stopping machine.

1. **DO NOT** operate the machine on slopes exceeding 15 degrees (27% grade). Loss of control, sliding and/or tipover may occur.
2. Exercise **EXTREME CAUTION** on slopes above 10 degrees (18% grade).
3. **DO NOT** operate machine back and forth across face of slopes. Operate up and down. Practice on slopes with cargo bed empty, and no attachments or trailer hitched to machine.
4. Avoid uphill starts. If machine stops going uphill or tires lose traction, apply brake, back slowly and straight down the slope. Do not turn machine.
5. **STAY ALERT** for holes and other hidden hazards. Tall grass can hide obstacles. Keep away from ditches, washouts, culverts, fences and protruding objects.
6. Keep a safe distance (at least 3 feet) away from edge of ditches and other drop offs. The machine could turn over if an edge caves in.
7. Always begin forward motion slowly and with caution.



IMPORTANT SAFETY INSTRUCTIONS



PROTECTION AGAINST TIPOVERS

(Continued)

8. DO NOT operate machine on slopes exceeding 10 degrees (18% grade) when towing. Cargo bed must be loaded when towing.
9. DO NOT put your foot on the ground to try and stabilize the machine.
10. DO NOT operate machine under any condition where traction, steering or stability is doubtful.
11. DO NOT remove or modify the Operator Protective Structure. Operator and passenger must be properly seated and must wear seat belts, snugly fastened, at all times.
12. DO NOT shift to neutral and allow machine to coast down slope. When descending a slope apply brake to maintain safe speed and drive straight. Avoid turning when descending a slope.
13. The use of a helmet, face shield or safety glasses and substantial clothing is recommended.

CARRYING LOADS

Carrying loads affects the handling, stability and braking of the machine. Improper loads, excessive speed, sharp turns, rough ground, loose or slippery surfaces and slopes can cause loss of control, sliding and/or tip-over accidents resulting in damage, serious injury or death. Extra caution is required whenever the machine is used to carry loads.

1. DO NOT exceed rated load capacity of the machine. Reduce load and speed when operating machine on slopes.
2. DO NOT carry off-center loads. All loads must be centered in the cargo bed and secured to prevent shifting.
3. DO NOT stack loads higher than the sides of the cargo bed. Keep all loads as low as possible to minimize effect on stability.
4. Loads affect stability, handling and braking. Reduce speed, avoid sharp turns, and allow extra distance for braking.
5. DO NOT attempt to dump loads from cargo bed. Empty load before raising bed. Raising a loaded cargo bed can affect stability, resulting in tip-over.
6. DO NOT drive machine with the cargo bed in a raised position.
7. DO NOT raise cargo bed when on a slope.
8. Tire pressure is extremely important to the handling, stability and braking of the machine. Tire inflation pressure must be maintained as specified on the machine and in this manual.

CARRYING LOADS (Continued)

9. Always release accelerator and apply brake when descending slopes to maintain safe speed.
10. DO NOT replace tires with different size or construction. Tire size and construction are critical to the proper handling and stability of the machine. Use only tires approved by manufacturer.

TOWING

Towing, as with carrying loads, affects the handling, stability and braking of the machine. Towing loads requires extra caution. Reduce speeds when towing and avoid slopes whenever possible. Allow extra distance for braking.

1. DO NOT exceed rated towing capacity of machine. Reduce load on slopes.
2. DO NOT exceed rated tongue capacity of hitch.
3. DO NOT modify hitch. Towed loads must only be attached to the hitch point provided on the machine.
4. DO NOT attempt to tow where steering, traction or stability is doubtful.
5. Tow loads at a speed slow enough to maintain control. DO NOT exceed 10 MPH while towing.
6. Cargo bed must be loaded when towing to provide adequate traction and braking.
7. DO NOT tow a load that you cannot safely control.
8. DO NOT tow loads on rough ground, or loose, slippery surfaces.
9. DO NOT allow children or others to ride on a trailer or towed attachment.
10. DO NOT tow the machine behind any other machine or vehicle.

PREPARATION

Read, understand and follow instructions and warnings in this manual and on the machine, engine and attachments. Know the controls and the proper use of the machine before starting.

1. Only mature, responsible persons shall operate the machine and only after proper instruction. The operator must possess a valid driver's license.
2. Handle fuel with care. Fuels are flammable and vapors explosive. Use only approved fuel container. DO NOT remove fuel cap or add fuel with the engine running. Add fuel outdoors only with engine stopped and cool. Clean spilled fuel from machine. DO NOT smoke while refueling the machine.
3. Practice operation of machine in a flat open area free from obstacles and hazards. Operate at reduced speed until familiar with the handling of the machine and operation of all controls.



IMPORTANT SAFETY INSTRUCTIONS



PREPARATION (Continued)

4. Be familiar with the area in which the machine will be operated. Inspect area for objects and hazards that could cause loss of control.
5. Keep people and pets clear of machine and work area.
6. Inspect shields, guards, switches, brakes and other safety devices frequently for proper operation and keep them in place.
7. Inspect headlights and repair as required before operating machine. Keep headlight lenses and rear reflectors clean to provide maximum visibility.
8. Make sure all safety signs are clearly legible. Replace if damaged.
9. Protect yourself; dress appropriately for the conditions and the work being performed. Protective equipment, such as helmet, safety glasses or face shield, substantial footwear, long pants, is recommended.
10. Know how to STOP the machine quickly and safely in preparation for emergencies.
11. Use extra care when loading or unloading machine into a truck or trailer.
12. Make sure accelerator, brake, steering, and shift lever function properly before operating machine.
13. Adjust tire inflation pressure to the specifications listed on the machine and in this manual.
14. Inspect condition of tires and replace worn or deteriorated tires before operating machine, using only tires of the same size, type and construction approved by SNAPPER.
15. Obey all local ordinances and laws governing the operation of off-road vehicles. Drive responsibly and respect private property.

SAFE HANDLING OF GASOLINE

To avoid personal injury or property damage, use extreme care in handling gasoline. Gasoline is extremely flammable and the vapors are explosive

1. Extinguish all cigarettes, cigars, pipes and other sources of ignition.
2. Use only an approved fuel container.
3. DO NOT remove fuel cap or add fuel with the engine running. Allow the engine to cool before refueling.
4. DO NOT refuel the machine indoors.
5. DO NOT store the machine or fuel container inside where there is an open flame, spark or pilot light such as on a water heater or other appliances.
6. DO NOT fill fuel containers inside a vehicle or on a truck or trailer bed with a plastic liner. Always place the containers on the ground away from the vehicle before filling.

SAFE HANDLING OF GASOLINE (Continued)

7. Remove gas-powered equipment from the vehicle or trailer and refuel it on the ground. If this is not possible, then refuel equipment using a portable container, rather than a gasoline dispenser nozzle.
8. DO NOT start gas powered equipment in enclosed vehicles or trailers.
9. Keep the nozzle in contact with the rim of the fuel tank or container opening at all times until fueling is complete. DO NOT use a nozzle lock-open device
10. If fuel is spilled on clothing, change clothing immediately.
11. DO NOT overfill a fuel tank. Replace fuel cap and tighten securely.

OPERATION

It is extremely important that the operator of this machine understand that it is not a toy, an ATV or recreation vehicle. Engaging in horseplay, joy riding, racing, jumping, hill climbing and similar activities greatly increases the likelihood of accidents, which may result in damage, serious injury and death.

1. Operator must mount and dismount the machine from the left side. The passenger must mount and dismount the machine from the right side.
2. DO NOT attempt to start engine unless properly seated in the operator's seat.
3. DO NOT leave the machine with the engine running. Stop engine, set park brake, shift to neutral and remove key before leaving the machine for any reason.
4. Operator must be properly seated with the seat belt buckle securely latched and the seat belt adjusted to a snug fit before operating machine.
5. Seating is restricted to only one operator and one passenger. The passenger must be properly seated in the passenger seat with the seat belt buckle securely latched and the seat belt adjusted to a snug fit before starting and operating the machine. DO NOT carry more than one passenger.
6. DO NOT shift transmission when machine is in motion. Machine must be fully stopped before shifting.
7. DO NOT operate machine on or near highways or public roadways. This machine is designed for off-road use only and is not licensed for use on public roads.
8. Keep hands and feet inside machine at all times.
9. DO NOT stand up in machine while machine is in motion.



IMPORTANT SAFETY INSTRUCTIONS



OPERATION (Continued)

10. DO NOT operate machine at speeds in excess of 10 MPH with the differential lock engaged.
11. DO NOT attempt to engage differential lock while machine or wheels are moving. Completely stop machine, before engaging differential lock.
12. DO NOT attempt to turn the machine with the differential lock engaged. To avoid loss of control, slow machine and disengage the differential lock before turning.
13. Reduce speed and use extra caution in unfamiliar areas.
14. Avoid low hanging or protruding objects that may strike the operator, passenger or Operator Protective Structure.
15. Slow machine before turning. Avoid sharp turns.
16. DO NOT park machine on slopes. Avoid uphill starts. DO NOT abruptly change speed or direction on slopes. Avoid turns when descending slopes. Slow down and use extra caution when turning on slopes.
17. Watch out for traffic when near or crossing roadways.
18. DO NOT operate engine in enclosed areas. Engine exhaust gases contain carbon monoxide, a deadly poison.

POWERLINK™ BY BRIGGS & STRATTON

(Not featured on all models)

The POWERLINK™ On-Board Generator System produces electricity that could result in death, serious injury and/or property damage if proper precautions are not followed. A Briggs & Stratton Operating and Safety Instruction manual has been provided with utility vehicles equipped with the POWERLINK™ On-Board Generator System. To avoid serious injury or death, read, understand and follow all warnings and instructions in the manual, on the machine and engine before using the generator system.

ELECTRIC WINCH OPERATION

(Optional accessory on some models)

Every winching operation has the potential for personal injury. The manufacturer of the winch has provided detailed operating and safety instructions that have been included with utility vehicles equipped with a winch. To avoid serious injury or death, read, understand and follow all warnings and instructions in the manual, on the machine and winch before performing a winching operation.

1. Read, understand and follow all warnings and instructions in the winch operator's manual before performing a winching operation.

ELECTRIC WINCH OPERATION

(Continued)

2. The wire rope must be free of tension and the wire rope drum fully stopped before engaging or disengaging the clutch.
3. DO NOT use a recovery strap or other types of stretchable straps in a winching operation.
4. Use the hook strap to hold the hook when spooling wire rope in or out.
5. Always wear heavy leather gloves and do not allow wire rope to slide through your hands.
6. DO NOT allow a helper to operate the winch while you are handling the wire rope or hook.
7. Always keep hands and clothing clear of the wire rope, spool and hook during operation and when spooling.
8. DO NOT leave remove control (optional accessory) plugged into winch while free spooling, rigging, or not in use.
9. DO NOT use the winch as a hoist.
10. DO NOT tow the vehicle using the winch's wire rope.

MAINTENANCE

1. DO NOT store machine or fuel container inside where fumes may reach an open flame, spark, or pilot light such as in a water heater, furnace, clothes dryer or other gas appliance. Allow engine to cool before storing machine in an enclosure. Store fuel container out of reach of children in a well-ventilated, unoccupied building.
2. Keep engine free of grass, leaves, and excess grease and oil to reduce fire hazard and overheating.
3. When draining fuel tank, drain fuel into an approved container outdoors away from open flame.
4. Check brakes each time machine is used; adjust, repair or replace as needed.
5. Condition of tires and tire inflation pressure is critical to the proper handling and braking of the machine. Inspect tires and adjust pressure before operating the machine. DO NOT operate machine with worn or deteriorated tires. Use only tires approved by manufacturer.
6. Keep all bolts, nuts, and screws properly tightened.
7. Always provide adequate ventilation when running engine. Engine exhaust gases contain carbon monoxide, an odorless and deadly poison.
8. Disconnect negative (black) cable from battery before performing maintenance or service. Unexpected cranking of engine could cause injury.
9. DO NOT work under machine without safety blocks.



IMPORTANT SAFETY INSTRUCTIONS



MAINTENANCE (Continued)

10. When working on machine with cargo bed raised, make sure that prop rod support is securely latched.
11. Service engine and make adjustments only when engine is stopped. Remove spark plug wires and secure away from spark plugs.
12. DO NOT check for spark by grounding plug near sparkplug opening. The spark could ignite the gas exiting the engine.
13. DO NOT change engine governor speed settings or over speed engine.
14. DO NOT modify machine. Use only genuine replacement parts to assure that original standards and performance are maintained.
15. Have machine serviced by an authorized SNAPPER dealer at least once a year and have dealer install any new safety devices.
16. POWERLINK™ On-Board Generator System must be serviced by an authorized Service Dealer. DO NOT tamper with or modify the generator system in any way.

TABLE OF CONTENTS

IMPORTANT SAFETY INSTRUCTIONS	2-6
TABLE OF CONTENTS	7
SECTION 1 –	
FAMILIARIZATION	8-9
CONTROL IDENTIFICATION & SAFETY SIGNS	10-12
SECTION 2 - OPERATING INSTRUCTIONS	13-21
Pre-Start Check List.....	13-14
Controls – Function & Operation	14-16
Starting & Stopping Engine	17
Starting & Stopping Machine Motion	17
Parking Machine.....	18
Using Differential Lock.....	18
Driving the Machine.....	18-19
Carrying Loads.....	19
Towing.....	19-20
Transporting Machine	20
Water Crossing.....	20
Operating POWERLINK™ Onboard Generator	20-21
SECTION 3 – MAINTENANCE	22-25
Introduction	22
Service – After First 5 Hours.....	22-24
Change Engine Oil.....	22
Engine Air Cleaner.....	22-23
Check Transmission Fluid	23
Check Tire Pressure	23
Lubrication – Axle Couplings and Steering King Pins	23
Check Wheel Lug Nuts	23
Check Brakes	23
Check Interlocks	24
Service – Every 25 Operating Hours	24
Check Battery.....	24
Check Drive Belt	24
Engine Service	24
Service – Every 50 Operating Hours.....	24-25
Check Wear Pads on Driven Clutch.....	24
Check Drive Clutch.....	25
Change Engine Oil.....	25
Service – Every 100 Operating Hours	25
Change Engine Oil Filter	25
Service – Every 200 Operating Hours (or Yearly)	25
Change Transmission Fluid.....	25
Replace Fuel Filter	25
Storage – Out of Season	25
SECTION 4 – ADJUSTMENTS & REPAIRS	26-29
Drive Belt Replacement.....	26
Service Brake & Park Brake Adjustment	26-27
Battery Removal.....	27
Battery Installation.....	28
Battery Charging	28
Battery Storage	28
Battery Testing.....	28
Cargo Bed Latch Striker Adjustment.....	28
Transmission Shift Rod Adjustment.....	29
SECTION 5 – ELECTRICAL.....	30-31
Wiring Schematic	30
Wire Harness Detail	31
TROUBLESHOOTING	32
MAINTENANCE SCHEDULE	33
WARRANTY & PRODUCT REGISTRATION FORM	34-35

SECTION 1 – FAMILIARIZATION

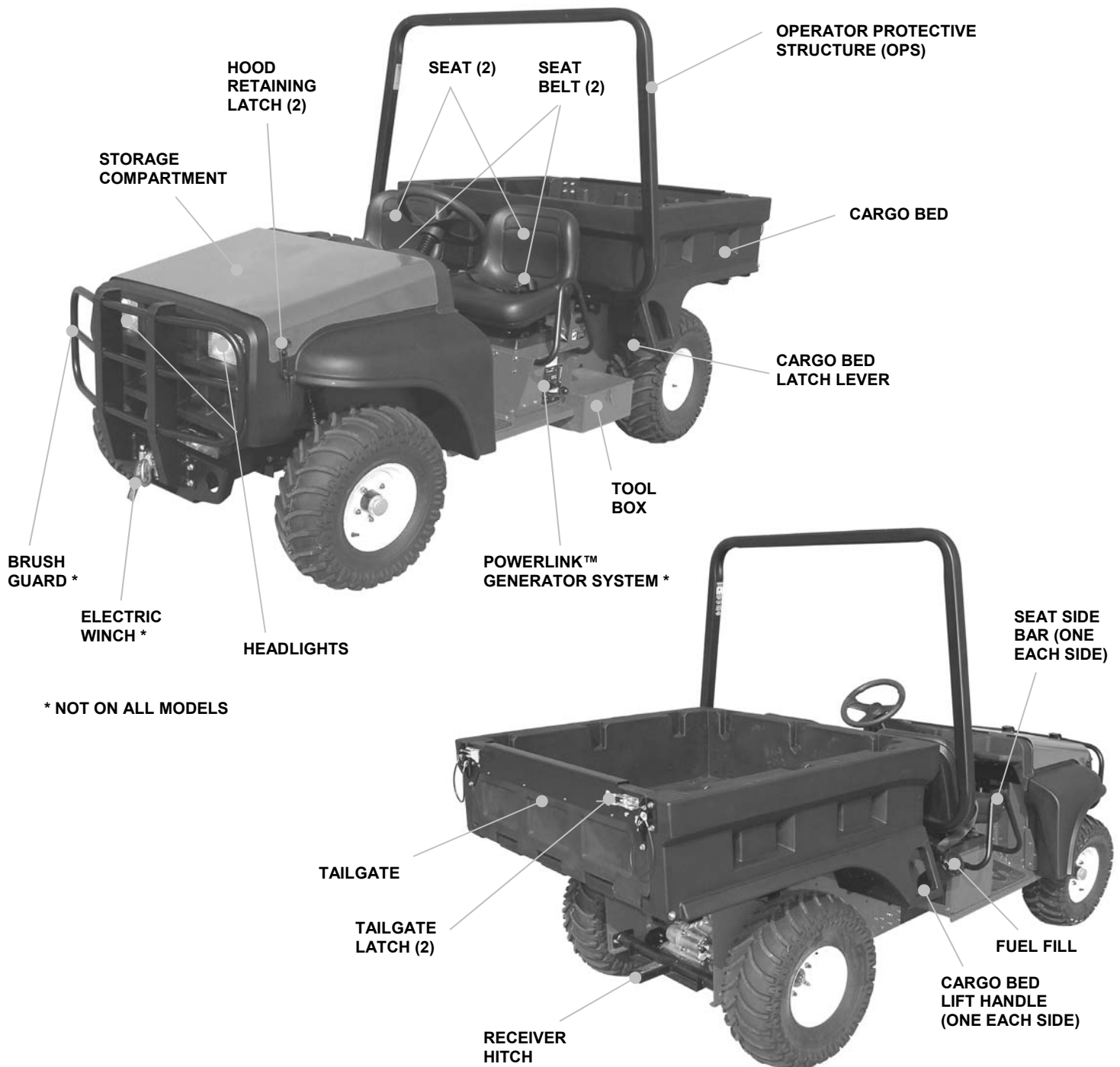

1.1 INTRODUCTION

This manual has been prepared for the operators of Turf Cruiser™ & Trail Cruiser™ utility vehicles. Its purpose, aside from recommending standard operating procedures and routine service requirements, is to promote SAFETY through the use of accepted operating practices. **Read, Understand and Follow** the IMPORTANT SAFETY INSTRUCTIONS on Pages 2 thru 6 of this manual and **All SAFETY** messages on the utility vehicle and its accessories before operating.

1.2 NOMENCLATURE

The nomenclature information above shows the essential parts of the vehicle. It is recommended that all operators of this equipment become thoroughly familiar with the controls, components, and operation of this machine before operating. Specific details involving the engine are found in the separate engine owner's manual. Study these manuals before operating and keep both handy for future reference.

SECTION 1 – FAMILIARIZATION

DASHBOARD / PEDAL CLUSTER

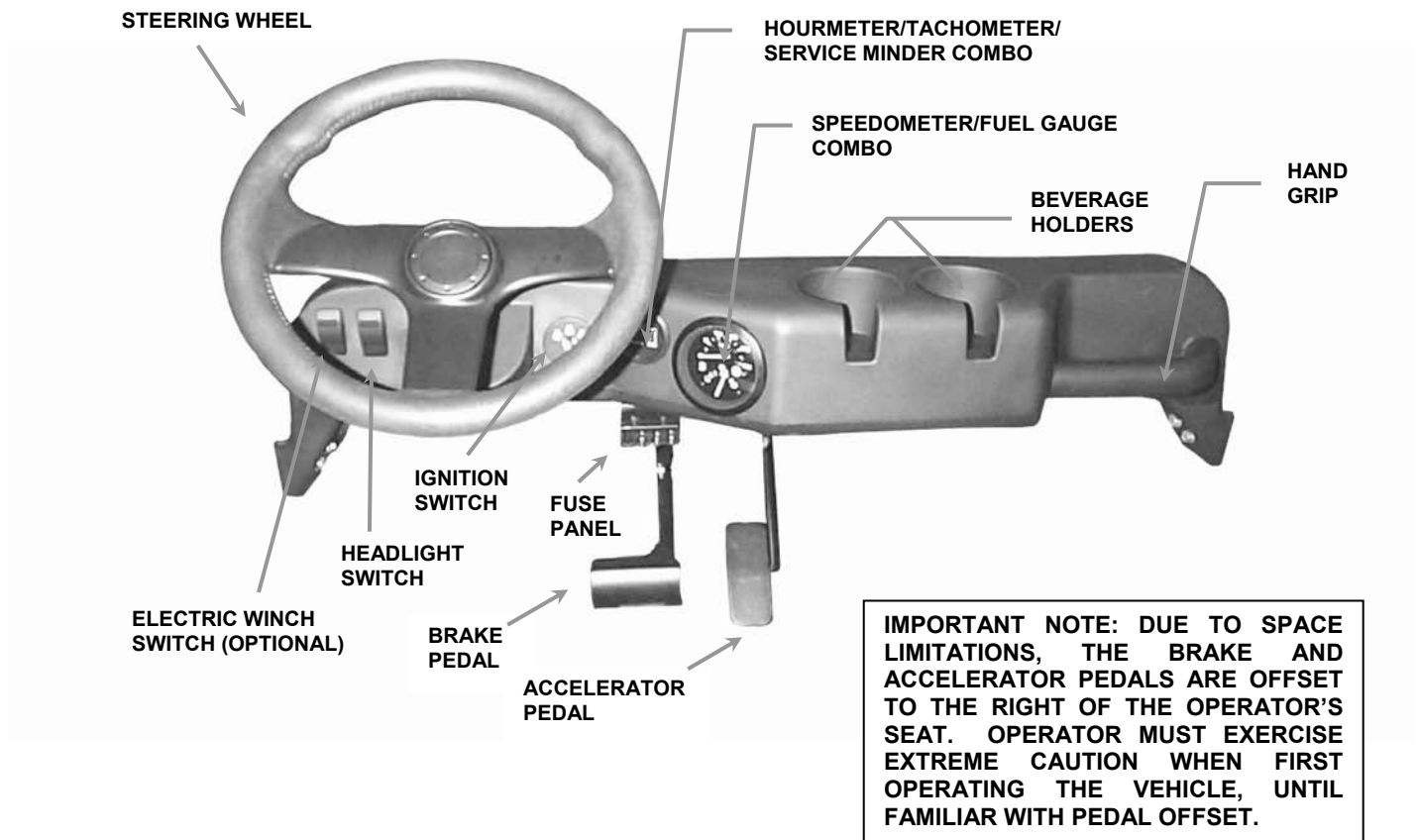

CONTROL CONSOLE

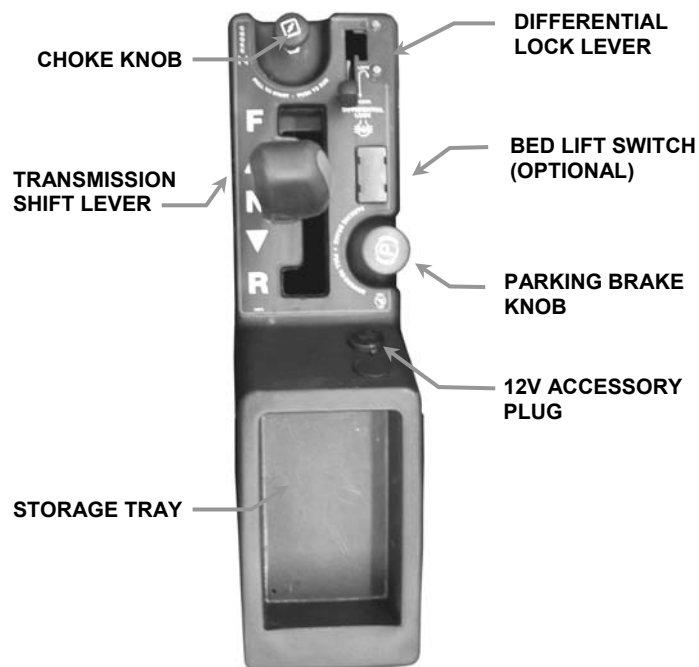

CONTROL IDENTIFICATION & SAFETY SIGNS

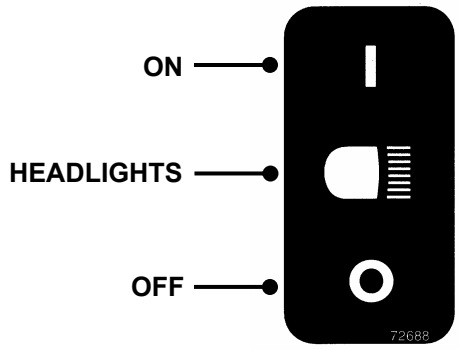

HEADLIGHT SWITCH

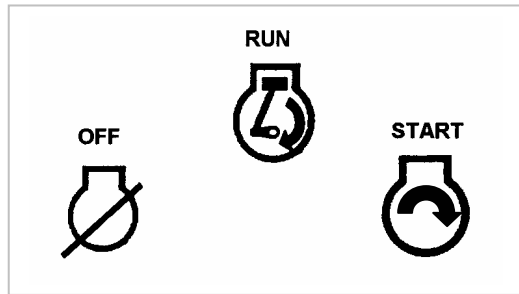

IGNITION SWITCH

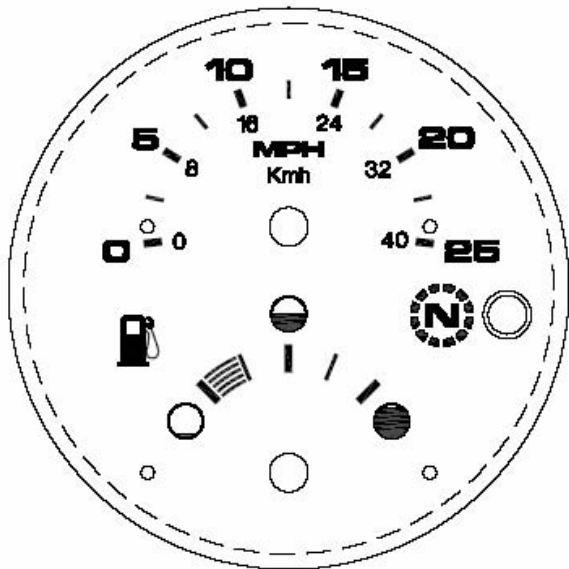

SPEEDOMETER/FUEL GAUGE COMBO

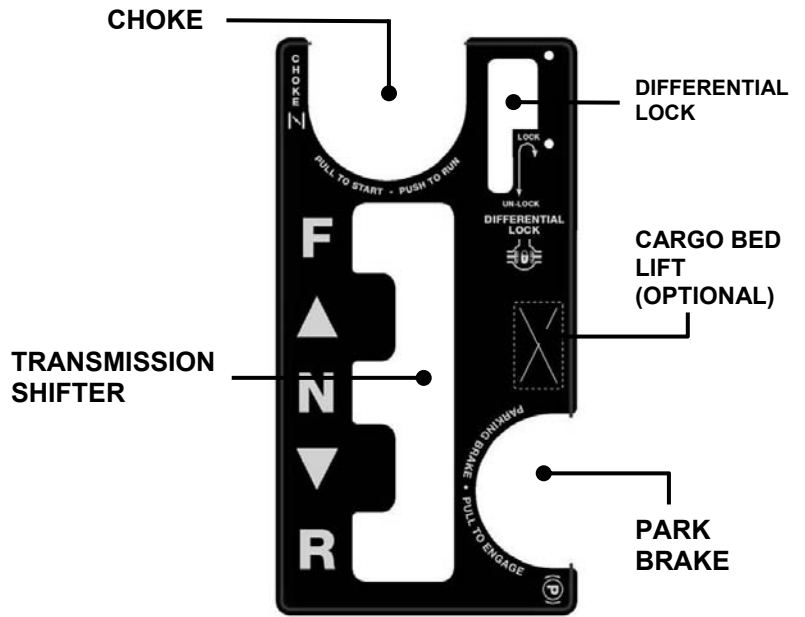

CONSOLE CONTROLS



DANGER – OPERATOR PROTECTIVE STRUCTURE

CONTROL IDENTIFICATION & SAFETY SIGNS



WARNING – NO RIDERS



WARNING - TO PREVENT FIRE



WARNING – OFF ROAD USE ONLY



WARNING – HOT SURFACE



WARNING – HITCH & TOWING



SPECIFICATIONS & MAINTENANCE

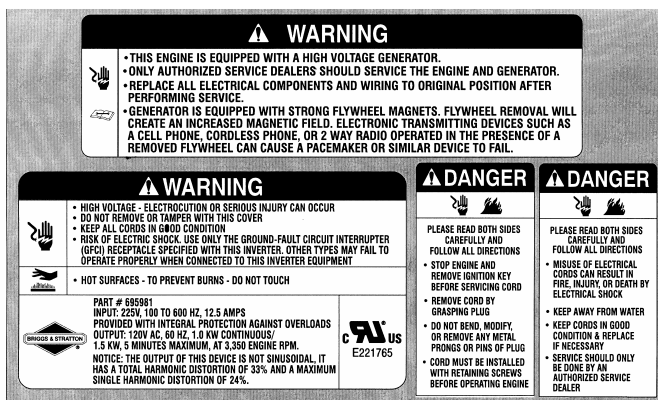

POWERLINK™ WARNINGS



WARNING – CARGO BED & LOADS

• DO NOT OPERATE MACHINE WITH CARGO BED RAISED.
• DO NOT RAISE CARGO BED WHEN LOADED OR ON SLOPES.

• ALL LOADS MUST BE CENTERED NO HIGHER THAN SIDES OF CARGO BED AND SECURED TO PREVENT SHIFTING.

CONTROL IDENTIFICATION & SAFETY SIGNS

WARNING AVOID SERIOUS INJURY OR DEATH

- OPERATOR MUST BE ADULT OR RESPONSIBLE TEENAGER AT LEAST 16 YEARS OLD AND POSSESS A VALID DRIVERS LICENSE.

- READ ALL MANUALS AND FOLLOW INSTRUCTIONS BEFORE OPERATING VEHICLE.

- MAXIMUM; ONE OPERATOR AND ONE PASSENGER (400 LBS TOTAL). BOTH MUST BE SEATED IN SEATS PROVIDED, WITH SEAT BELT LATCHED AND ADJUSTED TO A SNUG FIT.

WARNING
AVOID SERIOUS INJURY OR DEATH

- READ ALL MANUALS AND FOLLOW INSTRUCTIONS BEFORE OPERATING VEHICLE.
- OPERATOR MUST BE ADULT OR RESPONSIBLE TEENAGER AT LEAST 16 YEARS OLD AND POSSESS A VALID DRIVERS LICENSE.
- MAXIMUM; ONE OPERATOR AND ONE PASSENGER (400 LBS TOTAL). BOTH MUST BE SEATED IN SEATS PROVIDED, WITH SEAT BELT LATCHED AND ADJUSTED TO A SNUG FIT.
- DO NOT CARRY CHILDREN OR OTHERS IN CARGO BED, ON HOOD, ATTACHMENTS OR TOWED EQUIPMENT.
- KEEP CHILDREN OUT OF WORK AREA AND AWAY FROM THE MACHINE.
- BEFORE BACKING: STOP MACHINE COMPLETELY; LOOK AND SEE BEHIND AND DOWN FOR CHILDREN, PETS AND HAZARDS BEFORE AND WHILE BACKING.
- ON ALL SLOPES: EXERCISE CAUTION, REDUCE SPEED, AVOID SHARP TURNS, AVOID SUDDEN STARTS, DO NOT RAISE CARGO BED. REDUCE LOADS ON SLOPES.
- DO NOT OPERATE MACHINE ACROSS FACE OF SLOPES.
- DO NOT OPERATE ON SLOPES IN EXCESS OF 15° (27% GRADE).
- DO NOT HAUL OR TOW LOADS ON SLOPES IN EXCESS OF 10° (18% GRADE). DO NOT TOW A LOAD YOU CANNOT SAFELY CONTROL.
- DO NOT OVERLOAD OR EXCEED RATED CAPACITY OF MACHINE.

73472

NO RIDERS

15° MAX.

UNDER 16

- ON ALL SLOPES: EXERCISE CAUTION, REDUCE SPEED, AVOID SHARP TURNS, AVOID SUDDEN STARTS, DO NOT RAISE CARGO BED. REDUCE LOADS ON SLOPES.
- DO NOT OPERATE MACHINE ACROSS FACE OF SLOPES.
- DO NOT OPERATE ON SLOPES IN EXCESS OF 15° (27% GRADE).
- DO NOT HAUL OR TOW LOADS ON SLOPES IN EXCESS OF 10° (18% GRADE). DO NOT TOW A LOAD YOU CANNOT SAFELY CONTROL.
- DO NOT OVERLOAD OR EXCEED RATED CAPACITY OF MACHINE.

- MAXIMUM; ONE OPERATOR AND ONE PASSENGER (400 LBS TOTAL). BOTH MUST BE SEATED IN SEATS PROVIDED, WITH SEAT BELT LATCHED AND ADJUSTED TO A SNUG FIT.
- DO NOT CARRY CHILDREN OR OTHERS IN CARGO BED, ON HOOD, ATTACHMENTS OR TOWED EQUIPMENT.

- KEEP CHILDREN OUT OF WORK AREA AND AWAY FROM THE MACHINE.
- BEFORE BACKING: STOP MACHINE COMPLETELY; LOOK AND SEE BEHIND AND DOWN FOR CHILDREN, PETS AND HAZARDS BEFORE AND WHILE BACKING.

SECTION 2 – OPERATING INSTRUCTIONS

2.1 PRE-START CHECK LIST

Make the following checks and perform all service as required before starting and operating the machine.

2.1.1. Read Manuals. Read, understand, and follow instructions and warnings in this manual and all other supplied manuals, as well as instructions and warnings on the machine, engine and attachments. Know the controls and the proper use of the machine before starting.

2.1.2. Perform General Inspection. Thoroughly inspect the entire machine for damage, wear, and loose and missing hardware. Repair or replace damaged, worn, loose and missing components prior to starting and operating machine.

2.1.3. Check Tires. Check and adjust tire pressure to 15 psi. front and rear. Inspect condition of tires for wear, deterioration, cuts, and damage. Replace worn, damaged or deteriorated tires before operating machine, using only tires of original size, type and construction.

2.1.4. Check Accelerator Pedal. With engine off, depress pedal fully. The pedal must move freely, and immediately return to original position when released.

2.1.5. Check Engine oil and Transmission fluid. Raise empty cargo bed and carefully secure with prop rod. Add oil as needed to bring engine to FULL mark on dipstick. See Figure 2.1. Refer to Engine Owner's manual for engine oil specifications. Add fluid as needed to bring transmission to FULL mark on dipstick. See Figure 2.1. Use MOBILFLUID 424 or equivalent. IMPORTANT! Do Not overfill. Always fully thread dip stick when checking transmission fluid levels.

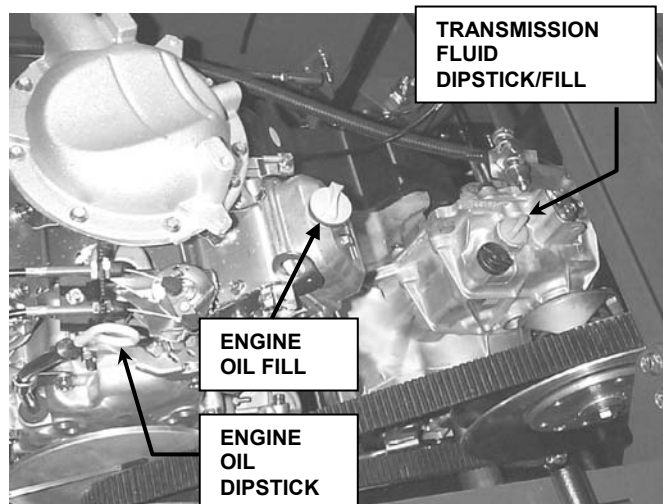

FIGURE 2.1

2.1.6. Add Fuel to tank. (Refer to Engine Owner's manual for fuel specifications.) Make sure fuel filler cap is tight after fueling. IMPORTANT NOTE: Always fuel machine out of doors, where fumes can safely dissipate. Do not smoke while fueling.

2.1.7. Check Steering for excessive play. Do not operate machine if steering is loose or sloppy.

2.1.8. Check Headlights. Both headlights should be functional before operating machine. Headlight lenses and rear reflectors must be clean. (NOTE: Ignition must be set to 'Run' position for headlights to function.)

2.1.9. Check Engine and surrounding areas for buildup of dirt, debris, oil, grease, etc.

IMPORTANT! ENGINE AND SURROUNDING AREAS MUST BE KEPT CLEAN. Debris buildup can cause engine overheating, severe damage, and fire.

2.1.10. Adjust Operator's Seat. With engine stopped, and park brake set, loosen two seat adjusting knobs and move seat to desired position. Re-tighten both knobs securely. See Figure 2.2.

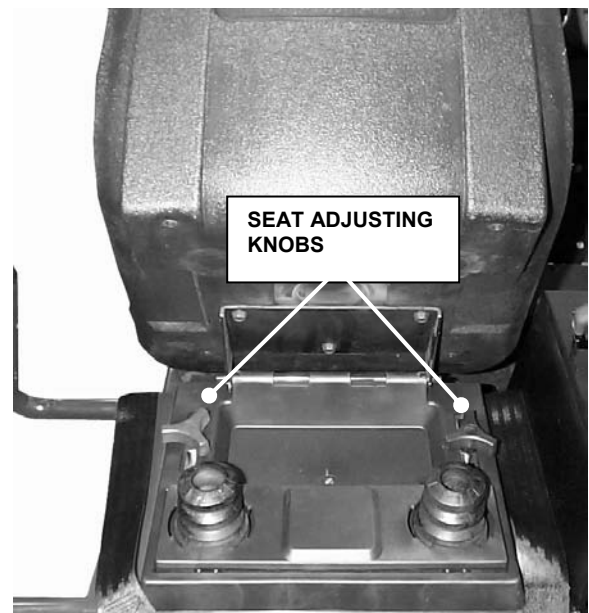

FIGURE 2.2

2.1.11. Check Seat Belts. Mounting hardware must be tight. Buckle must latch securely. Webbing must not display signs of deterioration, wear, or damage.

2.1.12. Check Operator Protective Structure (OPS). Check OPS for structural soundness (i.e. cracks, damage, etc.) All OPS mounting hardware must be tight. DO NOT operate a machine that has had the OPS removed, damaged, or modified in any way.

SECTION 2 – OPERATING INSTRUCTIONS

2.1.13. Check Cargo Bed. Cargo bed must be lowered and securely latched. Tailgate should be closed and latched. Tailgate support cables must be installed and secured.

2.1.14. Check Safety Interlocks for proper function:

1. Engine must not crank unless Transmission is in Neutral and Brake is fully depressed.
2. Engine must begin to die if operator leaves seat without setting parking brake and shifting Transmission into Neutral.
- 3*. Engine must begin to die if Powerlink™ Generator speed control is engaged without setting parking brake and shifting Transmission into Neutral. (* Equipped models only)

DO NOT operate machine unless all safety interlocks are functioning properly.

2.1.15. Check Parking Brake. Parking Brake must hold when engaged. Refer to Section 2.2.2 – Controls – Function and Operation, Park Brake. DO NOT operate machine if brake is not adjusted and functioning properly; refer to Section 4.2 – “Adjustment and Repairs, Service Brake and Park Brake Adjustment”.

2.2 CONTROLS – FUNCTION AND OPERATION

2.2.1. Service Brake. Depress Brake Pedal to slow or stop machine. Apply a steady firm force to the pedal. Avoid sudden stops. Always release Accelerator Pedal before applying brake. Allow extra stopping distance when traveling down slopes, carrying loads or towing. Apply brake when traveling down slopes to maintain safe speed. To avoid skidding and loss of control, do not operate machine on loose or slippery surfaces or where traction is doubtful.

2.2.2. Park Brake. To engage or set the park brake:

- 1) Pull park brake knob up and hold. See Figure 2.3.
 - 2) Depress Brake Pedal firmly. There will be a clicking sound as the pedal is depressed indicating that the brake has engaged the lock mechanism. Two clicks should be sufficient to hold the machine.
- To disengage or release the park brake:
- 1) Depress brake pedal firmly while pushing park brake knob down. See Figure 2.3.
 - 2) Release pedal.



FIGURE 2.3

2.2.3. Transmission Shift Lever. The shift lever has three positions. It controls the direction of travel only (not speed). Move the shift lever to the front slot for forward (F). Move the shift lever to the back slot for reverse (R). Place the shift lever in the center slot for neutral (N). See Figure 2.4. The shift lever must be placed in neutral (and the brake pedal fully depressed) for the engine to crank and start. The machine must be at a complete stop and the engine at idle before shifting. Do not race engine and then shift into gear. Move the shift lever with a quick and positive motion to avoid grinding gears.

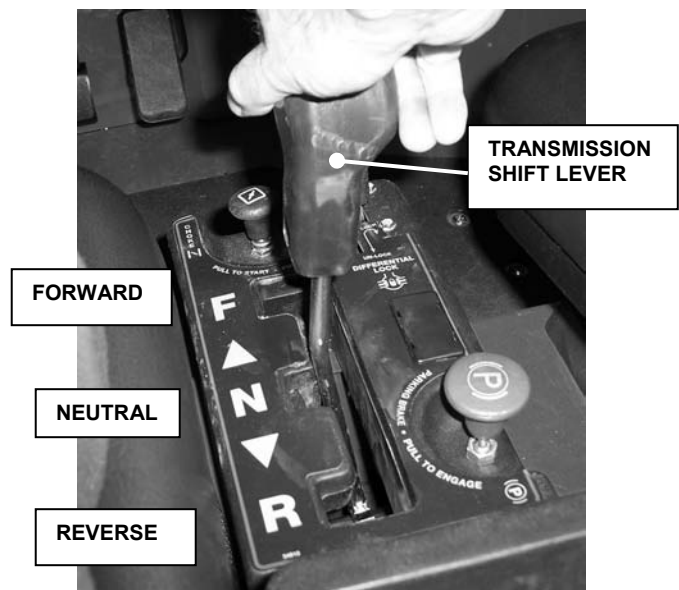

FIGURE 2.4

WARNING
DO NOT park machine on slopes. DO NOT leave machine with engine running. Stop machine. Stop engine. Set park brake. Shift transmission to neutral and remove key before leaving the machine for any reason.

WARNING
DO NOT attempt to shift gears with machine in motion. Bring machine to a complete stop before shifting. DO NOT shift gears until engine has returned to idle speed. DO NOT race engine and shift gears.

SECTION 2 – OPERATING INSTRUCTIONS

2.2 CONTROLS – FUNCTION AND OPERATION (Continued from previous page)

2.2.4. Differential Lock. The differential lock increases traction by causing both rear wheels to pull evenly. Move the lever towards the front of the slot and latch to “Lock” the differential. (See Figure 2.4a.) Unlatch the lever and move to the back of the slot to “Unlock” the differential. Do not attempt to lock the differential until all wheel rotation has stopped. Do Not operate the machine in excess of 10 mph or attempt to turn the machine with the differential locked. Always unlock the differential when increased traction is no longer needed.

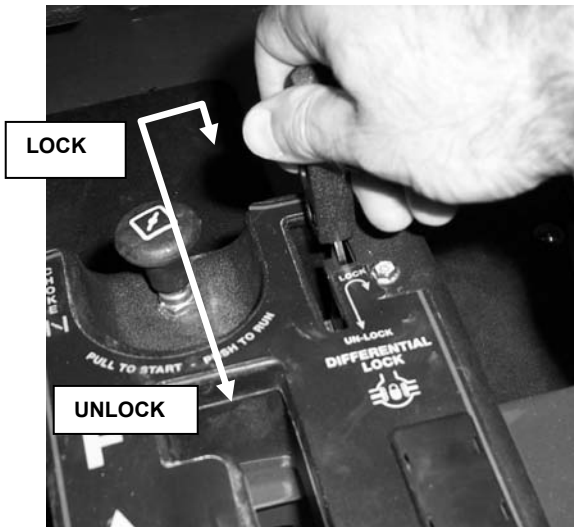

FIGURE 2.4a

WARNING
DO NOT engage the differential lock with the machine in motion or the rear wheels rotating. Operate the machine with the differential locked only at slow speeds, in a straight line and only when increased traction is needed.

2.2.5. Accelerator Pedal. The accelerator pedal controls the engine speed and the ground speed of the machine. Depressing the pedal will increase engine speed and cause the clutch to engage. The machine will move in the direction selected with the shift lever. The accelerator is also used to raise the engine speed, with transmission in neutral, when warming a cold engine. Always apply pressure to the accelerator slowly and with caution. Do Not accelerate suddenly and avoid sudden changes in speed. Release accelerator before applying brake. Reduce speed before turning. Refer to page 9 “Brake Pedal & Accelerator Pedal”.

WARNING
DO NOT operate machine if accelerator pedal movement is sticky or sluggish. Engine must immediately return to idle speed when pedal is released.

2.2.6. Choke. The choke control is used to help start a cold engine. Pull choke knob up to apply (‘turn on’) choke. Push knob down to open (‘turn off’) choke. Do not operate the engine with the choke on. (NOTE: After starting a cold engine, the choke may be partially applied to assist running during the warm up period.) Refer to page 9 “Control Console”.

2.2.7. Seat Belt. A lap-style seat belt is provided for the comfort and safety of the operator and one passenger. Safe operation of the machine limits the number of occupants to two. Both must be seated in the seats provided with the seat belts buckled securely and adjusted to a snug fit. To buckle the seat belt, insert the latch plate fully into the latch. Check to make sure that the belt is securely latched. Always adjust the seat belt to a snug fit.

WARNING
DO NOT operate machine until operator and one passenger are properly seated, with seat belts securely latched and adjusted to a snug fit. Lap style seat belts may not provide adequate protection for small children. Carrying infants or toddlers is not recommended.

2.2.8. 12 Volt DC Accessory Plug. The 12-volt accessory plug, located behind the parking brake knob on the control console, accepts cigarette lighter type power adapters and can be used to power small electronic devices. The ignition must be set to the “RUN” position for the accessory plug to function. NOTE: Operating a 12-volt accessory, especially with the engine at idle, may cause battery to discharge. NOTE: When not using accessory plug, be sure to replace rubber cover. Entrance of water into plug can cause short circuit.

WARNING
DO NOT exceed rated capacity of the 12 Volt accessory plug. Replace fuses using same type and rating only.

SECTION 2 – OPERATING INSTRUCTIONS

2.2 CONTROLS – FUNCTION AND OPERATION (Continued from previous page)

2.2.9. Headlights. The headlights are controlled by a rocker switch, located on the dash to the immediate left of the steering wheel. See Figure 2.5. Push the switch up to turn the headlights on. Push the switch down to turn the headlights off. Note: The engine ignition switch must be in the “RUN” position for the headlights to operate. Repair non-functional headlights before operating machine and keep lenses clean.

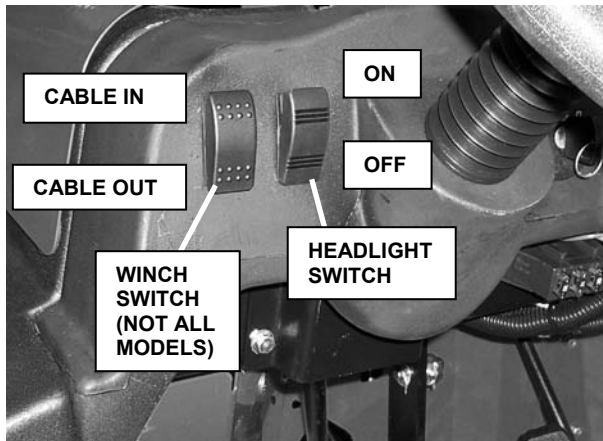

FIGURE 2.5

2.2.10. Ignition Switch. The ignition switch has three positions – Stop, Run, and Start. See Figure 2.6. Turn key and hold momentarily at “Start” position to crank the engine. After starting, release key to “Run” position. Turn key to “Stop” position to stop engine. Turning the key to the “Run” position will enable use of the headlights and the 12 volt accessory plug. However, when using the headlights or accessory plug, the engine should be running to prevent discharging the battery.

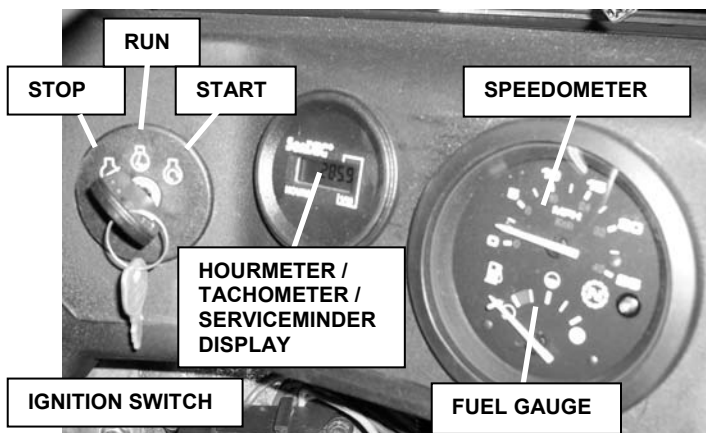

FIGURE 2.6

2.2.11. Speedometer/Fuel Gauge Combo. Both functions are contained within the one dial. See Figure 2.6. Speedometer measures ground speed of unit. Fuel gauge indicates amount of fuel in tank.

2.2.12. Hourmeter/Tachometer/ServiceMinder Combo. See Figure 2.6. With ignition off, LCD readout displays hours engine used. With engine started, readout displays RPM's. After first seven (7) hours of use, and every forty-nine (49) hours thereafter, the ServiceMinder displays a message indicating oil change is required. The message will be displayed for two (2) hours, and will continue even if oil is changed within the two hour period. After two hours, *whether oil is changed or not*, display will revert back to hourmeter/tachometer function.

2.2.13. Cargo Bed. The manual lift * cargo bed is secured in the lowered position by two spring latches located on either side of the machine. Pull outward on the latch lever (located behind the left cargo bed lift handle) to release the bed, and lift via the handle. Use the prop rod to secure the bed in the fully raised position. (NOTE: make sure slot in bottom of prop rod fully drops onto catch bolt in machine frame; failure to do so can result in serious injury.) The tailgate can be opened by flipping open the two tailgate latches located on either side of the tailgate and dropping gate down.

* An electrically operated bed lift kit is available. Contact dealer for details.

2.2.14. Powerlink™ Generator System (not on all models). See Pages 18-19 for details on the Powerlink generator.

2.2.15. Warn™ Electric Winch (not on all models). The winch switch is located on the dashboard next to the headlight switch, to the left of the steering wheel. Pushing the switch down lets cable out; pushing the switch up pulls cable in. See Figure 2.5. Refer to manuals supplied with literature package for comprehensive instructions on safe use and maintenance of electric winch.

WARNING

The winch switch on the utility vehicle does not automatically cut out when cable is fully retracted. To avoid damage to winch and/or vehicle, inspect cable regularly while retracting.

SECTION 2 – OPERATING INSTRUCTIONS

2.3 STARTING AND STOPPING ENGINE

Before attempting to start and operate machine, perform all steps in the Pre-Start Check List

2.3.1. Starting Engine

- A. Sit in operator's seat and latch seat belt. Adjust seat belt to a snug fit. If carrying a passenger, the one passenger must also be seated with seat belt securely latched and adjusted to a snug fit before starting engine.
- B. Set park brake.
- C. Shift transmission to neutral.
- D. Make sure POWERLINK™ generator speed control lever is set all the way down to 'SLOW' (equipped models only).
- E. Move choke control lever to the "ON" position to start a cold engine.
- F. Push accelerator pedal down approximately 1/3 of travel.
- G. Turn ignition key to "START" position and hold until engine starts. If after 5 to 10 seconds of cranking the engine has not started, release key and wait 20 seconds before attempting to crank the engine again.
- H. After engine starts, move the choke control to the "OFF" position. Partial choke may be required to keep the engine running smoothly during the initial warm up period.
- I. Allow 2 minutes for the engine to warm up. Make sure choke is in "OFF" position after engine has warmed.
- J. Release accelerator pedal. Engine should idle. If engine dies, additional warm up time may be required.

2.3.2. Stopping Engine

- A. Release accelerator pedal and allow engine to return to idle. Do not immediately stop a hot engine. Allow engine to idle several minutes to cool off before stopping.
- B. Set park brake
- C. Shift the transmission to Neutral.
- D. Turn key to Stop and remove key.

2.4 STARTING AND STOPPING MACHINE MOTION

IMPORTANT! – MACHINE MUST BE FULLY STOPPED AND THE ENGINE AT IDLE SPEED BEFORE SHIFTING GEARS. ALWAYS MOVE THE SHIFT LEVER WITH A QUICK AND POSITIVE MOTION TO AVOID GRINDING GEAR.

2.4.1. Starting Motion - Forward

- A. Complete pre-start checklist.
- B. Operator must be seated with seat belt securely latched and adjusted to a snug fit.
- C. Park brake must be set and the transmission in Neutral.

D. POWERLINK™ generator speed control lever must be set all the way down to 'SLOW' (equipped models only).

E. Start engine and allow 2 minute warm up period.

F. Shift transmission to Forward. ENGINE MUST BE AT IDLE SPEED.

G. Release park brake.

H. Move accelerator pedal slowly and with caution. Allow machine to accelerate to desired speed.

2.4.2. Starting Motion - Reverse



A. Complete pre-start checklist.

B. Operator must be seated with seat belt securely latched and adjusted to a snug fit.

C. Park brake must be set and the transmission in Neutral.

D. POWERLINK™ generator speed control lever must be set all the way down to 'SLOW' (equipped models only).

E. Start engine and allow 2 minute warm up period.

F. Shift transmission to Reverse. ENGINE MUST BE AT IDLE SPEED.

G. Release park brake.

H. Back slowly. Move accelerator pedal slowly and with caution. Do not back at high speeds and avoid sudden or sharp turns while backing.

I. When changing directions from Forward to Reverse bring machine to a complete stop first. Release accelerator pedal and apply brake.

J. Shift transmission to Reverse. Release brake pedal and back slowly.

2.4.3. Stopping Motion

A. Release accelerator pedal

B. Apply a firm steady pressure to brake pedal, bringing machine to a controlled stop.

C. Set park brake.

D. Shift transmission to Neutral.

E. Stop engine.

F. Remove key.

SECTION 2 – OPERATING INSTRUCTIONS

2.5 PARKING MACHINE

The park brake has a ratcheting lock mechanism. When setting the brake a clicking sound will be heard as the mechanism engages and locks the brake. To set and hold the machine properly, two or more clicks may be required. Always park the machine on a flat surface. Inspect brakes for proper operation before each use. Refer to Maintenance section of this manual for inspection and adjustment procedures.



- F. When increased traction is no longer needed the differential must be unlocked. Move differential lock lever to the “Unlocked” position.
- G. Resume normal machine operation.

2.7 DRIVING THE MACHINE

IMPORTANT! OPERATOR MUST BE 16 YEARS OLD OR OLDER AND POSSESS A VALID DRIVER’S LICENSE

2.7.1. Before operating machine, read understand and follow all instructions and warnings in this manual and on the machine, engine and attachments. Careless, reckless operation can cause accidents resulting in damage and injury. It is extremely important that the operator of this machine understand that it is not a toy. Engaging in horseplay, joy riding, racing, jumping, hill climbing and similar activities greatly increases the likelihood of accidents, which may result in damage, serious injury or death. Operating machine on slopes, carrying loads and towing require extra caution.

2.7.2. The machine is equipped with a Continuously Variable Torque drive train. No manual up shifting or down shifting of gears is required. The transmission automatically up-shifts and down-shifts to match operating speed and load conditions. Depressing the accelerator pedal increases engine speed and causes the clutch to engage and the machine to move in the direction selected with the transmission shift lever.



 **WARNING** 

DO NOT park machine on slopes. DO NOT leave machine with engine running. Stop machine. Stop engine. Set park brake. Shift transmission to Neutral and remove key before leaving the machine for any reason.

- A. Bring machine to a complete stop on a flat surface.
- B. Pull the park brake knob up to engage parking brake.
- C. Depress brake pedal firmly. (2 or more clicks.)
- D. Stop engine.
- E. Shift transmission to Neutral.
- F. Remove key.

2.6 USING DIFFERENTIAL LOCK

The differential lock is only used when increased traction is needed. Locking the differential causes both rear wheels to turn equally, improving traction. The differential lock should not be used at speeds in excess of 10 mph. The differential will remain locked as long as the control is in the “locked” position. Be sure to “Unlock” the differential when increased traction is no longer needed. Do not attempt to turn machine with the differential locked. The machine and wheels must be fully stopped before locking differential.

 **WARNING** 

DO NOT lock differential until machine and rear wheel motion has stopped. DO NOT operate machine at speeds in excess of 10 mph with the differential locked. DO NOT turn machine with differential locked. Unlock differential when increased traction is not required.

- A. Bring machine and wheels to a complete stop. **IMPORTANT!** All motion must be stopped before attempting to lock the differential.
- B. Move the differential lock lever to the front of the slot and latch in the “Locked” position.
- C. Shift transmission to desired direction.
- D. Move accelerator pedal slowly. The differential will lock when the rear wheels turn at slightly different speeds.
- E. Drive the machine only in a straight line and at a slow speed.

SECTION 2 – OPERATING INSTRUCTIONS

2.7.3. General Operating Procedures

- A.** Always complete the Pre-Start Checklist before starting or operating the machine.
- B.** Learn location and function of all controls before starting and operating machine.
- C.** Do not start or operate the machine until seated with seat belt securely latched and adjusted to a snug fit. The machine is equipped with an Operator Protective Structure. This structure can protect the operator and one passenger against injury from a tip-over accident if used properly. Both must be seated in the seats provided with the seat belts securely latched and adjusted to a snug fit. Seat belts that are not latched or are not adjusted to a snug fit will not provide protection.
- D.** Operate the machine at a safe speed. Reduce speed when hauling loads, towing, on slopes and on rough or loose surfaces. The operator must exercise sound judgment and adjust the speed of the machine based on operating conditions. Driving too fast for conditions can cause loss of control, accidents, injury or death.
- E.** Do Not overload the machine. On level surfaces, the maximum capacity of the cargo bed is 500 lb (227 kg). Reduce load when operating on slopes. Limit loads to those you can safely control. Maximum capacity, including two occupants, 900 lb (408 kg).
- F.** Maximum occupants 2: one operator and one passenger, 400 lb. (181 kg.) maximum. Both must be properly seated in the seats provided, with seat belts securely latched and adjusted to a snug fit.
- G.** Do Not carry children or others in the cargo bed.
- H.** Do not operate machine across face of slopes. Operate up and down.
- I.** Do Not shift to neutral and coast down slopes. When descending a slope apply brake to maintain a safe speed. Avoid turning when descending a slope.
- J.** Reduce speed before turning. Avoid turning on slopes.
- K.** Always lower the cargo bed and latch securely before operating machine.
- L.** Before leaving the machine, Stop engine. Set the park brake. Shift transmission to neutral and remove key.
- M.** Do Not park the machine on slopes. Starting and turning on slopes is not recommended. Parking on flat surface eliminates the need to perform these maneuvers on slopes.
- N.** Avoid sudden starts, stops and turns.
- O.** Apply brakes with a firm steady force. Avoid sudden stops and skidding tires.
- P.** The use of a helmet, face shield or safety glasses and substantial clothing is recommended.
- Q.** Be familiar with the area that the machine is operated in. Stay alert for holes and hidden hazards.

2.8 CARRYING LOADS

Carrying loads affects the handling, stability and braking of the machine. Improper loads, shifting loads, excessive speed, sharp turns, rough ground, loose or slippery surfaces and slopes can cause loss of control, sliding and/or tip-over accidents resulting in damage, serious injury or death.

- A.** Do Not exceed the maximum capacity of the machine. The maximum cargo bed capacity on smooth level surface is 500 lb (227 kg). Reduce load on rough ground and slopes.
- B.** Loads must be centered in the cargo bed and secured to prevent shifting. Off center loads and shifting loads can cause tipping and serious injury or death.
- C.** Loads must not be stacked higher than the sides of the cargo bed.
- D.** Always distribute loads evenly in the cargo bed and keep loads as low as possible to minimize effect on stability.
- E.** Reduce speed when carrying loads and allow extra distance for stopping.
- F.** Do Not operate on slopes in excess of 10 degrees (18% grade) when carrying loads.
- G.** Tires must be properly inflated (15 psi. front and rear) before carrying a load. Improperly inflated tires affect handling, stability and braking of the machine.
- H.** Do Not attempt to dump loads from the cargo bed. Always remove load first. Raising a loaded cargo bed can affect stability, resulting in tip-over.
- I.** Operate machine up and down slopes. Release accelerator pedal and apply brake to maintain safe speed when going down slope.
- J.** Do Not operate machine with cargo bed raised. Always close bed and latch securely before operating.
- K.** Do Not raise cargo bed when on slopes.

2.9 TOWING

The Turf Cruiser™/Trail Cruiser™ is fitted with a Class 1 receiver hitch. The vehicle, however, is rated at a lower tongue and towing capacity (see below).

Towing as with carrying loads, affects the handling, stability and braking of the machine. Towing loads requires extra caution. Reduce speeds when towing and avoid slopes whenever possible. Allow extra distance for stopping.

- A.** Do Not exceed rated towing capacity of the machine. The maximum towed load is 1000 lb (454 kg).
- B.** Do Not exceed rated tongue capacity of the hitch. The maximum tongue weight on the hitch is 100 lb (45 kg).

SECTION 2 – OPERATING INSTRUCTIONS

2.8 TOWING (Continued)

C. To provide adequate braking when towing, the cargo bed should be loaded. Load cargo bed to approximately one half (50%) of the towed load – not to exceed 500 lb (227 kg).

D. Reduce speed when towing. Do Not tow loads in excess of 10 mph.

E. Do Not tow loads on slopes in excess of 10 degrees (18% grade).

F. Do Not attempt to turn when descending a slope while towing.

G. Do Not carry children or others on trailer or towed attachment.

H. Do Not carry a load that you cannot safely control.

I. Always attach the trailer or towed attachment to the hitch provided on the machine. Do not attempt to attach at any other point on the machine.

J. Do Not modify the hitch on the machine.

K. The trailer or towed attachment must be secured to the machine to prevent unexpected disconnect. Use approved means to connect the trailer or towed attachment to the machine in accordance with the instructions provided with the trailer or attachment. When using a ball type hitch, always use the correct size ball and latch securely.

L. Distribute load on trailer evenly and so that tongue weight does not exceed 100 lb (45 kg).



M. Do Not tow machine behind any other machine or vehicle.

2.10 TRANSPORTING MACHINE

The machine will fit in the bed of most full size pick-up trucks. The truck or trailer used to transport the machine should have a rating of 3/4 ton (1500 lb/680 kg) or greater. When using ramps to load the machine, make sure that they are of sufficient capacity to support the machine weight (1230 lb/558 kg) and are positively secured to prevent slipping. The towing vehicle must be of sufficient capacity to handle the weight of the trailer and machine and comply with all applicable laws such as trailer lights and registration.

1. Do Not rely on the park brake to keep machine from moving while transporting on truck or trailer. Use straps, chains, cables or heavy ropes to secure machine to truck or trailer.



2. Do Not tow machine behind any other machine or vehicle.

 **WARNING** 

Transporting machine at highway speed may cause damage to optional accessories (windshield, sunshade, cab) or cause the hood to suddenly blow open. The machine should be backed on the vehicle or trailer. Reduce speed when transporting machine.



2.11 WATER CROSSING

Operating machine in water, crossing streams, rivers, and creeks is not recommended. Fast moving water can quickly move the machine off course causing loss of control that may result in injury or death. Even shallow, still water can conceal hazards that if encountered could result in injury or death. The final drive for the machine is through a belt. A wet belt may slip, leaving the machine and occupants stranded.

 **WARNING** 



DO NOT attempt to cross water with swift currents. Depth of water must be less than 8” and must be still. Operate machine in water only if absolutely necessary. If water crossing is unavoidable, operate machine slowly and only after carefully inspecting crossing area for concealed hazards.

2.12 POWERLINK™ ON-BOARD GENERATOR SYSTEM (Not All Models)

 **WARNING** 

DO NOT attempt to operate the POWERLINK™ System until you have read, understand and can follow all Important Safety and Operating Instructions in the POWERLINK™ Operator’s manual provided with your Turf Cruiser™/Trail Cruiser™ Utility Vehicle. The POWERLINK™ On-Board Generator System produces electricity that could result in death, serious injury and/or property damage if proper precautions are not followed.

The POWERLINK™ On-Board Generator System produces electricity that could result in death, serious injury and/or property damage if proper precautions are not followed. A Briggs & Stratton Operating and Safety Instruction manual has been provided with those **Turf Cruiser™ & Trail Cruiser™ utility vehicles** that are equipped with the POWERLINK™ On-Board Generator System. To avoid serious injury or death, read, understand and follow all warnings and instructions in the manual, on the machine and engine before using the generator system.

 **WARNING** 

The POWERLINK™ Generator is equipped with a safety interlock system. The generator speed control lever must be set all the way down to ‘SLOW’ before disengaging the parking brake or shifting the transmission from neutral. Failure to do so will cause the engine to die. DO NOT ATTEMPT TO OVERRIDE, REMOVE OR MODIFY THIS SAFETY FEATURE. INJURY, DEATH, OR EQUIPMENT DAMAGE MAY RESULT.

SECTION 2 – OPERATING INSTRUCTIONS

The POWERLINK™ On-Board Generator System will operate continuously at 1000 watts output and up to 1500 watts for brief periods. Operating at loads above 1000 watts may cause the POWERLINK™ system to reset, halting the electrical output. To avoid overloading the generator system, you must check the power (wattage) requirements of the appliance or tool before plugging it into the power receptacle. The generator maintains 120 volts output throughout the engine speed range; however, output wattage increases with engine speed. Always select the engine speed that will power the electrical device satisfactorily without triggering the POWERLINK™ system reset.

The POWERLINK™ On-Board Generator System includes three devices that will interrupt power output to the receptacle. Please refer to the POWERLINK™ Operator's manual for details on the function of these devices.

2.12.1 Starting the POWERLINK™ GENERATOR

- A. Complete Pre-Start Check List.
- B. Set park brake and shift transmission into neutral. (NOTE: POWERLINK™ system will not operate unless park brake has been set and transmission is in neutral.)
- C. Start engine. Refer to Section "Starting Engine".
- D. Set generator engine speed control to 'FAST' (Rabbit) position. (See Figure 2.7.)
- E. Actuate the POWERLINK™ system reset switch:
Move the switch to the OFF ('0') position, then return it to the ON ('1') position.
- F. Test the GFCI to insure it is functioning properly. Please refer to Section "Testing the GFCI".
- G. Before plugging in the electrical appliance or tool, make sure it is turned OFF and the wattage does not exceed the output of the POWERLINK™ generator.

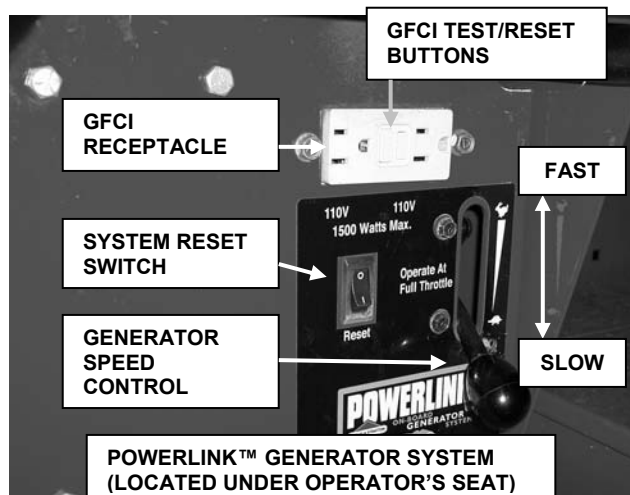

FIGURE 2.7

2.12.2 Resetting the POWERLINK™ GENERATOR

If the system loses electrical power:

- A. Turn off any appliance or tool that was in use prior to the loss of power.
- B. Verify the reset button on the GFCI has not been tripped. The reset button will pop out if tripped. To restore, press the reset button.
- C. The engine must be running, the park brake set, and the transmission in neutral.
- D. Actuate the POWERLINK™ reset switch:
Move the switch to the OFF position and then return it to the ON position.
NOTE: The system must be reset any time the engine is stopped for any reason.
- E. If power does not resume after reset, it may be a thermal overload. Wait 15 minutes before actuating the reset.

2.12.3 Testing the GFCI

To insure proper operation and avoid injury, the GFCI receptacle should be tested before every use.

- A. Have the POWERLINK system running and the power reset.
- B. Plug in a radio or lamp to verify that electrical power is present.
- C. Press the GFCI TEST button in order to trip the system and stop the flow of electricity.
- D. If the radio or lamp is still functioning, the GFCI is not working properly. Contact an Authorized Service Dealer.
- E. If the power goes off, the GFCI is working properly. To restore power, press the GFCI RESET button.

2.12.4 Stopping the POWERLINK™ GENERATOR

- A. Turn off electrical appliance or tool.
- B. Move system reset switch to OFF position
- C. Set generator engine speed control to 'SLOW' (Turtle) position.

WARNING

The POWERLINK™ Generator is equipped with a safety interlock system. The generator speed control lever must be set all the way down to 'SLOW' before disengaging the parking brake or shifting the transmission from neutral. Failure to do so will cause the engine to die. **DO NOT ATTEMPT TO OVERRIDE, REMOVE OR MODIFY THIS SAFETY FEATURE. INJURY, DEATH, OR EQUIPMENT DAMAGE MAY RESULT.**

- D. Allow engine to idle for several minutes to cool down.
- E. Unplug electrical cord(s) from receptacle(s).
- F. Turn ignition switch to STOP and remove the key.

SECTION 3 – MAINTENANCE

3.1 INTRODUCTION

To retain the quality of the Turf Cruiser™/Trail Cruiser™ utility vehicle, use genuine SNAPPER replacement parts only. Contact a local SNAPPER dealer for parts and service assistance. For the correct part or information, always mention the model and serial number. SNAPPER recommends returning the utility vehicle to an authorized SNAPPER dealer annually for inspection and addition of any new devices, which might upgrade the safety of the machine. For the nearest SNAPPER dealer in your area, check the Yellow Pages under the heading "LAWN MOWERS". For engine parts and service, look for the engine manufacturer's dealers under the heading, "ENGINES – Gasoline".

3.2 SERVICE - AFTER FIRST 5 HOURS

Routine maintenance is important to the performance and life of your vehicle. Service performed properly and at the recommended interval is essential. Refer to Section "MAINTENANCE SCHEDULE" in this manual and in the Engine Owner's Manual. Carefully complete all of the recommended service procedures.

IMPORTANT: Before working under a raised cargo bed, the bed must be empty and the prop rod securely latched.

3.2.1. Change Engine Oil

NOTE: The ServiceMinder is programmed to remind operator to change oil after first 8 hours of use. Should you choose instead to change oil after the first 5 hours of operation, simply disregard the ServiceMinder message.

1. Raise empty cargo bed and secure with prop rod.
2. Locate oil drain plug on engine at bottom front center of crankcase. See Figure 3.1.

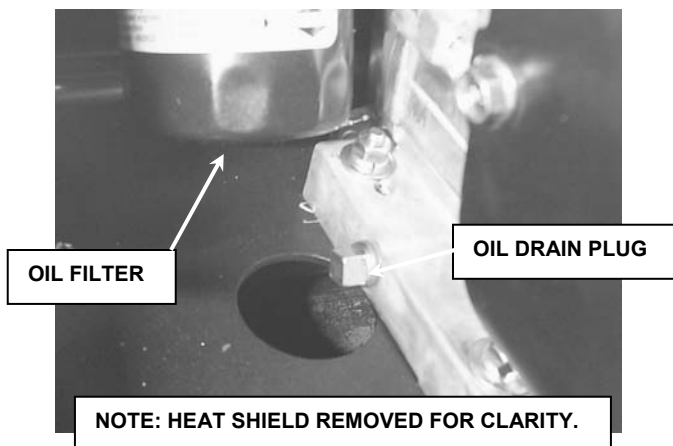

FIGURE 3.1

3. Place a 2 quart minimum capacity container under the drain plug.
4. Loosen or remove oil fill cap on engine.
5. Turn drain plug counter-clockwise and remove. Allow sufficient time for oil to drain completely.

6. Reinstall the oil drain plug. Torque plug to 12 ft-lb.
7. Fill engine crankcase to proper level with new oil. Refer to the Engine Owner's Manual for crankcase capacity and oil specifications. Do not overfill. The machine must be on a level surface and the dipstick unthreaded when checking engine oil level.
8. Lower cargo bed and latch securely.

IMPORTANT: Any oil spilled during draining or filling must be cleaned off of the machine before operating. Dispose of drain oil properly.

3.2.2. Service Engine Air Cleaner

The engine is equipped with a large capacity air cleaner. Service and replacement intervals will vary depending on operating conditions.

1. Locate engine air cleaner. Cover is retained with two latches. Unsnap both latches and remove cover. See Figure 3.2.

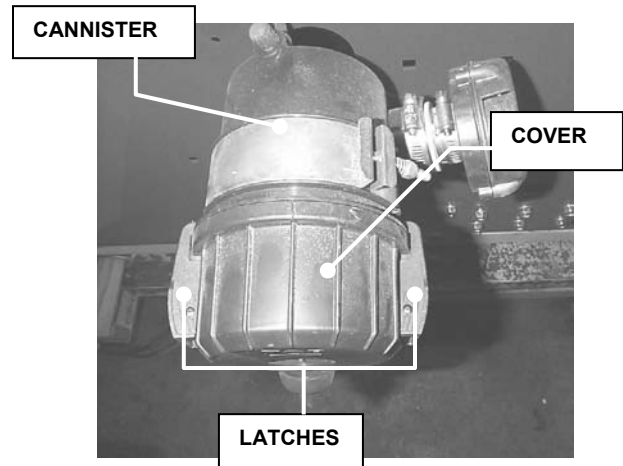

FIGURE 3.2
(Viewed from top, cargo bed removed)

2. Remove air filter element.
3. Clean inside of filter canister carefully - DO NOT allow debris to enter intake tube.
4. Service element. Clean by tapping gently on firm surface. Tapping will remove loose debris only. If cartridge is damaged or dirty, REPLACE IT. DO NOT oil the filter element or use pressurized air.
5. Place filter element into center of canister and press firmly to seat fully.
6. Attach cover to canister. Make sure that both latches are hooked on the flange on the canister, the cover is secure and the duck bill valve is located at the bottom. See Figure 3.3.

SECTION 3 – MAINTENANCE

3.2.2. Service Engine Air Cleaner (Continued)

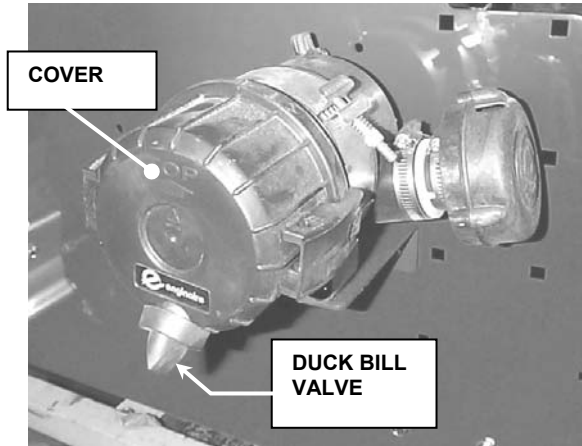

FIGURE 3.3

3.2.3. Check Transmission Fluid Level

1. Raise empty cargo bed and secure with prop rod.
2. Remove dipstick from top of transmission and wipe clean.
3. Screw dipstick fully back into transmission.
4. Remove dipstick and check fluid level.
5. Add MOBILFLUID 424 to bring level to "Full" mark on dipstick. Install dipstick and tighten securely
6. Lower cargo bed and latch securely.

3.2.4. Check Tire Pressure

1. Use a low pressure gage to measure tire inflation pressure.
2. Adjust tire pressure to 15 psi. front and rear. Do Not over inflate.

3.2.5. Lubrication –Axle Couplings & Steering Pins

1. Park machine on level surface.
2. Release park brake.
3. Locate grease fitting on left axle coupling. See Figure 3.4.

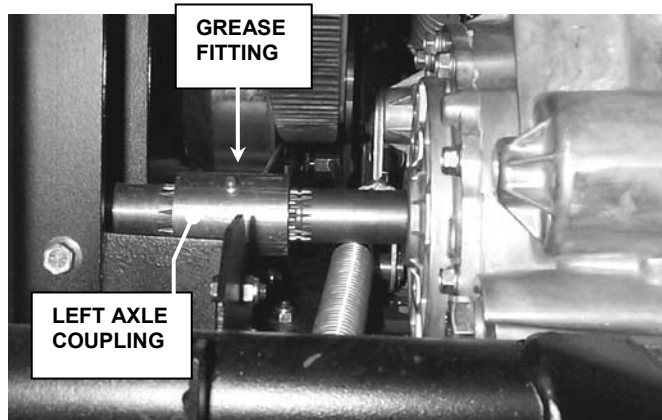

FIGURE 3.4
(Viewed from rear of machine)

4. Roll machine until grease fitting is accessible.
5. Apply (2) shots of General Purpose grease from a grease gun
6. Repeat on right axle coupling.
7. Locate grease fitting on left & right king pins. See Figure 3.4a.
8. Apply (4) shots of General Purpose grease from a grease gun.



FIGURE 3.4a

3.2.6. Check Wheel Lug Nuts

1. Torque all lug nuts to 75 ft-lb.

3.2.7. Check Brakes

1. Move machine to an open area, free of obstacles, children and others.
2. Set park brake firmly (2 or more clicks).
3. Start engine and shift transmission to Forward.
4. Using caution, gently move accelerator pedal to approximately 1/2 speed. Hold pedal momentarily.
5. **Machine should not move.** Release accelerator pedal and allow engine to return to idle.
6. Shift transmission to Reverse.
7. Move accelerator pedal to approximately 1/2 speed. Hold pedal momentarily.
8. **Machine should not move.** Release accelerator pedal and turn engine off.
9. If machine moved, Refer to Section "Adjustments – Service Brake and Park Brake".

WARNING

DO NOT operate machine if brakes are not functioning properly. Adjust, repair or replace as necessary. Contact your local authorized dealer for assistance.

SECTION 3 – MAINTENANCE

3.2.8. Check Interlocks

The machine is equipped with interlocks that prevent the engine from cranking or starting unless the brake is fully depressed and the transmission is in Neutral. It is also equipped with an operator presence sensor that will cause the engine to die if the operator attempts to leave the seat without setting the park brake. On models equipped with the POWERLINK Generator System, the interlock kills the engine if the parking brake is disengaged or the transmission is engaged while the generator is being operated. The interlocks were designed for the safety of the operator and others. Do not modify or defeat the interlocks. Do not operate the machine if interlocks are not functioning properly.

1. Move machine to a flat, open area free of obstacles, children and others.
2. Shift transmission to Forward.
3. Set park brake.
4. Turn key to "Start". **Engine must not crank.**
5. Shift transmission to Reverse.
6. Turn key to "Start". **Engine must not crank.**
7. Shift transmission to neutral.
8. Release park brake.
9. Turn key to "Start". **Engine must not crank.**
10. Set park brake and shift transmission to Neutral.
11. Start engine.
12. With engine at idle, release park brake.
13. Carefully grasp the steering wheel and raise up slightly out of the operator's seat. **The engine must begin to die.** (The engine can continue to run if you sit back down in the seat before it dies completely.) Set park brake.
14. Shift Transmission to Forward.
15. Carefully grasp the steering wheel and raise up slightly out of the operator's seat. **The engine must begin to die.** (The engine can continue to run if you sit back down in the seat before it dies completely.)
16. Shift Transmission to Reverse.
17. Carefully grasp the steering wheel and raise up slightly out of the operator's seat. **The engine must begin to die.** (The engine can continue to run if you sit back down in the seat before it dies completely.)

POWERLINK-equipped models only:

18. Start engine.
19. Shift Transmission to Forward.
20. Reach down and raise generator speed control lever. Engine should begin to die. Drop lever.
21. Shift Transmission to Reverse.
22. Reach down and raise generator speed control lever. Engine should begin to die. Drop lever.
23. Shift Transmission to Neutral and disengage park brake.
24. Reach down and raise generator speed control lever. Engine should begin to die. Drop lever.
25. If the machine failed any of the above tests, do not operate machine. Contact your local Snapper dealer for assistance.



3.3 SERVICE – EVERY 25 OPERATING HOURS

3.3.1. Perform all service required after the first 5 hours of operation – Refer to Section "SERVICE – AFTER FIRST 5 HOURS".

3.3.2. Check Battery Charge Level.

NOTE: The battery in this machine is maintenance-free. It has been filled to the proper level with acid and is sealed. Do not attempt to open the battery.

1. Remove seat knobs and carefully tilt forward to expose battery.
2. Remove battery, check voltage, and charge if necessary. Refer to Section 'Adjustments and Repairs, Battery'.

3.3.3. Check Drive Belt

1. Visually inspect condition of drive belt for signs of wear, deterioration, fraying or cracks.
2. Replace belt as necessary. Refer to Section 'Adjustments and Repairs, Drive Belt Replacement'.

3.3.4. Check "Maintenance Schedule" Section of the Engine Owner's Manual for engine service.

3.4 SERVICE – EVERY 50 OPERATING HOURS

3.4.1. Perform all service required after the first 25 hours of operation. Refer to Section "Service – Every 25 Operating Hours".

3.4.2. Check Wear Pads On Driven Clutch

1. Visually inspect for missing and worn wear pads.
2. There should be no signs of metal to metal contact.
3. If replacement is necessary, contact your local Snapper dealer for assistance.

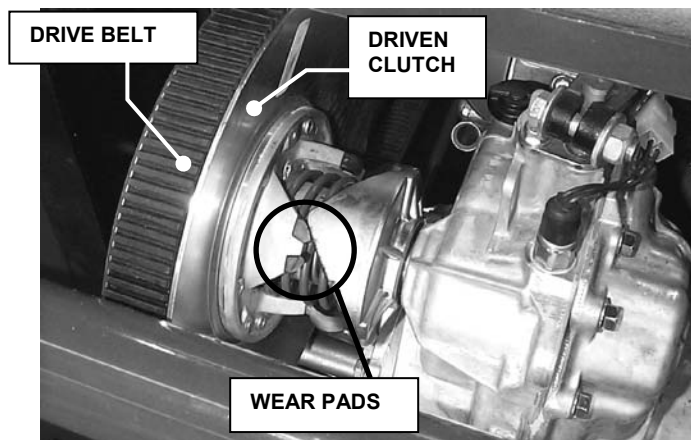

FIGURE 3.5

SECTION 3 – MAINTENANCE

3.4 SERVICE – EVERY 50 OPERATING HOURS (CONT.)

3.4.3. Check Drive Clutch

1. Start engine and shift transmission to Forward.
2. Release park brake. Clutch should have no tendency to grab or cause motion.
3. Gradually increase engine speed with the accelerator pedal. The machine should begin to move slowly with no jerking or unusual noises.
4. If the clutch is not functioning smoothly or is dragging, it may require cleaning and lubrication. Contact local Snapper dealer for assistance.

IMPORTANT – DRIVE CLUTCH MAINTENANCE IS RECOMMENDED EVERY 200 HOURS OR YEARLY. MORE FREQUENT SERVICE INTERVALS MAY BE REQUIRED IN SEVERE APPLICATIONS. ALWAYS KEEP RUBBER DUST PLUG IN PLACE ON CLUTCH.

3.4.4. Change Engine Oil

Change engine oil as indicated by ServiceMinder display. Refer to oil changing instructions earlier in this section.

3.5 SERVICE – EVERY 100 OPERATING HOURS

3.5.1. Change Engine Oil Filter

Change engine oil filter. Refer to engine manual for instructions and filter specifications.

3.6 SERVICE – EVERY 200 OPERATING HOURS (OR YEARLY)

3.6.1. Perform all maintenance required after 50 hours of operation. Refer to Section “Service – Every 50 Operating Hours”.

3.6.2. Change Transmission Fluid

1. Remove drain plug located on left bottom side of transmission case. Drain fluid into 6 quart minimum capacity pan. See Figure 3.6.

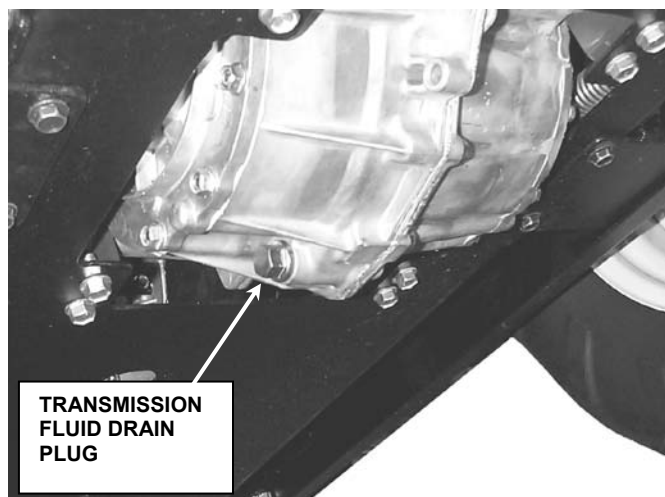

FIGURE 3.6

2. Allow fluid to drain completely. Reinstall drain plug and tighten securely.
3. Fill transmission with 5.6 qt of MOBILFLUID 424 or equivalent.
4. Check fluid level and top off as needed. Do Not over fill.

3.6.3. Replace Fuel Filter

1. Engine must be cool before proceeding.
2. Remove clamps from filter.
3. Remove hose from fittings on filter. Be prepared to collect small amount of fuel as it drains from the hose.
4. Dispose of old filter. Do Not attempt to clean and re-use.
5. Slide hose over fittings on new filter.
6. Reposition clamps over fittings on filter.
7. Clean up any spilled fuel.
8. Start engine and check for leaks.



3.7 STORAGE (OUT OF SEASON)

3.7.1. Perform all maintenance as specified in the “Maintenance Schedule” in this manual and in the Engine Owners Manual.

1. Drain Fuel Tank. Drain fuel into approved container and store away from source of ignition.
2. Run Engine to empty carburetor bowl.
3. Remove Battery.
4. Charge Battery (if necessary – see Adjustments and Repairs, Battery) and store in cool dry place on a non-concrete surface.
5. Store the machine in a cool, dry, protected place.

SECTION 4 – ADJUSTMENTS & REPAIRS

⚠ WARNING ⚠

DO NOT attempt any adjustments, maintenance, service or repairs with the engine running. **STOP** engine. Set park brake. Shift transmission to neutral. Remove key. Remove spark plug wire from spark plug and secure away from plug. Engine and components are **HOT**. Avoid serious burns, allow all parts to cool before working on machine.

4.1 DRIVE BELT REPLACEMENT

1. Engine and all parts must be cool before proceeding.
2. Remove key and disconnect spark plug wires.
3. Set park brake and shift transmission to neutral.
4. Roll belt off of driven clutch. See Figure 4.1.

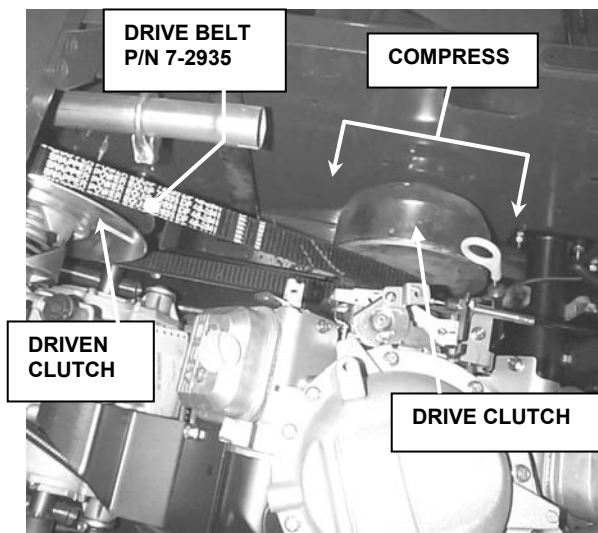

FIGURE 4.1

(Exhaust components removed for clarity)

5. Slide belt between bottom of drive clutch and notched area in frame.
6. Drive clutch is spring loaded. Compress clutch away from frame allowing clearance for belt.
7. Pull belt up between clutch and frame.
8. To install new belt, first compress clutch and place belt between clutch and frame.
9. Slide belt between bottom of drive clutch and notched area in frame and position on drive clutch.
10. Roll belt onto driven clutch.

4.2 SERVICE BRAKE & PARK BRAKE ADJUSTMENT

Brakes are critical to the safe operation of the machine. Check the function of the brakes frequently. Refer to Section “Maintenance – Check Brakes”. If adjustment is required, complete each of the following steps carefully. Always verify that the brakes function properly after performing any brake adjustments. Do Not operate the machine if the brakes are not functioning properly.

⚠ WARNING ⚠

DO NOT operate machine if brakes are not functioning properly. **Adjust, repair or replace as necessary.** Contact your local authorized dealer for assistance.

1. Park machine on flat surface. Set park brake. Remove key.
2. Locate left and right brake adjustment nuts. Clearly mark the nuts so that you will be able to count turns. See Figure 4.2.

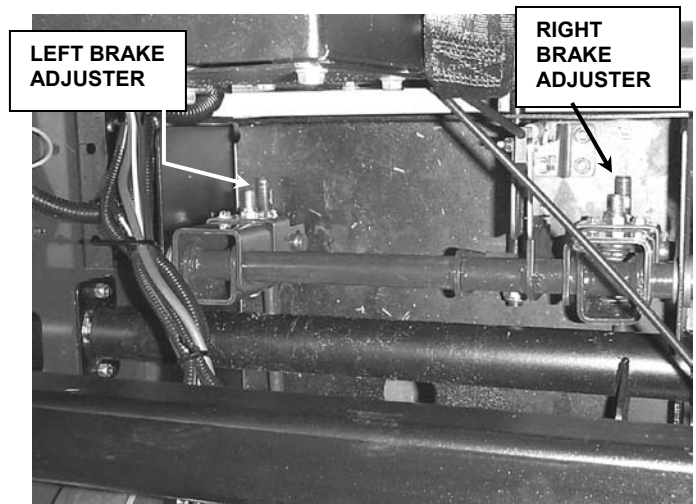

FIGURE 4.2 (Seen from above)

3. Using a 7/8” deep well socket, turn each nut one-half turn clockwise, tightening brake adjustment.
4. Check function of brake. Refer to Section “Maintenance – Check Brakes”.
5. If additional adjustment is required, turn each nut one-half turn clockwise and re-check brake function.
6. Repeat until brakes function properly. **DO NOT exceed two turns total and only make adjustment in half-turn increments. Overtightening the brakes will lead to premature wear and brake failure. Contact local authorized dealer for assistance.**
7. After completing the brake adjustment and verifying that they function properly, further fine adjustment may be required to balance the action of the left and right brakes.

SECTION 4 – ADJUSTMENTS & REPAIRS

4.2 SERVICE BRAKE & PARK BRAKE ADJUSTMENT (Continued)

8. Operate machine on smooth flat surface at approximately 1/2 speed.
9. Apply brake firmly. Machine should stop in a straight line and not pull to either the right or the left. Also both rear tires should begin to skid evenly.
10. If the machine pulls to the left or the left tire skids before the right, tighten the right brake adjustment nut 1/4 turn clockwise.
11. If the machine pulls to the right or the right tire skids before the left, tighten the left brake adjustment nut 1/4 turn clockwise.
12. Continue until the machine stops straight and both tires skid evenly.

2. Observe and note cable positions on battery. See Figure 4.4.
3. Disconnect cables from battery terminals, disconnecting BLACK (Negative) cables first. Retain hardware.

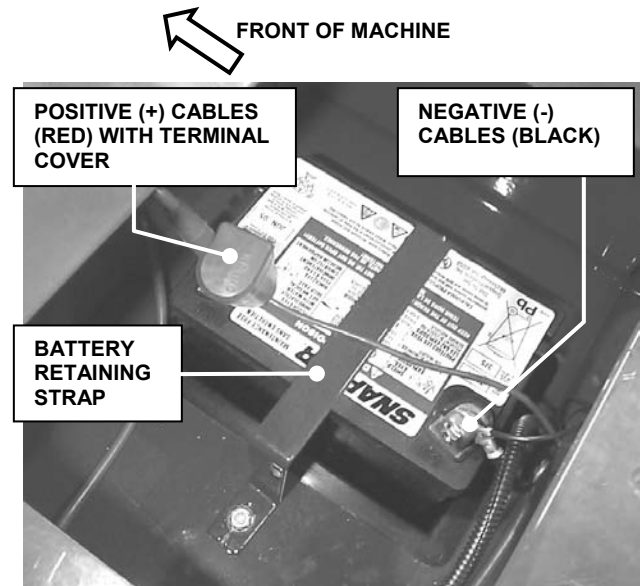

FIGURE 4.4

4. Remove battery retaining strap hardware and carefully lift battery out of battery tray. See Figure 4.4.

WARNING

DO NOT attempt any adjustments, maintenance, service or repairs with the engine running. STOP engine. Set park brake. Shift transmission to Neutral. Remove key. Remove spark plug wire from spark plug and secure away from plug. Engine and components are HOT. Avoid serious burns, allow all parts to cool before working on machine.

4.3 BATTERY

NOTE: The battery in this machine is maintenance-free. It has been filled to the proper level with acid and is sealed. Do not attempt to open the battery.

4.3.1. Battery Removal

1. The battery is located under operator's seat. Remove seat knobs and carefully tilt forward to expose battery. See Figure 4.3.

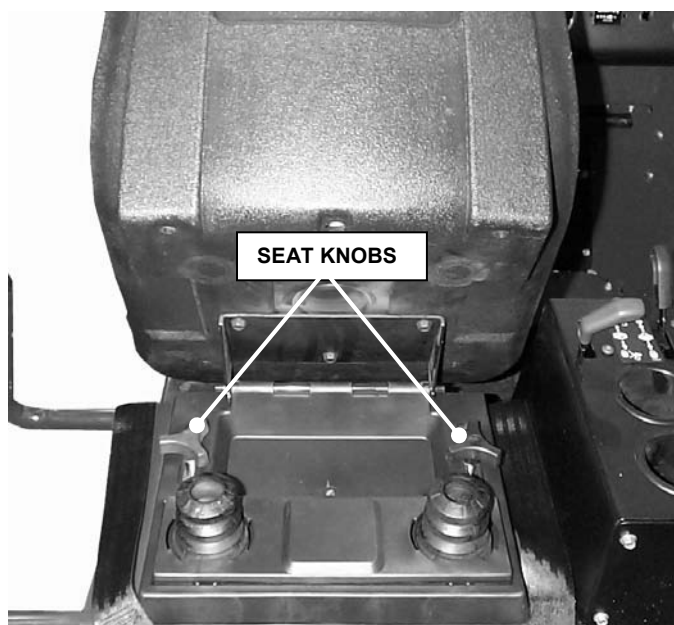

FIGURE 4.3

WARNING

Cables must be connected to battery terminals in the proper position as shown in Figure 4.4. DO NOT attempt to charge battery while installed on the Machine. DO NOT use "BOOST" chargers on the battery.

SECTION 4 – ADJUSTMENTS & REPAIRS

4.3.2. Battery Installation

IMPORTANT! The orientation of the battery and the routing of the battery cables is very important. Install battery carefully as shown in Figure 4.4. Always install positive (red) cables using the terminal cover. DO NOT operate machine until the battery retaining rod has been installed and the battery retained securely.

1. Carefully place battery into battery tray, and replace battery retaining strap (see Figure 4.4). Tighten strap hardware securely.
2. Connect positive (+) cables (red) first, from wiring harness to the positive terminal (+) on battery using bolt and nut. Install terminal cover. See Figure 4.4
3. Connect negative (-) cables (black) last, to negative terminal (-) on battery using bolt and nut. Apply a small amount of grease over terminals to prevent corrosion. See Figure 4.4.
4. Install seat/pedestal. Tighten seat knobs securely.

4. Store battery in an area away from the machine on a wood surface. DO NOT STORE BATTERY ON A CONCRETE SURFACE.

4.3.5. Battery Testing

1. Remove battery. Refer to Section "BATTERY REMOVAL".
2. Place battery in a well ventilated area on a level surface.
3. Using a voltmeter, measure the battery voltage and compare to the voltages listed in the "BATTERY CONDITION CHART" below to determine condition of battery. (Take care to hook the positive lead of the voltmeter to the battery's positive terminal, and the negative lead to the negative terminal.)

Battery Condition Chart	
State of Charge	Digital Voltmeter
100% Charged w/ Sulfate Stop	12.80v
100% Charged	12.60v
75% Charged	12.40v
50% Charged	12.10v
25% Charged	11.90v
0% Charged	Less than 11.80v

4. If battery is less than 100% charged, then charge battery. Refer to Battery Charging Section.

WARNING

Shield the positive terminal with terminal cover located on battery harness. This prevents metal from touching the positive terminal, which could cause sparks.

4.3.3. Battery Charging

1. Remove battery. Refer to Section "BATTERY REMOVAL".
2. Place battery in a well ventilated area on a level surface.
3. Connect battery charger to battery terminals. (Always remember to connect red cable to positive (+) terminal, black to negative (-) terminal.)
5. Charge battery at 6-10 amps for 1 hour.
6. If battery will not accept charge or is partially charged after 1 hour, replace with new battery.

4.4 CARGO BED LATCH STRIKER ADJUSTMENT

1. With cargo bed lowered, check to make sure that both latches hook completely onto striker bolts. See Figure 4.5.
2. If necessary, loosen striker bolt and/or striker bracket bolts, and adjust up until latches hook correctly. Retighten all hardware securely.

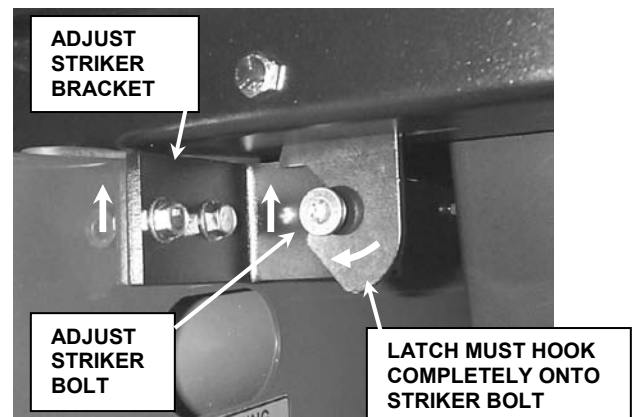

FIGURE 4.5

WARNING

Keep all sparks, flame and fire away from area when charging battery.

WARNING

DO NOT attempt to charge battery while installed in the machine. DO NOT use "BOOST" chargers on the battery.

4.3.4. Battery Storage

If machine is to be stored out of season, it is recommended the battery be removed, charged and stored.

1. Remove battery. Refer to Section "BATTERY REMOVAL".
3. Bring battery to full charge (if required).

SECTION 4 – ADJUSTMENTS & REPAIRS

4.5 TRANSMISSION SHIFT ROD ADJUSTMENT

The transmission shift rod is preset at the factory, and should not need adjustment. However, if transmission fails to shift into forward or reverse, adjustment may be needed. To adjust rod:

1. With cargo bed lifted and propped securely, loosen jam nut securing rod adjusting link. See Figure 4.6.
2. If transmission fails to shift into Forward, turn link counterclockwise 2-3 turns.
3. If transmission fails to shift into Reverse, turn link clockwise 2-3 turns.
4. Retighten jam nut against link, start vehicle and check shifter operation.
5. Repeat steps 1-4 as needed.

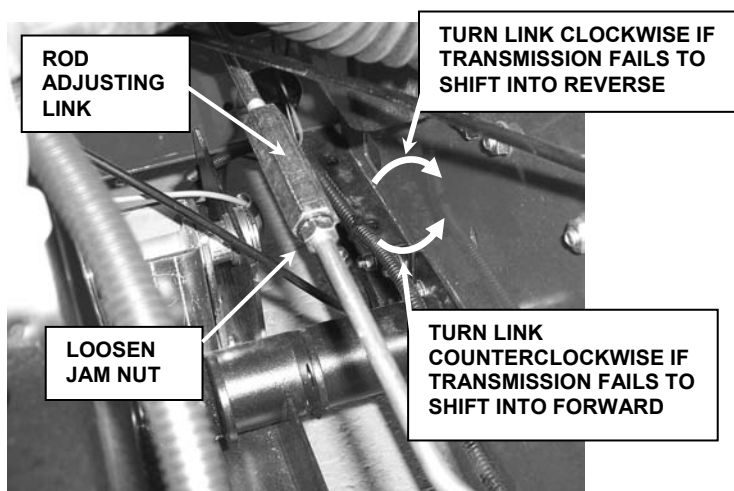
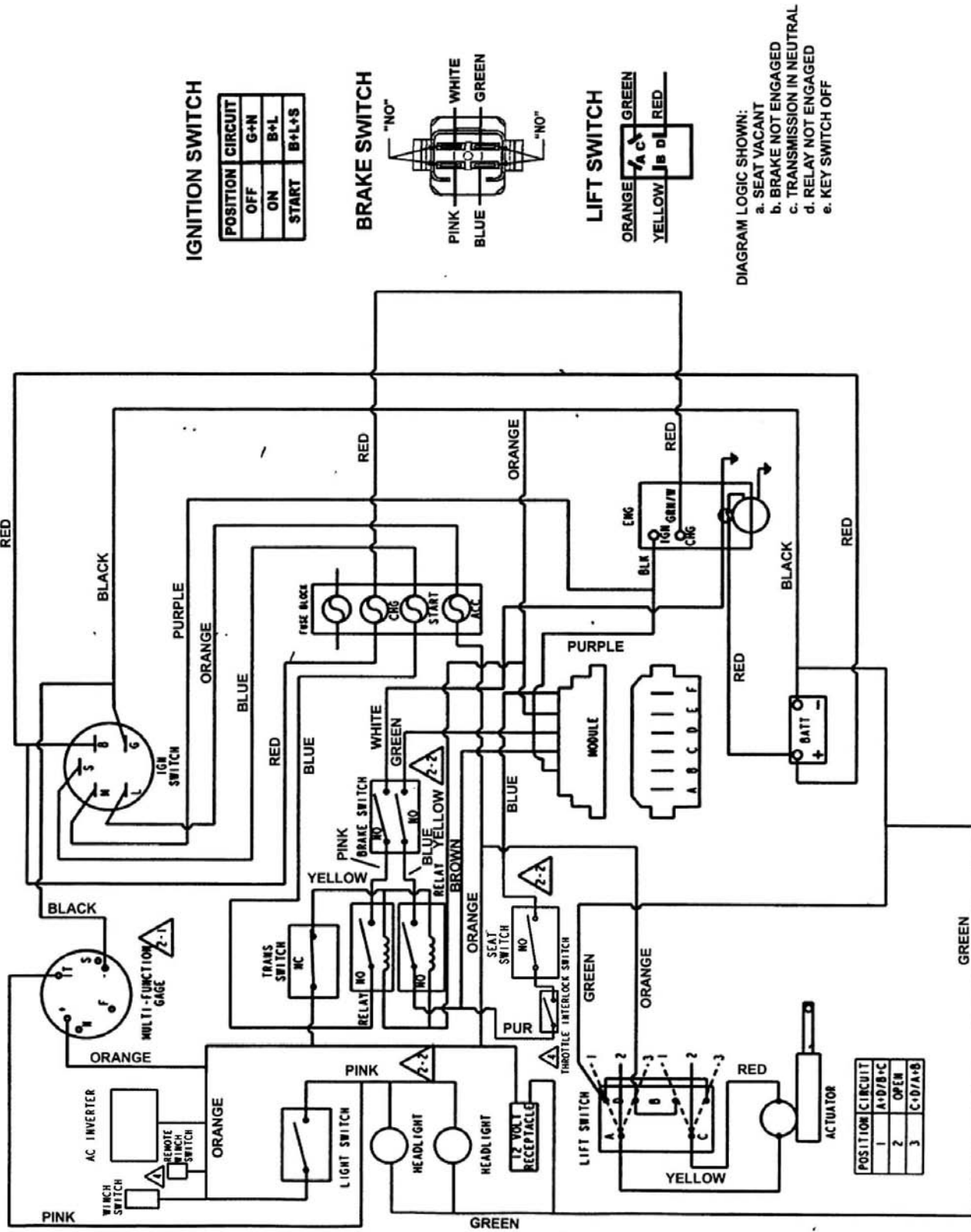

FIGURE 4.6

⚠ WARNING ⚠

DO NOT attempt any adjustments, maintenance, service or repairs with the engine running. **STOP** engine. Set park brake. Shift transmission to Neutral. Remove key. Remove spark plug wire from spark plug and secure away from plug. Engine and components are **HOT**. Avoid serious burns, allow all parts to cool before working on machine.

SECTION 5 - ELECTRICAL



SCHEMATIC - WIRING DIAGRAM Part No. 7-3639

SECTION 5 - ELECTRICAL

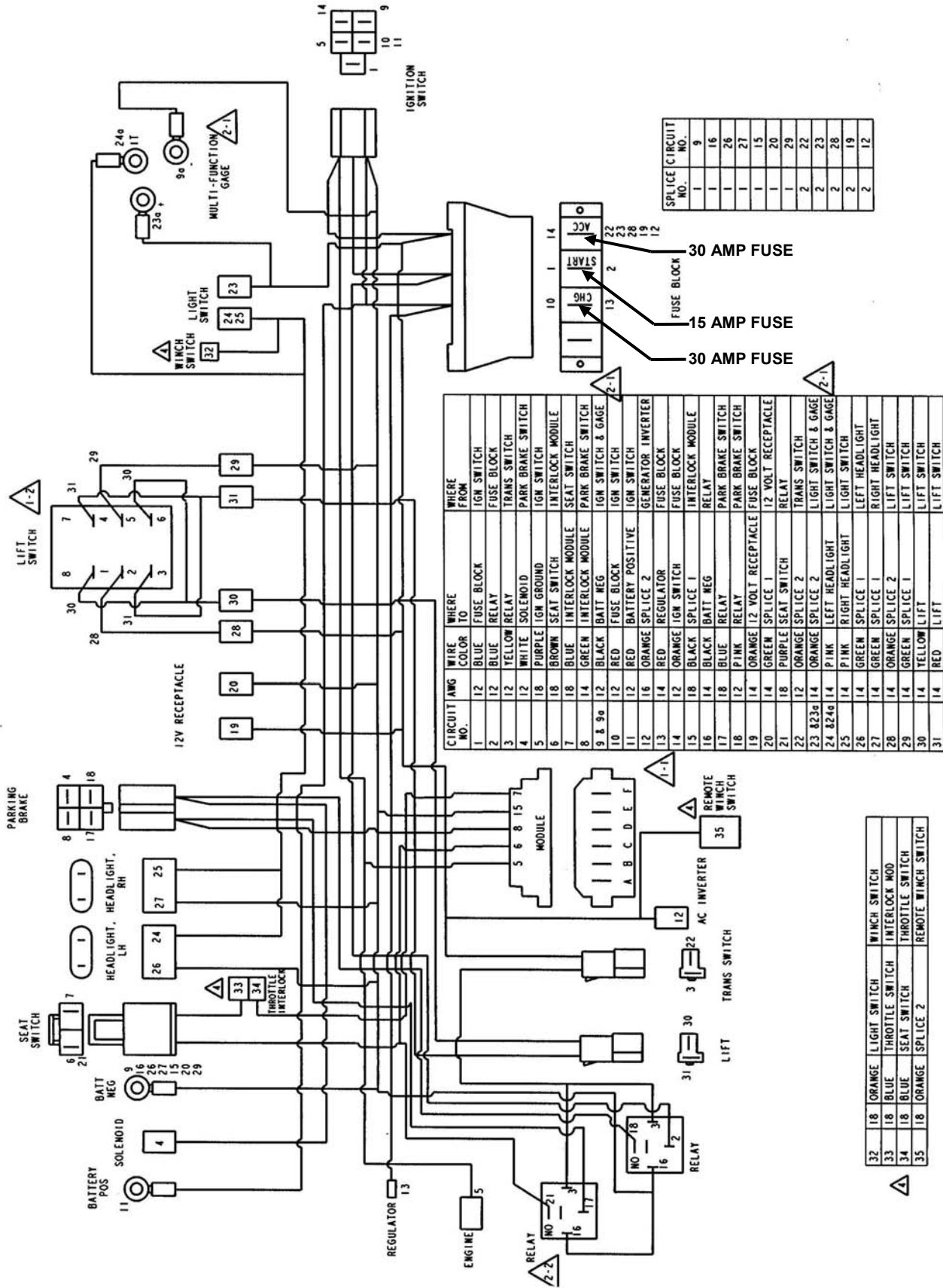

SPLICE CIRCUIT NO.	NO.
1	9
1	16
1	26
1	27
1	15
1	20
1	29
2	22
2	22
2	23
2	28
2	19
2	12

32	18	ORANGE	LIGHT SWITCH
33	18	BLUE	THROTTLE SWITCH
34	18	BLUE	SEAT SWITCH
35	18	ORANGE	SPLICE 2

TROUBLESHOOTING

PROBLEM	PROBABLE CAUSE	CORRECTIVE ACTION
Engine Will Not Start Using Electric Starter	1. Fuel tank empty.	1. Fill fuel tank with fresh fuel to proper level.
	2. Engine needs choking.	2. Move choke control to "ON" position.
	3. Spark plug wire(s) disconnected.	3. Place spark plug wire(s) onto spark plug(s).
	4. Faulty interlock circuit.	4. Contact authorized dealer.
	5. Brake pedal not depressed fully.	5. Depress brake.
	6. Blown Fuse.	6. Replace with new 15 AMP fuse.
	7. Transmission not in neutral.	7. Shift transmission into neutral.
	8. Battery is weak or dead.	8. Charge or replace with new battery.
	9. Battery cables loose, broken disconnected or corroded.	9. Clean and connect battery cables. If broken, replace with new battery cables.
	10. Faulty electric starter or starter solenoid.	10. Contact authorized dealer.
	11. Starter cable loose, broken or disconnected.	11. Connect starter cable. If broken, replace with new starter cable.
	12. Electrical wiring harness disconnected or broken.	12. Connect or replace with new wiring harness.
Engine Stalls After Running	1. Operator not in seat.	1. Sit in operator's seat.
	2. Choke control in the "ON" position.	2. Move choke control to "OFF" position.
	3. Fuel tank empty.	3. Fill fuel tank with fresh fuel to proper level.
	4. Engine air cleaner dirty.	4. Clean or replace filter.
	5. Spark plug defective or gap set improperly.	5. Service spark plug(s).
	6. Fuel filter restricted.	6. Replace fuel filter.
	7. Water, debris or stale fuel in fuel system.	7. Drain and clean fuel system.
Engine Loses Power	1. Excessive load on engine.	1. Reduce load.
	2. Engine air cleaner dirty.	2. Clean or replace filter.
	3. Spark plug(s) faulty.	3. Service spark plug(s).
	4. Water, debris or stale fuel in fuel system.	4. Drain and clean fuel system. Replace filter.
Engine Backfires When Turned To "STOP"	1. Engine hot or engine speed too fast.	1. Allow engine to idle for several minutes before turning key to "STOP".
Excessive Vibration	1. Bent wheel or damaged/flat tire.	1. Repair/replace as required.
	2. Loose components.	2. Service and tighten loose parts.
	3. Lug nuts loose.	3. Tighten. Torque to 75 ft.lbs.
	4. Lumpy or frayed drive belt.	4. Replace drive belt.
Machine Will Not Move. Loss Of Traction.	1. Transmission damaged.	1. Contact authorized dealer.
	2. Drive belt damaged or worn.	2. Install new drive belt.
	3. Transmission in neutral.	3. Shift transmission to "F" or "R".
	4. Drive or Driven clutch requires service.	4. Contact authorized dealer.
	5. Parking brake engaged.	5. Release parking brake.
Oil Leaking	1. Leaking transmission.	1. Contact authorized dealer.
	2. Leaking engine block.	2. Contact authorized dealer.

MAINTENANCE SCHEDULE

SUBJECT	SERVICE TO BE PERFORMED	REFERENCE PAGES	EACH USE	5 HRS	25 HRS	50 HRS	100 HRS	200 HRS	EACH SEASON
Engine	Check Oil Level	Page 13	X						
Engine	Initial Oil Change	Page 22		X					
Engine	Periodic Oil Change	Page 25				X*			
Engine	Oil Filter Change	Engine Manual					X		
Air Cleaner	Service/Replace	Engine Manual & Page 22-23				X**			
Spark Plug	Replace Plugs	Engine Manual.						X	
Fuel Filter	Replace Filter	Page 25						X	
Battery	Check/Charge Battery	Page 27-28							X
Tires	Check Pressures	Page 13	X						
Drive Belt	Check For Wear And Replacement	Pages 24 & 26			X				X
Lubrication Points	Grease or Oil	Page 23		X	X				X
Transmission	Check Fluid Level	Page 23			X				
Tires	Inspect	Page 23	X						
Transmission	Change Fluid	Page 25						X	X
Tires	Torque Lug Nuts	Page 23			X				
Interlocks	Verify Function	Page 24	X						
Drive Clutch	Inspect Wear Pads	Page 24				X			
Drive Clutch	Check Function	Page 25				X			
Brakes	Check Function	Pages 14, 26, 27		X					

*Change oil every 25 hours when operating under heavy load or high temperatures.

**Clean more often under dusty conditions or when air debris is present

1 YEAR LIMITED WARRANTY

For one (1) year from purchase date for the original purchaser's residential, non-commercial use, **SNAPPER - A Division of SIMPLICITY Manufacturing, Inc.**, through any authorized **TURF CRUISER** dealer, will replace, free of charge (except for taxes where applicable), any part or parts found upon examination by the factory at McDonough, Georgia, to be defective in material or workmanship or both.

For ninety (90) days from purchase date for the original purchaser's commercial, rental, or other non-residential use, **SNAPPER - A Division of SIMPLICITY Manufacturing, Inc.**, through any authorized **TURF CRUISER** dealer will replace, free of charge (except for taxes where applicable), any part or parts found upon examination by the factory at McDonough, Georgia, to be defective in material or workmanship or both

All transportation costs incurred by the purchaser in submitting material to an authorized **TURF CRUISER** dealer for replacement under this warranty must be paid by the purchaser.

This warranty does not apply to engines and their components, and batteries, as these items are warranted separately. This warranty does not apply to parts that have been damaged by accident, alteration, abuse, improper lubrication, normal wear, or other cause beyond the control of **SNAPPER - A Division of SIMPLICITY Manufacturing, Inc.** This warranty does not cover any machine or component that has been altered or modified, changing safety, performance, or durability.

Batteries have a one (1) year warranty period with free replacement if required for one (1) year from the original purchase date. **SNAPPER - A Division of SIMPLICITY Manufacturing, Inc.**, will not be responsible for any installation cost incurred. The battery warranty only covers original equipment batteries and does not cover damage to the battery or machine caused by neglect or abuse, destruction by fire, explosion, freezing, overcharging, or improper maintenance.

There is no other express warranty.

DISCLAIMER OF WARRANTY

Implied warranties, including those of merchantability and fitness for a particular purpose, are limited to one (1) year from purchase date for the original purchaser's residential or other non-commercial use, and ninety (90) days from the purchase date for the original purchaser's commercial, rental or other non-residential use, and up to the extent permitted by law and all implied warranties are excluded. This is the exclusive remedy. Liabilities for consequential damages, under any and all warranties are excluded. Some states do not allow limitations on how long an implied warranty lasts, or do not allow the exclusion or limitation of incidental or consequential damages, so the above limitation or exclusion may not apply to you.

This warranty gives you specific legal rights, and you may also have other rights which vary from state to state.

WARNING: THE USE OF REPLACEMENT PARTS OTHER THAN GENUINE SNAPPER PARTS MAY IMPAIR THE SAFETY OF SNAPPER PRODUCTS AND WILL VOID ANY LIABILITY AND WARRANTY BY SNAPPER ASSOCIATED WITH THE USE OF SUCH PARTS.

IMPORTANT: Please fill out the attached Product Registration Card immediately and mail to:
Snapper's Product Registration Center, P.O. Box 1379, McDonough, Georgia. 30253

PRODUCT REGISTRATION FORM

**IMPORTANT: KEEP THIS INFORMATION FOR YOUR PERSONAL RECORDS
(Complete the following information on your purchase)**

Model Number _____

Serial Number _____

Date of Purchase _____

Retailer _____

Retailer's Phone Number _____

**It is very important that you register your purchase to ensure warranty coverage.
Please mail your product registration card to:**

Snapper Products, Inc., P.O. Box 1379, McDonough, Georgia 30253.

Or you may register on line at www.snapper.com.

You can contact us at our web site or if you would like to speak with a Customer Service Representative, call us at the Snapper Customer Relations Center. For faster service please have your Serial Number and Model Number available.

Call the Snapper Customer Relations Center at 1-800-935-2967.

Safety Instructions & Operator's Manual For

TURF CRUISER™

TRAIL CRUISER™

UTILITY VEHICLES SERIES 1

IMPORTANT

This products is built using an engine that meets or exceeds all applicable emissions requirements on the date manufactured. The label on the engine contains very important emissions information and critical safety warnings. Read, Understand, and Follow all warnings and instructions in this manual, the engine manual, and on the machine, engine and attachments. If you have any questions about your Snapper product, contact your local authorized Snapper dealer or contact Snapper Customer Service at Snapper, McDonough, GA. 30253. Phone: (1-800-935-2967).



WARNING

BATTERY POSTS, TERMINALS AND RELATED ACCESSORIES CONTAIN LEAD AND LEAD COMPOUNDS, CHEMICALS KNOWN TO THE STATE OF CALIFORNIA TO CAUSE CANCER AND BIRTH DEFECTS OR OTHER REPRODUCTIVE HARM. WASH HANDS AFTER HANDLING.



WARNING

ENGINE EXHAUST, SOME OF ITS CONSTITUENTS, AND CERTAIN VEHICLE COMPONENTS CONTAIN OR EMIT CHEMICALS KNOWN TO THE STATE OF CALIFORNIA TO CAUSE CANCER OR OTHER REPRODUCTIVE HARM.

SNAPPER®McDonough, GA., 30253 U.S.A.

Free Manuals Download Website

<http://myh66.com>

<http://usermanuals.us>

<http://www.somanuals.com>

<http://www.4manuals.cc>

<http://www.manual-lib.com>

<http://www.404manual.com>

<http://www.luxmanual.com>

<http://aubethermostatmanual.com>

Golf course search by state

<http://golfingnear.com>

Email search by domain

<http://emailbydomain.com>

Auto manuals search

<http://auto.somanuals.com>

TV manuals search

<http://tv.somanuals.com>