

42

42" ROTARY MOWER, MFG. NO. 1690022
HITCH ASSEMBLY, MFG. NO. 1690082
HITCH ASSEMBLY, MFG. NO. 1690083

OPERATOR'S MANUAL

FORM - 1651224
PRINTED IN U.S.A.
748

TABLE OF CONTENTS

	Page
SAFETY PRECAUTIONS	1
ASSEMBLING	2
REMOVING	6
OPERATION	7
ADJUSTMENTS	8
MAINTENANCE	9

CONGRATULATIONS!

This great new product is engineered with imagination and built with integrity to assure you maximum service and performance for years to come. To completely understand the operation of your equipment and to take full advantage of its many fine built-in features, study this instruction manual thoroughly before operating the machine. The little time you spend reading now will repay you many times over in the time you save and the satisfaction you gain in using your equipment properly and safely.

SAFETY FIRST

PROTECT YOURSELF AND OTHERS BY FOLLOWING THESE SAFETY RULES

- * **ALWAYS** know your controls and how to stop quickly in an emergency—read the operator's manual thoroughly.
- * **NEVER** allow anyone to operate the equipment without full instruction and knowledge of safe operating procedures.
- * **NEVER** handle gasoline carelessly. Use an approved container and fill the tank out of doors. Wipe up spilled gasoline. Do not smoke while fueling the engine.
- * **NEVER** add gasoline to a running engine. Stop engine and allow it to cool a few minutes before adding fuel. Replace filler cap securely.
- * **NEVER** operate equipment unless all guards and shields are in place.
- * **ALWAYS** keep hands, feet and clothing away from power driven parts.
- * **ALWAYS** stop the engine before servicing or adjusting machine or equipment.
- * Never allow children or pets to cross your path or cause distractions in the area while operating.
- * Release both clutch levers and stop the engine before cleaning the tines, removing obstacles, making adjustments or when leaving the operating position.
- * **NEVER** overspeed the engine or alter governor settings. Excessive speed is always unsafe and shortens engine life.
- * **ALWAYS** properly maintain the equipment. Check all fasteners, guards and parts.
- * Do not operate the engine where carbon monoxide can collect.
- * **ALWAYS** stop the engine and inspect for damage immediately after striking an obstruction or foreign object. Repair damage before restarting.

**BUILT IN SAFETY FEATURES CAN BE
EFFECTIVE ONLY IF PROPERLY
MAINTAINED AND UTILIZED.**

ASSEMBLING

MOWER USING MFG. NO. 1690082 HITCH ASSEMBLY

1. See Figure 1. Bolt the rocker arm assembly in the lower holes of the mower brackets with two bolts, spacers, flat washers, lockwashers and nuts.
2. See Figure 1. Place shoulder bolts into rear holes of the rocker arm assemblies from the outside and install the eyebolt ends of the right and left leveling bars on the plain end of shoulder bolts and secure with lock pins.
3. See Figure 1. Install the mower driven pulley on the mower drive hub.

4. See Figure 1. Place the belt diagram film on the left arbor cover sheet.

5. See Figure 2. Fasten the rear of the right and left leveling bars to the outside of the leveling bracket ears with bolts, spacers, flat washers, lockwashers, and nuts.

6. See Figure 2. Bolt the discharge deflector to the left end of mower housing, slipping notch in front leg of deflector under mower housing, slipping notch in front leg of deflector under large flat washer on bolt "A" and installing bolt, flat washer, lockwasher and nut at holes "B" and "C".

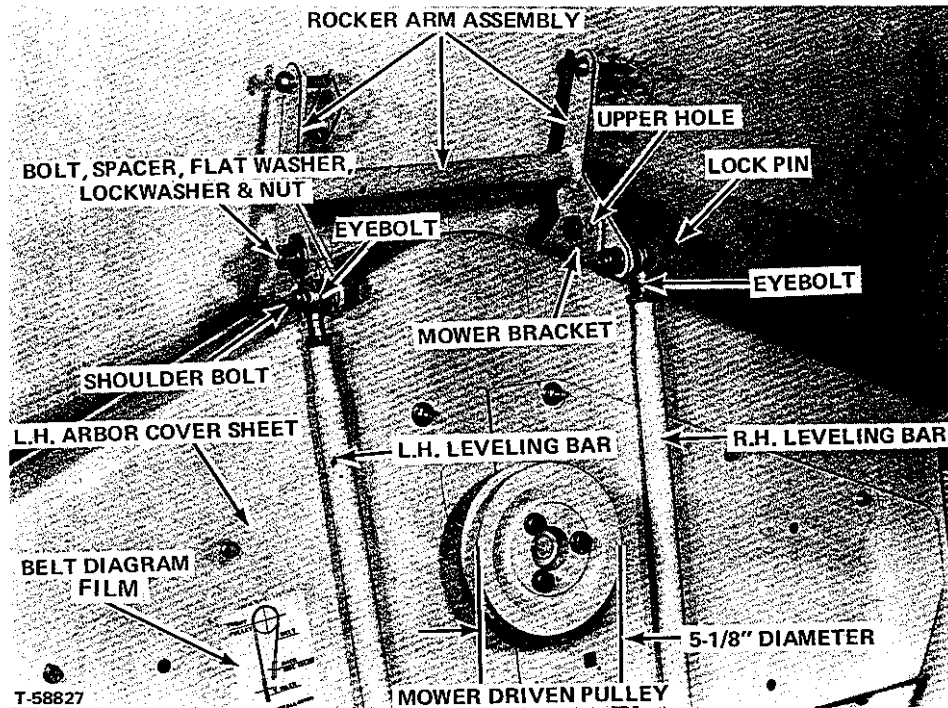

Figure 1.

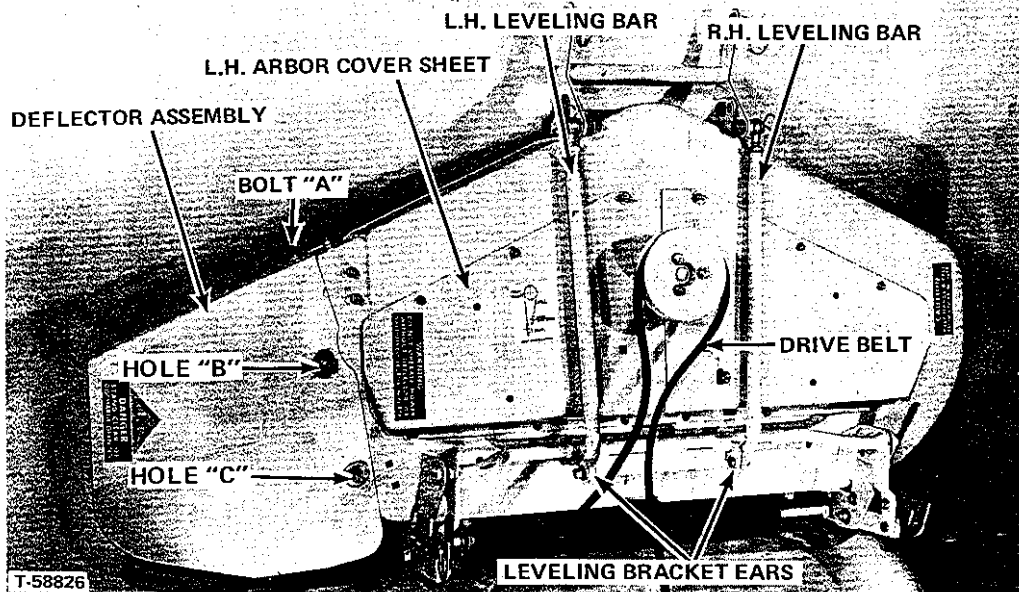

Figure 2.

MOWER USING MFG. NO. 1690083 HITCH ASSEMBLY

1. See Figure 5. Bolt rocker arm assembly in the upper holes of the mower brackets with bolts, spacers, flat washers, lockwashers and nuts.
2. See Figure 5. Place shoulder bolts in rear holes of rocker arm assembly and install eyebolts on front end of right and left leveling bars on plain end of shoulder bolts and secure with lock pins.
3. Install mower driven pulley on mower center arbor shaft with three capscrews and lockwashers. Tighten to 30 foot-pounds of torque.

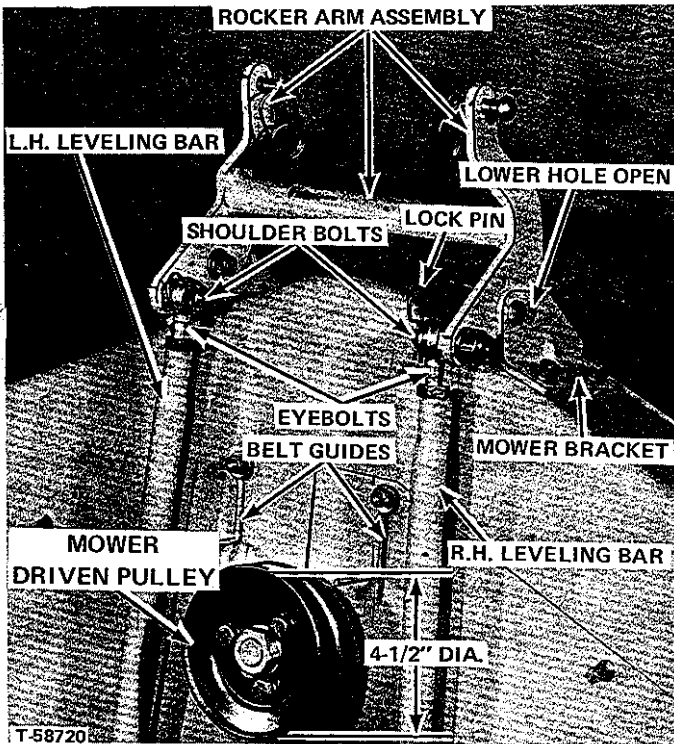

Figure 5.

4. See Figure 5. Install belt guides as shown.

5. See Figure 6. Fasten the rear of the right and left leveling bars to the inside of the leveling bracket ears. Bolt lower link of lift chain to lift eyebolt.

6. See Figure 6. Bolt the discharge deflector to the left end of mower housing, slipping notch in front leg of deflector under large flat washer on bolt "A" and installing bolt, flat washer, lockwasher and nut at holes "B" and "C".

MOWER TO TRACTOR USING MFG. NO. 1690083 HITCH ASSEMBLY

1. See Figures 5 and 7. Park the tractor on level ground with the mower positioned on either side. Turn the front wheels fully away from the mower to give clear access to the tractor under side. Slide the mower underneath the tractor, then straighten the front wheels. Attach the mower rocker arm assembly to the lower holes in tractor front hitch using round head pins and lock pins.

2. See Figure 7. Move the lift lever forward and attach the lift chain strap to the inner lift arm with pin and lock pin.

3. Disengage the tractor front power take off lever, (Figure 10), by pulling it all the way to rear. Place the mower drive belt around the mower drive pulley on the engine (Figure 9), then over the PTO idler pulleys at the front end of tractor. Put the free end of mower drive belt back over the mower driven pulley, (Figure 7). If the idler pulleys have belt guides position them as shown in (Figure 11).

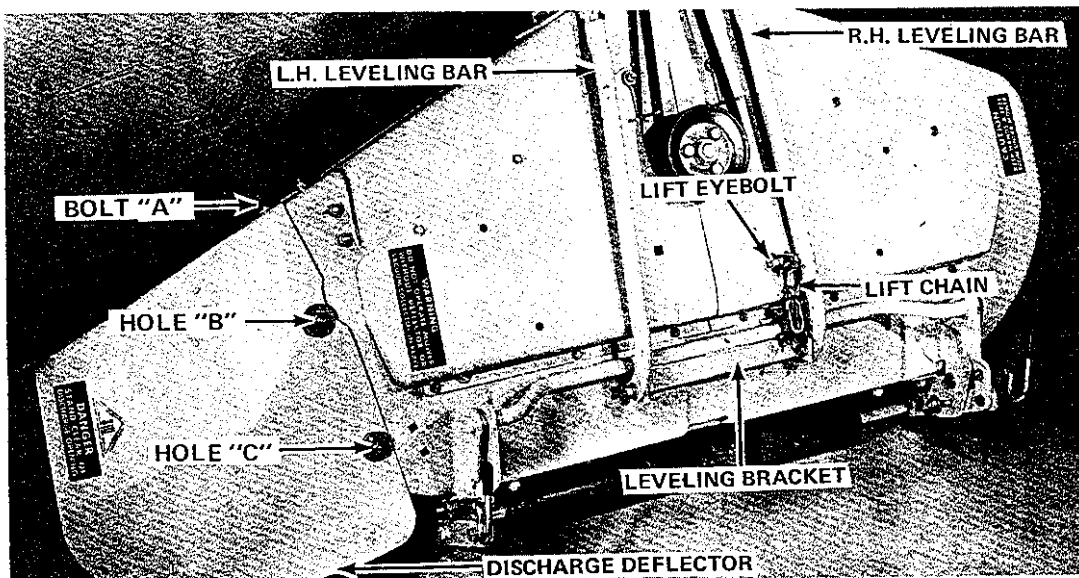

Figure 6.

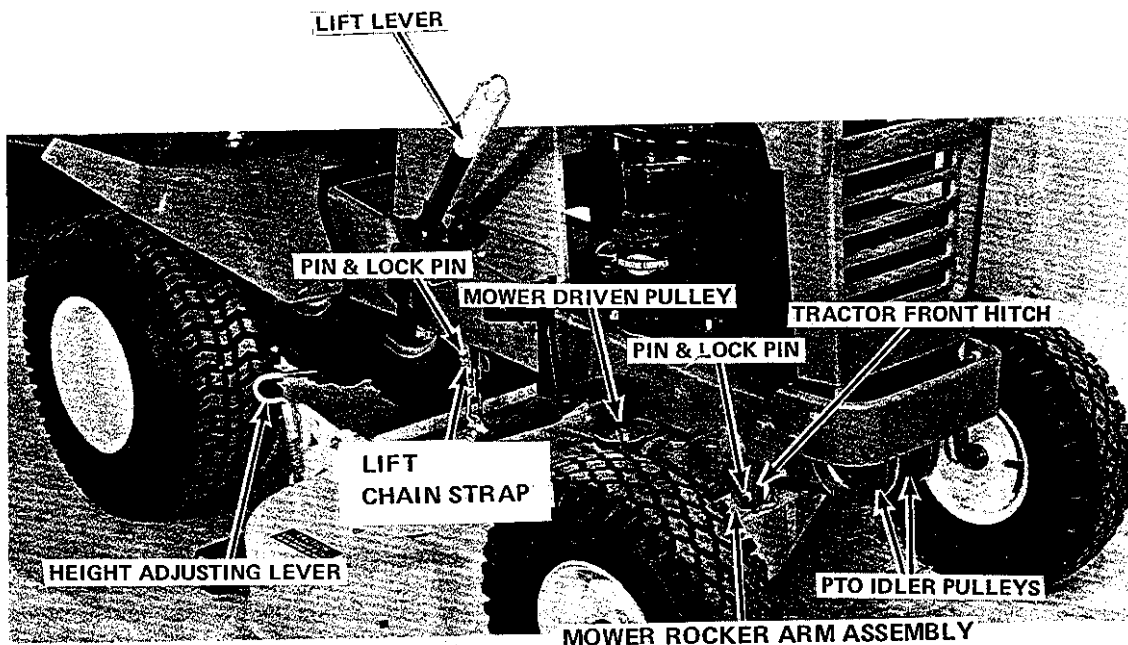

Figure 7.

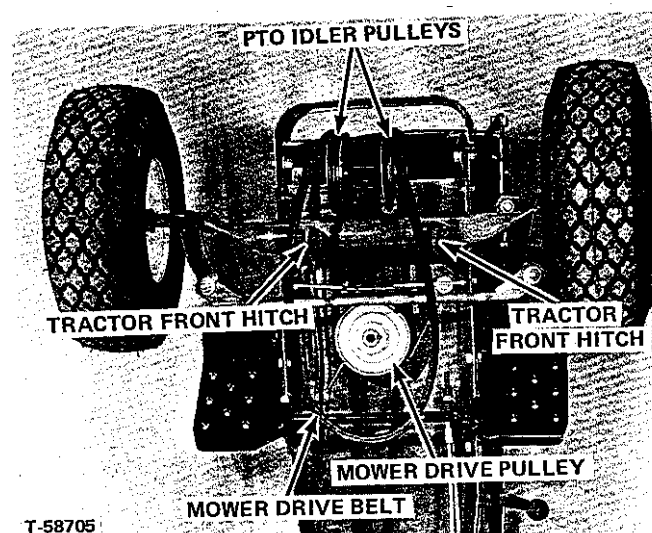

Figure 8.

NOTE: If the front PTO right idler pulley mounting bolt is loosened to permit moving the belt guide or for removing the idler, the actuating bracket for the front PTO safety start switch will probably move out of position and fail to actuate the switch.

The bracket, (See Figure 11), should be readjusted as follows every time the idler is loosened:

With right idler bolt only finger-tight pull PTO clutch lever fully to the rear disengaged position. Rotate the switch actuating bracket up against the safety start switch-button and hold it there with button depressed while idler pulley bolt is fully tightened.

Check that switch is actuated and will permit the starter motor to run when PTO lever is in rear, disengaged position.

4. Engage the power take off by pushing the PTO control lever to the forward position to put tension on belt. Swing the two belt guides forward at mower driven pulley and adjust them to within 1/8 inch of the belt (Figure 6).

5. Adjust set collar on the PTO clutch rod to provide 2-1/2 inches of spring length when PTO drive belt is on and clutch lever is in the forward, fully engaged, position (Figure 9).

NOTE: This adjustment should be made with mower at desired cutting height.

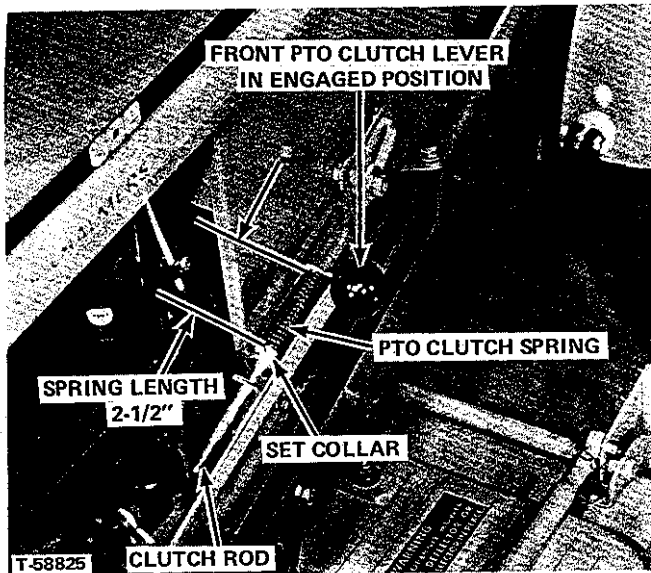

Figure 9.

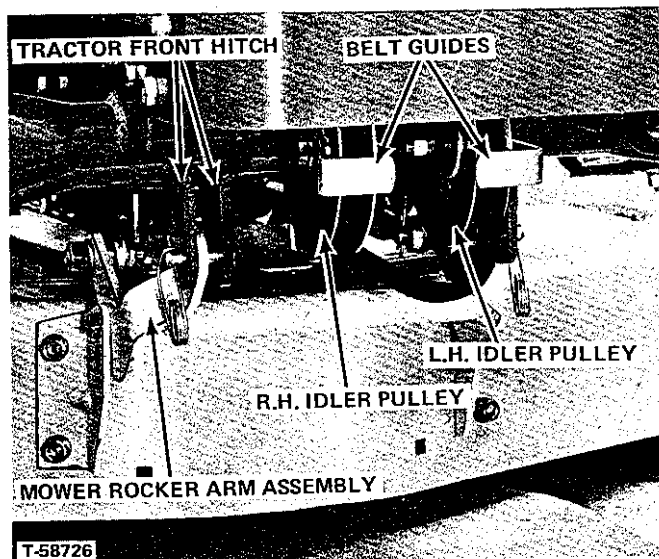

Figure 10

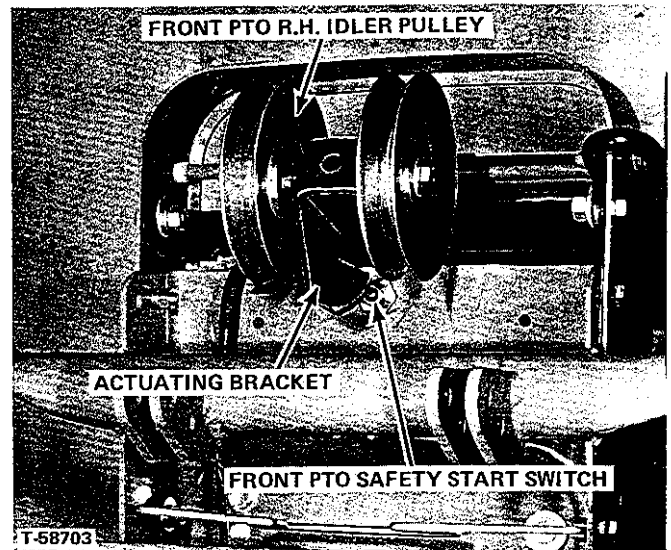

Figure 11.

REMOVING

MOWER WITH MFG. NO. 1690082 HITCH ASSEMBLY FROM TRACTOR

1. Position tractor and mower on a level solid surface with space for mower at left side of tractor.
2. Disengage the PTO lever and lower the belt tensioning lever (Figure 4). Loosen the bolt that holds the belt guide to the front idler and remove the drive belt from the tractor drive pulley and idlers and from the mower driven pulley.
3. Partially lower the mower with left lever and disconnect the mower rocker arm assembly from the tractor front hitch. Store the pins and lock pins in the mower rocker arm assembly.
4. Complete lowering the mower to the ground with the lift lever. Remove lock pin and pin holding lift clevis to lift anchor on top of mower.
5. Slide mower from under tractor on left side.

MOWER WITH MFG. NO. 1690083 HITCH ASSEMBLY FROM TRACTOR

1. Position tractor and mower on a level solid surface with space for mower at side of tractor.
2. With the PTO lever disengaged remove mower drive belt from mower drive pulley on engine and from PTO idler pulleys.

3. Lower the mower by pushing lift lever forward. Remove lock pin and pin from lift chain strap and lift arm (Figure 7). Store pin and lock pin in chain strap and leave with mower.

4. Disconnect the mower rocker arm assembly from the tractor front hitch and lower the mower to the ground. Store the pins and lock pins in the mower rocker arm assembly (Figure 10).

5. Slide mower from under tractor.

OPERATION

PREPARING

1. Read the mower and tractor operator manuals very carefully. Be sure you are familiar with the safety precautions, controls and operating instructions.

2. Check the mower carefully to be sure it is properly installed.

CAUTION

Never operate the mower unless the discharge guard and either the deflector assembly or the vacuum collector adapter are fastened securely in place.

3. Check the condition of mower blades. Keep them sharp and in balance.

4. Clear the lawn of all sticks, stones, wire and other debris which may be caught or thrown by the mower blade.

5. Be sure that mower is properly leveled and adjusted as outlined in adjustment section.

6. Refer to the tractor part of manual for starting engine.

OPERATING

1. Determine the best method of mowing according to the dimensions, terrain and obstructions of the lawn.

2. Most lawns should be mowed to keep the grass approximately two to three inches high. Best results are obtained by cutting often and not too short. To keep a green lawn, never mow more than one third off the height of the grass or a maximum of one inch in one mowing. For extremely tall grass, set the cutting height at maximum for the first mowing, then reset to the desired height and mow again. Allow the grass to grow to three inches, then cut off only the top inc.

3. On thick or springy grass or soft ground, the mower rollers may sink into the ground giving too low a cut. Adjust the cutting height to get the desired height of cut.

4. For best appearance, grass should be cut in the afternoon or evening when it is free of moisture.

5. Where possible change patterns occasionally to eliminate matting, graining and a corrugated appearance. See diagrams below.

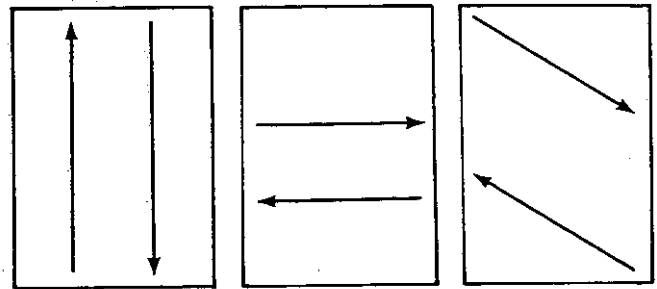

CAUTION

Do not work around mower housing area until you are certain that the mower blades have stopped rotating.

Heed the caution sign, the danger sign, and the warning sign located on the mower housing. Make certain the discharge guard and either the deflector assembly or the vacuum collector adapter are securely in place before operating the mower.

Always disconnect the mower drive clutch and stop engine before leaving the tractor seat. If leaving the tractor and mower unattended, remove the ignition key.

6. For the first use of the mower choose a smooth level area. Cut long straight strips overlapping slightly. After becoming familiar with the operation proceed to inclined or rougher ground.

7. The size and type of area to be mowed determines the best mowing pattern to use. Obstructions such as trees, fences, and buildings must also be considered. In most cases, making one or two passes in a counter-clockwise direction around the outside of the area to be mowed is advisable to keep cut grass off of fences, walks, etc. The remainder of the mowing should normally be done in a clockwise direction so the clippings are dispersed on the cut area.

8. Always keep the right side of mower toward trees, posts, or other obstacles on the first pass around obstacle.

9. On moderate size, frequently mowed lawns where grass is light and dry it is sometimes practical to mow in a counter-clockwise direction so that clippings are thrown toward the center of the lawn and concentrated for easy pickup and removal.

10. Engine speed should normally be operated at 2/3 to full throttle when mowing. When grass is wet or over 2 inches high, engine should be run at full speed for best results.

11. All forward speeds may be used for mowing under some conditions. Higher speeds should only be used in smooth level lawns with moderate to light grass crop. Always select a forward speed that is slow enough to assure that you can properly and safely control the tractor over the ground conditions encountered

CAUTION

When operating the mower for first time put the 3 speed transmission in first gear until you become acquainted with the controls and operation of the tractor and mower.

STORING

1. Remove the mower from the tractor. See Removing section of this manual.
2. Use water under pressure to thoroughly clean the mower to remove any buildup of grass clippings and dirt under the mower deck.
3. Cover any area where paint has been worn or chipped away with paint or a light coat of oil.
4. Lubricate each arbor grease fitting with about 5 shots of No. 2 lithium base gum grease.
5. Store the mower in a dry place.

ADJUSTMENTS

1. Check the tractor tire pressures and make them equal on right and left side.
2. See Figure 12. To adjust, turn the eyebolts on the front end of the leveling bars.
3. Turn both eyebolts to obtain the 1/8 to 1/4 inch difference in height from front tip to back tip. Turn only one eyebolt to obtain same height of the side blades for side-ways leveling.

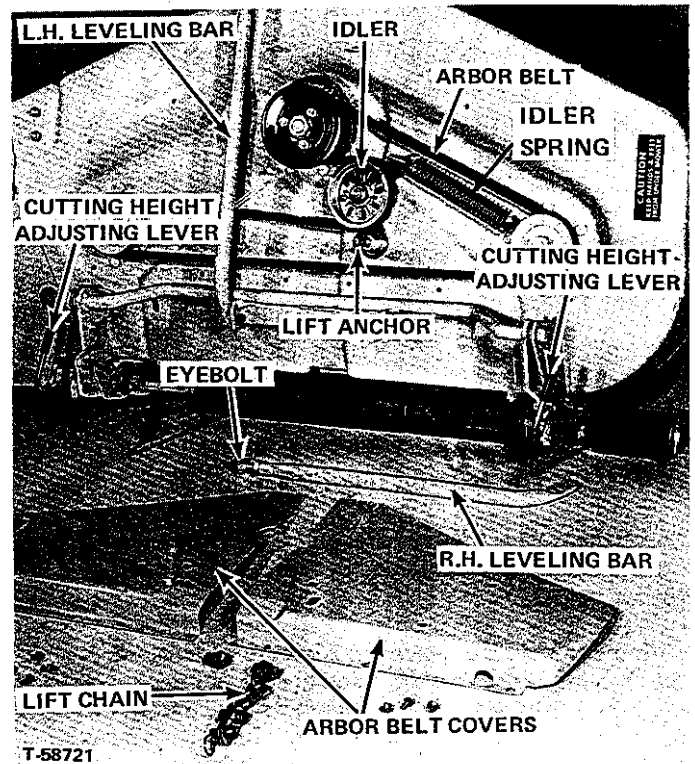

Figure 12.

4. Cutting height from 1-5/8 to 3=1/8 inches can be selected by adjusting the height control levers up or down. Turn the lever clockwise to raise the blades and counter-clockwise to lower them. The mowers have an adjusting lever on both sides of the mower. These should be turned the same number of turns to keep mower level from side to side.

5. A cutting height of approximately 2 inches is average and normal. The lower settings should be used only for smooth lawns where short grass is desired. The higher settings are for rougher areas or for very high grass.

6. See Figure 13. With the tractor and mower on a level surface rotate the three blades so that the blade tips are pointed toward the front of the mower. Measure the distance from the front tip of the center blade to the ground. Then measure the height of the rear tips of side blades. The front tip of center blade should be 1/4 inch higher than rear tip of side blades. The rear tips of right and left side blades should be the same distance above ground.

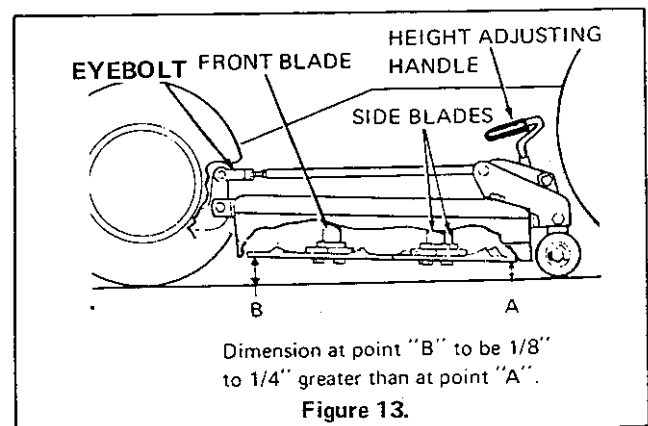

Figure 13.

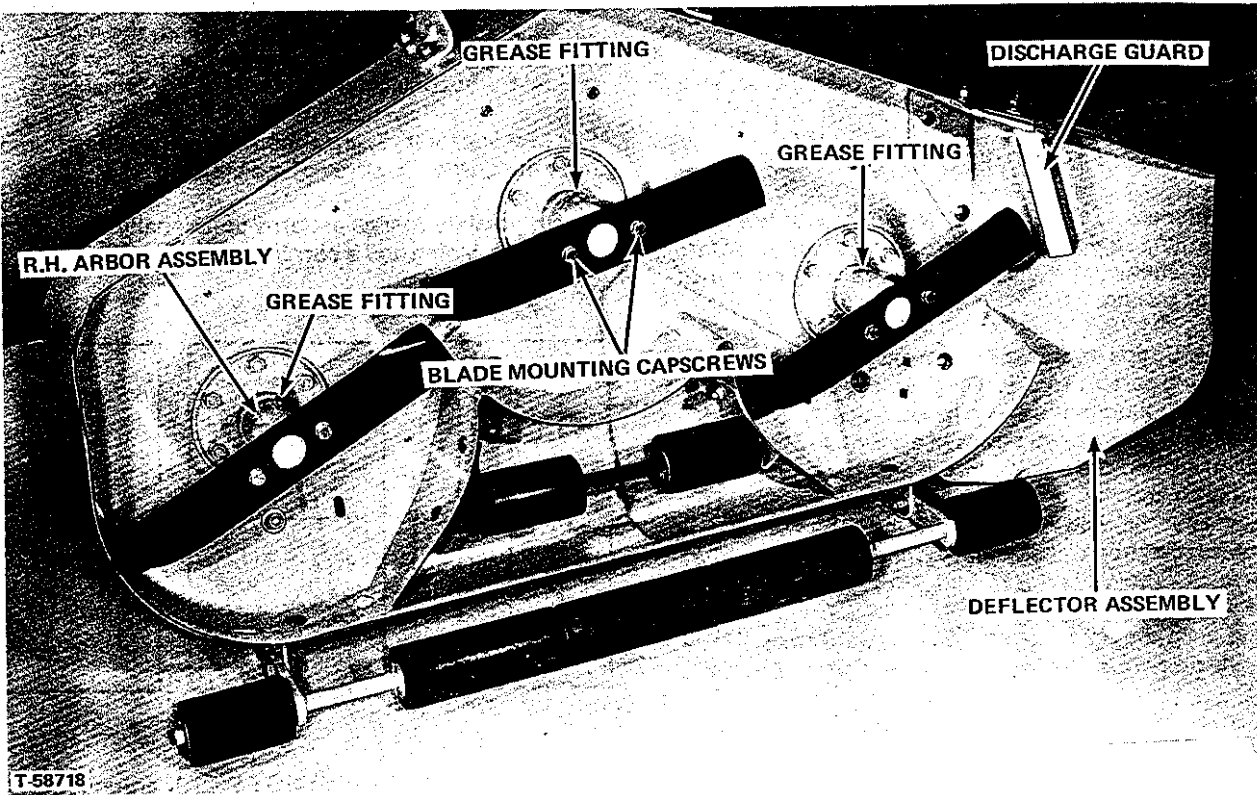

Figure 14.

MAINTENANCE

LUBRICATION

1. See Figure 14. The grease fittings in each of the arbor assemblies, should be given about five shots of No. 2 lithium base gum grease every 50 hours of operation and at the end of cutting season.
2. Do not overgrease. Make sure that any excess grease forced out of the mower arbor assemblies does not get on the drive belts.

BLADE REPLACEMENT (See Figure 14)

1. Do not attempt to remove the blades unless you have the correct size wrench to fit the blade mounting capscrews. Remove mower from tractor and turn it over to expose the blades.
2. To remove or install the blades, securely wedge a block of wood between the blade and the housing in such position that it will hold the blade safely while loosening or tightening the blade mounting capscrews.
3. Do not attempt to remove the arbor assemblies. Take out blade mounting capscrews only.

CAUTION

Always handle the blade with care to avoid injury.

4. To sharpen blade clamp blade securely in a vise and use a large mill file along the original bevel. File to a sharp edge.
5. To balance blade, place a small rod through center hole of blade to see if blade rests with both ends balancing evenly. File heavy side of blade until blade balances.
6. Carefully clean the blades and arbors. Install the new or sharpened blades with the lift tabs toward the top and tighten the capscrews securely. Use a block or wedge to keep the blade from turning while tightening capscrew.

NOTE: The mower blade retining capscrews should be torqued to 32 foot-pounds.

7. Rotate the blades slowly by hand to see that they clear the housing all around and that the blade tips are running true.

BELT REPLACEMENT ON 10,13 and 16 H.P. Vehicles

1. To replace the mower drive belt, stop the engine, fully disengage the PTO drive clutch. Push the belt tensioning lever (Figure 4) fully downward to loosen drive belt idlers. Remove the belt from the drive pulley on the tractor and from the driven pulley on the mower. Reinstall a new belt in reverse order.

2. To replace the arbor drive belt, remove the mower from the tractor, then remove the arbor belt covers by removing bolts that hold them to mower deck and the pin that holds the lift cable clevis to the lift anchor of the mower.

3. Remove the right hand leveling bar to permit lifting right arbor cover over the lift anchor (Figure12). 13

4. Unhook idler spring from idler and remove belt from arbor pulleys. Install new belt as shown in Figure. 12. 3

5. Reinstall both arbor belt covers and hook up leveling bars.

BELT REPLACEMENT (on 8 H.P. Vehicles)

1. To replace the mower drive belt, stop the engine and fully disengage the PTO drive clutch. Remove the belt from the drive pulley on the engine and from the driven pulley on the mower. Reinstall new belt in reverse order. pulleys and remove belt.

2. To replace arbor drive belt, refer to steps 2 through 5 of BELT REPLACEMENT ON 10,13 and 16 h.p. vehicles.

Free Manuals Download Website

<http://myh66.com>

<http://usermanuals.us>

<http://www.somanuals.com>

<http://www.4manuals.cc>

<http://www.manual-lib.com>

<http://www.404manual.com>

<http://www.luxmanual.com>

<http://aubethermostatmanual.com>

Golf course search by state

<http://golfingnear.com>

Email search by domain

<http://emailbydomain.com>

Auto manuals search

<http://auto.somanuals.com>

TV manuals search

<http://tv.somanuals.com>