

SNAPPER™

by
2300PSI
Pressure Washer

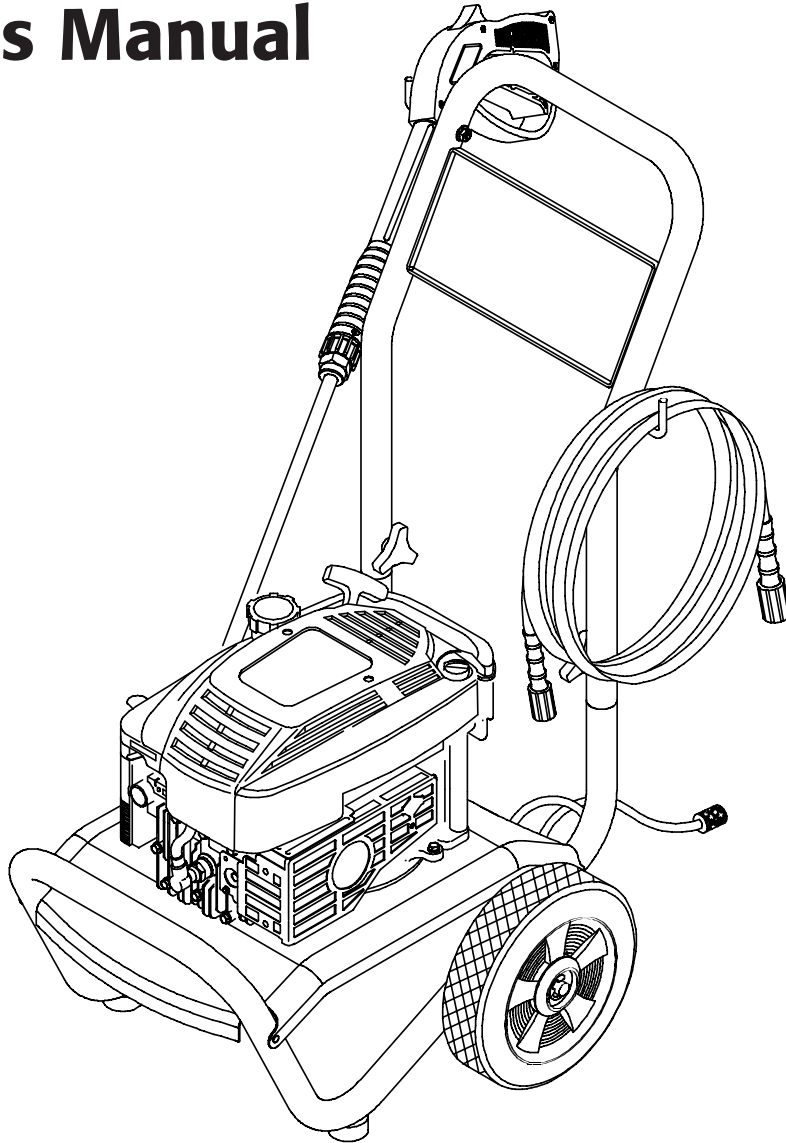

Owner's Manual



Questions? Help is just a moment away!
Helpline - 1-800-317-7833 M-F 8-5 CT

This Snapper™ product is distributed under license to Briggs & Stratton Power Products.

BRIGGS & STRATTON POWER PRODUCTS GROUP, LLC
JEFFERSON, WISCONSIN, U.S.A.

Model No. 1807-0 (2300 PSI Pressure Washer) Manual No. 191333GS Revision 0 (12/18/2002)



TABLE OF CONTENTS

Safety Rules	2-3
Know Your Pressure Washer	4
Assembly	5-7
Operation	8-10
Product Specifications	11
Maintenance	11-13
Storage	14
Troubleshooting	15
Replacement Parts	16-17
Notes	18-19
Warranty	Last Page

EQUIPMENT DESCRIPTION

 **Read this manual carefully and become familiar with your generator. Know its applications, its limitations and any hazards involved.**

Every effort has been made to ensure that information in this manual is accurate and current. However, Snapper reserves the right to change, alter or otherwise improve the product and this document at any time without prior notice.

SAFETY RULES

 **This is the safety alert symbol. It is used to alert you to potential personal injury hazards. Obey all safety messages that follow this symbol to avoid possible injury or death.**

The safety alert symbol () is used with a signal word (DANGER, CAUTION, WARNING), a pictorial and/or a safety message to alert you to hazards. **DANGER** indicates a hazard which, if not avoided, will result in death or serious injury. **WARNING** indicates a hazard which, if not avoided, could result in death or serious injury. **CAUTION** indicates a hazard which, if not avoided, might result in minor or moderate injury. **CAUTION**, when used **without** the alert symbol, indicates a situation that could result in equipment damage. Follow safety messages to avoid or reduce the risk of injury or death.

In the State of California a spark arrester is required by law (Section 4442 of the California Public Resources Code). Other states may have similar laws. Federal laws apply on federal lands. If you equip the muffler with a spark arrester, it must be maintained in effective working order.

 **WARNING**

The engine exhaust from this product contains chemicals known to the State of California to cause cancer, birth defects, or other reproductive harm.

 **DANGER**

 Running engine gives off carbon monoxide, an odorless, colorless, poison gas.

Some chemicals or detergents may be harmful if inhaled or ingested, causing severe nausea, fainting or poisoning.

Breathing carbon monoxide will cause nausea, fainting or death.

- Operate pressure washer **ONLY** outdoors.
- Use a respirator or mask whenever there is a chance that vapors may be inhaled.
- Read all instructions with mask so you are certain the mask will provide the necessary protection against inhaling harmful vapors.

 **WARNING**

 Spray contact with electrical wiring can result in electrocution.

- Keep water spray away from electric wiring or fatal electric shock may result.

 **WARNING**

 Use of pressure washer can create puddles and slippery surfaces.

 High pressure spray could cause you to fall if you are too close to the cleaning surface.

- Keep spray nozzle between 8 to 24 inches away from cleaning surface.
- Operate this unit on a stable surface.
- The cleaning area should have adequate slopes and drainage to reduce the possibility of a fall due to slippery surfaces.
- Be extremely careful if you must use the pressure washer from a ladder, scaffolding or any other relatively unstable location.
- Firmly grasp spray gun with both hands when using high pressure spray to avoid injury if gun kicks back.

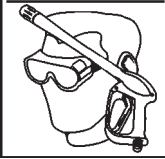
SAFETY RULES**Snapper 2300 PSI Pressure Washer****WARNING**

Fuel and its vapors are extremely flammable and explosive.



Fire or explosion can cause severe burns or death.

WHEN ADDING FUEL

- Turn pressure washer OFF and let it cool at least 2 minutes before removing gas cap.
- Fill fuel tank outdoors.
- DO NOT overfill tank. Allow space for fuel expansion.
- Keep fuel away from sparks, open flames, pilot lights, heat, and other ignition sources.
- DO NOT light a cigarette or smoke.

WHEN OPERATING EQUIPMENT

- DO NOT tip engine or equipment at angle which causes fuel to spill.
- DO NOT spray flammable liquids.

WHEN TRANSPORTING OR REPAIRING EQUIPMENT

- Transport/repair with fuel tank EMPTY or with fuel shutoff valve OFF.

WHEN STORING FUEL OR EQUIPMENT WITH FUEL IN TANK

- Store away from furnaces, stoves, water heaters, clothes dryers or other appliances that have pilot light or other ignition source because they can ignite fuel vapors.

WARNING

The high pressure stream of water that this equipment produces can pierce skin and its underlying tissues, leading to serious injury and possible amputation.

- NEVER aim the spray gun at people, animals or plants.
- DO NOT allow CHILDREN to operate the pressure washer.
- NEVER repair high pressure hose. Replace it.

WARNING

Running engines produce heat. Temperature of muffler and nearby areas can reach or exceed 150°F (65°C).

Severe burns can occur on contact.

- DO NOT touch hot surfaces.
- Allow equipment to cool before touching.

WARNING

Starter and other rotating parts can entangle hands, hair, clothing, or accessories.

- DO NOT wear loose clothing, jewelry or anything that may be caught in the starter or other rotating parts.
- Tie up long hair and remove jewelry.

WARNING

High pressure spray can cause paint chips or other particles to become airborne.

- Always wear eye protection when you use this equipment or when you are in the vicinity where the equipment is in use.

WARNING

Unintentional sparking can result in fire or electric shock.

**WHEN ADJUSTING OR MAKING REPAIRS TO YOUR PRESSURE WASHER**

- Disconnect the spark plug wire from the spark plug and place the wire where it cannot contact spark plug.

CAUTION

Excessively high or low operating speeds increase risk of injury and damage to pressure washer.

- DO NOT tamper with governed speed.
- DO NOT operate the pressure washer above the rated pressure.

CAUTION

High pressure spray may damage fragile items including glass.

- DO NOT point spray gun at glass when in the jet spray mode.
- NEVER aim the spray gun at plants.

KNOW YOUR PRESSURE WASHER

Read this owner's manual and safety rules before operating your pressure washer.

Compare the illustrations with your pressure washer to familiarize yourself with the locations of various controls and adjustments. Save this manual for future reference.

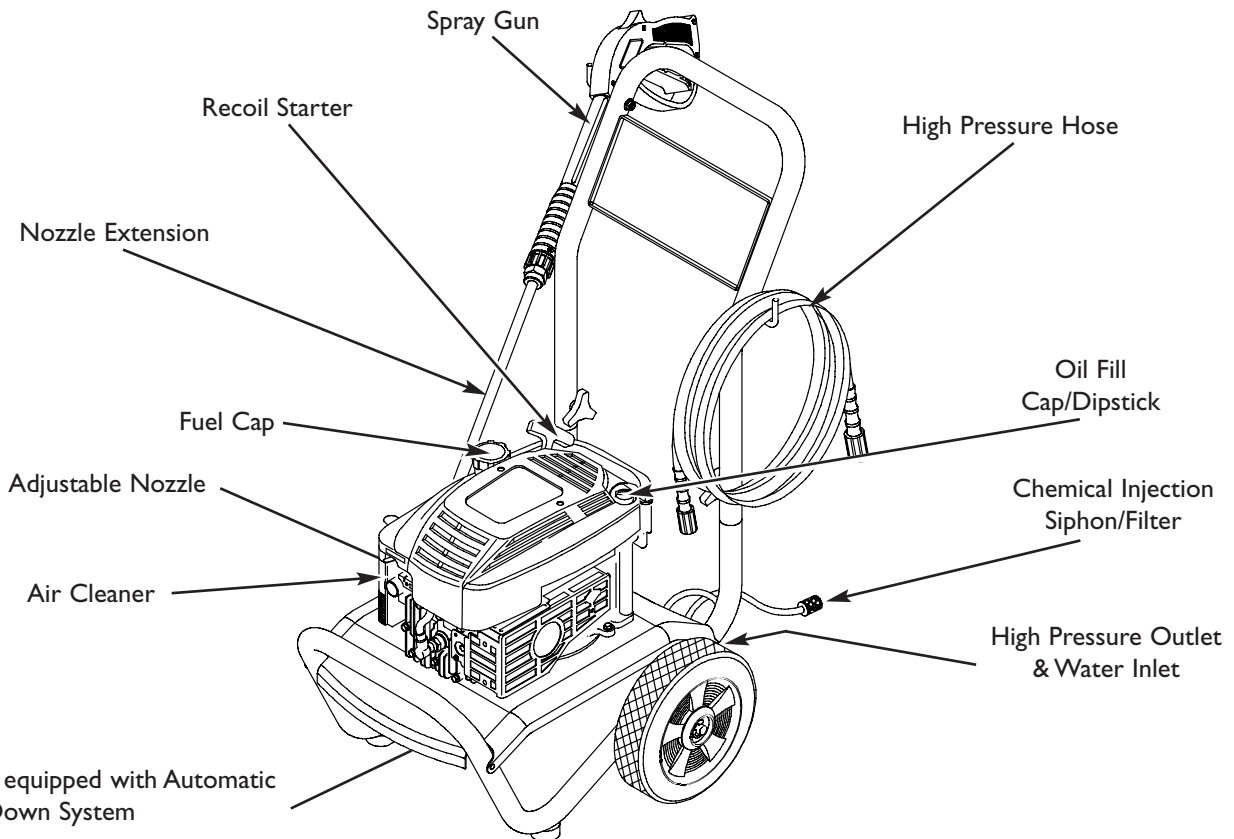

Adjustable Nozzle — Always attached to nozzle extension. Adjustable nozzle allows you to adjust force of spray and spray pattern.

Air Cleaner — Dry type filter element limits the amount of dirt and dust that gets in the engine.

Automatic Cool Down System — Cycles water through pump when water reaches 125°-155°F. **Warm water will discharge from pump onto ground.** This system prevents internal pump damage.

Chemical Injection Siphon/Filter — Use to siphon detergent or other pressure washer chemicals into the low pressure stream.

Data Tag (not shown, near rear of base plate) — Provides model, revision and serial number of pressure washer. Please have these readily available if calling for assistance.

Fuel Cap — Fill with clean unleaded fuel here.

High Pressure Hose — Connect one end to water pump and the other end to spray gun.

High Pressure Outlet — Connection for pressure hose.

Nozzle Extension — Attach to spray gun to use adjustable nozzle.

Oil Fill Cap/Dipstick — Used for checking and adding oil.

Pump — Develops high pressure.

Recoil Starter — Used for starting the engine manually.

Spray Gun — Controls the application of water onto cleaning surface with trigger device. Includes safety latch.

Water Inlet — Connection for garden hose.

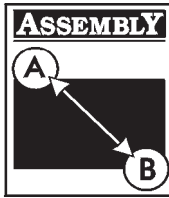

IMPORTANT: Read entire owner's manual before you attempt to assemble or operate your new pressure washer.

REMOVE PRESSURE WASHER FROM CARTON

- Remove the parts bag included with pressure washer.
- Slice two corners at the end of carton from top to bottom so the panel can be folded down flat, then remove all packing material.
- Remove pressure washer from carton.

Carton Contents

Check all contents.

- Main unit
- Engine Oil
- Safety Goggles
- High Pressure Hose
- Spray Gun
- Nozzle Extension
- Parts Bag (which includes the following):
 - Owner's Manual
 - Engine Manual
 - Owner's Registration Card
 - Maintenance Kit
 - Handle Fastening Hardware Kit (which includes):
 - Carriage Bolts (2)
 - Plastic Knobs (2)
 - "L" Hooks (2)
 - Lock Nuts (2)

PREPARING PRESSURE WASHER FOR USE

If you have any problems with the assembly of your pressure washer or if parts are missing or damaged, call the pressure washer helpline at **1-800-317-7833**. If calling for assistance, please have the model, revision, and serial number from the data tag available.

To prepare your pressure washer for operation, you will need to perform these tasks:

- Fill out and send in registration card.
- Add oil to the engine crankcase.
- Add fuel to the fuel tank.
- Connect the high pressure hose to the spray gun and the pump.
- Connect the water supply to the pump.
- Attach nozzle extension to spray gun.

Attach Handle

1. Place the handle assembly onto the handle supports connected to the main unit. Make sure the holes in the handle align with the holes on the handle supports (Figure 1).

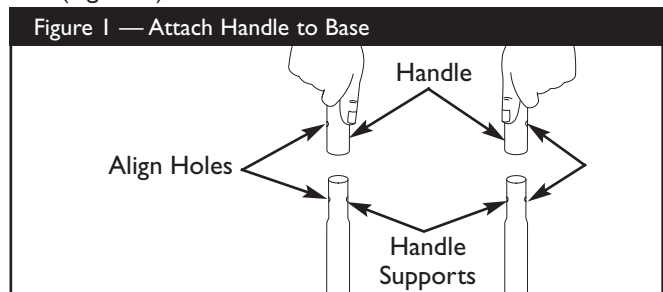

NOTE: It may be necessary to move the handle supports from side to side in order to align the handle so it will slide over the handle supports.

2. Insert the carriage bolts through the holes from the outside of the unit and attach a plastic knob from the inside of the unit (Figure 2). Tighten by hand.

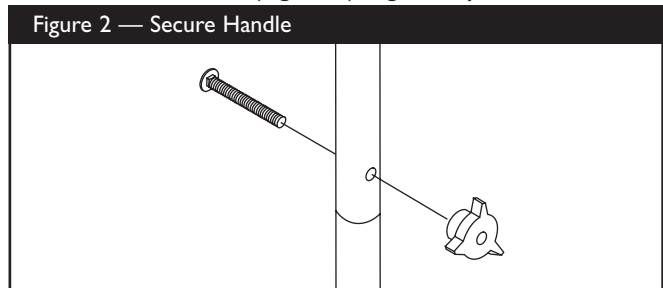

3. Insert one of the "L" hooks through the hole just under the billboard on the left side of the handle (viewing from rear of unit). Hold the hook in place with a pliers and attach the locknut with a 7/16" wrench (Figure 3).

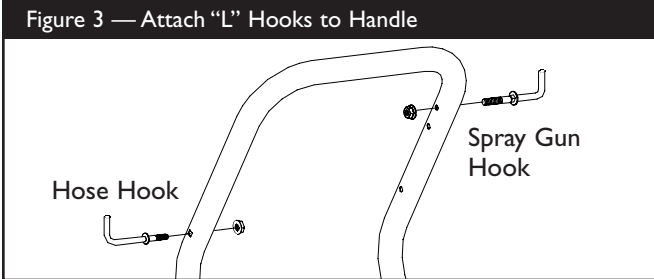
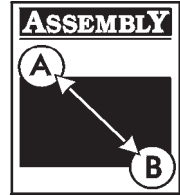

4. Insert the other “L” hook through the hole just above the billboard on the right side of the handle (viewing from rear of unit). Hold the hook in place with a pliers and attach the locknut with a 7/16” wrench (Figure 3).

Add Engine Oil

IMPORTANT: Any attempt to crank or start the engine before it has been properly serviced with the recommended oil may result in an engine failure.

- Place pressure washer on a level surface.
- Refer to engine owners manual to add recommended oil to engine.

NOTE: Check Oil Often During Engine Break-in.

Add Fuel

WARNING! NEVER fill fuel tank indoors. NEVER fill fuel tank when engine is running or hot. Allow unit to cool for two minutes before refueling. DO NOT light a cigarette or smoke when filling the fuel tank.

WARNING! DO NOT overfill the fuel tank. Always allow room for fuel expansion.

- Place pressure washer on a level surface.
- Refer to engine owners manual to add recommended fuel to engine.

Connect Hose and Water Supply to Pump

IMPORTANT: To avoid pump damage, you must assemble the nozzle extension to the spray gun and attach all hoses before you start the engine.

- Uncoil the high pressure hose and attach one end of the hose to the base of the spray gun (Figure 3). Tighten by hand.

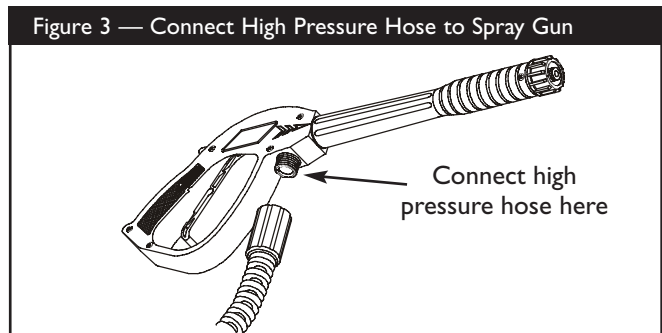

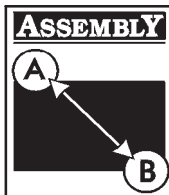

Snapper 2300 PSI Pressure Washer



- Attach the other end of the high pressure hose to the high pressure outlet on the pump (Figure 4). Tighten by hand.

Figure 4 — Connect High Pressure Hose to Pump

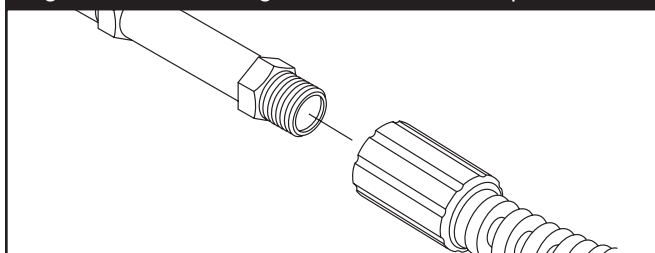

- Before you connect your garden hose to the water inlet, inspect the inlet screen (Figure 5). Clean the screen if it contains debris or have it replaced if damaged. **DO NOT RUN THE PRESSURE WASHER IF THE SCREEN IS DAMAGED.**

Figure 5 — Connect the Garden Hose to Water Inlet

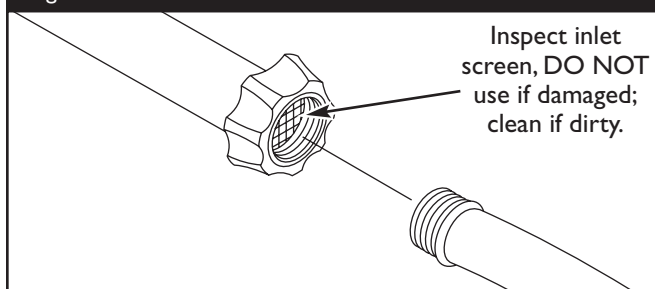

- Run water through your garden hose for 30 seconds to clean out any debris.

IMPORTANT: DO NOT siphon standing water for the water supply. Use **ONLY** cold water (less than 100°F).

- Connect the garden hose (not to exceed 50 feet in length) to the water inlet. Tighten by hand (Figure 5).

CAUTION! There **MUST** be at least ten feet of unrestricted garden hose between the pressure washer inlet and any flow shut off device, such as a 'Y' shut-off connector or other convenience-type water shut-off valve. Damage to pressure washer resulting from disregarding this warning will not be covered by the warranty.

- Turn **ON** the water and squeeze the trigger on the gun to purge the pump system of air and impurities.

CAUTION! Before starting the pressure washer, be sure you are wearing adequate eye protection.

CHECKLIST BEFORE STARTING ENGINE

Review the unit's assembly to ensure you have performed all of the following.

- Make sure the handle is in place and secure.
- Check that oil has been added to the proper level in the engine crankcase.
- Add the proper fuel to fuel tank.
- Check for properly tightened hose connections (high pressure and water supply) and that there are no kinks, cuts, or damage to the high pressure hose.
- Provide a proper water supply at an adequate flow.
- Be sure to read "Safety Rules" and "How To Use Your Pressure Washer" before using the pressure washer.



HOW TO USE YOUR PRESSURE WASHER

If you have any problems operating your pressure washer, please call the pressure washer helpline at **1-800-317-7833**.

How to Start Your Pressure Washer

To start your pressure washer for the first time, follow these instructions step-by-step. This starting information also applies if you have let the pressure washer sit idle for at least a day.

- Place the pressure washer near an outside water source capable of supplying water at a flow rate greater than 3.0 gallons per minute and no less than 20 PSI at the pressure washer end of the garden hose.
- Check that the high pressure hose is tightly connected to the spray gun and to the pump. See “Preparing Pressure Washer for Use” for illustrations.
- Make sure unit is in a level position.
- Connect the garden hose to the water inlet on the pressure washer pump. **Turn ON the water.**

CAUTION! DO NOT run the pump without the water supply connected and turned on. You must follow this caution or the pump will be damaged.

- Squeeze the trigger on the spray gun until you have a steady stream of water. This purges the pump of air and impurities.
- Attach the adjustable nozzle extension to the spray gun (Figure 6). Tighten by hand.

Figure 6 — Connect Nozzle Extension to Spray Gun

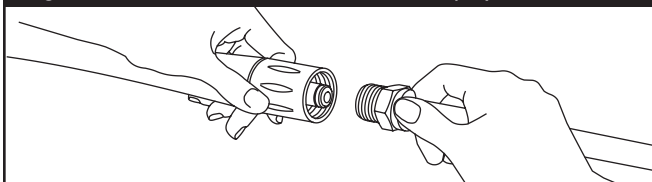

- Position the nozzle in the low pressure mode (see “How to Use the Adjustable Nozzle”) and squeeze the trigger on the spray gun to relieve the air pressure caused by turning ON the water. Water will flow out of the spray gun in a thin stream. Continue to hold trigger until there is a steady stream of water and no air remains in the system. This will make it easier to pull start the engine. Release the trigger.
- Engage the safety latch to the spray gun trigger (Figure 7).

Figure 7 — Spray Gun with Safety Latch Engaged

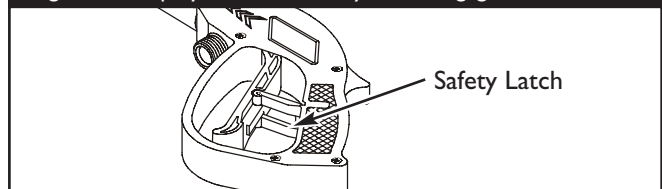

- Start the engine according to instructions given in the engine owner’s manual.

NOTE: Always keep the throttle lever in the “Fast” position when operating the pressure washer.

NOTE: If the recoil starter is hard to pull, squeeze the spray gun trigger to relieve internal pump pressure.

How to Stop Your Pressure Washer

- Let the engine idle for two minutes.
- Turn engine off according to instructions given in the engine owner’s manual.
- **Squeeze trigger on the spray gun to relieve pressure in the hose.**

NOTE: A small amount of water will squirt out when you release the pressure.



How to Use the Adjustable Nozzle

You now should know how to **START** your pressure washer and how to **STOP** it. The information in this section will tell you how to adjust the spray pattern and to apply detergent or other cleaning chemicals.

WARNING! NEVER adjust spray pattern when spraying. NEVER put hands in front of nozzle to adjust spray pattern.

- Slide the nozzle forward when you wish to adjust the spray to low pressure mode (Figure 10). Slide the nozzle backward to achieve high pressure.

Figure 10 — Adjusting Nozzle for Pressure

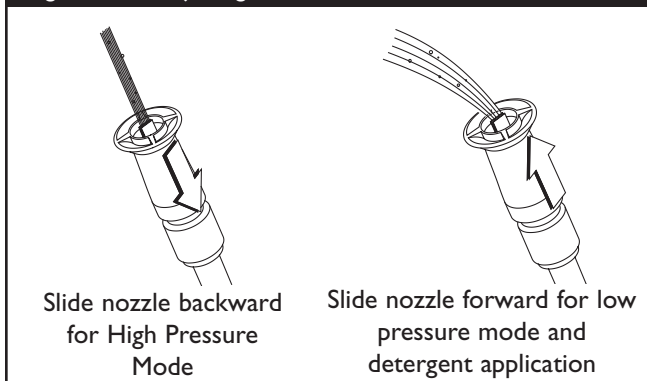

- Point the nozzle down towards a firm surface and press the trigger to test the pattern (Figure 11).

Figure 11 — Testing the Spray Pattern



- Twisting the nozzle adjusts the spray pattern from a narrow pattern to a fan pattern (Figure 12).

Figure 12 — Adjusting the Nozzle for Spray Pattern

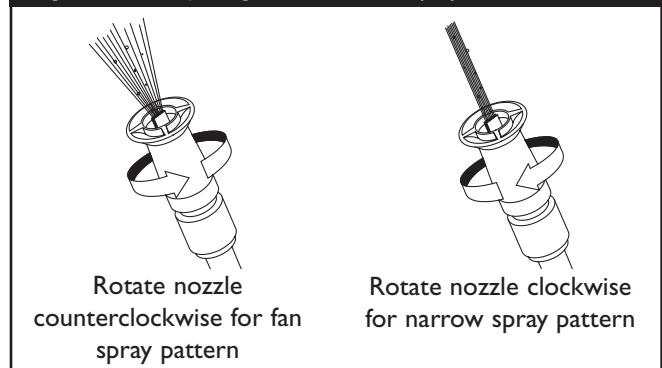

- For most effective cleaning, keep spray nozzle from 8 to 24 inches away from cleaning surface.
- If you get the spray nozzle too close, especially using high pressure mode, you may damage the surface being cleaned.
- DO NOT get closer than 6 inches when cleaning tires.

Applying Detergent with the Adjustable Nozzle

IMPORTANT: Use soaps designed specifically for pressure washers. Household detergents could damage the pump.

CAUTION! You must **attach all hoses** before you start the engine. Starting the engine without all the hoses connected and without the water turned ON will damage the pump.

To apply detergent, follow these steps:

- Review the use of adjustable nozzles.
- Prepare the detergent solution as required by the job.
- Place the filter end of the detergent siphoning tube into the detergent container.

CAUTION! Keep the detergent siphoning tube from coming in contact with the hot muffler.

- Slide the adjustable nozzle forward to low pressure mode. Detergent cannot be applied with the nozzle in high pressure position.



- Make sure the garden hose is connected to the water inlet. Check that the high pressure hose is connected to the spray gun and the pump. Start the engine.
- Apply the detergent to a dry surface, starting at lower portion of area to be washed and work upward, using long, even, overlapping strokes.
- Allow the detergent to "soak in" for 3-5 minutes before washing and rinsing. Reapply as needed to prevent surface from drying. DO NOT allow the detergent to dry on (prevents streaking).

IMPORTANT: You must flush the chemical injection system after each use by placing the filter into a bucket of clean water; then run the pressure washer in low pressure for 1-2 minutes.

Pressure Washer Rinsing

 **WARNING!** Be extremely careful if you must use the pressure washer from a ladder, scaffolding or any other relatively unstable location. When you press the trigger, the recoil from the initial spray could cause you to fall. The high pressure spray could also cause you to fall if you are too close to the cleaning surface.

For Rinsing:

- Slide the nozzle backward to high pressure, press the trigger and wait for the detergent to clear.



CAUTION! Firmly grasp spray gun with both hands when using high pressure spray to avoid injury if gun kicks back.

NOTE: You can also stop detergent from flowing by simply removing detergent siphoning tube from bottle.

- Keep the spray gun a safe distance from the area you plan to spray.
- Apply a high pressure spray to a small area, then check the surface for damage. If no damage is found, it is okay to continue cleaning.
- Start at the top of the area to be rinsed, working down with same overlapping strokes as you used for washing and applying detergent.

Automatic Cool Down System (Thermal Relief)

If you run the engine on your pressure washer for 3-5 minutes without pressing the trigger on the spray gun, circulating water in the pump can reach a temperature between 125°–155°F. When the water reaches this temperature, the automatic cool down system engages and cools the pump by **discharging the warm water onto the ground**. This system prevents internal damage to the pump.



Snapper 2300 PSI Pressure Washer



SPECIFICATIONS

- Outlet Pressure** 2300 psi
- Flow Rate** 2.0 gallons per minute (gpm)
- Detergent** Use detergent approved for pressure washers
- Water Supply Temperature** Not to Exceed 100°F
- Automatic Cool Down System** Will cycle when water reaches 125°-155°F
- Shipping Weight** 64 lbs.

GENERAL MAINTENANCE RECOMMENDATIONS

The pressure washer warranty does not cover items that have been subjected to operator abuse or negligence. To receive full value from the warranty, the operator must maintain the pressure washer as instructed in this manual.

- Some adjustments will need to be made periodically to properly maintain your pressure washer.
- All maintenance in this manual and the engine owner’s manual should be made at least once each season.
- Once a year you should clean or replace the spark plug, clean or replace the air filter and check the spray gun and adjustable nozzle extension assembly for wear. A new spark plug and clean air filter assure proper fuel-air mixture and help your engine run better and last longer. Please refer to your engine owner’s manual for more details.
- If equipped with inflatable tires, keep the air pressure at the value marked on the tire or within 15 and 40 psi.

Before Each Use

- Check engine oil level.
- Check water inlet screen for damage.
- Check in-line filter for damage.
- Check high pressure hose for leaks.
- Check detergent siphoning tube and filter for damage.
- Check spray gun and adjustable nozzle extension assembly for leaks.
- Rinse out garden hose to flush out debris.

PRESSURE WASHER MAINTENANCE

Check and Clean Inlet Screen

Examine the screen on the water inlet. Clean it if the screen is clogged or replace it if screen is damaged.

Check High Pressure Hose

The high pressure hose can develop leaks from wear, kinking, or abuse. Inspect the hose each time before using it. Check for cuts, leaks, abrasions or bulging of cover, damage or movement of couplings. If any of these conditions exist, replace the hose immediately.

WARNING! NEVER repair a high pressure hose. Replace it with another hose that exceeds the maximum pressure rating of your pressure washer.

Check Detergent Siphoning Tube

Examine the filter on the detergent tube and clean if clogged. The tube should fit tightly on the barbed fitting. Examine the tube for leaks or tears. Replace the filter or tube if either is damaged.

Check Gun and Adjustable Nozzle Extension

Examine the hose connection to the spray gun and make sure it is secure. Test the trigger by pressing it and making sure it “springs back” into place when you release it. Put the safety latch in the **ON** position and test the trigger. You should not be able to press the trigger.

Purge Pump of Air and Contaminants

To remove air from the pump, follow these steps:

- Set up the pressure washer as described in “Preparing Pressure Washer For Use”. Connect the water supply and turn water on.
- Pull the trigger on the spray gun and hold.
- When the water supply is steady and constant, engage the safety latch.

To remove contaminants from the pump, follow these steps:

- Set up the pressure washer as described in “Preparing Pressure Washer For Use”. Connect the water supply and turn water on.
- Remove the nozzle extension from the spray gun.
- Start the engine according to instructions in “How To Use Your Pressure Washer”.
- Squeeze the trigger on the spray gun and hold.
- When the water supply is steady and constant, engage the safety latch and refasten the nozzle extension.

Check In-Line Filter

Refer to Figure 13 and service the in-line filter if it becomes clogged, as follows:

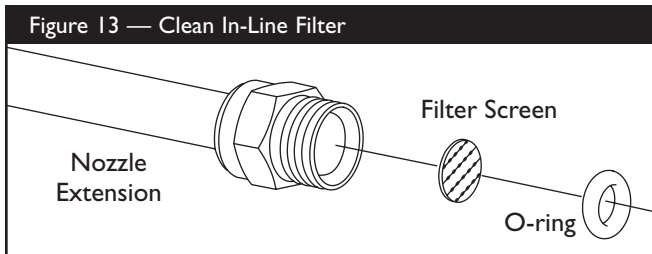

1. Detach spray gun and nozzle extension from high pressure hose. Detach nozzle extension from spray gun and remove o-ring and screen from nozzle extension. Flush the screen, spray gun, and adjustable nozzle extension with clean water to clear debris.
2. If the screen is damaged, the o-ring kit contains a replacement in-line filter screen and an o-ring. If undamaged, reuse screen.
3. Place the in-line filter screen into the threaded end of the nozzle extension. Direction does not matter. Push the screen in with the eraser end of a pencil until it rests flat at the bottom of the opening. Take care to not bend the screen.
4. Place the o-ring into the recess. Push the o-ring snugly against the in-line filter screen.
5. Assemble the nozzle extension to the spray gun, as described earlier in this manual.

Cleaning Detergent Siphoning Tube

If you used the detergent siphoning tube, you must flush it with clean water before stopping the engine.

- Place the detergent siphoning tube in a bucket full of clean water.
- Slide the adjustable nozzle forward to the low pressure position. Flush for 1-2 minutes.
- Shut off the engine.

IMPORTANT: Simply shutting OFF engine will not release pressure in the system. **When the engine has shut down, squeeze the trigger on the spray gun to relieve the pressure in the hose.**

Nozzle Maintenance

A pulsing sensation felt while squeezing the spray gun trigger may be caused by excessive pump pressure. The principal cause of excessive pump pressure is a orifice clogged or restricted with foreign materials, such as dirt, etc. To correct the problem, immediately clean the orifice using the tools included with your pressure washer and follow these instructions:

1. Shut off the engine and turn off the water supply.
2. Detach the nozzle extension from the spray gun. Twist the nozzle clockwise to the stream position. Using the supplied 2mm (5/64) allen wrench, remove the orifice from the end of the nozzle extension (Figure 14).

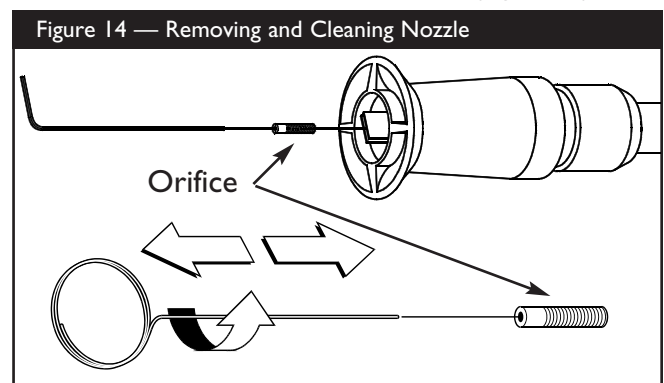

3. Remove the in-line filter from the other end of the nozzle extension.
4. Use the wire included in the kit (or a small paper clip) to free any foreign material clogging or restricting the orifice (Figure 14).



Snapper 2300 PSI Pressure Washer



- Using a garden hose, remove additional debris by back flushing water through the nozzle extension (Figure 15). Back flush between 30 to 60 seconds. Turn the adjustable nozzle extension to stream spray and move the nozzle from low to high while flushing.

Figure 15 — Backflushing the Nozzle

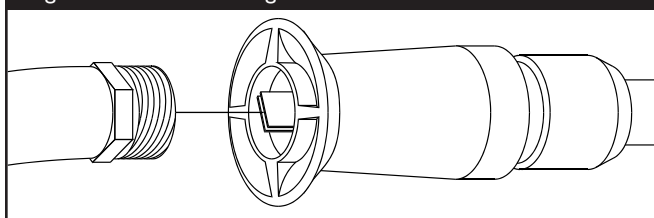

- Reinstall the orifice and in-line filter into the nozzle extension. **DO NOT** overtighten the orifice with the allen wrench.
- Reconnect the nozzle extension to the spray gun.
- Reconnect the water supply, turn on the water, and start the engine.
- Test the pressure washer by operating with nozzle in the high and in the low positions.

O-Ring Maintenance

Through the normal operation of your pressure washer, o-rings are used to keep the connections of the hoses and spray gun tight and leak-free. These o-rings may become worn or damaged.

An O-Ring Maintenance Kit is provided with your pressure washer. It includes replacement o-rings, rubber washer and water inlet filter. Refer to the instruction sheet provided in the kit to service your unit's o-rings. Note that you will not use all of the parts in the kit.

To remove a worn or damaged o-ring:

- Use a small flathead screwdriver to get underneath the o-ring and pry it off.

Pump Maintenance

Changing Pump Oil

Change oil every 50 hours or once yearly, whichever occurs first.

NOTE: Purchase a premeasured bottle of pump oil, item number 190586GS, by contacting the nearest authorized service center.

Change pump oil as follows:

- Drain engine oil and fuel from pressure washer.
- Use a 8mm allen wrench to remove the black pump oil cap between the high pressure outlet and garden hose inlet (Figure 17).

Figure 17 - Changing Pump Oil

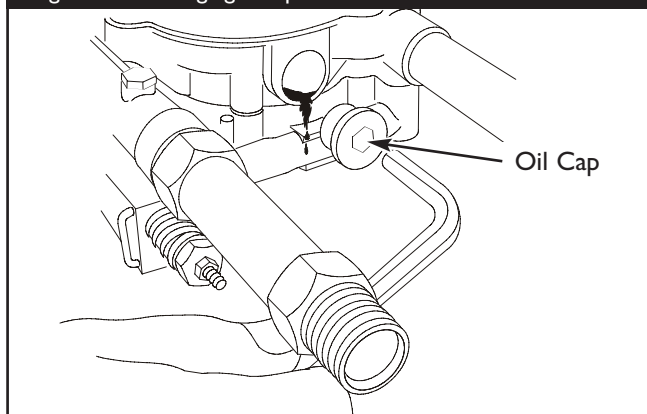

- Tilt the pressure washer to drain the oil into an approved container until it drips slowly from the pump.
- Tilt the pressure washer in the opposite direction and empty the premeasured pump oil bottle into the same opening (a small funnel may be helpful).
- Install the black pump oil cap and tighten firmly.
- Set the pressure washer in the upright position. Add fuel and engine oil.

ENGINE MAINTENANCE

See the engine owner's manual for instructions on how to properly maintain the engine.



CAUTION! Avoid prolonged or repeated skin contact with used motor oil. Used motor oil has been shown to cause skin cancer in certain laboratory animals. Thoroughly wash exposed areas with soap and water.

KEEP OUT OF REACH OF CHILDREN. DON'T POLLUTE. CONSERVE RESOURCES. RETURN USED OIL TO COLLECTION CENTERS.



PREPARING THE UNIT FOR STORAGE

Water should not remain in the unit for long periods of time. Sediments or minerals can deposit on pump parts and “freeze” pump action. If you do not plan to use the pressure washer for more than 30 days, follow this procedure:

1. Flush detergent siphoning tube by placing the filter into a pail of clean water while running pressure washer in low pressure mode (adjustable nozzle in the forward position). Flush for one to two minutes.
2. Shut off the engine and let it cool, then remove high pressure and garden hoses. Disconnect spark plug wire from spark plug.
3. Empty the pump of all pumped liquids by pulling the recoil handle about 6 times. This should remove most of the liquid in the pump.
4. Use PumpSaver to prevent corrosion build up and freezing of pump.
5. Store unit in a clean, dry area.

Protecting the Pump

To protect the pump from damage caused by mineral deposits or freezing, use PumpSaver to treat pump. This prevents freeze damage and lubricates pistons and seals.

NOTE: PumpSaver is available as an optional accessory. It is not included with the pressure washer. Contact the nearest authorized service center to purchase PumpSaver.

CAUTION! You must protect your unit from freezing temperatures. Failure to do so will permanently damage your pump and render your unit inoperable. Freeze damage is not covered under warranty.



CAUTION! Read and follow all cautions and warnings on the PumpSaver can label. Always wear eye protection when using PumpSaver.

To use PumpSaver, make sure the pressure washer is turned off and disconnected from supply water. Read and follow all instructions and warnings given on the PumpSaver container.

NOTE: PumpSaver will drip from pump after treatment and will stain wood and concrete.

NOTE: If PumpSaver is not available, draw RV antifreeze (non-alcohol) into the pump by pouring the solution into a 3-foot section of garden hose connected to inlet adapter and pulling recoil handle twice.

STORING THE ENGINE

See the engine owner’s manual for instructions on how to properly prepare the engine for storage.



TROUBLESHOOTING

Problem	Cause	Correction
Pump has following problems: failure to produce pressure, erratic pressure, chattering, loss of pressure, low water volume.	<ol style="list-style-type: none"> 1. Nozzle in low pressure mode. 2. Water inlet is blocked. 3. Inadequate water supply. 4. Inlet hose is kinked or leaking. 5. Clogged inlet hose strainer. 6. Water supply is over 100°F. 7. High pressure hose is blocked or leaks. 8. Gun leaks. 9. Nozzle is obstructed. 10. Pump is faulty. 	<ol style="list-style-type: none"> 1. Pull nozzle backward for high pressure mode. 2. Clear inlet. 3. Provide adequate water flow. 4. Straighten inlet hose, patch leak. 5. Check and clean inlet hose strainer. 6. Provide cooler water supply. 7. Clear blocks in outlet hose. 8. Replace gun. 9. Clean nozzle. 10. Contact Snapper service facility.
Detergent fails to mix with spray.	<ol style="list-style-type: none"> 1. Detergent siphoning tube is not submerged. 2. Chemical filter is clogged or cracked. 3. Dirty in-line filter. 4. Nozzle is in high pressure mode. 	<ol style="list-style-type: none"> 1. Insert detergent siphoning tube into detergent. 2. Clean or replace filter/detergent siphoning tube. 3. See "Check In-Line Filter" on page 12. 4. Push nozzle forward for low pressure mode.
Engine runs good at no-load but "bogs" when load is added.	Engine speed is too slow.	Move throttle control to FAST position. If engine still "bogs down", contact Briggs and Stratton service facility.
Pressure washer shuts down during operation.	Out of gasoline.	Fill fuel tank.

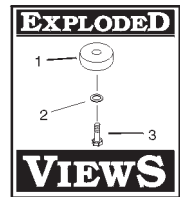

EXPLODED VIEW AND PARTS LIST – MAIN UNIT

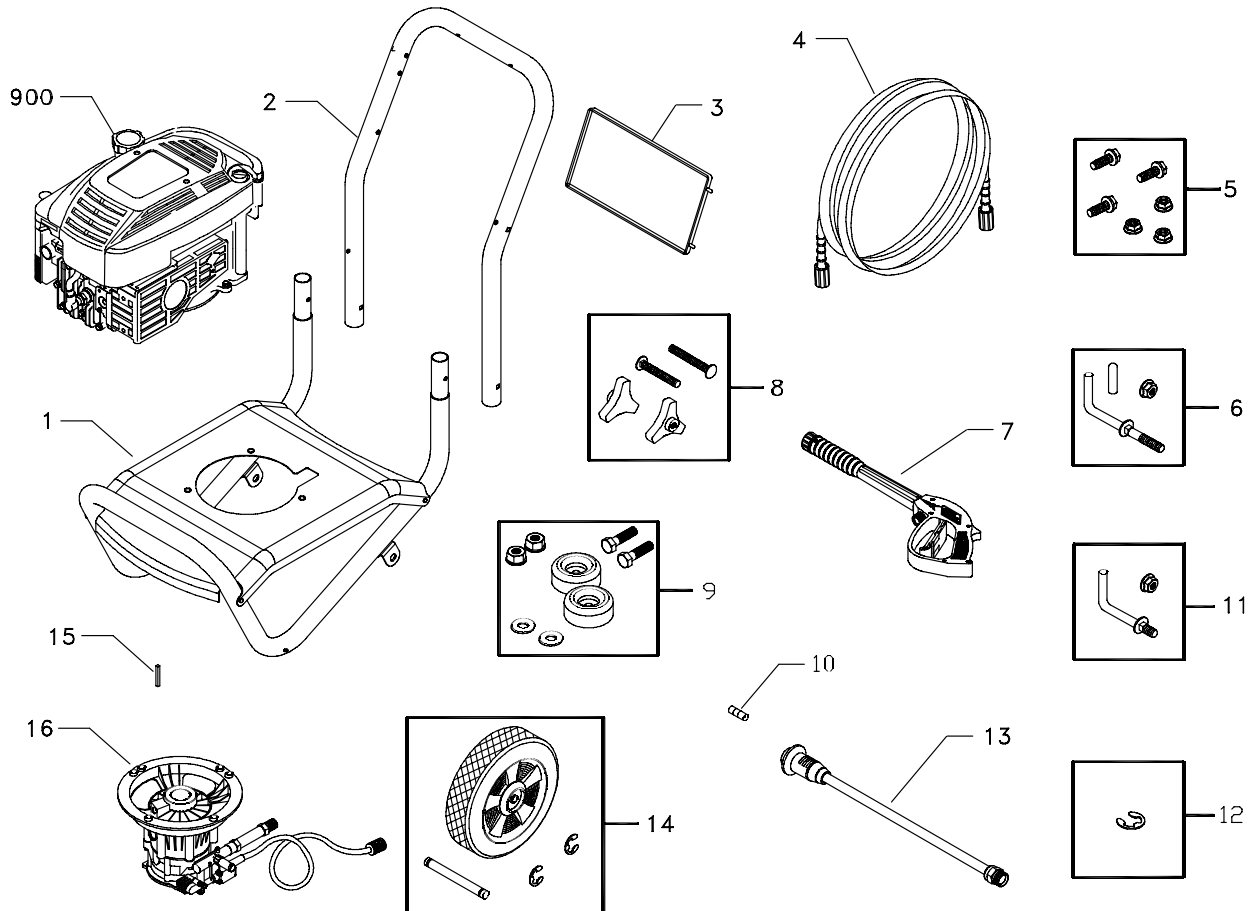

Item	Part #	Description	Item	Part #	Description
1	192547GS	BASE	10	21760GS	ORIFICE
2	B191874GS	HANDLE	11	192309GS	KIT, Hook
3	191909GS	BILLBOARD	12	192050GS	KIT, E-Ring
4	190249GS	HOSE	13	B3335HGS	WAND, Adjustable Nozzle
5	192529GS	KIT, Pump Mounting Hardware	14	192311GS	KIT, Wheel
6	192128GS	KIT, Hook	15	23139GS	KEY
7	190132GS	GUN	16	189970GS	ASSY, Pump (see page 17)
8	B2203GS	KIT, Handle Connector	900	NSP	ENGINE
9	192310GS	KIT, Vibration Mount			

Items Not Illustrated:

Part #	Description
192333GS	MANUAL, Owner's
192548GS	KIT, Decal
BB3061BGS	OIL, Engine

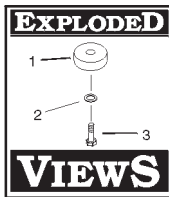

Snapper 2300 PSI Pressure Washer



EXPLODED VIEW AND PARTS LIST — PUMP

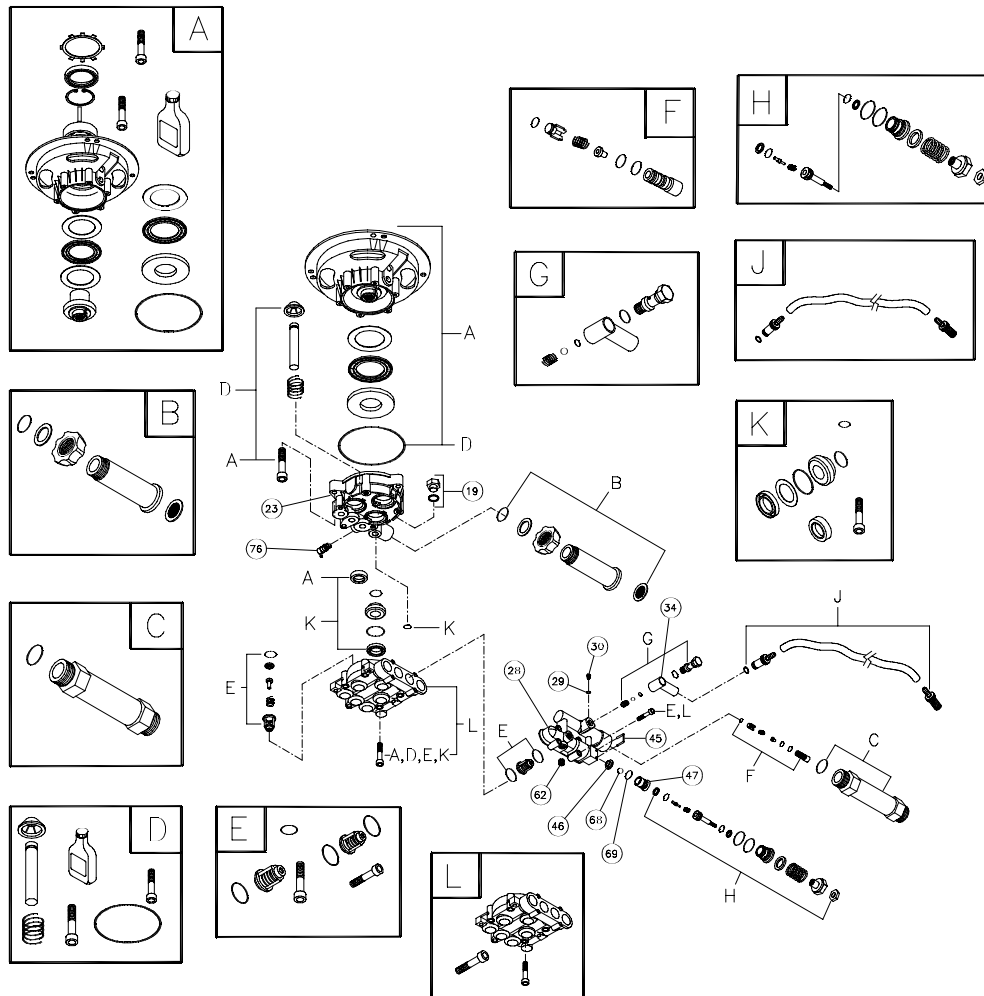

Item	Part #	Description
19	190571GS	CAP, Oil
23	190626GS	CARTER
28	190627GS	MANIFOLD
29	190575GS	O-RING
30	190576GS	SCREW
34	190577GS	CONNECTION, Chemical Inlet
45	190578GS	PIN
46	190579GS	VALVE, Seat Plate, Brass
47	190580GS	VALVE, Seat, Stainless
62	190581GS	CAP
68	190582GS	BALL, Stainless Steel
69	190584GS	O-RING
76	21783GS	THERMO RELIEF
77	190586GS	OIL BOTTLE

Item	Part #	Description
A	190709GS	KIT, WOBBLE PLATE BEARING
B	190632GS	KIT, WATER INLET, ALUM
C	190634GS	KIT, OUTLET, ALUM
D	190710GS	KIT, PISTON
E	190591GS	KIT, CHECK VALVES
F	190592GS	KIT, INLET CHECK
G	190593GS	KIT, CHEMICAL INJECTION
H	190594GS	KIT, UNLOADER STEM
J	189971GS	KIT, CHEMICAL HOSE
K	190595GS	KIT, SEAL SET
L	190596GS	KIT, HEAD BRASS

NOTE: Item letters A - L are service kits and include all parts shown within the box.



Snapper 2300 PSI Pressure Washer

NOTES

NOTES

NOTES

Snapper 2300 PSI Pressure Washer



NOTES

SNAPPER™ OWNER WARRANTY POLICY Effective January 1, 2003

LIMITED WARRANTY

"This Snapper™ product is distributed under license to Briggs & Stratton Power Products. Briggs & Stratton Power Products will repair or replace, free of charge, any part, or parts of the equipment** that are defective in material or workmanship or both. Transportation charges on parts submitted for repair or replacement under this warranty must be borne by purchaser. This warranty is effective for the time periods and subject to the conditions provided for in this policy. For warranty service, find your nearest Authorized service dealer by calling 1-800-317-7833. Warranty service may only be performed by a Briggs & Stratton Power Products Authorized service dealer.

THERE IS NO OTHER EXPRESS WARRANTY. IMPLIED WARRANTIES, INCLUDING THOSE OF MERCHANTABILITY AND FITNESS FOR A PARTICULAR PURPOSE, ARE LIMITED TO THE TIME PERIOD SPECIFIED, OR TO THE EXTENT PERMITTED BY LAW. ANY AND ALL IMPLIED WARRANTIES ARE EXCLUDED. LIABILITY FOR CONSEQUENTIAL DAMAGES UNDER ANY AND ALL WARRANTIES ARE EXCLUDED TO THE EXTENT EXCLUSION IS PERMITTED BY LAW. Some countries or states do not allow limitations on how long an implied warranty lasts, and some countries or states do not allow the exclusion or limitation of incidental or consequential damages, so the above limitation and exclusion may not apply to you. This warranty gives you specific legal rights and you may also have other rights that vary from country to country or state to state."

WARRANTY PERIOD*

Equipment **	Consumer Use	Commercial Use
Pressure Washer	1 Year	90 Days
Portable Generator	2 Years (2nd year parts only)	1 Year

* The warranty period begins on the date of purchase by the first retail consumer or commercial end user, and continues for the period of time stated in the table above. "Consumer use" means personal residential household use by a retail consumer.

"Commercial use" means all other uses, including use for commercial, income producing or rental purposes. Once equipment has been used commercially, it shall thereafter be considered to be in commercial use for purposes of this warranty.

** The engine and starting batteries are warranted solely by the manufacturers of those products.

WARRANTY REGISTRATION IS NOT NECESSARY TO OBTAIN WARRANTY ON BRIGGS & STRATTON POWER PRODUCTS EQUIPMENT. SAVE YOUR PROOF OF PURCHASE RECEIPT. IF YOU DO NOT PROVIDE PROOF OF THE INITIAL PURCHASE DATE AT THE TIME WARRANTY SERVICE IS REQUESTED, THE MANUFACTURING DATE OF THE EQUIPMENT WILL BE USED TO DETERMINE THE WARRANTY PERIOD.

About your equipment warranty:

We welcome warranty repair and apologize to you for being inconvenienced. Any Authorized service dealer may perform warranty repairs. Most warranty repairs are handled routinely, but sometimes requests for warranty service may not be appropriate. For example, warranty service would not apply if equipment damage occurred because of misuse, lack of routine maintenance, shipping, handling, warehousing or improper installation. Similarly, the warranty is void if the manufacturing date or the serial number on the equipment has been removed or the equipment has been altered or modified. During the warranty period, the Authorized service dealer, at its option, will repair or replace any part that, upon examination, is found to be defective under normal use and service. This warranty will not cover following repairs and equipment:

- **Normal Wear:** Outdoor power equipment, like all mechanical devices, needs periodic parts, service and replacement to perform well. This warranty does not cover repair when normal use has exhausted the life of a part or the equipment.
- **Installation and Maintenance:** This warranty does not apply to equipment or parts that have been subjected to improper or unauthorized installation or alteration and modification, misuse, negligence, accident, overloading, overspeeding, improper maintenance, repair or storage so as, in our judgment, to adversely affect its performance and reliability. This warranty also does not cover normal maintenance such as adjustments, fuel system cleaning and obstruction (due to chemical, dirt, carbon or lime, etc.).
- **Other Exclusions:** Also excluded from this warranty are wear items such as quick couplers, oil gauges, belts, o-rings, filters, pump packing, etc., pumps which have been run without water supplied or damage or malfunctions resulting from accidents, abuse, modifications, alterations, or improper servicing or freezing or chemical deterioration. Accessory parts such as guns, hoses, wands and nozzles are excluded from the product warranty. Also excluded is used, reconditioned, and demonstration equipment; equipment used for prime power in place of utility power and equipment used in life support applications.

BRIGGS & STRATTON POWER PRODUCTS GROUP, LLC
JEFFERSON, WISCONSIN, U.S.A.

Free Manuals Download Website

<http://myh66.com>

<http://usermanuals.us>

<http://www.somanuals.com>

<http://www.4manuals.cc>

<http://www.manual-lib.com>

<http://www.404manual.com>

<http://www.luxmanual.com>

<http://aubethermostatmanual.com>

Golf course search by state

<http://golfingnear.com>

Email search by domain

<http://emailbydomain.com>

Auto manuals search

<http://auto.somanuals.com>

TV manuals search

<http://tv.somanuals.com>