

Safety Instructions & Operator's Manual for **SNAPPER**[®]

EUROPEAN INTERMEDIATE REAR TINE TILLER SERIES 5



MODEL
EICFR5505BV

MODEL NUMBER EXPLANATION									
	E	I	C	F	R	55	05	BV	
EUROPEAN MODEL	MODEL DESIGNATION		REAR TINE MODEL			ENGINE MODEL		SERIES DESIGNATION	
									ENGINE HP
E – European Model	55 – 5.5 HP Engine (Horse Power)					5 - Series Designation		B – Briggs Engine	
I – Intermediate Size Model								V – Over Head Valve	
C – Counter Rotating Tines									
F – Forward Rotating Tines									
R – Rear Tine Type Model									

Thank you for buying a SNAPPER Product! Before operating your TILLER, read this manual carefully and pay particular attention to the "IMPORTANT SAFETY INSTRUCTIONS" on Page 2. Remember that all power equipment can be dangerous if used improperly. Also keep in mind that SAFETY requires careful use in accordance with the operating instructions and common sense!

SNAPPER[®] McDonough, GA., 30253 U.S.A.

IMPORTANT SAFETY INSTRUCTIONS

WARNING: This powerful machine is capable of amputating hands and feet and can throw objects that can cause injury and damage! Failure to comply with the following instructions may result in serious injury to the operator or other persons. The owner of the tiller must understand these instructions and, furthermore, must allow only persons who understand these instructions to operate tiller. Each person operating the tiller must be of sound mind and body and must not be under the influence of any substance, which might impair vision, dexterity, or judgment. If you have any questions pertaining to your tiller which your dealer cannot answer to your satisfaction, call or write the Customer Service Department at SNAPPER, McDonough, Georgia, 30253. Phone: (1-800-935-2967).

PROTECTION FOR CHILDREN

1. **DO NOT** allow children in area when tiller is being operated.
2. **DO NOT** allow pre-teenage children to operate tiller.
3. Allow only responsible teenagers or adults with mature judgment to operate tiller and only under close supervision.
4. Keep the area clear of all persons, particularly small children, and pets.
5. Know how to **STOP** the tiller and disengage the controls quickly.

PREPARATION

1. Read this manual, get to know where all controls are located and practice how to use them before starting for the first time, and at the beginning of each season. Be thoroughly familiar with the controls and proper use of the equipment. Pay attention to Warning and Instructional Decals on engine and tiller.
2. Never operate tiller without proper guards, drag shield, plates, safety switches, or other safety protective devices in place and properly connected. Inspect to determine that these safety devices are installed properly, are in good repair, and operate properly. If the condition or operation of these devices are questionable, they must be repaired or replaced before using the tiller.
3. Thoroughly inspect the area where the tiller is to be used and remove all stones, sticks, wire, bones and other foreign objects. Also, note the location of holes, stumps, and other possible hazards.
4. **DO NOT** operate tiller when barefoot or wearing open sandals. Always wear long pants and substantial footwear with good traction.
5. Fill fuel tank outdoors and replace fuel cap before starting engine. Use approved fuel container. **DO NOT** smoke near open fuel container. **DO NOT** fill fuel tank indoors or when engine is running. Allow engine to cool for at least ten minutes before refilling. Wipe off any spilled fuel before starting engine. **DO NOT** run engine indoors.
6. Make sure that clutch is disengaged and transmission is in neutral (if so equipped) before starting engine.

OPERATIONAL PRECAUTIONS

1. **DO NOT** change engine governor settings or over speed engine.
2. **DO NOT** put hands or feet near or under rotating parts.
3. Exercise **CAUTION** when crossing gravel drives, walks, or roads, and under any conditions when tiller is transported. Look behind and use care when backing.
4. After striking a foreign object or if tiller vibrates abnormally, **STOP** the engine, disconnect and secure spark plug wire away from plug. Inspect the tiller for any damage and repair the damage.
5. When leaving tiller unattended, disengage clutch, shift transmission to neutral (if so equipped) and stop the engine.
6. Before removing debris or cleaning tines, repairing or inspecting make certain engine, tines and all moving parts have **STOPPED**. Disconnect and secure spark plug wire away from plug to prevent accidental starting.
7. Exercise **CAUTION** when changing directions while operating tiller. **DO NOT** till in areas where stability or traction is in doubt.
8. **DO NOT** overload the machine capacity by attempting to till too deep at too fast a rate.
9. Be extra careful when tilling hard ground. Use less tine engagement to maintain control of tiller.
10. Till only in daylight or in good artificial light.
11. Never operate tiller in wet areas. Always be sure of your footing; keep a firm hold on the handle.
12. Do not operate on slopes

MAINTENANCE AND STORAGE

1. Keep all nuts, bolts, and screws tight and be sure tiller is in safe operating condition.
2. Never store tiller with fuel in tank inside of a building where fumes may reach an open flame or spark. Allow engine to cool before storing in any enclosure.
3. To avoid fuel leakage and **FIRE HAZARD**, fuel must be drained from tank before standing tiller on end. Always keep engine free of spilled fuel, debris and excessive grease.
4. Have your tiller inspected and serviced each year by an authorized Snapper dealer. Determine if any additional devices are available which might upgrade the safety of your tiller.
5. Factory specified Snapper replacement parts must be used to assure adequate protection against injury.

TABLE OF CONTENTS

IMPORTANT SAFETY INSTRUCTIONS	2
TABLE OF CONTENTS	3
SECTION 1	
FAMILIARIZATION.....	4
CONTROL IDENTIFICATION & SAFETY SIGNS	5-6
SECTION 2 - OPERATING INSTRUCTIONS	7-8
Transmission Positions	7
Pre-Start Checklist.....	7
Starting & Stopping	7
Handlebar Adjustment.....	8
Transporting.....	8
Tilling Procedure	8
SECTION 3 - ADJUSTMENTS & REPAIR.....	9-11
Service Parts & Assistance.....	9
Standing Tiller On End	9
Tiller Lubrication.....	9-10
Tiller Tines.....	10
Belt Adjustment & Replacement	10-11
Off Season Storage	11
Tine Replacement.....	11
WARRANTY	12
PRIMARY MAINTENANCE.....	13-16
NOTES	17-19

Section 1 - FAMILIARIZATION

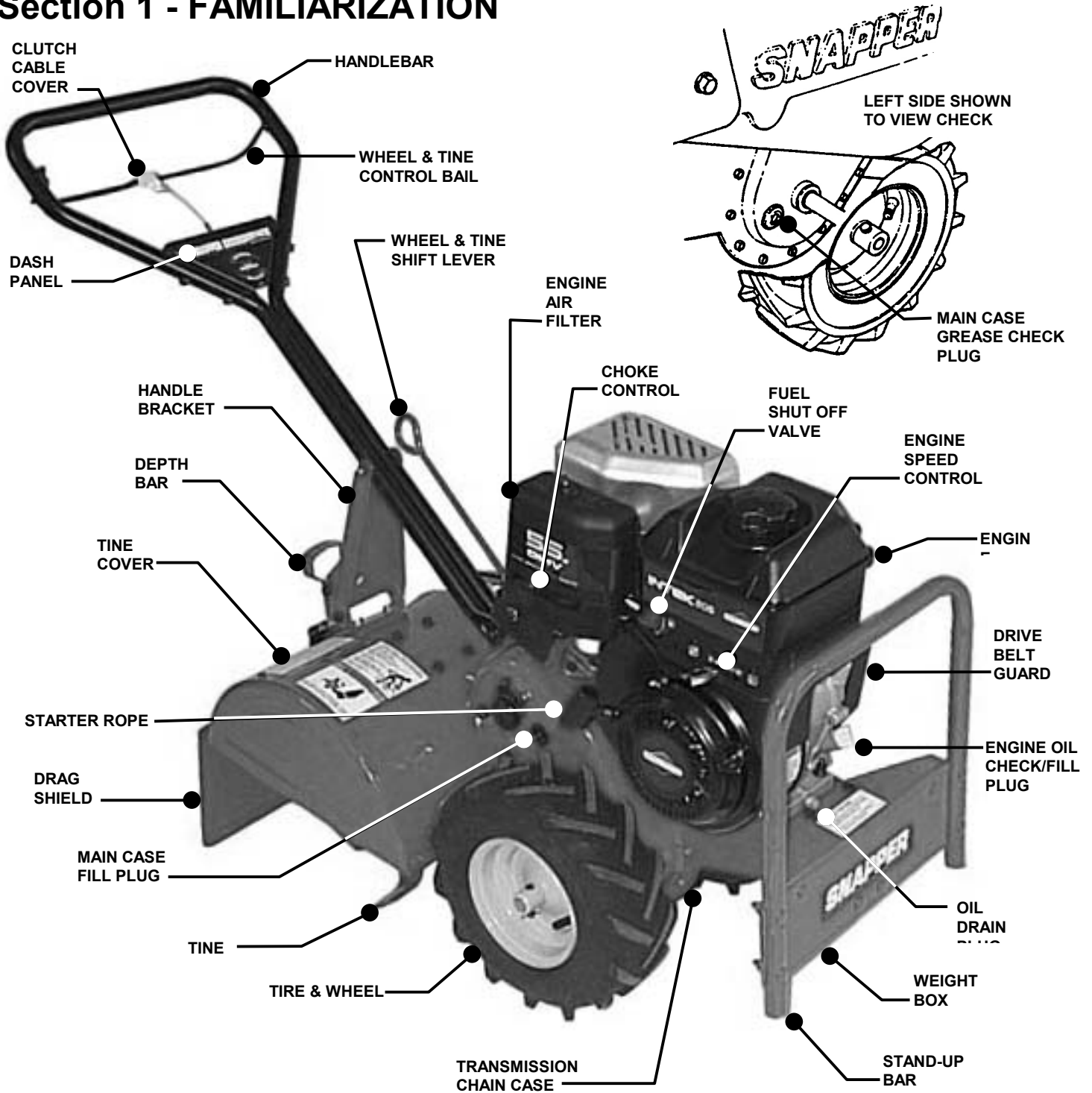
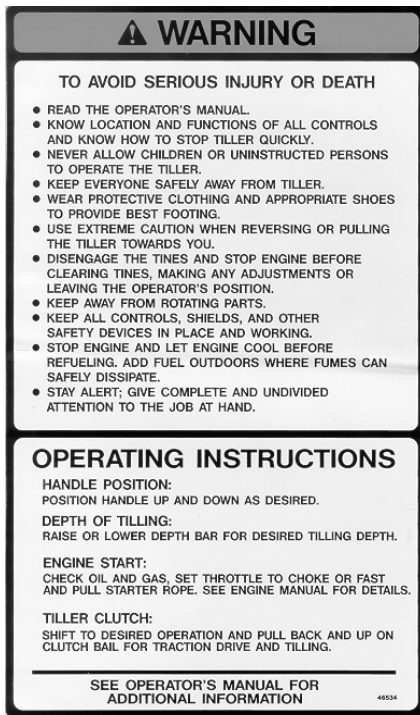

FIGURE 1

1.1 INTRODUCTION: This manual covers the recommended operating procedure and routine service requirements on SNAPPER Intermediate Rear Tine Tiller. It is recommended that all operators of this Tiller become thoroughly familiar with the controls and proper operation of the unit before operating. Specific details involving the engine are found in the separate engine owner's manual. Study these manuals before operating and keep both handy for future reference. Refer to Figure 1 above for location of controls and other essential components.

CONTROL IDENTIFICATION & SAFETY SIGNS



WARNING: Advises operator of safety procedures that should be followed to prevent injury.

OPERATING INSTRUCTIONS: Describes operating instructions. 1) Handle position. 2) Depth of tilling. 3) Engine starting procedure. 4) Tiller clutch engagement.

STARTING PROCEDURE: Describes procedure for starting tiller.

WARNING: Advises operator of the danger of the rotating tines.



WARNING: To avoid fuel leakage and FIRE HAZARD, fuel must be drained from tank before standing tiller on end.



WARNING: Warns operator to read operator's manual and observe all labels and safety instructions before operating tiller.

EUROPEAN PERFORMANCE:

Maximum level of vibration measured at the operators hand is 22.0 m/sec².

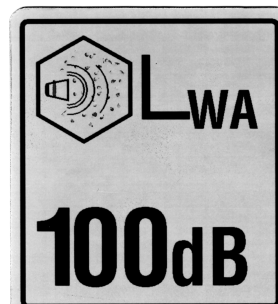

SOUND POWER LEVEL

CONTROL IDENTIFICATION & SAFETY SIGNS

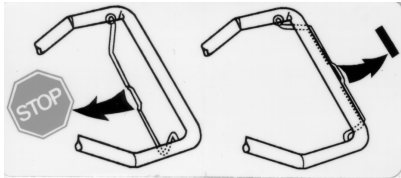

WHEEL & TINE CONTROL BAIL: Both decals describe operation of wheel & tine control. As the wheel & tine control bail is rotated rearward the wheels & tines will start rotating. The wheel & tine control bail is released and rotates forward the wheels & tines will stop but, the engine will continue operating.

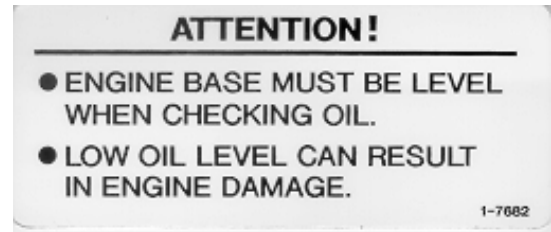
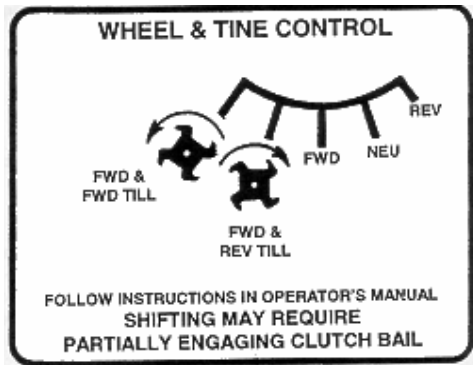

ATTENTION: Describes procedure for engine lubrication check.

WHEEL & TINE CONTROL: Describes operational shifting positions .

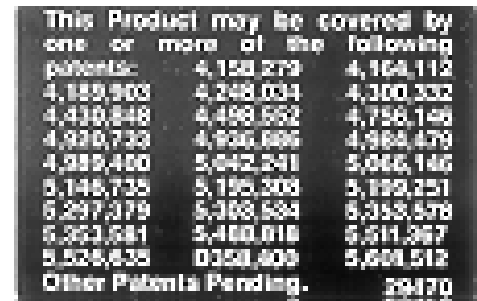
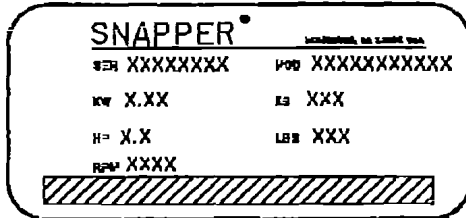

SERIAL PLATE: Lists model and serial numbers for proper identification and ordering parts.

PATENT NUMBERS: Describes current patent numbers being used for Snapper products.

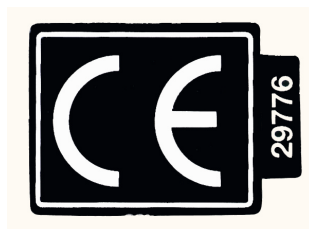

EUROPEAN COMMUNITY: Identification decal representing the European community.



YEAR OF MANUFACTURE: Represents the year of manufacture of machine.



SNAPPER: Manufacturers name of the product.

Section 2 - OPERATING INSTRUCTIONS

2.1 BEFORE OPERATING:

Be thoroughly familiar with the operation of ALL controls and how to use them BEFORE operating your Tiller. Transmission shifting is done by shifting the WHEEL and TINE SHIFT LEVER into the desired position. See Figure 3.

2.1.1. TRANSMISSION POSITIONS: The tiller has five different transmission positions. They are as viewed from the operator's position, viewed from the left to right as follows:

1. **FWD & FWD TIL** - (Forward Rotating Wheels and Forward Rotating Tines are engaged).
2. **FWD & REV TIL** - (Forward Rotating Wheels and Reverse Rotating Tines are engaged).
3. **FWD** - (Forward Rotating Wheels are engaged).
4. **NEU** - (Wheels and Tines are disengaged).
5. **REV** - (Reverse Rotating Wheels).

2.2 PRE-START CHECKLIST

Make the following checks and perform services as required before each start up. NOTE: Before checking oil level place 2x4 piece of wood under both wheels to level engine.

2.2.1. CHECK ENGINE OIL and bring level up to full. (Refer to engine manual for oil specifications).

2.2.2. CHECK AIR CLEANER and service according to instructions in engine manual.

2.2.3. CHECK EXTERNAL SURFACES and remove dirt and dust accumulation and clean tines as needed.

2.2.4. CHECK GUARDS to make sure all are in proper position and securely tightened.

2.2.5. FILL FUEL TANK where fumes will be safely dissipated. Refer to engine manual for fuel specifications.

2.3 STARTING - STOPPING

Know beforehand how to stop the tines, wheel drive and engine in preparation for possible emergencies. The engine is stopped by pulling the engine SPEED CONTROL to the rear to STOP. See Figure 2.



FIGURE 2

When the wheel and tine control is activated, the tines rotate in a rearward or forward direction. With the engine running, shift into the desired transmission position and pull the WHEEL and TINE CONTROL BAIL against the handle bar to start wheel or wheel and tine rotation. Wheel or wheel and tine rotation is **STOPPED** by releasing the WHEEL and TINE CONTROL BAIL. When the bail is released, rotation should STOP even with the WHEEL and TINE SHIFT LEVER in an engaged position. See Figures 3 and 4.

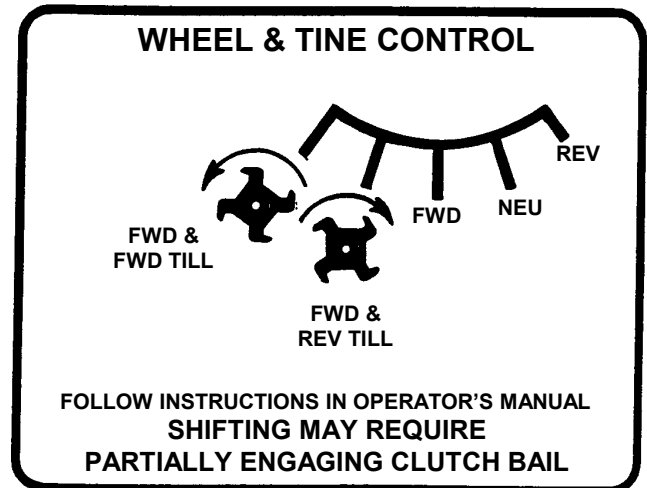

FIGURE 3

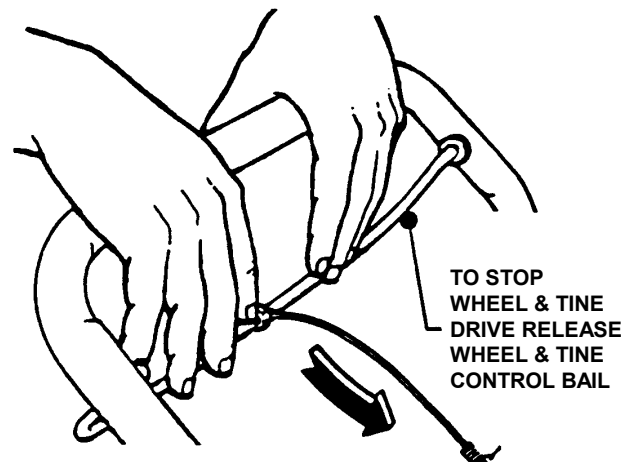

FIGURE 4

2.4 ENGINE STARTING PROCEDURE

STEP 1: Place the WHEEL and TINE SHIFT LEVER in the NEUTRAL position and make sure the WHEEL and TINE CONTROL BAIL is in the released position.

STEP 2: For cold starts, move the CHOKE CONTROL on the engine forward into CHOKE position. See Figure 5.

Section 2 - OPERATING INSTRUCTIONS



FIGURE 5

STEP 3: Move ENGINE SPEED CONTROL to FAST position and turn FUEL VALVE to ON position.

STEP 4: Move to the right side of Tiller and place your foot on top of the right wheel (See starting procedure decal located on top of the tine cover), hold handle bar, then pull the ROPE STARTER HANDLE in smooth, steady motion until the engine starts. To prolong the life of the rope, guide the handle back to the engine rather than allowing it to snap back.

STEP 5: Allow a brief warm-up period, then move the CHOKE CONTROL rearward to RUN POSITION and the ENGINE SPEED CONTROL to the desired speed setting. Refer to the tilling procedure column on this page.

STEP 6: To **STOP** the engine, pull the ENGINE SPEED CONTROL on engine rearward into STOP position and turn FUEL VALVE to OFF position.

2.5 HANDLE BAR ADJUSTMENT

Remove retaining screw and nut from handle bar bracket. Adjust handle bar "UP" or "DOWN" as required. Reinstall screw and nut. See Figure 6.

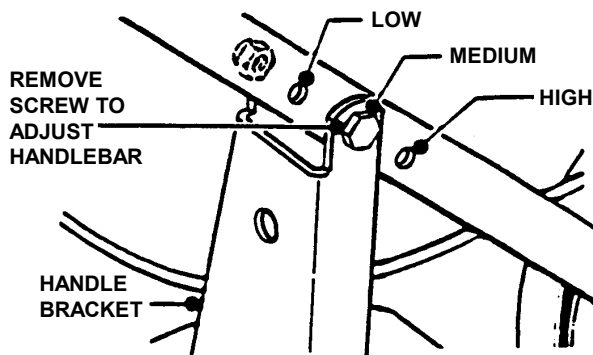

FIGURE 6

2.6 TRANSPORTING

2.6.1. FORWARD/REVERSE: To transport the Tiller to a new tilling site using its own power, raise the tines to clear lawn and paved surfaces to prevent gouging. Release the WHEEL and TINE CONTROL BAIL and lift the rear of the Tiller to take the weight off the DEPTH BAR (see Figure 7), then push the DEPTH BAR downward into notch setting that allows the tines to clear the ground surface. Place the WHEEL and TINE SHIFT LEVER in FWD or REV. Pull the WHEEL and TINE CONTROL BAIL back against the handlebar to engage the wheel drive and transport the unit.

2.6.2. To transport the Tiller to a new tilling site by pushing it, place the WHEEL and TINE SHIFT LEVER in the NEUTRAL position, and with the bail released, push the unit with the handle bar. The Tiller may be pushed with the engine running or shut off.

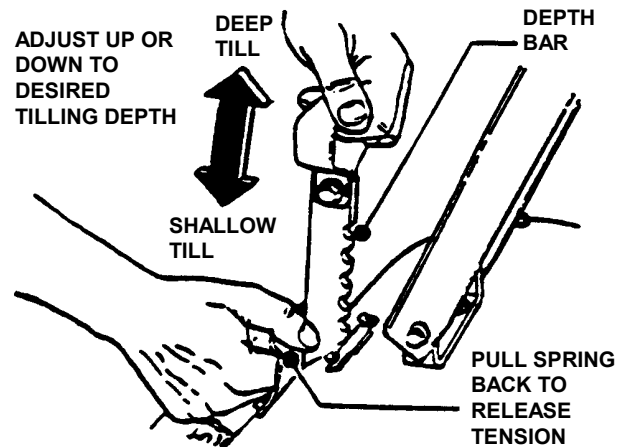

FIGURE 7

2.7 TILLING PROCEDURE

Tines are engaged **ONLY** when the WHEEL and TINE SHIFT LEVER is in the FWD & FWD TIL or FWD & REV TIL position and the WHEEL and TINE CONTROL BAIL is held against the handle bar.

STEP 1: Set HANDLE BAR in desired position before beginning operation.

STEP 2: Set DEPTH BAR to desired position. Highest position is deepest depth. See Figure 7.

STEP 3: Move the ENGINE SPEED CONTROL to desired setting.

STEP 4: To start TILLING action, move the WHEEL and TINE SHIFT LEVER to the FWD & FWD TIL or FWD REV TIL position.

STEP 5: Engage the WHEEL and TINE CONTROL. Machine will start forward movement and tilling.

IMPORTANT: To STOP forward movement and tine rotation, release the wheel and tine control.

Section 3 – ADJUSTMENTS & REPAIR

3.1 SERVICE PARTS & ASSISTANCE

To retain the original quality of your Tiller, use only genuine SNAPPER replacement parts. Specify the model and serial number as found on the nameplate of your Tiller when contacting your SNAPPER Dealer for parts or service assistance.

3.2 STANDING THE TILLER ON END

WARNING

DO NOT attempt any adjustments, maintenance, service, or repairs with the engine running. Stop tines and engine. Remove spark plug wire and secure wire away from spark plug. DO NOT stand Tiller on end with the engine running! To avoid fuel leakage and potential FIRE HAZARD the fuel tank must be drained before standing tiller on end. Allow engine to cool for at least ten minutes before draining or refilling fuel. Wipe off any spilled fuel before starting engine. Take all necessary precautions to prevent fuel leakage BEFORE standing the Tiller on end. Any draining of fuel must be done outside with the engine cool and away from ignition sources. If the Tiller is stored on end for any length of time, check it frequently for signs of fuel and/or oil leakage. Use approved fuel container. DO NOT smoke near open fuel container. DO NOT drain or fill fuel tank indoors or when engine is running. DO NOT run engine indoors.

3.2.1. ENGINE SERVICE: Refer to the engine owner's manual for details. Engine oil is drained by removing front filler plug and standing Tiller on end. See Figure 8.

3.2.2. SERVICE NOTE: Since a Tiller normally operates under extremely dusty or dirty conditions, the air cleaner, engine oil and cooling fins must be serviced as specified in the engine manual at frequent intervals. The Tiller itself should be serviced as follows:

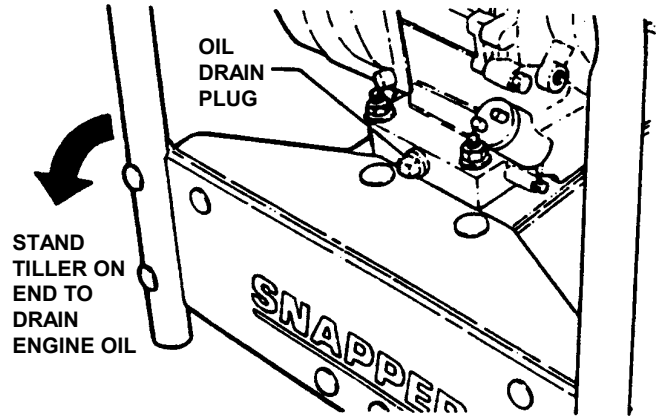

FIGURE 8

3.3 TILLER LUBRICATION

3.3.1. CHECK LUBRICATION IN CHAIN CASE:

Check the level of the grease in the chain case at the beginning of each tilling season. Remove clevis pin and cotter pin that secures left hand tire/wheel to axle. Remove wheel. Check grease level by removing the plastic plug located beside the axle shaft on the lower left hand side. See Figure 9. The level should be up to the edge of the opening.

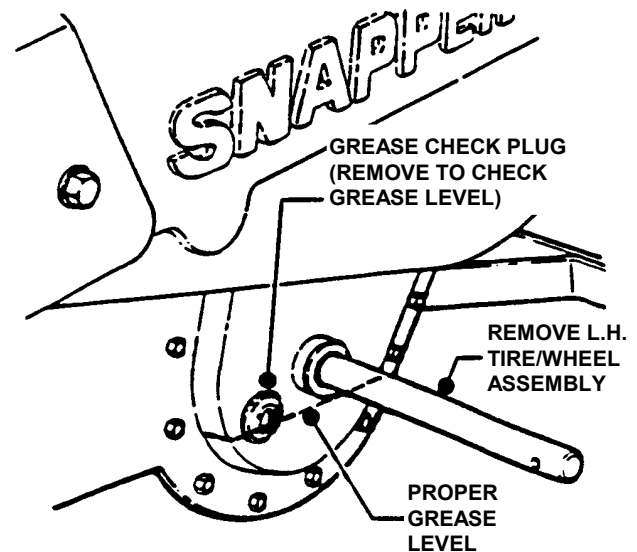

FIGURE 9

Section 3 - ADJUSTMENTS & REPAIR

3.3.2. ADD LUBRICATION TO CHAIN CASE: To add grease, remove the filler plug located just forward of the pulley shaft on the right hand side. See Figure 10. Add Snapper Part No. 2-9577 Benalene 900 grease (4 oz. Bottle) as needed to bring level up to bottom edge of the check plug opening. The total capacity of the case is about 48 ounces. DO NOT exceed this amount. Reinstall check plugs after checking. NOTE: Also available Snapper Part No. 2-9296 Benalene 900 grease (32 oz. Bottle).

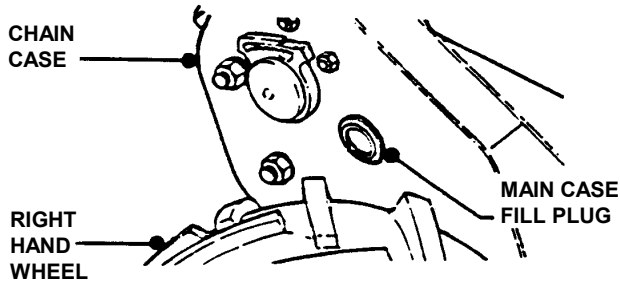

FIGURE 10

3.4 TILLER TINES

Your Snapper Tiller has right hand and left hand tines. Replace both tines if blades become bent or are badly worn or otherwise damaged. Use correct Snapper replacement tines. The tines are secured to the tine shaft with a shear bolt, Part No. 2-8725 and Lock Nut Part No. 9-0222 on each side. NOTE: Two extra nuts and two bolts come with tiller. Keep spares on hand in case a bolt shears off or becomes lost while tilling. See Figure 11. DO NOT over tighten these shear bolts as this will cause premature failure. (Recommended torque is 5 to 8 foot pounds maximum). NOTE: Failure to use the correct shear bolts could result in serious damage to your Tiller. Use only the genuine Snapper replacement bolts and lock nuts specified above. These bolts are designed to shear at a specific stress to prevent damage. DO NOT use substitutes!

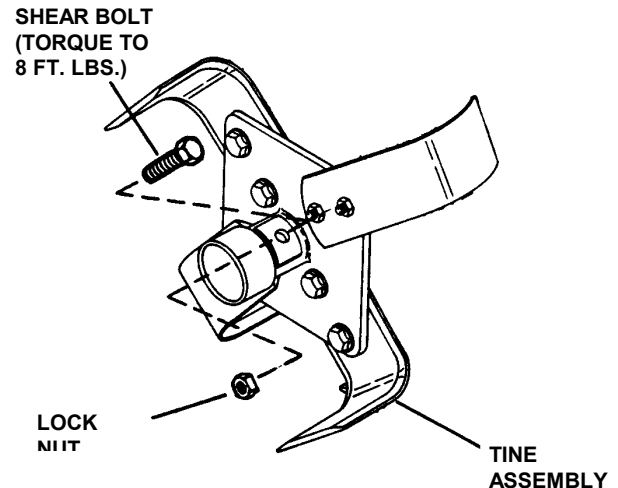

FIGURE 11

3.5 BELT ADJUSTMENT - REPLACEMENT

STEP 1: BELT TENSION ADJUSTMENT: From the right side under the fuel tank, measure the length of the idler pulley spring at the end of the control cable in a relaxed position. Then move wheel and tine control bail up to the handle bar and measure the extended length of the spring. When properly adjusted, the spring will extend 1/4" to 1/2". See Figure 12. To adjust, loosen and reposition the two jam nuts on the threaded end of cable located on the dash panel. Move jam nuts toward the end of threaded end of cable for more tension. Move jam nuts in a direction away from the end of threaded end of cable for less tension. See Figure 13. After adjustment, retighten both jam nuts against dash panel.

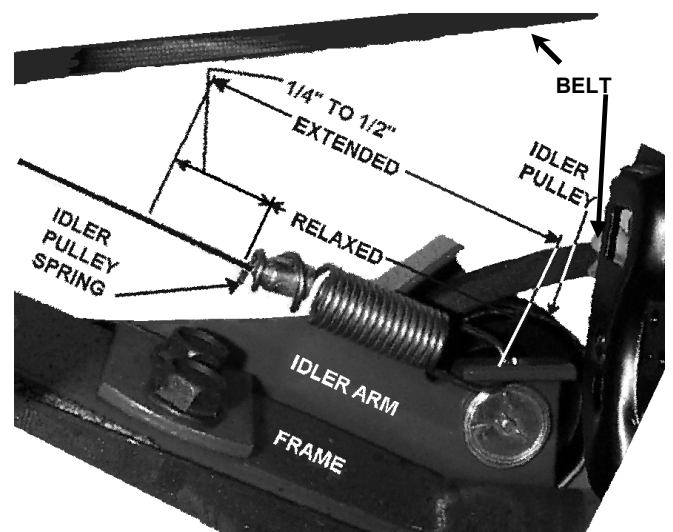

FIGURE 12

Section 3 - ADJUSTMENTS & REPAIR

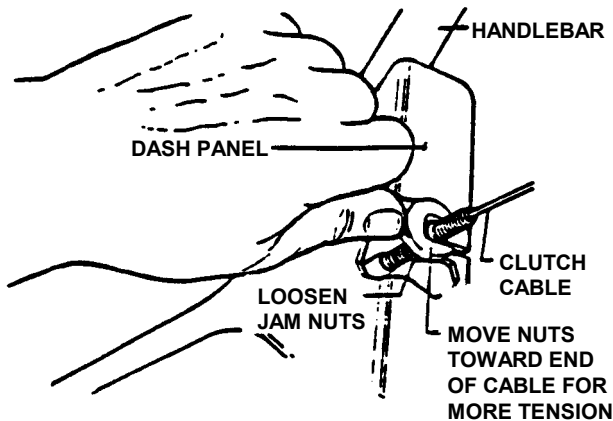

FIGURE 13

3.5.1. TENSION TEST: Start the engine with tiller in neutral. Shift transmission into FWD & TILL and pull the wheel and tine control bail up against the handle bar. Tines and wheels will start to rotate. Release control bail. Tines and wheels should stop rotating immediately. If rotation continues after release of control bail then clutch spring tension is too great and will have to be readjusted as described in BELT TENSION ADJUSTMENT Section.

3.5.2. BELT REPLACEMENT: Pull the clevis pin from the left wheel and slide the wheel out 1", remove belt guard and then the old belt. NOTE: Replacement belt must go over the top of the idler and be within the belt guide as shown in Figure 14. Check belt tension as described in BELT TENSION ADJUSTMENT Section. Reinstall guard, push left wheel back into position, secure with clevis pin and insert, and secure cotter pin.

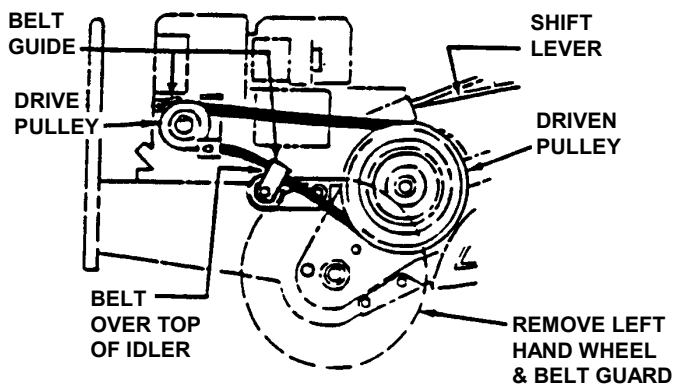

FIGURE 14

OFF SEASON STORAGE

Thoroughly clean all external surfaces and tines before storing the Tiller. The Tiller may be stored on end, however, the following steps must be taken:

STEP 1: Drain gasoline from fuel system and drain the engine crankcase oil (refer to engine manual for details).

STEP 2: After standing the Tiller on end, check the plugs in the chain case for leakage. After extended period, some grease may seep through upper bearing races.

STEP 3: Remove both wheels and grease wheel shafts. Reinstall wheels. Remove both tines and grease tine shafts. Reinstall tines. Grease these shafts when tiller is stored for long periods to prevent rust buildup. Rust buildup will cause wheels and tines difficult to remove.

STEP 4: At the start of the new season, replenish engine crank case oil and add gasoline to the fuel tank after returning the Tiller to its wheels.

STEP 5: Before starting, move the ENGINE CONTROL to OFF and pull rope starter slowly several times. If excessive resistance is felt, remove the spark plug and pull rope starter rapidly to spin the engine and clear oil from the cylinder. Clean and reinstall spark plug before attempting to start the engine.

3.5.3. TINE REPLACEMENT: Remove left and right side plate. Remove shear bolts and nuts that secure the tine assembly to tine shaft. Remove shoulder bolts and nuts that secure the tines to tine hub weldment. Install new tines and tighten nuts and bolts securely.

- 5-7831 Complete Tine Assembly (Includes Following Items)
- 4-6798 Tine Hub Weldment
- 3-8215 Tine 11-1/2" (4)
- 1-4981 Hex Flange Shoulder Bolt 3/8-24 (8)
- 9-0524 Hex Lock Nut 3/8-24 (8)

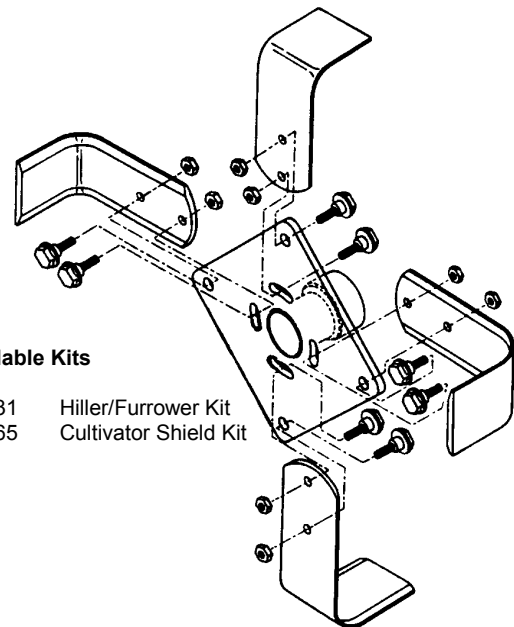

FIGURE 15

SNAPPER®

3 YEAR LIMITED WARRANTY

For three (3) years from purchase date for the original purchaser's residential, non-commercial use, **SNAPPER**, through any authorized **SNAPPER** dealer will replace, free of charge (except for taxes where applicable), any part or parts found upon examination by the factory at McDonough, Georgia, to be defective in material or workmanship or both.

For ninety (90) days from purchase date for the original purchaser's commercial, rental, or other non-residential use, **SNAPPER**, through any authorized **SNAPPER** dealer will replace, free of charge, any part or parts found upon examination by the factory at McDonough, Georgia, to be defective in material or workmanship or both.

All transportation costs incurred by the purchaser in submitting material to an authorized **SNAPPER** dealer for replacement under this warranty must be paid by the purchaser.

This warranty does not apply to engines and their components, and batteries, as these items are warranted separately. This warranty does not apply to parts that have been damaged by accident, alteration, abuse, improper lubrication, normal wear, or other cause beyond the control of **SNAPPER**. This warranty does not cover any machine or component part that has been altered or modified changing safety, performance, or durability.

Batteries have a one (1) year prorated warranty period with free replacement if required during the first ninety (90) days from the original purchase date. **SNAPPER** will not be responsible for any installation cost incurred. The battery warranty only covers original equipment batteries and does not cover damage to the battery or machine caused by neglect or abuse, destruction by fire, explosion, freezing, overcharging, improper maintenance, or use of improper electrolyte.

There is no other express warranty.

DISCLAIMER OF WARRANTY

Implied warranties, including those of merchantability and fitness for a particular purpose, are limited to three (3) years from purchase date for the original purchaser's residential or other non-commercial use, and ninety (90) days from purchase for the original purchaser's commercial, rental or other non-residential use, and to the extent permitted by law, any and all implied warranties are excluded. This is the exclusive remedy. Liabilities for consequential damages, under any and all warranties are excluded.

Some states do not allow limitations on how long an implied warranty lasts, or do not allow the exclusion or limitation of incidental or consequential damages, so the above limitation or exclusion may not apply to you.

This warranty gives you specific legal rights, and you may also have other rights, which vary, from state to state.

WARNING: THE USE OF REPLACEMENT PARTS OTHER THAN GENUINE SNAPPER PARTS MAY IMPAIR THE SAFETY OF SNAPPER PRODUCTS AND WILL VOID ANY LIABILITY AND WARRANTY BY SNAPPER ASSOCIATED WITH THE USE OF SUCH PARTS.

IMPORTANT: Please fill out the attached **SNAPPER** Product Registration Card immediately and mail to:
Snapper's Product Registration Center, P.O. Box 1379, McDonough, Georgia 30253

PRIMARY MAINTENANCE

SNAPPER®

vs. DIRT!

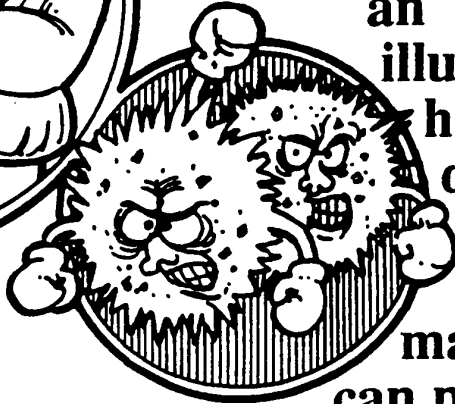
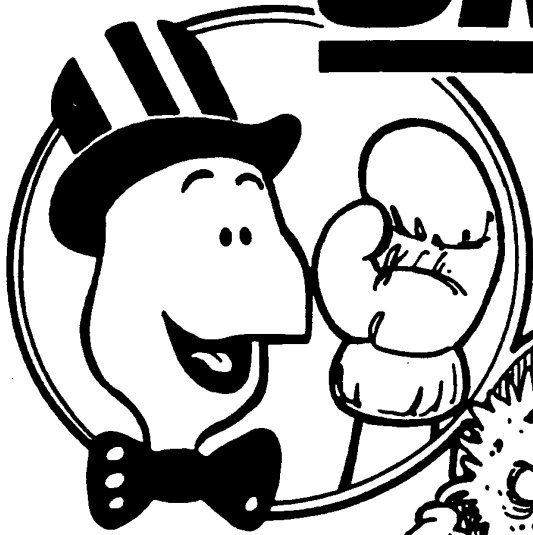

an illustration of how dirt can damage your engine & how reasonable maintenance can protect it!

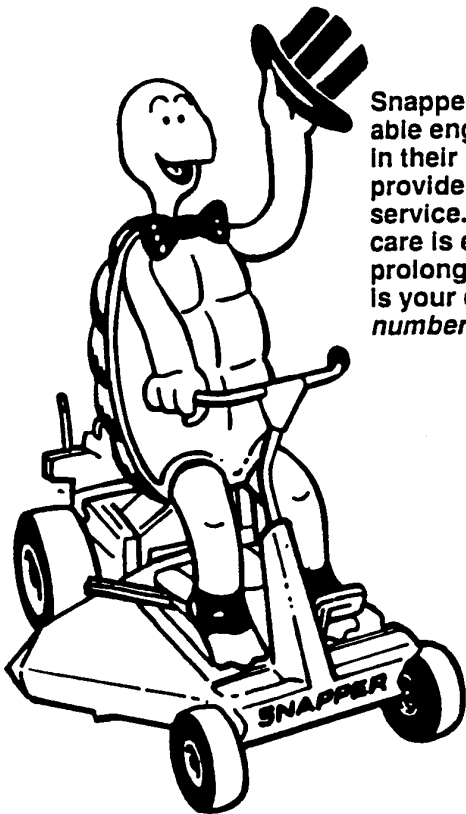

Snapper uses the best available engines and components in their products in order to provide long, satisfactory service. However, proper care is essential in prolonging engine life. Dirt is your engine's enemy number 1!

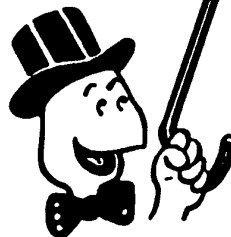
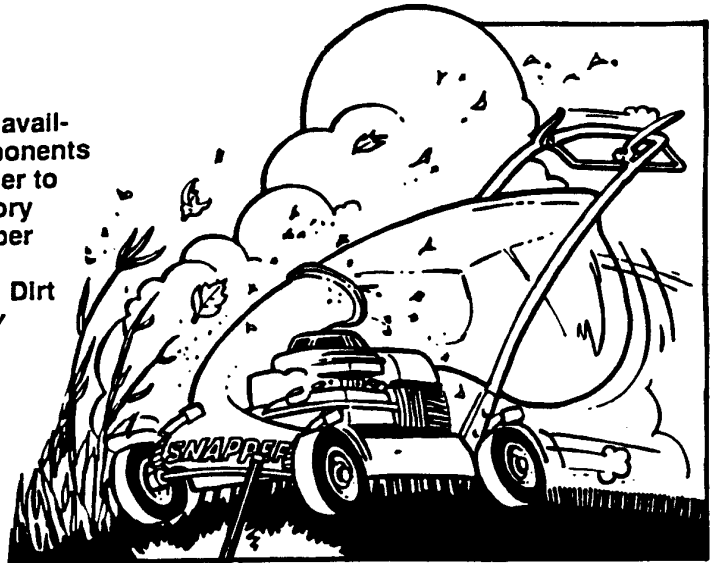

The engine on your Snapper product spends its entire life operating close to the ground at high speed creating a virtual storm of dust and dirt!

PRIMARY MAINTENANCE

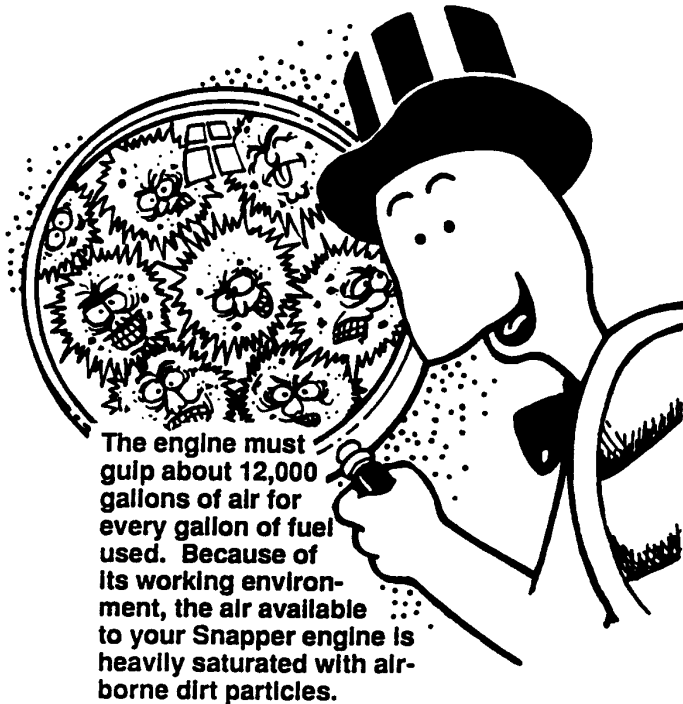

The engine must gulp about 12,000 gallons of air for every gallon of fuel used. Because of its working environment, the air available to your Snapper engine is heavily saturated with airborne dirt particles.

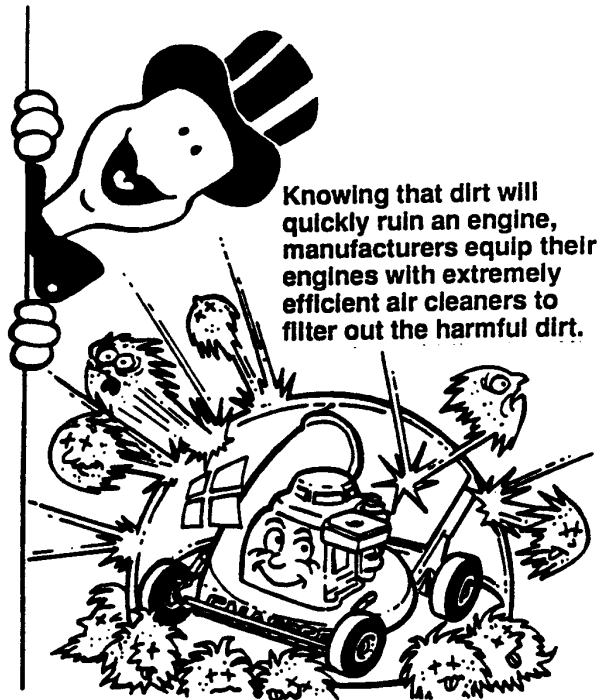

Knowing that dirt will quickly ruin an engine, manufacturers equip their engines with extremely efficient air cleaners to filter out the harmful dirt.

As the dirt particles are stopped, they build up and begin to clog the outside of the filter. This reduces the amount of air available to the engine and causes an over-rich fuel mixture which results in the following adverse effects:

An improperly serviced, dirt clogged air cleaner will:

1. Increase fuel consumption
2. cause power loss
3. result in hard starting
4. create smoke from unburned fuel
5. produce carbon build-up internally
6. foul spark plug electrodes
7. score cylinder walls
8. burn valves
9. wear out the engine prematurely
10. **COST YOU MONEY!**

Damage caused by a poorly serviced air cleaner is not covered under the engine warranties. So, save yourself unnecessary expenses and undue aggravation by keeping the air cleaner properly serviced at the intervals specified in the engine owner's manual.

It doesn't take long to service an air cleaner. Follow the specific instructions in the engine owner's manual for the type filter used. Prevent dirt from falling into the carburetor intake when servicing your air cleaner. Make sure components are installed in correct sequence after servicing to prevent unfiltered air from entering the engine. Some servicing hints on several common types are:

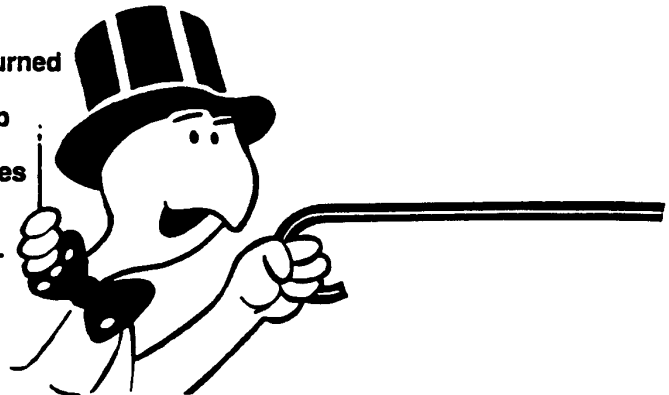
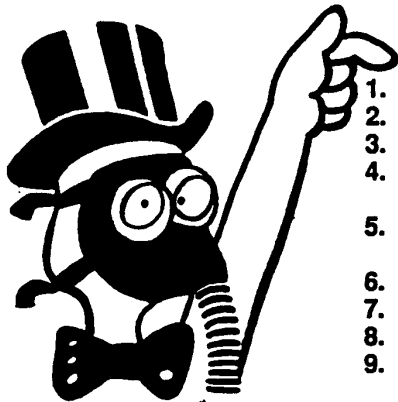

PRIMARY MAINTENANCE

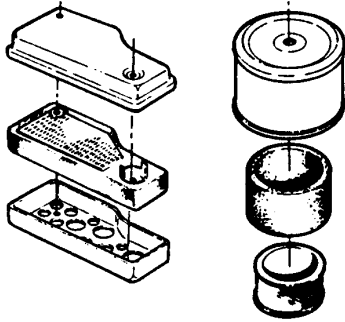

Generally, wash foam-type filters in a dishwashing detergent and water solution. Rinse and wring dry, then saturate with oil and squeeze out excess. *Failure to re-oil this type filter will ruin the engine.*

Clean paper elements by tapping lightly. Blowing with air will rupture paper elements.

Use a flashlight to detect clogged or torn paper elements - replace if damaged in any way.



Air is also needed to keep your engine cool. Dirt, dust & debris build up to restrict and clog cooling air intake screens and fins. Clean screens and fins at frequent intervals. The engine blower housing and shrouds should be removed at least once each season or more often under dry, dusty conditions for a thorough cleaning of fins.

Failure to keep external surfaces clean not only presents fire hazards, but causes overheating and resulting engine damages such as:

1. distorted valve guides
2. sticking valves
3. scuffed, scored cylinder walls
4. overspeeding
5. loss of power
6. complete failure of engine.

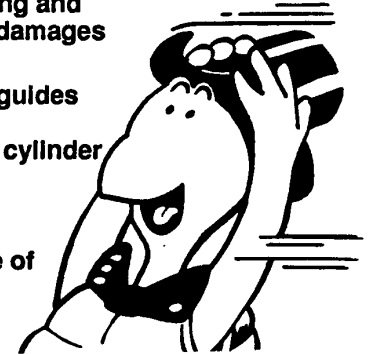

Dirt can also be introduced into an engine in dirty fuel from a contaminated container. Always use clean fresh fuel from a clean container to guard against dirt, sludge and water contamination.

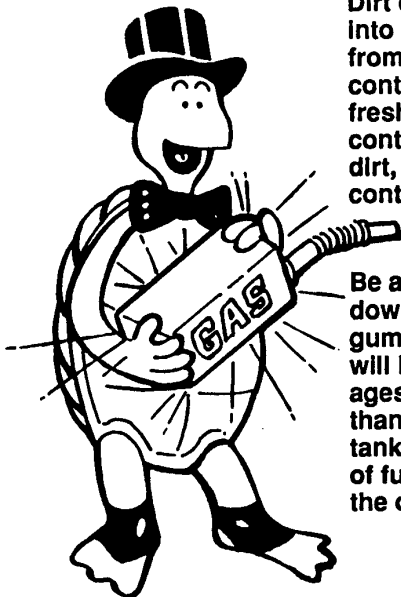

Be aware that fuel breaks down in storage and forms gummy compounds which will block carburetor passages. Never use fuel more than 3 months old. Drain tank then run the engine out of fuel before storing during the off-season.

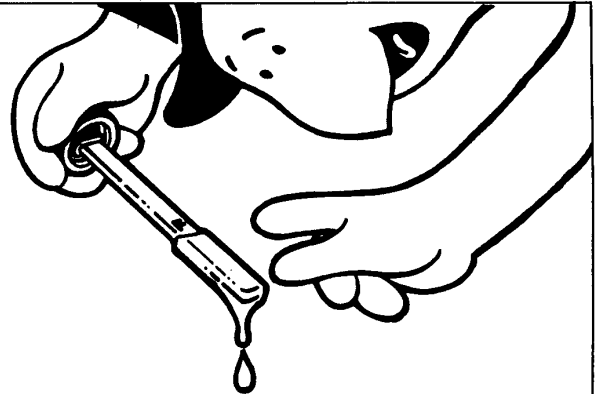

An engine must also have proper lubrication. All engines use some oil. On 4-cycle engines, **CHECK OIL LEVEL BEFORE EACH START-UP.** Wipe area clean around the oil check plug or dipstick opening to keep dirt from falling into the engine when checking the oil. Always check with the machine on a level surface. On engines with dipstick, keep the level up to, but not over, the **FULL** mark. When adding oil, allow time for all of the oil to flow down the fill tube to prevent a false full reading when the level could actually be low and result in engine damage.

PRIMARY MAINTENANCE

On 4-cyle engines with an oil level plug, don't be fooled into thinking the engine has sufficient lubricating oil if you can see "some" oil in the opening - the level should always be brought up to the point of overflowing at the top of the fill hole.

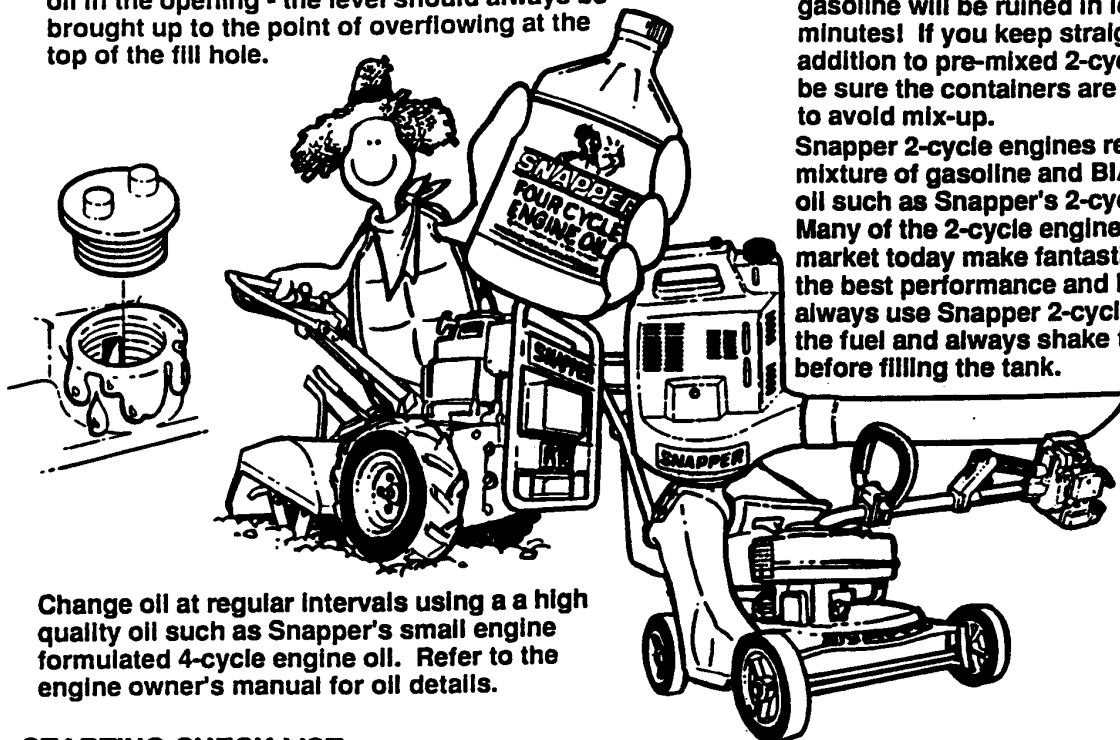

On 2-cycle engines, lubrication must be provided by an exact mixture of gasoline and 2-cycle air-cooled engine oil. A 2-cycle engine that is mistakenly run on straight gasoline will be ruined in less than 5 minutes! If you keep straight gasoline in addition to pre-mixed 2-cycle engine fuel, be sure the containers are clearly marked to avoid mix-up.

Snapper 2-cycle engines require a 32 to 1 mixture of gasoline and BIA certified TC-W oil such as Snapper's 2-cycle engine oil. Many of the 2-cycle engine oils on the market today make fantastic claims, but for the best performance and long engine life, always use Snapper 2-cycle oil. Pre-mix the fuel and always shake the container before filling the tank.

Change oil at regular intervals using a high quality oil such as Snapper's small engine formulated 4-cycle engine oil. Refer to the engine owner's manual for oil details.

STARTING CHECK LIST

- | | |
|------------------------------|--------------------------------------------------------------------------------------------------------------------------------------|
| 1. Engine Oil | <ul style="list-style-type: none"> • To full level (4-cycle) • Properly mixed with gas (2 cycle) |
| 2. Air Cleaner | <ul style="list-style-type: none"> • Clean and properly serviced • Full fresh clean gasoline |
| 3. Fuel Tank | <ul style="list-style-type: none"> • Fuel valve open • Cap vent open • Inline filter clean |
| 4. Choke | <ul style="list-style-type: none"> • Operating properly |
| 5. Primer (on some engines) | <ul style="list-style-type: none"> • Used properly |
| 6. Safety Interlock Switches | <ul style="list-style-type: none"> • In proper position • All wires properly connected |
| 7. Switch & Blade Control | <ul style="list-style-type: none"> • Switch On • Blade control properly positioned on walk mower |
| 8. Spark plug | <ul style="list-style-type: none"> • Wire connected • Good connection • Start position |
| 9. Throttle control | |
| 10. Blade | <ul style="list-style-type: none"> • Properly installed and torqued • Sharpened |
| 11. Muffler | <ul style="list-style-type: none"> • Good condition • Not clogged • Grass & leaves cleaned away |

Read and follow all safety instructions in safety booklets and manuals.

Keep in mind that dirt is your engine's *enemy #1* both internally and externally! Internally, dirt will quickly ruin an engine and externally it will cause overheating and resulting internal damages. Damage caused by improper lubrication, poor air cleaner service or overheating due to dirt cannot be covered under warranty.

It only takes a few moments to service the engine (and equipment) on a routine basis but the rewards will be a quick starting, responsive engine that will provide long satisfactory service with minimum maintenance cost. The prestart checklist in the next column and instructions in your Snapper Operator's Manual are designated to help you keep your Snapper in top operating condition with minimum effort!

Safety Instructions & Operator's Manual for

SNAPPER®

INTERMEDIATE REAR TINE TILLER SERIES 5

⚠ WARNING: The engine exhaust from this product contains chemicals known to the State of California to cause cancer, birth defects or other reproductive harm.

SNAPPER® McDonough, GA., 30253 U.S.A.

COPYRIGHT © 2001
SNAPPER INC.
ALL RIGHTS RESERVED

MANUAL No. 7-4270 (I.R. 11/31/01)

Free Manuals Download Website

<http://myh66.com>

<http://usermanuals.us>

<http://www.somanuals.com>

<http://www.4manuals.cc>

<http://www.manual-lib.com>

<http://www.404manual.com>

<http://www.luxmanual.com>

<http://aubethermostatmanual.com>

Golf course search by state

<http://golfingnear.com>

Email search by domain

<http://emailbydomain.com>

Auto manuals search

<http://auto.somanuals.com>

TV manuals search

<http://tv.somanuals.com>