



# Wall Mounted Mini Split Heat Pump Air Conditioner

OPERATING AND INSTALLATION MANUAL  
Model: KFHP-18-ID / KFHP-18-OD



**Indoor Unit.**



**Outdoor Unit.**

**Thank you for selecting Soleus Air. To ensure proper operation, please read this manual and keep it for future reference.**



---

---

# TABLE OF CONTENTS

USE AND MAINTENANCE.....	1-14
Precautions on Use .....	1-3
Specifications and Technical Data.....	4
Instructions of Use.....	5
Description of Air Conditioner Components.....	6
Remote Control Operation.....	7-8
How to Insert Batteries.....	9
Cleaning and Maintenance.....	10-11
Trouble-Shooting.....	12-14
INSTALLATION SERVICES.....	15-21
Precautions of Installation.....	15-16
Indoor unit Selection of Installation Position.....	15
Outdoor unit Selection of Installation Position.....	15
Electrical Safety Requirements.....	15-16
Grounding Requirement.....	16
Installation Dimension Drawing.....	17
Install Indoor Unit.....	18-19
Install Outdoor Unit.....	20-21
Checks Items After Installation and Test Run.....	21
ELECTRICAL SCHEMATIC DIAGRAM.....	22-23
Electrical Schematic Diagram (Indoor Unit).....	22
Electrical Schematic Diagram (Outdoor Unit).....	23
WARRANTY.....	24



Danger Caution.









This mark indicates a direction/procedure that must be followed!

**Thank you for selecting Soleus Air. To ensure proper operation, please read this manual and keep it for future reference.**

# Use and Maintenance

## ◆ Precautions on Use

<b>Carefully read the following precautions before use</b>		
<b>Warning</b>		
<p>★ In case of malfunction (e.g. burnt smell), cut off the power supply immediately and then contact the Authorized Service Center (626-820-1436).</p>  <p>The malfunction continues, the air conditioner may be damaged.</p>	<p>★ To avoid electric shock. Never operate the unit with wet hands.</p> 	<p>★ Do not cut or use damaged power cords and control lines.</p> 
<p>★ There is a possibility of electric shock or fire. To avoid electric shock or fire, use an approved circuit.</p> 	<p>★ Disconnect the power supply if you plan to discontinue using the unit for the season.</p> 	<p>★ Never use unapproved wire or controls.</p> 
<p>★ Please turn off the power before cleaning the air conditioner.</p> 	<p>★ Rated voltage of this air conditioner 208-230V~, with a tolerable fluctuation at 10%. Any other voltage will cause damage to the unit.</p>	<p>★ This unit requires a circuit breaker as specified by your building code.</p>

## ◆Precautions on Use

★Grounding: The unit must be properly grounded.



★Set the room temperature appropriately.

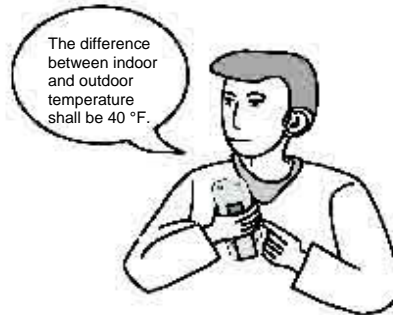

★Close all doors & windows for efficient operation.



★Never block the air inlet or outlet of indoor and outdoor unit.

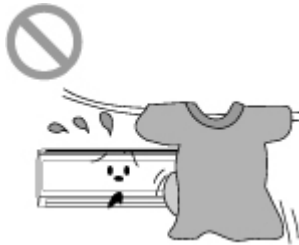

★To avoid the possibility of fire. Never store chemicals or flammable items within 3.28 feet of the unit.



Otherwise it may cause fire or explosion.

★To avoid damage make sure the mounting of the unit is secure.

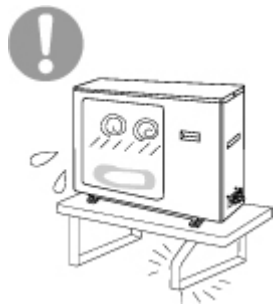

★To avoid damage never place any object on the condensing unit.



★Call an authorized service repair man if your unit malfunctions.

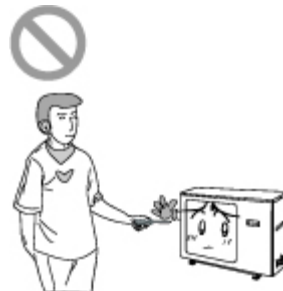

## ◆Precautions on Use

★Adjust the air flow and direction properly. When the air conditioner is running, you can press the SWING key on the remote control to adjust the guide louver and change the direction of air flow.



Guide Louver

★To avoid injury or damage, never stick your fingers or any other object into the unit.

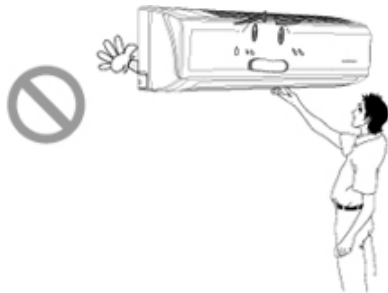

★To avoid harm to your pets or plants, never direct the airflow at them.

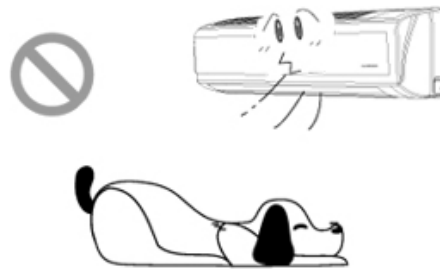

★To avoid damage or electric shock, never spray liquid onto the unit.



★To avoid carbon monoxide poisoning, never direct the airflow near or at your gas top burners.



★To avoid any harm to your health, do not blow the cold air on your body for long periods or decrease the room temperature too low.



★This air conditioner cannot be used for drying clothes or refrigerating foods.



## ◆ Specifications and Technical Data

Model		KFHHP-18-ID / KFHP-18-OD
Function		Heating and Cooling
Cooling capacity(BTU/hr) & (Watts)		18000 / 5300 (1400-6000)
Heating capacity(BTU/hr) & (Watts)		20000 / 6000 (1100-7000)
Rated voltage		208-230V~
Rated Frequency		60Hz
Cooling/Heating rated current(A)		10.6/10.6
Cooling/Heating rated power(W)		2440/2440
Cooling/Heating power input(W)		1350/1800
SEER		13.25
EER/COP(W/W)		3.93/3.22
HSPF		8.5
Recycling Air Volume (m <sup>3</sup> /h)		800
Factory Charge 410A (lbs.)*		R410A 3.9 lbs
Noise (Indoor/Outdoor) dBA		50/57
Height Differential	Maximum Vertical	16.4 ft
	Maximum Length	32.8 ft
Net Weight (Indoor/Outdoor) (lb)		28.7/130.1
Dimensions (Indoor/Outdoor) (WxDxH)(inch)		Indoor unit : 40.16" × 8.98" × 12.20" Outdoor unit: 37.40" × 13.39" × 26.93"

### Connection Pipe:

Length (ft)		26.25
Gas additional charge(oz/ft)		0.21
Outer Diameter	Liquid Pipe (mm)	Φ 9.52(5/8")
	Gas Pipe (mm)	Φ 16(3/8")
Max Distance	Height (ft)	26.25
	Length (ft)	49.21

- ❖ All above are tested and certified to ETL specification. Among them, the cooling capacity, heating capacity and noise level are tested before shipment.
- ❖ In case of any change in performance parameters, the data provided on nameplate shall prevail.
- ❖ Test the maximum input power under maximum cooling condition (89.6°F /73.4°F, 109.4°F /78.8°F) and maximum heating condition (44.6°F /-, 75.2°F /69.8°F).
- ❖ Working temperature range

	Indoor side DB/WB(°F)	Outdoor side DB/WB(°F)
Maximum cooling	89.6 / 73.4	109.4 / 78.8(T1)
Minimum cooling	69.8 / 59	64.4 / -
Maximum heating	80.6 / -	75.2 / 64.4
Minimum heating	68 / -	19.4 / 17.6

## ◆ Instructions for Use

### Principle and Special Functions during Cooling Mode

#### Principle:

The air conditioner absorbs heat from indoor air and transmits it outdoors for discharge, hence to decrease the indoor ambient temperature. The cooling capacity decreases with the rise of outdoor ambient temperature.

#### Anti-freeze Function:

If the air conditioner is running under low-temperature cooling mode, frost will appear on the surface of indoor heat exchanger. When the temperature of indoor heat exchanger is decreased to 32°F or below, the microcomputer of indoor unit will stop the compressor to protect the complete unit. A low ambient kit [not supplied] is required to make unit operate at lower than 32°F.

### Principle and Special Functions under Heating Mode

#### Principle:

- \* The air conditioner absorbs heat from outdoor air and transmits it indoors for emission, hence to increase the air temperature in the room. The heating capacity decreases with the reduction of the outdoor ambient temperature.
- \* It takes only a short time for this type of hot air circulating system to increase the indoor temperature.
- \* Use this air conditioner with other heating equipment if the outdoor temperature is extremely low.

#### Defrost:

- \* When the outdoor temperature is low but the humidity is high, the heat exchanger of outdoor unit may freeze after the air conditioner has run for a period of time. This will decrease the heating effect. In this case, auto defrost function will be activated and the heating mode will temporarily stopped for 8-10 minutes.
- \* Both the indoor fan and outdoor fan will be stopped during auto defrost.
- \* During defrost, the indicator on indoor unit will blink and steam might flow from the indoor unit. This is caused by quick defrost other than fault.
- \* Heating mode will automatically resume upon completion of defrost process.

#### Anti-freeze Function:

Under heating mode, if the indoor heat exchanger fails to reach a specific temperature under the following conditions, the indoor fan will not be started, so as to avoid blowing of cold air (within 3 minutes):

1. Start of heating mode.
2. End of auto defrost.
3. Heating under low-temperature environment.

#### ★ Conditions that the Air Conditioner will be unable to run normally:

The protection device will be activated within such temperature range as specified below, so that the unit will be shut down.

Heating Mode	Outdoor temperature over 75.2°F	Cooling Mode	Outdoor temperature over 109.4°F	Dehumidify Mode	Room temperature below 64.4°F
	Outdoor temperature below 19.4°F		Room temperature below 69.8°F		
	Room temperature over 80.6°F				

If the unit is run for extended periods under high humidity (80%+) condensation will be present at the outlets.

## ◆ Description of Air-Conditioner Components

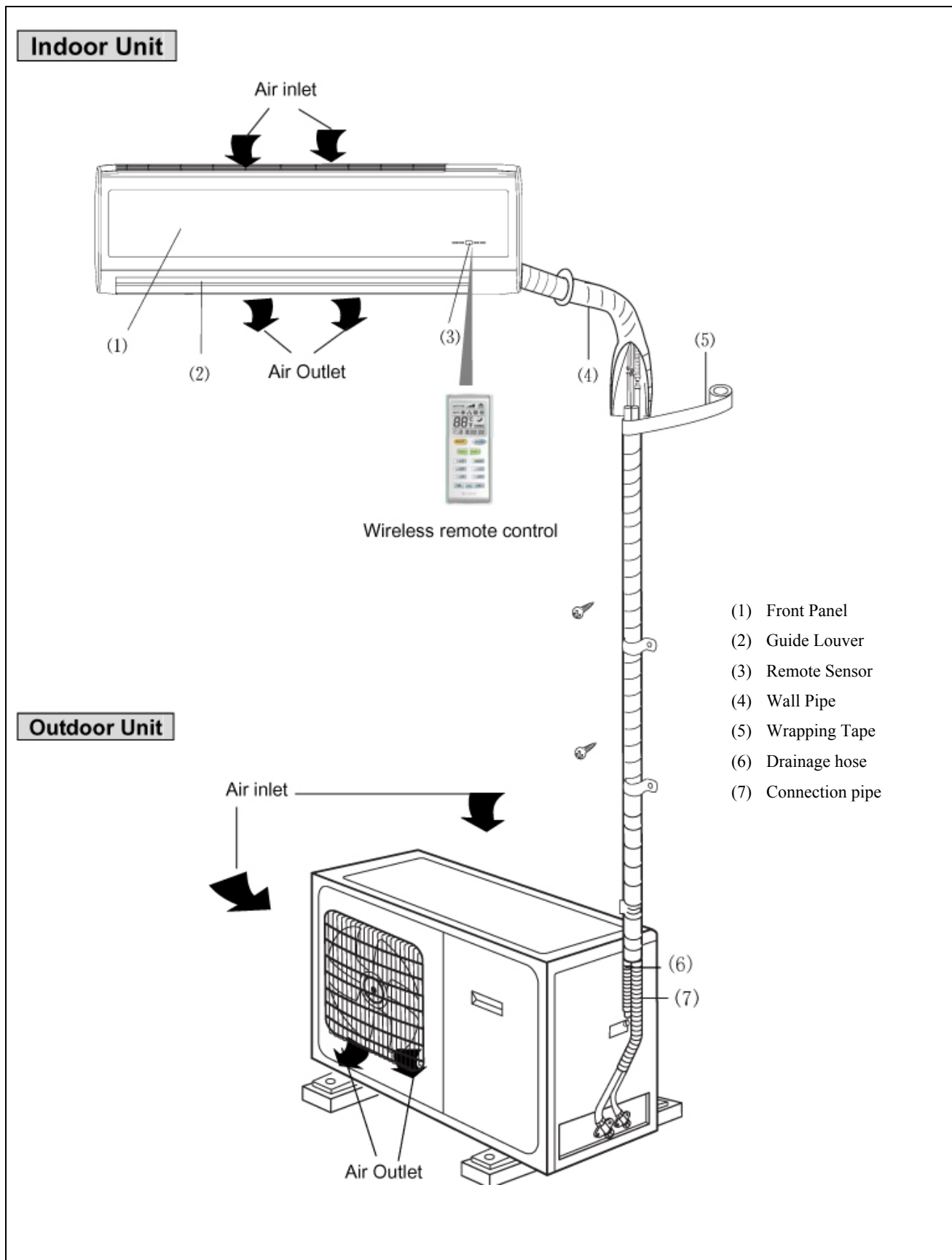



## ◆ Remote Control Operation

### Function-Remote control

#### Note:

- Don't drop the remote control.
- Don't place the remote control in a location exposed to direct sunlight.
- When the unit is restarted after stopped, it will automatically resume its last running mode, and the outdoor unit will start there after.

#### TEMP+ TEMP- Button:

Under the COOL, DRY, FAN or HEAT mode, press these two buttons could set the temperature, the temp. setting range is 60.8°F -86°F, the temp. can be memorized under each mode.

#### FAN SPEED Button:

When the unit starts up, under the AUTO, COOL, FAN or HEAT mode, press this button and select Auto fan, Low fan, Middle fan, High fan. At DRY mode, the fan speed runs at Low fan speed. The FAN SPEED can be memorized under various modes.



#### SLEEP Button:

Under COOL, DRY & HEAT mode, press the button once to start the SLEEP function, when pressed again, it will stop.

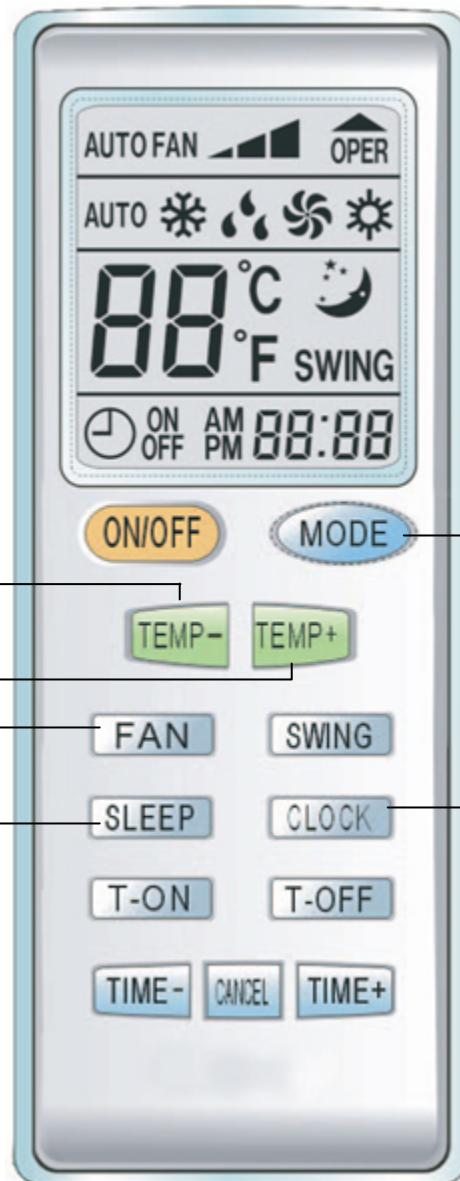

#### MODE Button:

When the unit is turned on, press this button. The AUTO, COOL, DRY, FAN or HEAT mode can then be selected.

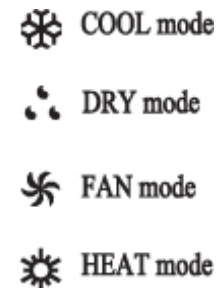

#### CLOCK Button:

When pressing this button once, the icon of CLOCK will flash, and can be adjusted. At CLOCK adjustment, press the TIME+ once, the ones placed on the minute will be increased 1, and continuously press 1 sec above, the tens place on the minute will be increased 1 in every half second. When pressing the TIME-, the ones placed on the minute will be decreased 1, and continuously press 1 sec above, the tens place will be decreased 1 in every half second. After adjusting please press the CLOCK button again for confirming.

## ◆ Remote Control Operation (Continued)

Liquid Crystal Display.  
It shows all set contents.

ON/OFF Button  
Press ON.  
Press OFF.

T-ON Button.  
When pressing this button once, enter into T-ON setting, the icon of T-ON flash, every press of TIME+, the time of T-ON will be increased 1min.  
When continuously press 1 sec above, the tens placed on minute will be increased 1, every press of TIME- will be decreased 1 minute, when continuously press 1 sec above, the tens placed on minute will be decrease 1 in every half second, and it goes round with 12 hours.

SWING Button:  
Press once to have louvers swing [oscillate]. Press twice in one second the panel light will turn on. Press twice again and the light will turn off.

T-OFF Button  
Press this button once to enter into T-OFF setting, the icon of T-OFF will flash, the T-OFF button is available in ON or OFF mode, the setting method is the same with T-ON.

CANCEL Button  
Pressing this button will cancel timer.

TIME+ TIME- Button  
Function instruction please refer to T-ON button, T-OFF button, CLOCK button.

## ◆ How to Insert Batteries

1. Remove the cover from the back of the remote control.
2. Insert the two batteries (Two AAA dry-cell batteries).
3. Re-attach the cover.

### NOTE:

- Don't mix different batteries.
- Remove batteries when not in use for a longtime.
- The batteries can be used for about one year.
- Keep remote at least 3.28 feet from TV's and other electronic devices.

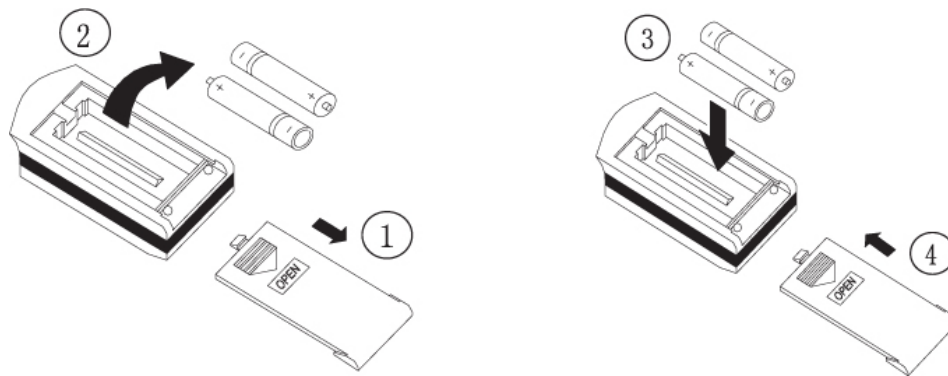

### Emergency running

When the wireless remote control is lost or broken, please use the manual switch, It will start in AUTO mode, the temperature setting and fan speed cannot be changed. Please use a ball point pen or similar device to operate switch.

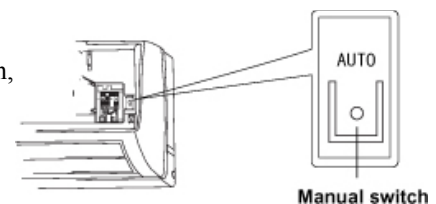

Turn on the unit: By pressing the Manual Switch the unit will start in AUTO automatically. The microcomputer will adjust to the indoor temperature by selecting (COOL, HEAT, FAN), in order to achieve a comfortable condition.

- Turn off the unit: When unit is running, press the manual switch STOP button, the unit will stop running.

## ◆ Cleaning and Maintenance



### Warning

- Be sure to cut off the power supply before cleaning the air conditioner; otherwise electric shock might occur.
- Liquids on the air conditioner may cause the risk of electric shock. Make sure not to spray wash your air conditioner in any case.
- Volatile liquids such as thinner or gasoline will cause damage to the appearance of air conditioner. (Only use soft dry cloth or wet cloth soaked with neutral detergent to clean the air conditioner cabinet).

### Clean the front panel (Don't remove the front panel when cleaning).

When the indoor unit front panel is dirty, please use the cloth which is soaked in the warm water under 104°F, then dry it and wipe the dirty places.

#### NOTE:

There are microcomputer components and circuit board on the display of the indoor unit front panel, never let it dip in the water.

### Clean filter (Approximately every three months)

Note: Clean the air filter more frequently if the air conditioner is used under dusty environment. To avoid injury, do not touch the fins of indoor unit with your finger after removing the filter.

#### ① Remove the air filter

Hold the groove on two ends of the front panel. Along arrow direction, pull with force to open the front panel for an angle. Then pull the air filter downward for removal. See Fig. 5 (a, b, c)

#### ② Clean the air filter

Wash the filter with vacuum cleaner or water. If the filter is too dirty, wash with warm water (below 113°F) with neutral detergent. Then air dry it at a cool place.

**Note: To avoid discoloring or deformation, do not wash with hot water over 113°F. Never dry on the fire, as the filter may be burnt or deformed.**

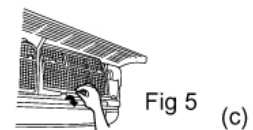
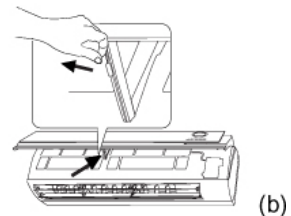
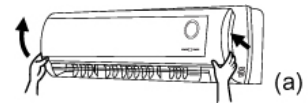
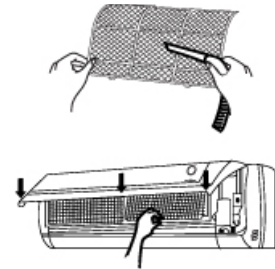

Fig 5 (c)

## ◆ Cleaning and Maintenance

### ③ Installing the air filter

Mount the air filter in the direction of the arrows. Then, clamp the cover of front panel securely.



### Check before Seasonal Use

- ① Check the air inlet/outlet on indoor and outdoor units for any blockage.
- ② Check the grounding cable for reliability.
- ③ Check the batteries of remote control for replacement.
- ④ Check the mounting frame of outdoor unit for damage. If damaged, please contact the Authorized Service Center.

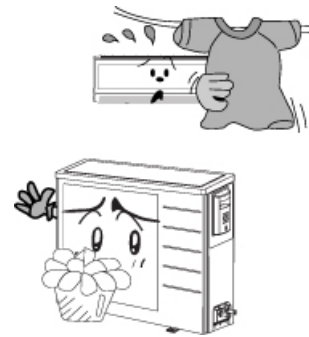

### Check after Seasonal Use





- ① Cut off the power supply to air conditioner.
- ② Clean the filter and the indoor/outdoor unit.
- ③ Clear off the dust and foreign particles on outdoor unit.
- ④ If the outdoor unit is rusted, paint on the rusty portion to prevent corrosion.

## ◆ Trouble-Shooting



### Warning

Do not repair by yourself. Incorrect repair may cause electric shock or fire, so please contact the Authorized Service Center for professional repair.

Fault	Cause Analysis
<p>Air conditioner does not run upon immediate restart after a stop.</p> 	<p>To protect the air conditioner upon immediate restart after a stop, the microcomputer control will delay the unit for 3 minutes before the air conditioner will run.</p>
<p>Air conditioner blows out a bad odor when it is initially started.</p> 	<p>The air conditioner itself has no bad odor. If any, it is the bad odor accumulated from the environment. Solution: Clean the air filter (Refer to Page 10). If the problem persists please call the Authorized Service Center.</p>
<p>You may hear a “water flowing” noise when the air conditioner is running.</p> 	<p>The noise you hear is the refrigerant in the system.</p>
<p>Sometimes a thin fog will flow out of the outlet when the air conditioner is running under cooling mode.</p> 	<p>This might occur when indoor temperature and humidity are high. This is because the indoor air is quickly cooled down. After a period of time, the fog will disappear with the decrease of indoor temperature and humidity.</p>
<p>You may hear a slight crack when the air conditioner is started or stopped.</p> 	<p>This is the sound of friction caused by expansion of panel or other parts due to the change of temperature.</p>

## ◆ Trouble-Shooting

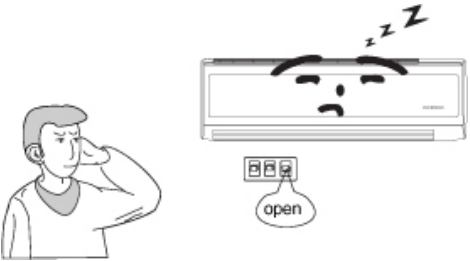
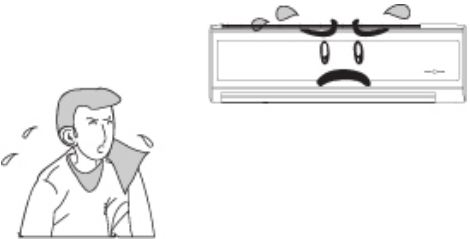
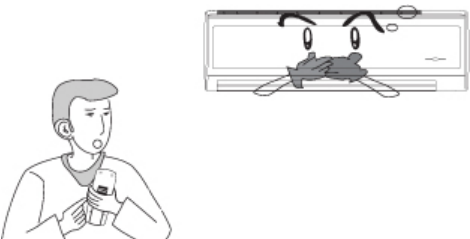
Fault	Cause Analysis
<p>Air conditioner does not run.</p> 	<ul style="list-style-type: none"> <li>• Power failure?</li> <li>• Circuit protection device tripped?</li> <li>• The voltage is too high or too low? (Refer to Page 15). (To be tested by professional technicians).</li> <li>• Timer function is correctly used? (Refer to Page 7).</li> </ul>
<p>Air conditioner is poor in cooling (or heating) effect.</p> 	<ul style="list-style-type: none"> <li>• Is temperature setting proper? (Refer to Page 7)</li> <li>• Is the air inlet or outlet of outdoor unit blocked?</li> <li>• Is the air filter clogged by dust? (Refer to Page 10).</li> <li>• Are all doors and windows closed?</li> <li>• Is air flow set to “LOW FAN”?</li> <li>• Is any other heating source in the room?</li> </ul>
<p>Remote control cannot execute control.</p> 	<ul style="list-style-type: none"> <li>• Remote control sometimes cannot execute control if the air conditioner is subject to abnormal interference or frequent switching of functions. To resume normal operation, just pull out the battery and reinsert it properly.</li> <li>• Is remote within receivable range or blocked by any obstacles? (Refer to Page 7)</li> <li>• Check the battery in remote control for power level. If low power, replace the battery. (Refer to Page 9)</li> <li>• Is the remote control is damaged.</li> </ul>
<p>Water leaks from indoor unit.</p>	<ul style="list-style-type: none"> <li>• Room air humidity is excessively high.</li> <li>• Condensation water overflowing.</li> <li>• Connection of indoor unit drain pipe is leaking.</li> </ul>
<p>Water leaks from outdoor unit.</p>	<ul style="list-style-type: none"> <li>• Under cooling mode, water might condense on pipe or pipe joint due to cooling.</li> <li>• Defrosted water flows out under heating or defrost (auto defrost) mode.</li> <li>• Under cooling mode, water attached on heat exchanger will drip.</li> </ul>
<p>Indoor unit has unusual noise.</p>	<ul style="list-style-type: none"> <li>• The sound that the fan or compressor relay is switching (close/open).</li> <li>• Air conditioner may give out sounds under defrost or when it is stopped. This is caused due to inverse flow of refrigerant in the unit.</li> </ul>

## ◆Trouble-Shooting

Fault	Cause Analysis
No air blows out from indoor unit.	<ul style="list-style-type: none"> <li>• When the temperature of indoor heat exchanger is low during heating process, the indoor unit will stop blowing to prevent blowing of cold air (within 3 minutes).</li> <li>• Under dehumidify mode, the fan of the indoor unit might be stopped to prevent evaporation of condensing water and inhibit the rise of temperature.</li> </ul>
Moisture exists on outlet grill.	<ul style="list-style-type: none"> <li>• If the unit is run for extended periods under high humidity condensation will be present at the outlets.</li> </ul>



**In the event of any of the following, please contact Authorized Service Center.**

- ▲ Air conditioner gives out shrill noise during running.
- ▲ Air conditioner gives out bad smell during running.
- ▲ Water leaks indoors.
- ▲ Air break switch or leakage protection switch trips frequently.
- ▲ Foreign matters or water are poured into the machine or remote controller.
- ▲ Abnormal overheating of power cord and plug.



Stop the air conditioner and pull out the power plug.



# Installation Services

## ◆ Precautions on Installation



### Important Caution

1. The air-conditioning unit must be installed by professional technicians in accordance with the state and local codes.
2. Contact the local installation and service agency before installation.
3. For relocation of the air conditioner to another position, please contact the local Authorized Service Center.

### Basic Requirements for Installation Position

Installation at the following places may cause failure of the air conditioning unit. Please contact installation and service agency if the installation at such places cannot be avoided.

- Any environment where the strong heat, steam, flammable or explosive gas exists or the volatile matters are distributed in the air.
- Any place close to high-frequency facilities, e.g. welding machine, medical equipment.
- A region with saline-sodic soil near the ocean.
- A place where the air contains oil (mechanical oil).
- A place with sulphide gases (such as sulphur spring).
- Any environment with special conditions.

### Indoor unit Selection of Installation Position

1. The air inlet and air outlet must be away from obstacles to ensure that airflow can reach every corner of the room.
2. Choose a position where condensation water can be easily discharged and the outdoor unit can be easily connected.
3. Install the unit in a place where the children can not reach.
4. Choose a place where the weight of indoor unit can be withstood and operating noise and vibration are not increased.
5. Ensure sufficient clearance and space for service and maintenance; Ensure the indoor unit is at least 2.3m from the floor.
6. Choose a position at least 3.28 feet from any TV, sound system or other household electric appliances.
7. Choose a place so that the air filter can be easily pulled out.
8. Ensure the installation of indoor unit is in conformity with the requirements of installation dimension drawing. (図紙 page 17)

### Outdoor unit Selection of Installation Position

1. The place where the noise and air flow from the fan will not affect the neighbors, animals or plants.
2. Ensure good ventilation of outdoor unit.
3. No obstacles near the outdoor unit obstructing the air intake and air exhaust of the unit.
4. The installation position shall be able to withstand the weight and vibration of the outdoor unit and ensure safe installation.
5. Select a dry place but not exposed to direct sunshine or strong wind.
6. Ensure that the outdoor unit is installed in compliance with installation dimensions for easy repair and maintenance. (図紙 page 17)
7. Height difference of fitting pipes shall be within 16.4 feet and the length of fitting pipe shall be within 32.8 feet.
8. Install the unit in a place where the children can not reach.
9. A place not affecting the public passage or city view.

### Electrical Safety Requirements

1. The power supply must be of rated voltage via special circuit for air conditioning. The wire size of power lines shall conform to code.
2. Applicable voltage range: the normal operation range of voltage is 90%~110% of rated voltage.
3. Do not pull the power line with force.

## ◆ Precautions on Installation

4. Ensure safe grounding and the grounding wire shall be connected with the special grounding equipment of the building and must be installed by professional technicians. In the fixed line there must be an electrical leakage protection switch and an air switch with sufficient capacity. The air switch shall also have the magnetic tripping and thermal tripping functions to achieve protection of both short-circuit and overload.
5. The minimum clearance between air conditioner and flammable surface is 1.5m.

### Grounding Requirement

1. This air-conditioning unit is a Class I electrical appliance, reliable grounding measures must be taken for it.
2. The double color (yellow and green) cable inside the air conditioner is for grounding and shall not be used for other purposes nor can it be cut. Do not tighten with tapping screw; otherwise electric shock is possible.
3. The ground resistance shall be in conformity with the state and local codes.
4. The unit must be properly grounded. It is prohibited to connect the grounding wire to the following items:
  - ① Water Supply Pipe
  - ② Gas Pipe
  - ③ Sewage Pipe
  - ④ Other positions that are considered to be unreliable by professionals.

# ◆ Installation Dimension Drawing

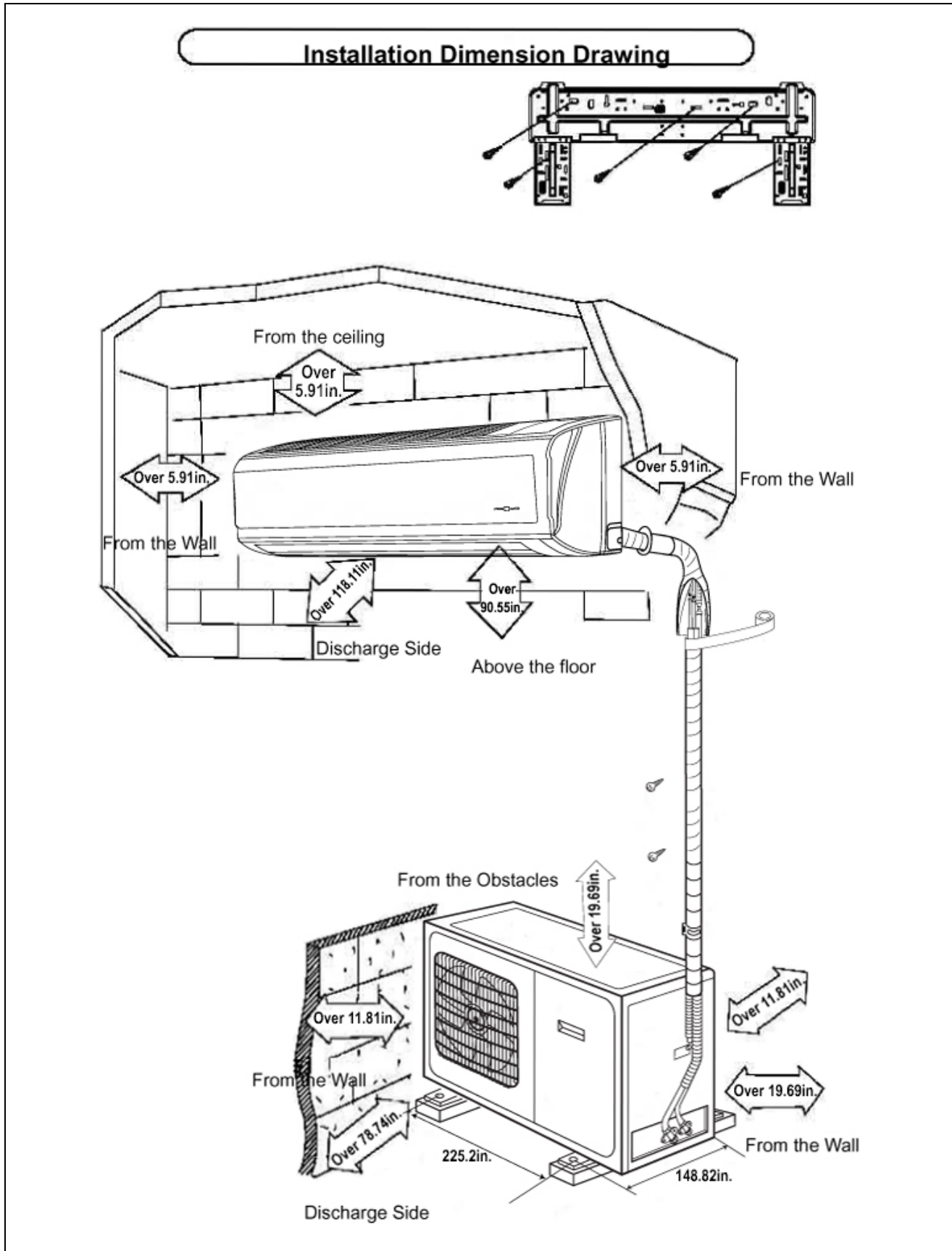

## ◆ Install Indoor Unit

### Installing Wall-Mounting Frame

1. Level with plumb line or spirit level. As the drain outlet is on left side, it is better that the left side shall be lower when adjusting the wall-mounted board.
2. Use screws to secure the wall-mounting frame on the wall.
3. After installation is completed, manually pull the wall-mounting frame to check if it is secured. The mounted frame shall be able to withstand the weight of an adult (132 lbs) and the fixing screws shall have relatively even stress.

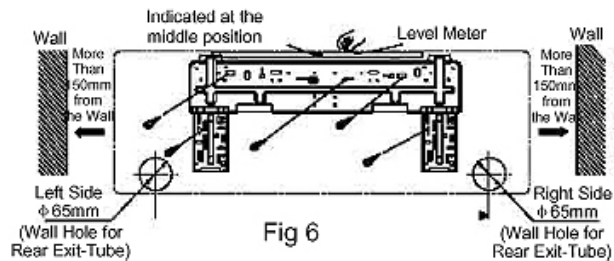

### Wall Opening and Wall Pipe Installation

1. After deciding the hole position of the fitting pipe according to Figure 6, drill a declining hole (Φ65)
2. To prevent the fitting pipe and the cable passing through the wall from being harmed, it is necessary to install a wall pipe.

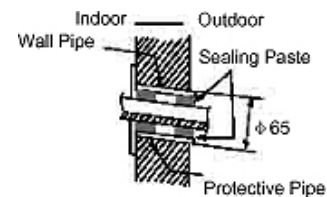

### Installing Drainage Pipe

1. The flexible drainage pipe must descend to allow smooth running of water.
2. Pay attention not to allow twists, ridges and distortion of the drainage pipe in the layout and not to immerse the outlet in water.
3. Extended part of flexible drainage pipe passing through the indoor unit must be wrapped by thermal insulation material.

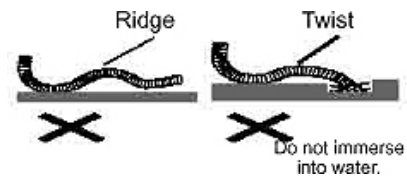

### Connection of Indoor and Outdoor Cables

1. Pull open the front panel from the above. (Refer page 10 Fig5 (a))
2. Unscrew the screw fixing the covering plate of terminal board.(Fig 7)
3. Pass the power cable through a separate cable duct on the back of indoor unit and pull it out from the front.
4. Connect the Neutral wire of the power connection cables to the “N (1) ” terminal of the terminal board, connect the Signal wire to the “2” terminal and connect the Live wire to the “3” terminal and connect the grounding wire to the “⊕” terminal (See Fig. 8).
5. Place the section of power cable with protective pipe into pressing groove and close the cover plate. Tighten the fixing screws to clamp the connecting cable.
6. Install the front panel back into position

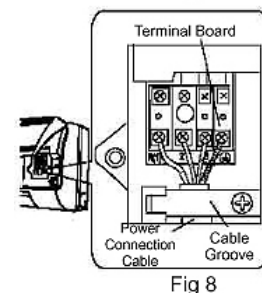
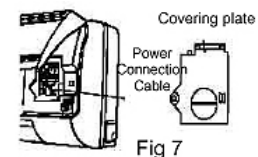

## ◆ Install Indoor Unit

### Notes:

If the connecting cable is not long enough, please contact your distributor for a piece of special cable with sufficient length. No joints are allowed in the middle of the cable.

- Be sure to connect the cable correctly. Incorrect connection will cause fault to some electrical parts.
- Tighten the terminal screw.
- After tightening the screw, gently pull the cable for tightness.
- Incorrect connection of grounding cable might cause electric shock.
- Be sure to fit the junction cover plate securely and press it closely against connecting cable. Improper fitting of junction over plate might allow dust or water to enter or expose connecting terminal directly under the external force, fire or electric shock might occur.

### Installing the Indoor Unit

- Fitting pipe can come out from one of four directions, i.e. right, rear right, left and rear left.

1. When laying the pipe (line) at the left or right side cut as needed the extra part of the fitting pipe left at the tube-exit plate of the unit base. (See Fig. 9).
  - (1) When only drawing out the power line, cut extra part 1.
  - (2) When drawing out the connecting pipe and the electrical line, cut extra parts 1 & 2 (or 1, 2 & 3).
2. Pull out the fitting pipe from bottom case. Use adhesive tape to bond the fitting pipe, electrical cable and drain hose properly together and then pass them through the fitting pipe hole (See Fig. 10).
3. Hang the claws at the rear side of the indoor unit to the hook on the wall-mounting frame. Move the unit left and right to see if it is steady. (See Fig 11)
4. The installation height of the indoor unit must be at least 78.74in.

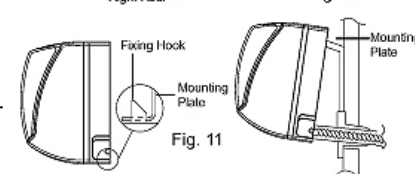
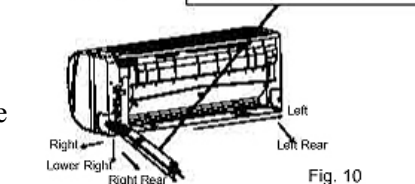
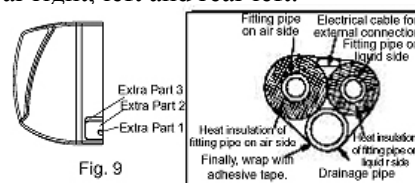

### Installing Connecting Pipe

1. The taper end of the connecting pipe must be in line with the corresponding tape face of the valve joint.
2. Use enough force to manually tighten the nut of the connecting pipe and then use spanner to tighten the nut.

Hexagon Nut (mm)	Tightening Torque (N.m)
φ 6.	15~20
φ 12	50~55

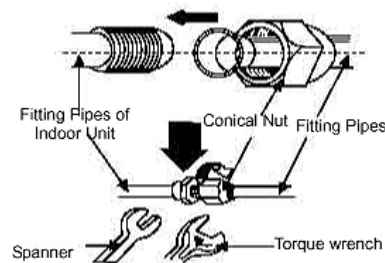

### Notes:

Connect the connecting pipe to the indoor unit first and then connect it to the outdoor unit. Pay attention to the bending and layout when preparing the connecting pipe in order not to harm it. Do not screw the joint nut too tight, otherwise leakage will occur.

## ◆ Install Outdoor Unit

### Power Cable Connection

1. Remove the handle at the right side plate of the outdoor unit (one screw).
2. Remove the cable clamp, connect the power connection cable with the terminal at the row of connection and make the connection. The fitting line distributing must be consistent with the indoor unit.
3. Use cable clamp to make the cable connection cable.
4. Confirm the fitting lines are properly installed.
5. Install the handle (fixed by one screw).

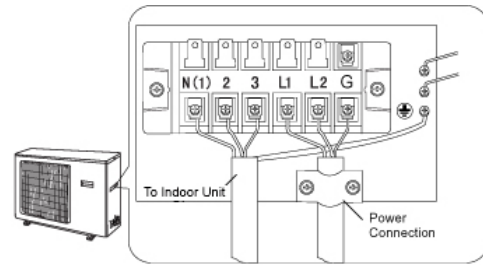

#### Notes:

- Improper line connection may cause failure of some electrical components and parts
- When fixing the cable, a certain degree of play shall be maintained for the cable between the connection point and the fixing point.

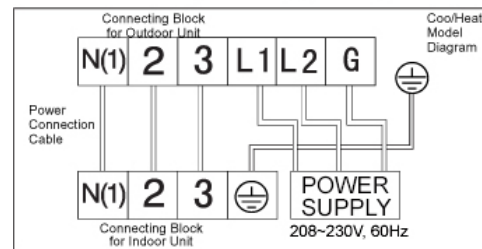

### Vacuum – Pumping and Leakage Inspection

1. Remove the nut cover at the shutoff valve.
2. Align with the center of the fitting pipe and manually tighten the conical nut sufficiently.
3. Use spanner to tighten the conical nut.
4. Remove the liquid valve cap, the gas valve cap and the nut of refrigerant charging mouth.
5. Use inner hexagon spanner to twist off the liquid valve body and at the same time use screwdriver to open the valve core of the liquid valve. Now gas shall flow out.
6. After gas continues flowing out for about 15 second and refrigerant gas begins to flow out, close the valve core and tighten the nut of refrigerant charge mouth.
7. Completely open the valve body of the liquid valve and the gas valve. (See Fig 12)
8. Turn and tighten the valve cap, then use soap water or a leak detector to check if there is gas leakage at the outdoor and indoor units and the pipeline connections.
9. If conditions permit, use a vacuum pump to exhaust air in the unit from the valve core. (See Fig 13)

Fig 12

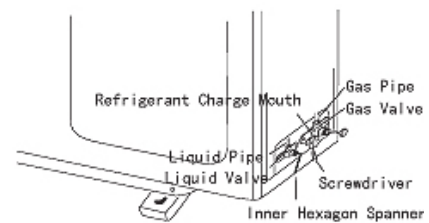
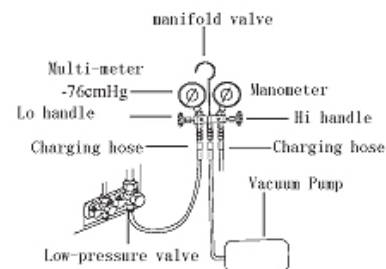

Fig 13



### Draining of Condensate Water of Outdoor Unit

When the air-conditioning unit is in the heating mode, the condensate water generated at the outdoor unit and the water generated by defrosting shall be drained through the drainage pipe to proper place.

Installation methods: As shown in Figure, insert the drainage joint of the outdoor unit into the  $\Phi 25$  hole on the base plate. Connect the drainage pipe to the drainage mouth so as to drain the condensate water and water generated by defrosting to proper place.

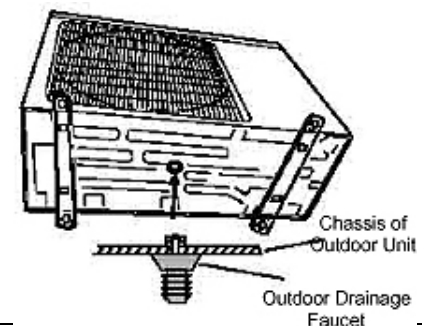

## ◆ Install Outdoor Unit

### Check Items After Installation

Check Items	Problems Owing to Improper Installation
Is the installation reliable?	The unit may drop, vibrate or make noises
Has the refrigerant gas leakage been checked?	May cause unsatisfactory cooling (heating) effect
Is the thermal insulation of the unit sufficient?	May cause condensation and water dripping
Is the drainage smooth?	May cause condensation and water dripping
Does the power supply voltage accord with the rated voltage specified on the nameplate?	The unit may break down or the components may be burned out
Are the lines and pipelines correctly installed?	The unit may break down or the components may be burned out
Has the unit been safely grounded?	Risk of electrical shock or electrocution.
Are the models of lines in conformity with requirements?	The unit may break down or the components may be burned out
Are there any obstacles near the air inlet and outlet of the indoor and outdoor units?	The unit may break down or the components may be burned out
Have the length of refrigerating pipe and refrigerant charge amount been changed?	It is not easy to measure the charge amount of refrigerant.

### Test Run

#### 1. Preparation of Test Run

- (1) Do not switch on the power before all installation work is completed.
- (2) Confirm that the control line is correctly installed and all electrical lines are firmly connected.
- (3) Open the shutoff valves of the big and small lineset.
- (4) Remove all foreign articles, especially metal scraps, line ends and forceps, from the unit.

#### 2. Method of Test Run (参照 page 17)

- (1) Connect to the power supply, press the “ON/OFF” key on the remote controller, and the air conditioning unit starts to operate.
- (2) Press the Mode key, select the operating modes such as cooling and fan, and observe if the operation is normal.

# Electrical Schematic Diagram

## ◆ Electrical Schematic Diagram (Indoor Unit)

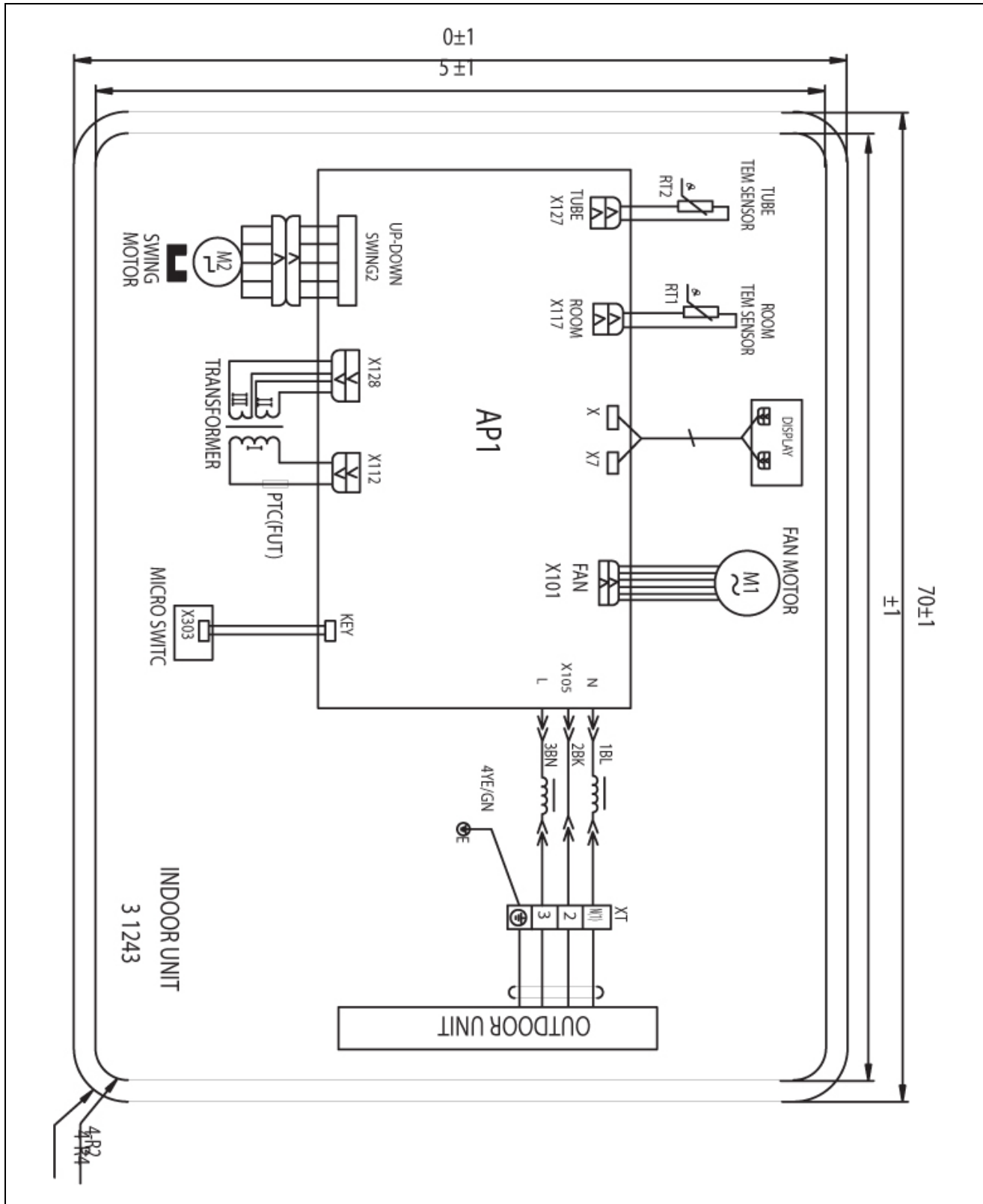



# ◆ Electrical Schematic Diagram (Outdoor Unit)

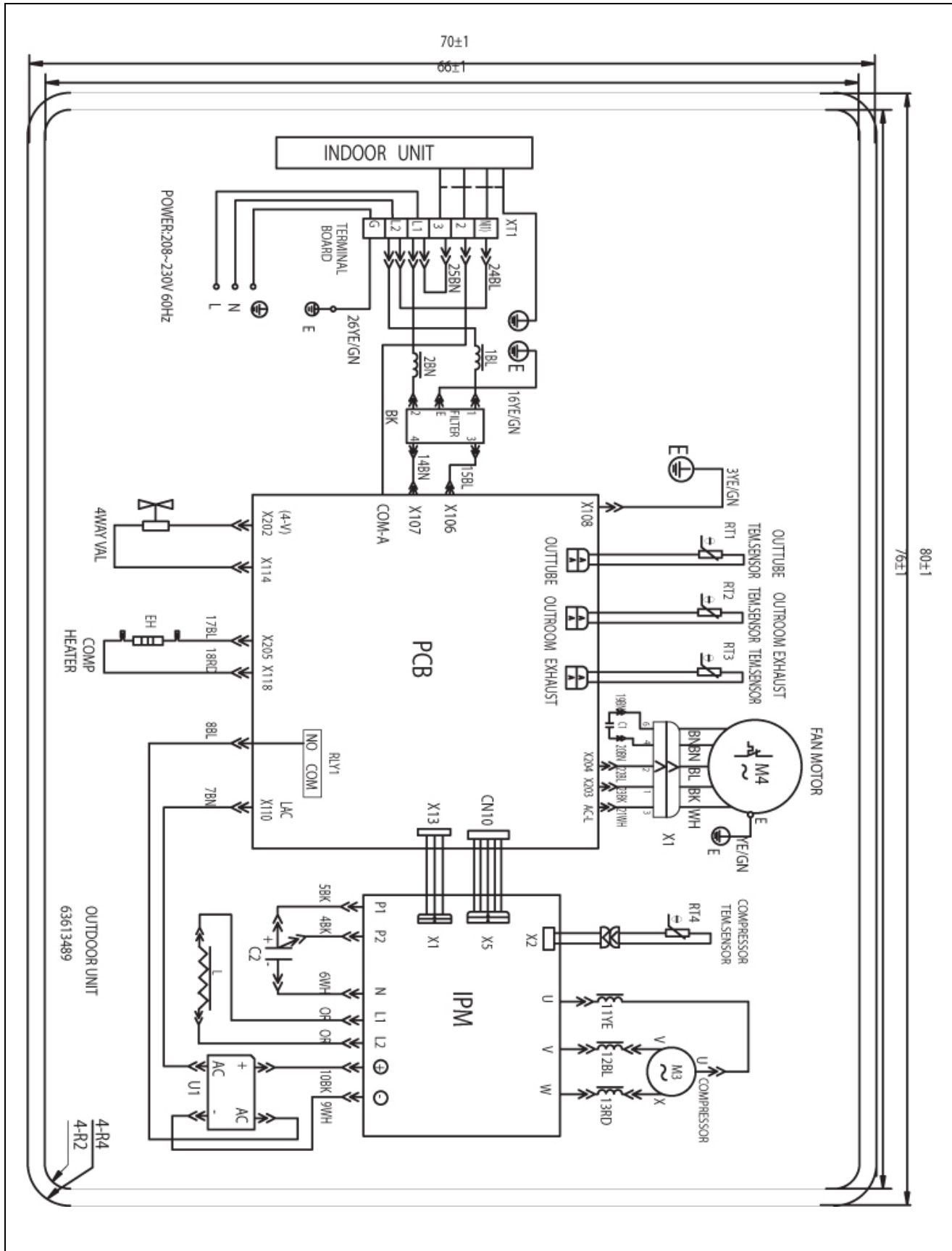

# Warranty

---

Soleus International Inc. warrants the accompanying Soleus Air Wall Mounted Mini Split Heat Pump Air Conditioner (KFHHP-18-ID/KFHHP-18-OD) to be free of defects in material and workmanship for the applications specified in its operation instruction for the period of parts specified below.

5 YEARS FOR COMPRESSOR
1 YEAR FOR OTHER COMPONENTS

This warranty shall not apply to broken or marred cabinets, accessories, knobs, filters or routine maintenance. This warranty does not apply to uncrating, setup, installation, removal of the product for repair or reinstallation of the product after repair.

This warranty does not apply to repairs or replacements necessitated by any cause beyond the control of Soleus International including, but not limited to, any malfunction, defect or failure caused by or resulting from unauthorized service or parts, improper maintenance, operation contrary to furnished instructions, shipping or transit accidents, modification or repair by the user, abuse, misuse, neglect, accident, incorrect power line voltage, fire, flood or other Acts of God, or normal wear and tear.

Warranty service must be performed by a qualified HVAC contractor. Soleus maintains a centralized service network to provide parts and assist in resolving service problems if difficulties are encountered. Soleus agrees to provide service information, sell repair parts and reimburse the dealer /serviceman for parts in accordance with Soleus International's Policies and Procedures.

**SOLEUS INTERNATIONAL MAINTAINS THAT ALL WARRANTIES, INCLUDING IMPLIED WARRANTY OR MERCHANTABILITY ARE LIMITED TO THE TERMS AND CONDITIONS SPECIFIED ABOVE. SOLEUS INTERNATIONAL DISCLAIMS ANY LIABILITY FOR CONSEQUENTIAL OR INCIDENTAL DAMAGES AND IN NO EVENT SHALL SOLEUS INTERNATIONAL INC.'S LIABILITY EXCEED THE RETAIL VALUE OF THE AIR CONDITIONER.**

This warranty covers only new products purchased from our authorized dealers or retailers. It does not cover internet sales, used, salvaged, or refurbished products.

## FOR TECHNICAL SUPPORT AND WARRANTY SERVICE

Soleus International Inc.  
Tel: 1-888-8 SOLEUS  
Monday through Friday, 9:00 AM to 5:00 PM, PST  
Email: [Contact@soleusair.com](mailto:Contact@soleusair.com)  
Website: [www.soleusair.com](http://www.soleusair.com)

## Free Manuals Download Website

<http://myh66.com>

<http://usermanuals.us>

<http://www.somanuals.com>

<http://www.4manuals.cc>

<http://www.manual-lib.com>

<http://www.404manual.com>

<http://www.luxmanual.com>

<http://aubethermostatmanual.com>

Golf course search by state

<http://golfingnear.com>

Email search by domain

<http://emailbydomain.com>

Auto manuals search

<http://auto.somanuals.com>

TV manuals search

<http://tv.somanuals.com>