



Portable AirConditioner and Heater With Heat Pump Technology Operating Instructions



Model No.: PH3-12R-03
Reference No.: KY2-34HP

V.130114

Thank you for choosing a Soleus Air Portable Air Conditioner. This owner's manual will provide you with valuable information necessary for the proper care and maintenance of your new product. Please take a few moments to thoroughly read the instructions and familiarize yourself with all the operational aspects of your new Soleus Air Portable Air Conditioner with Heat Pump technology.

For your own records, please attach a copy of your sales receipt to this manual. Also, write the store name/location, date purchased, and serial number below:

Store Name: _____

Location: _____

Date Purchased: _____

Serial Number (located on back of unit): _____

IMPORTANT INSTRUCTIONS

Before installing and using your portable air conditioner, please read this owner's manual carefully. Store this manual in a safe place for future reference.

- 1) Always place the unit on a level surface.
- 2) Never use or store gasoline or other flammable vapor or liquid near this unit unless instructed by this manual.
- 3) Maintain at least 10 inches (25 cm) clearance space around this unit. Do not block or cover air inlet or outlet grilles.
- 4) The unit must be connected to a correctly grounded power supply.
- 5) Do not start or stop the unit by inserting or pulling out the power plug.
- 6) Do not use an adapter plug or extension cord.
- 7) Do not use the unit in the immediate surroundings of a bath, a shower or a swimming pool.
- 8) Do not insert anything into the air outlet. Do not obstruct air inlet or outlet grills unless instructed by this manual.
- 9) Do not let children play near this unit.
- 10) Always inspect the cord for signs of damage before use. If the power cord is damaged, it must be replaced by the manufacturer or a qualified service technician.
- 11) When cleaning the unit, always turn the unit off and unplug the power cord.
- 12) When the unit is not in use, always remove the venting kit from window.
- 13) Do Not Mix Old And New Batteries.

Do Not Mix Alkaline, Standard (Carbon - Zinc), Or Rechargeable (Nickel - Cadmium) Batteries.

- 14) When changing between heating and cooling mode there will be a 3-5 minute delay for the compressor to start.

During this time, the refrigerant inside the portable air conditioner will return to the compressor to start heating or cooling your area.

PACKAGE CONTENTS

Portable Air Conditioner
Exhaust Hose (1)
Hose Adapters (1)
Window Kit Adapter (1)
Remote Control
AAA Batteries (2)
Window Kit - 2 Sliding Panels (1 single hose panel, 1 extension panels)
Owner's Manual

SPECIFICATIONS

- The cooling capacity is measured at an ambient temperature of DB 86 °F, WB 78 °F.
- Noise level is measured at a distance of 3.28 ft away from the front of the unit, when the unit is in cooling mode.
- Power consumption is measured when the fan runs at the highest speed setting.
- These specifications are for reference only. For actual data, please refer to the rating label on the back of the unit.
- If the environment temperature is higher than the max operating temperature or lower than the minimum operating temperature, the air conditioner may not work properly.

Model Number		PH3-12R-03
Reference Number		KY2-34HP
Cooling Capacity		12,000 BTU/Hr
Heating Capacity		12,200 BTU/Hr
Dehumidifying Capacity		63 pts/day
Power Consumption	Cooling	1100W
	Heating	980W
Air Flow Volume		240 CFM
Power Source		115 V / 60 HZ
Rated Current	Cooling	10A
	Heating	9.1A
Sound Pressure Level		<45 dB(A)
Weight		70 lbs
Dimensions (W x D x H)		13" x 22.125" x 27.75"
Refrigerant		R-410A

DISCLAIMER

ALL INFORMATION AND THE TECHNICAL SPECIFICATIONS PRESENTED IN THIS USER'S MANUAL ARE THE PRESENTATION OF THE MANUFACTURER. SOLEUS INTERNATIONAL HAS NOT CONDUCTED INDEPENDENT TEST TO THE INFORMATION AND THE SPECIFICATIONS PRESENTED HEREWITHIN.

LCDI POWER CORD AND PLUG

This air conditioner is equipped with an LCDI (Leakage Current Detection and Interruption) power cord and plug as required by US National Electric Code 440.65. This cord consists of a length of shielded flexible cord with no termination on the load side and a LCDI attachment plug on the line side.

The LCDI power cord and plug will remove the supply source via electrical disconnect (circuit trip) if the nominal current leakage between the cord shield and either load conductor exceeds a predetermined value. The cord will remain de-energized until the device has been manually reset. This is intended to reduce the risk of a fire in the power cord or combustible materials nearby. The cord shields are not grounded and they must be considered a shock hazards if exposed. The cord shield must not be connected to ground or to any exposed metal.

The test and reset buttons on the LCDI Plug are used to check if the plug is functioning properly. To test:

1. Plug power cord into wall outlet
2. Press TEST Button, circuit should trip, cutting power to the air conditioner
3. Press RESET button for use

If test button is pressed and unit can still be turned on, current leakage has been detected. Do not use the air conditioner or attempt to reset the LCDI Plug. Contact Soleus Air Customer Service for troubleshooting recommendations.

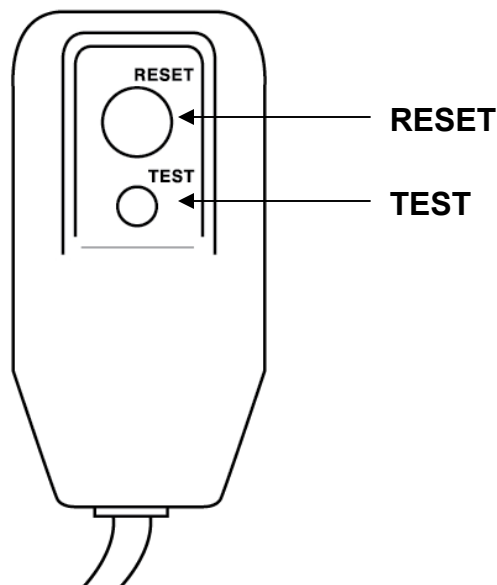

WARNING:

1. DO NOT press the TEST button while the air conditioner is operating.
2. The TEST and RESET buttons should not be used as “ON” and “OFF” switches.
3. The cord and plug are not intended to offer protection to externally connected loads or supply circuits.
4. The cord and plug are intended for indoor use only.

PRODUCT DIAGRAM (Actual product design may differ slightly from images below)

FRONT

- A. Control panel
- B. Vertical air louvers
- C. Air outlet
- D. Horizontal air louvers
- E. Casters
- F. Power Cord & Plug

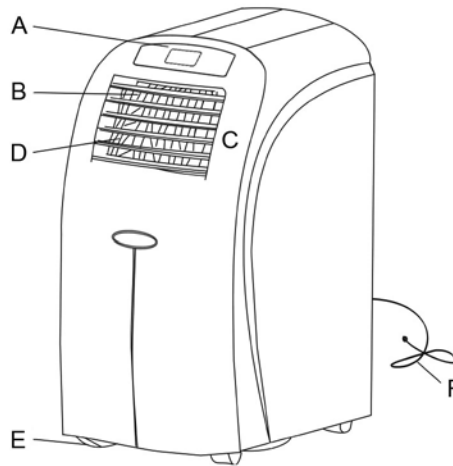

BACK

- A. Hot air outlet grill
- B. Lower air inlet grill

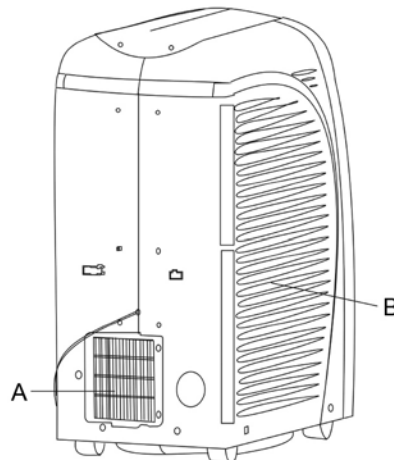

ACCESSORIES

Flexible exhaust hose with 2 adapters

- 3-piece set
- stretches from 14 1/4" to 60 5/8" (36cm to 150cm)

Adjustable window slider kit

- 2-piece set
- adjusts 28.5" to 55"

Drain tube

Drain pan

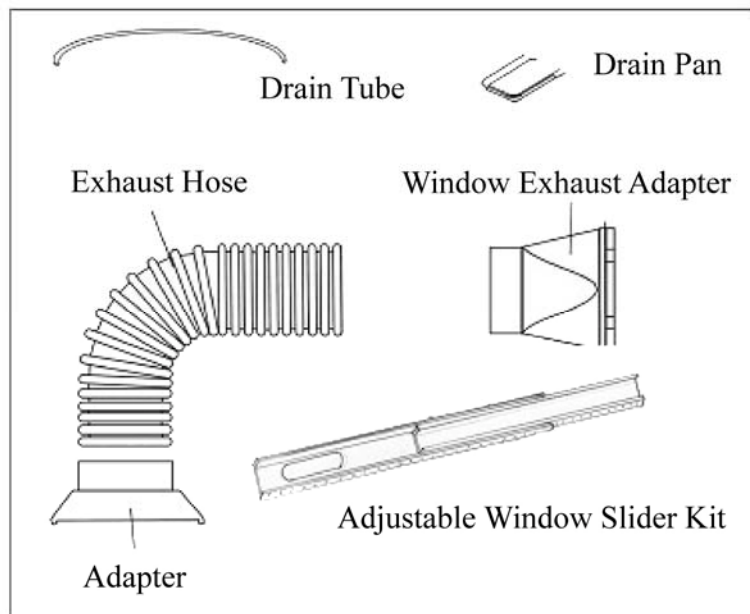

INSTALLATION

SELECTING THE LOCATION

Place the unit in a flat location where the air outlets are not obstructed. Place the unit at least 20" (50cm) away from a wall or other obstacle.

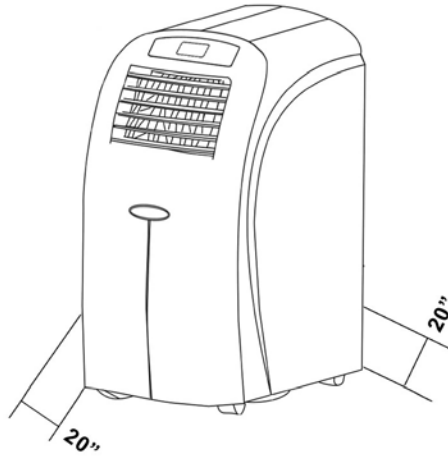

MOUNTING THE EXHAUST HOSE

Slide the square end of the exhaust duct over the hot air outlet on the back of the unit.

The exhaust hose should be kept as short and straight as possible. Prevent any sharp bends in the exhaust hose, as this will trap hot exhaust air.

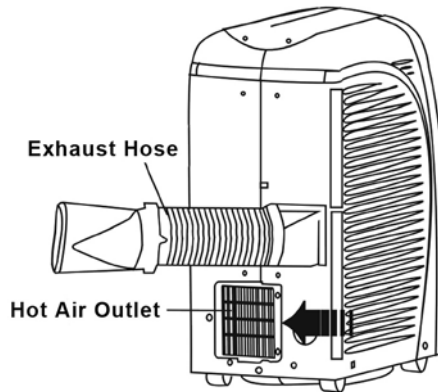

The hot exhaust air can be vented through the wall or out a window. If mounting in the wall, the height of the hole should be 16 to 50 inches (40cm to 130cm).

Soleus Air does not provide a venting kit for through the wall ventilation. Venting through the wall requires a custom installation.

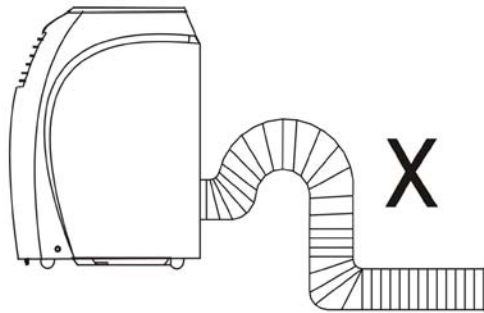
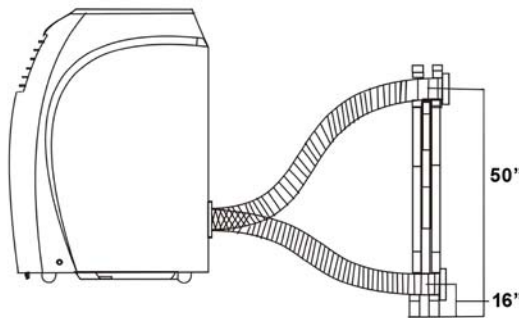

WINDOW KIT INSTALLATION

WINDOW KIT INSTALLATION

The window kit is designed to fit into most standard vertical and horizontal windows, as well as some sliding glass doors. However, it may be necessary to modify some aspects of the installation process for certain window types.

Open the window or sliding door and adjust the length of the window kit to fit the opening. If the window kit is not long enough, connect the extra window kit panel to fit the opening. Mark and cut down a single panel of the window kit if necessary.

Place the window kit between the window and the window frame as shown in the images to the right. Close the window onto the window kit to form a tight seal.

Attach the exhaust duct adapter to the window kit. Tabs located on the adapter will lock into place securing the adapter to the window kit.

HORIZONTAL WINDOW

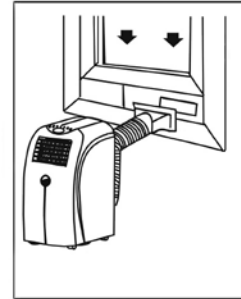
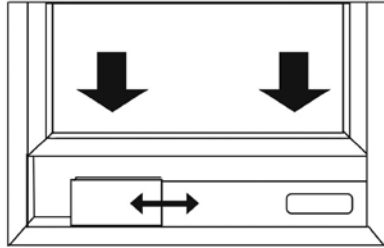

Window Slider Kit
Minimum: 28.5"
Maximum: 55"

VERTICAL WINDOW

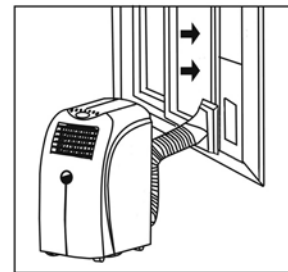
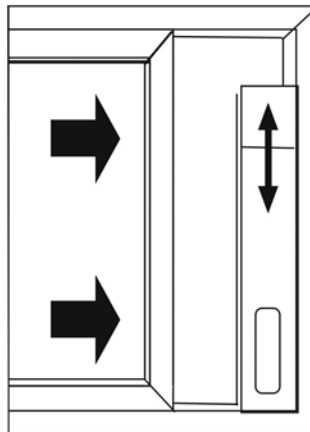

Window Slider Kit
Minimum: 28.5"
Maximum: 55"



Innovative products for a cleaner,
more comfortable world.

Installation of the Venting Kit FOR SINGLE HOSE PORTABLE AIR CONDITIONERS



The venting kit must be installed in order for the unit to work correctly in the air conditioning mode. The venting kit should not be used while the unit is heating or fanning.

The window kit has been designed to fit into most vertical and horizontal window openings. The window kit can also be used in a sliding door.



1. Choose a suitable location, near a grounded electrical outlet and a suitable window or door. Remove packaging and locate components. (figure a)

2. Slide the exhaust connector over the discharge opening on the back of the unit. (figure b)

3. Connect the exhaust hose to the exhaust connector, aligning the fitted groove. (figure c)

4. Open the window or door and adjust the length of the window kit to fit the opening. (figure d) If necessary, mark the kit and cut one end down to properly fit the opening. (figures e & f)



5. Attach the window kit adapter to the window kit. (figure g)

6. Place the window kit back into the window and attach the exhaust hose to the window kit adapter. (figures h & i) Close the window tightly. (figure j) Your Portable Air Conditioner is now ready to cool!



NOTE: When using the venting system, keep the exhaust hose as straight as possible. The exhaust hose can be shortened, but it is not recommended to increase the length of the exhaust hose. Do not use an extension cord with your portable air conditioner.



When using to a sliding door, it is recommend to make the air outlet up to air inlet.

NOTE: The Portable Air Conditioner above may differ from the unit described in this manual. The above directions and images show **general** directions for all Soleus Air single hose portable air conditioners.

CONTROL PANEL, DISPLAY, & OPERATING INSTRUCTIONS

CONTROL PANEL & MULTI-COLOR DISPLAY

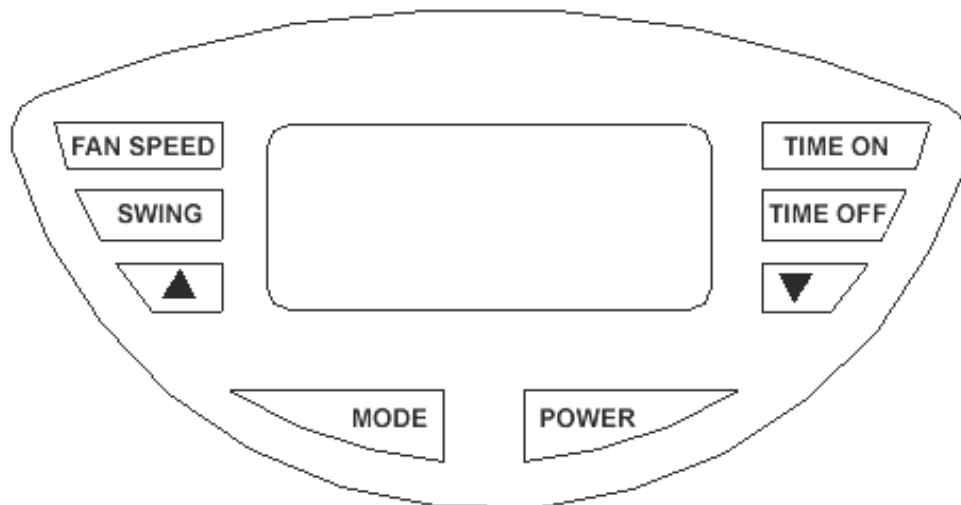

MULTI-COLOR DISPLAY

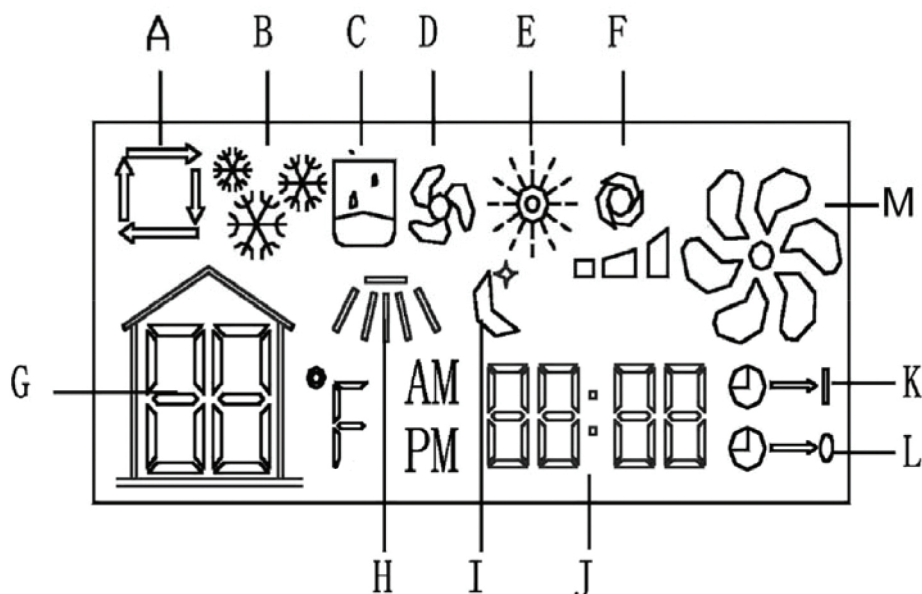

- A. Auto Mode
- B. Cool Mode
- C. Dehumidify Mode
- D. Fan Mode
- E. Heat Mode
- F. Fan Speed (Low, High, Medium)
- G. Temperature
- H. Swing Mode
- I. Sleep Mode
- J. Clock and Timer
- K. Timer On
- L. Timer Off
- M. Compressor is on



OPERATING INSTRUCTIONS

CONTROL PANEL BUTTONS (Refer to the images on page 9)

- 1) **Power On and Off** - Press the **POWER** button once to manually turn the unit on. Press the **POWER** button once more to turn the unit off.
- 2) **Mode Selection** - Press the **MODE** Button repeatedly to cycle between the different modes: Auto mode, Air Conditioner, Heater, Dehumidifier, and Fan.
- 3) **Fan Speed Control** - Press the **FAN SPEED** Button to cycle through the different fan speeds: **High, Medium, and low**. The fan speed can be visually distinguished by the speed of the digital air segments progressing out from the windmill fan image on the Multi-color display.
- 4) **Temperature** - Select the desired temperature by pressing either ▼ or ▲ button when using the unit in cool or heat mode. The temperature indicator flashes to display the desired temperature setting. After the temperature is set, the unit will display this temperature setting until it is changed by the user. The Multi-color display shows temperature in Celsius or Fahrenheit. Press the ▼ or ▲ buttons simultaneously on the control panel to select the desired temperature setting.
- 5) **Timer** - To program the timer, press the **TIMER ON** button until the display shows a flashing “”. Press the ▲ or ▼ buttons to change the clock to the desired time for the unit to automatically turn on.

Press the **TIME OFF** button and the display on the unit will flash “”. Press the ▲ or ▼ buttons to change the clock to the desired time for the unit to automatically turn off. The **TIME OFF** indicator will flash for 3 seconds to activate your programmed on and off times.
- 6) **Time Display** - In the diagram on page 9, the letter “J” points to the adjustable time display. To adjust the time, Press FAN SPEED and SWING together (at the same time). This will activate the time display feature. Next, let go of the FAN SPEED and SWING buttons, and press the ▲ button to adjust the hours, and press ▼ to adjust the minutes.
- 7) **Swing** - To start horizontal oscillation, press the Swing button once. “” icon will appear on the multi-color display. To stop oscillation, press the Swing button again. Vertical air flow direction can be adjusted manually.

NOTE: The timer will remember your settings when it is set. If you set the timer while in Air Conditioning mode, the timer will automatically turn the unit on and off in air conditioning mode according to the desired programmed times. The timer will also remember the temperature settings, fan speed, and oscillation setting. The timer works when the unit is in Air Conditioner mode, Dehumidifier mode, Fan mode, Heat mode and Auto mode.

OPERATING THE UNIT USING THE CONTROL PANEL

Air Conditioner Mode

- 1) Install the exhaust hose and window kit properly (see pages 7 & 8).
- 2) Plug the Power Cord into an electrical outlet.
- 3) Turn on the unit by pressing the **POWER** button on the control panel.
- 4) Press the Mode button until the “” icon appears on the Multi-color display
- 5) Press the ▲ or ▼ buttons until the desired room temperature appears on the control panel display. The temperature ranges from 61°F - 88°F (16°C - 31°C).
- 6) Select the desired fan speed by pressing the **FAN SPEED** button.

NOTE: During hot days, the unit will cool the room most efficiently by setting the temperature at the lowest setting and the fan speed on high. Reducing the length of the exhaust duct, insulating the exhaust hose and window kit, and keeping direct sunlight to a minimum will also improve the cooling efficiency.

NOTE: When the unit is running on cooling mode, the exhaust hose is required and must be vented outside using the supplied window kit.

Dehumidifier Mode

- 1) Install the exhaust hose and window kit properly (see pages 7 & 8).
- 2) Plug the Power Cord into an electrical outlet.
- 3) Turn on the unit by pressing the **POWER** Button on the control panel.
- 4) Press the **MODE** button until the “” appears on the control panel display.

NOTE: The unit operates at low fan speed during dehumidifier mode. The unit cools room slightly during the dehumidification. Keep the windows and doors closed to aid the effectiveness of the unit in removing the moisture from the room.

NOTE: When the unit is running in dehumidifier mode, the exhaust hose is required and must be vented outside using the supplied window kit. The unit will not perform in dehumidifier mode when the room temperature is lower than 61°F.

Fan Mode

- 1) Plug the Power Cord into an electrical outlet.
- 2) Turn on the unit by pressing the **POWER** button on the control panel.
- 3) Press the **MODE** button until the “” icon appears on the control panel display.
- 4) Select the fan speed by pressing the **FAN SPEED** button.
- 5) To circulate more air, press the **SWING** button on the remote control. The louvers will oscillate back and forth spreading more air throughout the room.

NOTE: It is not necessary for the exhaust hose and window kit to be installed to operate the unit in fan mode.

Heat Mode

- 1) Install the exhaust hose and window kit properly (see pages 7 & 8).
- 2) Plug the power cord into a grounded outlet.
- 3) Turn on the unit by pressing the On/Off button on the control panel.
- 4) Press the Mode button until “” icon appears on the multi-color display.
- 5) Press the ▲ or ▼ button until the desired room temperature appears on the multi-color display. The temperature ranges from 61°F - 88°F (16°C - 31°C).
- 6) Select the fan speed by pressing the Fan button. It is recommended to use the low fan speed.

NOTE: When the unit is running on heating mode, the exhaust hose is required and must be vented outside using the supplied window kit.

Auto Mode



- 1) Install the exhaust hose and window kit properly (see pages 7 & 8).
- 2) Plug the Power Cord into an electrical outlet.
- 3) Turn on the unit by pressing the **POWER** button on the control panel.
- 4) Press the **MODE** button until the “” icon appears on the control panel display. Select the fan speed by pressing the **FAN** button.

NOTE: During AUTO mode, the unit operates in **Heating** mode when the room temperature is below 68°F, **Dehumidifier** mode when the room temperature is between 68°F to 80°F. And **Air Conditioner** mode when the room temperature is above 80°F.

Sleep Mode (This mode can only be selected when using the Remote control)

- 1) To set Sleep mode, make sure the unit is in Air Conditioner mode.
- 2) Press the **SLEEP** Button on the remote control. The “” icon appears on the control panel display.
- 3) When in **SLEEP** mode, the fan will run on low to keep fan noise at a minimum.
- 4) When in Air Conditioner mode, the temperature setting will gradually increase to 2°F above the original set temperature for 6 hours. After 6 hours the temperature setting will return to the set temperature.
- 5) When in Heating mode, the temperature setting will gradually decrease to 2°F below the original set temperature for 6 hours. After 6 hours, the temperature setting will return to the set temperature.
- 6) When in Dehumidifier mode, the temperature will not change when Sleep mode is selected.

Compressor Indicator

The “” icon will light up on the control panel display when the compressor turns on. The “” icon will turn off when the compressor shuts off.

Emergency Condensate Holding Tank

When the room temperature is low and the indoor humidity is high, the air conditioner may not be able to evaporate some of the moisture fast enough. When this happens, the water will accumulate in an emergency condensate tank inside the unit. When the condensate tank is full, the unit will display “FULL” on the control panel. To empty the condensate tank, unscrew the screw plug at the bottom back of the unit. You will need a small pan, approximately 1” high to catch the water coming out of the condensate tank. Once the condensate tank is drained, the unit will begin working within a few minutes. The emergency condensate tank holds approximately 1.5 Liters of water. Another option is to purchase a small hose from a hardware store that can fit around the 5/8” drain plug on the back of the unit and drain the unit into a gravity drain or larger pan for continuous drainage.

To resume operation quickly, empty the water container according to the following steps:

1. Turn the unit off. **Do not move the unit when the water container is full.**
2. Place the drain pan accessory under the drainage port at the back of the unit.
3. Remove the drain plug from the drain hole. The condensate water will drain out automatically. When the drain pan is full, screw the drain plug back onto the drainage hole to stop the water flow. Empty the drain pan. Repeat until all the water is emptied.

Once the water container has been emptied, screw the plug back onto the drain hole. Do not allow the water to drip continuously into the drain pan, as it might easily overflow.

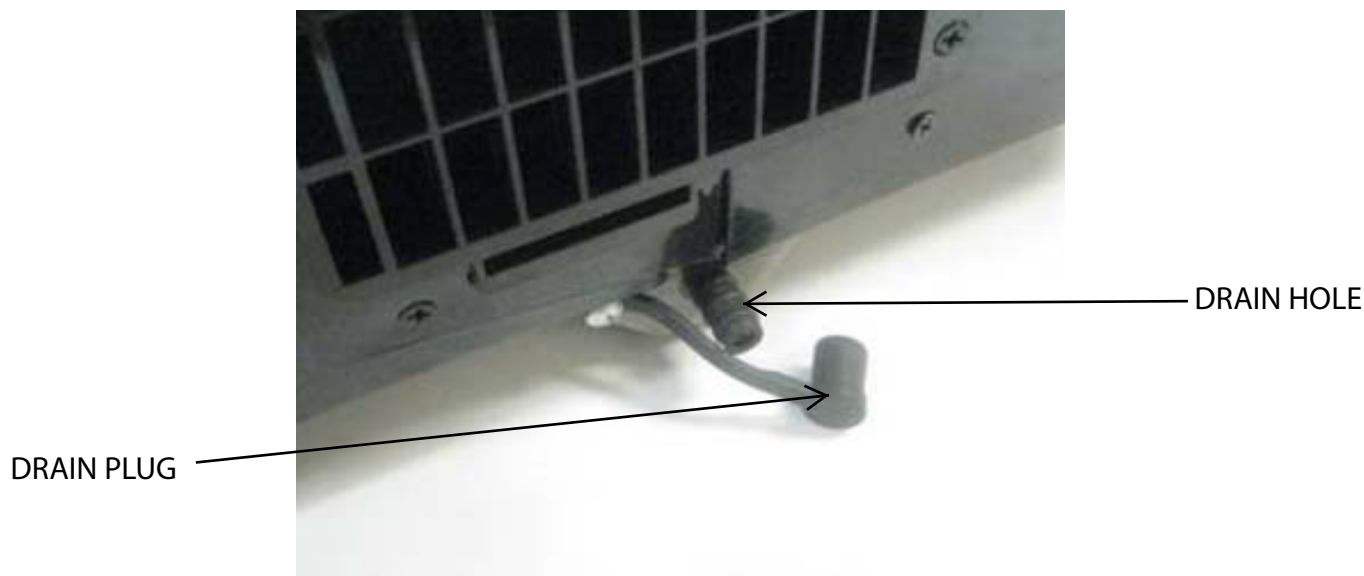

OPERATING THE UNIT USING THE REMOTE CONTROL

REMOTE CONTROL

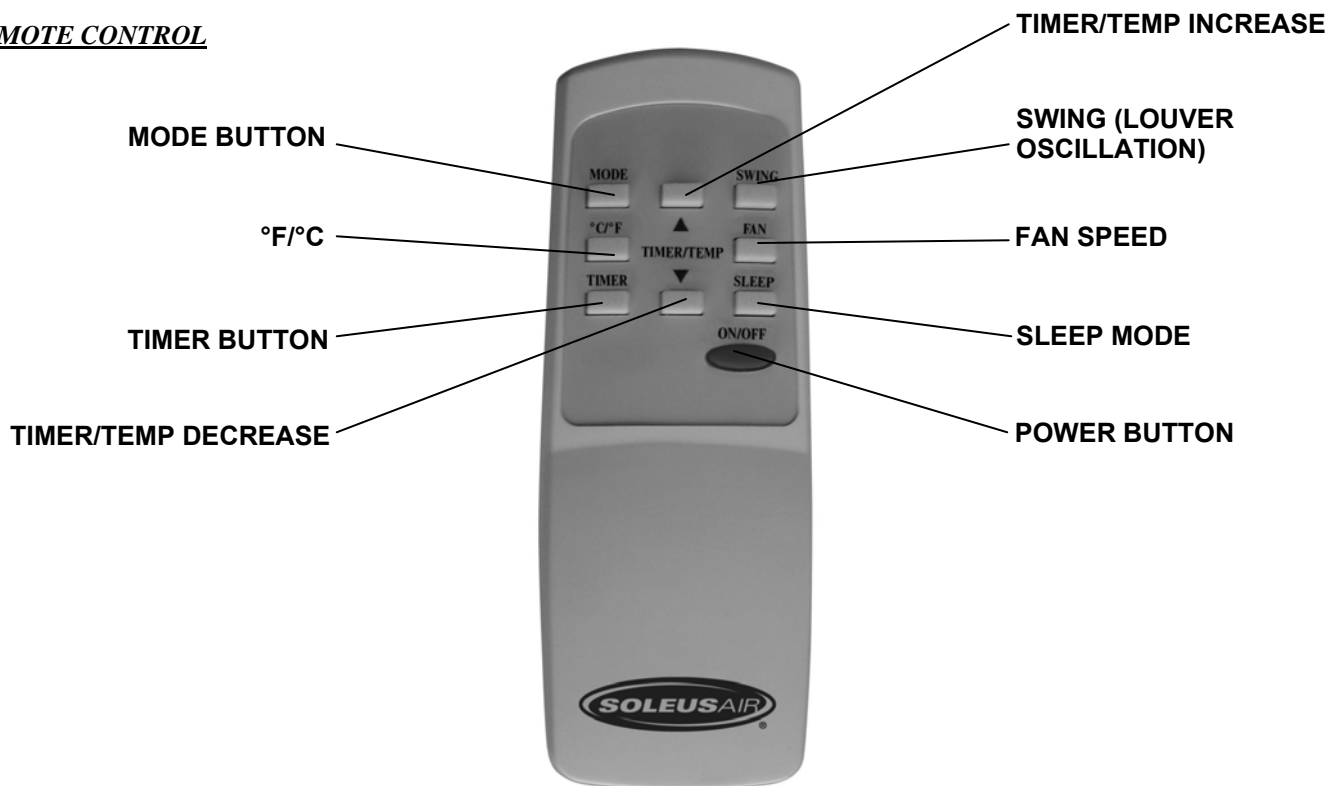

REMOTE CONTROL OPERATING INSTRUCTIONS

- 1) **Power On and Off** - Press the **ON/OFF** button on the remote to turn the unit on or off.
- 2) **Mode Selection** - Press the **MODE** Button repeatedly to cycle between the different modes: Auto, Air Conditioner, Dehumidifier, Fan only, and Heater mode.
- 3) **Fan Speed** - Press the **FAN** speed button to cycle through low, medium, and high fan speeds.
- 4) **Temperature Setting** - When the unit is in Air Conditioner mode you can select your desired temperature. Press the **▲** or **▼** to select your desired temperature setting. The temperature on the multi-color display on the control panel will increase or decrease accordingly. Pressing the **°F/°C** button will change the temperature select between °F and °C.
- 5) **Sleep Mode** - See “SLEEP MODE” on page 12.
- 6) **Swing** - To turn on oscillation, press the **SWING** button on the remote control. Once you press **SWING**, the louvers on the unit will oscillate back and forth.
- 7) **Timer** - To program the timer, press the **TIMER** button on the remote control. Press the **▲** or **▼** buttons to change the clock to the desired time for the unit to automatically turn on. Press the **TIMER** button again to set the time for the unit to shut-off. Press the **▲** or **▼** buttons to change the clock to the desired time for the unit to automatically turn off. The **TIMER OFF** indicator on the multi-color display will flash for 3 seconds to activate your programmed on and off times.

MAINTENANCE

Note: Make sure power is off and the power cord is not plugged into an electrical outlet prior to performing any maintenance on the unit.

Clean or replace filter - If the air filter is blocked with a dust, the airflow volume may reduce. It is recommended to clean the filter once every two weeks or as needed.

- 1) Remove the filter from the filter compartment on the back of the unit.
- 2) Wash the air filter by immersing it gently into warm water with a neutral detergent. Rinse the filter and dry it thoroughly out of sunlight.
- 3) Slide the filter back into the filter compartment after it is thoroughly dried.
- 4) If the filter is torn or unusable, order a new filter by calling the customer service number on the warranty page of this manual.

Clean the unit Housing

- 1) Keep the unit from being exposed directly to the sun to prevent color fading.
- 2) Clean the surface with a damp cloth and dry it with a soft towel.

Storing the Unit for an Extended Period of Time or Transporting the unit

- 1) Empty any excess water by unplugging the water drainage stop in the back of the unit (located at the bottom).
- 2) Unplug the unit.
- 3) The unit should be stored in a cool dry place.

WARRANTY

One Year Limited Warranty

Soleus International Inc. warrants the accompanying Soleus Air Portable Air Conditioner with Heat Pump technology to be free of defects in material and workmanship for the applications specified in its operation instruction for a period of ONE (1) year from the date of original retail purchase in the United States.

If the unit exhibits a defect in normal use, Soleus International Inc. will, at its option, either repair or replace it, free of charge within a reasonable time after the unit is returned during the warranty period.

As a condition to any warranty service obligation, the consumer must present this Warranty Certificate along with a copy of the original purchase invoice.

THIS WARRANTY DOES NOT COVER:

- Damage, accidental or otherwise, to the unit while in the possession of a consumer not caused by a defect in material or workmanship.
- Damage caused by consumer misuse, tampering, or failure to follow the care and special handling provisions in the instructions.
- Damage to the finish of the case, or other appearance parts caused by wear.
- Damage caused by repairs or alterations of the unit by anyone other than those authorized by Soleus International Inc.
- Freight and Insurance cost for the warranty service.

ALL WARRANTIES, INCLUDING ANY IMPLIED WARRANTY OF MERCHANTABILITY ARE LIMITED TO ONE-YEAR DURATION OF THIS EXPRESS LIMITED WARRANTY. **SOLEUS INTERNATIONAL INC.** DISCLAIMS ANY LIABILITY FOR CONSEQUENTIAL OR INCIDENTAL DAMAGES AND IN NO EVENT SHALL SOLEUS INTERNATIONAL INC'S LIABILITY EXCEED THE RETAIL VALUE OF THE UNIT FOR BREACH OF ANY WRITTEN OR IMPLIED WARRANTY WITH RESPECT TO THIS UNIT.

This warranty covers only new products purchased from our authorized dealers or retailers. It does not cover used, salvaged, or refurbished products.

As some states do not allow the limitation or exclusion of incidental or consequential damages, or do not allow limitation on implied warranties, the above limitations and exclusions may not apply to you. This warranty gives you specific legal rights, and you may also have other rights that vary from state to state.

For Technical Support and Warranty Service

Please Call (888) 876-5387

Or Write To:

Soleus International Inc.
20035 E. Walnut Dr. N.
City of Industry, CA 91789 USA
www.soleusair.com

Free Manuals Download Website

<http://myh66.com>

<http://usermanuals.us>

<http://www.somanuals.com>

<http://www.4manuals.cc>

<http://www.manual-lib.com>

<http://www.404manual.com>

<http://www.luxmanual.com>

<http://aubethermostatmanual.com>

Golf course search by state

<http://golfingnear.com>

Email search by domain

<http://emailbydomain.com>

Auto manuals search

<http://auto.somanuals.com>

TV manuals search

<http://tv.somanuals.com>