

# *C100*

## **Installation Guide**



---

**Solid State Logic**

***C100***

Digital Broadcast Console

Installation Guide

Version 1.2.0

82S6PC1010C

# Solid State Logic

SOUND || VISION

Begbroke, Oxford, England, OX5 1RU • +44 (0)1865 842300

320 West 46th Street, 2nd Floor, New York, NY 10036, USA • +1 (1) 212 315 1111  
Suite 401, 5757 Wilshire Blvd, Los Angeles, CA 90036, USA • +1 (1) 323 549 9090  
3-55-14 Sendagaya, Shibuya-Ku, Tokyo 151-0051, Japan • +81 (0)3 5474 1144  
7 bis, rue de la Victoire, le Blanc Mesnil, Paris 93150, France • +33 (0)1 48 67 84 85  
Via Timavo 34, 20124 Milano, Italy • +39 (0)39 2328 094

Visit SSL at URL: <http://www.solid-state-logic.com>

© Solid State Logic

All Rights reserved under International and Pan-American Copyright Conventions

C100, C200, C300, Centuri, C-SB StageBox, NetBridge, NiTech,  
Solid State Logic and SSL are trademarks of Solid State Logic

All other product names and trademarks are the property of their respective owners

No part of this publication may be reproduced in any form or  
by any means, whether mechanical or electronic, without the  
written permission of Solid State Logic, Oxford, England

As research and development is a continual process, Solid State Logic reserves the right  
to change the features and specifications described herein without notice or obligation

E&OE

---

# Contents

<b>1 Introduction</b>	2
<b>2 Safety Considerations</b>	3
Safety Warnings	4
CE/FCC/WEEE Certification and Directives	5
<b>3 Pre-Installation Information</b>	6
Services Provided by SSL	6
Physical/Structural	7
Console Footprint and Side Profile	8
Centuri and Stagebox Side View	10
Technical	11
<b>4 System Components</b>	13
Console Frame	13
The Centuri Processor	15
The Centuri Processor Cards	16
C-SB Stagebox (option)	21
MORSE (option)	21
NetBridge (option)	23
Script Tray (option)	25
Loudspeaker Shelf (option)	25
XGA Video Switcher	25
<b>5 Installation</b>	27
Connections	27
Earth Connection	27
Console Control	29
PSU Status	31
Sync	31
I/O – MicAmp Card	33
I/O – Analogue Card	33
I/O – Digital Card	35
I/O – MADI Card	35
GPI/O Card	37
C-SB Stagebox Wiring	39
Talkback and Oscillator	43
Phasescope and Meter Wiring	45
<b>Appendices</b>	
A Equipment Specifications	47
B Connector Details	51
C Connector Pinouts: Console	53
Processor Crate	56
NetBridge	62
D Audio Interfacing	63
E Environmental Specification	65
F Stagebox Installation Requirements	67
G SSL Part Numbers by Description	69

## Section 1 – Introduction

The object of this manual is to provide purchasers of the C100™ Console and Centuri™ Processor with information in the following areas:

- Safety considerations
- Installation requirements
- Items supplied: – Main components and optional items
- Installation: – Physical assembly  
– Electrical connections and cabling  
– System options
- Specifications and Physical dimensions
- Pinouts of standard connectors

The information provided by this manual is relevant to all of the versions of the C100.

The aspects of the C100 which can be customised – frame size, channel layout, meter panel as examples – will be fully documented in the Custom Specification information for a specific console.

The Custom Specification information, which details the actual console as built, will be found in Section 10 of the console's Service Manual.

## Section2 – Safety Considerations

This section contains definitions and warnings, and practical information to ensure a safe working environment. *Please take time to read this section before undertaking any installation work.*

### Definitions

#### *'Maintenance'*

All maintenance must be carried out by fully trained personnel. *Note: it is advisable to observe suitable ESD precautions when maintenance to any part is undertaken.*

#### *'Non-User Adjustments'*

Adjustments or alterations to the equipment may affect the performance such that safety and/or international compliance standards may no longer be met. Any such adjustments must therefore only be carried out by fully trained personnel.

#### *'Users'*

This equipment is designed for use solely by engineers and competent operators skilled in the use of professional audio equipment.

#### *'Environment'*

This product is a class A product intended to form an integrated component part of a professional audio recording, mixing, TV, radio broadcast or similar studio wherein it will perform to specification providing that it is installed according to professional practice.

### **Electrical Safety Warning**

When installing or servicing any item of SSL equipment with power applied, when cover panels are removed, HAZARDOUS CONDITIONS CAN EXIST.

These hazards include:

High voltages  
High energy stored in capacitors  
High currents available from DC power busses  
Hot component surfaces.

Any metal jewellery (watches, bracelets, neck-chains and rings) that could inadvertently come into contact with uninsulated parts should always be removed before reaching inside powered equipment.

### **Installation Instructions**

#### **Voltage Selection and Fusing**

Although the majority of SSL equipment uses auto-ranging power supplies, some sub-systems have user-selectable voltage inlets. Always confirm that the input mains voltage range is set correctly before applying power. Always isolate the mains supply before changing the input range setting.

If it is ever necessary to replace a blown mains-fuse, then always use the correct rating and type of replacement. If a correctly rated fuse continues to blow, then a fault exists and the cause should be investigated or the unit returned to SSL for repair/replacement as appropriate.

Details of mains settings and correct fuse ratings can be found in Appendix A of this manual.

### Safety Earth Connection

Any mains powered item of SSL equipment that is supplied with a 3-core mains lead (whether connectorised or not) should always have the earth wire connected to the mains supply ground. This is the safety earth and grounds the exposed metal parts of the racks and cases and should not be removed for any reason.

### Mains Supply and Phases

SSL equipment is designed for connection to single-phase supplies with the Neutral conductor at earth potential – category TN – and is fitted with a protective fuse in the Live conductor only. It is not designed for use with Phase (Live) and Neutral connections reversed or where the Neutral conductor is not at earth potential (TT or IT supplies).

All mains powered assemblies must be connected to the same mains phase. In particular, note that as PSU redundancy is standard, the two input leads must NOT be connected across different phases.

Mains cables will be coded with either of the following colour schemes:

	<b>1</b>	or	<b>2</b>
LIVE:	Brown		Black
NEUTRAL:	Blue		White
EARTH:	Yellow / Green		Green

### Mains Isolation and Over-Current Protection

An external disconnect device (switch) is required for this equipment which must be installed according to current wiring regulations. A detachable power cord, if fitted to this equipment, is a suitable disconnect device; otherwise an approved disconnect switch is required – the rating of which is defined in the product specification (Appendix A) and on the equipment itself.

An external over-current protection device is required to protect the wiring to this equipment which must be installed according to the current wiring regulations. The fusing or breaking-current is defined in the product specification. In certain countries this function is supplied by use of a fused plug.

Some equipment (specifically units with PSU Redundancy) utilises multiple power sources. This is clearly marked on the equipment. The finished installation must also be clearly marked to ensure that all sources of power are removed before servicing begins.

### Physical Safety

Most subsystems are too heavy for one person to lift. Take particular care when removing the computer chassis from the equipment rack.

If the console trim is removed for any reason then there may be sharp edges exposed on the frame metalwork.



### CE Certification

**CE** Note that the majority of cables supplied with SSL equipment are fitted with ferrite rings at each end. This is to comply with current European CE regulations and these ferrites should not be removed.

If any of the console metalwork is modified in any way – particularly the addition of holes for custom switches etc. – this may adversely affect the CE certification status of the product.

### FCC Certification

**FC** The equipment which forms a C100/Centuri system has been tested and found to comply with the limits for a Class A digital device, pursuant to part 15 of the FCC Rules. These limits are designed to provide reasonable protection against harmful interference when the equipment is operated in a commercial environment.

This equipment generates, uses and can radiate radio frequency energy and, if not installed and used in accordance with the instruction manual, may cause harmful interference to radio communications. Operation of this equipment in a residential area is likely to cause harmful interference in which case the user will be required to correct the interference at his own expense.

### Instructions for Disposal of WEEE by Users in the European Union



The symbol shown here, which is on the product or on its packaging, indicates that this product must not be disposed of with other waste. Instead, it is the user's responsibility to dispose of their waste equipment by handing it over to a designated collection point for recycling of waste electrical and electronic equipment. The separate collection and recycling of your waste equipment at the time of disposal will help to conserve natural resources and ensure that it is recycled in a manner that protects human health and the environment. For more information about where you can drop off your waste equipment for recycling, please contact your local city office, your household waste disposal service or where you purchased the product.

## Section 3 – Pre Installation Information

Physical installation of the console is normally carried out by a specialised transportation company. In some cases this will have been arranged by the local SSL office, in other cases by the facility.

The cables that run between console and processor can be shipped in advance of the console in a separate kit (the pre-install kit). These cables should be installed by the facility engineers. Instructions for installing these cables are found on pages 29 to 31 of this manual.

*Note: Cables for the connection of ancillary functions, Meters, talkback, oscillator and any custom switches etc. are not supplied by SSL and will need to be provided by the facility. See pages 43–45 for wiring information.*

Before the console is installed all building work should be completed and the environment MUST be clean otherwise the warranty will be rendered invalid.

*Before commissioning can take place the following MUST be completed:*

- Air Conditioning installed, tested, blown-through and working
- Lighting installed and tested
- Cable Trunking installed
- Wall and floor finishes completed
- Power Distribution installed and tested
- Cables installed and tested
- Monitor loudspeakers installed and working
- Other utilities (telephone, water etc.) available

## Services provided by SSL

### Commissioning

All C100 systems include on-site commissioning by an SSL engineer. This is usually expected to take from 2 to 4 days depending on system size, configuration and options. Large systems, or consoles split for shipment, may require an additional 1–2 days of commissioning time.

You will be contacted by your local SSL office or agent shortly before delivery to arrange a commissioning date.

### Training

Two days of standard operator training are provided with each C100 system. If required, this is scheduled to take place immediately following the commissioning period and is usually carried out by the commissioning engineer. A further day of advanced operator training is available at additional cost.

On-site maintenance training is also available at additional cost. This can be either one day for a basic overview or two days for more advanced training.

Training should be requested at time of order. For all training, we recommend that no more than five persons attend each session. If the use of an interpreter is necessary the training period may need to be extended (at additional cost). Note that travel and subsistence costs are not normally included. Please contact SSL's Training Department at: [support@solid-state-logic.com](mailto:support@solid-state-logic.com).

### Warranty

All systems normally include 13 months warranty from date of shipment. This does not include consumable items such as magnetic media, disks etc. Further details may be found in SSL's Conditions of Trading (printed on the reverse of all SSL invoices).

## Physical Requirements

### Console Control Surface

The console control surface can be specified to have from 8 to 96 channels so the size and weight will vary considerably. A dimensioned footprint drawing for each specific console control surface can be provided by SSL's Project Engineering Department. See page 8 for an example of a 32-channel footprint.

Consoles can be built with split points at any profile (at additional cost). The console can then be split for shipment to simplify installation into client's premises. Reassembly will be by SSL engineers.

Refer to Appendix A for weights and power consumption information.

### Rack Mounting Equipment – Centuri, NetBridge and Stageboxes

The Centuri Processor is a 15U height chassis into which a range of I/O cards can be fitted. The system's processing and DSP resource is also housed in the Centuri rack. The Centuri is therefore fitted with cooling fans and is expected to be housed in a separate 'machine' room.

A 19" equipment rack will need to be provided into which the Centuri Processor can be mounted. Note when positioning the rack that cards are inserted into the Centuri Processor from both the front and the rear depending on function. Clearance for access to cards must therefore be provided both in front of and behind the rack (see page 10 for service clearance diagram).

NetBridge – which is an option – is a 2U high rack mounting unit.

Remotely located stageboxes (C-SBs) – which are also optional – may be specified. These are 14U rack units.

*Note. Centuri, NetBridge and stagebox units MUST be supported on shelves and not only by the rack ears.*

SSL can supply 39U 800mm deep equipment racks and shelves if requested (at additional cost). Other rack heights are available to special order.

### Acoustic Isolation

Because of the noise generated by cooling fans adequate noise isolation should exist between the machine and control rooms/recording areas.

Noise figures for individual units are given in Appendix A.

### 32 Channel Footprint

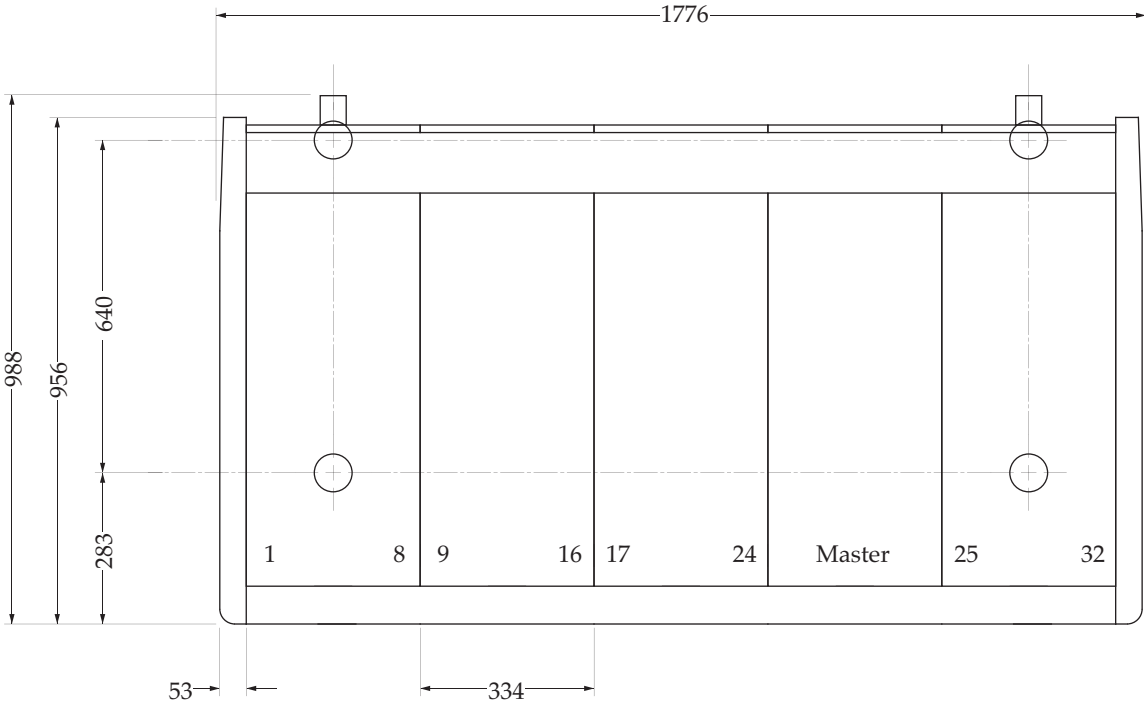

Console legs can be located at any position along console beam. Maximum distance between legs is 1,336mm (ie. four bays)

### Side Profile Showing Service Access

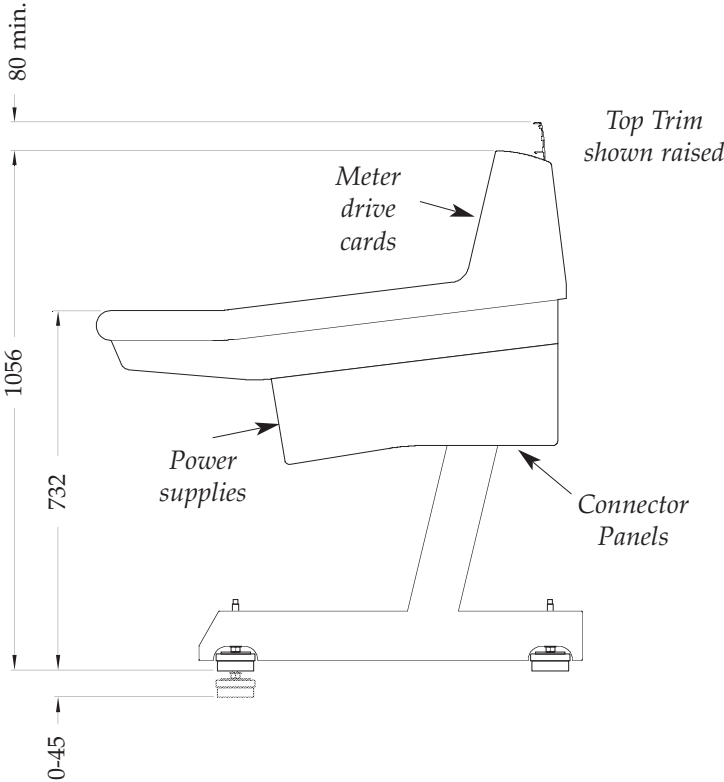

### **Air Conditioning Requirements**

Air conditioning will almost certainly be required for both the Machine and Control rooms in order to maintain the temperature and humidity to within the required levels.

Power dissipation figures for console control surface and equipment rack are listed in Appendix A.

Appendix E contains the environmental specification for SSL equipment.

### **Cable Ducting**

Cable ducting will be required between the console and the Machine room (as well as to any outboard racks and the recording areas). The ducting provided should be of sufficient size such that approximately 50mm x 35mm is available for console surface connection.

The connectors for all control and interface cables are located beneath the console's Centre Section. The connector panels are orientated so that cables will route towards the rear of the desk.

The mains input power connector will be located on a separate panel. This panel is usually positioned in a bay adjacent to the Centre Section nearest to the centre of the console but may vary due to console layout.

Cable sets are available in 10, 16, 20, 25, 48 and 80m standard lengths. Sets longer than 16m are at additional cost.

### **Service Access**

Access to all major electronic assemblies within the frame is either from the front or from beneath the console. The meter LCD panels are retained by finger-screw fastener beneath the top trim. The top trim is designed to hinge upwards to allow access to these screws. If the console is being built into restricted space – as in some mobile installations – then always allow a minimum of 80mm clearance above the top trim (see opposite).

Sufficient clearance must be provided in front of and behind the rack into which the Centuri processor is installed so that cards can easily be removed. See the drawing on page 10 for minimum clearances.

### Centuri Processor Crate (side view) Showing Card Access

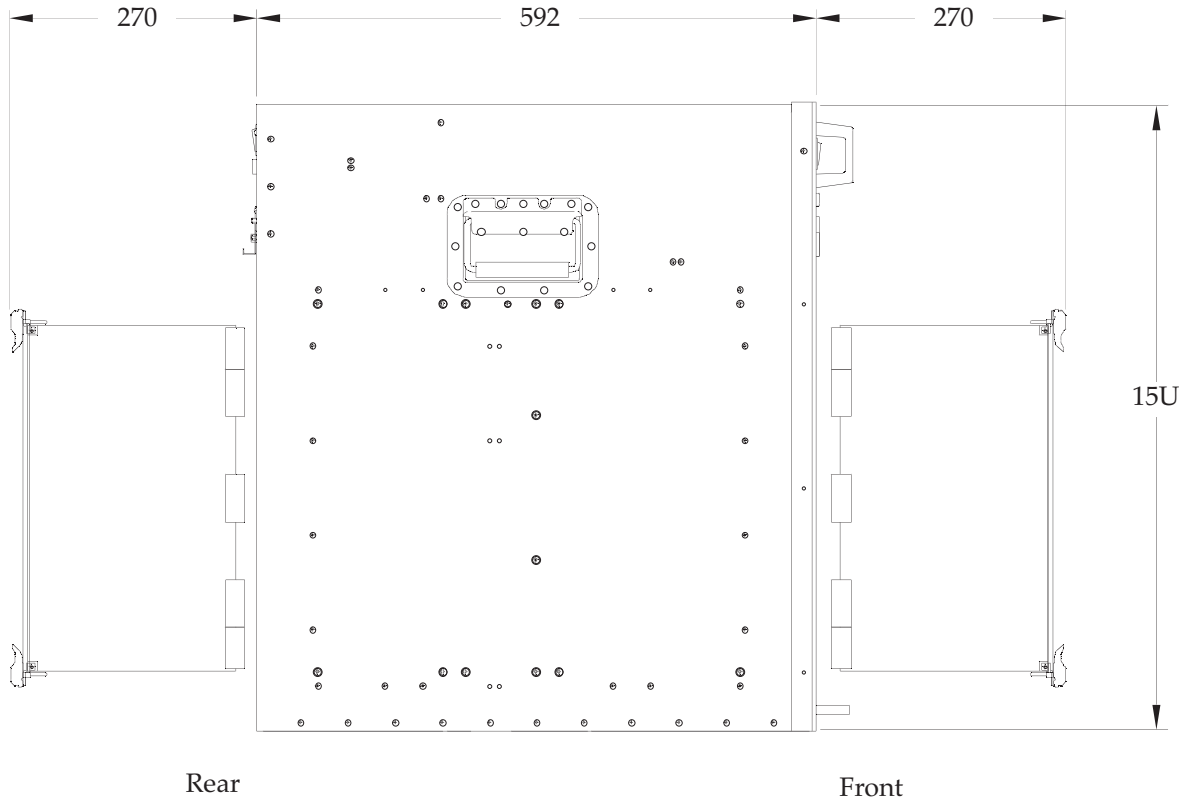

### C-SB Crate (side view) Showing Card Access

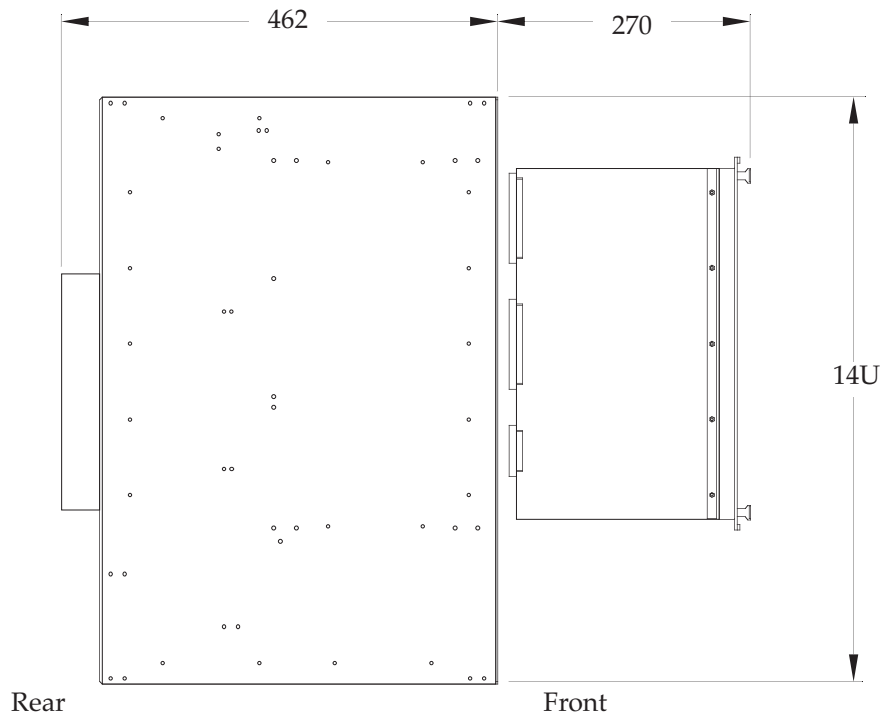

Dimensions in mm

## Technical Requirements

### Video Sync Source

The Centuri Processor requires a feed of video sync. Other sources – MIDI or wordclock etc. – cannot be used as the sync reference.

The sync required is 75Ω 1V(pk-pk) black-and-burst video. The standard can be either PAL (625 line, 50Hz) , NTSC (525 line, 59.94Hz or 60Hz). Composite sync may also be used.

Many other studio peripherals (digital recorders, editors and all video picture recorders) will also require a feed of video sync. Depending on the studio configuration, a suitable video distribution amplifier may also be required.

*Note : The Centuri processor does not provide internal sync generation.*

### Power Connections – Mains Input Voltage & Current

Both the console control surface and the Centuri processor rack are fitted with auto-sensing power supplies and will function at any voltage from 90 to 250 volts without adjustment.

The console is supplied with one or more detachable mains leads. These leads are 2m in length and the cable diameter is 11mm. The free ends of these leads are unterminated for connection to a suitable outlet.

The inrush current present when powering the console can be significant – typically ten times the steady current – so the use of 'slow' or 'motor' rated fuses/circuit-breakers is recommended.

NetBridge (which is a separate 2U unit – see page 23) is fitted with a voltage select switch for 230V or 115V operation. *Confirm that the voltage is correctly set before applying power – see page 23.*

See Appendix A for equipment specifications.

### Grounding

A standard system should not require any additional grounding over and above that supplied by a correctly installed mains supply. All rack unit chassis are permanently bonded to mains earth. A permanent mains earth connection via the mains inlet *must* be provided.

If, due to the quality of the mains wiring within an installation, it is deemed necessary to improve upon the mains earthing, chassis ground connection points are provided as follows:

Centuri rack chassis ground can be accessed via a stud located on the rear panel.

Console chassis ground can be accessed via a stud located on the mains power connector panel.

All audio connectors, both analogue and digital, have their screen pins connected directly to the chassis at the point of entry to comply with AES/EBU grounding and EMC standards.

### C100 Channel Bay Layout

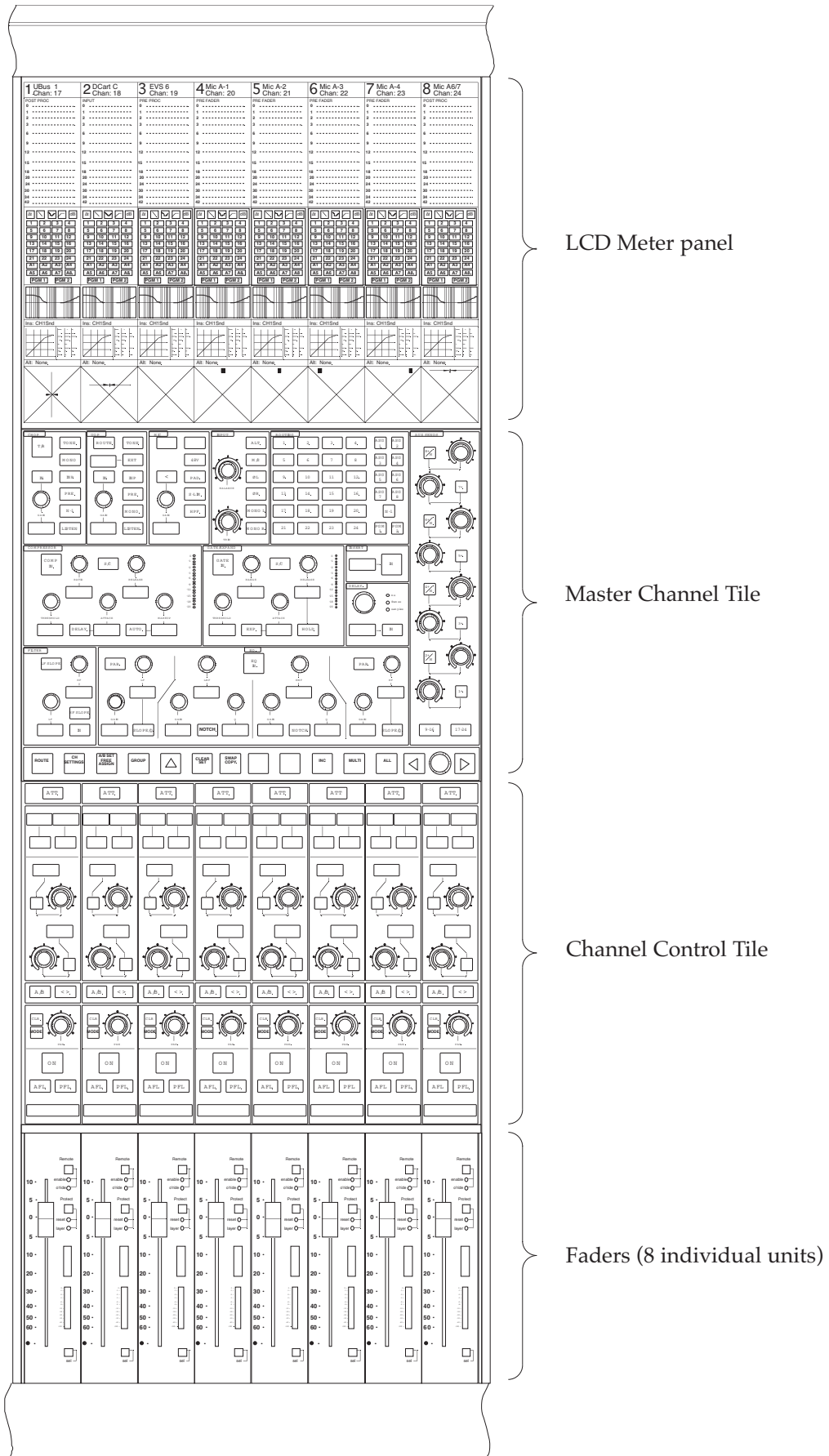



## Section 4 – System Components

This section gives an overview of the main units in the system. See Appendix A for specifications and Appendices B and C for connector details and pinouts.

### C100 Console

Each console control surface will consist of one Centre Section and can be specified to have from 8 to 96 channel faders in groups of 8. (Note: a group of 8 faders and controls and its frame is termed a *bay*). See page 10 for frame sizes.

Each console channel-bay consists of four sections: Faders, Channel Control, Master Channel and the meters. It is only necessary to have one Master Channel tile fitted to the console frame as this can be used to access all channels, although for convenience and additional flexibility additional Channel Masters may be fitted to any bay.

Only the faders are removable individually, all other panels (termed *tiles*) are 8 channels wide.

*Note that the number of physical faders fitted does not limit the number of processing channels available; this is determined by the amount of DSP resource fitted to the processor.*

The Centre Section may optionally be specified with a 6 or 8-channel LCD phase-scope and has additional space for mechanical meters. Alternatively, a range of custom meter configurations is possible; these should be detailed at the time of order.

The console frame may be specified to have 19" wide sections for script space (known as 'Producer's' tables). These can be fitted with either a full-depth flat table or a shorter table and 7U of equipment racking. A 7.2° corner section is also available to create angled frames.

Every C100 console is fitted with dual redundant power supplies as standard. Accordingly, there are two separate mains input connectors beneath the console.

The standard moulded end trims can be substituted by a thin trim panel (approximately 8mm) for installations where width is limited.

SSL's Project Engineering Department can provide specific console footprint drawings detailing layout, size and metering options during the specification process.

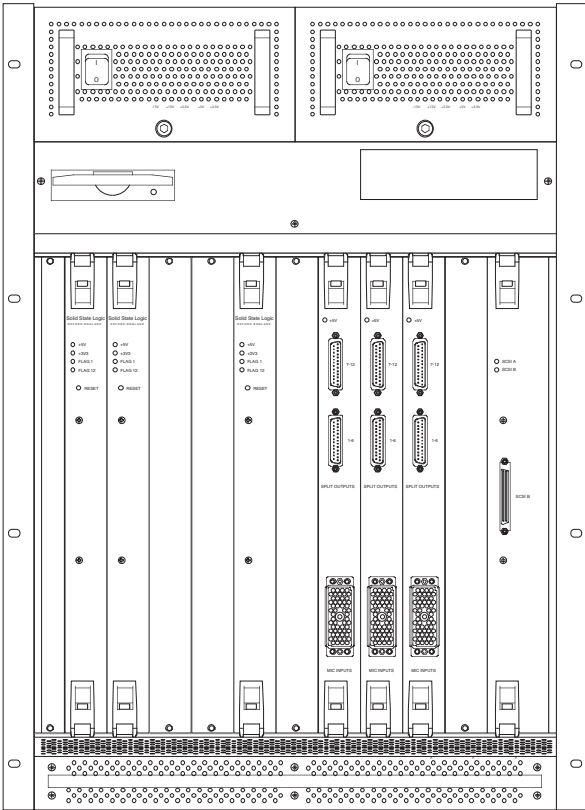

**Centuri Processor Crate  
(Front View)**

Access to:

- PSUs
- Removable media drive
- DSP cards
- System Disk card
- I/O Cards (Mic or Digital)

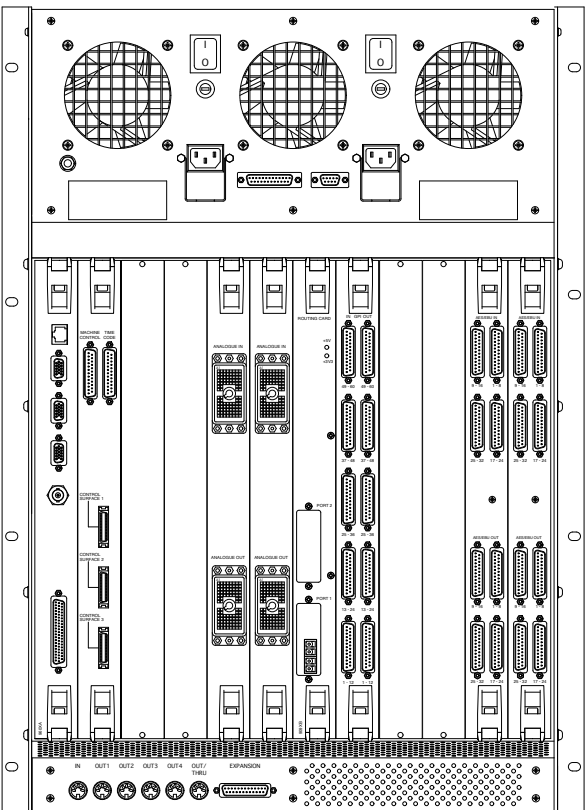

**Centuri Processor Crate  
(Rear View)**

Access to:

- CPU card
- Front panel card
- GPI/O card
- Routing/Link card
- I/O Cards (Mic, Analogue or Digital)

*NB. Cards shown are an example.  
Configuration will vary according to  
specification.*

## The Centuri Processor

The Centuri processor is a 15U high 600mm deep rack unit. Cards are fitted to the front and rear of the chassis so space for access is essential. See page 10 for chassis dimensions and minimum service clearance.

At the front of the processor are located the plug-in PSU units. One unit is capable of powering the system.

The panel below the power supplies is fitted with either a 250Mb Zip drive or an SD memory card reader. This is used to transfer system software onto the internal hard disk. This panel may also be fitted with the optional MO drive for project storage.

Below the drives is the front card-cage which has space for 11 plug-in cards, numbered from left to right. The cards are arranged as follows:

- Slots 1–4 Channel DSP cards.
- Slot 5 Always fitted with a DSP card for the Centre-Section mixes.
- Slot 6 Reserved for future expansion.
- Slots 7–10 I/O cards – micamp cards (digital/MADI cards to special order only)<sup>1</sup>.
- Slot 11 Always fitted with the system disc card; unless the dual-redundant disc option is specified.

There rear of the processor has space for 12 plug-in cards. *Note that these slots are numbered from right to left.*

- Slots 1–4 Available for I/O cards (analogue, digital and MADI).
- Slot 5 Always fitted with the console's Routing/Link card.
- Slot 6 Reserved for the optional GPI/O card.
- Slots 7–10 I/O cards – analogue, digital and MADI (mic cards to special order only)<sup>1</sup>.
- Slot 11 Always fitted with the Console-Interface card.
- Slot 12 Always fitted with the CPU card.

Note that front and rear mounting I/O cards, although functionally identical, are physically different so it is not possible to exchange cards between back and front after specification.

Below the rear card-cage are connectors for MIDI functions and another labelled 'Expansion'. These are not implemented in the C100 system.

(1) Specifying rear mounted micamp cards or front mounted digital/MADI cards will extend the order lead time.



DSP Card

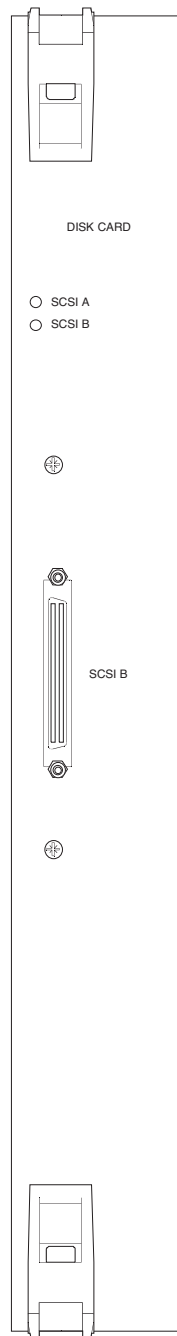

System Disk Card

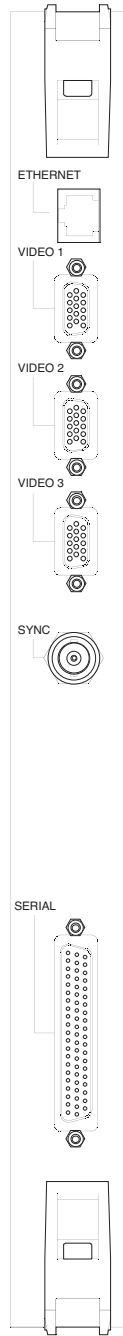

CPU Card

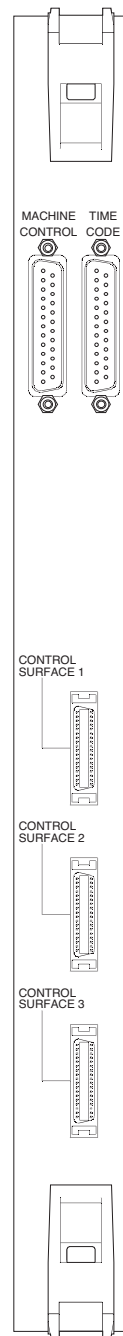

Console Interface Card

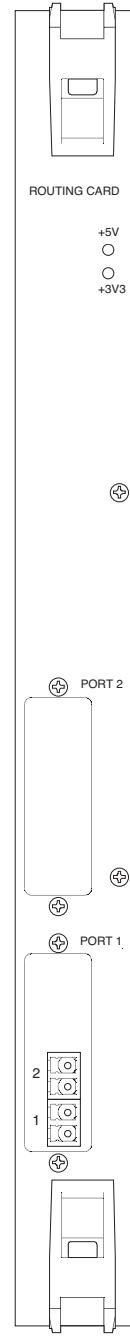

Routing/Link Card

### Centuri – DSP Card

The DSP cards supply the signal processing function for the Centuri system. Each card provides 32 channels of processing. DSP cards are all the same and do not require configuration, they can therefore be fitted into any of the first 5 slots in the front of the Centuri rack.

For a system to pass any audio, there must a card fitted in slot 5 and a card in slot 1.

### Centuri – Disk Card

This is a 1.5 width card which is always fitted in the right-hand slot (slot 11) of the front card-cage. It houses the system hard-disk. This card is not fitted if the dual redundant disk option is specified. In this case a blank panel is fitted and the system discs are mounted internally in the space beneath the power supplies. A front panel key switch is provided to select which disk is in use.

### Centuri – CPU Card

The Centuri Processor is always fitted with the CPU card. It must be fitted to the left-most rear slot.

The CPU card is fitted with connectors for the following functions:

Ethernet	-	100baseT console network <sup>(1)</sup>
Video 1–3	-	Display output for the Centre Section monitor.
Sync	-	Video sync input. Video black & burst is required for system reference.
Serial	-	62-pin connector providing eight RS422/RS232 serial ports. An adaptor cable breaking out to eight off 9-way D-type male connectors, labelled 'TTY-A' to 'TTY-G', is provided.
TTY-B:	-	Keyboard (RS422)
TTY-C:	-	Touchscreen data (RS422)
TTY-G:	-	Bitpad (RS422)
TTY-E:	-	Console (RS232) – Connection for data terminal
TTY-A, D, F & H	-	Unused on C100

<sup>(1)</sup> The ethernet connection is used for SSL control information, it is not TCP/IP protocol. Do not combine with proprietary networks. Standard ethernet repeaters can be used.

### Centuri – Console Interface Card

The Centuri Processor is always fitted with one Interface card. It must be fitted to the rear of the card-cage next to the CPU card.

The card provides the connection to the console's control surface and handles all switch and lamp signals. Of the three 'Control Surface' connectors, only numbers 1 and 2 are used as these contain sufficient capacity for the largest C100 console.

The 'Machine Control' and 'Timecode' connectors are not used by C100.

### Centuri – Routing/Link Card

The Centuri is always fitted with a Routing/Link card. It must be fitted to the rear card-cage in position 5.

This card has two functions. The first is an internal function to organise the audio routes across the system's backplane. The second is to provide access to the optical audio interfaces to the stageboxes and/or MORSE router (if specified). These optical audio connections are called Fibre Links and there can be from 1 to 4 fitted to the Routing card. Fibre Links are cost options and should be specified at the time of order. Note that each fibre link comprises two individual fibre optic connectors – one each for send and for receive.

Fibrelinks are available as either multimode or singlemode versions. The multimode link can be used for cable lengths of up to 550m and the singlemode version for up to 2km.

If no fibre links are specified then the two cutouts in the front panel will be fitted with blanks.



**Mic Input Card**

12 Microphone inputs  
12 split outputs



**Analogue I/O Card**

24 line level inputs and outputs

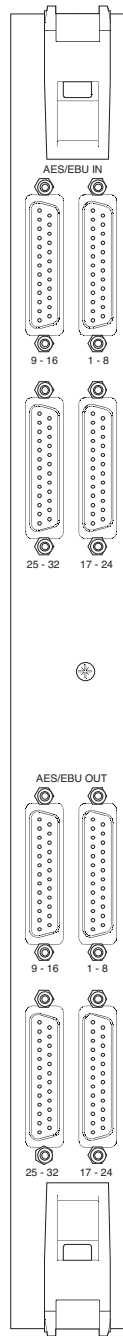

**Digital I/O Card**

64 SRC I/O  
(32 AES/EBU pairs)  
With 25-pin D-type connectors

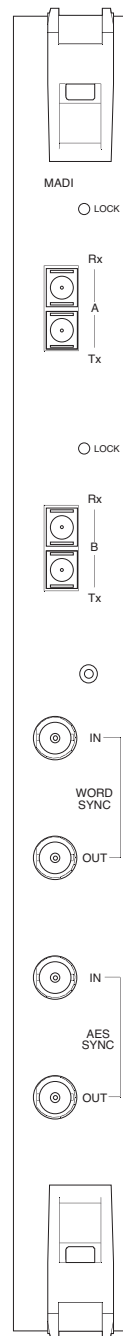

**MADI I/O Card**

(Fibre version)

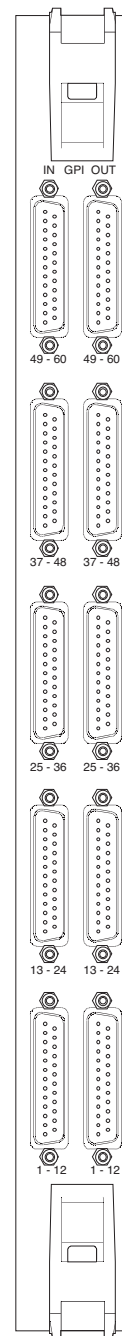

**GPI I/O Card**

60 in, 60 out

### **Centuri – Micamp Card**

The Microphone input card (generally known as the BMA or 'Broadcast Mic Amp') provides 12 input channels. The input is via a female Varicon (EDAC) connector. Mating connectors can be supplied as a cost option.

Each of the mic inputs has a buffered split output. The buffering takes place after the input pad, the RFI filter and the 25KHz low-pass filter but before the variable gain stage. The split output has a gain of 26dB above the mic input level (or 6dB with the pad in circuit) but is unaffected by the consoles' mic gain setting. The split outputs are available on two female 25-way D-type connectors.

Micamp cards are normally fitted to the front of the Centuri. If more than 48 channels are required then rear mounting cards can be specified as a special order.

Refer to section C for connector pinouts.

### **Centuri – Analogue I/O Card**

The Analogue card provides 24 channels of balanced line-level input and output. At least one Analogue card will need to be included if analogue monitor amplifiers are being used. The connectors used are Canon DL96 types. Mating connector kits and a contact crimp tool can be supplied (as cost options). This card is rear mounting only.

See page 57 for the DL pinout.

### **Centuri – Digital I/O Card**

The Digital I/O card is available in two versions: 110 $\Omega$  and 75 $\Omega$ . Both types provide 64 channels (32 AES/EBU pairs) of digital input and output. The 110 $\Omega$  card provides balanced output signals whereas the 75 $\Omega$  card is unbalanced for correct matching to co-axial cables. Sample rate conversion is available on every input so the card can accept input rates from 32kHz to 96kHz. The connectors are all D-25 type females and mating connectors can be supplied (as a cost option).

A breakout panel is available as an option for the 75 $\Omega$  card – this converts D-25 connectors to chassis BNC plugs and comes with 1m connecting looms. These panels should be mounted behind the Centuri rack; they cannot be remotely located because the linking cables are unbalanced.

Front mounting versions of the digital cards are available to special order only.

### **Centuri – Madi Card (Copper version)**

The MADI I/O card can operate in two ways: either as a 56 channel varispeed I/O multitrack interface (at 48kHz  $\pm$  12.5%) or as a 64 channel fixed 48kHz link (station router). In either case a source of sync is required. The sync source can be AES, Word sync or self clocked from the MADI bitstream. This sync source must be derived from the same station video reference as used for the CPU card sync input.

The card is fitted with dual MADI connections – MADI A and MADI B. The outputs are duplicates of the MADI signal so that a safety backup can be made without having to use external distribution. For the inputs, MADI A has priority but MADI B will take-over if the A signal is lost.

### **Centuri – Madi Card (Fibre version)**

Operates exactly the same as the copper version but the MADI connectors are now singlemode or multimode SC optical types. The fibre type must be specified at time of order.

### **Centuri – GPI/O Card**

The optional GPI/O card provides 60 GPI inputs and outputs. Inputs (which can trigger many console functions including channel faders and cuts) are opto-isolated. The outputs are provided by relay closure. Access is via 25-pin D-type connectors; inputs are male and outputs are female.

Only one GPI/O card can be fitted to the Centuri rack.

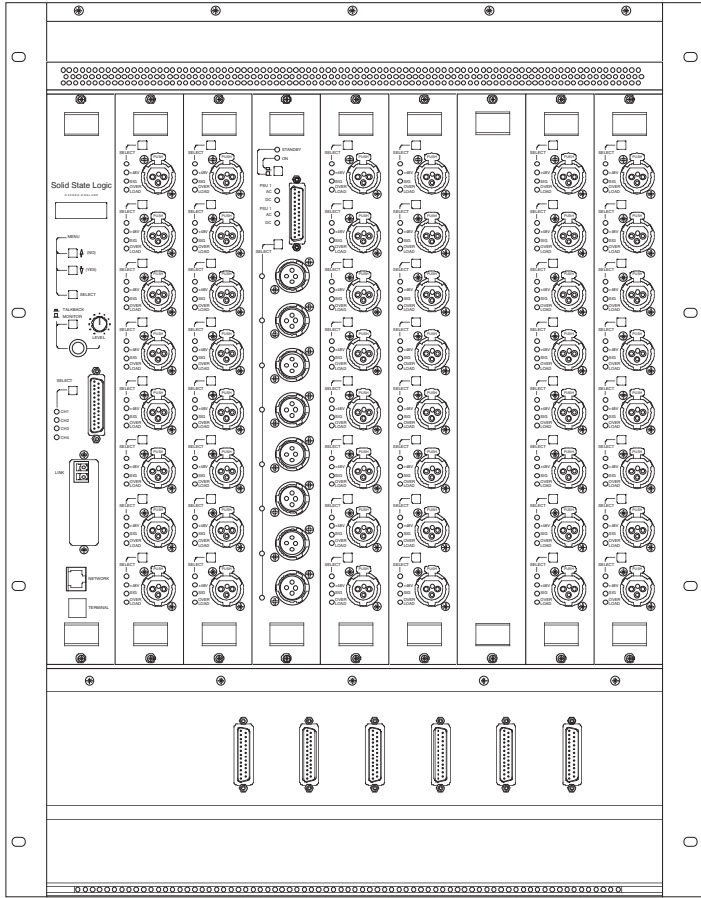

**C-SB Stagebox  
(Front View)**

Up to:  
48 inputs  
48 Split outputs  
16 Line outputs  
4 GPI I/O  
Single or dual Fibre Link

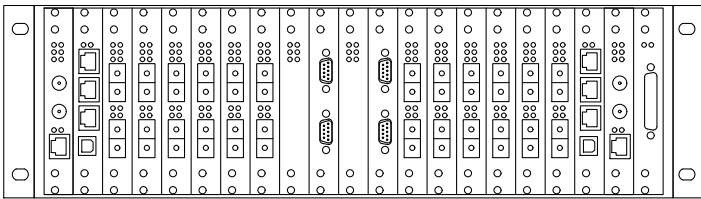

**MORSE Router**

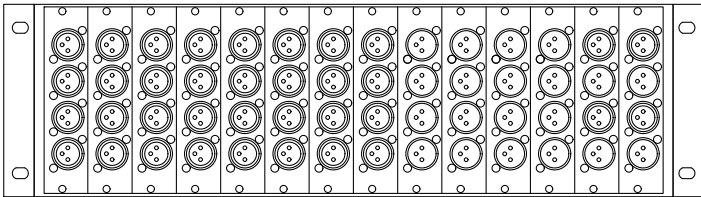

**MORSE 3U Stagebox**



## C-SB Stagebox (option)

The C-SB is a Mic/Line input/output stagebox which can be located remotely from the Centuri chassis. It operates at 48KHz sample frequency and is a 14U high, 462mm deep, rack-mounted unit.

At the front of the unit are nine slots for plug-in cards: six slots for mic/line input cards; two slots for line output cards and one for the CPU card. At the rear is an auto-ranging switch-mode power supply. This will accept input voltages from 90–250v without adjustment. The PSU units provide two un-switched mains outlets via IEC 6A shuttered sockets. A 2nd power supply unit may be fitted to provide redundancy.

Each micamp input card provides 8 channels, therefore a C-SB rack may be fitted with from 8 to 48 mic inputs. The line output card also provides 8 channels but also features 4 channels of GPI relay closure. The CPU card is fitted with a headphone socket to allow local monitoring of sources and also provides four analogue outputs via a 25-way D-type connector. These outputs are assigned from the console and may be used for additional analogue feeds, such as talkback or SLS.

Each mic input is provided with a split output. This output functions in the same way as the BMA circuit. (ie. post pad, limiter and 26dB buffer but pre the variable gain stage). The split outputs are available on 25-way D-type male connectors.

Remote stageboxes are linked to the Centuri core using duplex LC fibre-optic cable<sup>(1)</sup> for the audio data and a separate ethernet cable<sup>(2)</sup> for the control functions (gain, pad, filter etc.). The audio fibre links to a stagebox can be duplicated thus creating audio redundancy for critical or on-air reliability. (Fibre Links for the Centuri rack should be specified at the time of order).

The standard unit is fanless and so can be located within the live production area; subject to the following note. A low-noise fan ventilation kit is available as an option.

*Note: The stagebox racks are cooled by convection at the front of the rack. The air flow from bottom to top of the front panel must not be obstructed in any way (cable guides are provided at each side to route cables away from the air intake). The air temperature at the intake and at the rear PSU heatsinks MUST NOT exceed 30° Centigrade.*

*Special considerations need to be observed when fitting stageboxes into flight cases – refer to Appendix F.*

*(1) The fibre optic cable is available in two types: for distances of up to 550m (multimode fibre) and distances of up to 2Km (singlemode fibre).*

*(2) The standard maximum limit for ethernet cable is 100m. For distances of over 100m ethernet repeaters may be needed. Alternatively, the ethernet cable can be converted to fibre. This can then run the same distances as the audio fibre. Please discuss specific requirements with SSL's Project Engineering Department.*

## MORSE System (option)

The MORSE (MODular Resource Sharing Engine) system provides a cost-effective, scalable solution for the sharing of local or remote audio I/O and managing control data. The system is designed for on-air reliability and features optional redundancy on all data links and fault tolerant proprietary software.

The system comprises a central router to which remote stageboxes and consoles are connected via optical MADI links. Up to 24 individual links are available.

The router is a 3U 19" rack unit. Stageboxes are connected to the router and I/O can then be allocated to any C100 console connected to the router.

Stageboxes can be 3U or 6U 19" rack units and each can be fitted with up to 56 channels of I/O. Plug-in modules are available for mic, line, AES, MADI and SDI (*due 2007*). A 2nd redundant power supply can be fitted to the 6U version. Stageboxes are connected to the router using one or two duplex optical MADI links.

The MORSE system is more fully described in a separate document. Part number 82S69MOR10A.

### NetBridge (Front View)

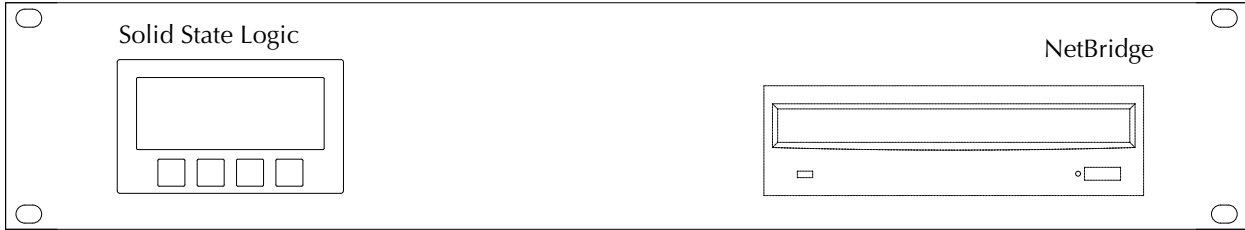

### NetBridge (Rear View)

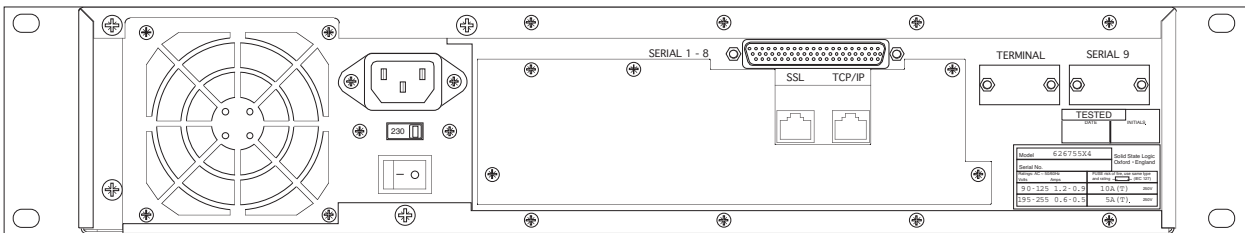

### NetBridge - PSU Voltage Selection

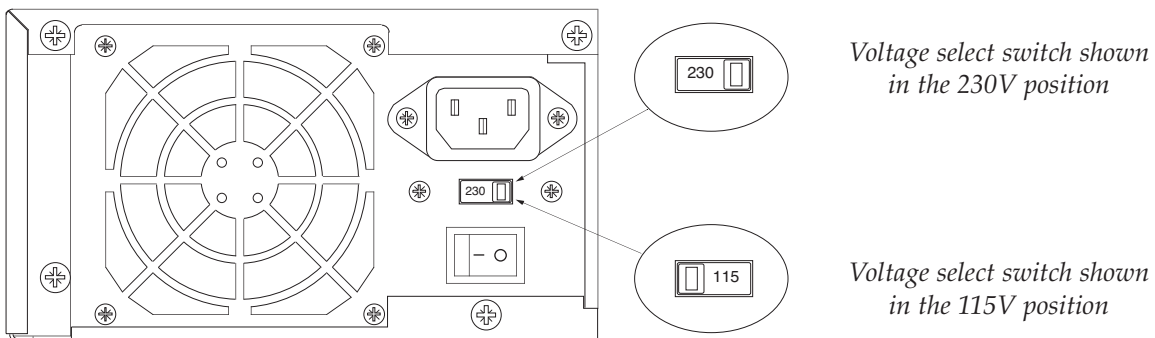

## NetBridge (option)

NetBridge is a 2U rack mounting unit.

The NetBridge provides two main features. Firstly (as the name suggests) it is a bridge between the proprietary Solid State Logic network, and the standard TCP/IP protocol, allowing remote diagnostic connection over the Internet. Up to 7 diagnostic ports may be served by a single NetBridge unit, with secure log-in facilities enabling trained staff or SSL engineers to access diagnostic functions remotely from any location worldwide.

*Note: Do not combine the SSL Network and the facility's TCP/IP network; they are different protocols.*

Secondly it can be used to transfer data files between the C100 console to which it is dedicated and the 'SSL-Network' central file server (CFS). This allows C100 session templates (used for offline configuration) and project archives to be moved across the Internet without requiring access to the console's CPU.

Using the secure login access provided by NetBridge, users may upload a console template to a secure website, edit the configuration offline and then reload their profile prior to the production saving valuable setup time. Parameters available for offline configuration include fader strip allocations, channel names and type, bus routing assignments, processing order, output options and fader grouping setup.

NetBridge requires access to the facility's internet service. To do this, an Ethernet connection will be required. The NetBridge will also need permission to access the SSL Network secure server; this may require the configuration of any firewall software that may be in use. (See page 39 for further information.)

NetBridge does not have dual power supplies as it is not critical to console operation.

*Note: NetBridge is not fitted with an auto-ranging power supply and the input setting must be confirmed before applying power. The voltage select switch is located on the rear of the PSU unit, see opposite for switch location.*

*To change the setting:*

- 1. Switch off and remove the IEC lead.*
- 2. Using a small flat-bladed screwdriver, slide the select switch so that the appropriate voltage is indicated.*

### Location Of Bellypanel USB Connectors

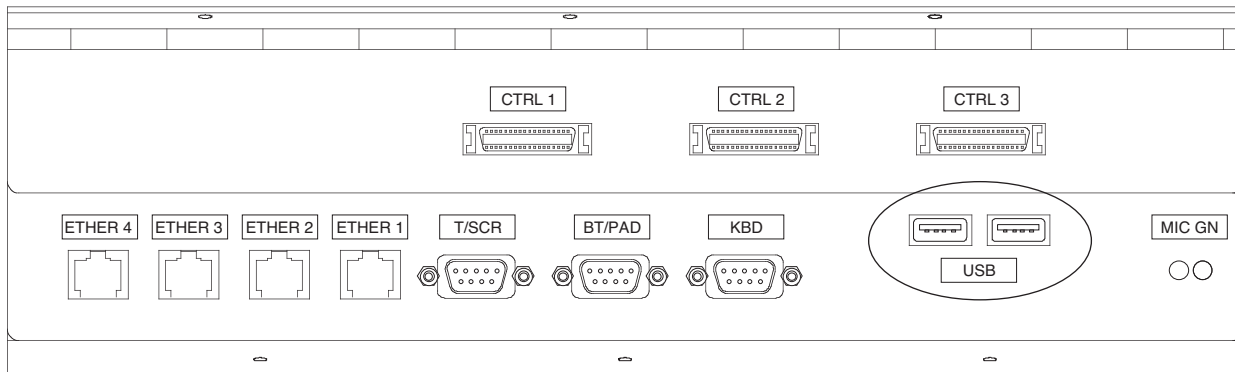

### **External Keyboard / Trackball (options)**

There is an inbuilt software keyboard included in the C100 system. This is accessed via the Centre Section touch screen.

Alternatively an external USB computer keyboard and or USB mouse/trackball may be connected to the audio connector panel using the connectors provided. The diagram opposite shows the location of these connectors.

### **Script Tray (option)**

The script tray is a movable transparent panel which fits over a channel bay. It has rollers fitted to allow it to move along the length of the desk.

The script tray does not require modifications to the console and can be added to existing consoles.

### **Loudspeaker Shelf (option)**

A flat secure shelf is available for the positioning of loudspeakers, monitors etc. Each shelf is 400mm wide by 253mm deep. A supporting rail is fixed to the console back panel for each speaker shelf. Additional support rails can be fitted so that shelves may be moved to different positions along the console.

### **TFT External Input (option)**

This option allows any of the channel bay TFT screens to be switched to show an external XGA (1024x768) video signal. The switchover is effected either by a GPI closure triggered from a free button or by a dedicated switch mounted on a custom panel (not included).

### Console Mains Inlet Panel

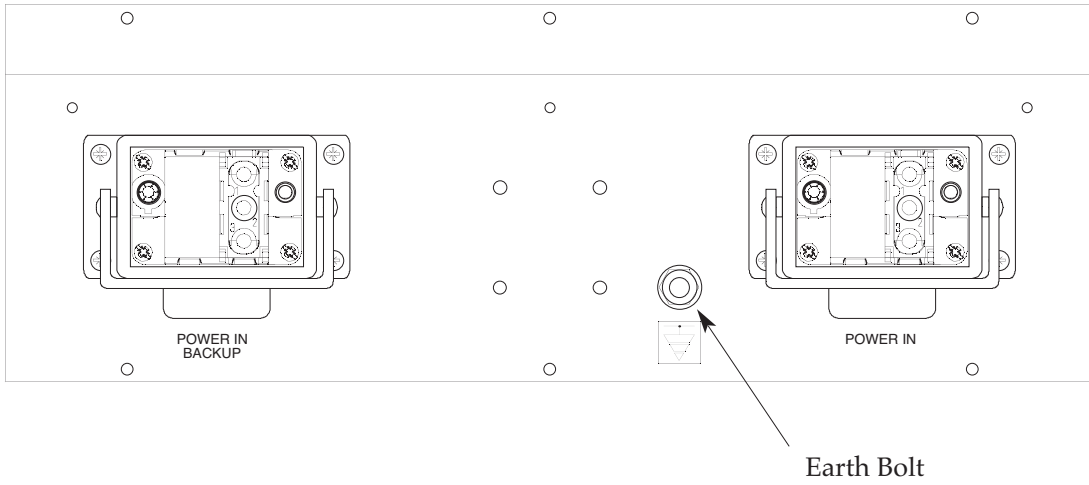

### Centuri Mains Inlet Panel

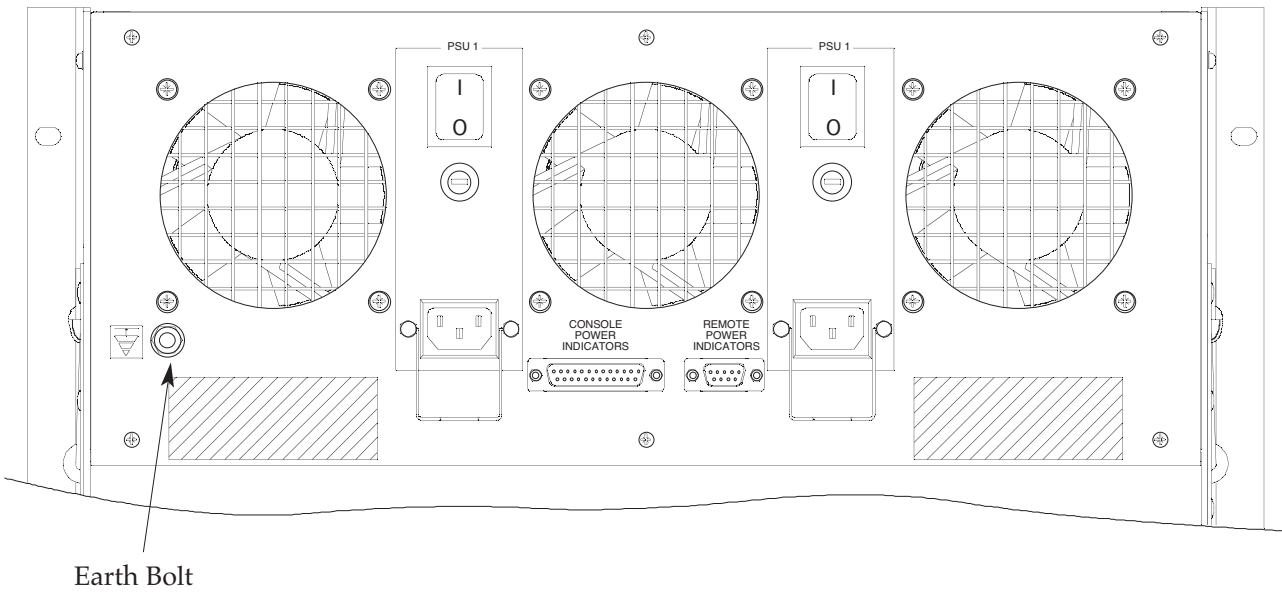

### NetBridge Rear Panel

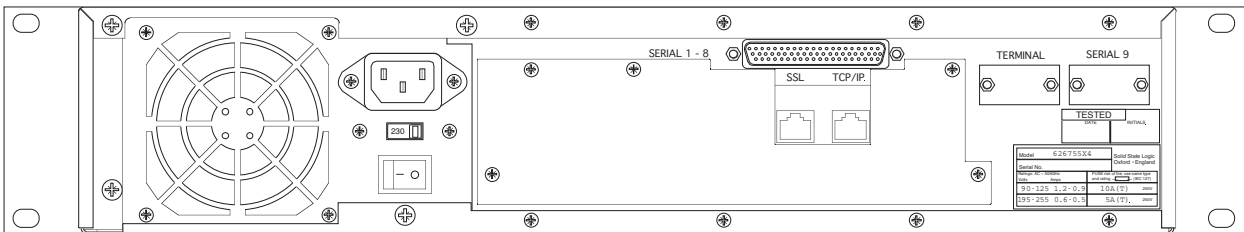

## Section 5 – Installation Wiring

This section provides the details for connecting the system components together.

### Power Supply Connections

*This section refers to the following supplied cables (:*

<i>Description</i>	<i>SSL Part No.</i>	<i>qty</i>	<i>Notes</i>
<i>Con IEC Free Socket 6A 2m</i>	<i>32VGL362</i>	<i>2</i>	<i>Centuri</i>
<i>Cable Power Digital 2m</i>	<i>32VALXVX</i>	<i>2</i>	<i>Main &amp; Redundant Console power</i>
<i>Lead Chassis Earth 16m</i>	<i>66C93115</i>	<i>1</i>	<i>Console to Centuri</i>

- a) Connect both the console's Harting mains leads to independent mains supplies. For live transmissions work it is recommended that one of the power sources will be from an un-interruptable source. The console is fitted with auto-ranging power supplies which will accept mains voltages which range from 90 to 255V without adjustment.

THE TWO POWER SOURCES MUST NOT BE FROM DIFFERENT PHASES OF A 3-PHASE SUPPLY.

THE MAINS SAFETY EARTH MUST BE CONNECTED

- b) Connect both the Centuri's IEC leads to independent mains supplies. The Centuri crate is also fitted with auto-ranging power supplies which will accept mains voltages which range from 90 to 255V without adjustment.
- c) If specified, do not connect a source of power to the NetBridge until the voltage select switch position has been confirmed. The NetBridge operates at either 115V or 230V ranges and its power supply must be set to the appropriate range for the local supply.

Refer to the diagram on page 22 for the location of the voltage select switch.

- d) **Earth Wiring** – A chassis to chassis earth cable needs to be installed between the console and the processor. This keeps the two earths at the same potential thus preventing currents flowing along the signal cables.

Run the green chassis earth cable from the Console's earth bolt to the similar earth bolt located on the Centuri chassis.

### Control Surface Wiring - Block Diagram

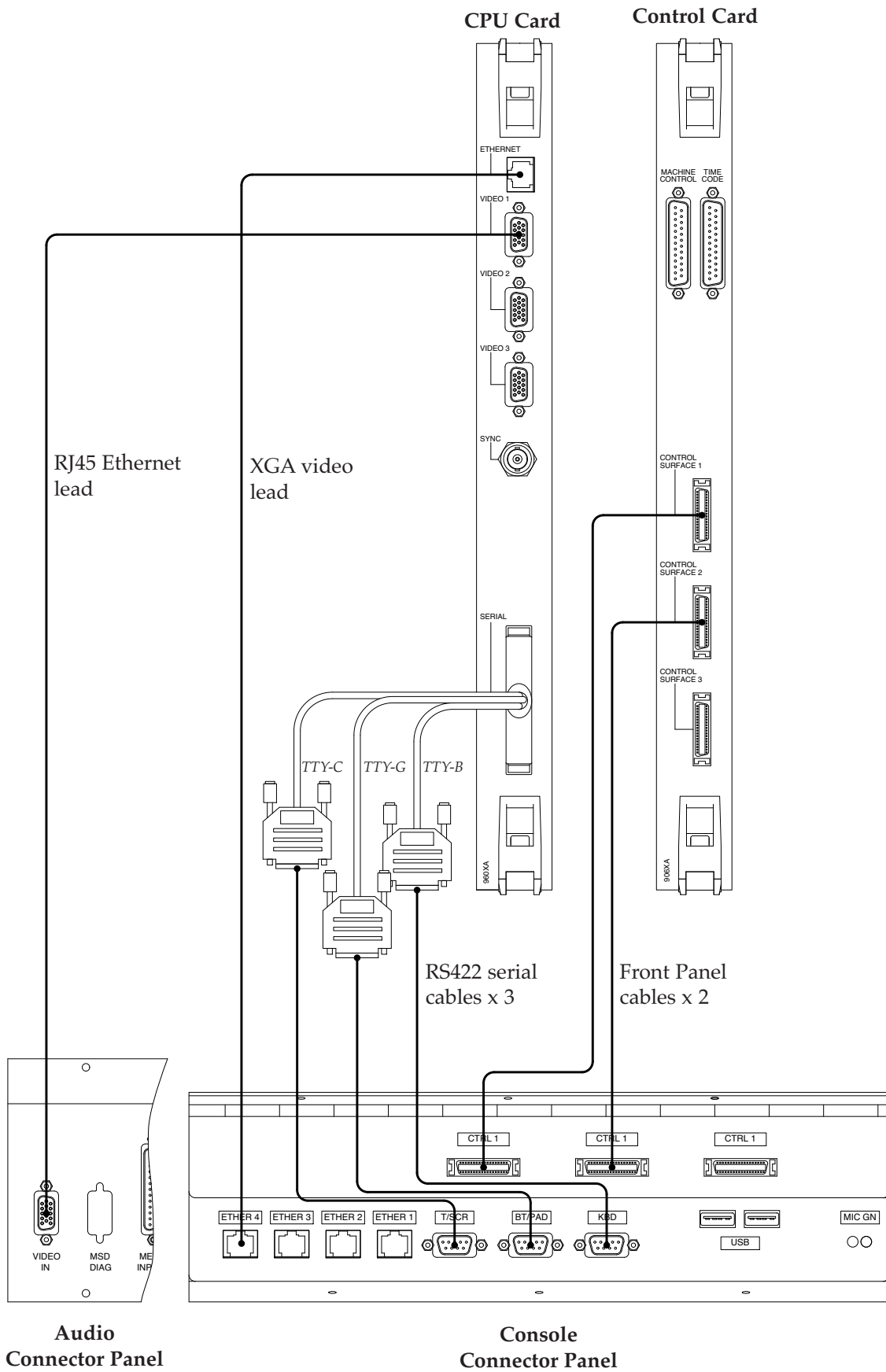



## Centuri to Console Surface Connections

This section refers to the following supplied items:

Description	SSL Part No.	qty	Note
Lead 9WD plug to 9WD plug 16m	66C66815	3	Touchscreen,
Lead RJ45 Shielded 15m	66C67316	2	
Lead Video HD15W D-Type 16m	66DN(16) V1	1	(20)=20m, (25)=25m, (48)=48m
Loom 36-way H/D Digital 16m	66CN00(16)	2	(48)m and (80)m options only
Cable assembly 62 way plg to 8 x 9WD plg 1m	66DNCSA8	1	
Adapter 9 way D con F to F	32PM09XV	8	converts above to female connectors

- a) **Front Panel Cables** – Locate the two MDR–MDR front panel cables and connect them between the Centuri Control card and the console interface panel as shown opposite. Although there are three connectors at both the Centuri and the console end, only connectors 1 and 2 are used.

These cables are symmetrical, having the same connectors at each end.

*Note: The front panel cables are only supplied in 16m, 48m or 80m lengths. This is due to a timing requirement for the high speed serial data. Do not attempt to shorten these cables. The connectors on these cables are not removable.*

- b) **Network Cable** – The Centuri processor uses an RJ45 Ethernet network to communicate with the C100 console, Stageboxes and NetBridge. The console has a built-in 4-way Ethernet repeater.

Connect the ethernet lead between the Centuri CPU card and any of the four 'Ether' sockets beneath the console.

If Netbridge is specified then a second RJ45 Ethernet lead will be supplied with the system. This lead is connected between the console and the 'SSL Network' connector on the NetBridge rear panel.

- c) **Serial Cables** – Three RS422 serial cables are supplied for the installation. These connect the CPU card in the Centuri to the touch screen, the bitpad (keyboard trackball) and the keyboard (if fitted).

The processor card is fitted with a 62-pin connector for the eight serial ports. An adapter lead which breaks-out the 62-pin connector to eight off 9-way D-type male connectors is provided. Connect the three serial leads as shown in the diagram opposite ensuring that the correct 'TTY' connector is used in each case. Note that 9-way D socket–socket adapters will be necessary at the Centuri end.

- d) **Video Cable** – There are three video outputs available on the CPU card. Video 1 and Video 3 are static background displays. Video 2 is used for the Centre section touch-screen display.

Note that the picture output from video 2 is rotated 90° so the Centre Section touchscreen can be used in 'portrait' orientation. If for any reason you wish to duplicate the video 2 output, then any monitor used will have to be turned onto its side to display correctly.

Connect the video cable as shown in the diagram opposite. The cable is male-male so does not have to be run in a particular direction.

*Note: SSL does not recommend that the supplied video cable be extended. Doing so may reduce the video quality as the cable is matched to function over long runs; these cables are of a high quality individually screened type. Longer cables are available from SSL.*

### PSU Status Wiring Diagram

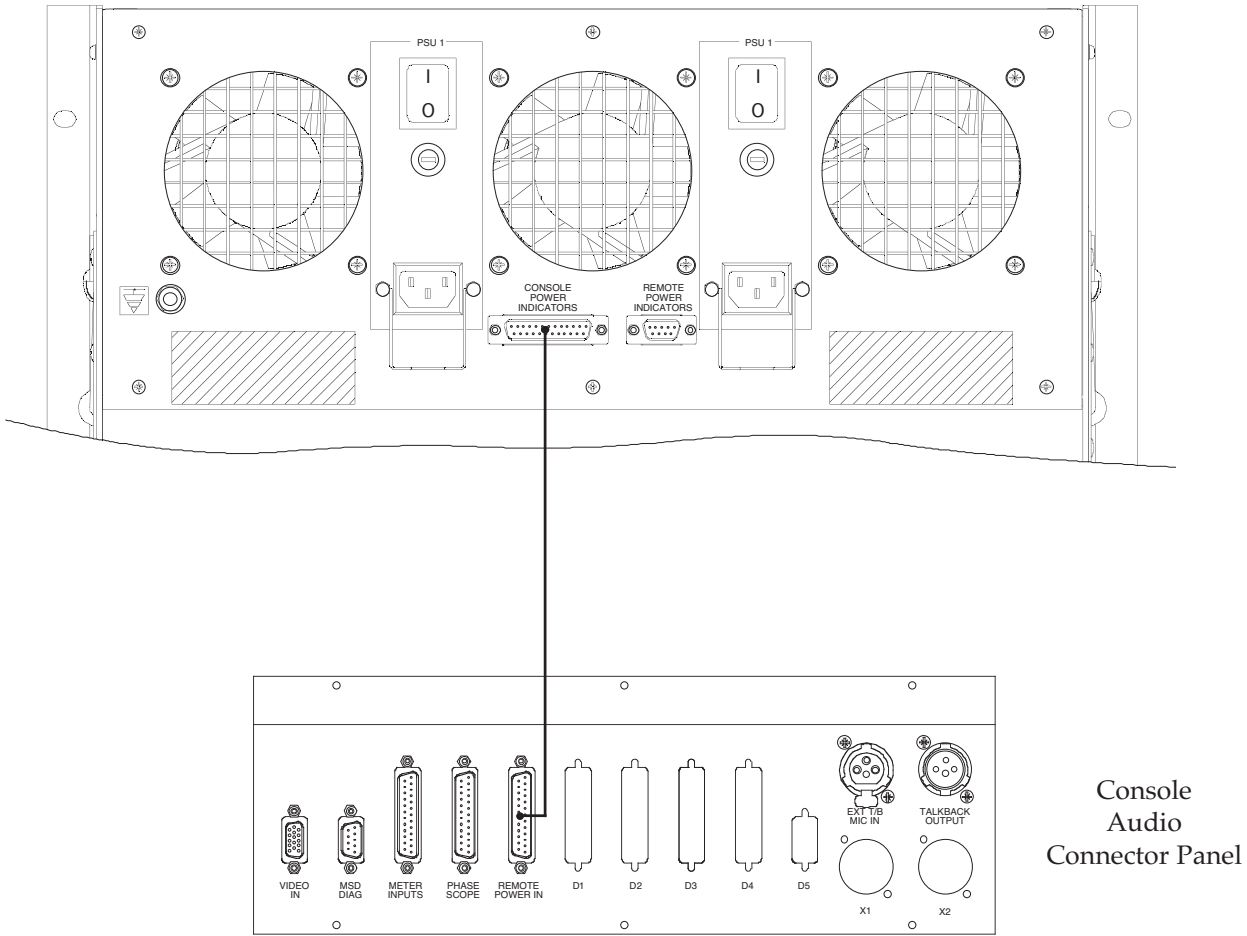

Console Audio Connector Panel

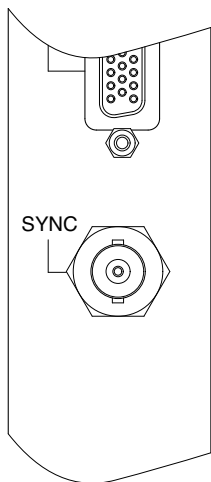

### CPU Card

Sync Input connector

## PSU Status

*This section refers to the following supplied items:*

<i>Description</i>	<i>SSL Part No.</i>	<i>qty</i>	<i>Note</i>
<i>Cable 25-way D Plug to Socket 16m screened</i>	<i>66C67781</i>	<i>1</i>	

- a) The PSU Status cable carries the status indication of the two Centuri crate PSU units.

Install the the 25 pin male to female lead and connect as shown opposite; the male end of the cable connects to the Centuri and the female to the console.

*Note that the 9-way connector 'Remote Power Indicators' is not used. This connector was allocated for power indication from remote I/O units which are no longer available.*

## Sync Source

*This section refers to the following supplied items:*

<i>Description</i>	<i>SSL Part No.</i>	<i>qty</i>	<i>Note</i>
<i>Terminator plug 75R</i>	<i>32TKB7TC</i>	<i>1</i>	
<i>BNC 75R TEE Adaptor</i>	<i>32TKU7CC</i>	<i>1</i>	

- a) Connect the source of video sync to the SYNC IN connector on the processor crate using the T-adaptor and 75Ω Terminator supplied to provide termination.

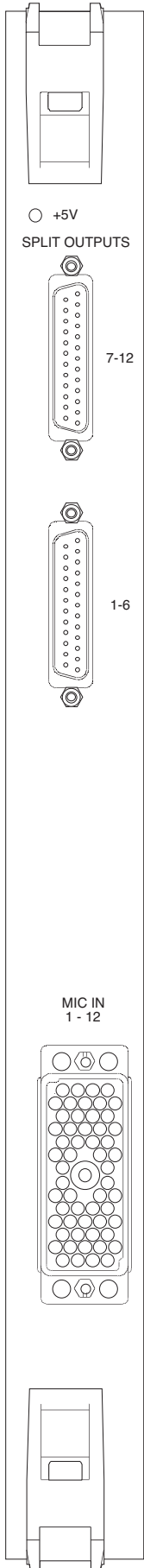

**Micamp Input Card**

Split Output Connectors  
*25-pin D-type female*

Microphone input Connector  
*Varicon 56-way female*



**Analogue I/O Card**

Analogue Input Connector  
*DL96 female*

Analogue Output Connector  
*DL96 female*

### **I/O – MicAmp Card (SSL ref. 908)**

Each MicAmp Input Card contains 12 Microphone circuits. The inputs are accessed via a Varicon (aka. EDAC or Elco) 56-way female connector.

The split outputs are accessed via two 25-pin D-type female connectors.

Refer to Appendix C for the connector pinouts.

SSL is able to supply mating connectors if requested, (at additional cost).

If more than one micamp card is fitted then the card furthest to the right will have the lowest input number and the channel numbers will increment by 12 as each card is added. Any cards added subsequently, should be placed to the left of any existing cards otherwise the channel numbering will be altered.

### **I/O – Analogue input/output Card (SSL ref. 904)**

The Analogue Card provides 24 circuits of electronically balanced input and output. These circuits are accessed via Canon DL 96 way female connectors; mating connectors are available to order

Refer to Appendix C for the connector pinouts.

As is the case for the MicAmp, cards added subsequently should be placed to the left of existing cards.

The default line-up level for analogue I/O is 0dBFS = +18dBu. This level may be globally altered and can range from +9dBu to +24dBu. The value can be adjusted from a setup screen to match the standard operating level for the facility.

*Note. When assigning analogue card output channels as insert sends, the routing system will automatically assign the same input channel number as the corresponding return. It is therefore necessary to physically wire outboard equipment so that circuit allocation follows this arrangement.*

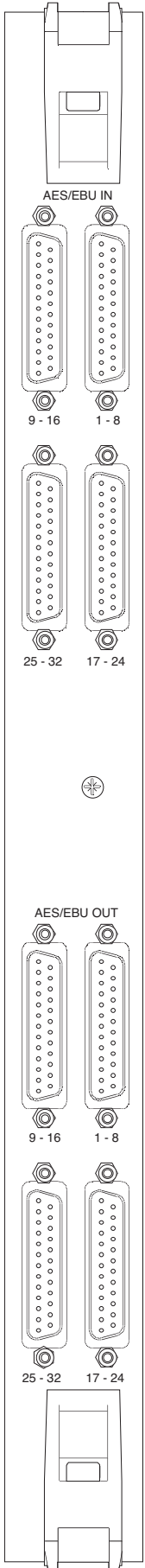

**Digital I/O Card**  
(D25 version)

AES/EBU Input Connectors  
*25-pin D-type female*

AES/EBU Output Connectors  
*25-pin D-type female*

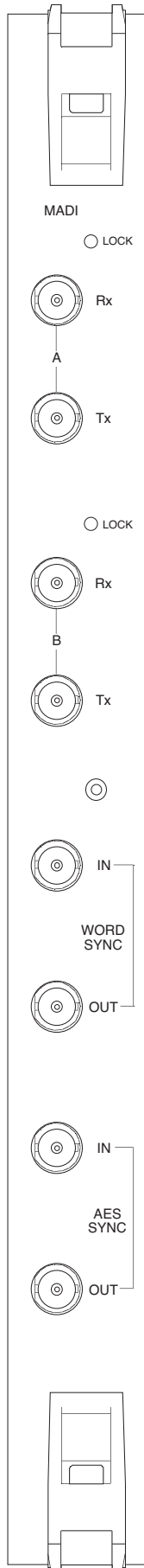

**MAD I/O Card**  
(Copper version)

MADI Link A  
BNC 75Ω

MADI Link B  
BNC 75Ω

MADI Word Sync  
BNC 75Ω

AES Sync  
BNC 75Ω

### **I/O – Digital Input/Output Card 110Ω (SSL ref. 902XF)**

The Digital Input Card provides 32 balanced AES/EBU signal pairs of both input and output. All circuits are accessed via 25-pin D-type female connectors.

Refer to Appendix C for the connector pinout for this card.

Mating connector kits can be ordered for the card.

As in the case of the Analogue I/O, cards added subsequently should be placed to the left of existing cards.

*Note. When assigning digital card output channels as insert sends, the routing system will automatically assign the same input channel number as the corresponding return. It is therefore necessary to physically wire outboard equipment so that circuit allocation follows this arrangement.*

### **I/O – Digital Input/Output Card 75Ω (SSL ref. 902XJ)**

This version of the Digital I/O card is externally identical to the the 110Ω version (apart from its designation number). The Impedance of each input and output circuit however, is now 75Ω for correct matching to installations using co-axial cabling.

A separate BNC interface panel is available as a cost option. This is 2U high and is fitted with 64 chassis mounted BNC plugs – 32 input and 32 output. 1metre D25–D25 interconnecting looms are provided.

As in the case of the Analogue I/O, cards added subsequently should be placed to the left of existing cards.

*Note. When assigning digital card output channels as insert sends, the routing system will automatically assign the same input channel number as the corresponding return. It is therefore necessary to physically wire outboard equipment so that circuit allocation follows this arrangement.*

### **I/O – MADI Card (SSL ref. 902XG copper version / 902XH/K fibre versions)**

The MADI I/O card can operate in two ways: either as a 56 channel varispeed I/O (multitrack interface) or as a 64 channel 48kHz link (station router). In either case a source of sync is required. The sync source can be AES, Word sync or self clocked from the MADI bitstream.

The Card is fitted with dual MADI connections – MADI A and MADI B. The outputs are duplicates of the MADI signal so that a safety backup can be made without having to use external distribution. On the input side, MADI A has priority but MADI B will take-over if the A signal is lost.

The fibre version of the card – see page 18 – has duplex SC optical connectors for both MADI A and B. The Fibre type can be either singlemode or multimode (this must be specified at time of order).

### GPI I/O Card

GPI input Connectors  
25-way D-type Male

GPI output Connectors  
25-way D-type Female

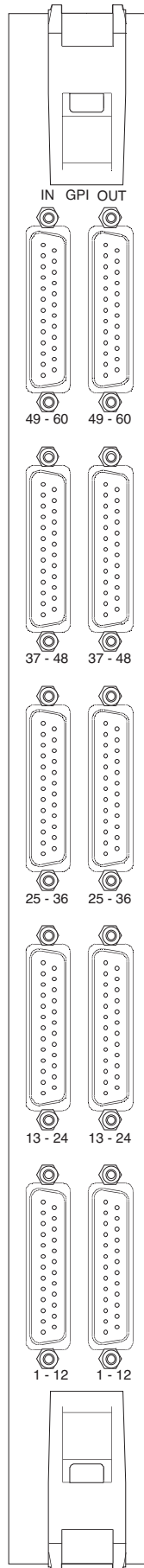



## I/O – GPI I/O (SSL ref. 907XA)

The GPI I/O Card contains 60 circuits of opto-isolated input and 60 circuits of relay-closure output. Inputs are accessed by 25-pin D-type male connectors and outputs by 25-pin D-type female connectors; mating connector kits are available to order.

Both the input and the output circuits are fully isolated from the processor electronics. On output connectors, there is a protected source of +15V available and a 0V reference is available on input connectors.

The input and output signals can be either latching or momentary; this is individually assigned in software using the touch screen. When set to momentary, the input signal duration needs to be greater than 50mS.

*Note: When used for track arming and tally, the tally must return to the same number input as the output signal. (ie. the tally for GPI out 1 will be on GPI in 1).*

The switch closure is by DIL relay. Contact rating is 100Vdc, 125Vac, 100mA max. Do not use the output contacts to directly switch capacitive or reactive loads; always use an external relay with a suitable contact rating.

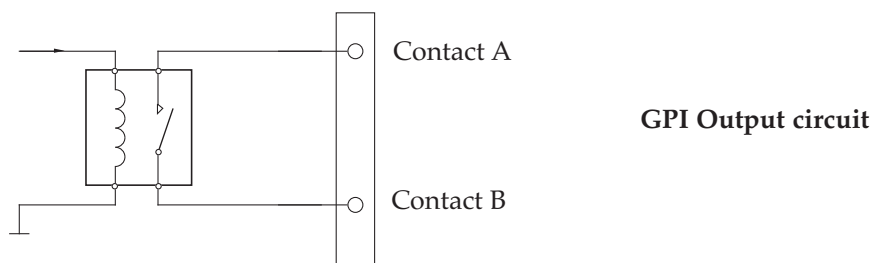

The signal input requires AC or DC voltage between 4V and 30V. The current drawn is approximately 10mA.

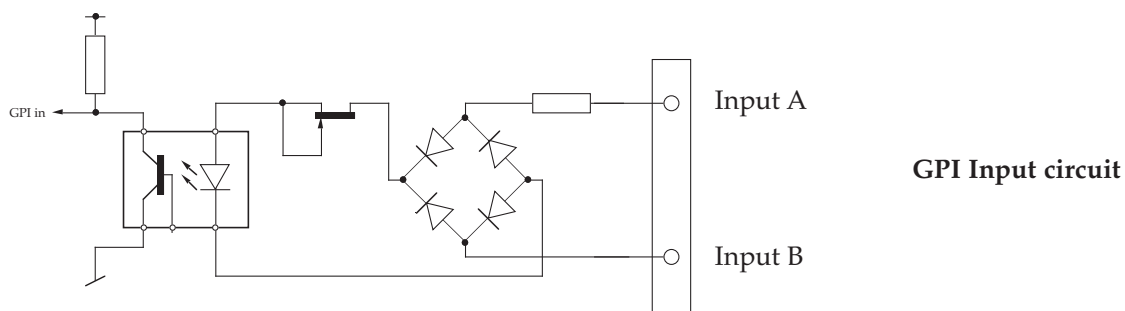

### Fibre Link Connectors and Panels

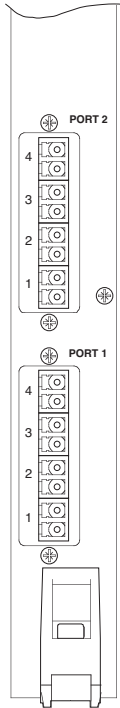

**Centuri Link Card**  
With four redundant links

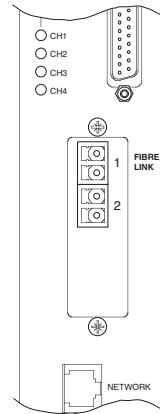

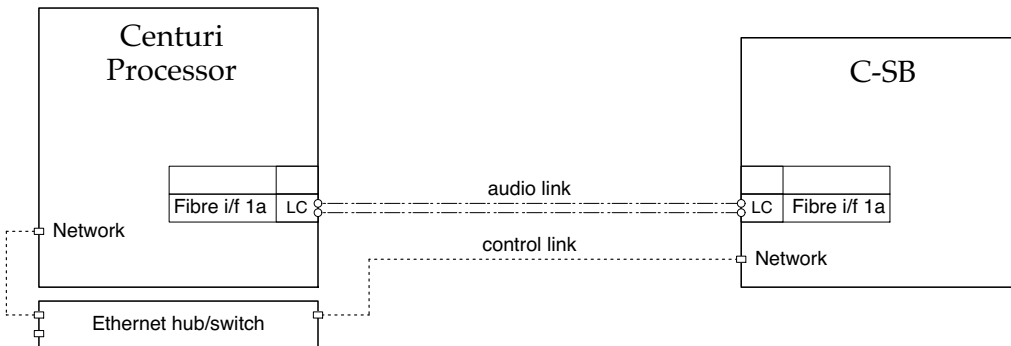

**C-SB CPU Card**  
With redundant Fibre Link

### C-SB Cabling Diagrams

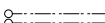

**Single Fibre-Link with RJ45 control link (100m max)**

duplex fibre link   
RJ45 ethernet 

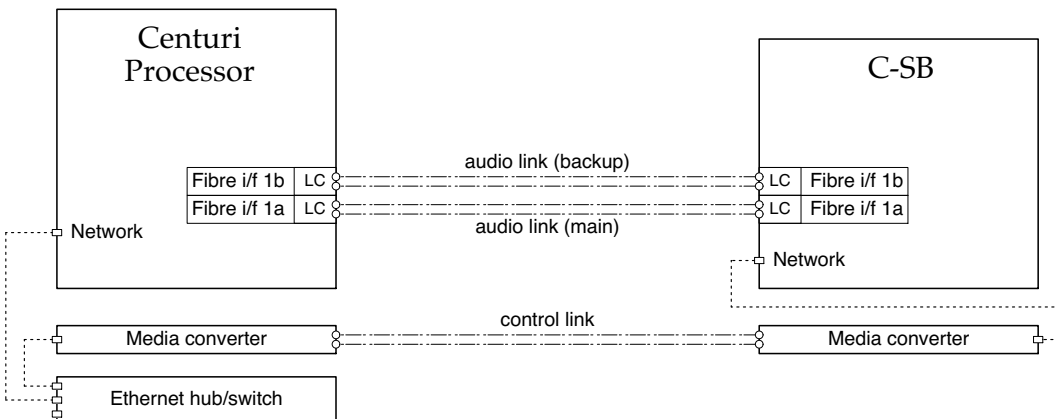

**Dual Fibre-Link with fibre control link (>100m)**

## Stageboxes & Fibre Links

The C-SB Stagebox utilises fibre-optic connection between itself and the Centuri Processor. This has the advantages of noise immunity, reduced weight and bulk of wiring and the elimination of earth loops. A separate control signal (for gain, pad, filter etc.) is carried over the SSL ethernet network. This control signal can be converted into fibre optic for runs longer than 100m.

The standard connectors for the fibre links are duplex LC at both the Centuri and the Stagebox ends. A 2m lead is provided as standard with each stagebox.

When Stageboxes are specified, it is recommended that a 10/100 ethernet hub/switch is installed so as to provide isolation for the remote network connection(s). A 1U rack mounting 16-port switch is available as a cost option.

Longer fibre cables and/or ruggedised OB cable using adaptor panels/patch panels are options. SSL is able to provide a range of fibre solutions although the facility may prefer to provide its own fibre installation. Details of fibre installation options should be discussed with SSL's Project Engineering Department at the time of order.

For location of Stageboxes at distances of greater than 100m from the Centuri rack the ethernet control cable will have to be buffered – using an ethernet repeater/switch – or converted to fibre.

The maximum length for a multimode Fibre Link is 550m, and for singlemode is 2km.

The Centuri Routing card can be fitted with up to eight Fibrelinks. These are arranged in four groups of two labelled as 'Port 1' to Port 4'.

*Note: Each Port on the Routing/Link card actually provides up to four separate connections (two pairs). Connections numbered 1 and 3 are for the primary Fibre Link and numbers 2 and 4 are reserved for the optional redundant links.*

Remote stageboxes may be connected to the Centuri core in any order.

### NetBridge Installation

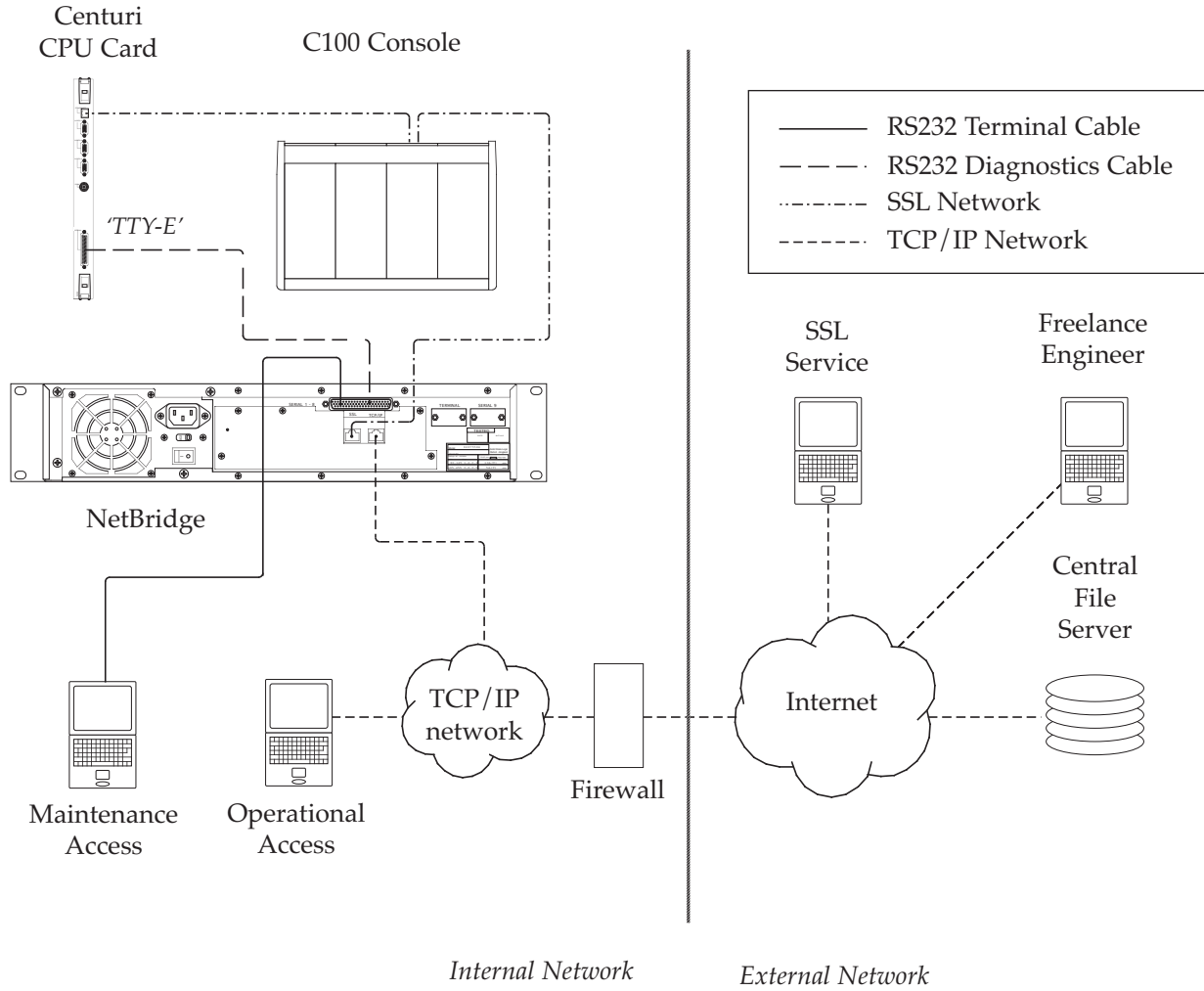

## NetBridge Installation

NetBridge has eight serial ports plus two Ethernet ports. The first Ethernet port is connected to the C100's network. The second port is for connection to the Internet; this can be via DHCP server (for a dynamically assigned IP address), or a static IP address defined by the operator. The IP number (in 'dot' notation) will be shown on the front panel while the unit is powered.

In facilities with a firewall to the Internet, this address is likely to be for internal use within the installation and not visible to the outside world. For external diagnostic access, the firewall will have to be set to pass (and redirect) the appropriate incoming traffic to the NetBridge unit, which will have to be agreed with and configured by the facility's IT staff.

NetBridge operation is more fully described in a separate document which is supplied with the hardware.

### Connection

The eight serial ports are all located on the single 62-pin connector (a breakout adaptor is provided). Serial ports 1 to 7 can be connected to the 'Console' port on the Centuri's CPU card (on port TTY-E), allowing one NetBridge to have terminal diagnostic access to up to seven C100 processors.

Serial port 8 may be connected to a data terminal (or software terminal emulator) for permanent local diagnostic access without requiring login. (see Appendix C for cable details)

### Access

For security purposes, the NetBridge file transfer functions can only be accessed by one registered user who must be logged into the Central File Server (CFS). This uses the secure HTTPS protocol, which must be passed through any firewall (and redirected as required), although this is unlikely to cause any security concerns as it has 128bit Secure Socket Layer encryption. For file transfer between the console and the CFS, the user must be logged in at the console itself. For file transfer between the CFS and another computer (eg. authorised freelance engineer or SSL support staff), the user may login from an Internet connection, with the same username and password security requirements.

Diagnostic access also uses 'Secure Socket Layer' encrypted login, and is available to multiple users simultaneously over the TCP/IP network link. They can log-in as terminal users and each run the terminal client application on the NetBridge to give them switched access to the seven serial ports.

### File Transfer

If a console operator wishes to export a session template to the CFS so that others may create offline setups from it, secure login from the C100 allows that file to be uploaded to the facility's private account on the CFS, so that registered users can download the template and upload their own setups. Any existing setups in that account can be downloaded from the CFS to the console's hard disk.

### Remote Diagnostics

In order to access a C100's diagnostics through its NetBridge, first you need to know the IP address of that unit (on the front panel, or defined by a firewall/router), which can be determined by contacting the facility's IT staff or consulting the security arrangements agreed with them. Once a secure connection has been made, running the terminal server application on the NetBridge will allow you to connect from the Internet to any of the seven 'console diagnostic' ports on that NetBridge.

### Talkback system - Block Diagram

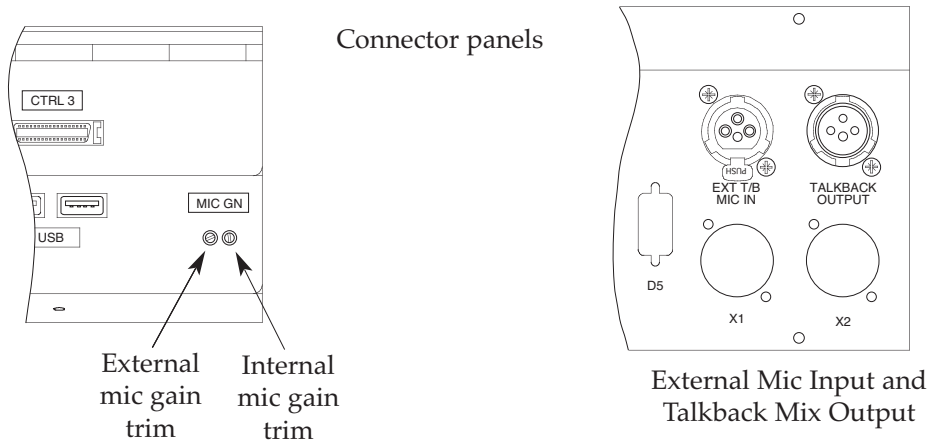
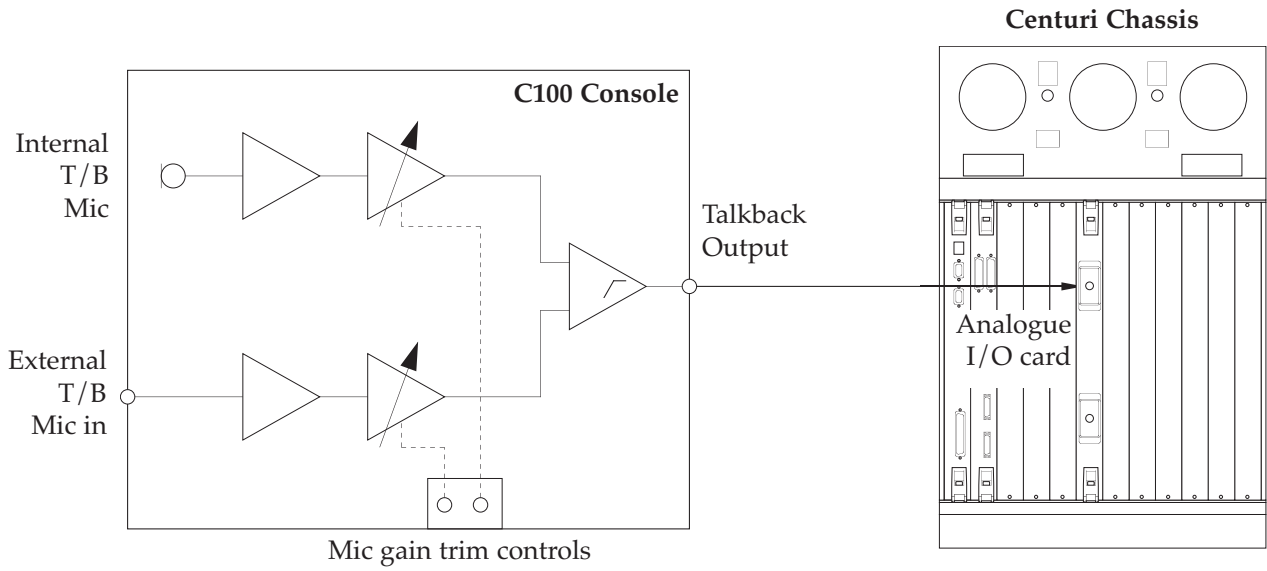

## Talkback and Oscillator

### Talkback Connections

The C100 console contains a built-in talkback microphone and amplifier. In addition, a second input is available for connection to an external dynamic microphone. This input is mixed with the internal T/B mic and the combined signal is available via an XLR connector on the audio interface panel beneath the console. This signal should be connected to an analogue input circuit in the Centuri processor. The circuit chosen can then be assigned as the talkback source via the console's routing.

The gain of each mic signal can be independently adjusted. Access to the trim controls is from beneath the console on the console interface panel.

The external mic input is via a 3-pin XLR female labelled 'Ext T/B Mic In'.

The mixed T/B output is via a 3-pin XLR Male labelled 'Talkback Output'.

See Appendix C for connector pinouts.

### Oscillator Connections

The C100 system includes an inbuilt software oscillator. This can be assigned to any relevant output without additional cabling.

Alternatively, an external oscillator (either analogue or digital, mono or stereo) may be used. In this instance one or two circuits should be allocated on an input card, these can then be assigned in software.

### Meter and Phasescope wiring - MSD 600C

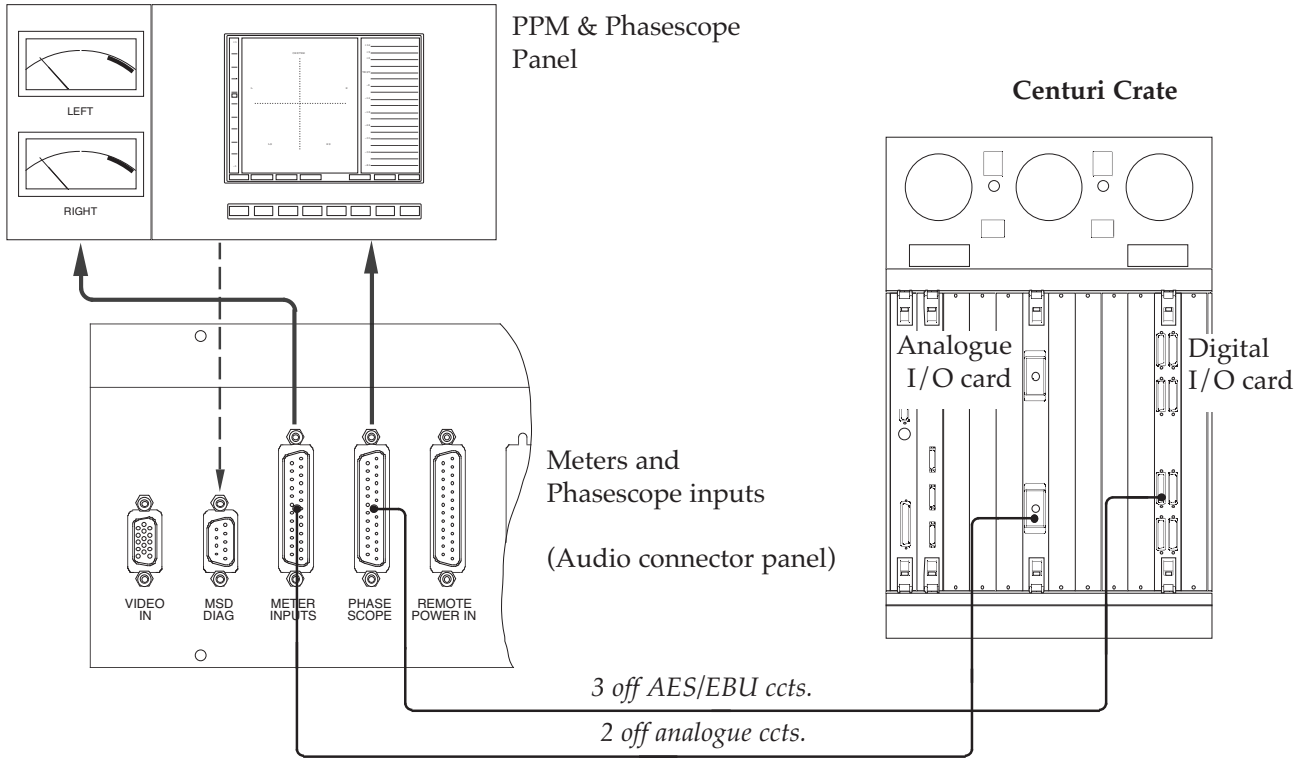

### Meter and Phasescope wiring - RTW 10830

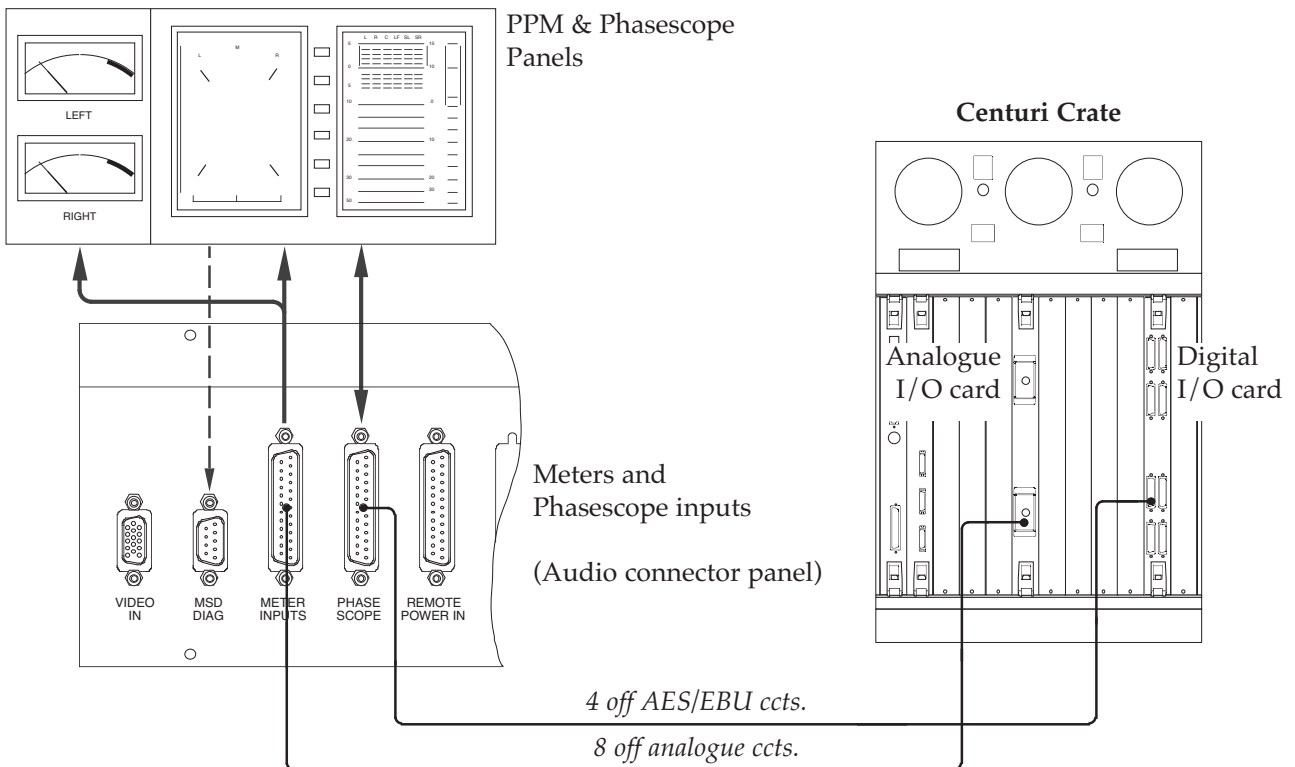



## Meters and Phasescope

The Centre Section of the C100 console may optionally be fitted with an LCD phasescope and/or twin moving-coil mechanical meters (PPM or VU). Two standard phasescope types are available, the MSD600C or the RTW 10830. Other custom meter solutions may be possible.

Cable connections to the meters and phasescope will need to be run between the Centuri and the Console. Both balanced analogue and 110Ω digital cables may be necessary depending on configuration. These cables are not supplied by SSL.

The mechanical meters require two circuits of balanced analogue audio.

The MSD600C 5.1 phasescope has inputs for 6 digital signals (3 AES/EBU pairs), plus a serial diagnostic port.

The RTW 10830 has eight digital input signals, eight digital output signals, eight analogue input signals plus a remote control port. Note that two of the analogue input signals will also feed the mechanical meters.

The Analogue meters could be parallel feeds from the console main output signals or, alternatively, independent feeds from the analogue output card.

See Appendix C for pinouts of the Meter Inputs and Phase Scope connectors.

*Gold is 1.9 times heavier than Lead.*

## Appendix A: Specifications

<b>C100 Console</b>				
<i>Parameter</i>	<i>Condition</i>	<i>Value</i>	<i>Unit</i>	<i>Notes</i>
Height	To top of meter trim	1,056	mm	
Height adjustment		-0+45	mm	
Width: (1)	Centre Section + End trims	440	mm	
	8 fader channel bay	334	mm	
Depth		988	mm	
Weight:	24ch Frame	164	Kg	
	8 Channel Bay (add/subtract)	35	Kg	
	Additional Leg	13	Kg	
Heat Dissipation	24ch Frame	270	W	
	8 Channel Bay (add/subtract)	70	W	
Voltage	Input Range	90 - 255	V	<i>AC only</i>
Current	@ Voltage Range, 24ch	4.4 - 1.7	A	<i>Worst case</i>
	@ Voltage Range, 48ch	7.8 - 3.1	A	<i>Worst case</i>
Power Factor		0.95		<i>approximately</i>
Fusing	None			
Noise	Fanless			
Connectors:	Mains/Backup power in	Harting™ Modular 3-pin		
	Control Surface	3M™ MDR High Density 50-way female		
	Ethernet 1–4	4 x RJ45 100BaseT		
	Video IN	HD15 Female		
	Touchscreen Out	9-way D-type Female		
	Bitpad Out	9-way D-type Female		
	Keyboard Out	9-way D-type Female		
	USB (keyboard)	4-pin USB female		
	Meter Inputs	25-way D-type male		
	Phasescope	25-way D-type female		
	Remote Power in	25-way D-type male		
	MSD Diag	9-way D-type Female (phasescope diag/remote)		
	Ext T/B Mic In	XLR 3-pin Female		
	Talkback Out	XLR 3-pin Male		

- (1) Values relate to straight Consoles with standard trim.  
Reduced and thin trim options are available – refer to SSL's Project Engineering Department.

<b>Centuri Processor Crate</b>				
<i>Parameter</i>	<i>Condition</i>	<i>Value</i>	<i>Unit</i>	<i>Notes</i>
Height:		15	U	
		665	mm	
Width		19	in	
	Case w/o rack ears	449	mm	
Depth		592	mm	<i>excludes cabling</i>
Weight (1)		35-45	Kg	<i>depending on I/O fitted</i>
Heat Dissipation	32 DSP, no I/O	300	W	<i>base</i>
	64 DSP, 24 mics, 48AIO	550	W	<i>typical</i>
	128DSP, 48 Mics, 96 AIO	910	W	<i>maximum</i>
Voltage	Range	90 - 255	V	<i>AC only</i>
Current	Total @ Voltage Range	12.3 - 4.9	A	<i>worst case with max. I/O</i>
Power Factor		0.95		<i>approximately</i>
Fusing	1.25"	12.5(T)	A	<i>each input</i>
Noise		50	NR	
Connectors:	Power In 1 & 2	IEC male		
	Network	RJ45 100 baseT		
	Sync In	BNC 75 $\square$ video		
	Video 1,2 & 3	HD15 female		
	Serial	62-way high density D-type female		
	Control Surface	3M <sup>TM</sup> MDR High Density 50-way female		
	Machine Control	25-way D-type male	<i>Unused</i>	
	Timecode	25-way D-type female	<i>Unused</i>	
	Control Power Indicators	25-way D-type female		
	Remote Power Indicators	9-way D-type male	<i>Unused</i>	
	Expansion	25-way D-type female	<i>Unused</i>	
	MIDI	5-way 180 $^{\circ}$ DIN female	<i>Unused</i>	

(1) Crate must be supported on rack shelves, do not rely on rack mounting ears alone.

<b>Net Bridge</b>				
<i>Parameter</i>	<i>Condition</i>	<i>Value</i>	<i>Unit</i>	<i>Notes</i>
Height:		2 89	U mm	
Width:	Case w/o rack ears	19 432	in mm	
Depth		360	mm	<i>Excludes cabling</i>
Weight (1)		10	Kg	
Heat Dissipation		45	W	<i>Max</i>
Voltage	Switch selectable	115 or 230	V	<i>AC Only</i>
Current:	@ 230 V @ 115 V	0.2 0.5	A A	
Fusing:	100/120 V Range 220/240 V Range	3.15(T) 3.15(T)	A A	
Noise		42	NR	
Connectors:	Power In Network - TCP/IP Network - SSL Serial 1 - 8	IEC Male RJ45 RJ45 9-way D-type Male		<i>via 62-pin to 8 x 9-pin adaptor</i>

(1) NetBridge must be supported on rack shelves, do not rely on rack mounting ears alone.

<b>C-SB Micamp Rack</b>				
<i>Parameter</i>	<i>Condition</i>	<i>Value</i>	<i>Unit</i>	<i>Notes</i>
Height:		14	U	
		620	mm	
Width:		19	in	
	Case w/o rack ears	432	mm	
Depth		300	mm	
Weight	Rack with 1 PSU unit	19	Kg	<i>No I/O cards</i>
	Each micamp/output card	1.7	Kg	
	Additional PSU	5.8	Kg	
Heat Dissipation	(1)	380	W	<i>Max</i>
Voltage	Range	90 - 255	V	<i>AC only</i>
Current:	Total @ Voltage Range	10.0 - 3.9	A	<i>Worst case with max. I/O</i>
Fusing:	1.25"	6.3(T)	A	<i>Each input</i>
Noise	Fanless			
Connectors:	Mains in	IEC Male		
	Mains out (x2)	IEC Female		<i>Unswitched</i>
	Mic in	XLR 3-pin female		<i>Pin 2 hot</i>
	Insert send out	25-pin D-type male		
	Audio I/O	Duplex LC fibre optic		
	Network	RJ45		

- (1) Ventilation is convection via vents at top and bottom of front panel. Do not obstruct vents – refer to Appendix F for additional information.

# Appendix B: Connector Details

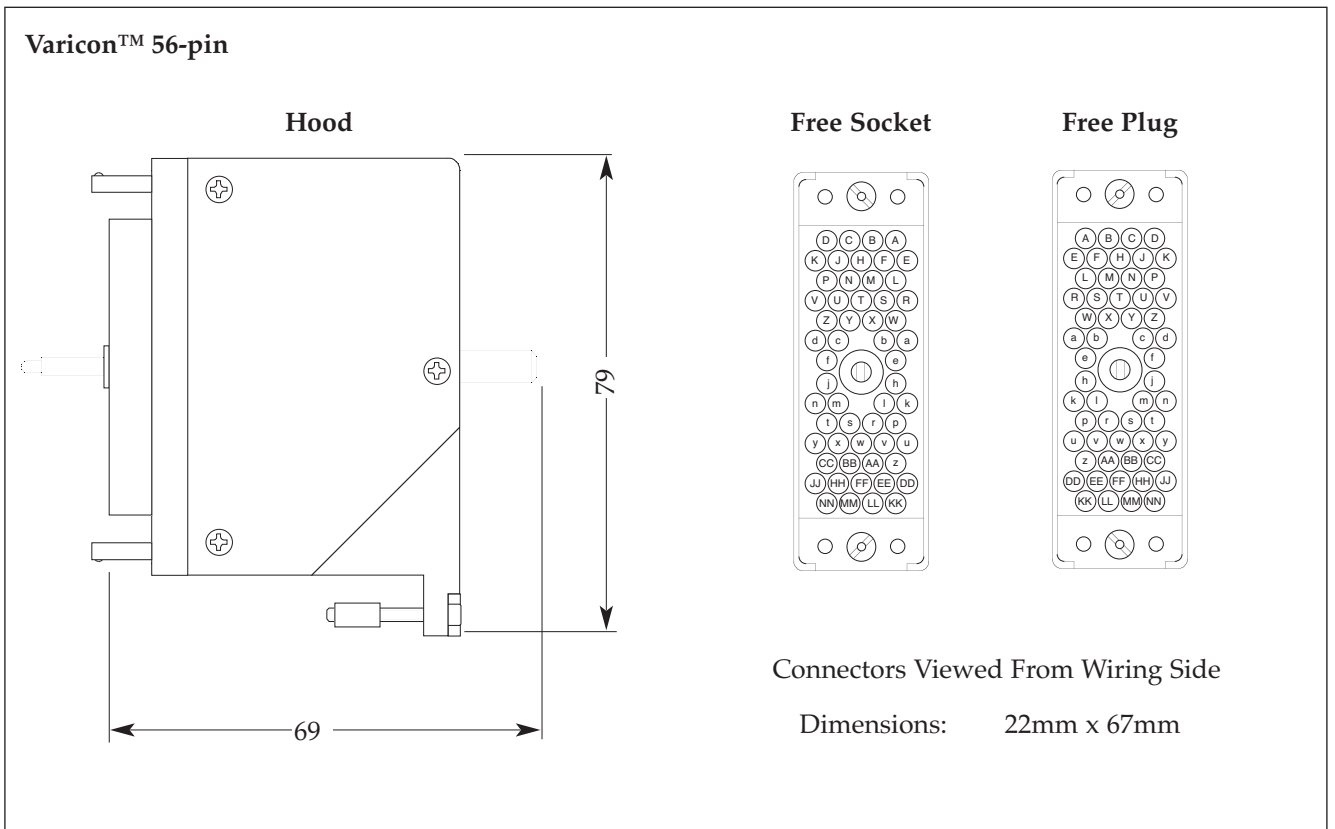
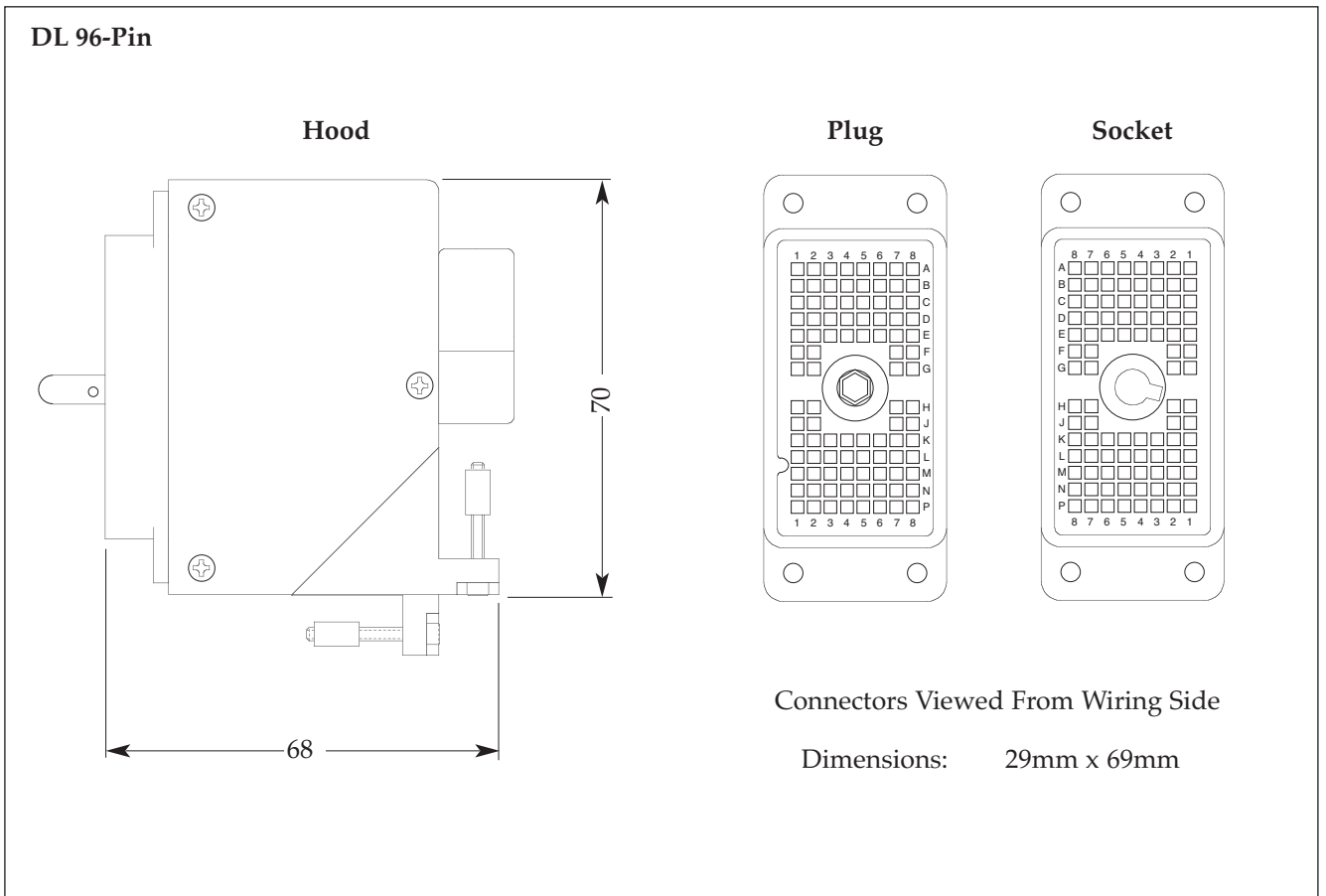

**XLR 3-Pin**

Dimensions: 19 x 60mm (approx.)  
 Cable Dia: 8-12mm (typical)

Pinout as used for balanced audio:

Pin 1 Screen/Ground  
 Pin 2 Hot (+ve)  
 Pin 3 Cold (-ve)

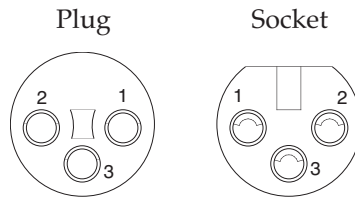

Connectors Viewed From Wiring Side

**DIN 5-Pin 180°**

Dimensions: 15mm dia.  
 Cable Dia: 4mm - 7mm (typical)

Typically used for MIDI interconnection

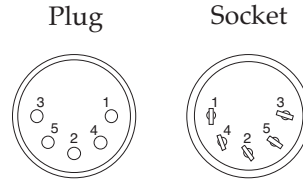

Connectors Viewed From Wiring Side

**D-Type Multipin**

Connectors Viewed From Wiring Side

**25-way**

Dimensions: 55 x 15mm (approx.)  
 Cable Dia: 8mm (typical)

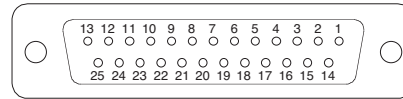

Plug

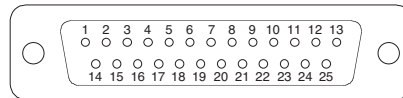

Socket

**9-way**

Dimensions: 35 x 15mm (approx.)  
 Cable Dia: 7mm (typical)

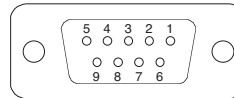

Plug

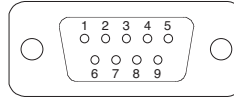

Socket

**HD 15-way**

Dimensions: 35 x 15mm (approx.)  
 Cable Dia: 12mm

RGBHV (XGA) connector

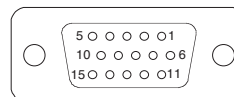

Plug

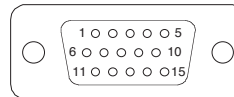

Socket

**Harting Mains Insert**

Pin 1 LIVE  
 Pin 2 n/c  
 Pin 3 NEUTRAL  
 Earth contact is via Earth pin in the housing frame

Note: The inserts utilise crimped pins which are not removable.

Part 3-way socket housing 40A Contact  
 SSL Part Number 32VAK3DC 32VAQXEX

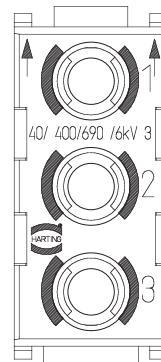

Socket Viewed from wiring side



## Appendix C: Connector Pinouts – C100 Console

<b>'Meter Inputs' (Analogue)</b>				
Location:		'Audio' interface Panel		
Connector Type:		25-way D-type male		
<i>Pin</i>	<i>Description</i>	<i>Notes VU/PPM only</i>	<i>Notes RTW 10830</i>	
1	Meter 1 Input +	<i>Left Meter input</i>	<i>Analogue input 1 and Meter Left</i>	
14	Meter 1 Input -			
2	n/c	<i>Unused</i>	<i>Analogue input 2 and Meter Right</i>	
15	Meter 2 Input +			
3	Meter 2 Input -	<i>Right Meter input</i>	<i>Analogue input 3</i>	
16	n/c			
4	Meter 3 Input +	<i>Unused</i>	<i>Analogue input 4</i>	
17	Meter 3 Input -			
5	n/c	<i>Unused</i>	<i>Analogue input 5</i>	
18	Meter 4 Input +			
6	Meter 4 Input -	<i>Unused</i>	<i>Analogue input 6</i>	
19	n/c			
7	Meter 5 Input +	<i>Unused</i>	<i>Analogue input 7</i>	
20	Meter 5 Input -			
8	n/c	<i>Unused</i>	<i>Analogue input 8</i>	
21	Meter 6 Input +			
9	Meter 6 Input -	<i>Unused</i>		
22	n/c			
10	Meter 7 Input +	<i>Unused</i>		
23	Meter 7 Input -			
11	n/c	<i>Unused</i>		
24	Meter 8 Input +			
12	Meter 8 Input -	<i>Unused</i>		
25	n/c			
13	n/c			

Note. If both the RTW phasescope and mechanical meters are fitted refer to the RTW circuit allocations.

<b>'Phase Scope' (Digital)</b>			
Location:		'Audio' Console Belly Panel	
Connector Type:		25-way D-type female	
<i>Pin</i>	<i>Description</i>	<i>Notes – MSD600C</i>	<i>Notes – RTW10830</i>
1	Circuit 1 +	<i>AES/EBU In 1/2</i>	<i>AES/EBU Out 7/8</i>
14	Circuit 1 -		
2	Gnd		
15	Circuit 2 +	<i>AES/EBU In 3/4</i>	<i>AES/EBU Out 5/6</i>
3	Circuit 2 -		
16	Gnd		
4	Circuit 3 +	<i>AES/EBU In 5/6</i>	<i>AES/EBU Out 3/4</i>
17	Circuit 3 -		
5	Gnd		
18	Circuit 4 +	<i>n/c</i>	<i>AES/EBU Out 1/2</i>
6	Circuit 4 -		
19	Gnd		
7	Circuit 5 +	<i>n/c</i>	<i>AES/EBU In 7/8</i>
20	Circuit 5 -		
8	Gnd		
21	Circuit 6 +	<i>n/c</i>	<i>AES/EBU In 5/6</i>
9	Circuit 6 -		
22	Gnd		
10	Circuit 7 +	<i>n/c</i>	<i>AES/EBU In 3/4</i>
23	Circuit 7 -		
11	Gnd		
24	Circuit 8 +	<i>n/c</i>	<i>AES/EBU In 1/2</i>
12	Circuit 8 -		
25	Gnd		
13	n/c		

<b>'MSD Diag' (Diagnostics / Remote Control)</b>		
Location:		'Audio' Console Belly Panel
Connector Type:		9-way D-type female
<i>Pin</i>	<i>Description – MSD600C</i>	<i>Description – RTW10830</i>
1	Chassis	Switch Common
6	n/c	Mode
2	Rx Data	Select
7	n/c	Memo
3	Tx Data	Gain
8	n/c	Reset
4	n/c	Shift
9	n/c	n/c
5	n/c	n/c

## Connector Pinouts – Centuri Processor

<b>'Video 1, 2 and 3'</b>		
Location:		Centuri - CPU Card
Connector Type:		HD15 D-type Female
<i>Pin</i>	<i>Description</i>	<i>Notes</i>
1	Red Signal	
2	Green Signal	
3	Blue Signal	
4	ID Bit	
5	Unused	
6	Red Screen	
7	Green Screen	
8	Blue Screen	
9	n/c	
10	Ground	
11	ID Bit	
12	ID Bit	
13	Horizontal Sync	
14	Vertical Sync	
15	Unused	

<b>'Machine Control'</b>	
Location:	Centuri – Interface Card
Connector Type:	25-pin D-type Male
<i>Not implemented on C100</i>	

<b>'Timecode'</b>	
Location:	Centuri – Interface Card
Connector Type:	25-pin D-type Female
<i>Not implemented on C100</i>	

<b>'Expansion'</b>	
Location:	Centuri – Lower rear panel
Connector Type:	25-pin D-type Male
<i>Not implemented on C100</i>	

<b>'MIDI'</b>	
Location:	Centuri – Lower rear panel
Connector Type:	5-pin 180° Din Female
<i>Not implemented on C100</i>	

<b>'Serial'</b>									
Location:		Centuri – CPU							
Connector Type:		62-pin High-density D-type female							
D9 pin no.	Description	TTY-A	TTY-B	TTY-C	TTY-D	TTY-E	TTY-F	TTY-G	TTY-H
1	0V	7	28	14	52	21	42	35	59
6	0V	5	26	12	50	19	40	33	57
2	Rx Data L	2	23	9	47	16	37	30	54
7	Rx Data H	3	24	10	48	17	38	31	55
3	Tx Data H	1	22	8	46	15	36	29	53
8	Tx Data L	4	25	11	49	18	39	32	56
4	0V	6	27	13	51	20	41	34	58
9	n/c	-	-	-	-	-	-	-	-
5	0V	43	45	44	44	62	61	60	61

<b>'TTYA' – 'TTYD', 'TTYF' – 'TTYH' (RS422)</b>		
Location:		Centuri – CPU Card (using 62-pin adaptor breakout lead)
Connector Type:		9-pin D-type Male
Pin	Description	Notes
1	0V	<i>Connector case connected to chassis</i>
6	0V	
2	Rx Data L	
7	Rx Data H	
3	Tx Data H	
8	Tx Data L	
4	0V	
9	n/c	
5	0V	

<b>'TTYE' (RS232)</b>		
Location:		Centuri – CPU Card (using 62-pin adaptor breakout lead)
Connector Type:		9-pin D-type Male
Pin	Description	Notes
1	0V	<i>Connector case connected to chassis</i>
6	0V	
2	Tx Data	
7	0V	
3	Rx Data	
8	n/c	
4	n/c	
9	n/c	
5	0V	

## Mic Input Card ('908)

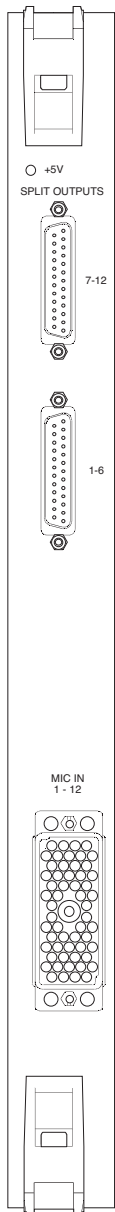

<b>Mic IN 1 - 12</b>				
Location:		908 Micamp		
Connector Type:		Varicon 56 way female		
cct.	hot	cold	screen	Notes
1	D	K	P	<i>All other pins n/c</i>
2	C	J	N	
3	A	E	L	
4	B	F	M	
5	V	Z	d	
6	U	Y	c	
7	R	W	a	
8	S	X	b	
9	n	t	y	
10	m	s	x	
11	k	p	u	
12	l	r	v	

<b>Split Outputs 1 - 6</b>				
Location:		908 Micamp		
Connector Type:		25-way D-type female		
cct.	hot	cold	screen	Notes
1	24	12	25	<i>All other pins n/c</i>
2	10	23	11	
3	21	9	22	
4	7	20	8	
5	18	6	19	
6	4	17	5	

<b>Split Outputs 7 - 12</b>				
Location:		908 Micamp		
Connector Type:		25-way D-type female		
cct.	hot	cold	screen	Notes
7	24	12	25	<i>All other pins n/c</i>
8	10	23	11	
9	21	9	22	
10	7	20	8	
11	18	6	19	
12	4	17	5	

## Analogue I/O Card ('904)



Analogue IN / Analogue OUT				
Location:		904 Analogue I/O		
Connector Type:		DL96 Female		
cct.	hot	cold	screen	Notes
1	A1	B1	C1	<i>All other pins n/c</i>
2	A2	B2	C2	
3	A3	B3	C3	
4	A4	B4	C4	
5	A5	B5	C5	
6	A6	B6	C6	
7	A7	B7	C7	
8	A8	B8	C8	
9	D1	E1	F1	
10	D2	E2	F2	
11	D3	E3	G1	
12	D4	E4	G2	
13	D5	E5	G7	
14	D6	E6	G8	
15	D7	E7	F7	
16	D8	E8	F8	
17	L1	K1	J1	
18	L2	K2	J2	
19	L3	K3	H1	
20	L4	K4	H2	
21	L5	K5	H7	
22	L6	K6	H8	
23	L7	K7	J7	
24	L8	K8	J8	

## Digital I/O Card ('902)



AES/EBU In 1-8 (9-16, 17-24, 25-32)				
Location:		902 DIO		
Connector Type:		25-way D-type female		
Cct	Hot	Cold	Screen	Notes
1	24	12	25	<i>Pin 13 unused</i>
2	10	23	11	
3	21	9	22	
4	7	20	8	
5	18	6	19	
6	4	17	5	
7	15	3	16	
8	1	14	2	

AES/EBU Out 1-8 (9-16, 17-24, 25-32)				
Location:		902 DIO		
Connector Type:		25-way D-type female		
Cct	Hot	Cold	Screen	Notes
1	24	12	25	<i>Pin 13 unused</i>
2	10	23	11	
3	21	9	22	
4	7	20	8	
5	18	6	19	
6	4	17	5	
7	15	3	16	
8	1	14	2	

## BNC Breakout Panel

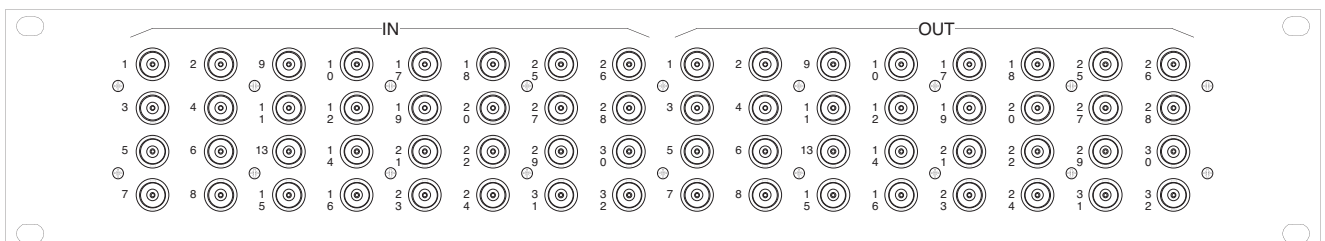

### GPI I/O Card ('907)

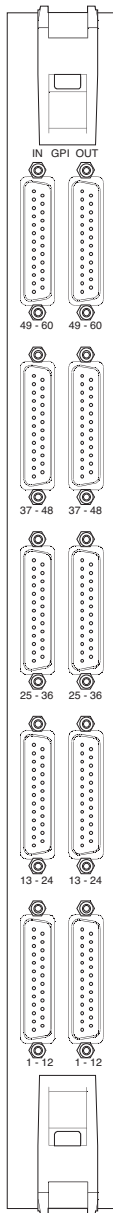

GPI Inputs 1 - 12 (13 - 24, 25 - 36, 37 - 48, 49 - 60)		
Location:		907 Relay card
Connector Type:		25-way D-type Male
Pin	Description	Notes
1	Input 1 A	
14	Input 1 B	
2	Input 2 A	
15	Input 2 B	
3	Input 3 A	
16	Input 3 B	
4	Input 4 A	
17	Input 4 B	
5	Input 5 A	
18	Input 5 B	
6	Input 6 A	
19	Input 6 B	
7	Input 7 A	
20	Input 7 B	
8	Input 8 A	
21	Input 8 B	
9	Input 9 A	
22	Input 9 B	
10	Input 10 A	
23	Input 10 B	
11	Input 11 A	
24	Input 11 B	
12	Input 12 A	
25	Input 12 B	
13	0V	

GPI Outputs 1 - 12 (13 - 24, 25 - 36, 37 - 48, 49 - 60)		
Location:		907 Relay card
Connector Type:		25-way D-type Female
Pin	Description	Notes
1	Output 1 A	
14	Output 1 B	
2	Output 2 A	
15	Output 2 B	
3	Output 3 A	
16	Output 3 B	
4	Output 4 A	
17	Output 4 B	
5	Output 5 A	
18	Output 5 B	
6	Output 6 A	
19	Output 6 B	
7	Output 7 A	
20	Output 7 B	
8	Output 8 A	
21	Output 8 B	
9	Output 9 A	
22	Output 9 B	
10	Output 10 A	
23	Output 10 B	
11	Output 11 A	
24	Output 11 B	
12	Output 12 A	
25	Output 12 B	
13	+15VDC	450mA total across all output connectors



## Connector Pinouts – NetBridge

<b>Serial 1–8 (RS232)</b>		
Location:		Netbridge rear panel
Connector type:		9-pin D-type male
<i>pin</i>	<i>Description</i>	<i>Notes</i>
1	Chassis	
6	n/c	
2	Rx Data	
7	n/c	
3	Tx Data	
8	n/c	
4	n/c	
9	n/c	
5	Signal ground	

<b>Terminal</b>		
Location:		Netbridge rear panel
Connector type:		9-pin D-type male
<i>pin</i>	<i>Description</i>	<i>Notes</i>
1	DCD	Data Carrier Detect
6	DSR	Data Set Ready
2	Rx Data	
7	RTS	Request to Send
3	Tx Data	
8	CTS	Clear to Send
4	DTR	Data Terminal Ready
9	RI	Ring Indicator
5	Signal ground	

## NetBridge Diagnostic Cable

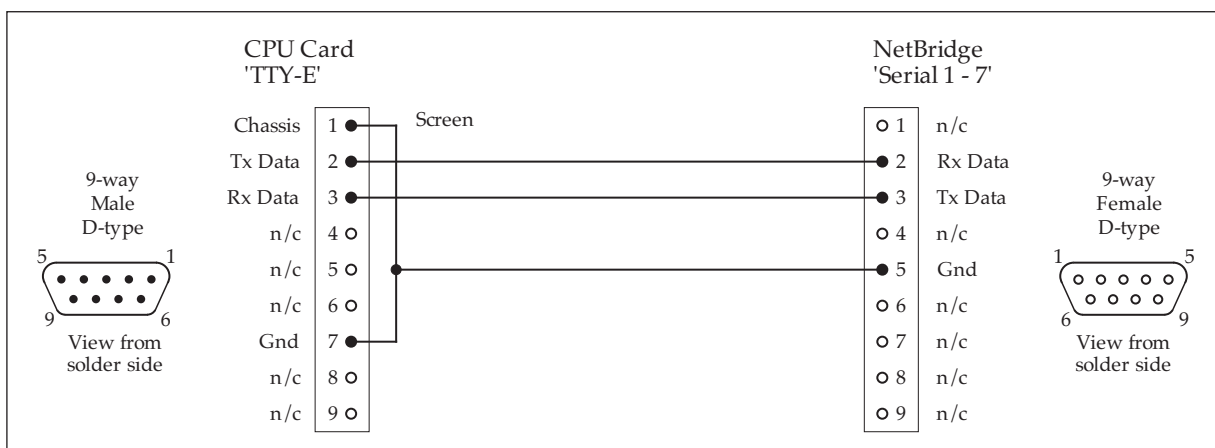

*Resistor Colour Code:*

<i>Black</i>	<i>0</i>
<i>Brown</i>	<i>1</i>
<i>Red</i>	<i>2</i>
<i>Orange</i>	<i>3</i>
<i>Yellow</i>	<i>4</i>
<i>Green</i>	<i>5</i>
<i>Blue</i>	<i>6</i>
<i>Violet</i>	<i>7</i>
<i>Grey</i>	<i>8</i>
<i>White</i>	<i>9</i>

## Appendix D: Audio Interfacing

All analogue audio inputs and outputs are electronically balanced. The screen pins are all directly connected to the chassis at the point of entry to comply with AES/EBU grounding and EMC recommendations.

### Balanced Circuits

It is strongly recommended that balanced connections are used wherever possible using high quality screened cable. The following diagram shows the recommended connection with both screens connected to the chassis:

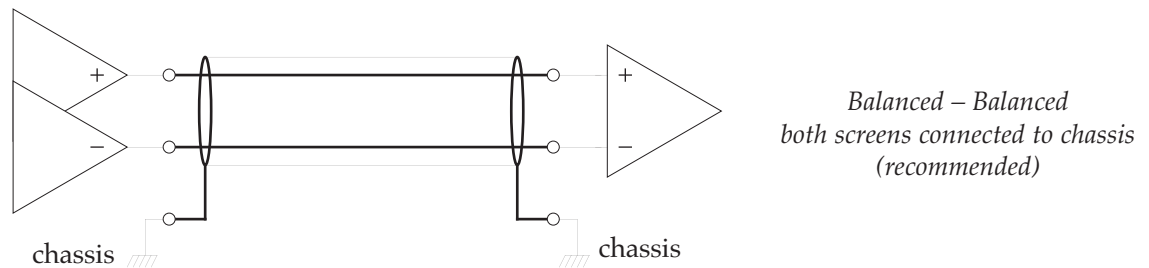

On some older items of equipment the screen connection may still be referenced to the circuit 0V rather than the chassis. In these cases it may be advantageous to disconnect the screen at this connection. Note however that this practice will degrade the EMC performance.

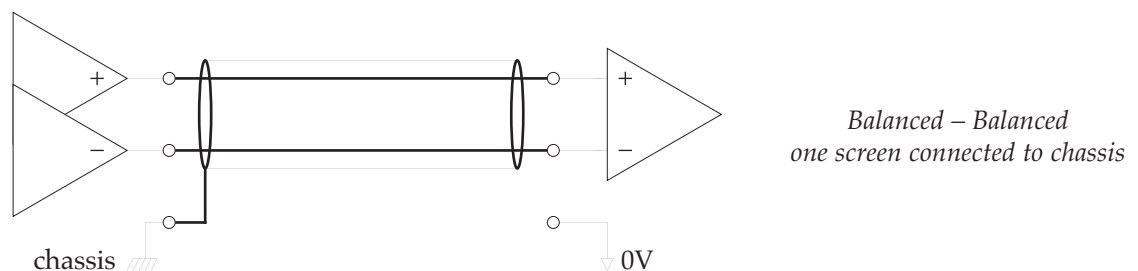

### Connecting to Unbalanced Equipment

Connecting to unbalanced equipment can be much more problematic. It is much more likely that earth and induced RF currents will become referenced to the audio 0V which will give rise to audible hum and buzz.

The recommendation for connection of balanced to unbalanced equipment is to isolate unbalanced connections by using a balancing transformer.

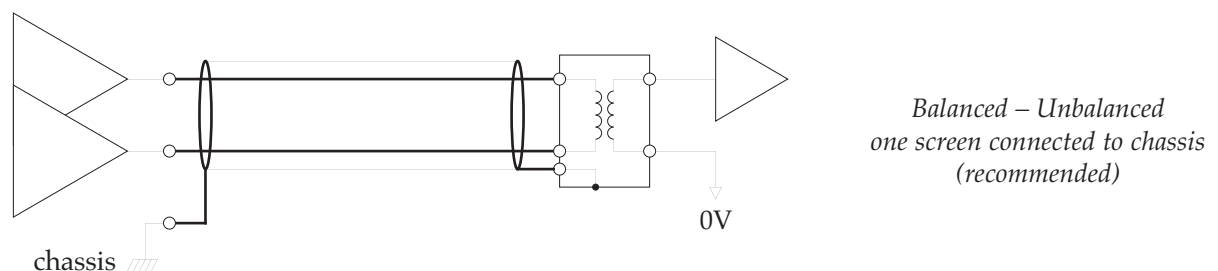

*1 inch = 25.4mm (exactly)*

*1m = 3' 3" (roughly)*

*1 mile = 1,600m (roughly)*

*1Kg = 2.2 Pounds (roughly)*

## Appendix E: Environmental Specification

<b>Temperature</b>	Operating:	5 to 30 Deg. C
	Non-operating:	-20 to 50 Deg. C
	Max. Gradient:	15 Deg. C/Hour
<b>Relative Humidity</b>	Operating:	20 to 80 %
	Non-operating:	5 to 90 %
	Max. wet bulb:	29 Deg. C ( <i>non-condensing</i> )
<b>Vibration</b>	Operating:	< 0.2 G (3 - 100Hz.)
	Non-operating, power off:	< 0.4 G (3 - 100Hz.)
<b>Shock</b>	Operating:	< 2 G (10mSec. Max.)
	Non-operating:	< 10 G (10mSec. Max.)
<b>Altitude</b> ( <i>above sea level</i> )	Operating:	0 to 3000 m
	Non-operating:	0 to 12000 m

*+4dBu = 1.229V rms.*

*0dBu = 0.775V rms.*

*-6dBu = 0.388V rms.*

## Appendix F: Additional Information for Installing Stageboxes

When positioning and installing C-SB the following rules must be followed:

- Unobstructed airflow at front and rear.
- No obstruction to airflow, horizontal or vertical, within 300mm in front, above and below both the front and rear panels.
- Ambient temperature no more than 30°C measured at the air intake (lower front opening) or just below the rear heatsink.
- Microphone cables must not obstruct the air intake. To help ensure this, a cable guide is provided down the sides of the rack.

### Design Requirements for a Flightcase

If a Stagebox is to be installed into a flight case the following requirements, in addition to those above, must be met to ensure adequate passive cooling – otherwise user must install a 'forced-ventilation kit'.

- Both front and rear covers must be completely removed during operation.
- The front and rear covers must be deep enough to ensure that the front and rear faces of Stagebox are flush with front and rear of the open flight case.

*This page is blank intentionally.*



## Appendix G: Cables and accessories

### Cables and Accessories - by Part Description

Description	SSL Part No.
<b>Audio Cables and Accessories</b>	
DL Connector Crimp Contacts .32MM LOOSE	32QFXXQ1
DL Connector Free Hood 96-way	32QF96FH
DL Connector Free Plug 96-way	32QF96KC
DL Connector Handle	32QFXXKM
DL Connector 96W Chassis Socket	32QF96GC
DL Connector Crimp Contact Removal Tool	80CLAGDC
DL Connector Crimp Tool	80CLAG1C
Lead DL - DL 24cct 10m	92DL1024
Lead DL - DL 24cct 15m	92DL1524
Lead DL - DL 24cct 20m	92DL2024
Lead DL - DL 24cct 25m	92DL2524
Lead DL - DL 32cct 10m	92DL1032
Lead DL - DL 32cct 15m	92DL1532
Lead DL - DL 32cct 20m	92DL2032
Lead DL - DL 32cct 25m	92DL2532
<b>Processor &amp; Machine cables</b>	
25-way D-type to 9-way D-type RS232 10m	66C60002
RJ45 to 25-way D-type RS232 10m	66C67206
9-way D-type to 9-way D-type RS422 10m	66C60007
<b>Network Cables</b>	
Ethernet: RJ45 to RJ45 10baseT 0.5m (pin-pin)	66C67207
Ethernet: RJ45 to RJ45 10baseT 1m (pin-pin)	66C67210
Ethernet: RJ45 to RJ45 10baseT 2m (pin-pin)	66C67220
Ethernet: RJ45 to RJ45 10baseT 5m (pin-pin)	66C67250
Ethernet: RJ45 to RJ45 10baseT 10m (pin-pin)	66C67310
Ethernet: RJ45 to RJ45 10baseT 16m (pin-pin)	66C67316
Ethernet: RJ45 to RJ45 10baseT 20m (pin-pin)	66C67320
Ethernet: RJ45 to RJ45 10baseT 25m (pin-pin)	66C67325

Description	SSL Part No.
<b>Video &amp; Sync</b>	
Lead Video HD15 XGA 16m	66DN16V1
Lead Video HD15 XGA 20m	66DN20V1
Lead Video HD15 XGA 25m	66DN25V1
Lead Video HD15 XGA 48m	66DN48V1
BNC 75 'Y' piece	32TKU7CC
BNC 75 Terminator	32TKB7TC
<b>Miscellaneous/Hardware</b>	
39U Equipment Rack	57GQ4QA8
25-way D-type Male-to-Female Cable 15m	66C90014
IEC Mains Lead	32VGL362
IEC Mains Lead (US)	32VGL3AN

## **Notes**

## More Notes

## Free Manuals Download Website

<http://myh66.com>

<http://usermanuals.us>

<http://www.somanuals.com>

<http://www.4manuals.cc>

<http://www.manual-lib.com>

<http://www.404manual.com>

<http://www.luxmanual.com>

<http://aubethermostatmanual.com>

Golf course search by state

<http://golfingnear.com>

Email search by domain

<http://emailbydomain.com>

Auto manuals search

<http://auto.somanuals.com>

TV manuals search

<http://tv.somanuals.com>