



SONANCE[®]

SONAMP[®] ASAP3D SE
STEREO POWER AMPLIFIER

INSTRUCTION MANUAL



Important Safety Instructions

Basic safety precautions should always be followed when using your ASAP3D SE amplifier, to reduce risk of fire, electric shock, and injury to persons:

1. **Read** and understand all instructions.
2. **Retain** these instructions for future reference.
3. **Follow** all warnings and instructions in this manual and marked on the product.
4. Any service or repair required must be performed by qualified factory-authorized personnel.
5. Do not use the amplifier in a high-humidity environment or near water — for example in a wet basement, or near a wet bar or swimming pool.
6. Always provide adequate ventilation for the amplifier. Allow a minimum of two (2) inches on all sides of the amplifier. Do not block the cooling vents on the amplifier case.
7. The amplifier should be situated away from heat sources such as heat registers, radiators, stoves, or other appliances that produce heat.
8. The amplifier should only be connected to a power supply of the type marked on its back panel. The power supply cord should be routed to avoid damage from contact with sharp objects or being stepped on.
9. Unplug the amplifier during thunderstorms or when it will be unused for extended periods of time.
10. Exercise care to avoid spilling liquids on or in the amplifier.
11. Do not place the amplifier on an unstable table, stand, or cart. Improper placement of the amplifier may cause it to fall on an adult or child causing serious injury, as well as damage to the amplifier.



12. Do not expose the amplifier to dripping or splashing. Do not place objects filled with liquids, such as vases, on the amplifier.
13. **Cleaning:** To clean the amplifier, wipe it with a soft cloth. Do not use solvents, as they may damage the amplifier.
14. **Non-Use Periods:** Unplug the amplifier's power cord from the electrical outlet when the amplifier will be unused for a long period of time.
15. **Damage Requiring Service:** The amplifier should be serviced by qualified service personnel when:
 - A. The power cord or plug has been damaged
 - B. Objects have fallen, or liquids have been spilled into the amplifier

- C. The amplifier has been exposed to rain.
 - D. The amplifier does not appear to be operating properly or exhibits a marked change in performance.
 - E. The amplifier has been dropped or appears to have been damaged.
16. **Servicing:** The user should not attempt to service the amplifier beyond that described in these instructions. All other servicing should be referred to qualified service personnel.
 17. **Storms:** To prevent damage to components, unplug all electronic equipment during thunderstorms.



WARNING: TO PREVENT FIRE OR SHOCK HAZARD, DO NOT EXPOSE THIS APPLIANCE TO RAIN OR MOISTURE. THE APPLIANCE SHALL NOT BE EXPOSED TO DRIPPING OR SPLASHING. NO OBJECTS FILLED WITH LIQUIDS SHALL BE PLACED ON THE APPLIANCE.

CAUTION: TO REDUCE THE RISK OF ELECTRIC SHOCK, DO NOT REMOVE COVER OR BACK. NO USER-SERVICEABLE PARTS INSIDE. REFER SERVICING TO AUTHORIZED SERVICE PERSONNEL.

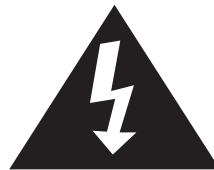

The lightning flash with arrowhead symbol, within an equilateral triangle, is intended to alert the user to the presence of uninsulated dangerous voltage within the product's enclosure that may be of sufficient magnitude to constitute a risk of electric shock to persons.



The exclamation point within an equilateral triangle is intended to alert the user to the presence of important operating and maintenance (servicing) instructions in the literature accompanying the appliance.



Introduction

Thank you for purchasing the Sonance ASAP3D SE amplifier. When properly installed, this amplifier will give you many years of entertainment pleasure. To get the most out of your new amplifier, please read this manual thoroughly before you begin installation.

To achieve the best performance, Sonance recommends that this amplifier be installed by a Sonance Authorized Dealer/Installer.

Design and Features



Automatic House/Local Source Switching

The ASAP3D SE will automatically switch a pair of speakers between two different input sources. Typically, the *House* source will be a whole-home audio system that normally plays in the area, and the *Local* source will be a nearby source, such as a TV set. The ASAP3D SE can be set up so that any one of several different triggers will cause it to automatically switch from the House source to the Local source.

A typical application would be to use the ASAP3D SE to power and automatically switch a pair of speakers in a bedroom from playing background music sent by a whole-home audio system to playing the sound of the bedroom TV whenever the TV is switched ON. With the amplifier's Mono Variable Output feeding a local-zone powered subwoofer, this installation would provide much better sound quality than the TV could supply on its own.

Flexible Triggering

Switching from the House to the Local source can be triggered in four different ways:

- By the presence of an audio signal at the LOCAL LINE inputs or LOCAL SPEAKER inputs;
- When a TV set that is connected to the ASAP3D SE's AC Outlet is turned ON;
- By an external control voltage connected to the VOLTAGE TRIGGER input;
- By an IR controller connected to the IR Input.

IR Control

The ASAP3D SE has IR Input connections that allow its automatic input switching, volume, muting and BBE to be controlled by an IR keypad controller. IR Output connections allow the connection of Sonance OptiLinQ® IR emitters so that 3rd-party control signals can be passed-through to their intended components, and an IR Bus connection allows IR signals from multiple ASAP3D SEs to be passed-through to a single set of IR emitters.

BBE® Sound Enhancement

The ASAP3D SE incorporates BBE® Sound Enhancement. The BBE process improves the presence and detail of speakers, especially at lower listening volumes, so distributed audio systems playing background music sound better at quiet volume levels. BBE also restores clarity and definition (or focus) to spoken voices, making paging systems easier to understand without having to run them at high volumes.

The ASAP3D SE has controls that let you set the BBE enhancement to HI, LOW or OFF.

Digital Amplification

The ASAP3D SE utilizes a highly-efficient ICEpower® digital amplifier that provides 50 watts RMS per channel in stereo. The ICEpower's high efficiency produces high power in a 1U high/½ rack width package, with very little heat generation. This expands installation options, improves long-term reliability and provides significant energy savings over conventional amplifier designs.

Box Contents

Your ASAP3D SE amplifier box should contain the following:

- (1) ASAP3D SE Power amplifier
- (1) Joining Plate
- (4) Rack-mount screws and (4) nylon washers
- (1) IEC Power cord (120V version only)
- (1) AC Trigger Outlet cable (120V version only)
- (4) Stick-on rubber feet

Unpacking

Save the shipping carton and polystyrene inserts so you can safely transport your amplifier in the future. Before you install the amplifier, locate the serial number on its rear panel and note it here for future reference:

S/N: _____



Placement/Installation

The Sonamp ASAP3D SE is designed to operate automatically and is housed in a compact chassis that can be conveniently mounted out of sight. The amplifier can be placed horizontally on the supplied rubber feet, or it can be hung on a wall — hidden behind a wall-mounted flat-panel TV — using the keyhole-shaped hole on its bottom panel.

The ASAP3D SE includes a joining plate that allows it to be rack-mounted in a single 1U space side-by-side with another ASAP3D SE. An optional Rack-Mount Filler Panel is available (Sonance part #92729) that allows a single ASAP3D SE to be mounted in a 1U rack space.

Stand-Alone Placement

IMPORTANT: TO AVOID DAMAGE, THE AMPLIFIER MUST ALWAYS REST ON ITS FOUR FEET TO ALLOW SUFFICIENT CLEARANCE FOR PROPER VENTILATION.

Apply the four supplied stick-on feet to the amplifier's bottom panel and place the ASAP3D SE on a level surface, in an upright position, out of direct sunlight and away from windows through which rain may enter.

Situate the amplifier away from heat sources such as hot air ducts or radiators. Be sure that the amplifier is adequately ventilated by convection cooling or suitable cabinet fans.

When using the ASAP3D SE with a TV set, it may be convenient to hide the amplifier inside of the TV cabinet or bookshelf (but not on the TV itself).

IMPORTANT: THE ASAP3D SE REQUIRES TWO INCHES OF CLEARANCE ON THE TOP AND ALL SIDES.

- Never place any object on or against the amplifier
- Never operate the amplifier on a carpeted surface, as this will compromise ventilation.

Rack-Mounting

Two ASAP3D SE amplifiers can be rack-mounted side-by-side using the included joining plate.

- If they've already been installed, remove the amplifier's stick-on feet before using the included rack-mount accessories.
- Use nylon washers on rack-mount screws to isolate the amplifiers from the rack rails (see *Figure 1*). This will help prevent ground loops and hum problems.
- Very sensitive low-level components might pick up some hum radiated from the ASAP3D SE's power supply. If this occurs, move the amplifier to another rack position, away from the other components.

To rack-mount the ASAP3D SE (see *Figure 1*):

1. Place the amplifier with its front panel touching the other amplifier or rack-mount filler panel.
2. Slip the Joining Plate behind the rack holes and attach it using 4 rack screws.
3. Attach the assembled unit to the rack using 4 more rack screws. Use nylon washers on the rack screws in front of and behind the face plates to isolate them from the rack rails, to help prevent ground loops and hum.

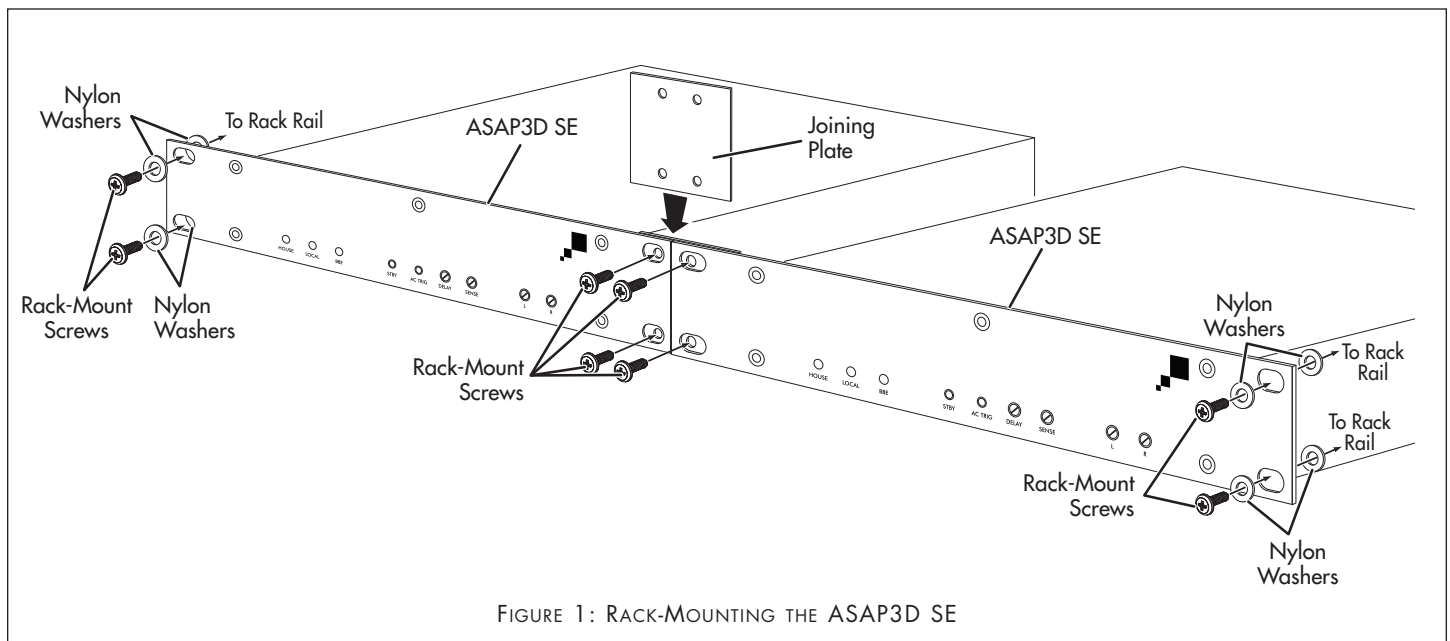

FIGURE 1: RACK-MOUNTING THE ASAP3D SE

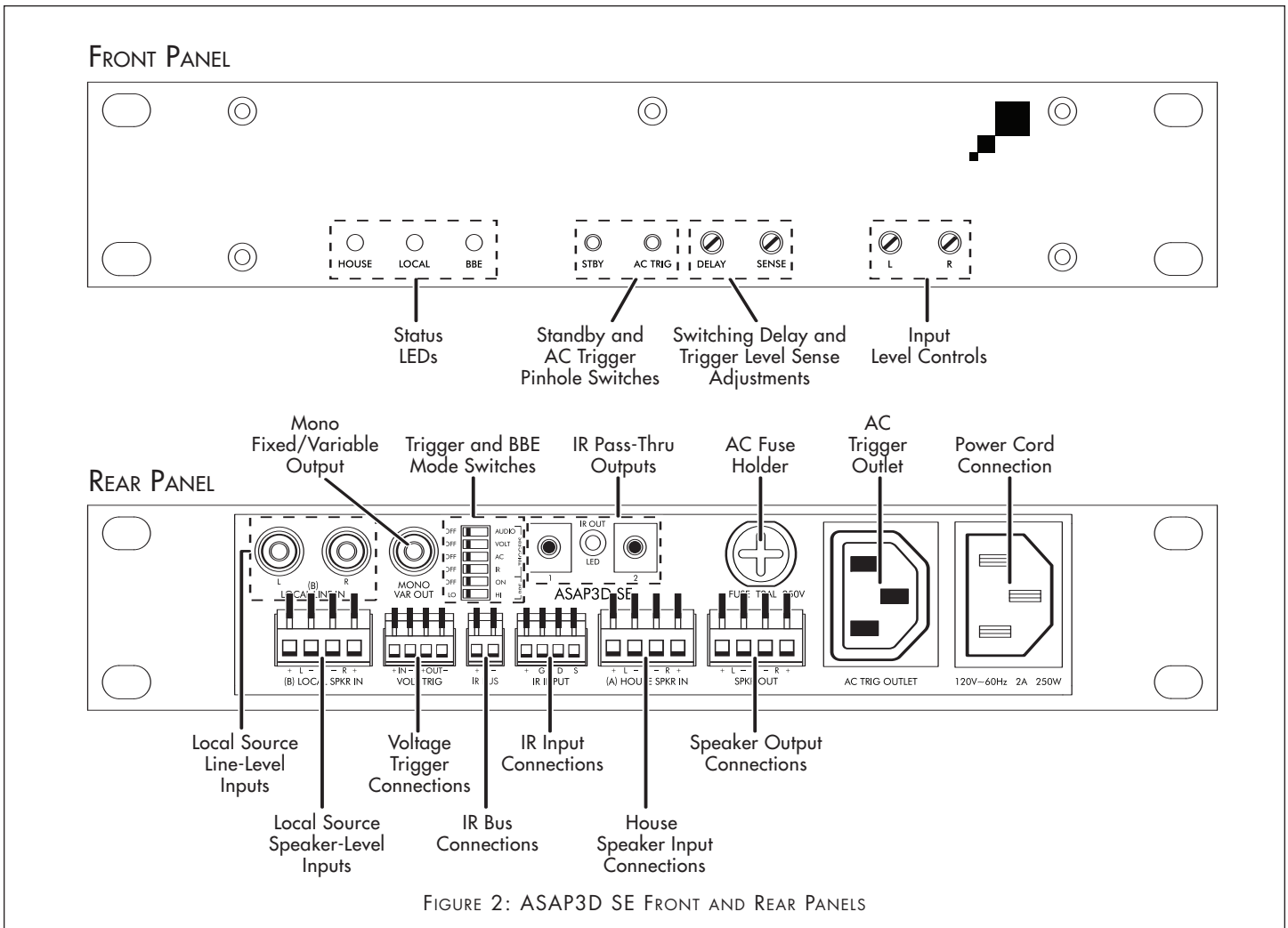

FIGURE 2: ASAP3D SE FRONT AND REAR PANELS

Powering the Amplifier

Power Cord Connection

The ASAP3D SE features an IEC power connector (see Figure 3). Plug the female end of the power cord into the Power Cord Connector on the amplifier's rear panel and plug the male end into a grounded wall socket. Do NOT plug the amplifier's power cord into a convenience outlet on any other audio or video component. (Note: A power cord is included only with the 120V version of the amplifier.)

IMPORTANT: Do NOT plug the power cord into the wall outlet until all system connections have been made and verified.

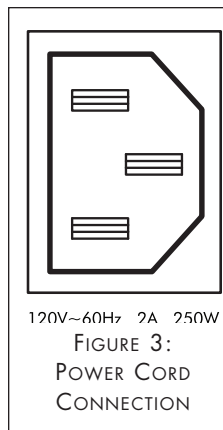

NOTE: IF YOU NEED TO USE AN EXTENSION CORD, USE ONLY A HEAVY-DUTY (16-GAUGE OR LARGER) EXTENSION CORD TO AVOID STARVING THE AMPLIFIER OF ALL THE CURRENT NECESSARY FOR FULL-POWER OPERATION.

A.C. Fuse Holder

120V versions of the Sonamp ASAP3D SE are shipped with a 2 amp AC fuse installed. 230V versions have a 1.25 amp AC fuse installed. The fuse protects the amplifier circuitry; THE AC TRIGGER OUTLET IS NOT PROTECTED BY THE FUSE.

To replace the fuse, unplug the power cord from the Power Cord Connector and use a screwdriver to remove the fuse holder (see Figure 4).

CAUTION: FOR CONTINUED PROTECTION AGAINST FIRE, REPLACE THE FUSE WITH ONLY THE SAME TYPE AND RATING.

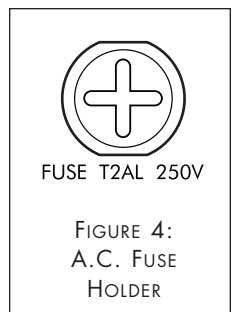



Audio Input Connections

IMPORTANT: ALWAYS UNPLUG THE AMPLIFIER'S POWER CORD FROM THE WALL OUTLET BEFORE MAKING AUDIO, CONTROL OR SPEAKER CONNECTIONS.

HOUSE SPEAKER IN Connector

The component connected to the HOUSE SPEAKER IN connector (see *Figure 5*) is the amplifier's default input signal that is passed (unamplified) to the speakers when no control trigger stimulus is applied. Typically, this is the room's speaker output from a whole-house audio system.

The HOUSE SPEAKER IN connector uses a removable 4-wire quick connector that accepts bare wire up to 14AWG. To wire the connector see the sidebar in the next column.

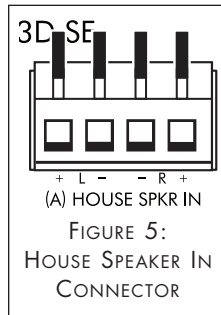

LOCAL LINE IN Jacks

If the local source component has a set of Line Output jacks, use a stereo RCA cable to connect them to the ASAP3D SE's LOCAL LINE IN jacks (see *Figure 6*).

The signal at the Local Line In jacks will be amplified and sent to the ASAP3D SE's SPEAKER OUTPUT connector whenever the amplifier's automatic switching is triggered (see *Control Inputs/Outputs*, on page 7).

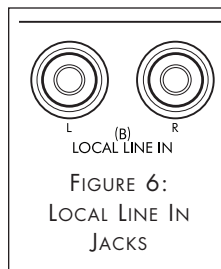

LOCAL SPEAKER IN Connector

If the local source component does not have a set of Line Output jacks, use speaker wire to connect its Speaker Outputs to the ASAP3D SE's LOCAL SPEAKER IN connector (see *Figure 7*).

The signal at the LOCAL SPEAKER IN connector will be amplified and sent to the ASAP3D SE's SPEAKER OUTPUT connector whenever the amplifier's automatic switching is triggered (see *Control Inputs/Outputs*, on page 7).

The LOCAL SPEAKER IN connector uses a removable 4-wire quick connector that accepts bare wire up to 14AWG. To wire the connector see the sidebar in the next column.

NOTE: THE LOCAL SPEAKER IN CIRCUIT IS COMPLETELY ISOLATED FROM GROUND AND IS COMPATIBLE WITH FLOATING GROUND OR BRIDGED AMPLIFIER OUTPUT SIGNALS.

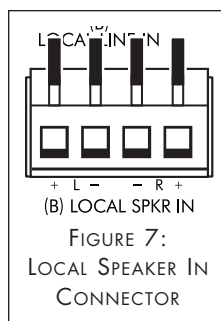

Wiring the Removable Quick Connectors

1. Mark each wire's positive ("+") and negative ("-") leads and its channel (left or right).
2. Strip no more than 1/8" of insulation from each wire. Twist the strands to ensure that there are no stray strands. (Stray strands that touch other or touch the amplifier chassis can cause a short-circuit that can damage the amplifier.)
3. Insert a small screwdriver into the slot on each lever to open the connector terminals (see *Figure 8*).

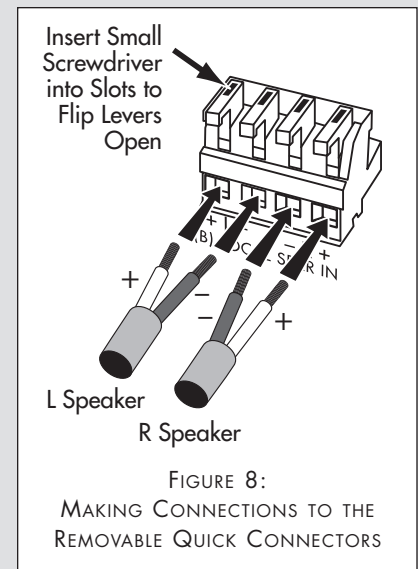

4. Insert the exposed portions of the wires into the terminal openings. Make sure to insert the '+' and '-' leads into the correct openings as indicated in the chassis markings below the connector.
5. After making sure that there are no stray wire strands touching each other, flip the levers down to lock the wires in the terminals.
6. Press the removable connector into the rear-panel connector until it locks into place.
 - The removable connectors will only fit one way on the amplifier.

Audio Output Connections

IMPORTANT: ALWAYS UNPLUG THE AMPLIFIER'S POWER CORD FROM THE WALL OUTLET BEFORE MAKING AUDIO, CONTROL OR SPEAKER CONNECTIONS.

SPEAKER OUTPUT Connector

Connect the speakers in the local area to the ASAP3D SE's Speaker Output connector (see *Figure 9*). These speakers will play whichever input source the ASAP3D SE has switched ON (see *Control Inputs/Outputs*, on page 7).

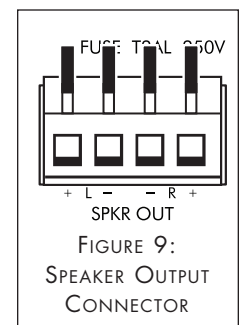



The SPEAKER OUTPUT connector uses a removable 4-wire quick connector that accepts bare wire up to 14AWG. To wire the quick connector see the sidebar on page 6.

Mono Fixed/Variable Output

The MONO VAR OUTPUT jack (see *Figure 10*) supplies a sum of the left & right channel signals from the LOCAL LINE IN or LOCAL SPEAKER IN connections.

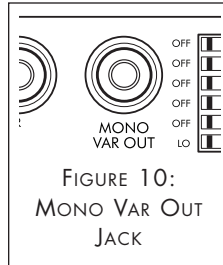

FIGURE 10:
MONO VAR OUT
JACK

The signal from the MONO VAR OUTPUT jack is ideal for driving a powered subwoofer, enabling the local system to deliver improved bass performance that will greatly enhance the listening experience when playing film soundtracks or musical performance videos.

Volume changes made with the front-panel INPUT SENSITIVITY adjustments or via IR commands will also effect the level of the MONO VAR OUTPUT, so the subwoofer will track volume adjustments made to the local main speakers.

NOTE: YOU CAN CHANGE THE MONO VAR OUT TO A FIXED-LEVEL OUTPUT BY SWITCHING AN INTERNAL JUMPER. FOR DETAILS SEE APPENDIX 1, ON PAGE 13.

Control Inputs/Outputs

IMPORTANT: ALWAYS UNPLUG THE AMPLIFIER'S POWER CORD FROM THE WALL OUTLET BEFORE MAKING CONTROL CONNECTIONS.

The ASAP3D SE has a set of rear-panel DIP switches (see *Figure 11*) that lets you select the different methods for triggering the switch from the House source to the Local source.

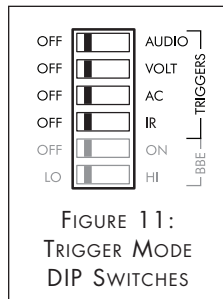

FIGURE 11:
TRIGGER MODE
DIP SWITCHES

AUDIO: The presence of a 10mV or higher audio signal at the LOCAL LINE IN or LOCAL SPEAKER IN inputs will switch the ASAP3D SE to the Local source.

VOLT: The presence of a 5 ~ 24V AC or DC external control voltage at the VOLTAGE TRIGGER input will switch the ASAP3D SE to the Local source. See *Voltage Trigger Connections*, next column.

AC: The ASAP3D SE will switch to the Local source when a TV set that is connected to the ASAP3D SE's AC Trigger Outlet is turned ON. See *AC Trigger Outlet*, on page 8.

IMPORTANT: YOU CAN ONLY USE ONE OF THE ABOVE TRIGGERING METHODS AT A TIME. IF MORE THAN ONE METHOD IS SELECTED THE ASAP3D SE WILL ENTER A PROTECT CONDITION AND WILL NOT SWITCH TO THE LOCAL SOURCE (SEE STATUS LEDs, ON PAGE 9). IF NO TRIGGER IS SELECTED THE AMPLIFIER WILL PASS THE HOUSE SOURCE TO THE SPEAKERS BUT WILL NOT SWITCH TO THE LOCAL SOURCE.

IR: The ASAP3D SE will switch to the Local source when it receives an amplifier ON command from a connected IR control device.

NOTE: THE IR TRIGGER CAN BE SELECTED ALONG WITH THE AUDIO, VOLTAGE OR AC TRIGGER, TO ALLOW IR CONTROL OF VOLUME, MUTE AND BBE ON/OFF IN THESE CONTROL MODES. IR ZONE ON AND ZONE OFF COMMANDS ARE IGNORED.

Voltage Trigger Connections

When the ASAP3D SE's VOLT trigger mode switch is set to the ON position, the source can be switched from House to Local by an external trigger voltage appearing at the VOLTAGE TRIGGER IN connections (see *Figure 12*). The trigger voltage must be between 5V and 24V, either AC or DC, usually supplied by the *Status* output from an IR control system.

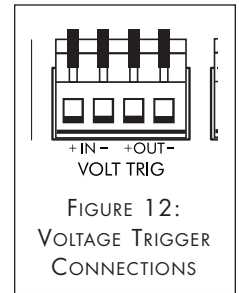

The VOLTAGE TRIGGER OUT connection (see *Figure 12*) supplies a 12V DC trigger signal whenever the Local source is ON. This trigger can be used to control other devices, such as Sonance AL2/AS2 automatic secondary switches, other Sonamps or 12V DC relays.

The VOLTAGE TRIGGER connections feature a removable 4-wire quick connector similar to the ones used for the speaker connections. To wire the connector see the sidebar on page 6.

IR Input

The IR INPUT connection (see *Figure 13*) allows the ASAP3D SE's Local/House source switching to be triggered by an IR signal from a keypad controller or other IR control device.

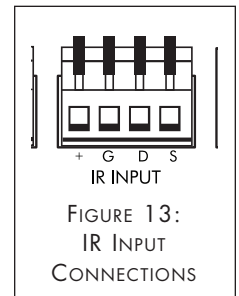

The IR INPUT connections feature a removable 16AWG 4-wire quick connector similar to the ones used for the speaker connections. To wire the connector see the sidebar on page 6.

The connections are as follows:

- +** = +12V DC **D** = Data
- GND** = Ground **S** = Status

IR control codes for the ASAP3D SE can be downloaded from the Sonance website: www.sonance.com.



IR Pass-Thru Outputs

The IR PASS-THRU OUTPUT connectors (see *Figure 14*) pass IR signals received at the IR INPUT connector (see above) and IR Bus input. They are designed for connection of IR emitters like the Sonance E1, E2, VE1 and VE2. The connectors accept 3.5mm mono male plugs. A red LED located between the connectors flashes to indicate IR activity.

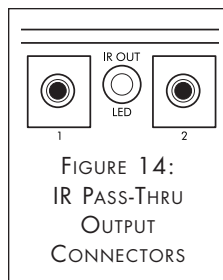

FIGURE 14:
IR PASS-THRU
OUTPUT
CONNECTORS

IR Bus Connection

The IR Bus connection (see *Figure 15*) links IR PASS THRU OUTPUT signals between multiple ASAP3D SE amplifiers, so that a single set of IR emitters can respond to commands from multiple IR controllers. This is useful if a single set of source components is being shared by different amplifiers for different zones.

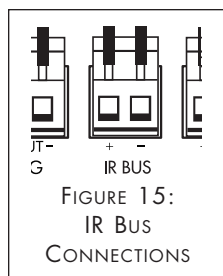
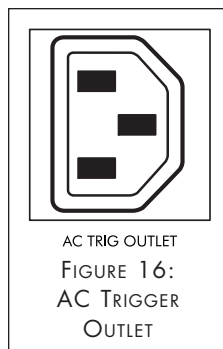

FIGURE 15:
IR BUS
CONNECTIONS

AC Trigger Outlet

The ASAP3D SE will sense when a TV connected to the AC TRIGGER OUTLET (see *Figure 16*) is turned ON and will switch to the Local source as long as the AC TRIGGER OUTLET is supplying current to the TV. When the current draw ceases the amplifier will switch back to the House source.



AC TRIG OUTLET
FIGURE 16:
AC TRIGGER
OUTLET

The 120V version of the ASAP3D SE includes an IEC power cable with one end designed to connect to a TV's power cable. The other end has a male IEC power connector that is designed to connect to the amplifier's AC TRIGGER OUTLET.

To maximize the ASAP3D SE's compatibility with a variety of TVs, the trigger sensitivity of the AC TRIGGER OUTLET is user-adjustable. See *AC Trigger Button*, next column.

NOTE: THE AC TRIGGER OUTLET IS NOT FUSED. THE REAR-PANEL AC FUSE PROTECTS THE ASAP3D SE CIRCUITRY ONLY.

Front Panel Indicators and Controls

Level Control Adjustment

IN ALL TRIGGER MODES EXCEPT FOR IR: The front-panel Level Control [L, R] potentiometers (see *Figure 17*) control the volume of the source connected to the LOCAL LINE IN or LOCAL SPEAKER IN jacks. These can be used to balance the

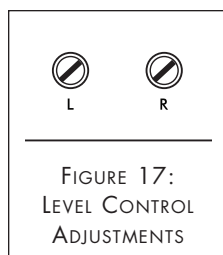

FIGURE 17:
LEVEL CONTROL
ADJUSTMENTS

volume of the Local source against the volume of the House source (the volume of which is determined by the source component feeding the HOUSE SPEAKER IN connections). Use a small screwdriver or similar tool to adjust the potentiometers.

IN THE IR TRIGGER MODE: The L [left] Level Control potentiometer sets the maximum volume level that both amplifier channels will achieve when responding to IR volume commands. Volume commands above that level will be ignored.

NOTE: AMPLIFIER VOLUME, MUTING AND BBE ON/OFF CAN BE CONTROLLED VIA IR REGARDLESS OF WHICH TRIGGER MODE IS SELECTED.

SENSE [Audio Trigger Sensitivity] Adjustment

The amount of Local source audio input voltage required to switch the ASAP3D SE from the House source to the Local source can be adjusted with the front-panel SENSE potentiometer (see *Figure 18*). Turning the control clockwise decreases the trigger sensitivity (requires more signal to trigger the input change).

- The minimum signal required for triggering is 5mV; the maximum is 4.5V. The factory setting is 5mV.

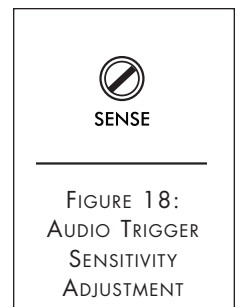

FIGURE 18:
AUDIO TRIGGER
SENSITIVITY
ADJUSTMENT

Audio Switching Delay Adjustment

When the AUDIO trigger mode is active, the amount of time it takes for the ASAP3D SE to revert back to the House source after the LOCAL input audio signal has ceased can be adjusted with the front-panel DELAY potentiometer (see *Figure 19*). Turning the control clockwise increases the delay time.

- The minimum delay time is 3 seconds; the maximum is 2 minutes. The factory setting is 3 seconds.

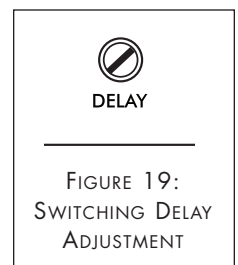

FIGURE 19:
SWITCHING DELAY
ADJUSTMENT

NOTE: IN THE VOLTAGE AND AC TRIGGER MODES, REVERSION BACK TO THE HOUSE SOURCE IS INSTANTANEOUS AFTER THE TRIGGERING EVENT CEASES.

STBY [Standby] Pinhole Switch

Pushing the STBY pinhole switch (see *Figure 20*) disables the automatic input triggering and passes the House source through to the speaker outputs. The HOUSE LED (see *Status LEDs*, on page 9) will flash once every 5 seconds to indicate the standby condition.

Pushing the STBY button again will restore normal operation.

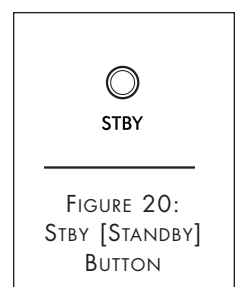
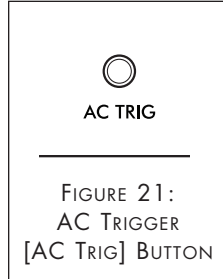

FIGURE 20:
STBY [STANDBY]
BUTTON



AC TRIG [AC Trigger] Pinhole Switch

The AC TRIG pinhole switch (see *Figure 21*) lets the ASAP3D SE determine the precise voltage appearing at its AC TRIGGER OUTLET that will trigger the amplifier to switch from the House to the Local source:



1. Place the TV that is connected to the AC TRIGGER OUTLET in the *Standby* or *OFF* mode.
 - The HOUSE AND BBE LEDs on the ASAP3D SE's front panel will flash and the amplifier's microprocessor records the (minimum) voltage level at the AC TRIGGER OUTLET.
2. Push the AC TRIG button.
 - The HOUSE AND BBE LEDs on the ASAP3D SE's front panel will flash and the amplifier's microprocessor records the (minimum) voltage level at the AC TRIGGER OUTLET.
3. Turn the TV's power ON.
4. Push the AC TRIG button again.
 - The ASAP3D SE's microprocessor records the (maximum) voltage level at the AC Trigger Outlet,
5. The ASAP3D SE calculates an AC trigger voltage that is between the maximum and the minimum voltage levels that will appear at the AC TRIGGER OUTLET. (This allows the amplifier to switch sources when the TV turns ON.)
 - When this process is completed the HOUSE AND BBE LEDs will stop flashing.

NOTE: THE ASAP3D SE WILL STAY IN THE HOUSE SOURCE MODE FOR APPROXIMATELY 2 SECONDS AFTER THE TV SWITCHES ON. THIS PREVENTS ANY ANNOYING TV SWITCHING NOISES FROM BEING AMPLIFIED THROUGH THE SYSTEM'S SPEAKERS.

To reset the AC Trigger Voltage to its factory level, unplug the amplifier's AC cord and plug it back in while holding-in the AC TRIG pinhole switch.

Status LEDs

The ASAP3D SE front panel has three LEDs (see *Figure 22*) that provide the amplifier's normal operating status:

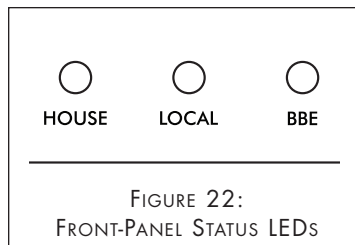

HOUSE: Illuminates when the House source is active.

LOCAL: Illuminates when the Local source is active.

BBE: Illuminates when BBE Sound Enhancement is active.

The HOUSE LED also flashes to indicate various protection and operational error conditions (see table in *Appendix 3*, on page 14).

BBE® Sound Enhancement

The Sonamp ASAP3D SE incorporates BBE® Sound Enhancement. The BBE process improves music's presence and detail, especially at lower listening volumes. This improves the sound of your audio system, particularly distributed audio systems playing background music. BBE also restores clarity and definition (or focus) to spoken voices, which makes paging systems easier to understand without having to run them at high volumes.

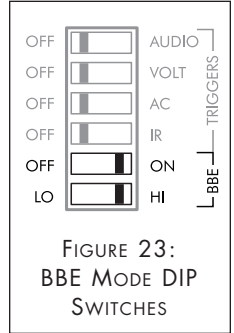

The ASAP3D SE has 2 individual switches to set the BBE enhancement (see *Figure 23*):

- If the BBE ON/OFF switch is set to OFF, BBE enhancement is not applied.
- If the BBE ON/OFF switch is set to ON, BBE enhancement is applied according to the setting of the LO/HI switch: LO = +3dB of BBE enhancement; HI = +6dB of BBE enhancement.

Specifications

Number of Channels:	2 (one stereo pair)
Output Power (Stereo):	25 watts RMS per channel, 0.25% THD, 20Hz – 20kHz, @ 8 ohms 50 watts per channel, 0.25% THD, 1kHz, @ 4 ohms
Frequency Response:	20Hz – 20kHz ±2dB
Total Harmonic Distortion:	0.10% (1kHz, 8 ohms); 0.25% (1kHz, 4 ohms)
Signal to Noise Ratio:	-94dB (w/22kHz filter, A-WTD); -88dB (with AC-sensing trigger)
Input Sensitivity:	0.9V for 25W RMS output 0.7V w/BBE ON (+3dB) 0.5V w/BBE ON (+6dB)
Input Impedance:	13k ohms
Maximum Source Input Voltage:	2.3VAC RMS 1.3VAC RMS w/BBE ON
Power Consumption:	200 Watts
Heat Output:	187 BTU/hr
AC Fuse:	2A (T2AL ~ 250V)
Dimensions (W x H x D):	9½" x 1¾" x 12½" (241mm x 45mm x 318mm)
Rack Space Requirements:	1U (½-rack width)
Weight:	7.0 lbs (3.2kg)



Installation Examples

The illustrations on these pages show the wide variety of audio and audio/video systems that can be assembled using one or more Sonamp ASAP3D SE amplifiers. Your local Authorized Sonance Dealer is an expert in audio/video system planning and installation. Sonance strongly recommends that you work with your dealer to ensure that your system is properly planned, assembled and installed.

ASAP3D SE System with AC Triggering

Figure 24 shows the typical system connections when triggering the ASAP3D SE via AC. The LOCAL LINE IN and LOCAL SPEAKER IN connections are both shown for illustrative purposes. Although they both can be used simultaneously, normally only one would be used.

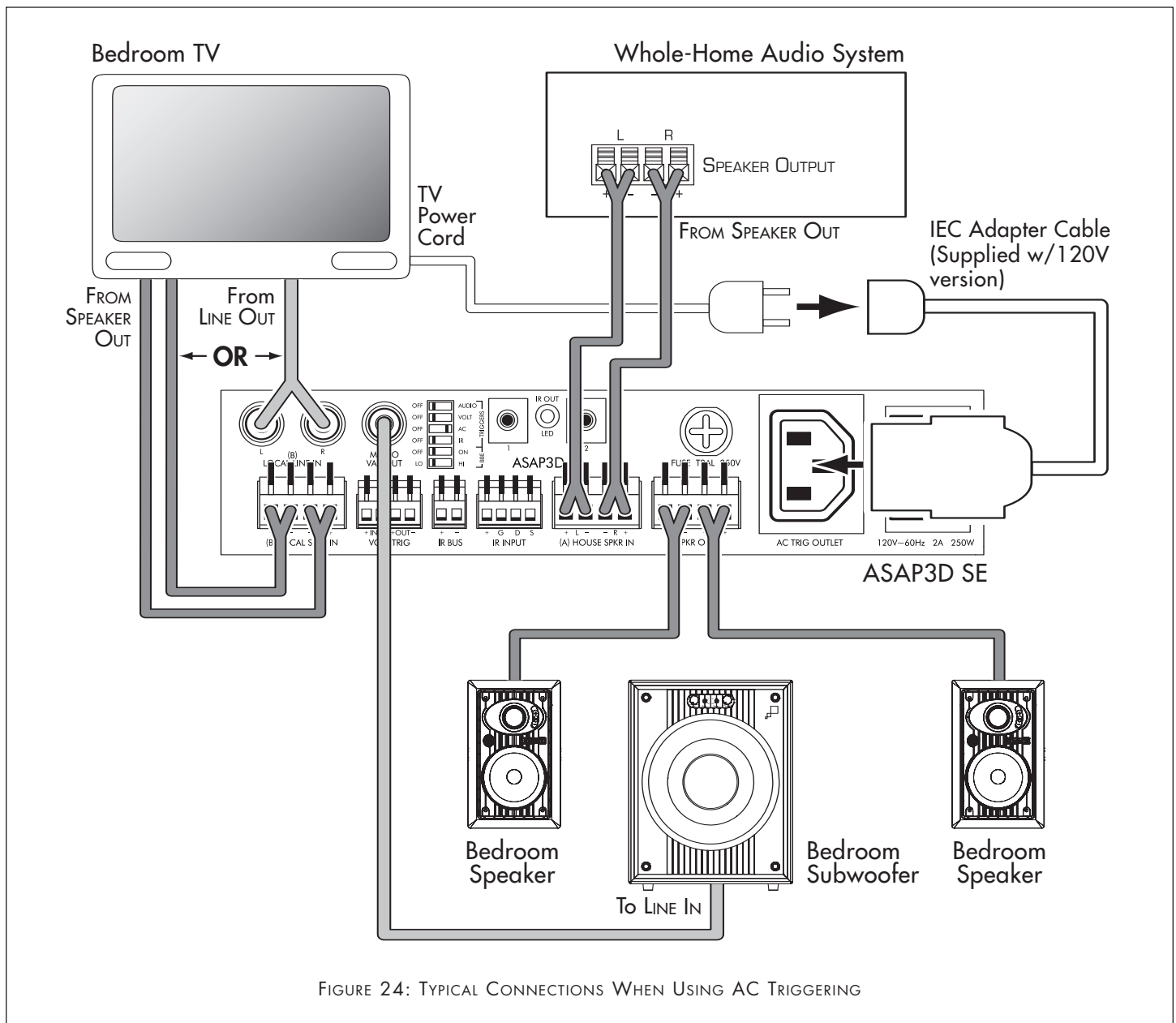

FIGURE 24: TYPICAL CONNECTIONS WHEN USING AC TRIGGERING



ASAP3D SE System with IR Triggering

Figure 25 shows the typical system connections when triggering the ASAP3D SE via IR from a keypad controller or other IR control device. If multiple ASAP3D SEs are being used their IR BUS connections can be linked, allowing each of their IR control devices to send signals to a single set of IR emitters on a set of source components being shared by all the systems.

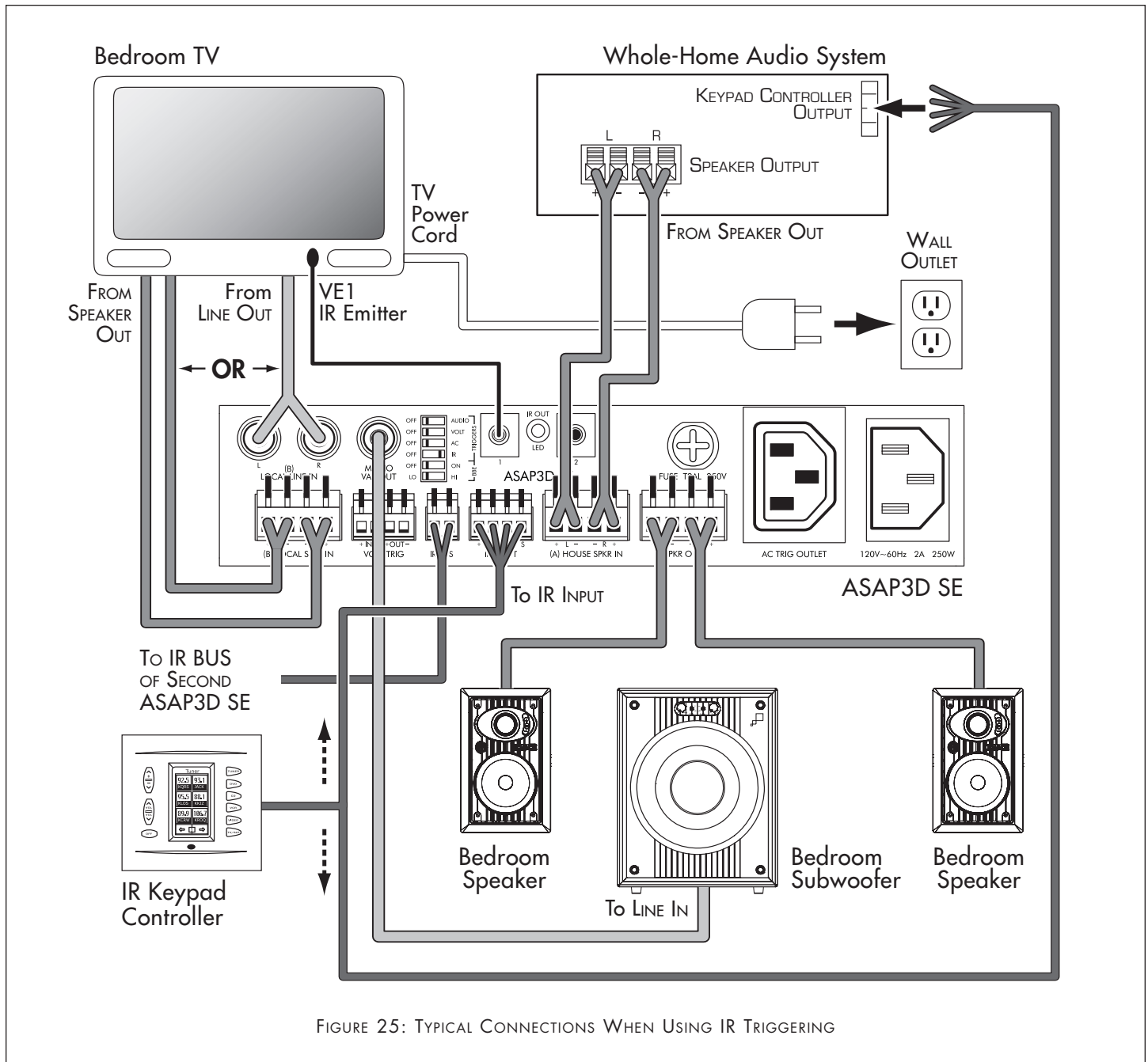

FIGURE 25: TYPICAL CONNECTIONS WHEN USING IR TRIGGERING



ASAP3D SE System with Individual Zone IR Controller

Figure 26 shows the typical system connections when using the ASAP3D SE as a sub-zone amplifier, being driven by the audio signal from one zone of a multi-zone controller.

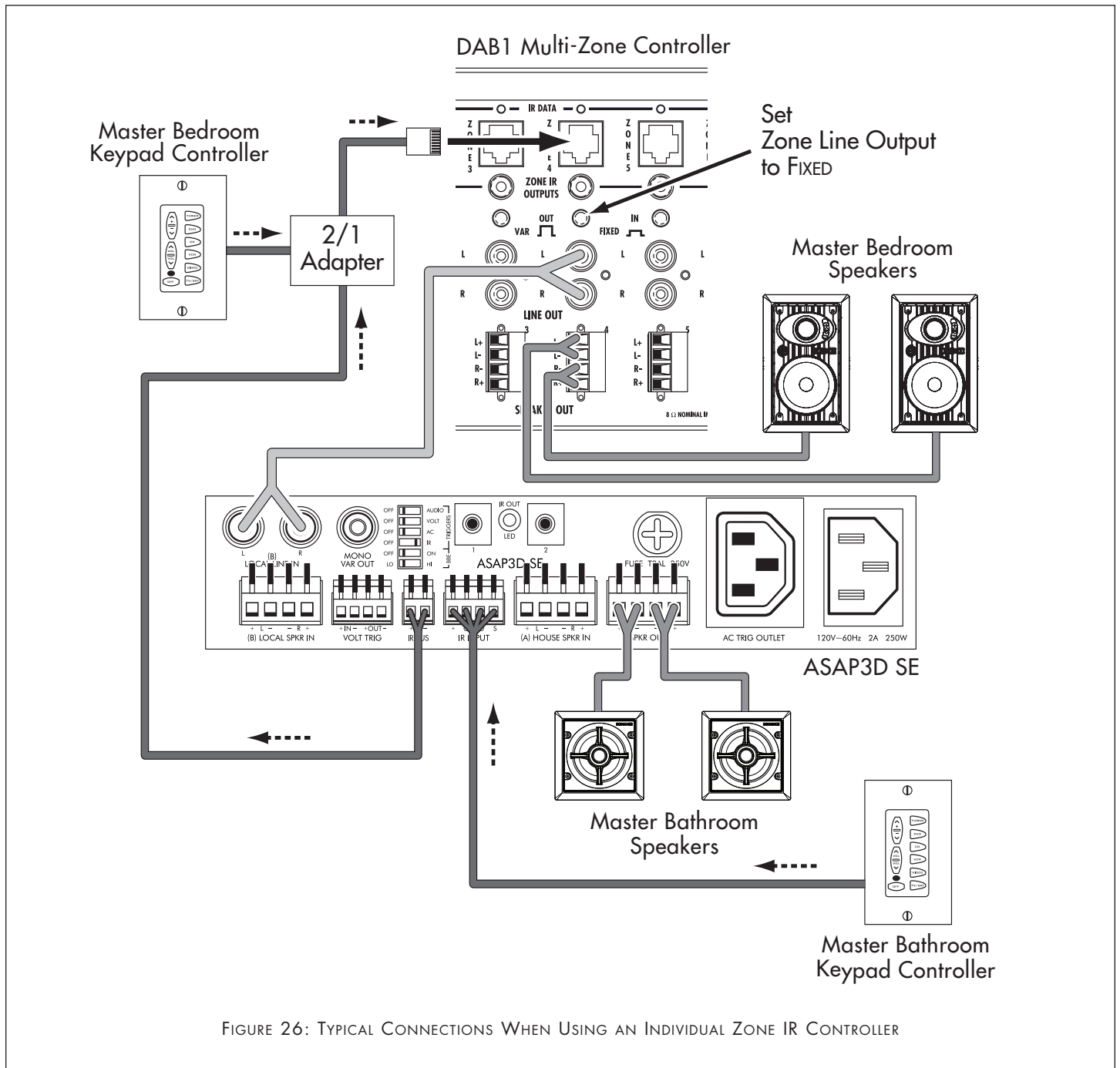

FIGURE 26: TYPICAL CONNECTIONS WHEN USING AN INDIVIDUAL ZONE IR CONTROLLER



Appendix 1: Changing the Mono Variable Output to a Fixed Output Level

The MONO VAR OUT is factory-set to *Variable* via a jumper on the amplifier PCB. To change the output to a fixed level (which is not affected by the front-panel L and R Input Level Controls or by IR volume commands):

1. Unplug the amplifier's power cord from the Power Cord Connection on the back of the amplifier.
2. Remove the 8 screws (4 on top and 2 on each side) that secure the amp's chassis cover.
3. Locate the MONO OUT section on the circuit board (see *Figure 27*).
4. Remove the jumper from the center pin and the "V" (variable) pin and re-insert it between the center pin and the "F" (fixed) pin (see *Figure 28*).
5. Replace the amplifier's chassis cover and screws, and plug the power cord back into the Power Cord Connection.

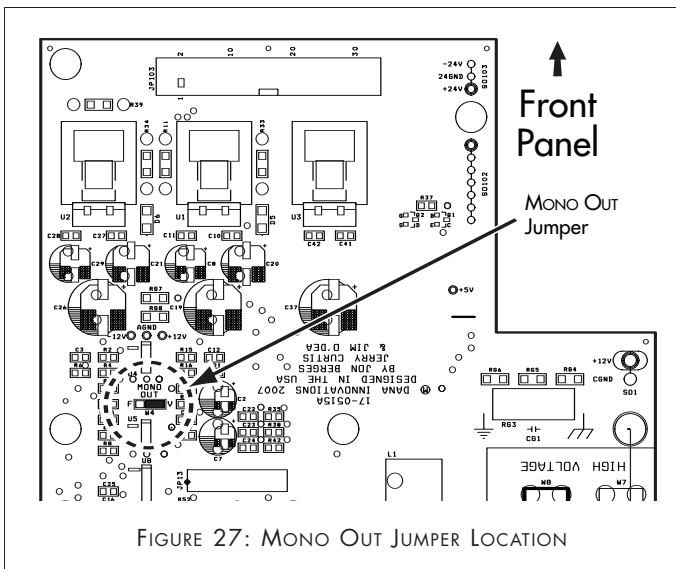

FIGURE 27: MONO OUT JUMPER LOCATION

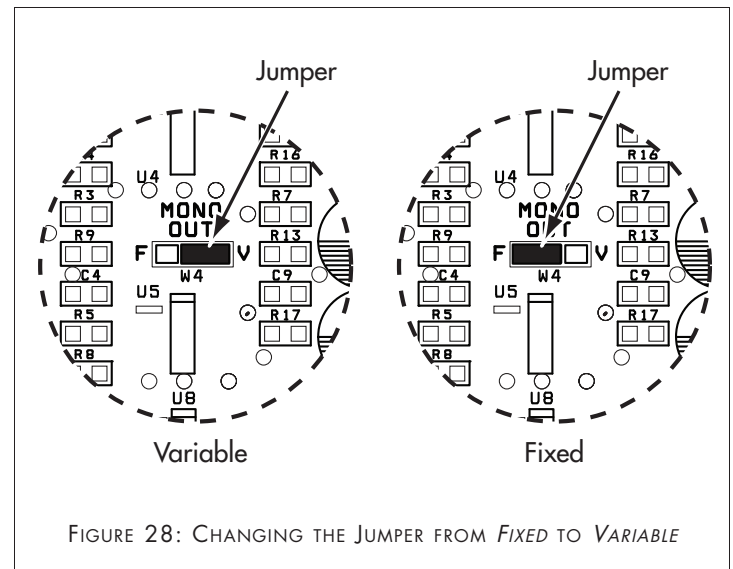

FIGURE 28: CHANGING THE JUMPER FROM *FIXED* TO *VARIABLE*

Appendix 2: IR Command List

The following ASAP3D SE functions can be controlled via IR:

- Amplifier ON (Local source active)
- Amplifier OFF (House source active)
- Mute ON
- Mute OFF
- Mute Toggle ON/OFF
- Volume -1 (Down one step)
- Volume +1 (Up one step)
- Volume -3 (Down three steps)
- Volume +3 (Up three steps)
- Volume -5 (Down five steps)
- Volume +5 (Up five steps)
- Volume 0 (Jump to 0)
- Volume 20 (Jump to 20)
- Volume 40 (Jump to 40)
- Volume 60 (Jump to 60)
- Volume 80 (Jump to 80)
- Volume 100 (Jump to 100)
- BBE ON
- BBE OFF
- BBE Toggle ON/OFF



Appendix 3: Front-Panel LED Fault Indications

House LED Action	Cause	Condition	Remedy
1 Flash every 5 seconds	Amplifier is in STANDBY mode	Amplifier will not switch to LOCAL source	Press front-panel STBY button
1 Flash every 2 seconds	More than 1 Trigger Mode switch (AUDIO, VOLT, AC) is set to ON	Amplifier output muted	Set only 1 AUDIO, VOLT or AC Trigger Mode switch to ON
2 Flashes every 2 seconds	Over-Temperature	Amplifier output muted	Unplug the AC cord, wait 30 seconds, then plug the AC cord back in
3 Flashes every 2 seconds	Over-Current; Short-circuit in speaker output	Amplifier output mutes for 5 seconds, then turns back ON	No action necessary if the amplifier remains ON*
*If the amplifier goes into Over-Current or Short-Circuit protection 5 times in 1 minute it will shut-down. After correcting the over-current condition (speaker impedance too low, volume too high, short-circuit, etc), unplug the AC cord, wait 10 seconds, then plug the AC cord back in.			

Technical Assistance and Service

If you have any questions about the operation or installation of this product, please call our Technical Assistance Department on any business day at (800) 582-0772 or (949) 492-7777; from 7 a.m. to 5 p.m., PST.

If your amplifier should need repair or service, contact your Sonance Authorized Dealer for help, or use the following procedure:

1. Prior to calling note the product's model number, serial number, purchase date, and the name and address of the dealer where you purchased the product.
2. Contact our Technical Assistance Department at the above number(s) and describe the problem the unit is experiencing. If applicable, they will issue a Return Authorization Number.

IMPORTANT: You must have prior authorization to return your amplifier to Sonance!

3. If you're directed to return the unit to Sonance for repair, pack the unit in its original shipping carton. If needed, you can obtain replacement packaging from us for a small charge. It is best if you place the box into an additional outer "overcarton" before shipment to minimize a chance of theft in shipment. Please include a copy of the original bill of sale inside the package.
4. Contact a package delivery service such as United Parcel Service or Federal Express to arrange prepaid (not collect) shipping. Do not use the U.S. Postal Service.

IMPORTANT: Freight collect shipments will be refused.

5. Write the Return Authorization Number on the outside of the shipping carton.

6. Ship the packaged unit to:

Quality Assurance Department
 Sonance
 212 Avenida Fabricante
 San Clemente, CA 92672-7531



Limited Warranty Coverage (U.S. Only)

Sonance warrants to the original retail purchaser only that this Sonance product will be free from defects in materials and workmanship for a period of five (5) years, provided the product was purchased from a Sonance Authorized Dealer.

Defective products must be shipped, together with proof of purchase, prepaid insured to the Authorized Sonance Dealer from whom they were purchased, or to the Sonance factory at the address listed on this instruction manual. Freight collect shipments will be refused. It is preferable to ship this product in the original shipping container to lessen the chance of transit damage. In any case, the risk or loss or damage in transit is to be borne by the purchaser. If upon examination at the factory or Authorized Sonance Dealer it is determined that the unit was defective in materials or workmanship at any time during this warranty period, Sonance or the Authorized Sonance Dealer will, at its option, repair or replace this product at no additional charge, except as set forth below. If this model is no longer available and cannot be repaired effectively, Sonance, at its sole option, may replace the unit with a current model of equal or greater value. In some cases where a new model is substituted, a modification to the mounting surface may be required. If mounting surface modification is required, Sonance assumes no responsibility or liability for such modification. All replaced parts and product become the property of Sonance. Products replaced or repaired under this warranty will be returned to the original retail purchaser, within a reasonable time, freight prepaid.

This Warranty does not include service or parts to repair damage caused by accident, disaster, misuse, abuse, negligence, inadequate packing or shipping procedures, commercial use, voltage inputs in excess of the rated maximum of the unit, or service, repair or modification of the product which has not been authorized or approved by Sonance. This Warranty also excludes normal cosmetic deterioration caused by environmental conditions. This Warranty will be void if the Serial Number on the product has been removed, tampered-with or defaced. This Warranty is in lieu of all other expressed warranties. If the product is defective in materials or workmanship as warranted above, the purchaser's sole remedy shall be repair or replacement as provided above. In no event will Sonance be liable for any incidental or consequential damages arising out of the use or inability to use the product, even if Sonance or an Authorized Sonance Dealer has been advised of the possibility of such damages, or for any claim by any other party.

Some states do not allow the exclusion or limitation of consequential damages, so the above limitation and exclusion may not apply. All implied warranties on the product are limited to the duration of this expressed Warranty. Some states do not allow limitation on the length of an implied warranty. If the original retail purchaser resides in such a state, this limitation does not apply.

Exclusions and Limitations

The warranty set forth above is in lieu of all other warranties, express or implied, of merchantability, fitness for a particular purpose, or otherwise. The warranty is limited to Sonance products registered herein and specifically excludes any damage to loudspeakers and other allied or associated equipment which may result for any reason from use with this product. Sonance shall, in no event, be liable for incidental or consequential damages arising from any breach of this warranty or otherwise. This warranty gives you specific legal rights, and you may have other rights which vary from state to state.



SONANCE®

©2008 Sonance. All rights reserved. Sonance, Sonamp and OptiLinQ are registered trademarks of Dana Innovations. "BBE" and its designs are the registered trademarks of BBE Sound, Inc. ICEpower is a registered trademark of Bang & Olufsen ICEpower. Due to continuous product improvement, all features and specifications are subject to change without notice.

For the latest Sonance product specification information visit our website: www.sonance.com

SONANCE • 212 Avenida Fabricante • San Clemente, CA 92672-7531 USA • (800) 582-7777 or (949) 492-7777
FAX: (949) 361-5151 • Technical Support: (800) 582-0772

www.sonance.com

Free Manuals Download Website

<http://myh66.com>

<http://usermanuals.us>

<http://www.somanuals.com>

<http://www.4manuals.cc>

<http://www.manual-lib.com>

<http://www.404manual.com>

<http://www.luxmanual.com>

<http://aubethermostatmanual.com>

Golf course search by state

<http://golfingnear.com>

Email search by domain

<http://emailbydomain.com>

Auto manuals search

<http://auto.somanuals.com>

TV manuals search

<http://tv.somanuals.com>