

**Honeywell**

---

**DCP301**  
**Digital Program Controller**  
**User's Manual**

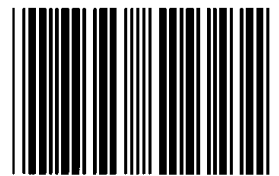

**\*P301\***

**EN11-6197**  
**Issue 7 (02/04)**

## **WARRANTY**

*The Honeywell device described herein has been manufactured and tested for corrent operation and is warranted for a period of one year.*

## **TECHNICAL ASSISTANCE**

*If you encounter a problem with your unit, please review all the configuration data to verify that your selections are consistent with your application; (i.e. Inputs, Outputs, Alarms, Limits, etc.). If the problem persists after checking the above parameters, you can get technical assistance by calling the following:*

*In the U.S.A. . . . . 1-800-423-9883*

*In Europe . . . . . Your local branch office*

# SAFETY PRECAUTIONS

## About Icons

Safety precautions are for ensuring safe and correct use of this product, and for preventing injury to the operator and other people or damage to property. You must observe these safety precautions. The safety precautions described in this manual are indicated by various icons.

The following describes the icons and their meanings. Be sure to read and understand the following descriptions before reading this manual.



### WARNING

Warnings are indicated when mishandling this product might result in death or serious injury to the user.



### CAUTION

Cautions are indicated when mishandling this product might result in minor injury to the user, or only physical damage to this product.

## Examples

	<p>Triangles warn the user of a possible danger that may be caused by wrongful operation or misuse of this product.</p> <p>These icons graphically represent the actual danger. (The example on the left warns the user of the danger of electric shock.)</p>
	<p>White circles with a diagonal bar notify the user that specific actions are prohibited to prevent possible danger.</p> <p>These icons graphically represent the actual prohibited action. (The example on the left notifies the user that disassembly is prohibited.)</p>
	<p>Black filled-in circles instruct the user to carry out a specific obligatory action to prevent possible danger.</p> <p>These icons graphically represent the actual action to be carried out. (The example on the left instructs the user to remove the plug from the outlet.)</p>

# **WARNING**



Before connecting the DCP301 to the measurement target or external control circuits, make sure that the FG terminal is properly grounded (100Ω max.).  
Failure to do so might cause electric shock or fire.



Before wiring, or removing/mounting the DCP301, be sure to turn the power OFF. Failure to do so might cause electric shock.



Do not touch electrically charged parts such as the power terminals. Doing so might cause electric shock.



Do not disassemble the DCP301. Doing so might cause electric shock or faulty operation.

# **CAUTION**



Use the DCP301 within the operating ranges recommended in the specifications (temperature, humidity, voltage, vibration, shock, mounting direction, atmosphere, etc.). Failure to do so might cause fire or faulty operation.



Do not block ventilation holes. Doing so might cause fire or faulty operation.



Wire the DCP301 properly according to predetermined standards. Also wire the DCP301 using designed power leads according to recognized installation methods.  
Failure to do so might cause electric shock, fire or faulty operation.



Do not allow lead clippings, chips or water to enter the controller case. Doing so might cause fire or faulty operation.



Inputs to the current input terminals (31) and (33) on the DCP301 should be within the current and voltage ranges listed in the specifications.



Firmly tighten the terminal screws at the torque listed in the specifications. Insufficient tightening of terminal screws might cause electric shock or fire.



Do not use unused terminals on the DCP301 as relay terminals. Doing so might cause electric shock, fire or faulty operation.









We recommend attaching the terminal cover (sold separately) after wiring the DCP301. Failure to do so might cause electric shock, fire or faulty operation.



Use the relays on the DCP301 within the service life listed in the specifications.  
Continued use of the relays after the recommended service life might cause fire or faulty operation.

# CAUTION

	Use induced lighting surge preventive device if there is the risk of power surges caused by lightning. Failure to do might cause fire or faulty operation.
	Before replacing the battery, be sure to turn the power OFF. Failure to do so might cause electric shock.
	Do not touch internal components immediately after turning the power OFF to replace the battery. Doing so might cause burns.
	<ul style="list-style-type: none"><li>• Do not insert the battery with the polarities (+,-) reversed.</li><li>• Do not use damaged (broken battery skin, leaking battery fluid) batteries.</li><li>• Do not throw batteries into fires, or charge, short-circuit, disassemble or heat batteries.</li><li>• Store batteries in low-temperature, dry locations.</li></ul> Failure to observe the above cautions may cause batteries to emit heat or split, or battery fluid to lead.
	Store batteries out of the reach of small children. Batteries are small and are easy to swallow. If a child swallows a battery, consult a physician immediately.
	Return used batteries to Honeywell sales/service office or your dealer. When disposing of used batteries at the user site, observe local by laws.

## Handling Precautions

After turning the power ON, do not operate the DCP301 for at least 15s to allow the DCP301 to stabilize.

# Unpacking



Check the following when removing the **DCP301** from its package.

1. Check the model No. to make sure that you have received the product that you ordered.
2. Check the **DCP301** for any apparent physical damage.
3. Check the contents of the package against the Package List to make sure that all accessories are included in the package.

After unpacking, handle the **DCP301** and its accessories taking care to prevent damage or loss of parts.

If an inconsistency is found or the package contents are not in order, immediately contact your dealer.

## Product List

Name	Model No.	Q'ty	Remarks
Body 		1	See 1-5 How Model Nos. Are Configured, page 1-5.
Mounting bracket 	81405411-001	1 set (2)	The Model No. is the parts No. for two installation tools.
User's Manual 	EN11-6197	1	This manual
Unit indicator label (SI units)	N-3132	1	

# Request

The filter on the front of the controller is Covered with a protective film to protect the surface of the controller. When you have finished mounting and wiring the controller, fix cellophane adhesive tape on the corners of the filter, and pull in the direction of the arrow to peel off the protective film.

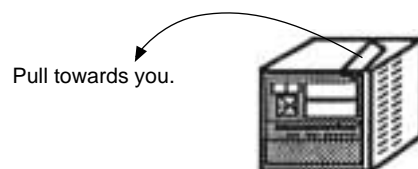

## Handling Precautions

Peeling off the protective film with your fingernail might scratch the surface of the controller.

# Organization of This User's Manual

---

This manual is organized as follows.

## **Chapter 1. GENERAL**

This chapter describes DCP301 applications, features and basic function blocks. It also gives a list of model numbers.

## **Chapter 2. NAMES & FUNCTIONS OF PARTS**

This chapter describes the names and functions of DCP301 parts, input types and range Nos.

## **Chapter 3. MOUNTING**

This chapter describes how to mount the DCP301 on control panels. This chapter is required reading for designers of control systems using the DCP301.

## **Chapter 4. WIRING**

This chapter describes the precautions when wiring the DCP301 to a control system and how to wire the DCP301. This chapter is required reading for designers of control systems and supervisors of wiring work.

## **Chapter 5. FUNCTIONS**

This chapter describes the functions of the controller. This chapter is required reading for designers of control systems using the DCP301.

## **Chapter 6. OPERATION**

This chapter describes how to switch the basic display states of the DCP301, and select and run programs. This chapter is required reading for designers of control systems using the DCP301 and users of the DCP301.

## **Chapter 7. PARAMETER SETUP**

This chapter describes how to set up parameters on the controller and the meaning of settings.

## **Chapter 8. PROGRAM SETUP**

This chapter describes how to set up programs on the controller and the meanings of settings.

## **Chapter 9. TROUBLESHOOTING**

This chapter describes points to check when the DCP301 is not working properly or how to remedy trouble that might occur.

## **Chapter 10. SPECIFICATIONS**

This chapter describes the general specifications, performance specifications and external dimensions of the DCP301.

## **Chapter 11. CALIBRATION**

This chapter describes calibration procedures for the functions of the DCP301.

# Contents

---

Safety Precautions	
Unpacking	
Request	
Organization of the Product Manual	
Conventions Used in This Manual	

## Chapter 1. GENERAL

1-1 Features	1-1
1-2 Basic Function Blocks	1-2
1-3 Data Structure	1-3
1-4 System Configuration	1-4
System configuration by CPL communications	1-4
1-5 Model Numbers	1-5
Model selection guide	1-5

## Chapter 2. NAMES & FUNCTIONS OF PARTS

2-1 Structure	2-1
2-2 Console	2-2
Basic display state	2-2
Display	2-2
Keys	2-4
Functions using two or more keys	2-7
Loader jack	2-7
2-3 Input Type and Range No.	2-8
Inputs	2-8

## Chapter 3. MOUNTING

3-1 External Dimensions	3-1
3-2 Panel Cutout Dimensions	3-2
3-3 Mounting	3-3
Mounting locations	3-3
Noise generating sources and countermeasures	3-4
Dust-proof cover	3-4
Mounting method	3-5

## Chapter 4. WIRING

4-1 Wiring Precautions	4-1
4-2 Compensating Lead	4-3
4-3 Terminal Connections	4-4
4-4 Layout of Terminals and Recommended Lead Draw-out Direction	4-5
4-5 Connecting the Ground and Power Supply	4-6
Power supply	4-6
Ground	4-6
4-6 Wiring of Standard and Add-on Terminal Base	4-7
Standard terminal layout	4-7
Add-on terminal layout	4-7



4-7	Connecting Inputs (analog inputs)	4-8
	Connecting input 1	4-8
4-8	Connecting control outputs (outputs 1, 2)	4-9
	Relay output (0D)	4-9
	Current output (5G)	4-9
	Position-proportional output (2G)	4-9
	Voltage output (6D)	4-10
	Heat/cool output (3D)	4-10
	Heat/cool output (5K)	4-10
4-9	Connecting auxiliary outputs (outputs 2, 3)	4-11
	0D, 5G, 6D auxiliary outputs	4-11
	2G, 3D, 5K auxiliary outputs	4-11
4-10	Connecting Event Output (relay output)	4-12
4-11	Connecting Time Event Output (open-collector)	4-13
4-12	Connecting External Switch (RSW) Input	4-14
4-13	Connecting for Communications	4-16
	RS-485 interface	4-16
4-14	Isolating Inputs and Outputs	4-19
	Control outputs 0D, 5G, 6D, 3D, 5K	4-19
	Control output 2G	4-19

## Chapter 5. FUNCTIONS

5-1	Data	5-1
	Data types	5-1
5-2	Program Patterns	5-2
	Patterns	5-2
	Events 1 to 3	5-3
	Time events 1 to 5	5-6
	PID set selection	5-8
	G.Soak (guarantee soak)	5-8
	PV start	5-9
	Cycle	5-9
	Pattern link	5-10
5-3	Modes	5-11
	Mode type	5-11
	Mode transition	5-13
	Mode transition operations	5-14
	Mode transition limitations	5-15
5-4	Controller and Programmer	5-16
5-5	Input Processing Functions	5-17
5-6	Output Processing Functions	5-18
	Control output	5-18
	SP output	5-22
	Auxiliary output	5-22

## Chapter 6. OPERATION

6-1	Turning the Power ON	6-1
6-2	Switching the Basic Display	6-2

■ Display in program operation mode . . . . .	6-3
■ Display in constant-value operation mode . . . . .	6-5
6-3 Program Selection . . . . .	6-7
■ How to select the program No. . . . .	6-7
6-4 External Switch (RSW) Operations . . . . .	6-8
■ External switch (RSW) inputs . . . . .	6-8
■ Program selection . . . . .	6-9
■ Read timing . . . . .	6-10
6-5 Manual Operation and Auto-tuning . . . . .	6-11
■ Manual operation . . . . .	6-11
■ Auto-tuning (AT) . . . . .	6-11

## Chapter 7. PARAMETER SETUP





















7-1 Parameter Setup . . . . .	7-1
■ Selecting the setting group in the parameter setup . . . . .	7-1
■ Moving individual items in the parameter setup . . . . .	7-2
■ Changing individual items and how to return from the setup state . . . . .	7-2
7-2 How to Use  . . . . .	7-4
■ How to register functions to keys . . . . .	7-4
7-3 Parameter Setup List . . . . .	7-7
■ Variable parameter settings “P R r R” . . . . .	7-7
■ Description of variable parameter settings . . . . .	7-10
■ Event configuration data settings “E v” . . . . .	7-18
■ Description of event configuration data . . . . .	7-22
■ PID parameter settings “P I d” . . . . .	7-23
■ Setup data settings “S E t” . . . . .	7-27
■ Description of setup data settings . . . . .	7-33
■ Table data settings “t b L” . . . . .	7-40
■ Description of table data settings . . . . .	7-41
■ Constant-value operation data settings “C n S t” . . . . .	7-42





















## Chapter 8. PROGRAM SETUP

8-1 Program Setup . . . . .	8-1
■ How to enter program setup . . . . .	8-1
■ Selecting the program No. to set up . . . . .	8-1
■ Mode transition . . . . .	8-2
■ Programming map . . . . .	8-4
■ Display details . . . . .	8-5
■ Setting up pattern items . . . . .	8-5
■ Setting up events 1 to 3 items . . . . .	8-6
■ Setting up time events 1 to 5 . . . . .	8-8
■ Setting up PID set No. items . . . . .	8-9
■ Setting up G.Soak (guarantee soak) items . . . . .	8-10
■ Setting up G.Soak time-out items . . . . .	8-10
■ Setting up PV start items . . . . .	8-11
■ Setting up cycle items . . . . .	8-11
■ Setting up pattern link items . . . . .	8-12
■ Deleting programs . . . . .	8-12
■ Inserting and deleting segments . . . . .	8-13

8-2 Copying Programs .....	8-14
Operation .....	8-14
8-3 General Reset .....	8-15
Operation .....	8-15

## Chapter 9. TROUBLESHOOTING

9-1 Self-diagnostics and Alarm Code Display .....	9-1
Self-diagnostics at power ON .....	9-1
Self-diagnostics at each sampling cycle .....	9-1
Intermittent self-diagnostics during operation .....	9-1
Self-diagnostics only when certain functions are operating .....	9-2
Alarm code display .....	9-2
Alarm categories .....	9-2
9-2 Trouble during Key Entry .....	9-3
The program No. does not change by pressing  in basic display state .....	9-3
The program No. does not change by pressing  in the basic display state .....	9-3
The controller does not change to RUN mode by pressing  in the basic display state .....	9-3
The controller does not change to HOLD mode by pressing  in the basic display state .....	9-3
The controller cannot be reset by pressing  +  in the basic display state .....	9-3
The program is not advanced by pressing  +  in the basic display state .....	9-4
The controller does not change to FAST mode by pressing  +  in the basic display state .....	9-4
The controller does not change to MANUAL mode by pressing  in the basic display state .....	9-4
The controller does not change to AUTO mode by pressing  in the basic display state .....	9-4
Auto-tuning (AT) is not started by pressing  in the basic display state .....	9-4
Auto-tuning (AT) is not canceled by pressing  in the basic display state .....	9-5
Setting group other than “P R r R” is not displayed by pressing  by selecting the setting group in parameter set state .....	9-5
Setting group other than “S E t” is not displayed by pressing  by selecting the setting group in parameter set state .....	9-5
The controller does not enter the setting entry state by pressing  in the parameter setup state .....	9-5
The controller does not change to setup group selection state and setting entry state continues by pressing  in parameter setting entry state .....	9-5
The controller does not change to program setup state by pressing  +  in the basic display state .....	9-5
The controller does not change to the setting entry state by pressing  in the basic display state .....	9-5

Items cannot be changed by pressing  ,  in program setup state . . . . .	9-6
Event items cannot be changed by repeatedly pressing  ,  in program setup state . . . . .	9-6
Time events cannot be changed by repeatedly pressing  ,  in program setup state . . . . .	9-6
PID set items cannot be changed by repeatedly pressing  ,  in program setup state . . . . .	9-6
G.Soak items cannot be changed by repeatedly pressing  ,  in program setup state . . . . .	9-6
PV start items, cycle items and pattern link items cannot be displayed by repeatedly pressing  ,  in program setup state . . . . .	9-6
Insertion/deletion of segments cannot be confirmed by pressing  +  in program setup state . . . . .	9-7
Program deletion cannot be confirmed by pressing  +  while entering pattern items in program setup state . . . . .	9-7
The program cannot be copied by pressing  +  in the basic display state . . . . .	9-7
General reset is not applied by pressing  +  +  in the basic display state . . . . .	9-7
<b>9-3 Motor Adjustment is Impossible . . . . .</b>	<b>9-8</b>
Normal wiring for direct motor rotation . . . . .	9-9
Normal wiring for reverse motor rotation. . . . .	9-9
Alarm display caused by wrong wiring and causes . . . . .	9-9
<b>9-4 Replacing the Battery . . . . .</b>	<b>9-10</b>
BAT LED blinking . . . . .	9-10
Items to prepare . . . . .	9-10
Replacement procedure. . . . .	9-11

## Chapter 10. SPECIFICATIONS

<b>10-1 Specifications . . . . .</b>	<b>10-1</b>
Accessories/option list . . . . .	10-7
<b>10-2 External Dimensions . . . . .</b>	<b>10-8</b>
Soft dust-proof cover set. . . . .	10-9
Hard dust-proof cover set . . . . .	10-9
Terminal cover set . . . . .	10-9

## Chapter 11. CALIBRATION

Precautions before calibration . . . . .	11-1
Equipment needed . . . . .	11-1
<b>11-1 Quick Reference Table for Calibration Items . . . . .</b>	<b>11-2</b>
<b>11-2 Calibration Procedures . . . . .</b>	<b>11-6</b>
Enter calibration mode. . . . .	11-6
Function test . . . . .	11-7
PV calibration. . . . .	11-10
Cold junction sensor calibration. . . . .	11-12
Current output calibration . . . . .	11-12

## Index

# Conventions Used in This Manual

---

The following conventions are used in this manual.

## Handling Precautions

: Handling Precautions indicate items that the user should pay attention to when handling the **DCP301**.



## Note

: Notes indicate useful information that the user might benefit by knowing.



: These icons represent keys on the DCP301's console.



: Combinations of icons like these indicate that  must be pressed while holding  down.

(1) (2) (3)

: The numbers with the parenthesis indicate steps in a sequence or indicate corresponding parts in an explanation.

>>

: Indicates the controller state after an operation.

# Chapter 1. GENERAL

## 1-1 Features

---

The DCP301 is a general-purpose single-loop program controller for controlling temperature, pressure, flow rate and other inputs.

- **High accuracy achieved by multi-range input**

Multi-range input allows you to choose between the following input types: thermocouple, resistance temperature detector (RTD), dc voltage and dc current. Accuracy of  $\pm 0.1\%FS \pm 1$  digit and a sampling cycle of 0.1s ensures consistently high-precision control.

- **Wide range of control output types**

A wide range of models supporting various control output types are available: relay time-proportional output, position-proportional output, current output, voltage time-proportional output, and heat/cool output.

On models other than heat-cool control output, you can also choose neural net-based auto-tuning and smart-tuning for inhibiting overshoot, in addition 2 degrees of freedom PID.

- **Enhanced compatibility with PLC**

12 external switch inputs (eight optional), three event outputs and five time event outputs (optional) ensure compatibility with automating systems designed around a PLC core.

- **Easy operation**

Up to eight frequently changed parameter setups can be registered to the  key, facilitating recall of item setups.

If the Smart Loader Package (sold separately) is used together with the DCP301, programs and parameters can be set up on a personal computer.

## 1-2 Basic Function Blocks

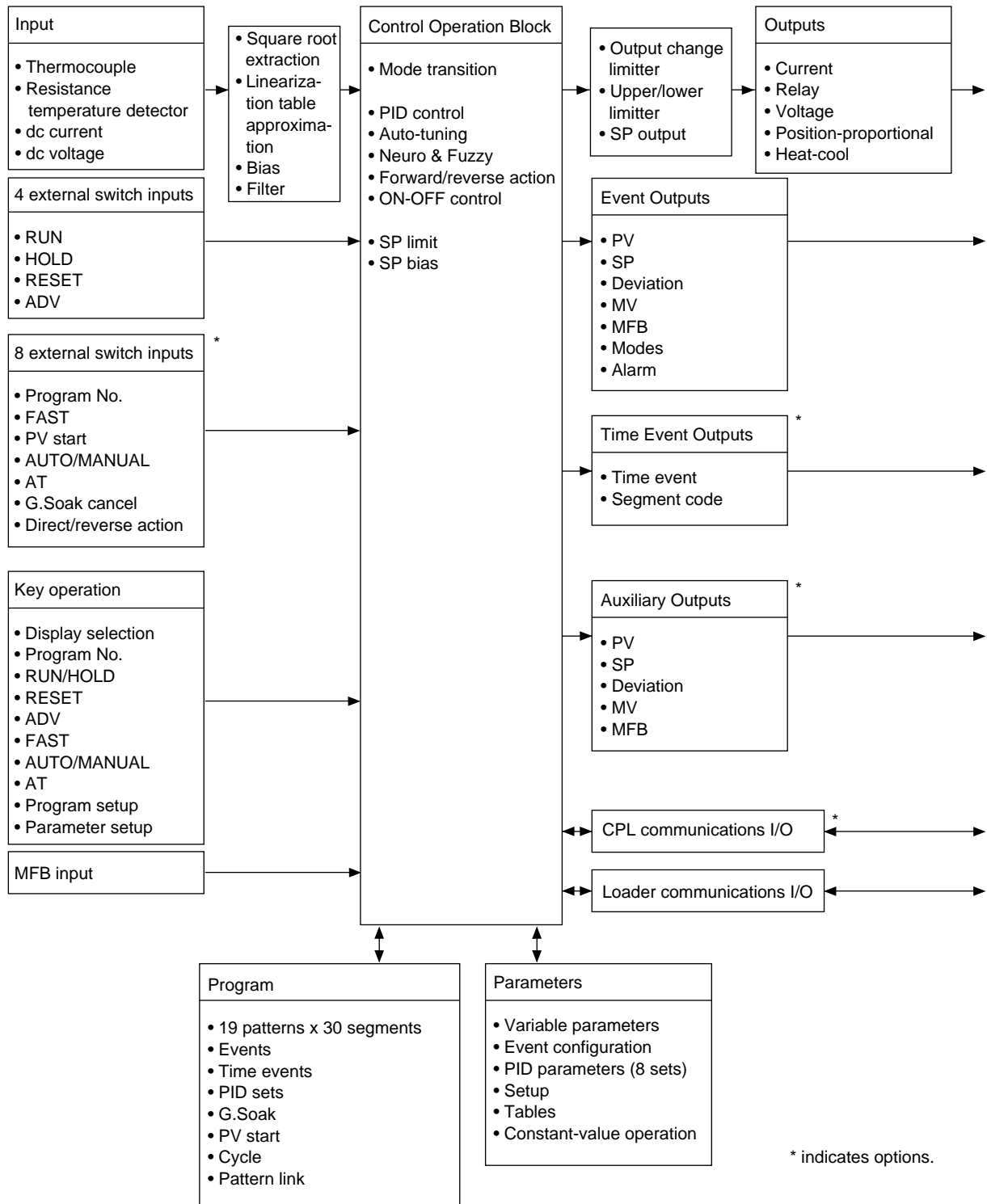

## 1-3 Data Structure

Data is made up of “parameters” that are used mainly for setting controller functions and “programs” that are used for setting operation during program operation of the controller.

- Total of 19 program patterns

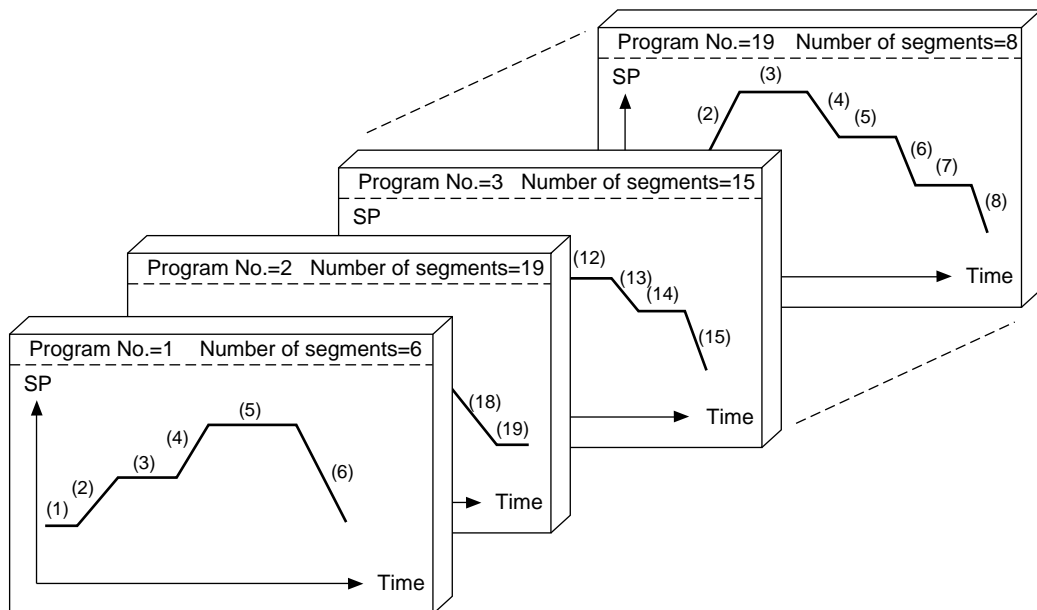

- Parameters

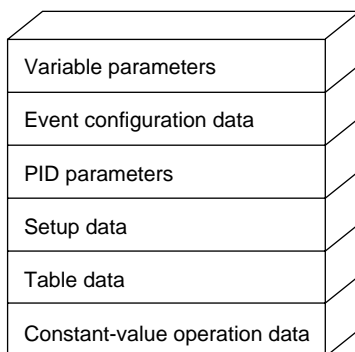



## 1-4 System Configuration

---

### ■ System configuration by CPL communications

On DCP301 models supporting RS-485 communications (optional), controllers can be connected as slave stations on a communications network.

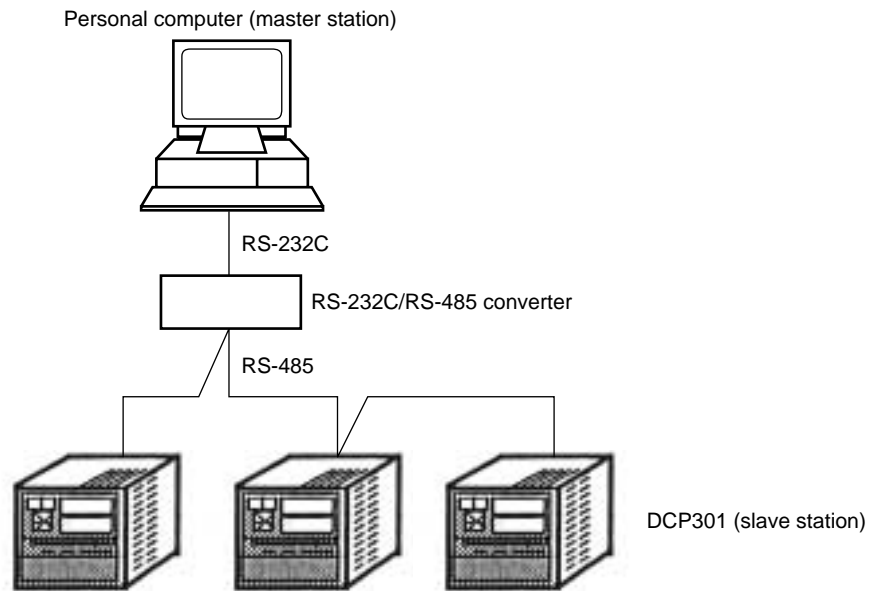

## 1-5 Model Numbers

### ■ Model selection guide

Basic Model No.	Output	Function	Power	Option 1	Option 2	Additions	Description
P301							Digital Program Controller (single-loop model)
	0D						Relay outputs (on-off, or time-proportional)
	2G						Position-proportional output
	5G						Current output (controller/programmer selectable) (changeable to 6D output)
	6D						Voltage output (current value adjustment function supported, on-off, or time-proportional) (changeable to 5D output)
	3D						Heat-cool output, relay output + relay output (PID control or 3-position-proportional)
	5K						Heat-cool output, current output + current output (changeable between current output and voltage output)
		0					One input channel
			ES				Free power supply (90 to 264Vac)
				00			No auxiliary output
				01			1 auxiliary output
				02			2 auxiliary outputs
					0		External switch inputs (4), time events not supported, communications not supported
					1		External switch inputs (12), 5 time events supported, communications not supported
					2		External switch inputs (12), 5 time events supported, RS-485 communications supported
						00	Additional treatment not supported
						T0	Tropical treatment
						K0	Antisulfide treatment
						D0	Inspection Certificate supplied
						B0	Additional treatment + Inspection Certificate provided
						L0	Antisulfide treatment + Inspection Certificate provided
						Y0	Traceability Certificate

### ! Handling Precautions

On 2G, 3D and 5K output models, 2 auxiliary output (option 1) cannot be designated.

# Chapter 2. NAMES & FUNCTIONS OF PARTS

## 2-1 Structure

This controller comprises a body, console, case, standard terminal base and add-on terminal base.

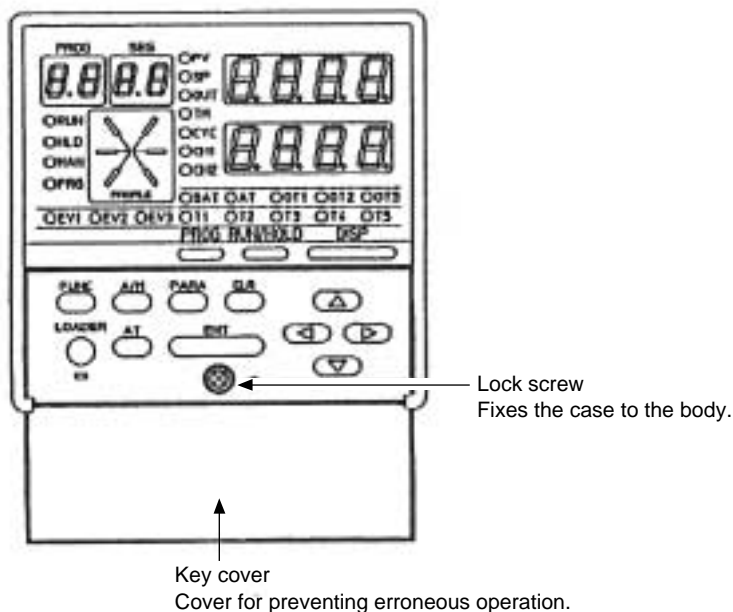
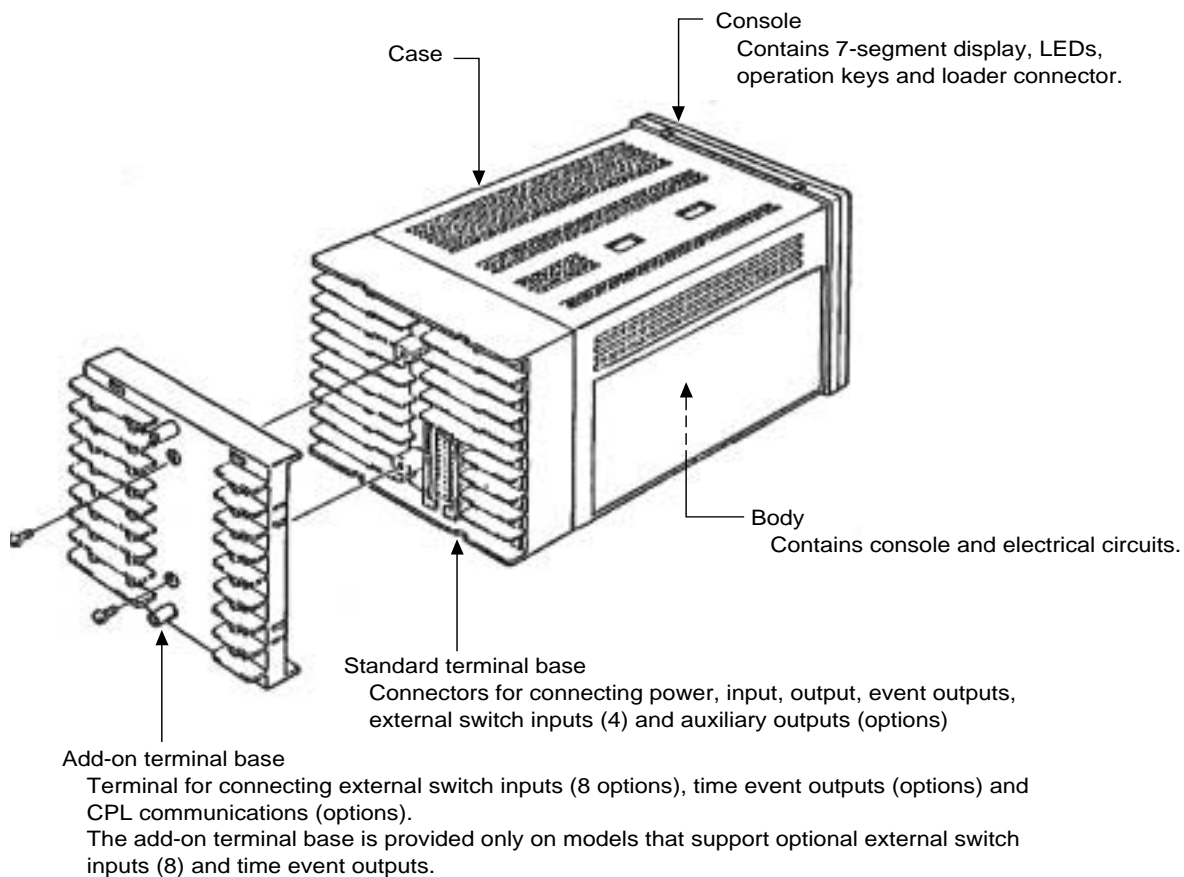

## 2-2 Console

The console comprises keys for operating the controller, displays and LEDs.

### ■ Basic display state

The “basic display state” is the state in which the controller operating state is displayed on the console.

When the power is turned ON, the controller is in this state.

Key operation changes the controller from the basic display state to one of the parameter setup, program setup, program copy or general reset states. Key operation also returns the controller to the basic display state.

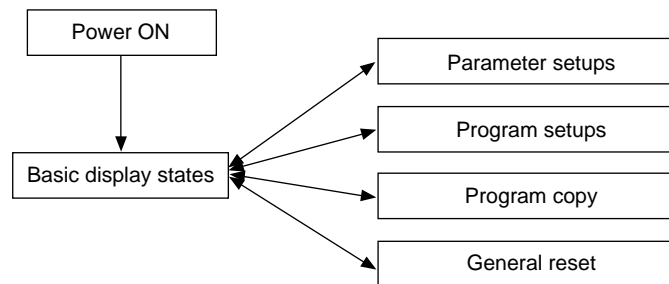

### ■ Display

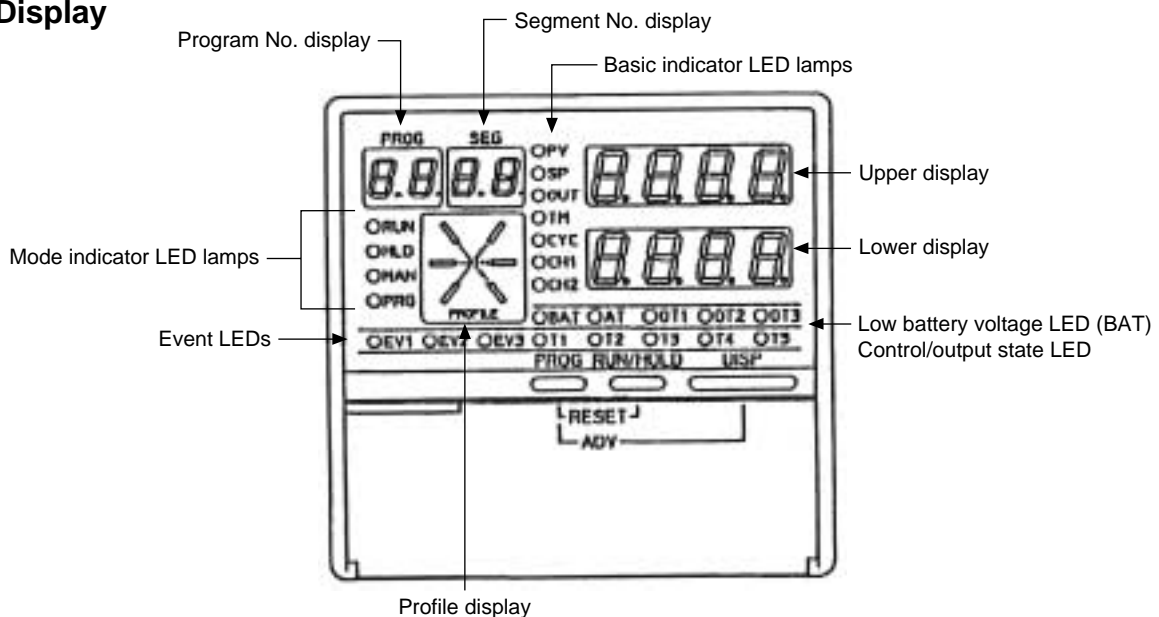

- Program No. display

In the basic display state, this display indicates the currently selected program No. In the program setup state, this display indicates the program No. currently being set up. During constant-value operation, this display goes out in the basic display state. When an alarm occurs in the basic display state, alarm code “ $\overline{H} L$ ” is displayed.

- Segment No. display

In the basic display state, this display indicates the currently selected segment No. In the program setup state, this display indicates the segment No. currently being set up. During constant-value operation, this display goes out in the basic display state. In the parameter setup state, this display indicates the item No. When an alarm occurs in the basic display state, the alarm code No. is displayed.

- Mode indicator LEDs

RUN, HLD: Display the READY, RUN, HOLD, FAST and END modes. (See following table.)

LED \ Mode	READY	RUN	HOLD	FAST	END
RUN	Out	Lit	Out	Blinking	Out
HLD	Out	Out	Lit	Out	Blinking

MAN : Lights in the MANUAL mode, and goes out in the AUTO mode.

PRG : Lights in the program setup state. Otherwise, this LED is out.

- Upper display

In the basic display state, displays PV and other values.

In the parameter setup state, displays the item code.

- Lower display

In the basic display state, displays SP, time, output and other values.

In the parameter setup state, displays the item setting value.

- Low battery voltage LED

BAT: Blinks when the battery voltage is low. Otherwise, this LED is out.

- Control/output state LED

AT: Blinks during auto-tuning, and lights during smart-tuning. Otherwise, this LED is out.

OT1: When relay or voltage are assigned to output 1, lights when output is ON and goes out when output is OFF. In the case of 2G output models, lights when the open-side relay is ON and goes out when the relay is OFF.

Lights when current output is assigned to output 1.

OT2: When relay or voltage are assigned to output 2, lights when output is ON and goes out when output is OFF. In the case of 2G output models, lights when the closed-side relay is ON and goes out when the relay is OFF. Lights when current output is assigned to output 2, and goes out when auxiliary output is assigned to output 2.

OT3: Out

- Basic indicator LEDs

PV: Lights during PV display. Otherwise, this LED is out.

SP: Lights during SP display. Otherwise, this LED is out.

OUT: Lights during output display. Otherwise, this LED is out.

TM: Lights during time display. Otherwise, this LED is out.

CYC: Lights during cycle display. Otherwise, this LED is out.

CH1: Out

CH2: Out

- Event LEDs

EV1, EV2, EV3 : • In the basic display state or parameter setup state, light when each of events 1 to 3 are ON, and go out when OFF.

• In the program setup (programming) state, light when each of the items for events 1 to 3 are displayed. Otherwise, these LEDs are out.

T1, T2, T3, T4, T5 : • Light when each of time events 1 to 5 are ON, and go out when OFF.

• In the program setup (programming) state, light when each of the items for time events 1 to 5 are displayed.

Otherwise, these LEDs are out.

- Profile display

Displays the tendencies (rise, soak, fall) of the program pattern.





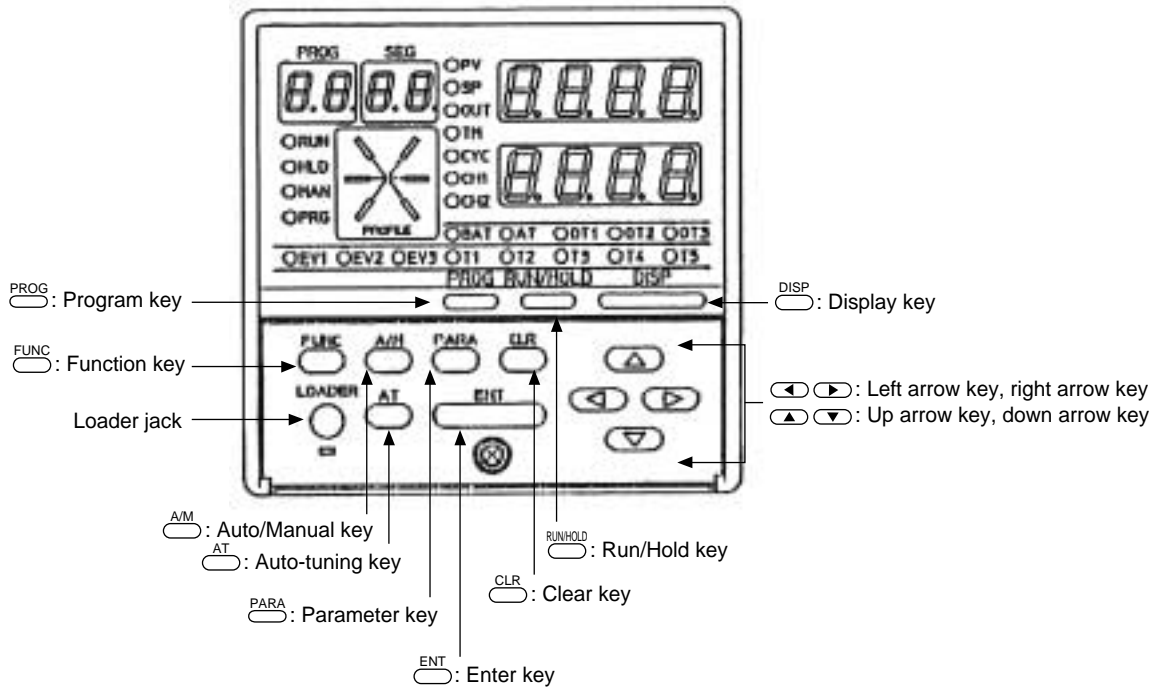





Blinks during G.soak standby, and lights successively after the power is turned ON.

■ Keys



Category	Function	Key operation
Basic display state	To change the display	DISP ⏏
	To change the program No. in ascending order (in READY mode)	PROG ⏏
	To execute running of program (in READY mode)	▶
	To run the program (in READY, HOLD, FAST modes)	RUNHOLD ⏏
	To hold the program (in RUN mode)	
	To reset the program (in READY, HOLD, FAST, END modes)	PROG + RUNHOLD ⏏ + ⏏
	To advance the program (in RUN, HOLD, FAST modes)	PROG + DISP ⏏ + ⏏
	To run the program fast (in RUN, HOLD modes)	FUNC + ▶ ⏏ + ▶
	To execute manual operation (in AUTO mode)	A/M ⏏
	To execute automatic operation (in MANUAL mode)	
	To start auto-tuning (when not executing auto-tuning)	AT ⏏
	To cancel auto-tuning (when executing auto-tuning)	
	To change values during manual operation (when MV or SP is blinking)	▲ ▼ ◀ ▶ ▲ ▼ ◀ ▶

Category	Function	Key operation
<b>Parameter setup</b>	Starts parameter setup. So the controller enters selection of setup group (major item). (in basic display state)	FUNC + PARA
	To change the setup group (major item)	PARA ▲ ▼
	To fix the setup group	ENT
	To moves between individual items (minor items)	▲ ▼ ◀ ▶
	To start changing individual item setting values (while setting value is blinking)	ENT
	To end changing individual item setting values (while setting value is blinking)	
	To change individual item setting values (while setting value is blinking)	▲ ▼ ◀ ▶
	To cancel changing individual item setting values (in basic display state)	PARA
	To selects setup group	
	To end parameter setup	DISP
<b>PARA key Assignment item setup</b>	To start changing assignment item setting values (in basic display state)	PARA
	To move to next item by assignment item, and start changing setting values	
	To change assignment item setting values (while setting value is blinking)	▲ ▼ ◀ ▶
	To end changing assignment item setting values (while setting value is blinking)	ENT
	To start changing assignment item setting values	
	To end assignment item setup	DISP
<b>Program setup</b>	To start program setup (programming) (in basic display state)	FUNC + PROG
	To move between program items and segment Nos.	▲ ▼ ◀ ▶
	To start changing item setting values (while setting value is blinking)	ENT
	To end changing item setting values (while setting value is blinking)	
	To change item setting values (while setting value is blinking)	▲ ▼ ◀ ▶
	To clear item setting (while setting value is blinking)	FUNC + CLR
	To cancel changing item setting values (while setting value is blinking)	DISP
	To insert/delete segments	FUNC + ENT
	To change the program No. in ascending order	FUNC + PROG
	To change the program No. in descending order	FUNC + ▼
	To end program setup (programming)	DISP













































Category	Function	Key operation
<b>Program copy</b>	To start program copy (in basic display state)	 + 
	To change the copy destination program No.	 
	To execute program copy (while setting value is blinking)	
	To end program copy	
<b>General reset</b>	To check general reset (in basic display state)	 +  + 
	To execute general reset	
	To cancel general reset	

### Handling Precautions

Do not operate the console keys using a sharp-pointed object such as a propelling pencil or needle. Doing so might damage the console.



## ■ Functions using two or more keys

-  +  : Reset keys  
Press  with  held down in the basic display state to reset the controller.  
The controller enters the READY mode in the RUN, HOLD, FAST or END modes.  
The controller cannot be reset in the READY mode by key operation.
-  +  : Advance keys  
Press  with  held down in the program operation mode in the basic display state to advance the program.  
In the RUN, HOLD or FAST modes, the program advances to the next segment.  
The controller cannot advance in the READY mode by key operation.
-  +  : Fast keys  
Press  with  held down in the program operation mode in the basic display state to fast-operate the program.  
The controller enters the FAST mode from the RUN or HOLD modes.
-  +  : Parameter setup keys  
Press  with  held down in the basic display state to move to selection of the setting group (major items) in the parameter setup state.
-  +  : Program setup (programming) keys  
Press  with  held down in the program operation mode in the basic display state to move to the program setup (programming) state.  
Press  with  held down in the program setup state to change the No. of the program to be set up in ascending order.
-  +  : Program No. change keys  
Press  with  held down in the program setup state to change the No. of the program to be set up in descending order.
-  +  : Program item delete keys  
Press  with  held down during entry of settings in the program setup state to clear the setting.
-  +  : Segment insert/delete keys  
Press  with  held down at SP or time item in the program setup state to move to the segment insert/delete screen.
-  +  : Program copy keys  
Press  with  held down in the program operation READY mode in the basic display state to move to the program copy screen.
-  +  +  : General reset keys  
Press  and  with  held down in the READY AUTO mode in the basic display state to move to the general reset confirmation screen.

## ■ Loader jack

This jack is for connecting the loader. Objects other than the loader plug should not be inserted into this jack.

The loader jack is not isolated from internal digital circuits.

Be sure to cap the loader jack when it is not in use.

## 2-3 Input Type and Range No.

### ■ Inputs

#### ● Thermocouple

Input Format	Range No.	Code	Temp. Range (°C)	Temp. Range (°F)
K (CA)	0	K09	0 to 1200	0 to 2400
K (CA)	1	K08	0.0 to 800.0	0 to 1600
K (CA)	2	K04	0.0 to 400.0	0 to 750
K (CA)	3	K29	-200 to 1200	-300 to 2400
K (CA)	4	K44	-200.0 to 300.0	-300 to 700
K (CA)	5	K46	-200.0 to 200.0	-300 to 400
E (CRC)	6	E08	0.0 to 800.0	0 to 1800
J (IC)	7	J08	0.0 to 800.0	0 to 1600
T (CC)	8	T44	-200.0 to 300.0	-300 to 700
B (PR30-6)	9	B18	0 to 1800	0 to 3300
R (PR13)	10	R16	0 to 1600	0 to 3100
S (PR10)	11	S16	0 to 1600	0 to 3100
W (WRe5-26)	12	W23	0 to 2300	0 to 4200
W (WRe5-26)	13	W14	0 to 1400	0 to 2552
PR40-20	14	D19	0 to 1900	0 to 3400
Ni-Ni-Mo	15	Z13	0 to 1300	32 to 2372
N	16	U13	0 to 1300	32 to 2372
PL II	17	Y13	0 to 1300	32 to 2372
DIN U	18	Z08	-200.0 to +400.0	-300 to +750
DIN L	19	Z07	-200.0 to +800.0	-300 to +1600
Golden iron chromel	20	Z06	0.0 to +300.0K	—

#### ● Resistance temperature detector (RTD)

Input Format	Range No.	Code	Temp. Range (°C)	Temp. Range (°F)
JIS'89 Pt100 (IEC Pt100Ω)	32	F50	-200.0 to 500.0	-300 to 900
	33	F46	-200.0 to 200.0	-300 to 400
	34	F32	-100.0 to 150.0	-150.0 to 300.0
	35	F36	-50.0 to 200.0	-50.0 to 400.0
	36	F38	-60.0 to 40.0	-76.0 to 104.0
	37	F33	-40.0 to 60.0	-40.0 to 140.0
	38	F05	0.0 to 500.0	0.0 to 900.0
	39	F03	0.0 to 300.0	0.0 to 500.0
	40	F01	0.00 to 100.00	0.0 to 200.0
JIS'89 J Pt100	48	P50	-200.0 to 500.0	-300 to 900
	49	P46	-200.0 to 200.0	-300 to 400
	50	P32	-100.0 to 150.0	-150.0 to 300.0
	51	P36	-50.0 to 200.0	-50.0 to 400.0
	52	P38	-60.0 to 40.0	-76.0 to 104.0
	53	P33	-40.0 to 60.0	-40.0 to 140.0
	54	P05	0.0 to 500.0	0.0 to 900.0
	55	P03	0.0 to 300.0	0.0 to 500.0
56	P01	0.00 to 100.00	0.0 to 200.0	

● dc current, dc voltage

Input Format	Range No.	Code	Range (programmable)
4 to 20mA	64	C01	-1999 to 9999
0 to 20mA	65	C08	
0 to 10mA	66	M01	
-10 to +10mV	67	L02	
0 to 100mV	68	L01	
0 to 1V	69	L04	
-1 to +1V	70	L08	
1 to 5V	71	V01	
0 to 5V	72	L05	
0 to 10V	73	L07	

 **Handling Precautions**

- The unit of code Z06 is Kelvin (K)
- The lower limit readout of code B18 is 20°C (68°F).  
The lower limit readout (°C) of codes K44, K46, T44, Z08 and Z07 is -199.9°C.
- The lower limit readout (°C) of codes F50, F46, P50 and P46 is -199.9°C.
- The upper limit readout (°C) of codes F01 and P01.
- The PV lower limit alarm does not occur with code F50.  
However, note that the PV lower limit alarm occurs at a disconnection when input has been downscaled when input is disconnected during setup.
- The number of digits past the decimal point for dc current and dc voltage is programmable within the range 0 to 3.

# Chapter 3. MOUNTING

## 3-1 External Dimensions

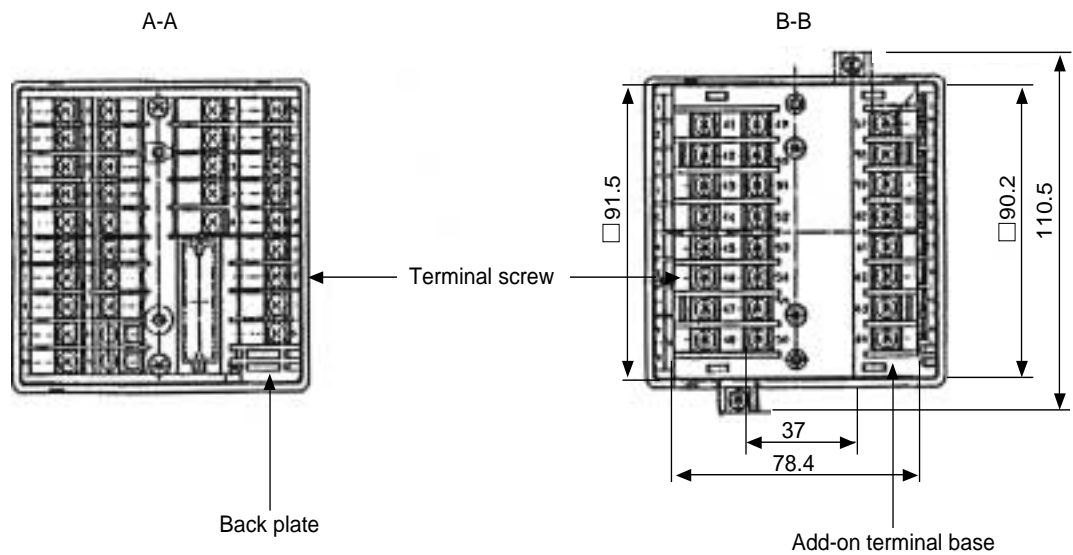
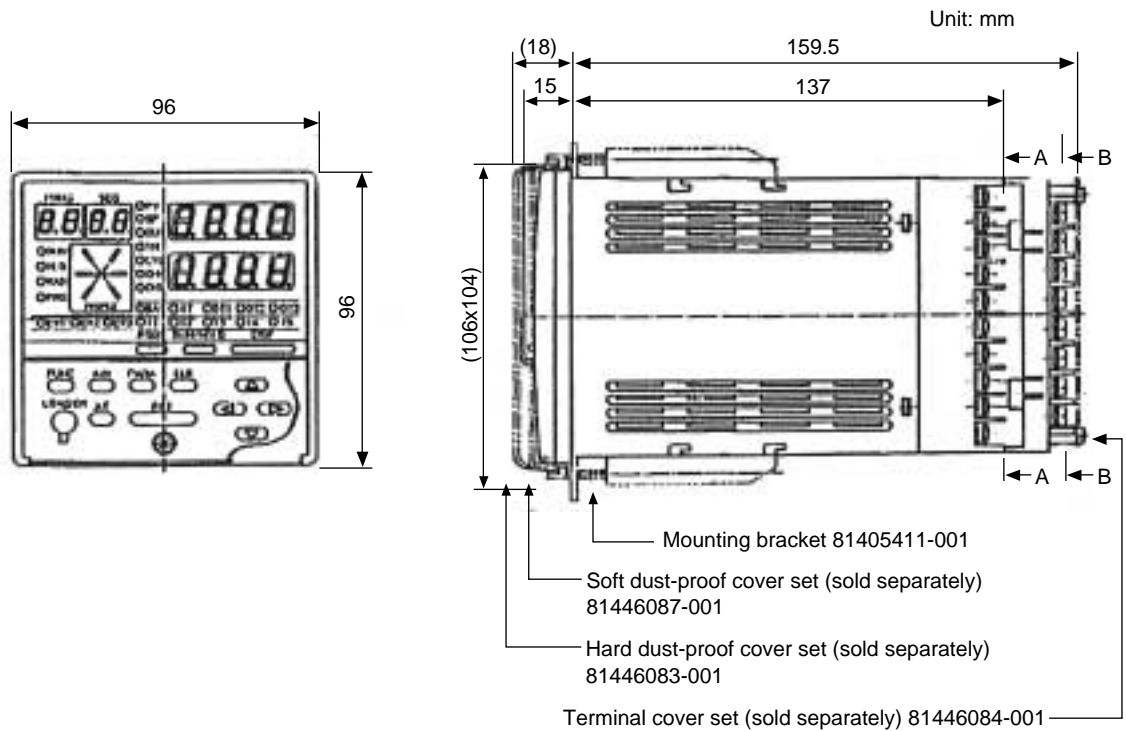

## 3-2 Panel Cutout Dimensions

Use a steel panel of at least 2mm in thickness for mounting the controller.

Unit: mm

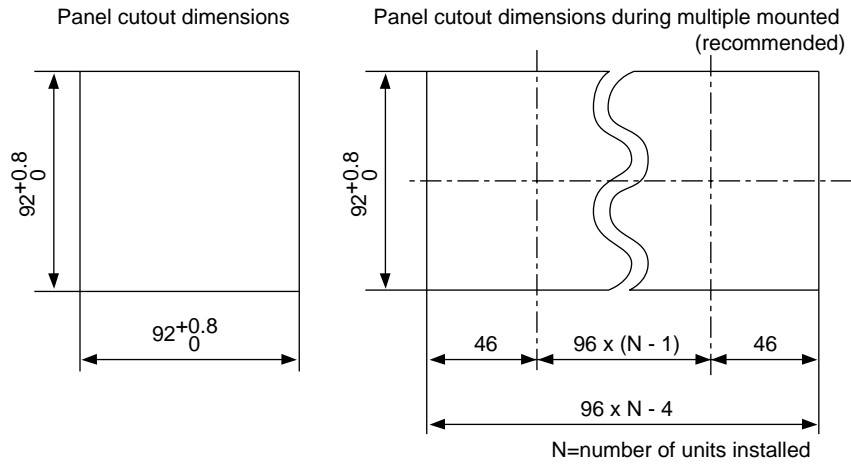

Panel cutout dimensions when mounting units horizontally and vertically (recommended)

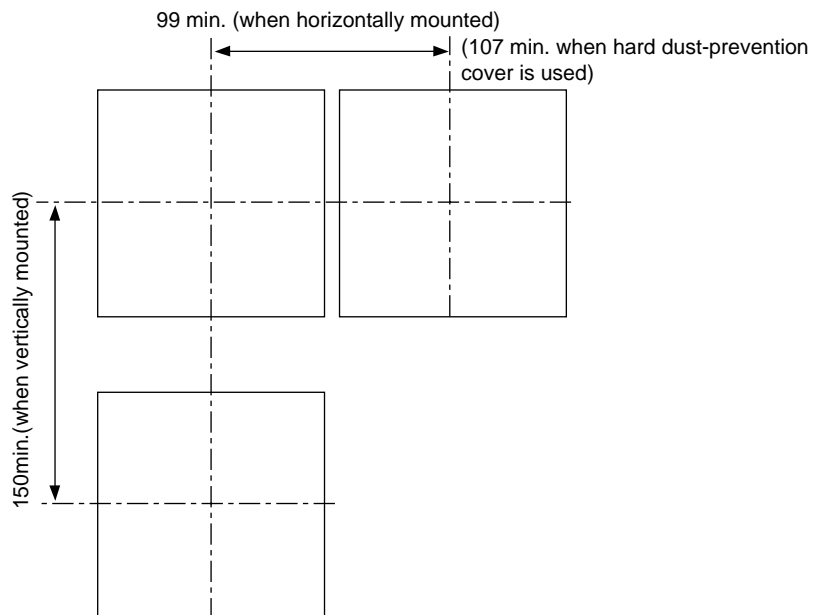

### ! Handling Precautions

When mounting the controller, take care to prevent the temperature at the lower surface of the controller's case from exceeding the operating temperature range (0 to 50°C), particularly when mounting vertically or during multiple mounting.

## 3-3 Mounting

### **WARNING**



Before wiring, or removing/mounting the DCP301, be sure to turn the power OFF. Failure to do so might cause electric shock.



Do not disassemble the DCP301. Doing so might cause electric shock or faulty operation.

### **CAUTION**



Use the DCP301 within the operating ranges recommended in the specifications (temperature, humidity, voltage, vibration, shock, mounting direction, atmosphere, etc.). Failure to do so might cause fire or faulty operation.



Do not block ventilation holes. Doing so might cause fire or faulty operation.



Do not allow lead clippings, chips or water to enter the controller case. Doing so might cause fire or faulty operation.

### ■ Mounting locations

Avoid installing the DCP301 in the following locations:

- Locations outside of the operating temperature range (0 to 50°C) and operating humidity range (10 to 90%RH)
- Locations subject to sulfide gas or other flammable gases
- Locations subject to dust or oil smoke
- Locations subject to the direction sunlight, wind or rain
- Locations that directly subject the body to vibration or impact
- Locations under high-voltage lines, near welders or near sources of electrical noise
- Locations near (within 15m) of high-voltage ignition equipment such as boilers
- Locations where magnetic fields are generated
- Locations subject to flammable liquids or moisture

### ■ Noise generating sources and countermeasures

- Generally, the following generate electrical noise:
  - (1) Relays and contacts
  - (2) Solenoid coils, solenoid valves
  - (3) Power lines (in particular, 90Vac min.)
  - (4) Induction loads
  - (5) Inverters
  - (6) Motor commutators
  - (7) Phase angle control SCR
  - (8) Wireless communications equipment
  - (9) Welding equipment
  - (10) High-voltage ignition equipment
  
- If the influence of electrical noise cannot be eliminated, we recommend taking the following countermeasures:
  - Provision of a CR filters for fast-rising noise  
Recommended CR filter: Model No. 81446365-001
  - Provision of a varister for noise with a high wave height  
Recommended varister: Model No. 81446366-001 (100V)  
81446367-001 (200V)

### Handling Precautions

The varister may become short-circuited when trouble occurs. Pay attention to this when providing a varister on a controller.

### ■ Dust-proof cover

Use the dust-proof cover when using the controller in a dusty or dirty location, and to prevent inadvertent operation.

Two dust proof-covers are provided, hard or soft, each with the following differing functions.

Type	Confirmation on Display	Operation
Hard	○	x
Soft	○	○

○ indicates that a function can be used.

## ■ Mounting method

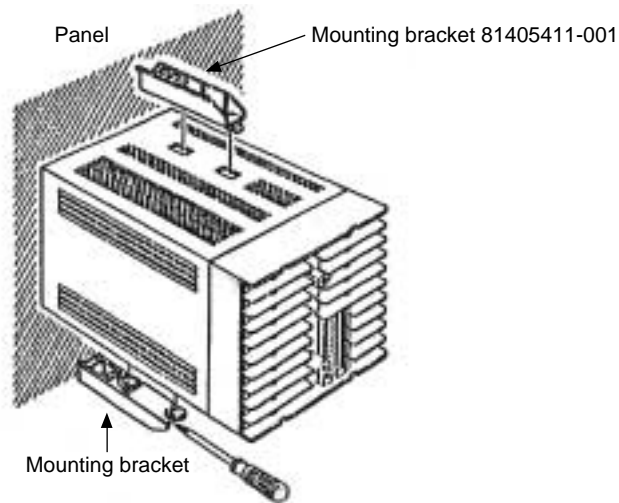

- Firmly secure the top and bottom of the controller by the mounting brackets.
- When mounting the controller, secure by lower mounting bracket (1) first.

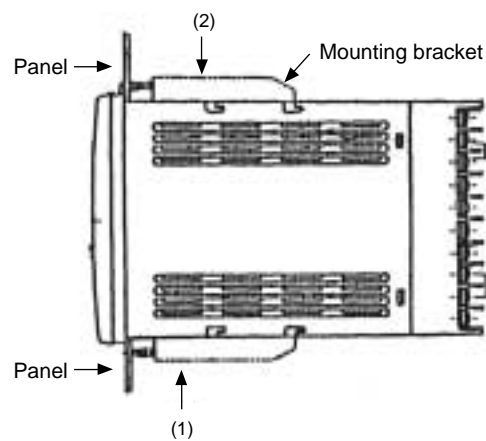

### ⚠ Handling Precautions

To secure the controller, tighten the screw on the mounting bracket (supplied) until there is no more play and then tighten a further full turn. Take care not to overtighten the screw. Doing so might deform the case.

- Keep the mounting angle to within  $10^\circ$  from the horizontal at both the controller rear top and bottom.

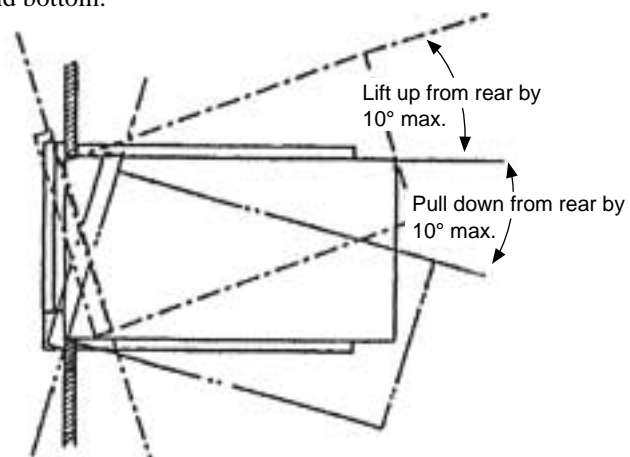



# Chapter 4. WIRING

## 4-1 Wiring Precautions

### **WARNING**



Before connecting the DCP301 to the measurement target or external control circuits, make sure that the FG terminal is properly grounded (100Ω max.).

Failure to do so might cause electric shock or fire.



Before wiring, or removing/mounting the DCP301, be sure to turn the power OFF. Failure to do so might cause electric shock.



Do not touch electrically charged parts such as the power terminals. Doing so might cause electric shock.

### **CAUTION**



Wire the DCP301 properly according to predetermined standards. Also wire the DCP301 using designed power leads according to recognized installation methods.

Failure to do so might cause electric shock, fire or faulty operation.



Do not allow lead clippings, chips or water to enter the DCP301 case. Doing so might cause fire or faulty operation.



Inputs to the current input terminals (31) and (33) on the DCP301 should be within the current and voltage ranges listed in the specifications. Failure to do so might cause electric shock or faulty operation.



Firmly tighten the terminal screws at the torque listed in the specifications. Insufficient tightening of terminal screws might cause electric shock or fire.



Do not use unused terminals on the DCP301 as relay terminals. Failure to do so might cause electric shock, fire or faulty operation.



We recommend attaching the terminal cover (sold separately) after wiring the DCP301. Failure to do so might cause electric shock, fire or faulty operation.



Use the relays on the DCP301 within the service life listed in the specifications. Continued use of the relays after the recommended service life might cause fire or faulty operation.



Use induced lightning surge preventive device if there is the risk of power surges caused by lightning. Failure to do might cause fire or faulty operation.

---

## **!** Handling Precautions

- Before wiring the DCP301, check the controller catalog No. and terminal Nos. on the label on the rear of the body. After wiring the DCP301, be sure to check the wiring for any mistakes.
- Maintain a distance of at least 50cm between I/O leads or communications leads and the power lead. Also, do not pass these leads through the same piping or wiring duct.
- When wiring with crimped terminals, take care to prevent contact with adjacent terminals.
- When connecting the DCP301's thermocouples in parallel to other controllers, make sure that the total input impedance of the other controller is at least 1M $\Omega$ .

If the input impedance is less than 1M $\Omega$ , the DCP301 may not be able to detect sensor disconnection.

- When inputting the DCP301's I/O (parallel connection in case of input) to an A/D converter or analog scanner, read data may fluctuate.

To prevent this, adopt one of the following measures.

- (1) Use a low-speed, integrating type A/D converter.
- (2) Insert an isolator without a switching power supply between the DCP301 and A/D converter.
- (3) Average data on a personal computer when reading data.
- (4) If possible, set a filter for the input.

- Provide the wiring for the instrument power supply with a mains power shutoff switch within reach of the instrument operator.
- Provide the wiring for the instrument power supply with a delayed operation type (T) 1A current rating, 250V voltage rating fuse. (IEC 127)
- Devices and systems to be connected to this unit must have the basic insulation sufficient to withstand the maximum operating voltage levels of the power supply and input/output parts.

## 4-2 Compensating Lead

In the case of thermocouple input, connect the bare thermocouple lead to the terminal. If the thermocouple is located a long way from the DCP301 or the thermocouple is connected to a terminal, extend the connection using a compensating lead and then connect to the terminal. Use shielded compensating leads only.

- For I/O other than thermocouples, use JCS-364 shielded instrument polyethylene insulated vinyl sheath cable or equivalent product. (This is generally referred to “twisted shielded cable for instruments.”) The following cables are recommended.

<b>Fujikura Ltd.</b>	2-core	IPEV-S-0.9mm <sup>2</sup> x 1P
	3-core	ITEV-S-0.9mm <sup>2</sup> x 1T
<b>Hitachi Cable Co.</b>	2-core	KPEV 0.9mm <sup>2</sup> x 1P
	3-core	KTEV-S-0.9mm <sup>2</sup> x 1T

- Shielded, multi-core microphone cord (MVVS) can be used if there is little electromagnetic induction.

## 4-3 Terminal Connections

---

Use crimped terminals that fit onto M3.5 screws.

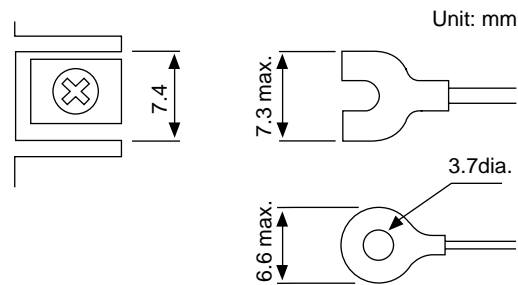

### ! Handling Precautions

- When installing the DCP301 in locations subject to vibration or impact, be sure to use round crimped terminals to prevent the lead from coming loose from the terminal.
- When wiring with crimped terminals, take care to prevent contact with adjacent terminals.
- The recommended tightening torque for the terminal screws is 0.78 to 0.98N•m.

## 4-4 Layout of Terminals and Recommended Lead Draw-out Direction

Wiring is carried out on the standard terminal base or add-on terminal base. The following diagram shows the recommended draw-out directions for the leads on the standard terminal base.

The lead draw-out directions are the same when using the add-on terminal base.

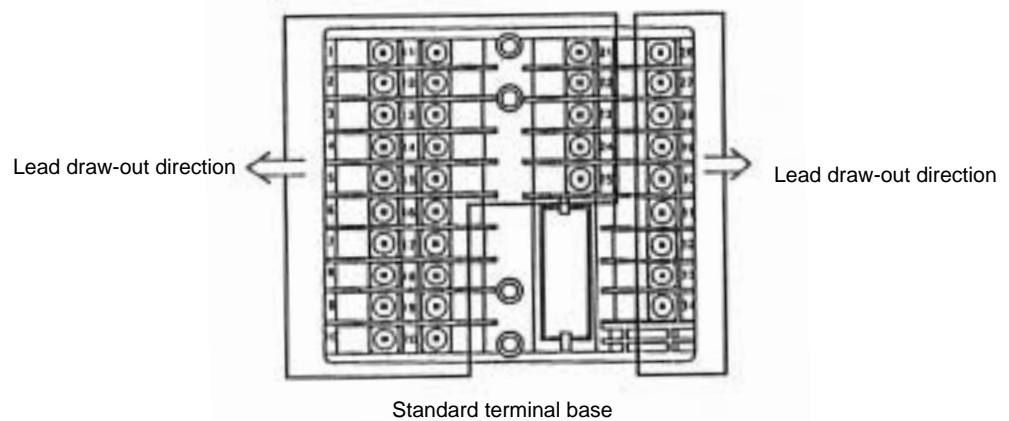
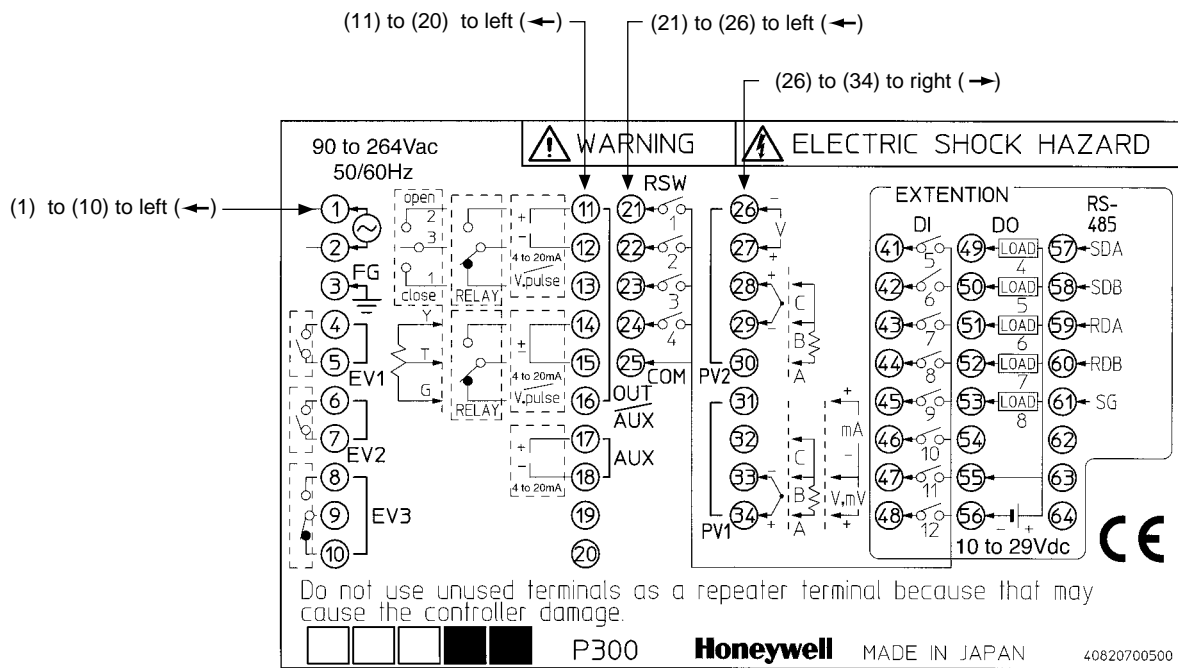

## 4-5 Connecting the Ground and Power Supply

### ■ Power supply

Connect the DCP301 to a single-phase power supply for controllers, and take measures to prevent the influence of electrical noise.

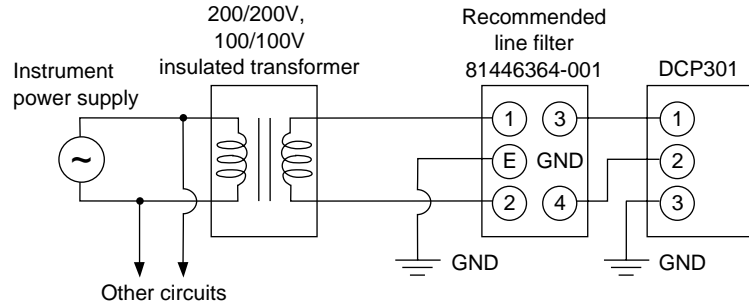

### ! Handling Precautions

- If the power supply generates a lot of electrical noise, we recommend inserting an insulating transformer in the power circuit and using a line filter.

Recommended line filter: Model No. 81446364-001

- After providing anti-noise measures, do not bundle primary and secondary power leads together, or pass them through the same piping or wiring duct.

### ■ Ground

When it is difficult to ground shielded cable, prepare a separate ground terminal (earth bar).

Ground type: 100Ω max.

Ground cable: 2mm sq. min soft-copper wire (AWG14)

Cable length: Max. 20m

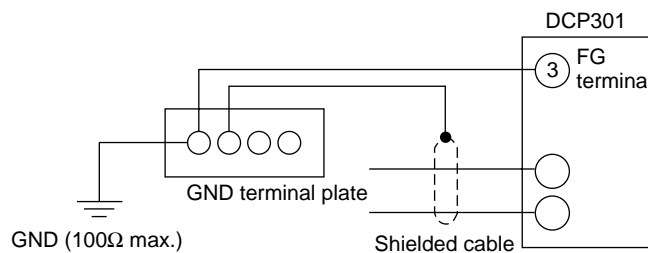

### ! Handling Precautions

Use only the FG terminal (3) on the DCP301 for grounding. Do not ground across other terminals.

## 4-6 Wiring of Standard and Add-on Terminal Base

### Standard terminal layout

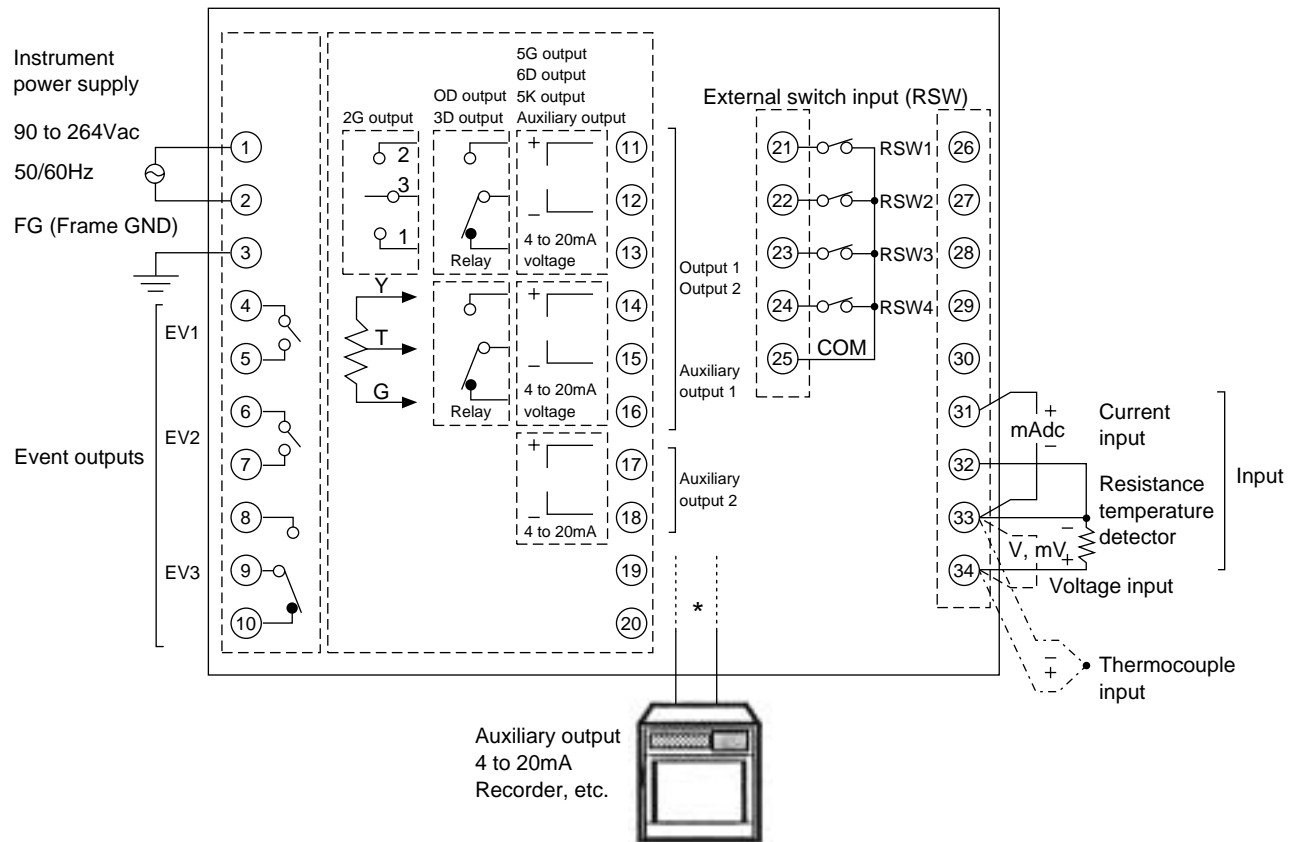

\* On 2G, 3D or 5K models, (17) and (18) are the auxiliary outputs.

On 0D, 5G or 6D models, (14) and (15), and (17) and (18) are the auxiliary outputs.

### Add-on terminal layout

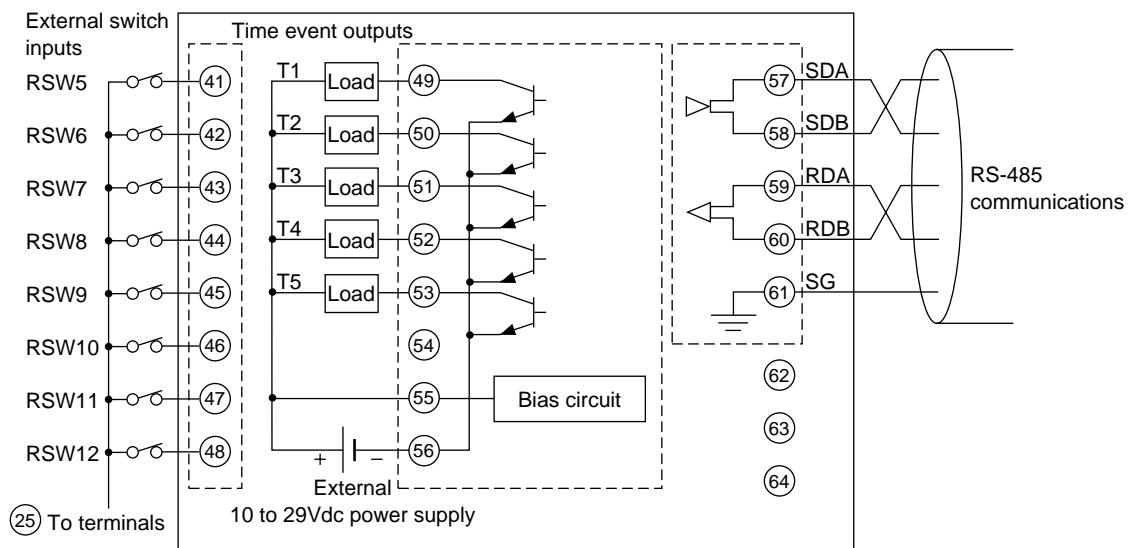

## 4-7 Connecting Inputs (analog inputs)

### ■ Connecting input 1

Multiple input 1 supports various sensor inputs. Connect as follows according to the sensor being used.

#### • Thermocouple input

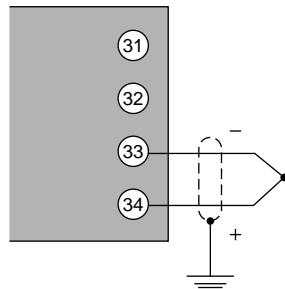

#### • RTD input

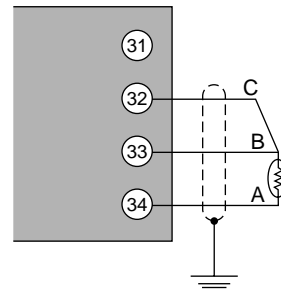

#### • dc voltage input

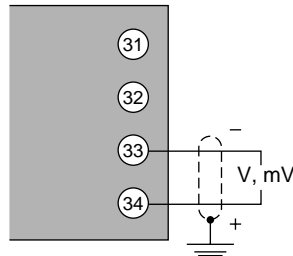

#### • dc current input

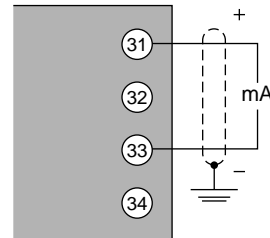

### ! Handling Precautions

- Applying voltage across dc current input terminals (31) and (33) may cause faulty operation.
- Take care of polarities (+,-) when wiring inputs.
- Use only shielded cable for wiring inputs.
- When using a thermocouple input, prevent air blasts from coming into contact with the terminal. Doing so might cause a reading error.



## 4-8 Connecting control outputs (outputs 1, 2)

### ! WARNING



Before wiring, or removing/mounting the DCP301, be sure to turn the power OFF. Failure to do so might cause electric shock.

#### ■ Relay output (0D)

Connect as follows.

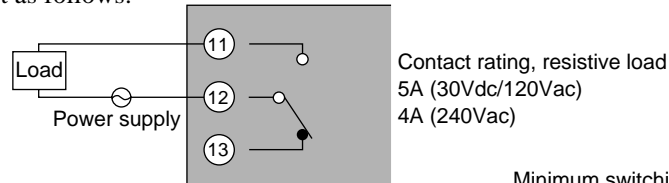

#### ! Handling Precautions

When switching small currents, connect a bleeder resistor to allow current flow of the minimum relay switching input (100mA min.).

#### ■ Current output (5G)

Connect as follows.

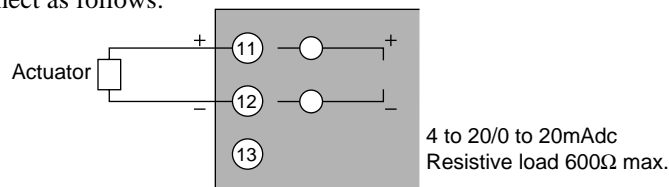

#### ! Handling Precautions

4 to 20mA dc and 0 to 20mA dc can be selected in setup data  $\zeta 9 \text{ 0}$ .

#### ■ Position-proportional output (2G)

Connect as follows paying attention to the switching direction.

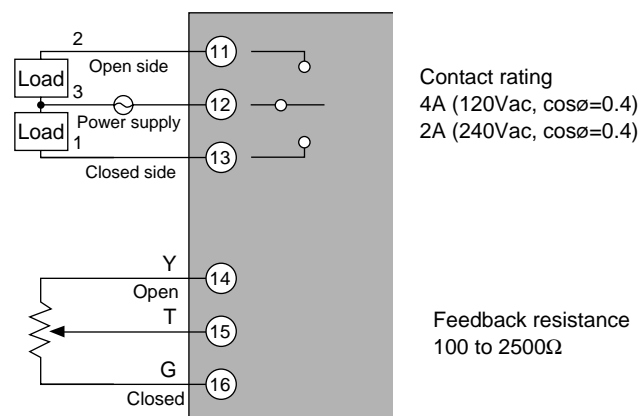

#### ! Handling Precautions

- The life of internal relays is limited. Avoid setting the PID constant in such a way that results in excessive repeated ON/OFF switching.
- When using a 100/200Vac motor, pay attention to rush current and the contact rating. If necessary, provide an external auxiliary relay.
- Separate the wiring for motor terminals (11) (12) (13) and feedback resistor terminals (14) (15) (16).  
(Do not wire the leads in the same duct or use 6-core cable. Doing so might result in faulty controller operation caused by electrical noise when the motor is started up.)
- When controlling without motor feedback with variable parameter  $\tilde{n}$ ,  $\zeta$  set to "2", terminals (14) (15) (16) need not be connected.

### ■ Voltage output (6D)

Connect as follows.

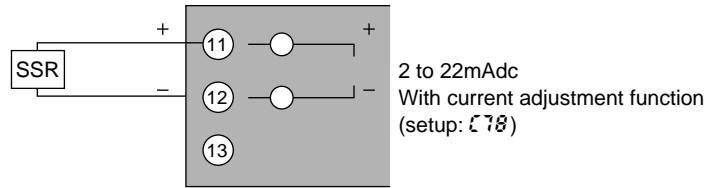

#### ! Handling Precautions

Voltage output is reliant on an internal fixed-current circuit.

Set the current value in the setup data so that the optimum voltage is obtained matched to the conditions of the SSR in use and load.

Factory setting: general-purpose SSR voltage value.

### ■ Heat/cool output (3D)

Connect as follows.

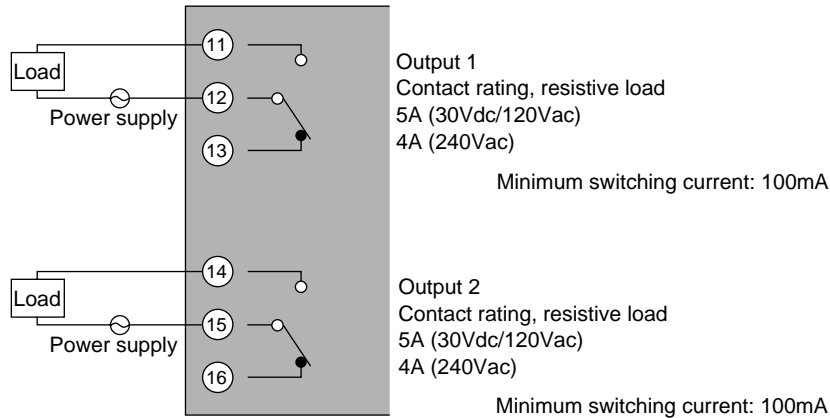

#### ! Handling Precautions

When switching small currents, connect a bleeder resistor to allow current flow of the minimum relay switching input (100mA min.).

### ■ Heat/cool output (5K)

Connect as follows.

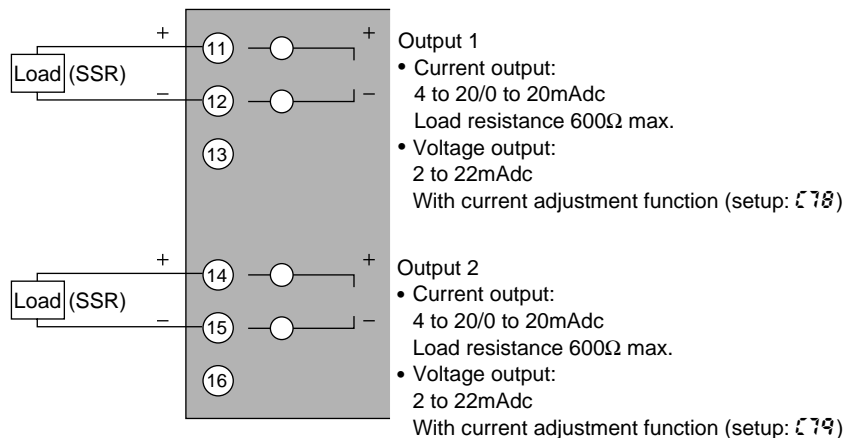

#### ! Handling Precautions

Current output and voltage output can be selected by setups 75 and 76.

Voltage output is reliant on an internal fixed-current circuit.

Set the current value in the setup data so that the optimum voltage is obtained matched to the conditions of the SSR in use and load.

Factory setting: general-purpose SSR voltage value.

## 4-9 Connecting auxiliary outputs (outputs 2, 3)

Optional auxiliary outputs can be added on.

### WARNING



Before wiring, or removing/mounting the DCP301, be sure to turn the power OFF. Failure to do so might cause electric shock.

#### ■ 0D, 5G, 6D auxiliary outputs

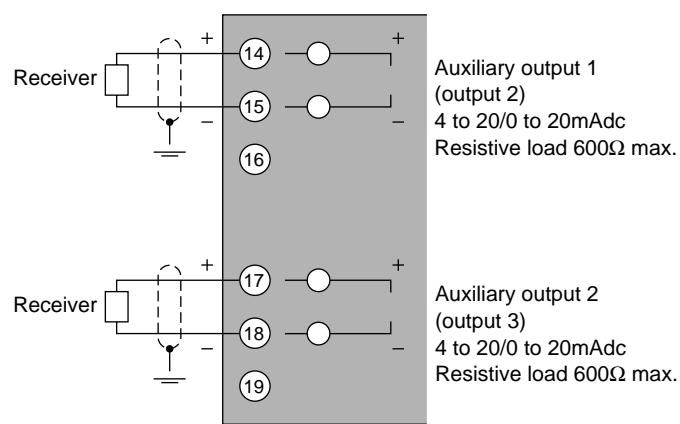

#### Handling Precautions

- 4 to 20mA dc and 0 to 20mA dc can be selected in setup data  $\zeta 90$ .
- Use shielded cable only.

#### ■ 2G, 3D, 5K auxiliary outputs

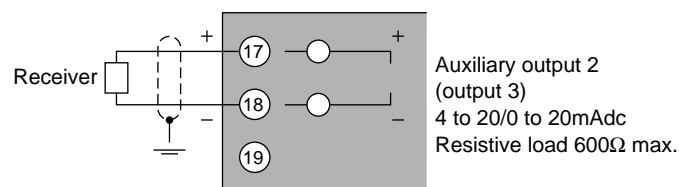

Auxiliary output 1 is not provided for 2G, 3D and 5K outputs.

#### Handling Precautions

- 4 to 20mA dc and 0 to 20mA dc can be selected in setup data  $\zeta 90$ .
- Use shielded cable only.

## 4-10 Connecting Event Output (relay output)

Event outputs EV1 and EV2 are 1a contact, and event output EV3 is 1a1b. Event outputs are connected on the standard terminal base.

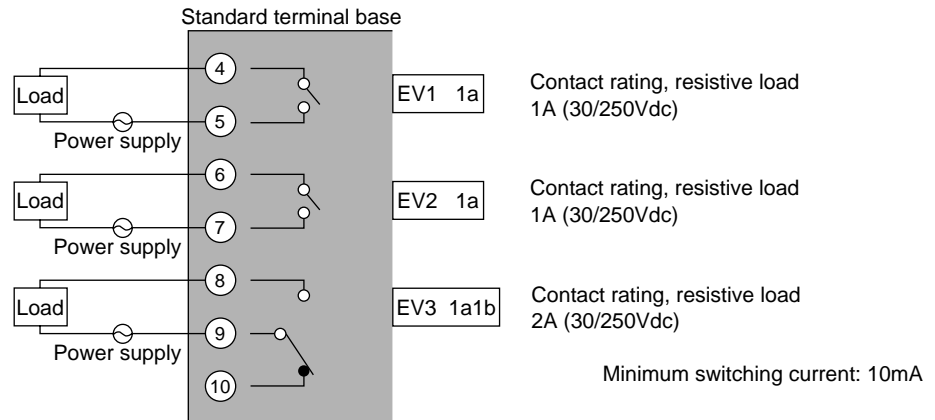

### ⚠ Handling Precautions

When switching small currents, connect a bleeder resistor to allow current flow of the minimum relay switching input (10mA min.).

## 4-11 Connecting Time Event Output (open-collector)

Optional time event outputs T1 to T5 (open-collector outputs) can be added on. Time event outputs are connected on the add-on terminal base.

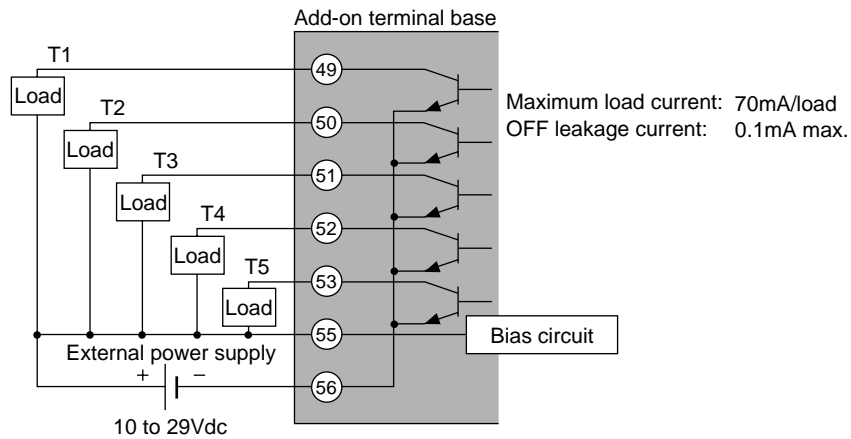

### ! Handling Precautions

- Be sure to connect terminal (55) to the + terminal of the external power supply. Otherwise, open-collector output will not function.
- Do not short-circuit the + terminal of the external power supply and terminals (49) to (53) on the DCP301. Doing so will cause faulty open-collector output. (The DCP301 does not contain a short-circuit prevention circuit.)
- When connecting to a semiconductor load such as a programmable controller (sequencer), select a module whose current directions are matching. Use a module that does not operate by leakage current when the open-collector output of the DCP301 is OFF.

## 4-12 Connecting External Switch (RSW) Input

The DCP301 is provided with four external switch inputs as standard (eight optional). The optional eight inputs are located on the add-on terminal base. Wire the external switch inputs across the standard and add-on terminal bases.

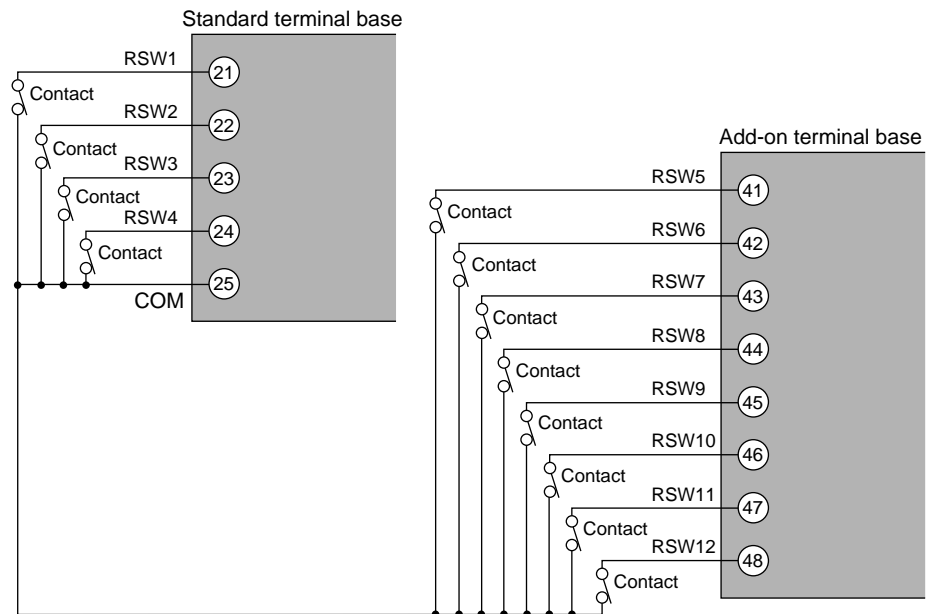

### ! Handling Precautions

- The external switch inputs on the DCP301 have built-in power supplies (open voltage 12Vdc). Be sure to use no-voltage contacts for external contacts.
- Use no-voltage contacts such as gold contacts whose small current can be switched ON/OFF. On some relay contacts, the small current cannot be switched ON/OFF. Use no-voltage contacts having a sufficient minimum switching capability with respect to the contact current and open voltage of the DCP301.
- When using a semiconductor (e.g. open-collector) as a no-voltage contact, use a semiconductor whose contact terminal voltages at contact ON are 3V max., and whose leakage current at contact OFF is 0.1mA.
- External switch inputs on the DCP301/302 can be connected in parallel.

When connecting in parallel with other controllers, thoroughly check the conditions of the other controller before configuring the control system.

● Internal circuit for controller components for connecting external switch inputs

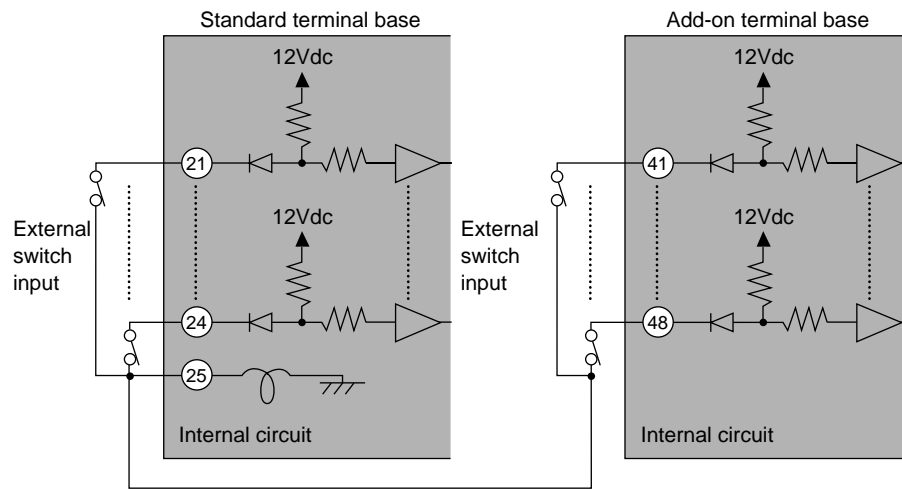

## 4-13 Connecting for Communications

Some controller models support the RS-485 communications interface. Select the RS-485 communications models by selected the required catalog No.

Connect as follows.

### Handling Precautions

The DCP301 operates as a slave station.

### ■ RS-485 interface

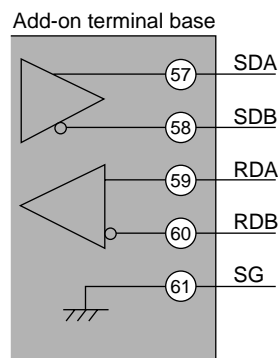

### Handling Precautions

- Multi-drop connection of slave stations is possible.
- Make sure that different addresses are set for each slave station.
- Provide terminating resistor (total of 4 in the case of a 5-wire system connection) on both ends of the communications path. Use terminating resistor of  $150\Omega \pm 5\%$ , 1/2W min.
- In the case of a 3-wire system connection, short-circuit terminals (57) and (59), (58) and (60) on the DCP301.
- Do not short-circuit the RDA and RDB, or SDA and SDB terminals. Doing so might damage the DCP301.



● 5-wire system RS-485 mutual connection

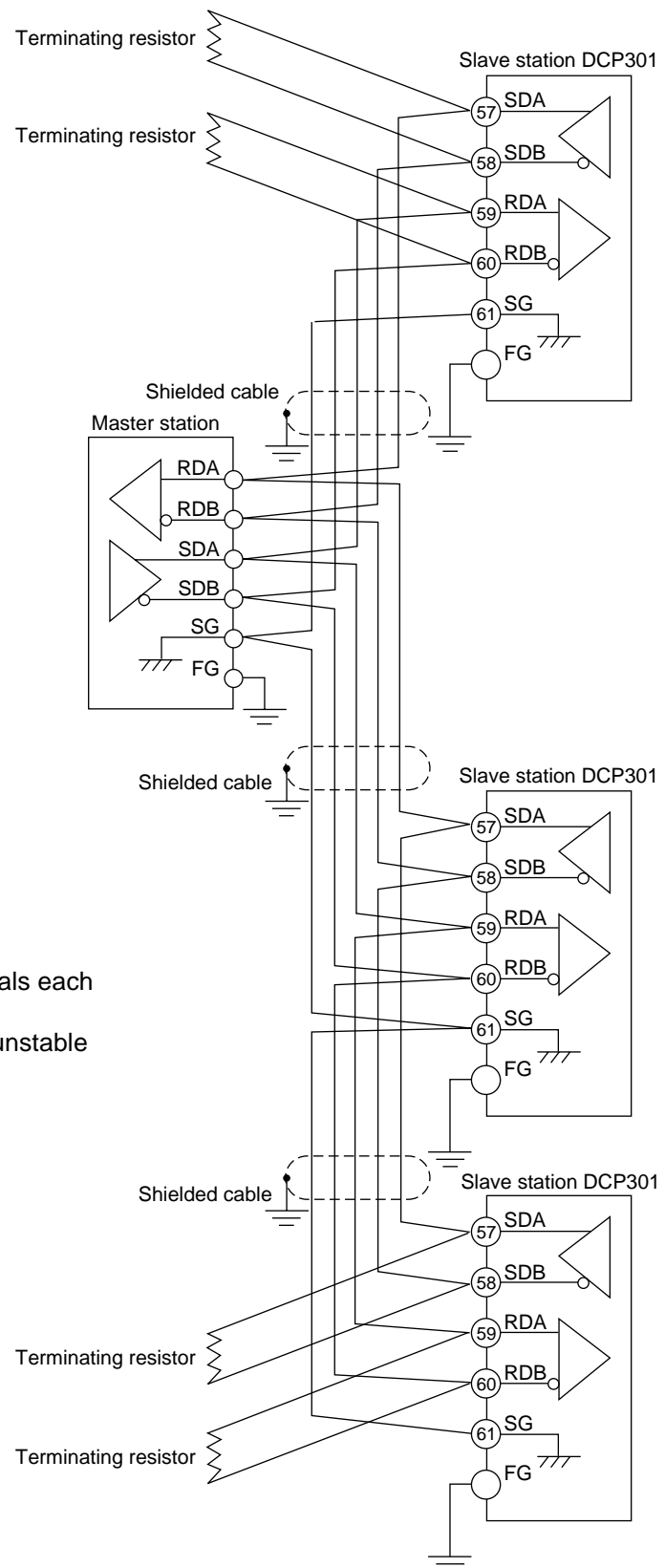

**! Handling Precautions**

Be sure to connect SG terminals each others.  
 Failure to do so might cause unstable communications.

Provide terminating resistor of  $150\Omega \pm 5\%$ , 1/2W min. at both ends of the communications path.  
 Grounding of the shielded FG terminal should be carried out at only one end and not both ends.

● 3-wire system RS-485 mutual connection

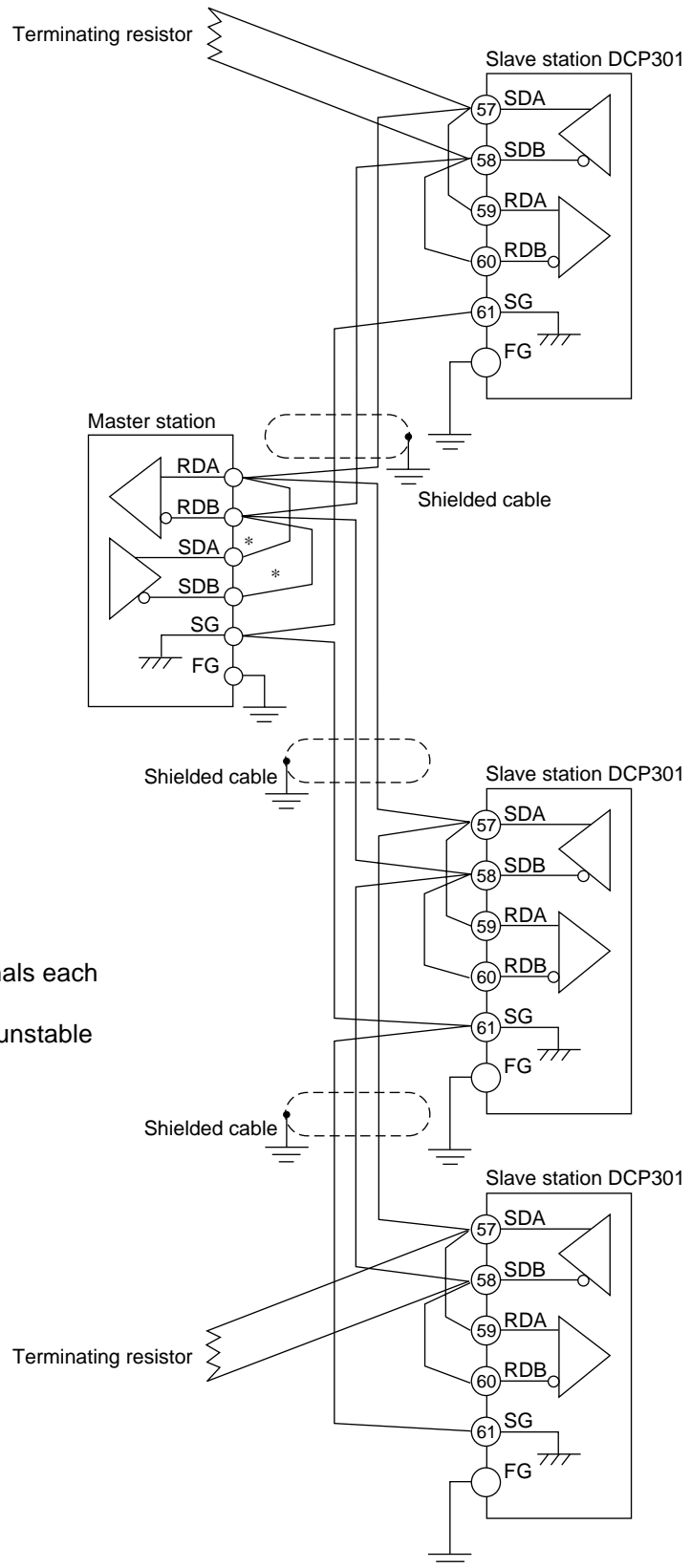

**! Handling Precautions**

Be sure to connect SG terminals each others.  
 Failure to do so might cause unstable communications.

Provide terminating resistor of  $150\Omega \pm 5\%$ , 1/2W min. at both ends of the communications path. Grounding of the shielded FG terminal should be carried out at only one end and not both ends. When there are only three RS-485 terminals, terminals marked \* are wired internally.

## 4-14 Isolating Inputs and Outputs

The following figures show isolation between inputs and outputs. Solid lines show isolated items, and dotted lines show non-isolated items.

### ■ Control outputs 0D, 5G, 6D, 3D, 5K

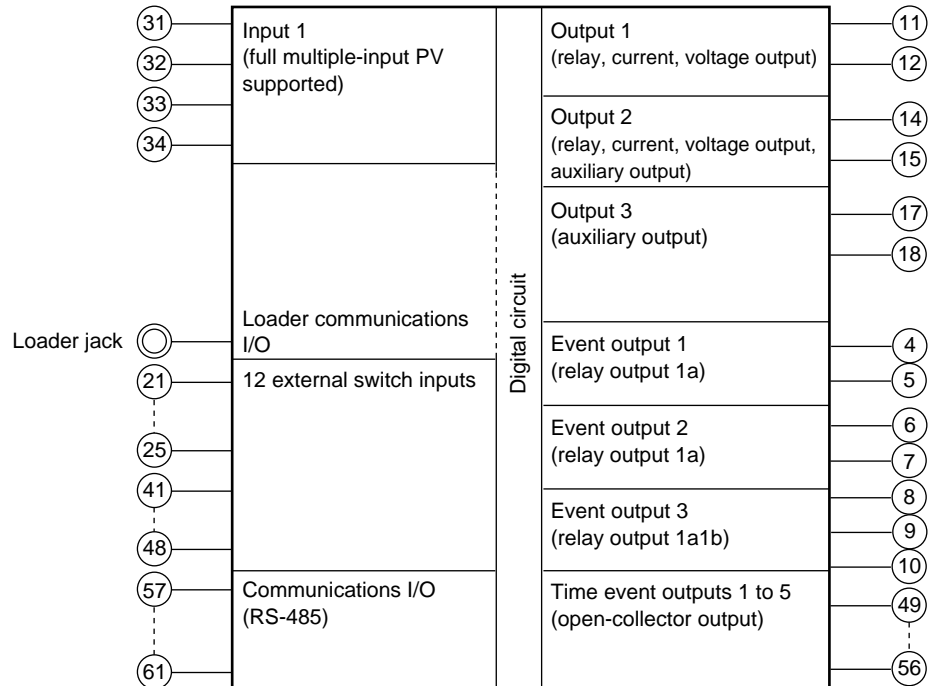

#### ! Handling Precautions

The loader jack is not isolated from internal digital circuits.  
Be sure to cap the loader jack when it is not in use.

### ■ Control output 2G

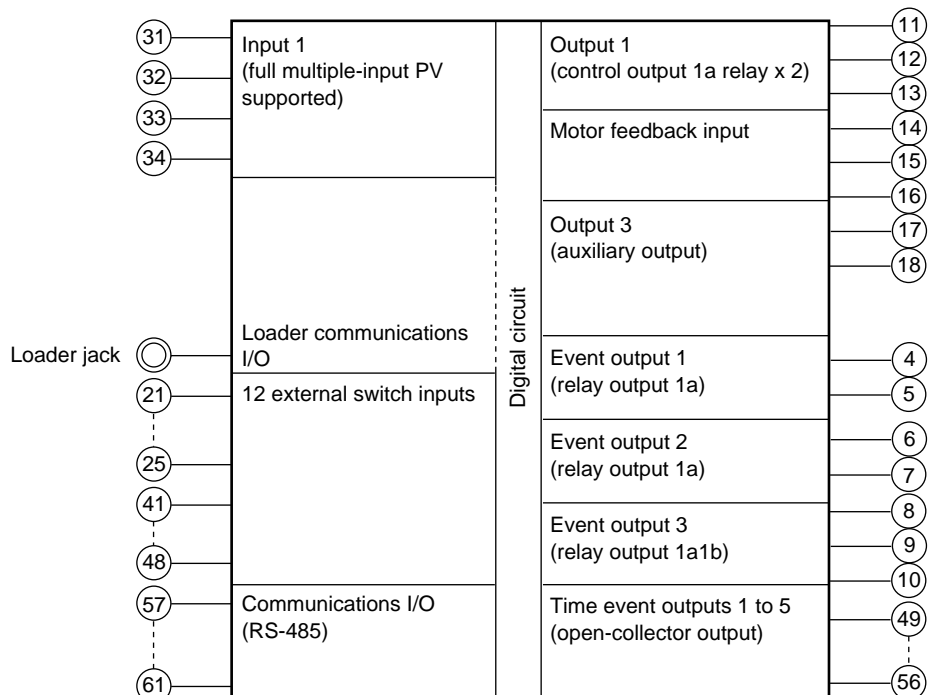

#### ! Handling Precautions

The loader jack is not isolated from internal digital circuits.  
Be sure to cap the loader jack when it is not in use.

# Chapter 5. FUNCTIONS

## 5-1 Data

### ■ Data types

The DCP301 supports the following data types.

For further details, see Chapter 7, Parameter Setup and Chapter 8, Program Setup.

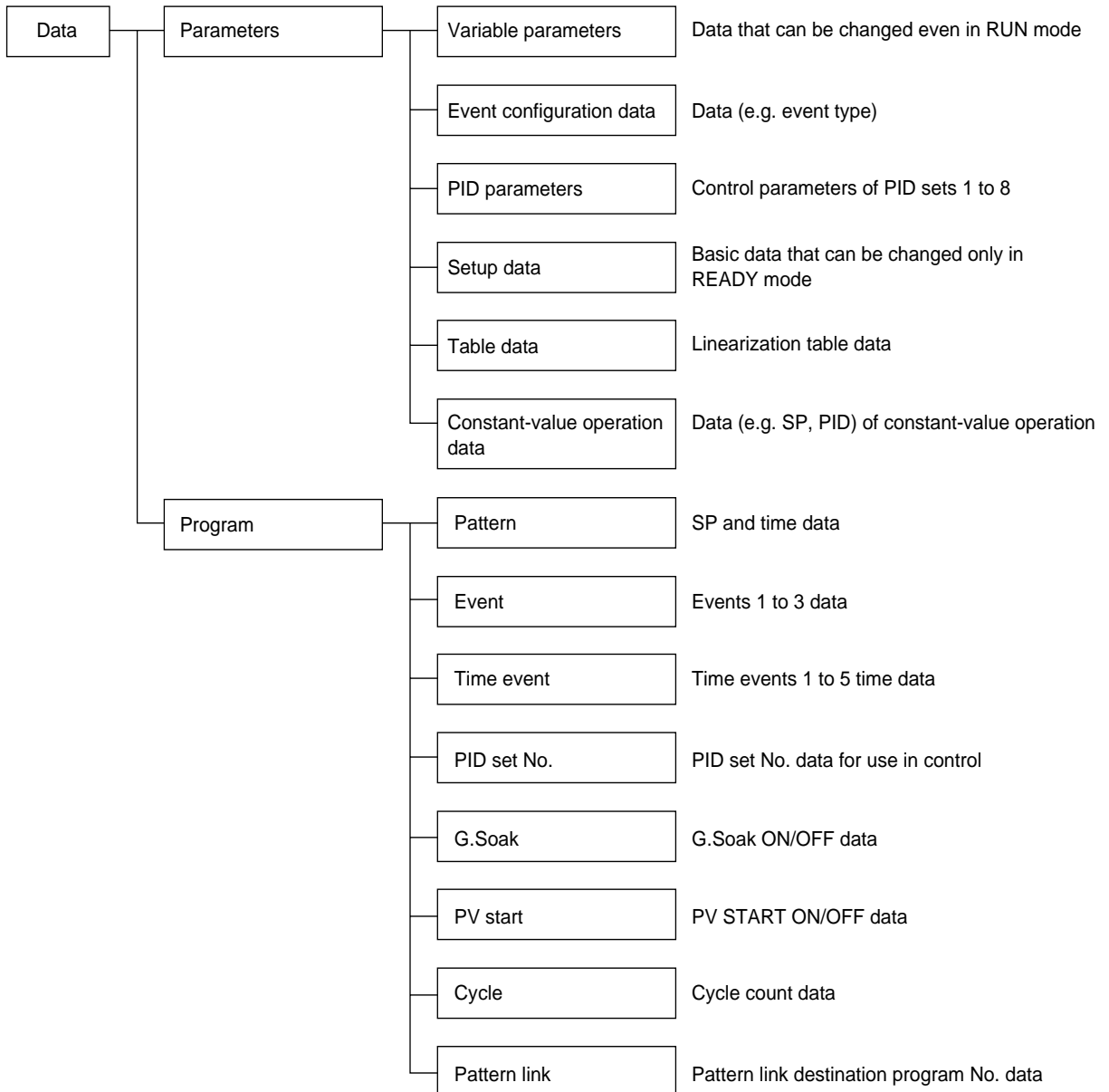

## 5-2 Program Patterns

### ■ Patterns

SP and time comprise the settings for a single segment in a pattern. Up to 30 segments can be linked to create a broken-line whose vertical axis is SP and horizontal axis is time. This system is called the “RAMP-X” system.

SP setting: Within range of SP limiter upper and lower limits

Timesetting: 0 to 99h, 59min or 0 to 99min, 59s  
(Select the time unit in setup data 54.)

SP is the point that corresponds to the time elapsed in the current segment on a straight line made by jointing the start point (SP setting value of the previous segment) to an end point (SP setting value of the current segment).

Accordingly, segments are categorized as follows:

- Rising ramp (rising ramp, rising tendency)  
Previous segment SP setting value < current segment SP setting value
- Falling ramp (falling ramp, falling tendency)  
Previous segment SP setting value > current segment SP setting value
- Soak (soak)  
Previous segment SP setting value = current segment SP setting value

In the case of the No.1 segment, both the start and end points become the soak segment of the No.1 segment SP setting values.

SP (other than No.1 segment) is calculated as by the following formula:

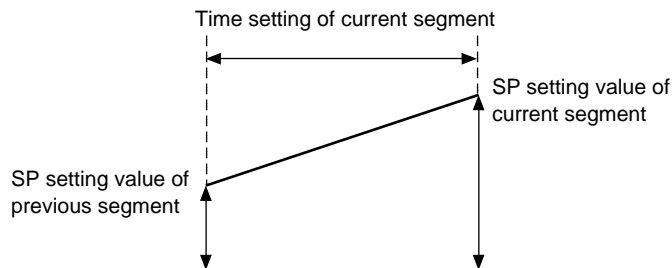
$$SP = (\text{current segment SP setting value} - \text{previous segment SP setting value}) \times (\text{current segment elapsed time} \div \text{current segment time setting}) + \text{previous segment SP setting}$$

## ■ Events 1 to 3

Events 1 to 3 are event configuration data. These are used after setting the event type, event standby, hysteresis and ON delay time.

A total of three event types are available: PV type events, controller status events, and time events.

### ● PV type events



- Basic specifications

The following page shows event type PV, deviation, absolute value deviation, SP, MV and MFB. In the figures, the thick lines show ON-OFF changes in state. The upper line expresses the ON state, and the lower line the OFF state.

EV and H stand for event setting value and hysteresis, respectively. Output in the READY state is OFF.

- Event standby

Events function as follows when event standby has been set to ON.

- If the controller is in the  state in the figure when changing from the READY to the RUN mode and after restoring the power, operation is the same as when event standby is set to OFF. The up-facing arrow in the figure indicates a change to ON, and a down-facing arrow indicates a change to OFF.
- If the controller is outside the  state in the figure when changing from the READY to the RUN mode and after restoring the power, the state is OFF. After entering the  state, the up-facing arrow in the figure indicates a change to ON, and a down-facing arrow indicates a change to OFF.

- Event ON delay

The event No. to apply the delay to and the delay time can be set regardless of event type. "Delay" functions to turn output ON when the event is continuously ON for the preset delay time after the event OFF→ON condition is satisfied.

When event ON delay is combined with event standby, event standby must first be canceled before event ON delay functions.

- Segment progression

- Output is OFF until the program progresses to the segment containing the event setting.
- When the program progresses to the segment containing the event setting, event ON/OFF operation is carried out according to the event setting value.
- The previous setting is valid until the program progresses to a segment containing a new event setting.

For this reason, set as follows to disable the event set in the previous segment from a certain segment onwards:

Direct action events: Upper limit value of event setting

Reverse action events: Lower limit value of event setting

Note, however, that some types of event turn ON even if events are set as shown above.

- When the program has progressed to the No.1 segment by the cycle or pattern link functions, the previous setting is disabled. Output is OFF unless the No.1 segment contains an event setting.

- Other

On 5G output models, when setup data  is set to 1, and SP output (programmer functions) is selected, the MV direct/reverse event does not function.

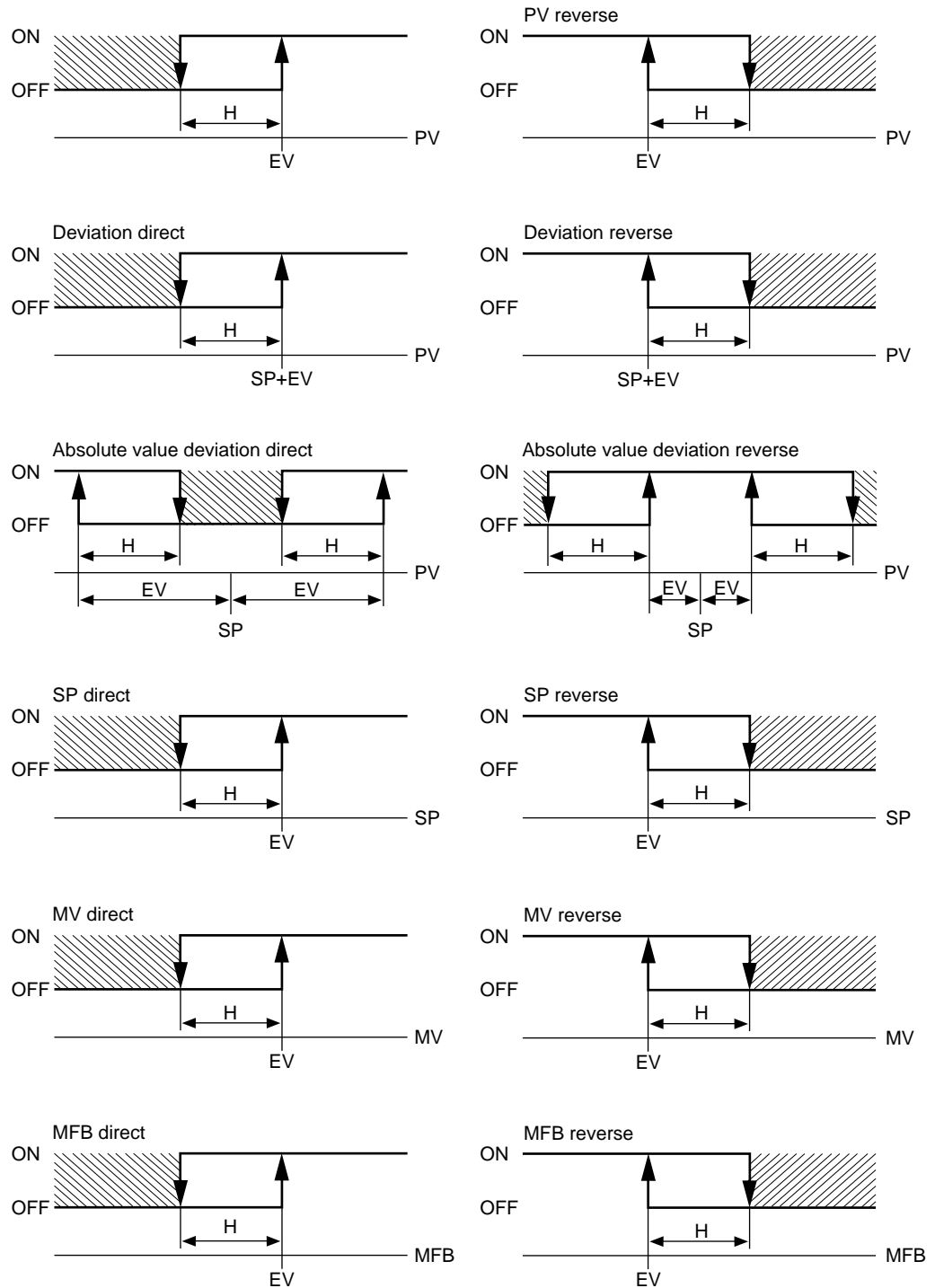

## ● Controller status events

Controller status events are turned ON and OFF according to the controller mode, alarm status and other statuses.

Though the event standby function does not function, the ON delay function does.

Event setting values (operating point), hysteresis and event standby are not set.

### • Basic operations

The following basic operation types are provided:

RUN+HOLD+FAST+END

READY

RUN

HOLD

FAST

END

G.Soak standby

MANUAL

Auto-tuning executing

Constant-value operation

MFB estimated position control, sum of all alarms

PV range alarm

Controller alarms

Low battery voltage

Console setup in progress

Loader setup in progress

ADV

When the DCP301 reaches the state designated by the event type, the event is turned ON. Otherwise, the event is OFF.

### • Alarms

Alarms are divided into PV range alarm groups (alarm code Nos. 01 to 16) and controller alarm groups (alarm code Nos. 70 to 99, and low battery voltage).

When the event type is set to the sum of all alarms, the alarm turns ON even if at least one of the alarms occurs.

When the event type is set to PV range alarm, the alarm turns ON even if at least one of the alarms in the PV range alarm group occurs.

When the event type is set to controller alarm, the alarm turns ON even if at least one of the alarms in the controller alarm group occurs.

### • ADV

This is ON for 1s after executing program advance. The event ON delay is disabled and a delay is not applied.

## ● Time events

When the event 1 to 3 type is set to time event, the event can be used in the same way as time events 1 to 5. However, note that events 1 to 3 do not have segment No. event functions.

Though the event standby function does not function, the ON delay function does.



■ Time events 1 to 5

Either of time events or segment No. events can be selected by the time event type item in the event configuration data setup.

● Time events

The ON and OFF times or only the ON time can be set for each event No. and segment. The following describes ON/OFF of output.

- When the ON time is smaller than the OFF time, output is ON for the duration from the ON time to the OFF time. (See segments 1, 6 and 7 in the figure.)
- When only the ON time is set, output is ON for the duration from the ON time to the segment end point. (See segments 2 and 5 in the figure.)
- When both the ON time and OFF time are not set, output is OFF. (See segment 3 in the figure.)
- Setting only the OFF time without an ON time is not possible. (See segment 3B in the figure.)
- Setting an ON time to be greater to or equal than the OFF time is not possible. (See segment 3C in the figure.)
- Only ON and OFF times set within the segment time are valid. Times straddling the next segment are invalid. The ON and OFF times set in the next segment are valid. (See segments 4 and 5 in the figure.)

Accordingly, the ON and OFF times settings at the segment end point are ignored.

However, ON and OFF times set for segment end points when the END mode is shifted to are valid.

(See segment 9 in the figure, and compare with segment 10 in the END mode.)

- When the ON time is set to 0 (no OFF time setting, or OFF time is greater than 0), output becomes OFF at time 0.

If output at the previous segment end point was ON at this time, the output status at the segment switching point does not momentarily become OFF.

(See segments 5 and 6 in the figure.)

- The G.Soak standby time is not included in the ON and OFF times. (See segment 7 in the figure.)

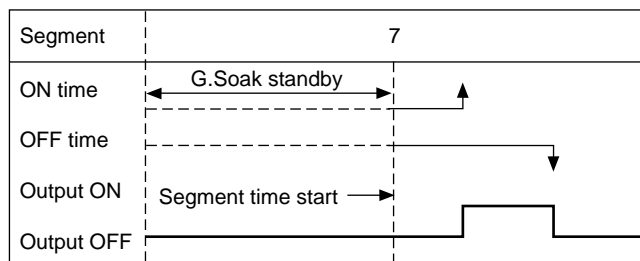
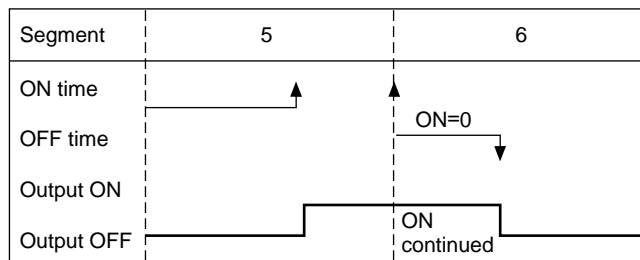
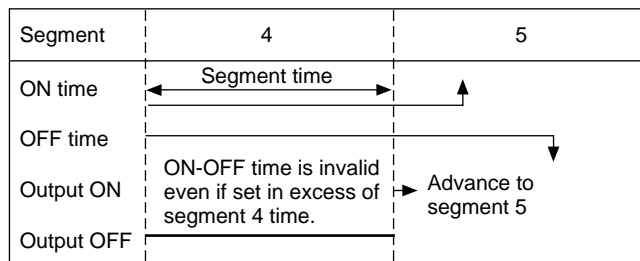
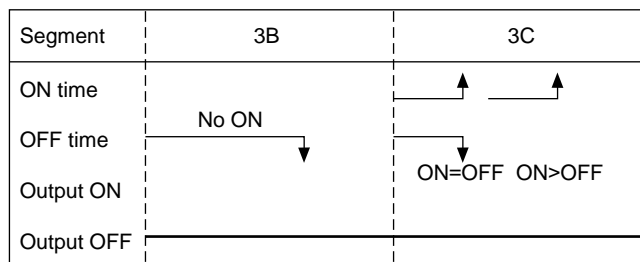
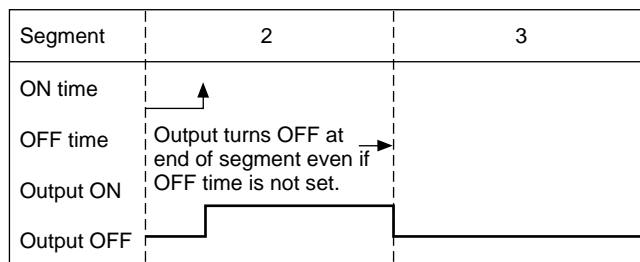
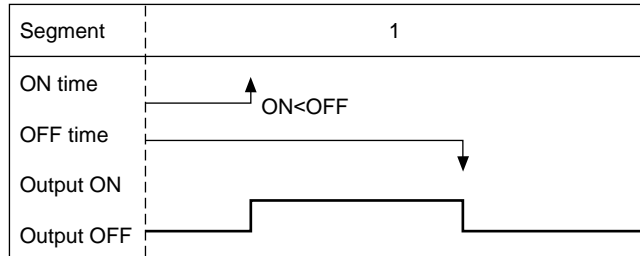

- If the ON time is set to 0 in the case of G.Soak standby, output becomes ON from the G.Soak standby state, and the ON time is started at completion of the G.Soak standby time.

The output time = G.Soak time + OFF time  
(See segment 8 in the figure.)

- ON and OFF time settings the same time as the segment end point are valid in the case of the final segment END mode.  
(See segment 10 in the figure.)

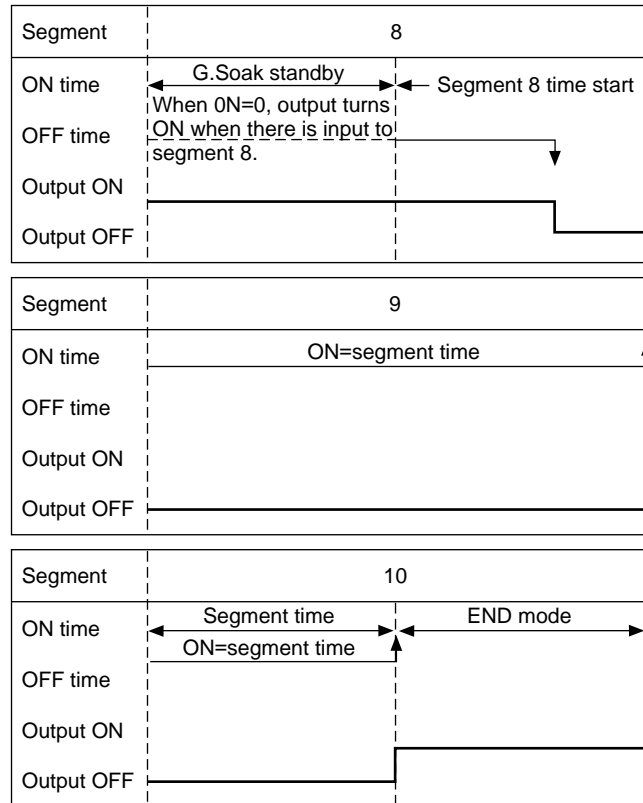

● Segment No. events

The current segment No. is output as binary code.

When all of T1 to T5 are selected as segment No. events in the time event type setup, all ON-OFF operations are as shown in the following table.

When T1 to T4 are assigned in part to segment No. events, only the assigned time events operate as shown in the following table, and the remaining events operate as regular time events.

Segment No. / Event No.	1	2	3	4	5	6	7	8	9	10	11	12	13	14	15
T1	ON	OFF	ON	OFF	ON	OFF	ON	OFF	ON	OFF	ON	OFF	ON	OFF	ON
T2	OFF	ON	ON	OFF	OFF	ON	ON	OFF	OFF	ON	ON	OFF	OFF	ON	ON
T3	OFF	OFF	OFF	ON	ON	ON	ON	OFF	OFF	OFF	OFF	ON	ON	ON	ON
T4	OFF	OFF	OFF	OFF	OFF	OFF	OFF	ON	ON	ON	ON	ON	ON	ON	ON
T5	OFF	OFF	OFF	OFF	OFF	OFF	OFF	OFF	OFF	OFF	OFF	OFF	OFF	OFF	OFF

Segment No. / Event No.	16	17	18	19	20	21	22	23	24	25	26	27	28	29	30
T1	OFF	ON	OFF	ON	OFF	ON	OFF	ON	OFF	ON	OFF	ON	OFF	ON	OFF
T2	OFF	OFF	ON	ON	OFF	OFF	ON	ON	OFF	OFF	ON	ON	OFF	OFF	ON
T3	OFF	OFF	OFF	OFF	ON	ON	ON	ON	OFF	OFF	OFF	OFF	ON	ON	ON
T4	OFF	OFF	OFF	OFF	OFF	OFF	OFF	OFF	ON	ON	ON	ON	ON	ON	ON
T5	ON	ON	ON	ON	ON	ON	ON	ON	ON	ON	ON	ON	ON	ON	ON

### ■ PID set selection

- Eight sets of PID parameters, PID1 to PID8, are used for control operation. When the PID set No. is set to each segment by designating the PID set segment, control output is calculated by each of the PID parameters.
- There are two ways of selecting PID sets: by designating the PID set segment and PID set auto-switching. The method can be selected by setting setup data  $\zeta 11$ .

$\zeta 11$  set to 0: Designation of PID set segment

$\zeta 11$  set to 1: PID set auto-switching

These two methods cannot be set simultaneously.

#### Note

When setup data  $\zeta 11$  is set to 1, PID items in the program setup are not displayed.

- By designation of PID set segment, the PID set No. is set for each segment, and control output is calculated by each of the PID parameters.
- By PID set auto-switching, the SP full-scale is divided into eight zones according to the settings of  $\zeta P. 11$  to  $\zeta P. 17$ , and the PID constant to be used according to the SP value is automatically selected to calculate the control output.

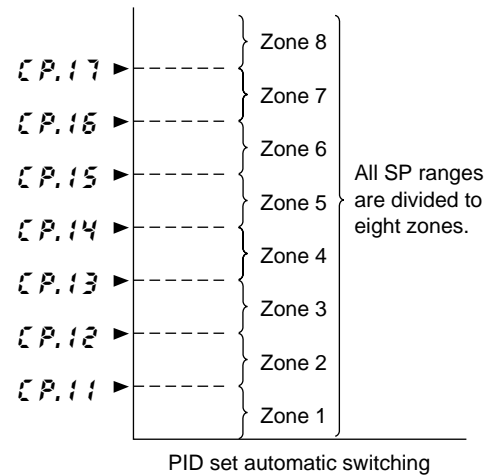
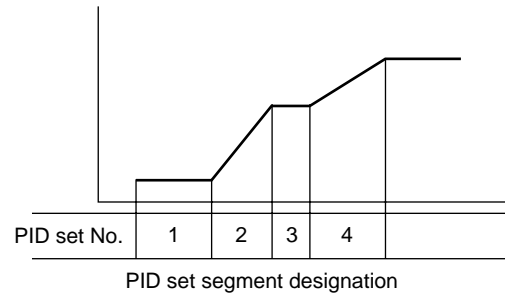

### ■ G.Soak (guarantee soak)

G.Soak ON/OFF and G.Soak width can be set for each segment. The G.Soak time can also be set by the variable parameter  $\zeta 5. k$  item.

The G.Soak function ensures a segment execution time with PV close to SP. G.Soak functions not only in soak segments but also in ramp segments.

At the segment start point, PV and SP are compared, and the absolute value of the resulting deviation continues for the G.Soak time or longer. When the absolute value is smaller than the G.Soak width, operation of that segment is started.

The controller is in the G.Soak standby state until this condition is satisfied, and the linear lamp on the left of the profile display blinks. The operation state is the same as hold at the segment start point (time is set to 0). However, note that in the FAST mode, the controller does not enter the G.Soak standby state even if G.Soak is set to ON. The G.Soak standby state can also be canceled by external switch output. The following cancel conditions can be selected by the setup date  $\zeta 5.2$  to  $\zeta 5.4$  settings.

- (1) G.Soak cancel when external switch input contact is ON or PV satisfies the G.Soak cancel conditions
- (2) G.Soak cancel when external switch input contact is ON and PV satisfies the G.Soak cancel conditions

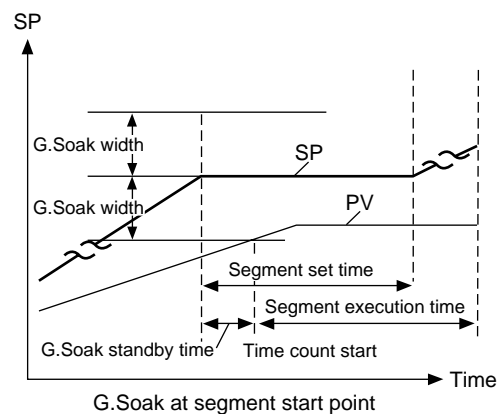

### ■ PV start

If PV start is set in the program setup, PV is started by regular RUN operation.

The first point where PV matches the SP in the program pattern (including bias for both PV and SP) is searched for, and operation is started from that point.

However, note that if a matching point is not found, operation is started from the beginning of segment 1.

When PV has started, event operating points and the time of time events are automatically corrected. If the PV start function is selected by setup data  $\zeta 5 2$  to  $\zeta 5 4$  settings relating to external switch input, PV start can be executed without setting PV start in the program setup.

PV start is valid for segments in the currently selected program, and invalid for the segment at the pattern link destination.

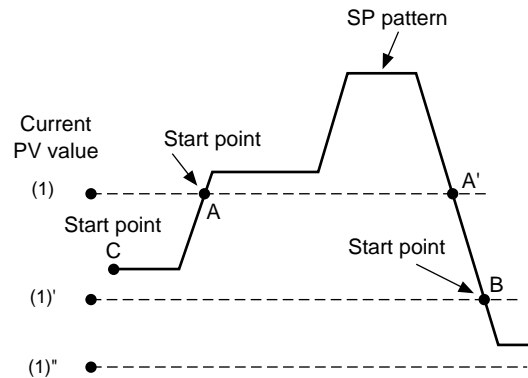

PV start points

- (1) PV starts at point A where the PV value first crosses the SP pattern.
- (1)' PV starts at point B where the PV value first crosses the SP pattern.
- (1)'' Point C of segment 1 is the PV start point since there is no point where the PV value crosses the SP value.

### ■ Cycle

The cycle function is for repeating operation from the No.1 segment of the program pattern to the final set segment for a preset number of cycles. The number of cycles can be set up to 9999.

When a number of cycles "n" is set, the operation count becomes "n+1".

When executing cycle operation, operation at the end point of the final segment is not carried out, and operation is restarted with the settings of events 1 to 3 and time events 1 to 5 cleared. At this time, PV is not started and operation starts from the No.1 segment even if PV start is set.

If the SPs at the pattern start and end points do not match, the SP changes in a stepped manner during cycle operation.

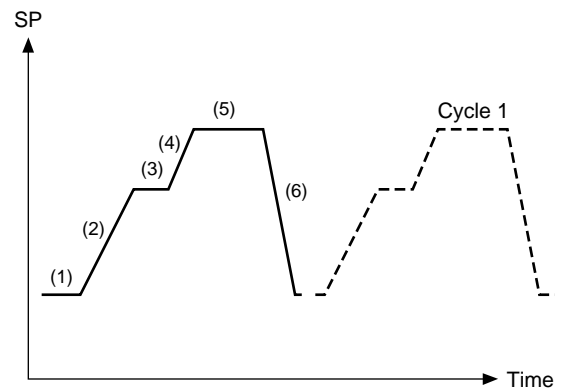

■ Pattern link

“pattern link” is a function for linking patterns together. The link destination program No. is set by the pattern link item.

When the pattern link item is set to 0 (initial setting), patterns are not linked. When the No. of the current program itself is set to the pattern link item, this creates an endless loop.

If the SPs at the link source end point and the link destination start point do not match, the SP changes in a stepped manner during link operation.

When cycle operation has been set, the pattern link function works after cycle operation has ended. After pattern link operation ends, operation begins from the No.1 segment of the link destination pattern, so operation is restarted with the settings of events 1 to 3 and time events 1 to 5 cleared.

If PV start is programmed to the link destination pattern, the PV start function operates after the link is made.

After the link has been made, PID operation is not initialized, and is continued.

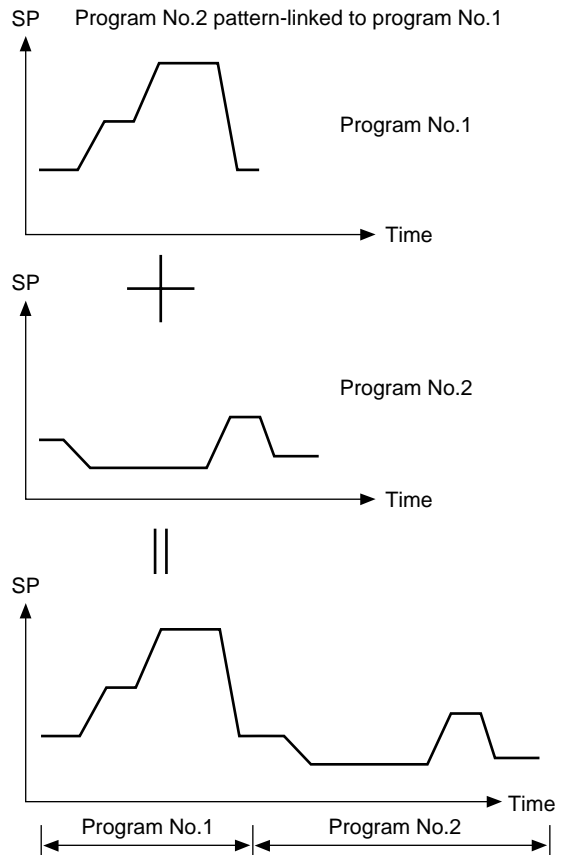

## 5-3 Modes

### ■ Mode types

The following modes are available on the DCP301.

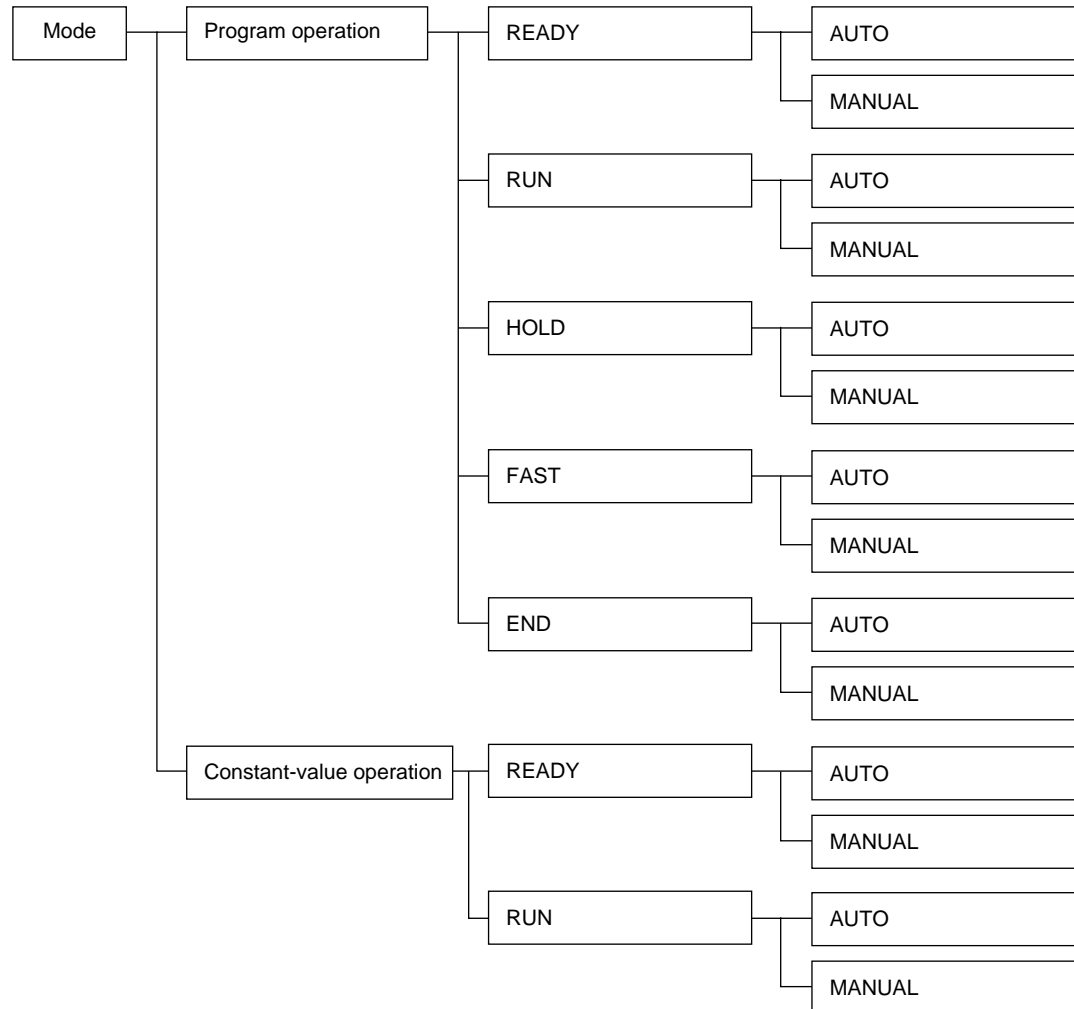

#### ● Program operation

Operation is carried out according to SP, times, events, etc. set to program patterns No.1 to 19.

#### ● Constant-value operation

Operation is carried out according to SP or events set in the constant-value operation data. Time events 1 to 5 turn OFF.

#### ● READY

In this mode, the DCP301 is ready for operation.

MV output is fixed, and events to be operated according to event setting values turn OFF. However, events to be operated according to controller states are active.

Parameters for all of the setup data, some event configuration data and some constant-value operation data can be set or changed in the READY mode. During program operation, program pattern Nos.1 to 19 can be selected.

● **RUN**

In this mode, the program is running.

MV outputs are active in PID control or ON-OFF control, and events and time events are active.

In the program operation mode, program operation progresses according to the elapsed time.

However, note that progress of program operation stops in the same way as the HOLD mode when the controller is in the G.Soak (Guarantee Soak) standby state.

● **HOLD**

In this mode, the program is held.

Progress of program operation stops. However, note that MV outputs are active in PID control or ON-OFF control, and events and time events are active in the same way as in the RUN mode. The HOLD mode is not available during constant-value operation.

● **FAST**

In this mode, the program is fast-forwarded.

This mode is like the RUN mode except that progress of the program operation time is speeded up.

The time scale is selected by the variable parameter *F A S T* setting.

MV outputs are active in PID control or ON-OFF control, and events and time events are active.

The controller does not enter the G.Soak standby state even if G.Soak (Guarantee Soak) is set. The FAST mode is not available during constant-value operation.

● **END**

In this mode, operation of the program has ended.

MV outputs are active in PID control or ON-OFF control, and events and time events are active with program operation stopped at the program end point.

The END mode is not available during constant-value operation.

● **AUTO**

In this mode, program operation is automatic.





MV output is active according to controller control.

(However, note that when programmer functions are selected on 5G output models, SP output is active according to controller control.)

● **MANUAL**

In this mode, program operation is manual.

MV output can be changed by  ,  ,  ,  on the console or communications.

(However, note that when programmer functions are selected on 5G output models, SP output can be changed by  ,  ,  ,  on the console or communications.)

## ■ Mode transition

### ● During program operation

The solid lines in the following diagram show mode transition operations. The broken lines show end of operation.

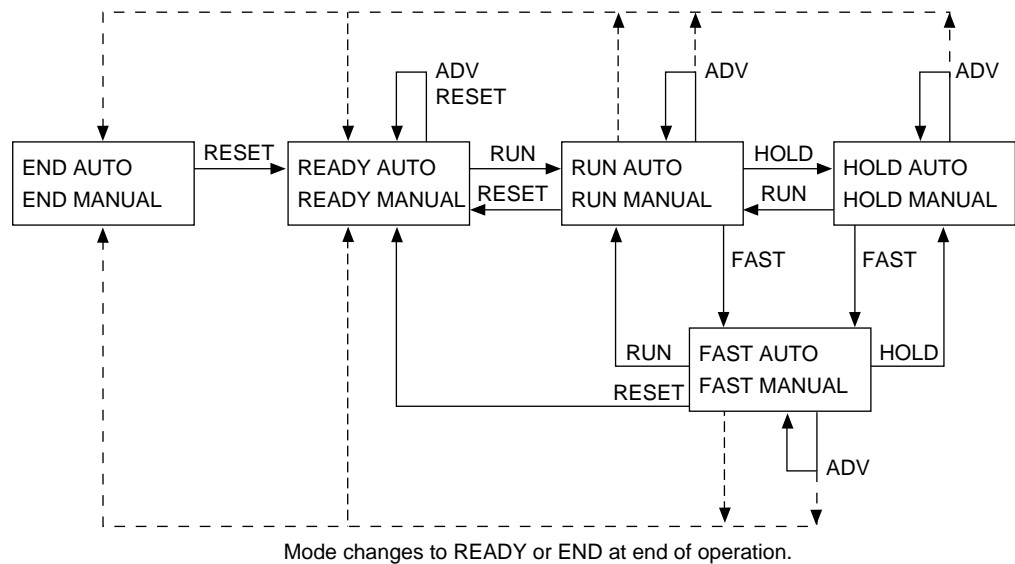

### Note

- When shifting between the AUTO and MANUAL modes, the modes in the square frames can be shifted between.
- Selection of the READY or END modes at end of operation is set up in the setup data.

### ● During constant-value operation

The solid lines in the following diagram shows mode transition operation.

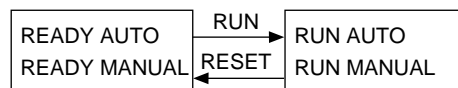

### Note

When shifting between the AUTO and MANUAL modes, the modes in the square frames can be shifted between.

### ● Switching between program operation and constant-value operation

In the READY mode, select operation by the constant-value operation data “0 1 0 0 E” operation mode item.

- 0: Program operation
- 1: Constant-value operation



## ■ Mode transition operations

The following describes mode transition operations.

Though “program end” is not an operation, it is described below as it is a factor in mode transition.

### ● RUN

This operation involves shifting to the RUN mode from the READY, HOLD or FAST modes. To shift from the READY mode to the RUN mode, the DCP301 must be in the basic display state even in key, external switch input or communication operations.

### ● HOLD

This operation involves shifting to the HOLD mode from the RUN or FAST modes.

The HOLD mode is not available in the constant-value operation mode.

### ● RESET

This operation involves shifting to the READY mode from the RUN, HOLD, FAST or END modes.

In the program operation mode, this mode includes returning to the No.1 segment.

### ● ADV

This operation involves advancing one segment in the READY, RUN, HOLD or FAST modes.

The ADV mode is not available in the constant-value operation mode.

### ● FAST

This operation involves shifting to the FAST mode from the RUN or HOLD modes.

The FAST mode is not available in the constant-value operation mode.

### ● AUTO

This operation involves shifting to the AUTO mode from the MANUAL mode.

### ● MANUAL

This operation involves shifting to the MANUAL mode from the AUTO mode.

When the DCP301 enters the MANUAL mode, the basic display state changes as follows.

- When controller functions are selected, PV and output value (%) are displayed.
- When programmer functions are selected, PV and SP are displayed.

When the DCP301 enters the MANUAL mode from the AUTO mode by external switch inputs or communications, the display changes to the basic display state even in the parameter setup or program setup states.

### ● Program end

When operation progresses in the RUN or FAST modes in the program operation mode, or when the segment has been advanced in the ADV mode, the program ends when all end points in the program setup including cycles and pattern links have been reached.

You can select in the setup setting in which of the READY or END modes program operation ends.

The program does not end in the constant-value operation mode.

## ■ Mode transition limitations

Mode transition can be carried out operating the console keys, external switching input and communications. The following table shows which operations are enabled in each of the modes.

Operation		RUN (to RUN mode)			HOLD (to HOLD mode)			RESET (to READY mode)			ADV * (to next segment mode)			FAST (to FAST mode)		
		Key	Switch	Com- muni- cations	Key	Switch	Com- muni- cations	Key	Switch	Com- muni- cations	Key	Switch	Com- muni- cations	Key	Switch	Com- muni- cations
Program operation	READY	⊙	⊙	⊙	—	—	—	—	Δ	Δ	—	○	—	—	—	—
	RUN	—	—	—	⊙	○	○	⊙	○	○	⊙	○	○	⊙	○	○
	HOLD	⊙	○	○	—	—	—	⊙	○	○	⊙	○	○	⊙	○	○
	FAST	⊙	○	○	—	○	○	⊙	○	○	⊙	○	○	—	—	—
	END	—	—	—	—	—	—	⊙	○	○	—	—	—	—	—	—
Constant- value operation	READY	⊙	○	○	—	—	—	—	—	—	—	—	—	—	—	—
	RUN	—	—	—	—	—	—	⊙	○	○	—	—	—	—	—	—

Operation		MANUAL (to MANUAL mode)			AUTO (to AUTO mode)		
		Key	Switch	Com- muni- cations	Key	Switch	Com- muni- cations
Program operation	AUTO	⊙	○	○	—	—	—
	MANUAL	—	—	—	⊙	○	○
Constant- value operation	AUTO	⊙	○	○	—	—	—
	MANUAL	—	—	—	⊙	○	○

○ : Operation is enabled.

⊙ : Operation is enabled if in basic display state.

Δ : No.1 segment is returned to if controller is still in READY mode.

— : Operation is disabled.

\* With ADV by communications, mode transition is not limited to the next segment; the mode advances to the segment specified in the communications message.

## 5-4 Controller and Programmer

On 5G output models (output catalog No. appended with 5G), you can choose between use as a controller or a programmer. Set this in setup data  $\zeta 18$ . You can also choose between controller or programmer functions even if the DCP301 is used for program operation or constant-value operation.

The DCP301 is limited to use as a controller at all times on other models.

### ● Controller

When the DCP301 is used as a controller, PID control operation is carried out according to PV, SP AND PID setting values, and the resulting manipulated variable (MV) is output as an analog output.

ON-OFF control, heat/cool PID control and 3-position-proportional is also possible depending on the type of output supported by the model of DCP301.

In the MANUAL mode, the MV can be incremented or decremented in the basic display state by the console keys.

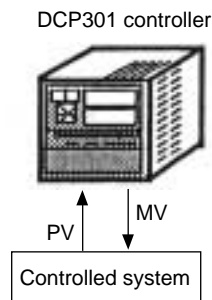

### ● Programmer

When the DCP301 is used as a programmer, PID control operation is not carried out, and the SP is output in the scaled 4 to 20mA range.

In the MANUAL mode, the SP can be incremented or decremented in the basic display state by the console keys.

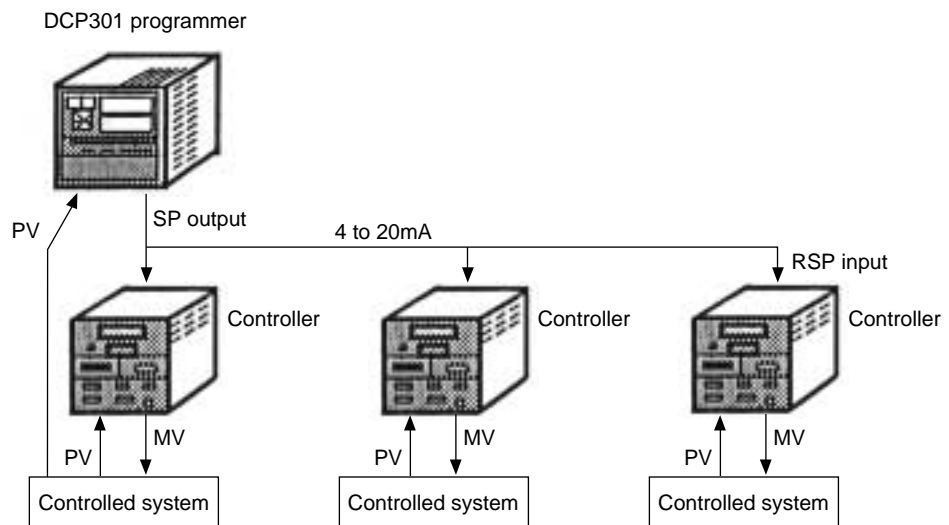

## 5-5 Input Processing Functions

Input processing is carried out in the order shown below.

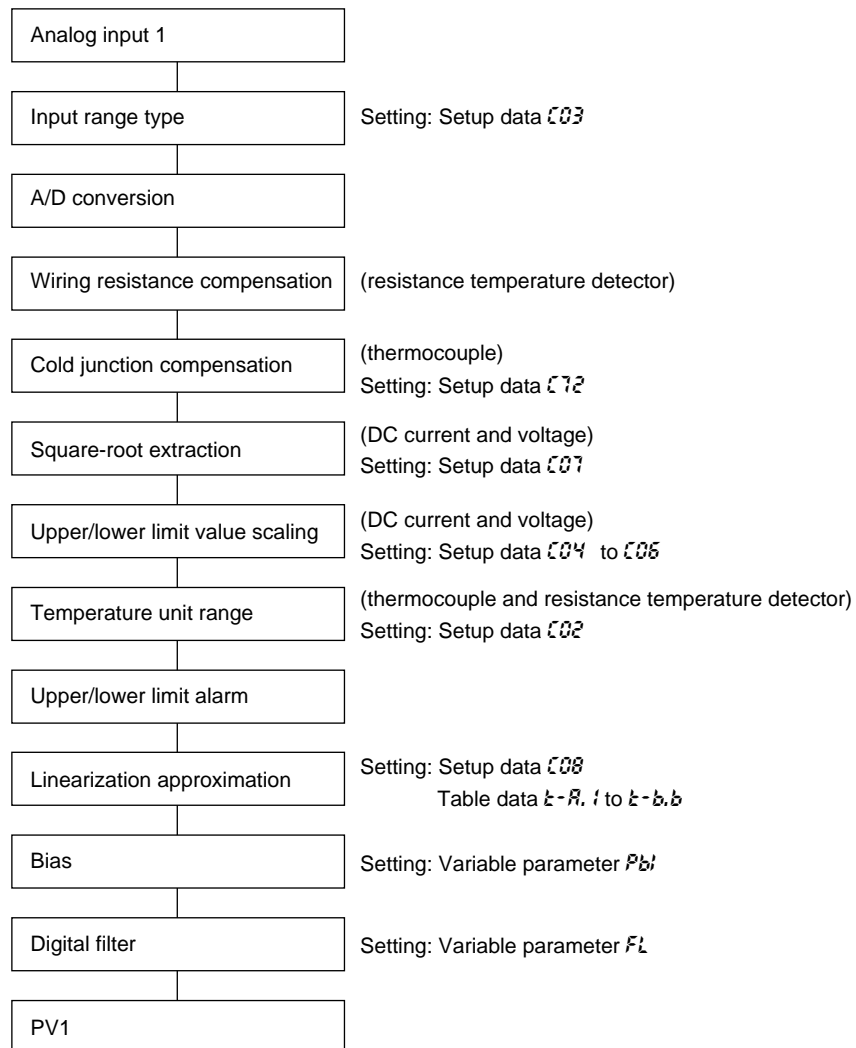

## 5-6 Output Processing Functions

Three outputs are provided as output processing functions: control output, SP output and auxiliary output.

### ■ Control output

When the DCP301 is selected for use as a controller, control output is operational. How outputs are processed varies according to the output type supported on the model.

#### ● 5G output

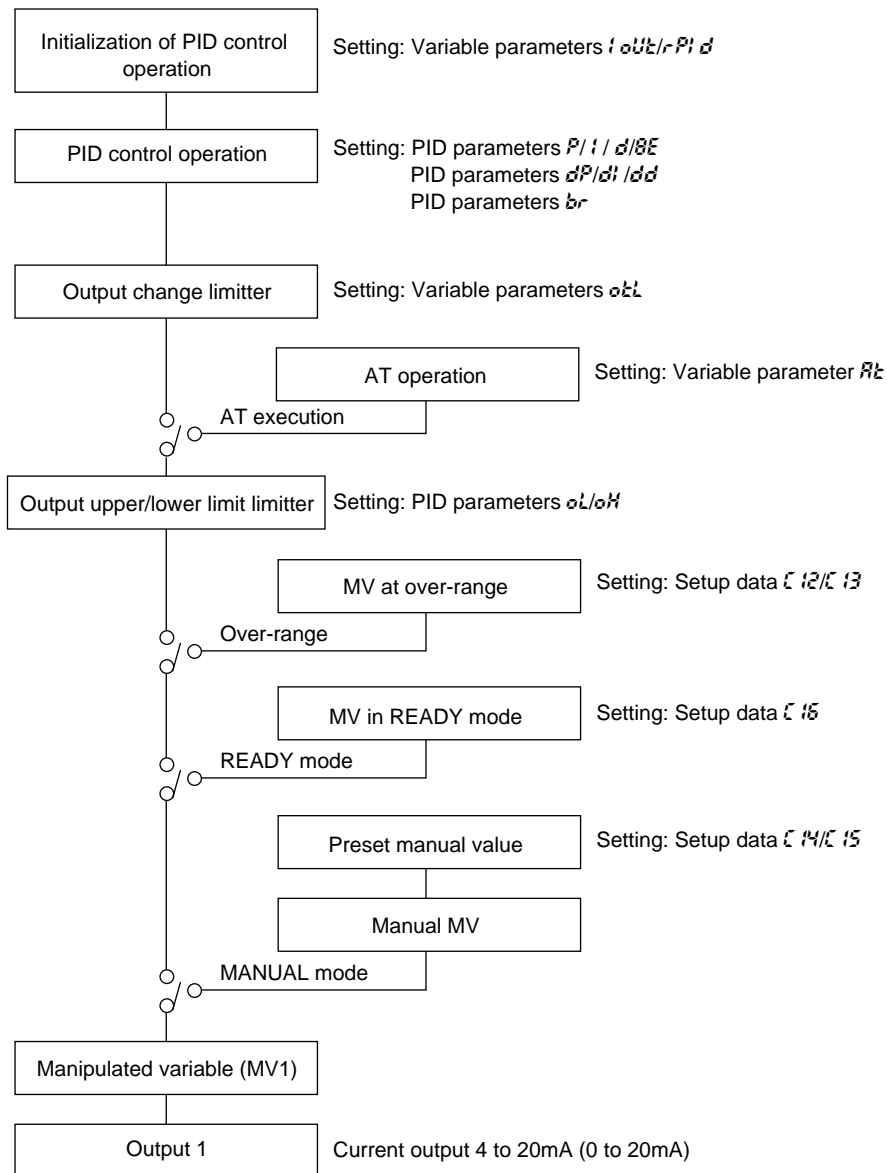

● 0D, 6D output

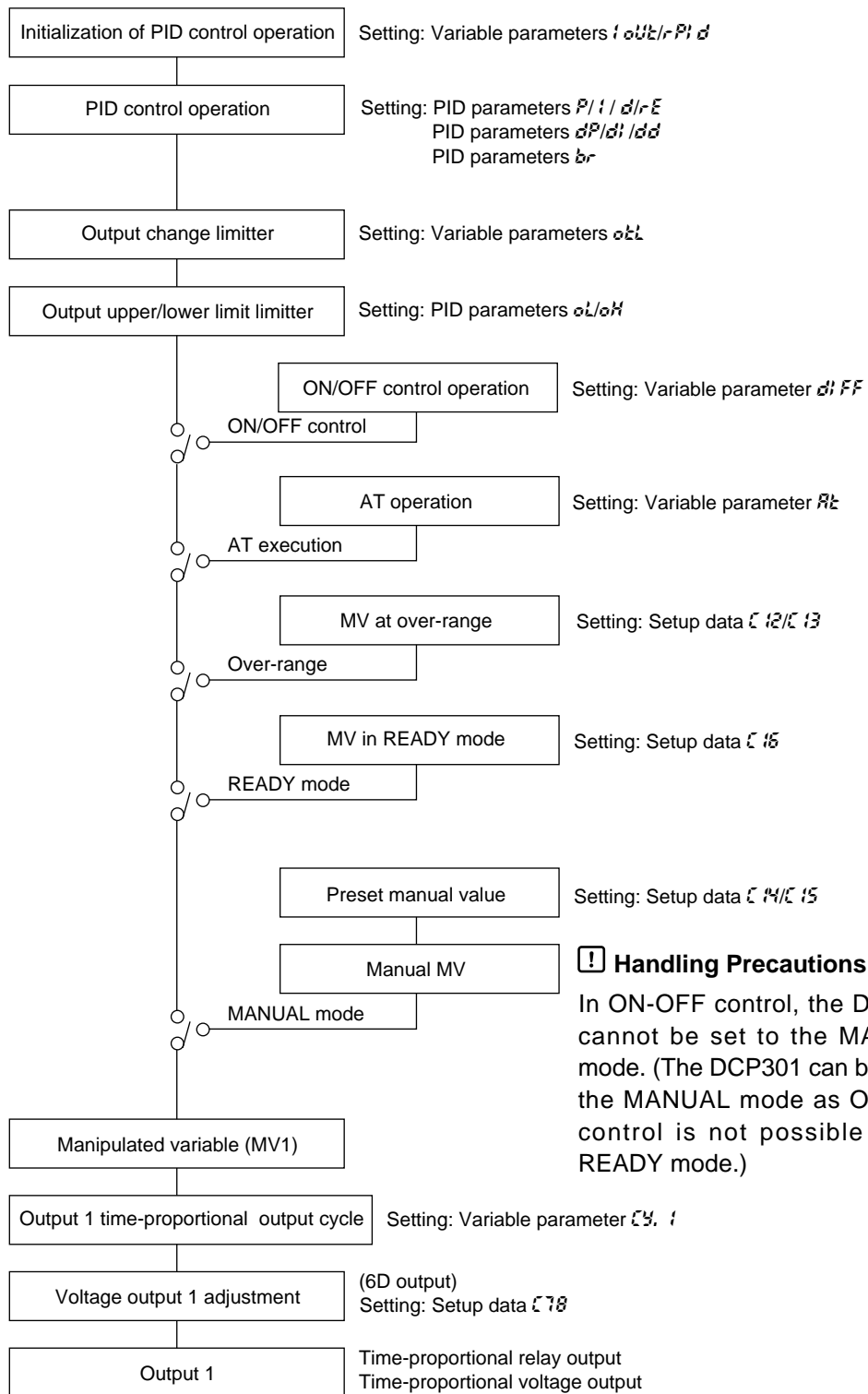

**! Handling Precautions**

In ON-OFF control, the DCP301 cannot be set to the MANUAL mode. (The DCP301 can be set to the MANUAL mode as ON-OFF control is not possible in the READY mode.)

● 2G output

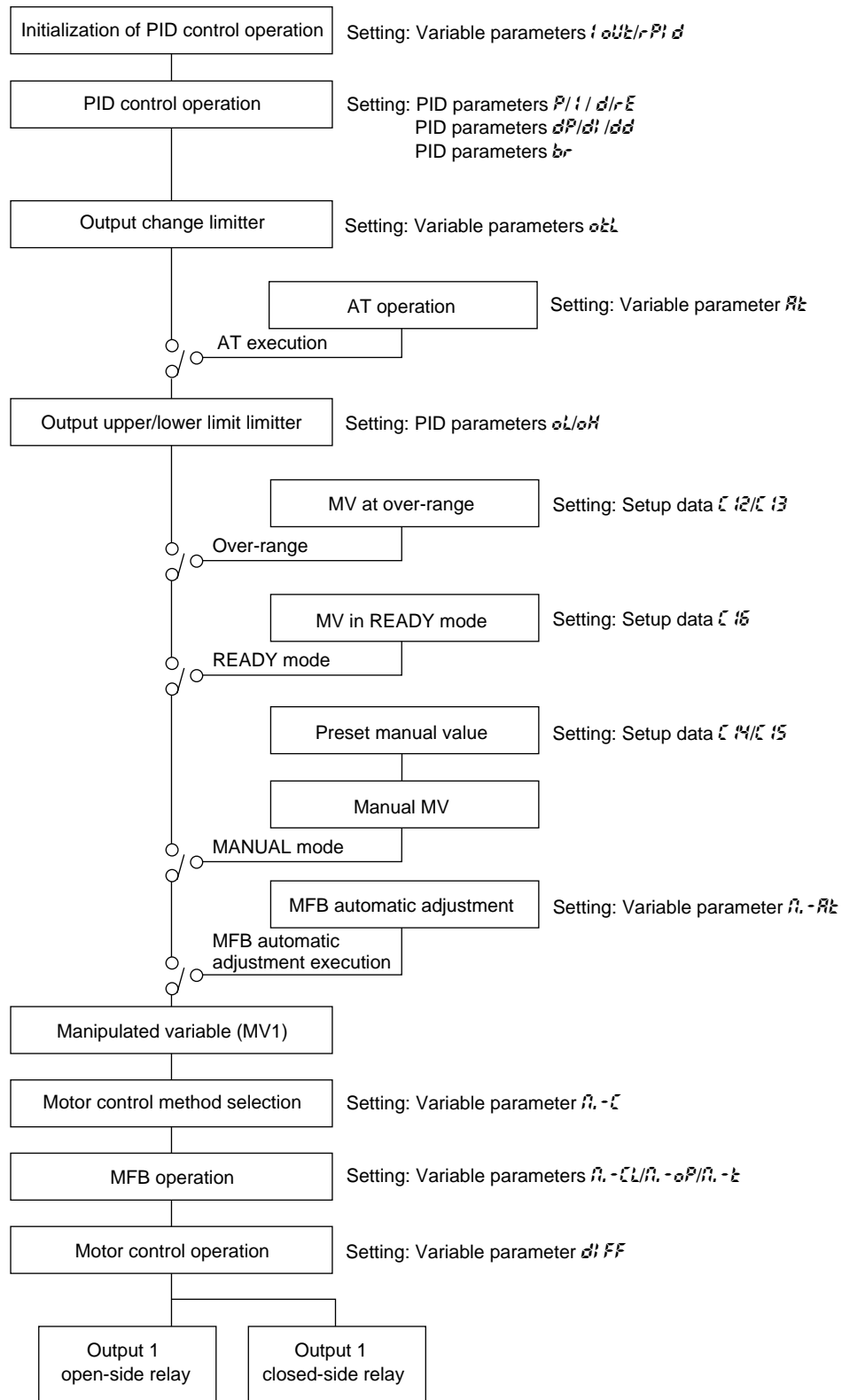

● 3D, 5K outputs





■ SP output

When the DCP301 is selected for use as a programmer, control output is operational. On 5G output models, SP output is processed as follows.

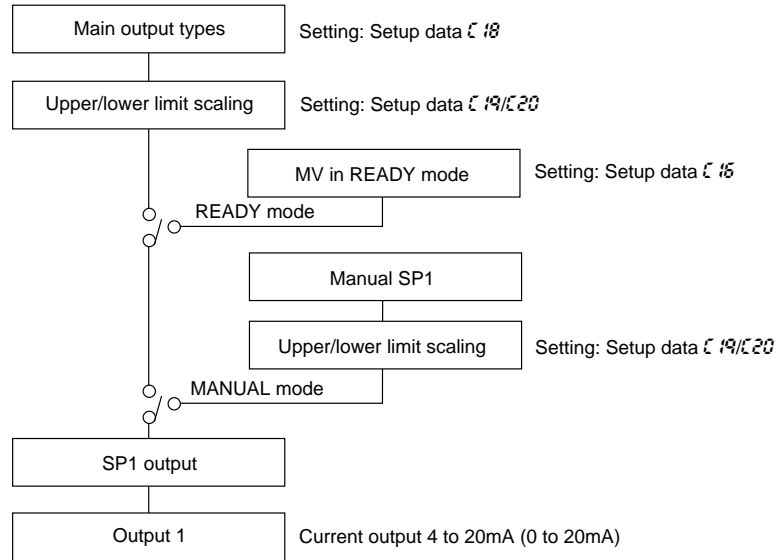

■ Auxiliary output

● Auxiliary output 1

When auxiliary output 1 or 2 are supported on 0D, 5G or 6D output models, auxiliary output 1 is processed as follows.

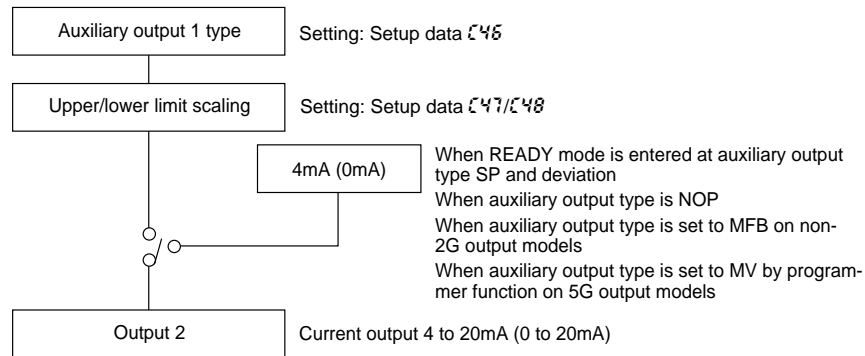

● Auxiliary output 2

When auxiliary output 2 is supported on 0D, 5G or 6D output models, auxiliary output 2 is processed as follows.

When auxiliary output 1 is supported on 2G, 3D or 5K output models, auxiliary output 2 is processed as follows.

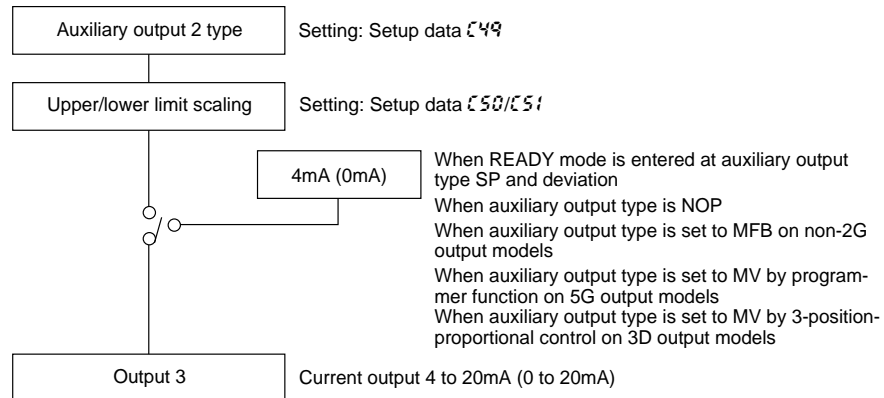

# Chapter 6. OPERATION

## 6-1 Turning the Power ON

The DCP301 is not equipped with a power switch or protective fuses. If necessary, prepare these externally.

When a voltage of 90 to 264Vac is applied across terminals (1) and (2) on the DCP301, display appears for about 10s after which control and other operations are started. During controller startup until start of operations, the LEDs on the profile display light successively at uneven intervals clockwise from top right. The following diagram shows the flow of operations at startup.

### ● Startup flow

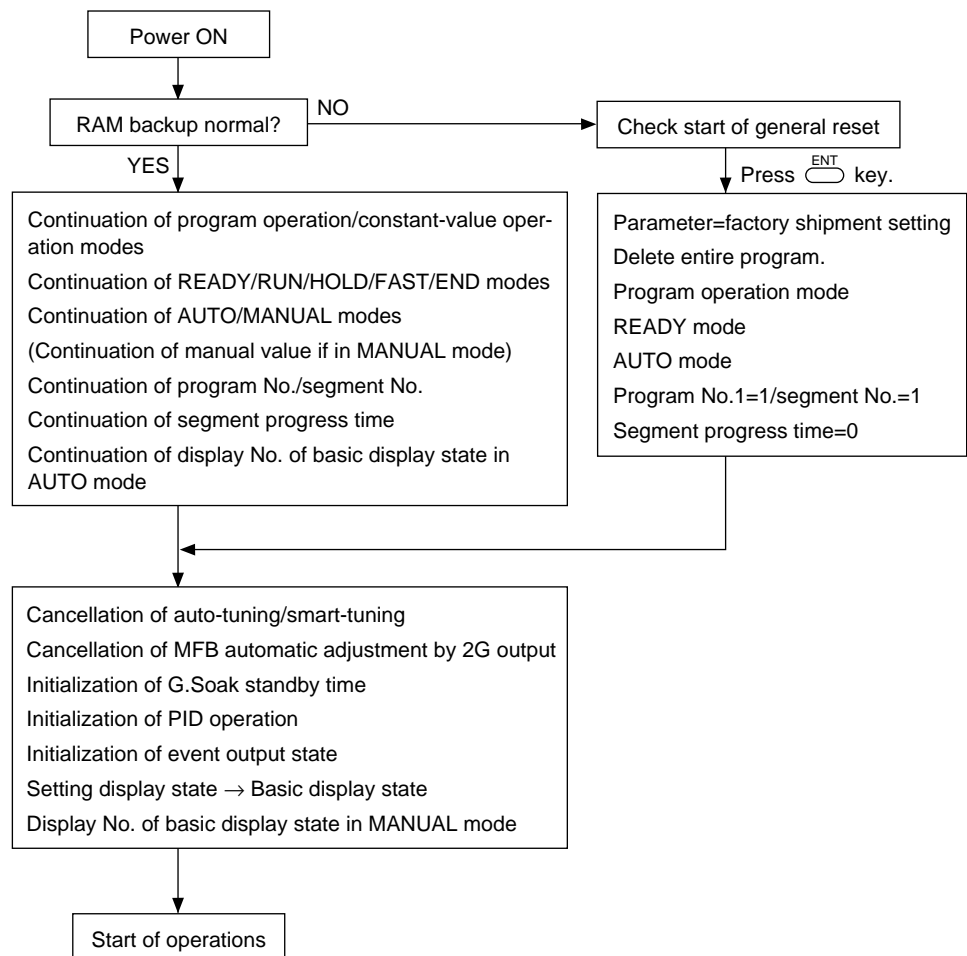

### ! Handling Precautions

With the following modes and items, the state when the power is turned OFF continues when the power is turned back ON.

- READY, RUN, HOLD, FAST, END modes
- AUTO, MANUAL modes
- MANUAL values in MANUAL mode
- Program No., segment No.
- Progress time in segment
- Display No. if in basic display state in AUTO mode

## 6-2 Switching the Basic Display

The “basic display state” of the controller collectively refers to the display state of the program No. display, segment No. display, upper display, lower display, basic indicator LED lamps and event LEDs.

Each press of  $\text{DISP}$  successively switches the basic display state. Operation of other displays and LEDs is carried out in the same way even when setting up parameters, for example. However, switching by  $\text{DISP}$  is not possible.

The following figure shows the conventions used for displays in this manual.

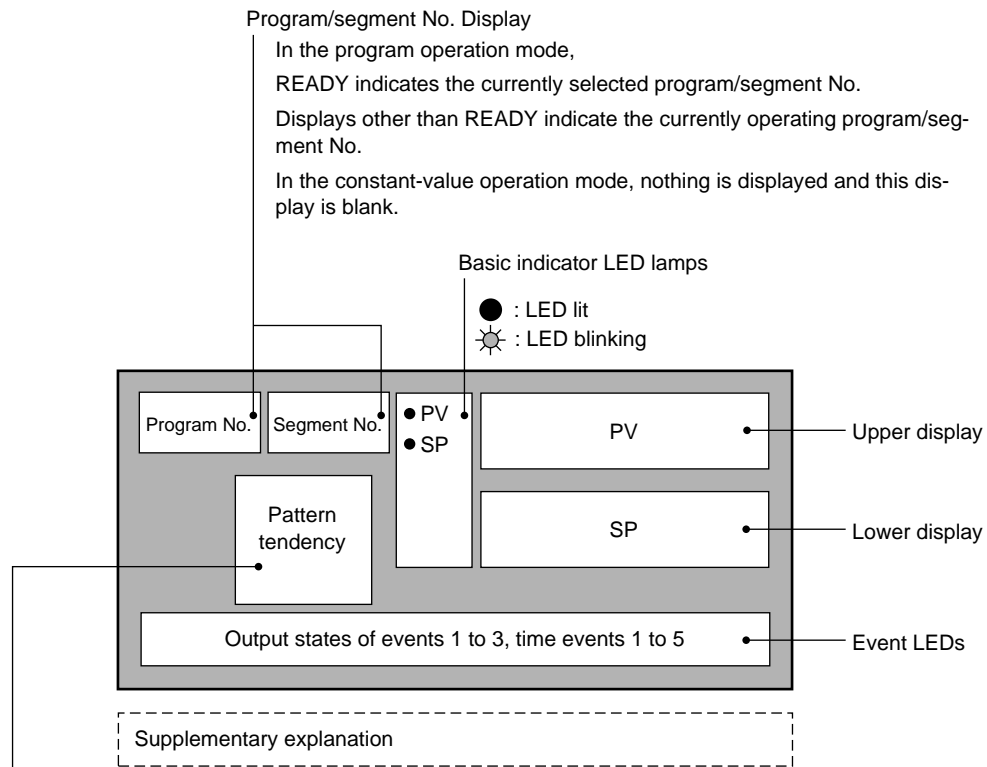

### Profile Display

In the program operation mode, the profile is displayed only when the program has been set up. The profile is not displayed when the program is not set up.

When there is no subsequent segment even if the program is set up, the three LEDs on the right do not light. In the constant-value operation mode, nothing is displayed and this display is blank.

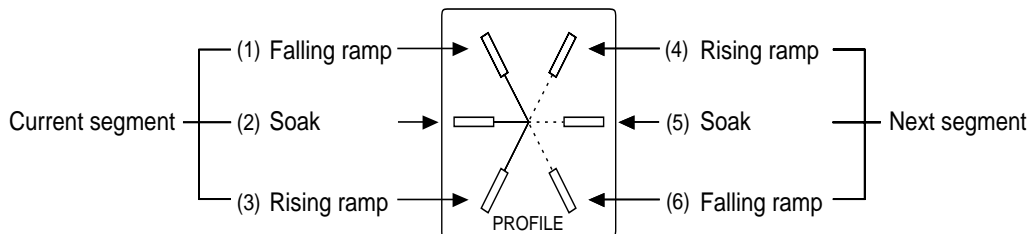

## ■ Display in program operation mode

### ● functions

Output Model No.	Display
0D, 5G, 6D	Display 1 → Display 2 → Display 5 → Display 6 → Display 7 → Display 1 (repeated)
2G	Display 1 → Display 2 → Display 3 → Display 5 → Display 6 → Display 7 → Display 1 (repeated)
3D, 5K	Display 1 → Display 2 → Display 4 → Display 5 → Display 6 → Display 7 → Display 1 (repeated)

### ● Display 1

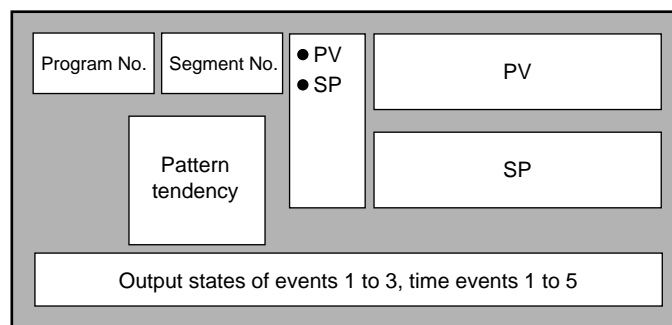

The digit to which SP values can be entered blinks in the MANUAL mode when programmer functions are selected.

### ● Display 2

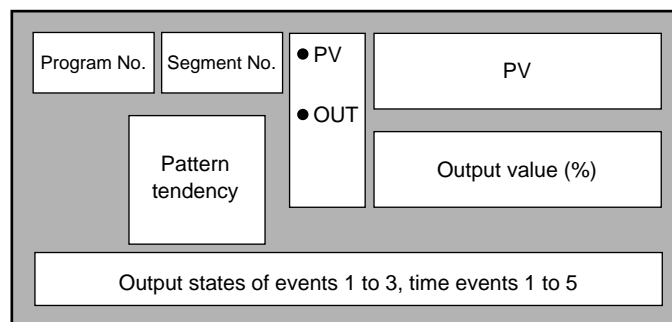

The digit to which SP values can be entered blinks in the MANUAL mode when controller functions are selected.

### ● Display 3

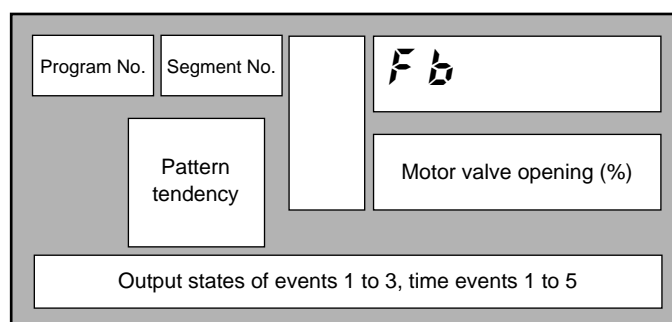

This display is exclusive to 2G output models (output catalog No. appended with 2G).

● Display 4

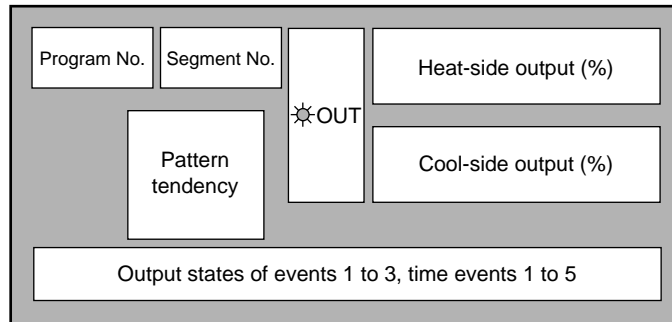

This display is exclusive to heat/cool output models (output catalog No. appended with 3D or 5K).

● Display 5

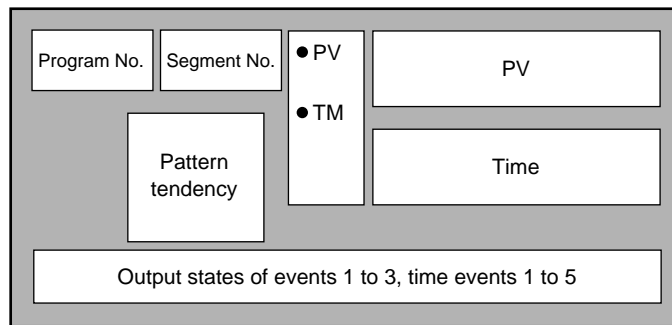

Either of “h:min” or “min:s” is selected as the time unit in setup settings. Select either “remaining segment time” or “total operating time” in setup settings as the details whose time is to be displayed.

● Display 6

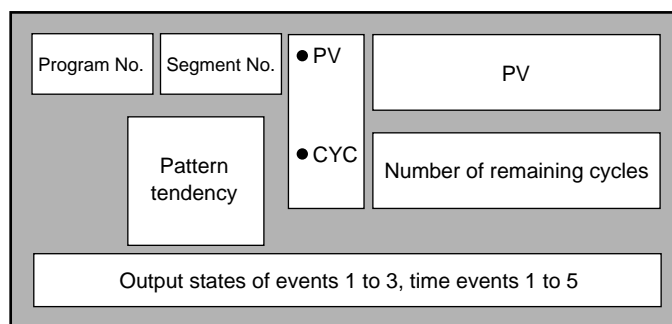

When the remaining number of cycles is “0”, subsequent cycle operation is not carried out.

● Display 7

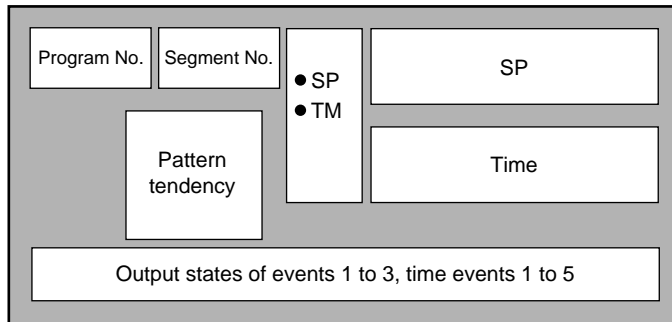

The digit to which SP values can be entered blinks in the MANUAL mode when programmer functions are selected. Either of “h:min” or “min:s” is selected as the time unit in setup settings. Select either “remaining segment time” or “total operating time” in setup settings as the details whose time is to be displayed.

■ Display in constant-value operation mode

●  functions

Output Model No.	Display
0D, 5G, 6D	Display 1 → Display 2 → Display 1 (repeated)
2G	Display 1 → Display 2 → Display 3 → Display 1 (repeated)
3D, 5K	Display 1 → Display 2 → Display 4 → Display 1 (repeated)

● Display 1

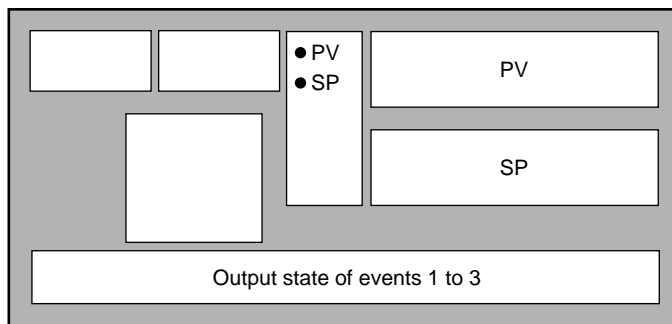

The digit to which SP values can be entered blinks in the MANUAL mode when controller functions are selected.

● Display 2

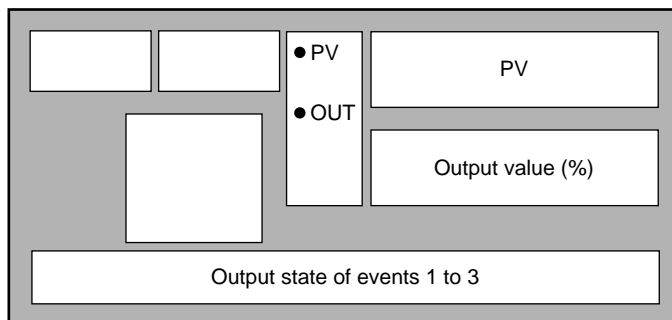

The digit to which SP values can be entered blinks in the MANUAL mode when programmer functions are selected.

● Display 3

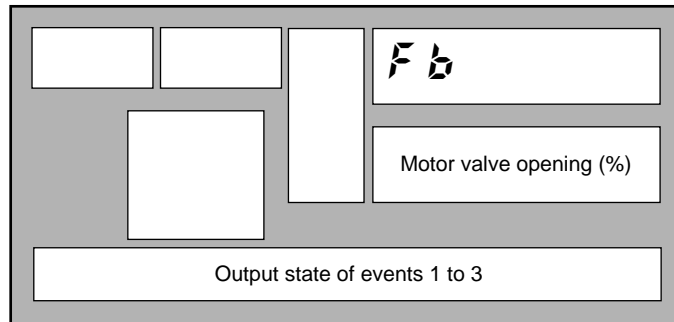

This display is exclusive to 2G output models (output catalog No. appended with 2G).

● Display 4

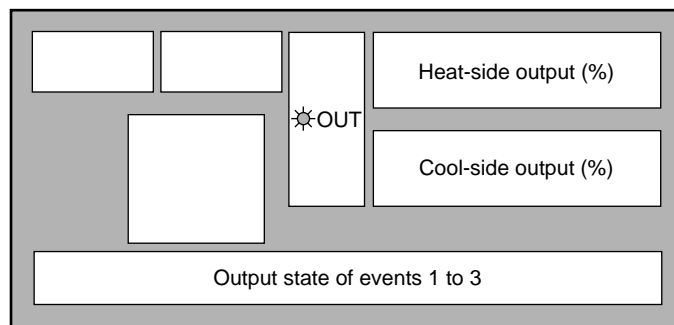

This display is exclusive to heat/cool output models (output catalog No. appended with 3D or 5K).

## 6-3 Program Selection

The program No. can be selected on the console within the range 1 to 19.

### ■ How to select the program No.

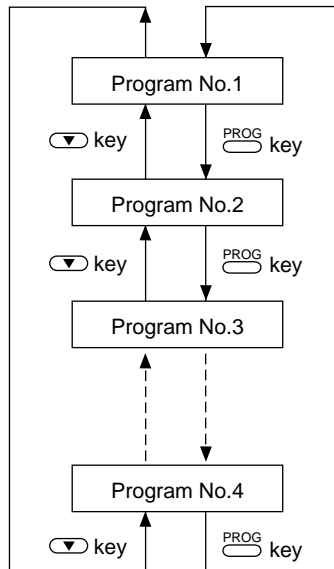

When the controller is in the basic display state in the program operation READY mode:

- Each press of **PROG** key increments the program No. The display reverts to 1 after 19.
- Each press of **key** decrements the program No. The display reverts to 19 after 1.

### ! Handling Precautions

- Both already set or non-set program Nos. can be selected
- The program No. cannot be selected when selecting the program No. by external switch input.
- The program No. cannot be selected during constant-value operation.
- Pressing **key** does not change the program No. when values currently being entered are displayed in the MANUAL mode.



## 6-4 External Switch (RSW) Operations

### ■ External switch (RSW) inputs

In all, the DCP301 is provided with 12 external switch inputs. Each of these inputs are differentiated by RSW1, RSW2 and so forth to RSW12. On models whose option 2 catalog No. is "0", only inputs RSW1 to RSW4 are mounted.

(RSW: external switch input)

#### ● External switch input types

The functions of RSW1 to 4, and RSW8 to 12 are fixed.

The functions of RSW5 to 7 are selected by the setup setting.

External Switch No.	Function	Detection Method
RSW1	RUN	Rising edge
RSW2	HOLD	Rising edge
RSW3	RESET	Rising edge
RSW4	ADV	Rising edge
RSW5 RSW6 RSW7	Selected by setup from the following functions	
	FAST	Rising edge
	PV start	Rising edge
	AUTO/MANUAL	Rising/falling edge
	AT start/stop	Rising/falling edge
	G.Soak cancel by OR conditions	Status
	G.Soak cancel by AND conditions	Status
	Direct/reverse action switching	Status
RSW8	Program No. selection    Weighting 1	Status
RSW9	Program No. selection    Weighting 2	Status
RSW10	Program No. selection    Weighting 4	Status
RSW11	Program No. selection    Weighting 8	Status
RSW12	Program No. selection    Weighting 10	Status

- With PV is valid only in the program operation mode and READY mode, and the PV start RUN mode is entered regardless of the PV start setting in the program. Note, however, that RUN mode is entered from the start point of the selected segment in READY mode when there is no SP for the PV start.
- With G.Soak cancel by OR conditions, G.Soak standby is canceled when the external switch turns ON or when the PV enters the G.Soak width.
- With G.Soak cancel by AND conditions, G.Soak standby is canceled when the external switch turns ON or when the PV enters the G.Soak width.
- When the external switch turns ON by direct/reverse action switching, control operation is the opposite to that set in setup parameter  $\zeta 0 1$ . When the external switch turned OFF, control operation is that set in setup parameter  $\zeta 0 1$ .

## ■ Program selection

The program can be selected in the program operation READY mode. The table below shows program selection by external switch inputs. Two external switch states are provided for selection of programs 10 to 15. When program selection by external switch inputs is set to "0", the program can be selected by the console keys and by communication with a personal computer.

External Switch No.	Weighting	State									
RSW8	1	OFF	ON	OFF	ON	OFF	ON	OFF	ON	OFF	ON
RSW9	2	OFF	OFF	ON	ON	OFF	OFF	ON	ON	OFF	OFF
RSW10	4	OFF	OFF	OFF	OFF	ON	ON	ON	ON	OFF	OFF
RSW11	8	OFF	OFF	OFF	OFF	OFF	OFF	OFF	OFF	ON	ON
RSW12	10	OFF	OFF	OFF	OFF	OFF	OFF	OFF	OFF	OFF	OFF
Program No. Selection		0	1	2	3	4	5	6	7	8	9

External Switch No.	Weighting	State											
RSW8	1	OFF	OFF	ON	ON	OFF	OFF	ON	ON	OFF	OFF	ON	ON
RSW9	2	OFF	ON	OFF	ON	ON	OFF	ON	OFF	OFF	ON	OFF	ON
RSW10	4	OFF	OFF	OFF	OFF	OFF	ON	OFF	ON	ON	ON	ON	ON
RSW11	8	OFF	ON	OFF	ON	OFF	ON	OFF	ON	OFF	ON	OFF	ON
RSW12	10	ON	OFF	ON	OFF	ON	OFF	ON	OFF	ON	OFF	ON	OFF
Program No. Selection		10		11		12		13		14		15	

External Switch No.	Weighting	State									
RSW8	1	OFF	ON	OFF	ON	OFF	ON	OFF	ON	OFF	ON
RSW9	2	ON	ON	OFF	OFF	ON	ON	OFF	OFF	ON	ON
RSW10	4	ON	ON	OFF	OFF	OFF	OFF	ON	ON	ON	ON
RSW11	8	OFF	OFF	ON	ON	ON	ON	ON	ON	ON	ON
RSW12	10	ON	ON	ON	ON	ON	ON	ON	ON	ON	ON
Program No. Selection		16	17	18	19	0					

## ■ Read timing

### ● Timing of RSW1 to 7

Inputs RSW1 to RSW7 are read according to the following timing.

- (1) When input changes state from OFF to ON, the time from the change up to reading is 0.2s max.
- (2) When input changes state from ON to OFF, the time from the change up to reading is 0.2s max.

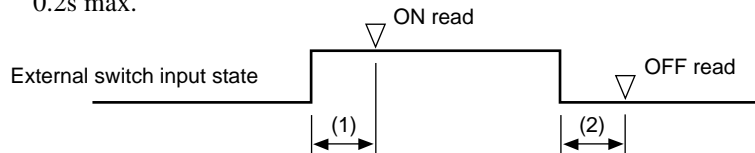

### ● Timing of RSW8 to 12, RUN and PV start

The time from the change in input state up to reading when selecting program Nos. by RSW8 to RSW12 is 0.4s max.

Accordingly, due to the relationship with RUN operation, be sure to observe timings ① to (4) in the following diagram.

PV start operation also must conform to RUN operation.

- (1) The time from fixing of the selected No. up to the rising edge of the RUN signal is 0.4s min.
- (2) The time from the rising edge of the RUN signal up to holding of the program No. is 0.2s min.
- (3) The time from holding of RUN signal OFF up to the rising edge of the RUN signal is 0.2s min.
- (4) The time from the rising edge of the RUN signal up to holding of RUN signal ON is 0.2s min.
- (5) The time from fixing of the selected No. up to changing of the program No. is 0.4s max.
- (6) The time from the rising edge of the RUN signal up to start of RUN is 0.4s max.

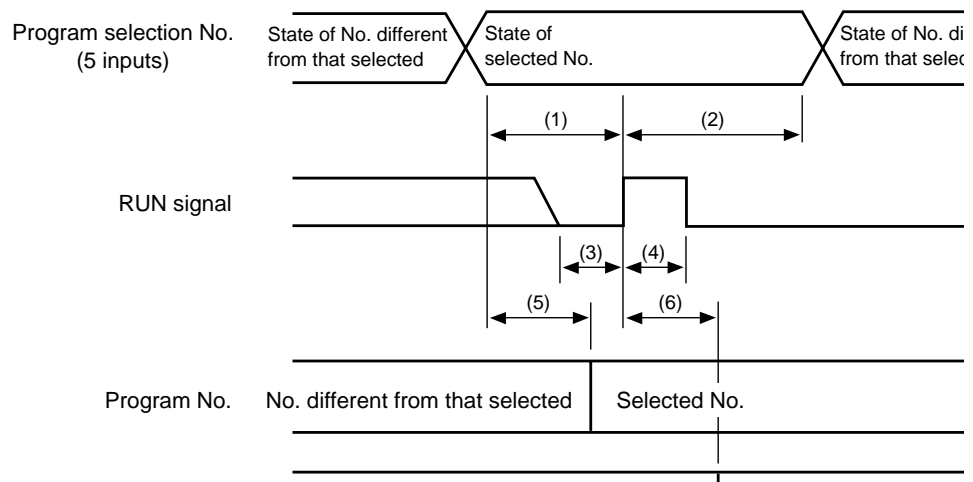

## ! Handling Precautions

When operating the controller by external switch inputs, operation can be carried out more reliably if a margin is added to the minimum time for the above read times.

## 6-5 Manual Operation and Auto-tuning

### ■ Manual operation

In the MANUAL mode, controller outputs can be manipulated by  $\blacktriangle$  or  $\blacktriangledown$  on the console.

#### ● Controller functions

When outputs are displayed in the basic display state, only one digit in the output value blinks. If the output value is incremented or decremented by  $\blacktriangle$  or  $\blacktriangledown$ , actual output also increments or decrements. Output values differ from values being entered to setting items in that  $\text{ENT}$  need not be pressed.

The blinking digit can be moved by pressing  $\blacktriangleleft$  or  $\blacktriangleright$ .

On 2G output models, when only estimated position-proportional control is selected by variable parameter  $\text{P} \cdot \zeta$  setting 2, “—” not the value is displayed as the output display in the MANUAL mode.

Pressing  $\blacktriangle$  displays “o P E n”, and the open-side relay turns ON.

Pressing  $\blacktriangledown$  displays “z L o S”, and the closed-side relay turns ON.

Bump-less and preset output changes when shifting from the AUTO to the MANUAL mode can be selected by setup parameter  $\zeta \text{ IS}$  setting. When shifting from the MANUAL to the AUTO mode, output is bumpless.

(However, when the total time for the PID parameter of the PID set in use is set to “0”, a sudden change in output occurs.)

#### ● Programmer functions

On 5G output models, when programmer functions are in operation with setup data  $\zeta \text{ IS}$  setting 1, SP can be manually manipulated. When SP is displayed in the basic display state, only one digit in the SP value being entered blinks. When the SP value is incremented or decremented by  $\blacktriangle$  or  $\blacktriangledown$ , the actual SP output also increments or decrements. SP values differ from values being entered to setting items in that  $\text{ENT}$  need not be pressed.

The blinking digit can be moved by pressing  $\blacktriangleleft$  or  $\blacktriangleright$ .

Output changes when shifting from the AUTO to the MANUAL mode are bumpless regardless of setup data  $\zeta \text{ IS}$  setting. When shifting from the MANUAL to the AUTO mode, the SP becomes the program pattern SP, which results in a sudden change in output.

### ■ Auto-tuning (AT)

When operating in the AUTO mode in either of the RUN, HOLD, FAST or END modes, setting values can be automatically written to the PID set in use by auto-tuning (AT). The following can be selected by variable parameter  $\text{P} \cdot \zeta$  setting.

0: AT is disabled.

1: General AT is executed.

2: Overshoot-inhibited AT is executed.

3: AT by neural net is executed.

- Auto-tuning does not function when programmer functions are selected on 3D or 5K heat/cool output models and 5G output models.
- During execution of auto-tuning, progress of program operation time stops. Accordingly, the controller is in a similar state to the HOLD mode even in the RUN or FAST modes.

- Auto-tuning in all instances involves calculating the downtime and critical sensitivity of the line according to two limit cycles and PID values according to suitable characteristic equations for each, and automatically writing these PID values.
- During execution of auto-tuning, PV fluctuates according to fluctuations in MV. Before executing auto-tuning, make sure that fluctuations in PV will not cause controller trouble.
- Normally, suitable values are written by setting variable parameter At setting to 1 or 3. However, when executing auto-tuning on a line that easily overshoots, either set to 2, or also use smart-tuning for carrying out overshoot inhibit control. Setting to 3 executes AT by neural net so that the suitable value is calculated for wider range applications.
- The point at which output at auto-tuning is inverted (lower limit to upper limit, and vice versa) is determined as follows from SP and PV at start of auto-tuning.

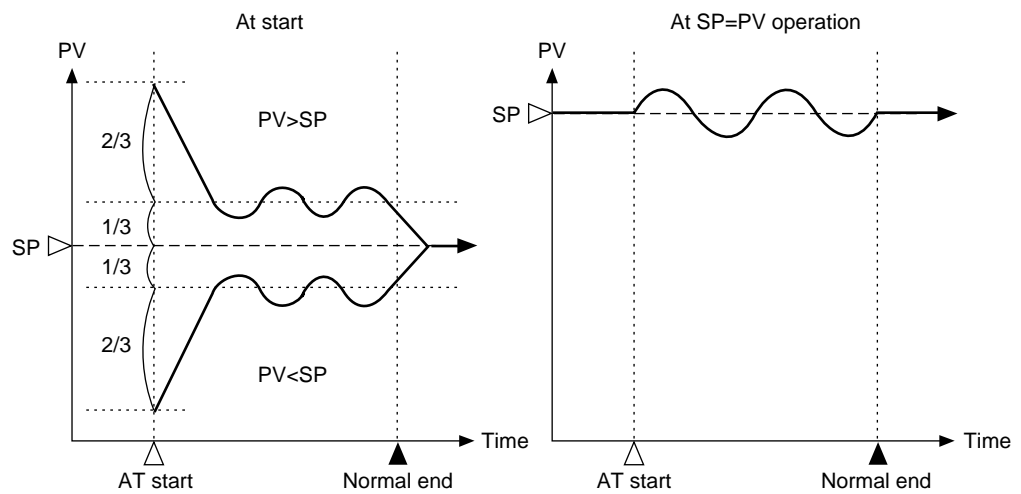

- Auto-tuning can be started by  $\overline{AT}$ , external switch inputs and communications. During auto-tuning, the AT LED blinks.
- If one or more of the following conditions occurs during auto-tuning, auto-tuning is canceled without PID constants being written, and the AT LED goes out.
  - Cancel by  $\overline{AT}$
  - Cancel by external switch input
  - Cancel by communications
  - Change in mode (shift to MANUAL mode or READY mode)
  - Execution of automatic motor valve opening adjustment on 2G output models
  - When variable parameter  $\overline{H}$  setting is changed to "0"
  - When input 1 becomes out-of-range

### ! Handling Precautions

- Auto-tuning will not function properly unless the control target is connected.
- The time from start to end of auto-tuning varies according to the control target.
- When auto-tuning is executed, control is stopped, OFF and ON outputs are switched in the case of relay output and voltage output, and the manipulated variable upper and lower limits of the currently selected PID set are switched several times in the case of current output and position proportional output. If this causes controller trouble, manually set the PID value.
- Sometimes a suitable PID value cannot be obtained depending on the control target. If this happens, manually set the PID value.

# Chapter 7. PARAMETER SETUP

## 7-1 Parameter Setup

Parameters can be set up when the DCP301 is in the basic display state.

If the DCP301 is not in the basic display state, press  $\overline{\text{DISP}}$  to set the controller to the basic display state.

### ■ Selecting the setting group in the parameter setup

Parameter setup is divided into two stages: setting group (major item) and individual item (minor item).

If you press  $\overline{\text{FUNC}}$  +  $\overline{\text{PARA}}$  in the basic display state, the display changes to selection of setting group (major item), the setting group is displayed on the upper display, and the lower display goes out.

If you press  $\overline{\text{PARA}}$ ,  $\blacktriangle$  or  $\blacktriangledown$ , the setting group display changes in order.

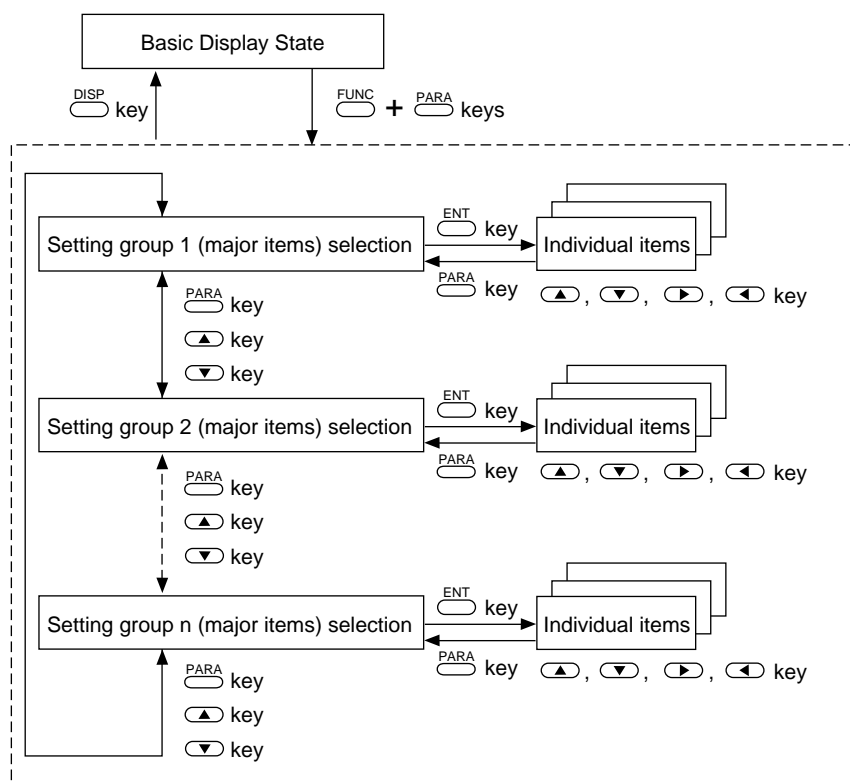

If you press  $\overline{\text{ENT}}$  when the setup group to be selected is displayed, the display moves to the individual (minor) item level.





The following table shows the setting groups.

Name	Upper Display	Remarks
Variable parameters	$\overline{\text{PARA}}$	
Event configuration data	$\overline{\text{EV}}$	This parameter is not displayed when variable parameter $\overline{\text{LOC}}$ is 2 or 4
PID parameters	$\overline{\text{PID}}$	This parameter is not displayed when variable parameter $\overline{\text{LOC}}$ is 2 or 4 This parameter is not displayed when constant-value operation data $\overline{\text{MODE}}$ is 1 This parameter is not displayed when setup data $\overline{\text{C10}}$ is 1 by 5G output This parameter is not displayed when setup data $\overline{\text{C45}}$ is 1 by 3D output
Setup data	$\overline{\text{SET}}$	This parameter is not displayed when variable parameter $\overline{\text{LOC}}$ is 1, 2 or 4
Table data	$\overline{\text{tbl}}$	This parameter is not displayed when variable parameter $\overline{\text{LOC}}$ is 2 or 4
Constant-value operation data	$\overline{\text{cnst}}$	This parameter is not displayed when variable parameter $\overline{\text{LOC}}$ is 2 or 4





### ■ Moving individual items in the parameter setup

With individual items, item codes are displayed in the upper display and setting values are displayed in the lower display.



The program No. display goes out, and the item No. is displayed in the segment No. display. However, note that the segment No. display also goes out in the case of setup data.



Individual items are arranged in a matrix as shown on the following page, and can be displayed in order by pressing , ,  or . The size of individual item matrices varies according to the setting group.

### ■ Changing individual items and how to return from the setup state

If you press  when an individual item is displayed, the setting value blinks. This state is referred to as the “setting value entry state.” In this state, pressing  or  can increment or decrement the setting value that is blinking. Also, pressing  or  moves the position of the digit that is blinking.

If you press  when the setting value is at the desired value, blinking stops, the display returns to its normally lit state, and the new setting value is stored to internal memory.

To cancel changing of setting values, press  or . When  is pressed, the value stops blinking and the display returns to its normal lit state.

If you press , the display returns to the basic display state. If “- - -” is displayed at the lower display when an individual item is displayed, or the controller does not enter the setting value entry state by pressing , that item cannot be set nor changed.

- Example of individual item matrix (setup date)

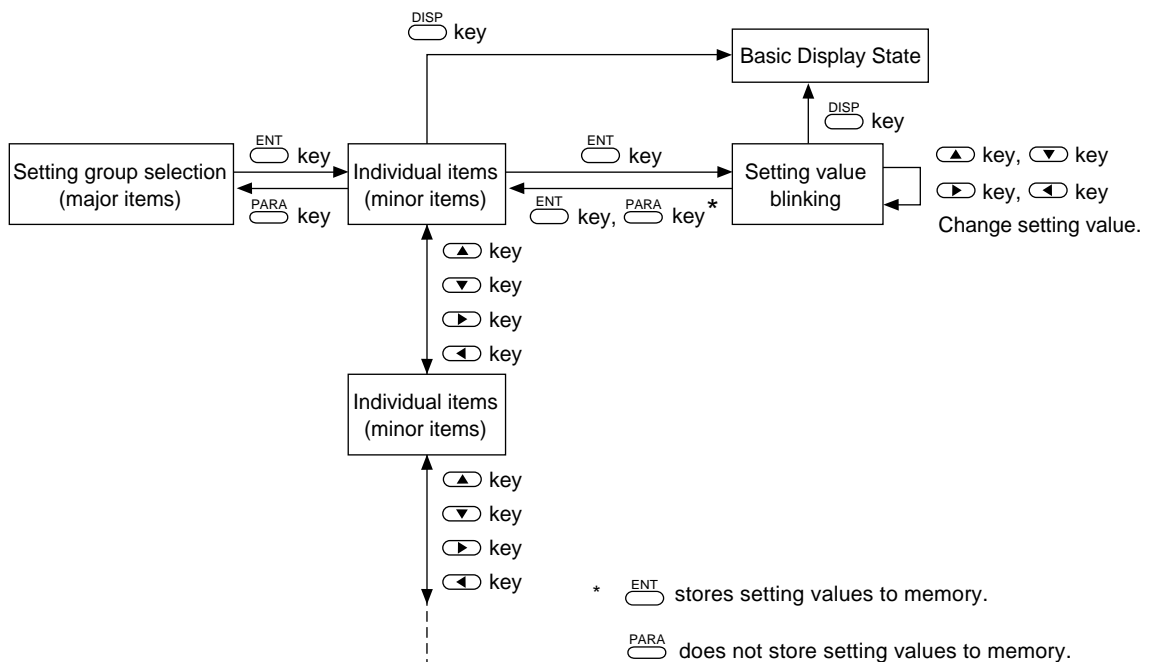
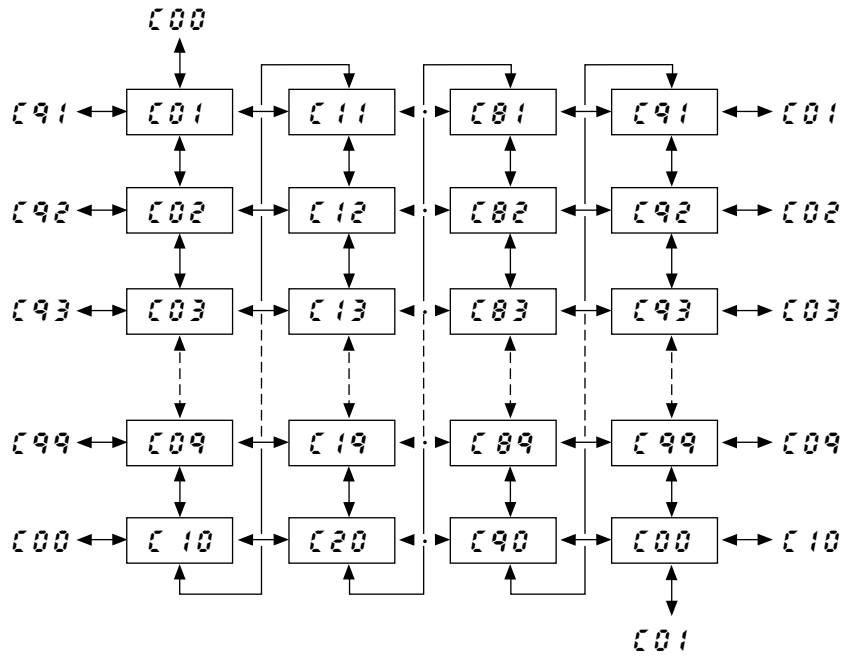





## 7-2 How to Use



Use  for calling up individual items in frequently changed parameters.

### ■ How to register functions to keys

Up to eight individual items in the parameter setup can be assigned to each  key. The assignment item must be registered to use this feature.

This feature allows you to call up individual items more easily in the following order:  
 +  → selection of setting group → individual item matrix.

### ● How to register assignment items

To register an assignment item, add the following base corresponding to the setting group to the item No., and then set the resultant value to setup data  to  (  assignment items 1 to 8)).

Base	Setting Group
1000	Constant-value operation data
1500	PID parameters
2500	Variable parameters
3500	Event configuration data
4000	Table data
4500	Setup data

### ● Example

Let's register four individual items to  $\overline{\text{PARA}}$ . If you press  $\overline{\text{PARA}}$  in the basic display state, the 1st to 4th individual items in the table below are displayed successively. In this example, let's change the setting values.

Order	Item to Call by $\overline{\text{PARA}}$
1	Setup data $\overline{\text{C01}}$
2	PID parameter $\overline{\text{P-2}}$
3	Variable parameter $\overline{\text{FL}}$
4	Variable parameter $\overline{\text{FRSt}}$

The settings for registering these individual items are as follows.

Setup Data Setting " $\overline{\text{SEt}}$ "

No.	Item Code [auxiliary display]	Item	Setting Value	Remarks
55	$\overline{\text{C55}}$	$\overline{\text{PARA}}$ assignment item 1	4501	This is produced by adding item No.1 of $\overline{\text{C01}}$ to setup data radical 4500.
56	$\overline{\text{C56}}$	$\overline{\text{PARA}}$ assignment item 2	1511	This is produced by adding item No.11 of $\overline{\text{P-2}}$ to PID parameter radical 1500.
57	$\overline{\text{C57}}$	$\overline{\text{PARA}}$ assignment item 3	2503	This is produced by adding item No.3 of $\overline{\text{FL}}$ to setup data radical 2500.
58	$\overline{\text{C58}}$	$\overline{\text{PARA}}$ assignment item 4	2520	This is produced by adding item No.20 of $\overline{\text{FRSt}}$ to variable parameter radical 2500.

### ! Handling Precautions

- For details on item Nos., see 7-3 Parameter Setup List (pages 7-7 to 7-42).
- When the " $\overline{\text{PARA}}$  assignment item" setting is set to a value that does not correspond to an existing item, that setting is ignored.

For example, though factory setting 1000 corresponds to "constant-value operation data" 0th of base 1000, 0th does not exist, so the setting will be treated as an invalid data and will not be registered.

### ● Operations by $\overline{\text{PARA}}$

If you press  $\overline{\text{PARA}}$  in the basic display state, registered individual items are called up. Each press of  $\overline{\text{PARA}}$  successively calls up (up to eight) registered individual items. Only individual items to which valid assignment settings have been registered can be called up.

$\overline{\text{PARA}}$  operations are not limited by the setting of "variable parameter setup"  $\overline{\text{L0L}}$  (key lock) setting.  $\overline{\text{PARA}}$  operations are described on the following page.

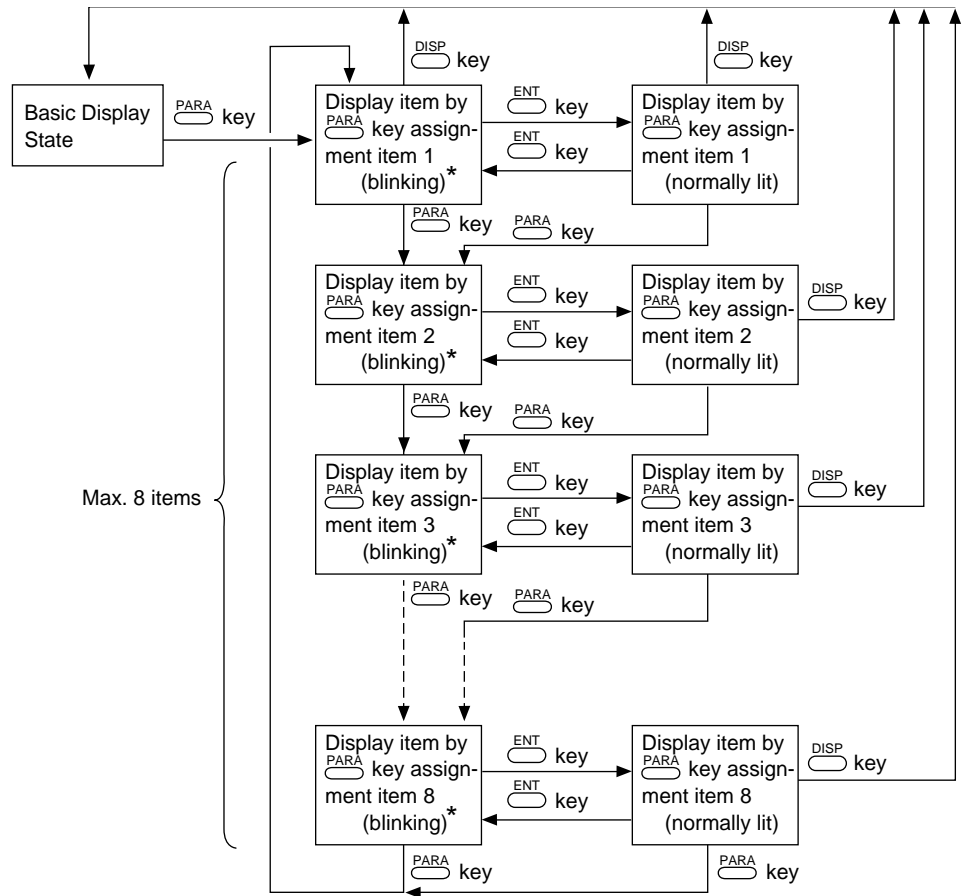

**! Handling Precautions**

When invalid assignments are registered, that item is skipped and the next registered item is displayed.

\* Items that can be changed: When these items are displayed blinking, the setting values can be changed by ▲, ▼, ► and ◀. ENT stores data to memory.

Items for reference: These are displayed at all times.

## 7-3 Parameter Setup List



**Note** “U” and “%FS” used in the “Factory Setting” and “Setting” columns in the table mean the following:

U: The decimal point changes according to the input range type setting. For example, when one digit past the decimal point is allowed, -1999U becomes 199.9, and 9999U becomes 999.9.

%FS: The numbers and decimal point position changes according to the input range setting.

For example, when the input range is 0.0 to 800.0°C, 0%FS is 0.0 and 100%FS is 800.0.

### ■ Variable parameter settings “P A R A”

No.	Item Code	Item	Factory Setting	User Setting	Setting
1	LoE	Key lock	0		0: Key lock disabled 1: Display of setup data settings disabled 2: Display of parameter settings and program settings disabled 3: Use of operation keys disabled 4: Display of parameter settings and program settings displayed, and use of operation keys disabled [Note] Two or more key lock setting values for actual key lock items and items assigned to  can be displayed and set.
2	PrE	Program protect	0		0: Changing program settings enabled 1: Changing program settings disabled
3	FL	Input 1 digital filter	0.0		0.0 to 120.0s [Note] 0.0 disables the filter.
4	PbI	Input 1 bias	0U		-1000 to 1000U
5	SbI	SP1 bias	0U		-1999 to 9999U
6	oEL	MV change limiter (CH1)	0.0		0.0 to 10.0% (0.1% steps) [Note] 0.0 disables the limit.
7	IoUE	PID operation initial MV (CH1)	0.0 (50.0)		0.0 to 100% [Note] On heat/cool models, the factory setting is 50.0.
8	rPID	PID operation initialization	0		0: Automatic judgment of initialization is carried out by advance operation. 1: Initialization is carried out by advance operation. 2: Initialization is not carried out by advance operation.
9	At	Auto-tuning method selection (CH1)	0		0: AT is disabled. 1: General AT is executed. 2: Overshoot-inhibited AT is executed. 3: AT by neural net is executed. [Note] On heat/cool models, “- - - -” is displayed, and setting is not possible.
10	St	Smart-tuning method selection (CH1)	0		0: Smart-tuning is disabled. 1: The brake value is fixed to inhibit overshoot. 2: Overshoot is inhibited while automatically reviewing the brake value. [Note] On heat/cool models, “- - - -” is displayed, and setting is not possible.
11	2PID	Advanced PID selection (CH1)	0		0: 2 degrees of freedom PID is disabled. 1: 2 degrees of freedom PID is enabled. [Note] On heat/cool models, “- - - -” is displayed, and setting is not possible.

No.	Item Code	Item	Factory Setting	User Setting	Setting
12	<del>95.k</del>	G.Soak time (CH1)	2.0		0.1 to 60.0s
13	<del>CP.11</del>	PID auto-switching point 1-1	0U		-1999 to 9999U [Note]
14	<del>CP.12</del>	PID auto-switching point 1-2	200U		When setup data <del>CP.11</del> setting is 0 (PID set auto-switching OFF), "----" is displayed and setting is not possible.
15	<del>CP.13</del>	PID auto-switching point 1-3	400U		
16	<del>CP.14</del>	PID auto-switching point 1-4	600U		
17	<del>CP.15</del>	PID auto-switching point 1-5	800U		-1999 to 9999U [Note]
18	<del>CP.16</del>	PID auto-switching point 1-6	1000U		On heat/cool models, "----" is displayed and setting is not possible. On other models, when setup data <del>CP.11</del> setting is 0 (PID set auto-switching OFF), "----" is displayed and setting is not possible.
19	<del>CP.17</del>	PID auto-switching point 1-7	1200U		
20	<del>FAST</del>	FAST factor	0		0: 2X 1: 10X 2: 60X (10X) 3: 120X (10X) [Note] When setup data <del>CP.14</del> setting is 1 (program time unit:min/s), the FAST factor is 10X for settings 2 and 3.
21	<del>DIFF</del>	ON-OFF control differential	5U		0 to 1000U [Note] This setting is displayed on 0D and 6D models.
		Position-proportional dead zone	5.0		0.5 to 25.0% [Note] This setting is displayed on 2G output models.
		Heat/cool control dead zone	0.0		-100.0 to 50.0% [Note] This setting is displayed on heat/cool models.
					[Note] On 5G output models, "----" is displayed and setting is not possible.
22	<del>CY.1</del>	Output 1 time-proportional output cycle	10		5 to 120s (relay output) 1 to 60s (voltage output) [Note] On models whose output 1 is neither relay output nor voltage output, "----" is displayed and setting is not possible.
23	<del>CY.2</del>	Output 2 time-proportional output cycle	10		5 to 120s (relay output) 1 to 60s (voltage output) [Note] On models whose output 2 is neither relay output nor voltage output, "----" is displayed and setting is not possible.
24	<del>CY.3</del>	Unused	-		[Note] "----" is displayed and setting is not possible.
25	<del>DU-L</del>	3-position control deviation lower limit	5U		0 to 1000U [Note] On models other than 3D output models, "----" is displayed and setting is not possible.
26	<del>DU-H</del>	3-position control deviation upper limit	5U		
27	<del>HY-L</del>	3-position control lower limit hysteresis	5U		
28	<del>HY-H</del>	3-position control upper limit hysteresis	5U		

No.	Item Code	Item	Factory Setting	User Setting	Setting
29	Ń.-Ĺ	Motor control method selection	0		0: MFB control (conventional) + estimated position control 1: MFB control (conventional) only 2: Estimated position control only [Note] On models other than 2G output models, "----" is displayed and setting is not possible.
30	Ń.-ŃĹ	Motor valve opening automatic adjustment	0		0: Adjustment disabled 1: Adjustment enabled [Note] On models other than 2G output models, "----" is displayed and setting is not possible. On 2G output models, when Ń.-Ĺ setting is 2, "----" is displayed and setting is not possible.
31	Ń.-ĹĹ	Motor valve opening adjustment fully closed position	1000		0 to (fully open adjustment - 500) [Note] On models other than 2G output models, "----" is displayed and setting is not possible. On 2G output models, when Ń.-Ĺ setting is 2, "----" is displayed and setting is not possible.
32	Ń.-ŃĹ	Motor valve opening adjustment fully open position	9000		(fully closed adjustment + 500) to 9999 [Note] On models other than 2G output models, "----" is displayed and setting is not possible. On 2G output models, when Ń.-Ĺ setting is 2, "----" is displayed and setting is not possible.
33	Ń.-Ĺ	Motor valve opening adjustment fully open/closed time	30.0		5.0 to 240.0s [Note] On models other than 2G output models, "----" is displayed and setting is not possible.

## ■ Description of variable parameter settings

### ● $L O L$ (key lock)

- 0: Key lock disabled
- 1: Display of setup data settings disabled
- 2: Display of parameter settings and program settings disabled
- 3: Use of operation keys disabled
- 4: Display of parameter settings and program settings displayed, and use of operation keys disabled

- When  $L O L$  is set to 1, the following keys are disabled.

Basic display state:  $\text{FUNC} + \text{CLR} + \text{DISP}$  (general reset)

Only  $S E L$  can be selected by setting group selection in the parameter setup state.

- When  $L O L$  is set to 2, the following keys are disabled.

Basic display state:  $\text{FUNC} + \text{PROG}$  (program setup)

$\blacktriangle + \text{PROG}$  (program copy)

$\text{FUNC} + \text{CLR} + \text{DISP}$  (general reset)

Only  $P R R R$  can be selected by setting group selection in the parameter setup state.

However, note that items assigned to  $\text{PARA}$  can be called up by  $\text{PARA}$  in the basic display state.

- When  $L O L$  is set to 3, the following keys are disabled.

Basic display state:  $\text{PROG}$  (program selection)

$\blacktriangledown$  (program selection)

$\text{RUNHOLD}$  (RUN, HOLD)

$\text{PROG} + \text{RUNHOLD}$  (RESET)

$\text{PROG} + \text{DISP}$  (ADV)

$\text{FUNC} + \blacktriangleright$  (FAST)

$A/M$  (AUTO, MANUAL)

$AT$  (AT start, AT cancel)

$\text{FUNC} + \text{CLR} + \text{DISP}$  (general reset)

However, note that MV (when controller functions are selected) and SP (when programmer functions are selected) can be changed in the basic display state in the MANUAL mode.

- When  $L O L$  is set to 4, all keys disabled when  $L O L$  is set to 2 and 3 are disabled.

### ● $P R P L$ (program protect)

- 0: Changing program settings enabled

- 1: Changing program settings disabled

When  $P R P L$  is set to 1, the following keys are disabled.

Basic display state:  $\blacktriangle + \text{PROG}$  (program copy)

$\text{FUNC} + \text{CLR} + \text{DISP}$  (general reset)

Program setup state:  $\text{ENT}$  (start of value entry)

$\text{FUNC} + \text{ENT}$  (segment insert/delete)

● **ΔL (MV change limit)**

The MV is increased or decreased by the same value so that the output change is taken as the limit setting value when the output change (%) after PID operation is greater than this limit setting.

The following example shows the actual change in MV when the MV changes from 20% to 22% with the change limit setting at 0.5%. MV is output at 0.5% setting value increments every 0.1s, and reaches 22% in 0.4s.

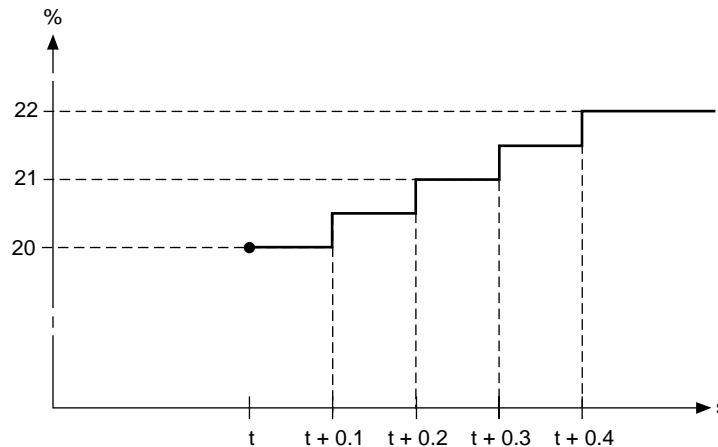

● **Δ (PID operation initial MV)**

PID operation is started in the following cases using the  $\Delta$  setting value:

- When the mode changes from READY AUTO to RUN AUTO
- When the power is turned ON in the RUN AUTO (or HOLD, FAST, END AUTO) mode
- At completion of auto-tuning

As the PV, SP and PID parameters settings bear a relation to PID operation, the first MV resulting from PID operation will not necessarily match the  $\Delta$  setting value.

● **rPID (PID operation initialization)**

When SP changes suddenly by ADV (advance) operation, rate action in PID operation may cause the MV in the operation to change excessively. For this reason, excessive changes can be suppressed by initializing PID operation.

However, as initialization of PID operation may result in lost continuity, initialization may adversely influence PID operation depending on the circumstances in which the controller is being used.

Initialization ON/OFF and conditions can be selected by the  $rPID$  setting.



● **5 t (smart-tuning method selection)**

- 0: Smart-tuning is disabled.
- 1: The brake value is fixed to inhibit overshoot.
- 2: Overshoot is inhibited while automatically reviewing the brake value.

- When the control direction is set to reverse action, overshoot is inhibited. When set to direct action, undershoot is inhibited. Both functions are referred to collectively as “overshoot inhibit.”

When set to 1, the value of PID parameter setting item *b r* is used as it is to inhibit overshoot.

When set to 2, the value of *b r* is reviewed at each rise (reverse action) or fall (direct action), and overshoot is inhibited while the value is automatically rewritten.

Review is executed only in the direction in which the *b r* value is increased (overshoot inhibit effect becomes more apparent).

When operation is carried out for a long time with this parameter set to 2, overshoot inhibit may function too strongly, and it may take a long time to arrive at SP. So, when overshoot disappears, note down the *b r* value at that time, set **5 t** to 1, and reset the *b r* value to the noted down value.

- The AT LED lights while reviewing the *b r* value when set to 2.
- Do not set to 2 when normal control is not being carried out due to inappropriate tuning of the PID constant, for example.  
Also, hunting is more likely to occur when *b r* is set to a large value on quick-starting lines. Set the *b r* value to 0 then to 2.
- On heat/cool models, smart-tuning does not function.

● **2 P 1 d (2 degrees of freedom)**

- 0: 2 degrees of freedom is disabled.
- 1: 2 degrees of freedom is enabled.

- 2 degrees of freedom is a function for improving the response to disturbance during setup without losing conventional characteristics at rise (or fall).

When set to 1, optimum PID constants can be set individually for inhibiting disturbance in addition to conventional the PID constant.

These constants are set automatically during AT execution, and is memorized. They can also be set and changed independently.

In particular, on 2G output models, suppressing changes in MV to lessen the frequency of motor operation during setup, and manually applying weak PID differential for inhibiting disturbance to lengthen service life, for example, proves effective.

- These PID are switched automatically by applying fuzzy rules on the slope between deviation and PV.
- When *i* (reset time) is set to 0, control is carried out without integration in all states regardless of the setting value of *d i* (disturbance inhibit reset time).
- On heat/cool models, 2 degrees of freedom does not function.

● *diff*

- ON-OFF control differential

When P is set to 0.0 on both 0D and 6D output models, control is set to ON-OFF control, and operational period at that time is set.

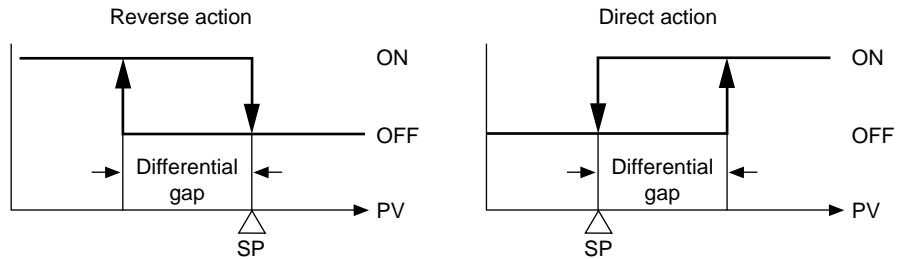

- Position-proportional control dead zone

On 2G output models, a dead zone between the motor open and motor closed positions is set.

As a general guideline, the minimum value is the value where this dead zone changes to stop motor hunting once a fixed value set to manual output is being output.

If this value is set without any margin, the motor will be operating at all times, which will considerably shorten its service life.

The factory setting is 5%. Use this as a guideline, and take the control results and motor service life into consideration when setting the dead zone.

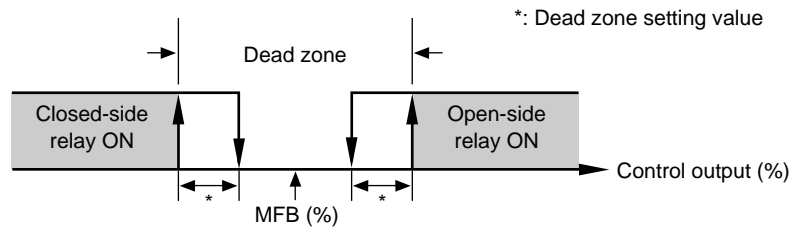

- Heat/cool control dead zone

On heat/cool models, this sets how the relationship between heat-side output and cool-side output should be processed with respect to the MV resulting from PID operation. Heat-cool control is calculated as follows:

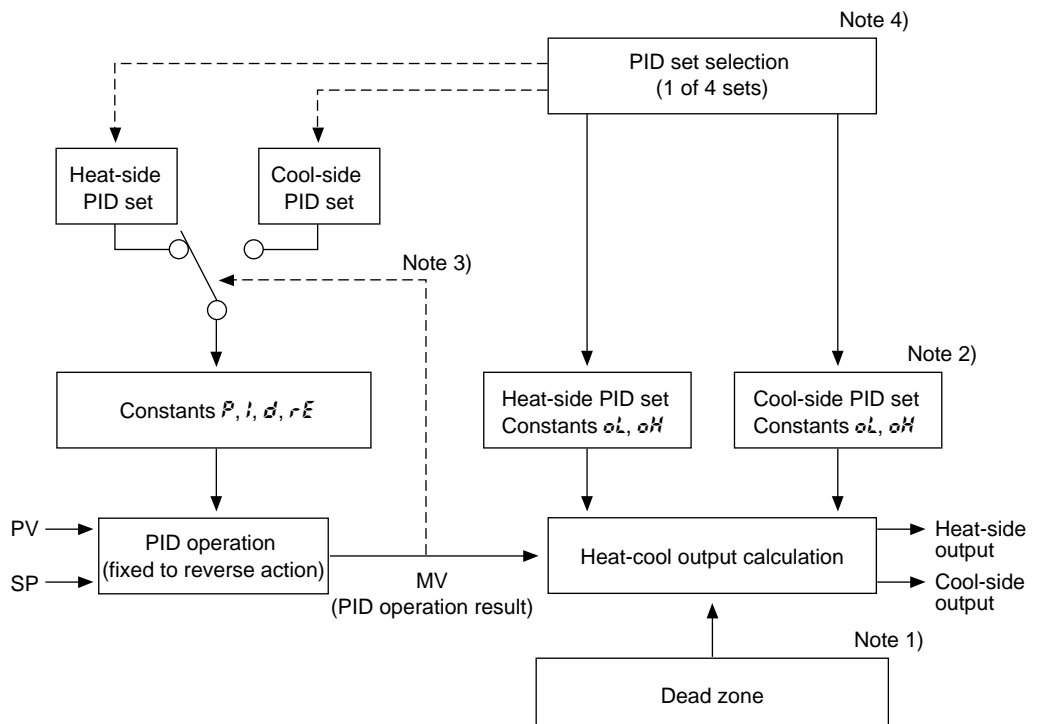

Note 1) On heat/cool models, this sets how the relationship between heat-side output and cool-side output should be processed with respect to the MV resulting from PID operation.

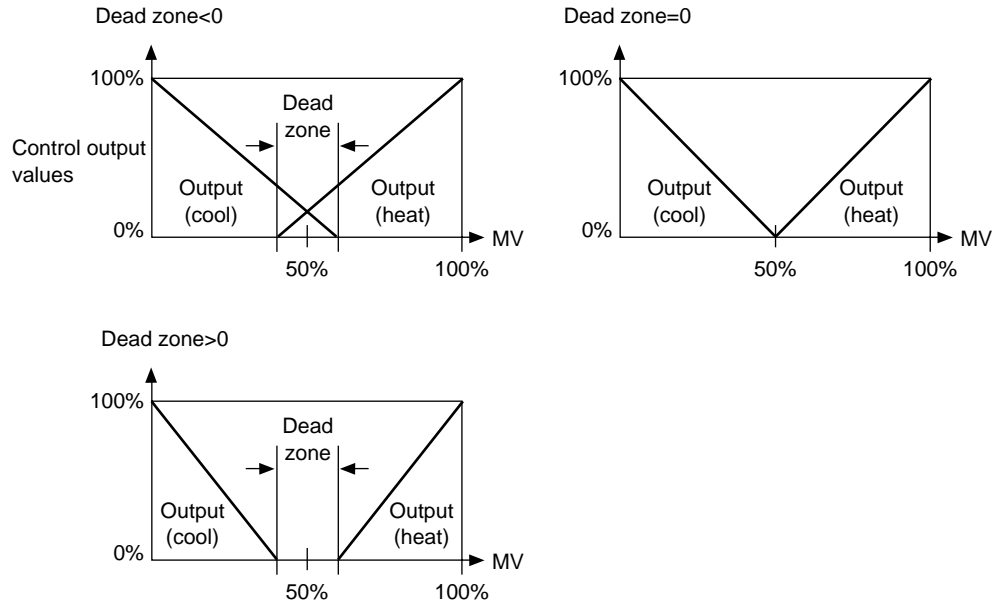

Note 2) Constants  $\sigma_c$  and  $\sigma_h$  function as follows:

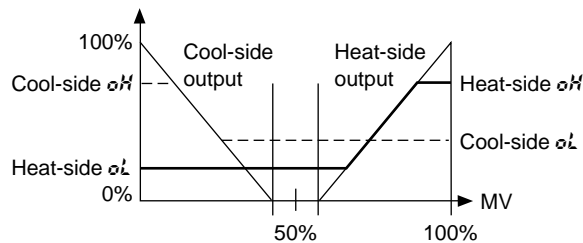

Note 3) When  $MV \geq 50\%$ , the heat-side PID set is switched to.  
When  $MV < 50\%$ , the cool-side PID set is switched to.

Note 4) PID set selection is carried out by setting value and external switch.

- $d_v - L$  (3-position control deviation lower limit)
- $d_v - H$  (3-position control deviation upper limit)
- $HY - L$  (3-position control lower limit hysteresis)
- $HY - H$  (3-position control upper limit hysteresis)

In 3-position control, control is carried out in the following three states in the RUN, HOLD, FAST and END modes.

State	Heat-side Output	Cool-side Output	MV
1	OFF (0.0%)	ON (100.0%)	0.0%
2	OFF (0.0%)	OFF (0.0%)	50.0%
3	ON (100.0%)	OFF (0.0%)	100.0%

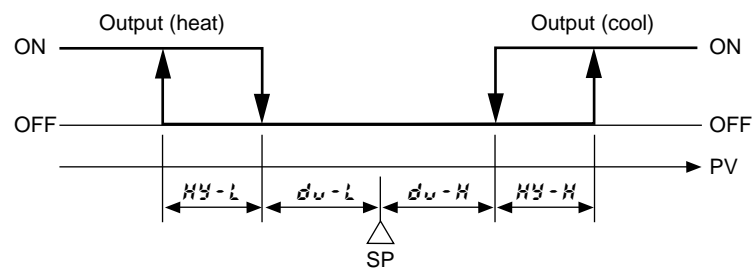

### ! Handling Precautions

Even in 3-position control, output is time-proportional in the READY mode. This is set in setup data  $\zeta 15$  (MV (heat) in READY mode) and  $\zeta 17$  (MV (cool) in READY mode).

When connecting an actuator that may burn by time-proportional output, set setup data  $\zeta 15$  and  $\zeta 17$  so that output in the READY mode is 0%.

●  $\bar{P}1$  (motor control method selection)

- 0: MFB control (conventional) + estimated position control
- 1: MFB control (conventional) only
- 2: Estimated position control only

• 0: MFB control (conventional) + estimated position control

- When MFB (Motor Feed Back) input is normal, the motor position is controlled by the actually measured MFB.
- When MFB input is in error, the motor position is controlled by an estimated MFB value. This state is referred to as “estimated position control state.”

For example, when the motor rotates at a position where the feedback potentiometer has deteriorated, MFB input changes suddenly. This sudden change is detected as an error, and the correct MFB position is estimated. The motor position is also controlled by the estimated MFB value when the MFB disconnected alarm has occurred.

- In the estimated position control state, an error will inevitably occur between the actual motor valve opening and estimated MFB value.

So, set the closed-side relay to ON at all times when output (MV)  $\leq 0.0\%$ , and the open-side relay to ON at all times when MV  $\geq 100.0\%$  to set the motor to a fully-open or fully-closed state to compensate this error.

However, note that this error is not compensated when MV is limited to within 0.1 to 99.9% by the output limiter, or when MV is 0.0% or less or 100% or more due to the control state.

- The following are probable causes when estimated position control is likely to be carried out:
  - Defective motor valve opening adjustment
  - Deteriorated feedback potentiometer, insufficient resolution
  - Defective MFB wiring.

• 1: MFB control (conventional) only

- When this setting is used, conventional MFB control is carried out. When the MFB disconnected alarm occurs, the MFB value is regarded as 150.0%, and the closed-side relay is ON at all times.

• 2: Estimated position control only

- When this setting is used, control is in the estimated position control state at all times, and the motor position is controlled by the estimated MFB value regardless of the state of MFB wiring.
- When this setting is used, enter the correct  $\bar{P}1$  item.
- The MFB disconnected alarm does not occur.
- The error between actual motor valve opening and estimated MFB value is compensated by forcibly continuing motor operation in the closed or open directions when MV is 0.0% and 100%.

●  **$\bar{r}. - \bar{r} \bar{k}$  (motor valve opening automatic adjustment)**

- 0: Adjustment disabled
- 1: Adjustment enabled

This parameter automatically measures the motor fully closed position, fully open position, and close-open times. The results of calculation are automatically written to  $\bar{r}. - \bar{c} \bar{l}$ ,  $\bar{r}. - \bar{o} \bar{p}$  and  $\bar{r}. - \bar{t}$ .

• Adjustment Method and Motor Functions

1. Set  $\bar{r}. - \bar{c} \bar{l}$  to 0 or 1.
2. Set  $\bar{r}. - \bar{r} \bar{k}$  to 1, and press  $\overline{\text{ENT}}$ .  
If set to 1 already, press  $\overline{\text{ENT}}$  twice to enter automatic adjustment.
3. Automatic adjustment is carried out.
  - $\bar{c} \bar{r} \bar{c} \bar{l}$  is displayed on the upper display, and the closed-side relay turns ON.
  - The motor operates to the closed side, and the MFB count value is displayed on the lower display. When the count has stabilized, fully closed adjustment is completed, and the count value is written to  $\bar{r}. - \bar{c} \bar{l}$ .
  - $\bar{c} \bar{r} \bar{o} \bar{p}$  is displayed on the upper display, and the closed-side relay turns ON.
  - The motor operates to the open side, and the MFB count value is displayed on the lower display. When the count has stabilized, fully open adjustment is completed, and the count value is written to  $\bar{r}. - \bar{o} \bar{p}$ .

The time it took from fully closed to fully open is written to  $\bar{r}. - \bar{t}$ . However, note that if this time is 240.0s or more, the time is taken as 240.0s.

  - When all adjustments are completed, the controller returns to the basic display state.
4. To cancel automatic adjustment, press  $\overline{\text{DISP}}$ .

When automatic adjustment begins, you cannot press any keys other than  $\overline{\text{DISP}}$ .  $\overline{\text{DISP}}$  is used for canceling adjustment.

The following instances are regarded as errors. In these instances, the factory settings are returned to, and  $\bar{r} \bar{l} \bar{i} \bar{e}$  is displayed. The  $\bar{r} \bar{l} \bar{i} \bar{e}$  display can be cleared only when automatic re-adjustment has ended successfully or when the power has been reset.

- Fully closed count - fully open count < 500
- Fully closed count > fully open count
- Time from fully closed to fully open is less than 5s
- MFB disconnected alarm ( $\bar{r} \bar{l} \bar{i} \bar{e}$ ,  $\bar{r} \bar{l} \bar{i} \bar{i}$ ) occurs continuously or frequently
- The time taken for the MFB count to stabilize exceeds 5min
- Faulty wiring of MFB or switching relay  
(However, note that all faulty wiring cannot be detected as an error.)

●  **$\bar{r}. - \bar{t}$  (motor valve opening adjustment fully open/closed time)**

When  $\bar{r}. - \bar{c} \bar{l}$  is set to 2, the set time is taken as the base for all operations. Enter the time correctly in 0.1s units.

■ Event configuration data settings “E”

No.	Item Code	Item	Factory Setting	User Setting	Setting
1	E 1	Event 1 type	0		<p><u>PV type events</u>                      0: PV direct                      1: PV reverse                      2: Deviation direct                      3: Deviation reverse                      4: Absolute value deviation1 direct                      5: Absolute value deviation1 reverse                      6: SP direct                      7: SP reverse                      8: MV direct                      9: MV reverse                      10: MFB direct                      11: MFB reverse                      12 to 49: NOP</p> <p><u>Time events</u>                      50: Time event                      51 to 99: NOP</p> <p><u>Controller status events</u>                      100: RUN+HOLD+FAST+END                      101: READY                      102: RUN                      103: HOLD                      104: FAST                      105: END                      106: G.Soak standby                      107: MANUAL                      108: Auto-tuning executing                      109: Constant-value operation                      110: MFB estimated position control                      111: Sum of all alarms                      112: PV range alarm                      113: Controller alarm                      114: Low battery voltage                      115: Console setup in progress                      116: Loader setup in progress                      117: ADV (ON time 1s)                      118 to 199: NOP</p> <p>[Note]                      Setting can be changed only in READY mode.</p>
2	E 2	Event 1 standby	0		<p>0: Standby OFF                      1: Standby ON</p> <p>[Note]                      The controller stands by after power is restored and in the READY mode. When the event type setting is ≥ 50, “- - - -” is displayed and setting is not possible.</p>
3	H 3	Event 1 hysteresis	5		<p>0 to 200U (when event type is neither MV nor MFB)                      0.0 to 20.0% (when event type is MV or MFB)</p> <p>[Note]                      When the event type setting is ≥ 50, “- - - -” is displayed and setting is not possible.</p>
4	D 4	Event 1 ON delay time	0		0 to 3600s

No.	Item Code	Item	Factory Setting	User Setting	Setting
5	E t 2	Event 2 type	0		<p><u>PV type events</u></p> <p>0: PV direct  1: PV reverse  2: Deviation direct  3: Deviation reverse  4: Absolute value deviation1 direct  5: Absolute value deviation1 reverse  6: SP direct  7: SP reverse  8: MV direct  9: MV reverse  10: MFB direct  11: MFB reverse  12 to 49: NOP</p> <p><u>Time events</u></p> <p>50: Time event  51 to 99: NOP</p> <p><u>Controller status events</u></p> <p>100: RUN+HOLD+FAST+END  101: READY  102: RUN  103: HOLD  104: FAST  105: END  106: G.Soak standby  107: MANUAL  108: Auto-tuning executing  109: Constant-value operation  110: MFB estimated position control  111: Sum of all alarms  112: PV range alarm  113: Controller alarm  114: Low battery voltage  115: Console setup in progress  116: Loader setup in progress  117: ADV (ON time 1s)  118 to 199: NOP</p> <p>[Note]  Setting can be changed only in READY mode.</p>
6	E d 2	Event 2 standby	0		<p>0: Standby OFF  1: Standby ON</p> <p>[Note]  The controller stands by after power is restored and in the READY mode. When the event type setting is <math>\geq 50</math>, "----" is displayed and setting is not possible.</p>
7	H Y S 2	Event 2 hysteresis	5		<p>0 to 200U (when event type is neither MV nor MFB)  0.0 to 20.0% (when event type is MV or MFB)</p> <p>[Note]  When the event type setting is <math>\geq 50</math>, "----" is displayed and setting is not possible.</p>
8	d L 2	Event 2 ON delay time	0		0 to 3600s



No.	Item Code	Item	Factory Setting	User Setting	Setting
9	E t 3	Event 3 type	0		<p><u>PV type events</u>                      0: PV direct                      1: PV reverse                      2: Deviation direct                      3: Deviation reverse                      4: Absolute value deviation1 direct                      5: Absolute value deviation1 reverse                      6: SP direct                      7: SP reverse                      8: MV direct                      9: MV reverse                      10: MFB direct                      11: MFB reverse                      12 to 49: NOP</p> <p><u>Time events</u>                      50: Time event                      51 to 99: NOP</p> <p><u>Controller status events</u>                      100: RUN+HOLD+FAST+END                      101: READY                      102: RUN                      103: HOLD                      104: FAST                      105: END                      106: G.Soak standby                      107: MANUAL                      108: Auto-tuning executing                      109: Constant-value operation                      110: MFB estimated position control                      111: Sum of all alarms                      112: PV range alarm                      113: Controller alarm                      114: Low battery voltage                      115: Console setup in progress                      116: Loader setup in progress                      117: ADV (ON time 1s)                      118 to 199: NOP</p> <p>[Note]                      Setting can be changed only in READY mode.</p>
10	E d 3	Event 3 standby	0		<p>0: Standby OFF                      1: Standby ON</p> <p>[Note]                      The controller stands by after power is restored and in the READY mode. When the event type setting is ≥ 50, " - - - - " is displayed and setting is not possible.</p>
11	H Y 3	Event 3 hysteresis	5		<p>0 to 200U (when event type is neither MV nor MFB)                      0.0 to 20.0% (when event type is MV or MFB)</p> <p>[Note]                      When the event type setting is ≥ 50, " - - - - " is displayed and setting is not possible.</p>
12	d L 3	Event 3 ON delay time	0		0 to 3600s

No.	Item Code	Item	Factory Setting	User Setting	Setting
13	ㄷㄷ	Time event type	0		<p>0: T1 to T5 are all time events.            1: T1 is a segment No. event.               T2 to T5 are time events.            2: T1 and T2 are segment No. events.               T3 to T5 are time events.            3: T1 to T3 are segment No. events.               T4 and T5 are time events.            4: T1 to T4 are segment No. events.               T5 is a time event.            5: All T1 to T5 are segment No. events.</p> <p>[Note]            On models not supporting time events, "----" is displayed and setting is not possible.            Settings can be changed only in the READY mode.</p>

■ Description of event configuration data

- E d 1 (event 1 standby)
- E d 2 (event 2 standby)
- E d 3 (event 3 standby)

0: Standby OFF

1: Standby ON

- When set to standby ON, event output becomes OFF if the controller is in the standby state even if the condition for turning event output ON is satisfied.
- The controller enters the standby state in the following instances:
  - When in the READY mode
  - When shifting from the READY to the RUN mode
  - When the power is turned ON
- The standby state is canceled in the following instances:
  - When the condition for turning event output OFF (not including the hysteresis period) is satisfied in one of the RUN, HOLD or FAST modes
  - When set to standby OFF
- In the following example, PV event direct, operating point 500°C, hysteresis 10°C and standby ON are set. When the mode changes from READY to the RUN mode at PV 550°C, the controller enters the standby state, so event output is turned OFF.
- Standby functions only when the event type is set to PV type event, and does not function when set to time event type or controller status type.

- d L 1 (event 1 ON delay time)
- d L 2 (event 2 ON delay time)
- d L 3 (event 3 ON delay time)

- The ON delay time is processed after completing all processes up to event output standby ON/OFF. Event output is turned ON when more than the ON delay time has elapsed with the condition for turning event output ON satisfied.
- When the event type is set to ADV, the ON delay function does not operate whatever value is set as the ON delay time.
- ON delay time is processed as follows.

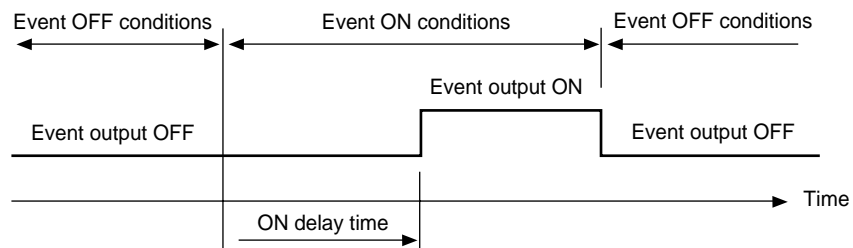

■ PID parameter settings “P; I; D”

No.	Item Code	Item	Factory Setting	User Setting	Setting															
1	<i>P-1</i>	Proportional band (PID set 1)	100.0		<p><i>P</i> : 0.0 to 999.9% (0D, 6D output models) 0.0 enables ON-OFF control. 0.1 to 999.9% (models other than 0D and 6D output models)</p> <p><i>I</i> : 0 to 3600s 0 disables integrating action.</p> <p><i>D</i> : 0 to 1200s 0 disables derivative action.</p> <p><i>oL</i> : -10.0 to MV upper limit % <i>oH</i> : MV lower limit to 110.0%</p> <p><i>rE</i> : 0.0 to 100.0% <i>br</i> : 0 to 30 0 disables the brake function.</p> <p><i>dP</i> : 0.1 to 999.9% <i>dI</i> : 1 to 3600s <i>dd</i> : 0 to 1200 0 disables derivative action.</p> <p>[Note]</p> <ul style="list-style-type: none"> <li>On 0D and 6D output models, when <i>P</i> setting is 0.0, ON-OFF control is enabled. “----” is displayed for items <i>I</i>, <i>D</i>, <i>oL</i>, <i>oH</i>, <i>rE</i>, <i>dP</i>, <i>dI</i> and <i>dd</i>, and setting is not possible.</li> <li>When variable parameter <i>n. -E</i> setting is 2 (estimated position control only) on 2G output models, “----” is displayed for items <i>oL</i> and <i>oH</i>, and setting is not possible.</li> <li>When <i>I</i> setting is not 0, “----” is displayed for <i>rE</i> and setting is not possible.</li> <li>When variable parameter <i>St</i> setting is 0 (smart-tuning disabled), “----” is displayed for <i>br</i> and setting is not possible.</li> <li>When variable parameter <i>2PI d</i> setting is 0 (2 degrees of freedom PID disabled), the items for <i>dP</i>, <i>dI</i>, <i>dd</i> are not displayed.</li> <li>On heat/cool models, the set No. of the PID parameter used for the PID set No. is as follows:</li> </ul> <table border="1" data-bbox="895 1585 1430 1832"> <thead> <tr> <th>PID Set No. Designated in the Program or Zone No. According to Automatic Selection of PID Set</th> <th>PID Set (heat)</th> <th>PID Set (cool)</th> </tr> </thead> <tbody> <tr> <td>1</td> <td>1</td> <td>2</td> </tr> <tr> <td>2</td> <td>3</td> <td>4</td> </tr> <tr> <td>3</td> <td>5</td> <td>6</td> </tr> <tr> <td>4</td> <td>7</td> <td>8</td> </tr> </tbody> </table>	PID Set No. Designated in the Program or Zone No. According to Automatic Selection of PID Set	PID Set (heat)	PID Set (cool)	1	1	2	2	3	4	3	5	6	4	7	8
PID Set No. Designated in the Program or Zone No. According to Automatic Selection of PID Set	PID Set (heat)	PID Set (cool)																		
1	1	2																		
2	3	4																		
3	5	6																		
4	7	8																		
2	<i>I-1</i>	Reset time (PID set 1)	0																	
3	<i>D-1</i>	Rate time (PID set 1)	0																	
4	<i>oL-1</i>	MV lower limit (PID set 1)	0.0																	
5	<i>oH-1</i>	MV upper limit (PID set 1)	100.0																	
6	<i>rE-1</i>	Manual reset (PID set 1)	50.0																	
7	<i>br-1</i>	Brake (PID set 1)	0																	
8	<i>dP-1</i>	Disturbance inhibit proportional band (PID set 1)	100.0																	
9	<i>dI-1</i>	Disturbance inhibit reset time (PID set 1)	120																	
10	<i>dd-1</i>	Disturbance inhibit rate time (PID set 1)	0																	
11	<i>P-2</i>	Proportional band (PID set 2)	100.0																	
12	<i>I-2</i>	Reset time (PID set 2)	0																	
13	<i>D-2</i>	Rate time (PID set 2)	0																	
14	<i>oL-2</i>	MV lower limit (PID set 2)	0.0																	
15	<i>oH-2</i>	MV upper limit (PID set 2)	100.0																	
16	<i>rE-2</i>	Manual reset (PID set 2)	50.0																	
17	<i>br-2</i>	Brake (PID set 2)	0																	
18	<i>dP-2</i>	Disturbance inhibit proportional band (PID set 2)	100.0																	
19	<i>dI-2</i>	Disturbance inhibit reset time (PID set 2)	120																	
20	<i>dd-2</i>	Disturbance inhibit rate time (PID set 2)	0																	

No.	Item Code	Item	Factory Setting	User Setting	Setting
21	<i>P-3</i>	Proportional band (PID set 3)	100.0		<ul style="list-style-type: none"> <li>When variable parameter <i>2 P I d</i> setting is 1 (2 degrees of freedom PID enabled), the parameter (<i>P, I, d</i>) ideal for control when SP changes and the parameter (<i>d P, d I, d d</i>) ideal for inhibiting disturbance during settling are automatically switched.</li> <li>Decreasing the proportional band (<i>P, d P</i>) value improves controllability. However, it also makes overshoot or hunting more likely to occur. Use of the controller on a motor or actuator shortens the controller's life. Do not set the proportional band (<i>P, d P</i>) to too small a value.</li> <li>Decreasing the reset time (<i>I, d I</i>) improves trackability. However, it also makes cycling caused by integrating action more likely to occur. When <i>I</i> setting is 0, integrating operation for inhibiting disturbance also functions.</li> <li>Increasing the rate time (<i>d, d d</i>) allows overshoot to be inhibited more easily. However, it also make hunting more likely to occur as the controller reacts to minute changes in PV.</li> <li>In a temperature control system, setting the rate time to <math>\frac{1}{3}</math> to <math>\frac{1}{4}</math> of the integrating time is generally considered to be appropriate. In a pressure or flow rate control system, derivative action causes hunting. Either set the <i>d</i> setting to 0.0 to disable derivative action, or decrease the setting so that derivative action is almost negligible. The latter solution is more frequently adopted.</li> <li>The MV upper and lower limits (<i>o L, o H</i>) function as integrating limits. When the MV reaches the upper or lower limit, integration no longer functions. This prevents reset wind-up that occurs when the PV has not risen for a long time.</li> <li>Manual reset (<i>r E</i>) is a setting for eliminating offset that occurs during proportional action (integrated action disabled). For manual reset, set the MV ideal for deviation 0.</li> <li>Increasing the brake (<i>b r</i>) value increases the overshoot inhibit effect. However, it also lengthens the rise time.</li> </ul>
22	<i>I-3</i>	Reset time (PID set 3)	0		
23	<i>d-3</i>	Rate time (PID set 3)	0		
24	<i>o L-3</i>	MV lower limit (PID set 3)	0.0		
25	<i>o H-3</i>	MV upper limit (PID set 3)	100.0		
26	<i>r E-3</i>	Manual reset (PID set 3)	50.0		
27	<i>b r-3</i>	Brake (PID set 3)	0		
28	<i>d P-3</i>	Disturbance inhibit proportional band (PID set 3)	100.0		
29	<i>d I-3</i>	Disturbance inhibit reset time (PID set 3)	120		
30	<i>d d-3</i>	Disturbance inhibit rate time (PID set 3)	0		
31	<i>P-4</i>	Proportional band (PID set 4)	100.0		
32	<i>I-4</i>	Reset time (PID set 4)	0		
33	<i>d-4</i>	Rate time (PID set 4)	0		
34	<i>o L-4</i>	MV lower limit (PID set 4)	0.0		
35	<i>o H-4</i>	MV upper limit (PID set 4)	100.0		
36	<i>r E-4</i>	Manual reset (PID set 4)	50.0		
37	<i>b r-4</i>	Brake (PID set 4)	0		
38	<i>d P-4</i>	Disturbance inhibit proportional band (PID set 4)	100.0		
39	<i>d I-4</i>	Disturbance inhibit reset time (PID set 4)	120		
40	<i>d d-4</i>	Disturbance inhibit rate time (PID set 4)	0		

No.	Item Code	Item	Factory Setting	User Setting	Setting
41	<i>P-5</i>	Proportional band (PID set 5)	100.0		
42	<i>I-5</i>	Reset time (PID set 5)	0		
43	<i>D-5</i>	Rate time (PID set 5)	0		
44	<i>oL-5</i>	MV lower limit (PID set 5)	0.0		
45	<i>oH-5</i>	MV upper limit (PID set 5)	100.0		
46	<i>rE-5</i>	Manual reset (PID set 5)	50.0		
47	<i>br-5</i>	Brake (PID set 5)	0		
48	<i>dP-5</i>	Disturbance inhibit proportional band (PID set 5)	100.0		
49	<i>dI-5</i>	Disturbance inhibit reset time (PID set 5)	120		
50	<i>dd-5</i>	Disturbance inhibit rate time (PID set 5)	0		
51	<i>P-6</i>	Proportional band (PID set 6)	100.0		
52	<i>I-6</i>	Reset time (PID set 6)	0		
53	<i>D-6</i>	Rate time (PID set 6)	0		
54	<i>oL-6</i>	MV lower limit (PID set 6)	0.0		
55	<i>oH-6</i>	MV upper limit (PID set 6)	100.0		
56	<i>rE-6</i>	Manual reset (PID set 6)	50.0		
57	<i>br-6</i>	Brake (PID set 6)	0		
58	<i>dP-6</i>	Disturbance inhibit proportional band (PID set 6)	100.0		
59	<i>dI-6</i>	Disturbance inhibit reset time (PID set 6)	120		
60	<i>dd-6</i>	Disturbance inhibit rate time (PID set 6)	0		

## Chapter 7. PARAMETER SETUP

No.	Item Code	Item	Factory Setting	User Setting	Setting
61	<i>P-7</i>	Proportional band (PID set 7)	100.0		
62	<i>I-7</i>	Reset time (PID set 7)	0		
63	<i>D-7</i>	Rate time (PID set 7)	0		
64	<i>oL-7</i>	MV lower limit (PID set 7)	0.0		
65	<i>oH-7</i>	MV upper limit (PID set 7)	100.0		
66	<i>rE-7</i>	Manual reset (PID set 7)	50.0		
67	<i>br-7</i>	Brake (PID set 7)	0		
68	<i>dP-7</i>	Disturbance inhibit proportional band (PID set 7)	100.0		
69	<i>dI-7</i>	Disturbance inhibit reset time (PID set 7)	120		
70	<i>dd-7</i>	Disturbance inhibit rate time (PID set 7)	0		
71	<i>P-8</i>	Proportional band (PID set 8)	100.0		
72	<i>I-8</i>	Reset time (PID set 8)	0		
73	<i>D-8</i>	Rate time (PID set 8)	0		
74	<i>oL-8</i>	MV lower limit (PID set 8)	0.0		
75	<i>oH-8</i>	MV upper limit (PID set 8)	100.0		
76	<i>rE-8</i>	Manual reset (PID set 8)	50.0		
77	<i>br-8</i>	Brake (PID set 8)	0		
78	<i>dP-8</i>	Disturbance inhibit proportional band (PID set 8)	100.0		
79	<i>dI-8</i>	Disturbance inhibit reset time (PID set 8)	120		
80	<i>dd-8</i>	Disturbance inhibit rate time (PID set 8)	0		









## ■ Setup data settings “5 E 1”

No.	Item Code	Item	Factory Setting	User Setting	Setting
1	└01	Control action (CH1)	0		0: Reverse action (heat) 1: Direct action (cool) [Note] On heat/cool models, “- - - -” is displayed and setting is not possible. On other models, external switch input can invert direct/reverse action on the setting of └01.
2	└02	Input 1 temperature unit	0		0: °C 1: °F [Note] When the input 1 range type is linear, “- - - -” is displayed and setting is not possible.
3	└03	Input 1 range type	0		0 to 73 0 to 20: Thermocouple 32 to 40, 48 to 56: Resistance temperature detector 64 to 73: Linear (dc current, dc voltage) [Note] Refer to the input 1 range table. Operation according to a setting not listed in this table is not fixed.
4	└04	Input 1 range decimal point position	Not fixed		0 to 3 [Note] When the input 1 range type is non-linear, “- - - -” is displayed and setting is not possible. When the input 1 range type is changed from non-linear to linear, the original non-linear range values remain.
5	└05	Input 1 range lower limit (0%)	Not fixed		-1999 to 9999U [Note] When the input 1 range type is non-linear, “- - - -” is displayed and setting is not possible.
6	└06	Input 1 range upper limit (100%)	Not fixed		When the input 1 range type is changed from non-linear to linear, the original non-linear range values remain. The relationship between the analog inputs and readout values can be inverted by inverting the upper and lower limit values.
7	└07	Input 1 root extraction dropout	0.0		0.0 to 10.0% (ratio to input range) [Note] 0.0 disables square root extraction. When the input 1 range type is non-linear, “- - - -” is displayed and setting is not possible.
8	└08	Input 1 linearization table approximation	0		0: Disabled 1: Enabled [Note] Table data setting ( $R$ , $b$ ) is used for the linearization table.
9	└09	SP1 lower limit	0%FS		-1999 to upper limit U [Note] Changing the input 1 range has no effect on the range. However, note that a general reset sets the range to the 0%FS value of the input 1 range.
10	└10	SP1 upper limit	100%FS		Lower limit to 9999U [Note] Changing the input 1 range has no effect on the range. However, note that a general reset sets the range to the 0%FS value of the input 1 range.



No.	Item Code	Item	Factory Setting	User Setting	Setting
11	€ 11	PID set auto-switching (CH1)	0		0: OFF (PID set segment designation) 1: ON [Note] When set to 1, the PID set items in the program are invalid. The switching point for auto-switching is set in variable parameters (€ P. 11 to € P. 17).
12	€ 12	MV setting at input 1 over-range (MV1)	0		0: OFF 1: ON
13	€ 13	MV at input 1 over-range (MV1)	0		-10 to 110% [Note] When € 12 setting is 0, "----" is displayed and setting is not possible.
14	€ 14	Manual change mode (MV1)	0		0: Bump-less 1: Preset [Note] When the programmer function is selected, operation is bump-less regardless of the setting of € 14.
15	€ 15	Preset manual value (MV1)	0		-10 to 110% [Note] When € 14 setting is 0, "----" is displayed and setting is not possible.
16	€ 16	MV in READY mode (MV1, MV1 heat-cool output)	0		-10 to 110% [Note] This setting is invalid even if the programmer function is selected by € 18 setting. On heat/cool models, this setting functions as the MV (heat) setting in the READY mode.
17	€ 17	MV (cool) in READY mode (MV1 heat-cool output)	0		-10 to 110% [Note] When the model is not a heat/cool model, "----" is displayed and setting is not possible.
18	€ 18	Main output type (CH1)	0		0: MV1 output (controller function) 1: SP1 output (programmer function) [Note] When the model is not a 5G output model, "----" is displayed and setting is not possible.
19	€ 19	SP1 main output lower limit (4mA setting)	0U		-1999 to 9999U [Note] When the model is not a 5G output model and 8 setting is 0 on a 5G output model, "----" is displayed and setting is not possible.
20	€ 20	SP1 main output upper limit (20mA setting)	1000U		The relationship between the analog outputs and SP1 can be inverted by inverting the upper and lower limit values.
21	€ 21	Unused	-		[Note] "----" is displayed and setting is not possible.
22	€ 22	Unused	-		
23	€ 23	Unused	-		
24	€ 24	Unused	-		
25	€ 25	Unused	-		
26	€ 26	Unused	-		
27	€ 27	Unused	-		
28	€ 28	Unused	-		
29	€ 29	Unused	-		
30	€ 30	Unused	-		

No.	Item Code	Item	Factory Setting	User Setting	Setting
31	C31	Unused	-		[Note] "----" is displayed and setting is not possible.
32	C32	Unused	-		
33	C33	Unused	-		
34	C34	Unused	-		
35	C35	Unused	-		
36	C36	Unused	-		
37	C37	Unused	-		
38	C38	Unused	-		
39	C39	Unused	-		
40	C40	Unused	-		
41	C41	Unused	-		
42	C42	Unused	-		
43	C43	Unused	-		
44	C44	Unused	-		
45	C45	3-position control	0		0: 3-position control disabled 1: 3-position control enabled [Note] On models not supporting 3D output, "----" is displayed and setting is not possible.
46	C46	Auxiliary output 1 type	0		0: PV1 1: SP1 2: Deviation1 3: MV1 4 to 7: NOP 8: MFB 9 to 11: NOP [Note] On models not supporting auxiliary output 1, "----" is displayed and setting is not possible. When set to NOP (or to MFB on models other than 2G output models), output is fixed to 4mA. When set to SP or deviation, output in the READY mode is fixed to 4mA.
47	C47	Auxiliary output 1 lower limit (4mA)	0		-1999 to 9999U -199.9 to 999.9% [Note]
48	C48	Auxiliary output 1 upper limit (20mA)	1000		When the auxiliary output type is MV or MFB, the unit is %. Otherwise, the unit is U.
49	C49	Auxiliary output 2 type	0		0: PV1 1: SP1 2: Deviation1 3: MV1 4 to 7: NOP 8: MFB 9 to 11: NOP [Note] When auxiliary output 2 is not supported, "----" is displayed and setting is not possible. When set to NOP (or to MFB on models other than 2G output models), output is fixed to 4mA. When set to SP or deviation, output in the READY mode is fixed to 4mA.

No.	Item Code	Item	Factory Setting	User Setting	Setting
50	└└50	Auxiliary output 2 lower limit (4mA)	0		-1999 to 9999U -199.9 to 999.9%
51	└└51	Auxiliary output 2 lower limit (20mA)	1000		[Note] When the auxiliary output type is MV or MFB, the unit is %. Otherwise, the unit is U.
52	└└52	External switch input RSW5 assignment	0		0: NOP 1: Fast operation 2: PV start 3: NOP 4: AT start/stop 5: NOP
53	└└53	External switch input RSW6 assignment	0		6: Manual/auto operation 7: Cancel G.Soak by OR conditions 8: Cancel G.Soak by AND conditions 9: Direct/reverse action inversion 10 to 20: NOP
54	└└54	External switch input RSW7 assignment	0		[Note] On external switch 4-input models, "----" is displayed and setting is not displayed. When the same assignment is set to two or more RSWs, the RSW setting with the lowest No. is valid. When this setting is set to NOP, the controller state is not switched by external switch input ON/OFF. The controller state can be switched ON/OFF by communications.
55	└└55	 assignment item 1	1000		1000 to 5000
56	└└56	 assignment item 2	1000		[Note] To set the No., add the No. of the item to be assigned to  to the following values for the setting group containing that item. • 1000: Constant-value operation data • 1500: PID parameter • 2500: Variable parameter • 3500: Event configuration data • 4000: Table data • 4500: Setup data Assignments to which a nonexistent No. have been set are invalid.
57	└└57	 assignment item 3	1000		
58	└└58	 assignment item 4	1000		
59	└└59	 assignment item 5	1000		
60	└└60	 assignment item 6	1000		
61	└└61	 assignment item 7	1000		
62	└└62	 assignment item 8	1000		
63	└└63	Operation completion state	0		
64	└└64	Program time unit	0		0: h/min 1: min/s
65	└└65	Time display	0		0: Remaining segment time 1: Total operation time [Note] The total operation time returns to 0 in the READY mode.
66	└└66	PV display	0		0: ON 1: OFF 2: ON 3: OFF [Note] Settings 0 and 2, and 1 and 3 mean the same, respectively.

No.	Item Code	Item	Factory Setting	User Setting	Setting
67	└67	Alarm display			0: Display ON 1: Display OFF [Note] Even when set to 1, alarm-related events do not operate.
68	└68	Programming item: Events 1 to 3	0		0: Display ON 1: Display OFF [Note] Even if each of the items are set to 1, the function operates even if data is set to the program. On models not supporting time events, time event items are not displayed in program settings regardless of the number of └69 settings.
69	└69	Programming item: Time events 1 to 5	0		
70	└70	Programming item: PID set, G.Soak	0		
71	└71	Programming item: PV start, cycle, pattern link	0		
72	└72	Cold junction compensation	0		0: Compensated internally 1: Compensated externally [Note] When the input 1 range type is other than a thermocouple, "----" is displayed and setting is not possible.
73	└73	Input operation at input 1 disconnection	0		0: Upscale 1: Downscale [Note] This setting is valid when the input 1 range type is thermocouple, resistance temperature detector or linear (mV series).
74	└74	Voltage time-proportional output system	0		0: Input ON again enabled within time-proportional cycle 1: Input ON again disabled within time-proportional cycle [Note] When both of outputs 1 and 2 are not voltage time-proportional outputs, "----" is displayed and setting is not possible.
75	└75	Output 1 selection	Not fixed		0: Current output 1: Voltage output [Note] When each of the outputs are relay output, position-proportional output, auxiliary output or output is not mounted, "----" is displayed and setting is not possible. Factory setting is 1 if outputs are voltage output according to output type. Otherwise, the setting is 0.
76	└76	Output 2 selection	Not fixed		
77	└77	Unused	—		[Note] "----" is displayed and setting is not possible.
78	└78	Voltage output 1 adjustment	15		2 to 22mA [Note] When each of the outputs are other than voltage output, "----" is displayed and setting is not possible. Normally, use the factory setting.
79	└79	Voltage output 2 adjustment	15		
80	└80	Unused	—		[Note] "----" is displayed and setting is not possible.
81	└81	Input 1 burnout current (expansion setting 1)	0		0: Burnout current ON 1: Burnout current OFF [Note] Normally set to 0. Set to 1 when infra-red thermocouple RT50 is connected to input 1.

No.	Item Code	Item	Factory Setting	User Setting	Setting
82	C82	Expansion setting 2	0		0: Expansion disabled 1: Expansion enabled [Note] This setting is for service use only.
83	C83	Unused	—		[Note] "----" is displayed and setting is not possible.
84	C84	Station address	0		0 to 127 [Note] On models not supporting communications, "----" is displayed and setting is not possible. 0 disables communication.
85	C85	Transmission rate/ character format	0		0: 9600bps/even parity, 1 stop bit 1: 9600bps/no parity, 2 stop bits 2: 4800bps/even parity, 1 stop bit 3: 4800bps/no parity, 2 stop bits [Note] On models not supporting communications, "----" is displayed and setting is not possible.
86	C86	Unused	—		[Note]
87	C87	Unused	—		"----" is displayed and setting is not possible.
88	C88	Unused	—		
89	C89	Unused	—		
90	C90	Special functions	0		
91	C91	Input 1 zener barrier adjustment	—		[Note] "----" is displayed and setting is not possible.
92	C92	Unused	—		[Note] "----" is displayed and setting is not possible.
93	C93	CPL communica- tions port selection	0		0: Add-on terminal 1 to 15: Loader jack (communications address)
94	C94	PID type	0		0: Improved 1: Compatible with DCP200
95	C95	Unused	—		[Note] "----" is displayed and setting is not possible.
96	C96	Hardware type 1	—		[Note] This setting is for service use only, and can only be verified.
97	C97	Hardware type 2	—		
98	C98	ROM ID	—		
99	C99	ROM item	—		
100	C00	ROM revision	—		

## ■ Description of setup data settings

### ● $\zeta 07$ (input 1 square root extraction dropout)

- Generally, the differential pressure detected by an orifice on a differential pressure type flowmeter, is proportional to the square of the flowrate. For this reason, square root extraction is carried out when uniform signals are required.

When input for square root extraction is the dropout value set by  $\zeta 07$  or less, output from square root extraction processing can be set to 0%.

- When  $\zeta 07$  is set to 1, square root extraction is not carried out.

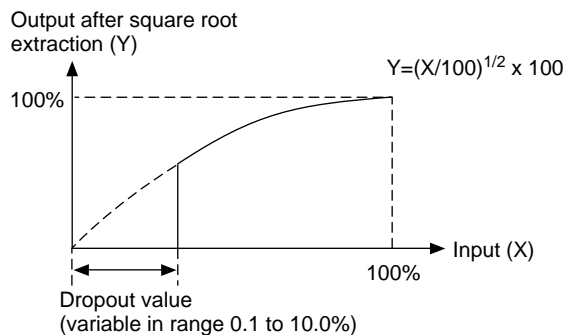

- Square root extraction is carried within the range 0.0 to 100.0%. In the ranges -10.0 to 0.0% and 100.0 to 110.0%, regular scaling is carried out.

### ● $\zeta 09$ (SP1 lower limit)

### ● $\zeta 10$ (SP1 upper limit)

- This is a program setup pattern item, and functions as a limiter when setting or changing SP.
- In the program operation mode, this functions as a limiter on the value obtained by adding the SP set to the program to the SP bias (variable parameter). The result of this operation is taken as SP.
- This functions as a limiter when setting or changing the SP in constant-value data setup.
- In the constant-value operation mode, this functions as a limiter on the value obtained by adding the SP set to the constant-value operation data to the SP bias (variable parameter). The result of this operation is taken as SP.

### ● $\zeta 47$ (auxiliary output 1 lower limit)

### ● $\zeta 48$ (auxiliary output 1 upper limit)

### ● $\zeta 50$ (auxiliary output 2 lower limit)

### ● $\zeta 51$ (auxiliary output 2 upper limit)

- This is the scaling setting for auxiliary output. The values of the upper limit setting and lower limit setting can also be inverted.
- In the following example, the type is set to MV at auxiliary input 1. 12mA is output when MV is 100% and 20mA is output when MV is 0%. In the following figure, MV is 200% when virtually calculated at 4mA.

Accordingly, the setting of  $\zeta 47$  and  $\zeta 48$  become 200.0 and 0.0, respectively.

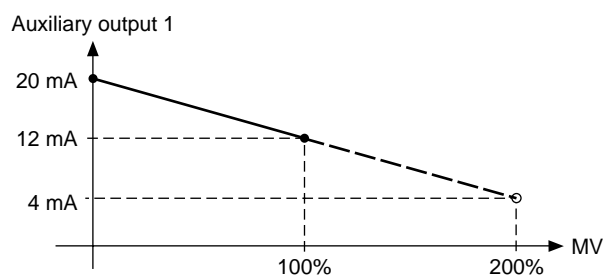

● **└ 55 (time display)**

- 0: Remaining segment time
- 1: Total operation time

- This selects the time display in the basic display state in the program operation mode.
- When set to 0, in the READY mode, the time setting value of the currently selected segment is displayed.
- When set to 0, in the RUN, HOLD, FAST or END modes, the remaining time for the currently executing segment is displayed after being rounded down.

For example, if the remaining time is 1h, 30min, 59s when the time unit is set to “h:min”, the time display is “1.30”.

- When set to 1, in the READY mode, the time display is “0.00”.
- When set to 1, in the RUN, HOLD, FAST or END modes, the time it takes to shift from the READY to the RUN mode is displayed after being round down. Also, after “99.59” the time display changes to “0.00”.

For example, if the remaining time is 101h, 30min, 59s when the total operation time is set to “h:min”, the time display is “1.30”.

- In the FAST mode, the time display changes according to the FAST scale if this parameter is set to either 0 or 1.

● **└ 56 (PV display)**

This selects PV display in the basic display state. You can select between numerical display or no display at all. The setting of this parameter does not influence PV-related input processing, PID operation, event output, auxiliary output and alarm display.

Also, to eliminate PV alarm display or PV alarm event output, select the thermocouple range by the input range to short-circuit the input terminals.

● **└ 72 (cold junction compensation)**

- 0: Compensated internally
- 1: Compensated externally

- This selects how thermocouple cold junctions are to be compensated.
- When set to 1, carry out 0°C compensation by an ice box, for example.

● **└ 74 (voltage time-proportional output system)**

- 0: Input ON again enabled within time-proportional cycle
- 1: Input ON again disabled within time-proportional cycle

- This selects whether or not to turn output ON again even if output is OFF when the results of PID operation have changed during the time-proportional cycle (cycle time).
- The figure below shows each of these differences.

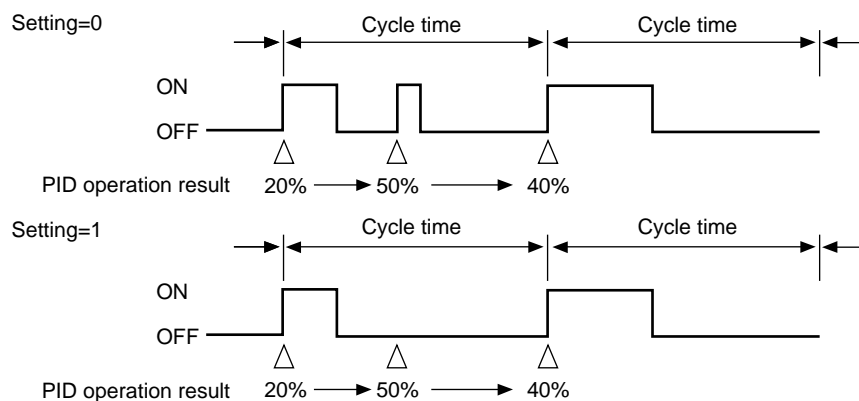

- 78 (voltage output 1 adjustment)

- 79 (voltage output 2 adjustment)

When driving an SSR by voltage time-proportional output, the output voltage of the controller must be within the input rated voltage (optimum ignition voltage) of the SSR.

On the DCP301, a newly developed variable output system is utilized that enables output of the optimum ignition voltage even when driving two or more SSRs.

This system sets the optimum current value on the controller so that the optimum ignition voltage with respect to the internal impedance of the SSR side can be obtained.

The following shows equivalent circuits and related formulas.

- Description of Symbols

(1) Details

$I_o$	: Setting output current of controller (setting range: 2 to 22mA)
$V_o$	: Maximum applied load voltage (approx. 14.7V)
$V_{SSR}'$	: Actual input voltage to SSR
$V_{SSR}$	: Input rated voltage range of SSR ( $V_{SSR/MIN}$ to $V_{SSR/MAX}$ )
$V_{SSR/MIN}$	: Minimum input rated voltage of SSR
$V_{SSR/MAX}$	: Maximum input rated voltage of SSR
$Z$	: Internal impedance of SSR
$V_D$	: Internal voltage drop of SSR (normally 1 to 2V)

(2) Equivalent circuit when one SSR is connected

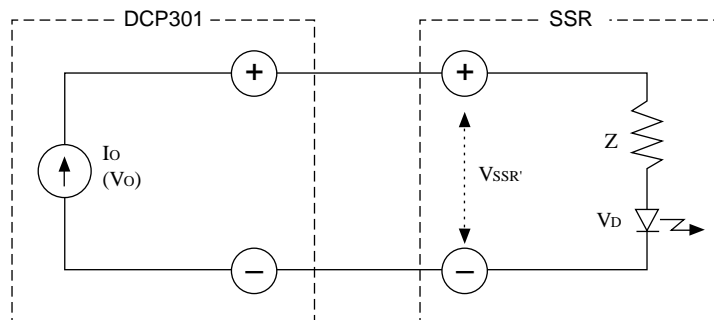

Formulas (1) and (2) formulas must be satisfied.

(1) formula  $V_{SSR/MIN} \leq I_o \times Z + V_D \leq V_o$

(2) formula  $V_{SSR}' < V_{SSR/MAX}$   
 $(V_{SSR}' = I_o \times Z + V_D)$



(3) Equivalent circuit when N number of SSRs are connected in series

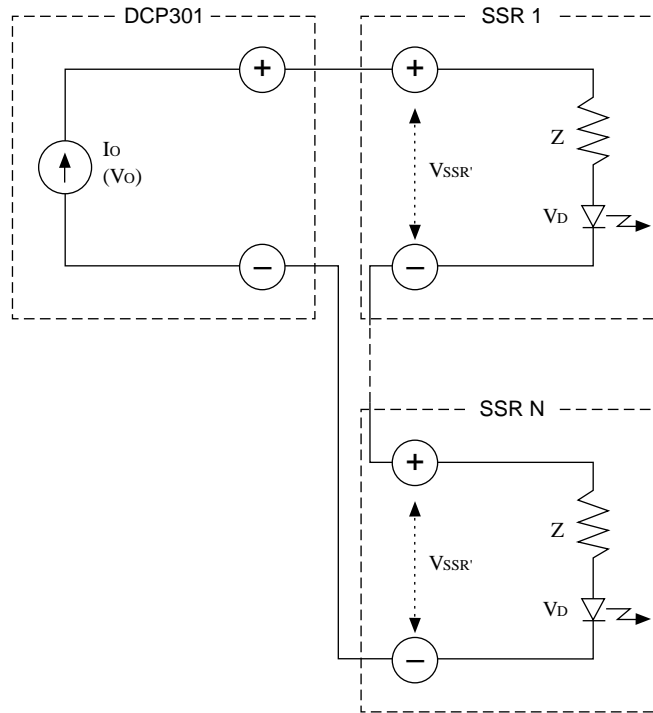

Formulas (3) and (4) formulas must be satisfied.

(3) formula  $V_{SSR/MIN} \leq I_o \times Z + V_D \leq V_o/N$

(4) formula  $V_{SSR'} \leq V_{SSR/MAX}$   
 $(V_{SSR'} = I_o \times Z + V_D)$

(4) Equivalent circuit when N number of SSRs are connected in parallel

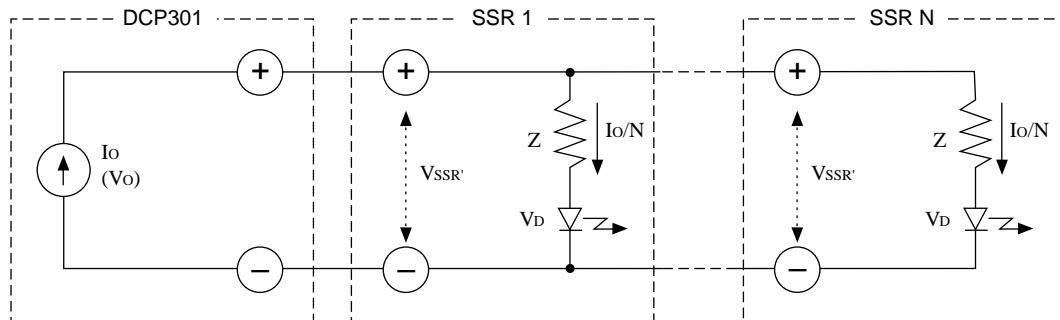

Formulas (5) and (6) formulas must be satisfied.

(5) formula  $V_{SSR/MIN} \leq I_o/N \times Z + V_D \leq V_o$

(6) formula  $V_{SSR'} \leq V_{SSR/MAX}$   
 $(V_{SSR'} = I_o/N \times Z + V_D)$

## (5) Example: Using Yamatake Corporation's PGM

$V_{SSR}$  : 3 to 6V  
 $Z$  :  $260\Omega \pm 5\%$   
 $V_D$  : 0.8 to 1.3V

- What value should  $I_o$  be set to when connecting one PGM?

As shown in the figure on the right, a fixed-current system is used for the voltage output of this controller. The fixed current can be calculated as follows from the input voltage range of PGM.

$$8.9\text{mA} \leq I \leq 17.2\text{mA}$$

$$I_{\text{MIN}} \times Z_{\text{MIN}} + V_{D/\text{MIN}} > 3$$

$$I_{\text{MIN}} > 8.9\text{mA}$$

$$I_{\text{MAX}} \times Z_{\text{MAX}} + V_{D/\text{MAX}} < 6$$

$$I_{\text{MAX}} < 17.2\text{mA}$$

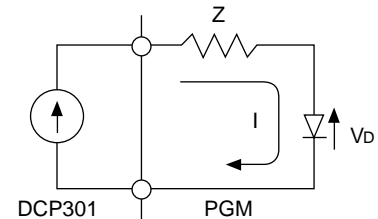

- How many PGMs can be connected?

A current of 8.9mA or more must flow to a single PGM. On the other hand, the maximum current of the controller is 22.0mA. Accordingly, two PGMs can be connected in parallel.

In the case of a series connection, due to the maximum output current (22.0mA) and allowable load resistance ( $600\Omega$ ), the maximum voltage that can be applied to a load becomes 13.2V ( $22.0\text{mA} \times 600\Omega$ ).

When a current of 8.9mA flows to a PGM, the maximum voltage at both of its input terminals becomes 3.7V.

$$0.0089 \times 260 \times 1.05 + 1.3 = 3.7\text{V}$$

Accordingly,  $13.2 \div 3.7 = 3.56$ , which means that three PGMs can be connected in series.

The above calculation assumes operation in the worst conditions. For example, even if four PGMs are connected in series, they should operate normally if a voltage of 3V or more is applied to each of the PGMs in a voltage ON state.

●  $\zeta \text{ 9 } \textcircled{3}$  (Special functions)

- Normally set to 0.
- In the case of setup 102, current output (including heat-cool output) 0 to 100% for the control output becomes 0 to 20mA. Note, however, that at 0% or less, the current is 0mA.  
At output 1mA or less, accuracy is  $\pm 0.5\%$ .
- In the case of setup 103, current output (including heat-cool output) and auxiliary output 0 to 100% for the control output becomes 0 to 20mA. Note, however, that at 0% or less, the current is 0mA.  
At output 1mA or less, accuracy is  $\pm 0.5\%$ .
- When the input 1 range type ( $\zeta \text{ 0 } \textcircled{3}$ ) is an RTD in setup 241, Zener barrier adjustment ( $\zeta \text{ 9 } \textcircled{1}$ ) is displayed.

● **Input 1 Zener barrier adjustment**

The following adjustment must be made when using a Zener barrier.

- (1) Turn the DCP301 OFF. When you have finished mounting and wiring the DCP301, short-circuit across A and B on the terminals of the RTD.

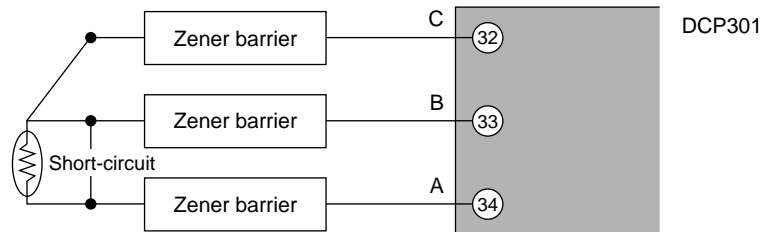

- (2) Turn the DCP301 ON again, and set setup data **Input 1 Zener barrier adjustment** setting to 241. For details on how to change settings, see 7-1 Parameter Setup (page 7-1).
- (3) Display the setup data **Input 1 Zener barrier adjustment** setting.
- (4) Press **ENT** to display the difference (A—B) between the resistances of the Zener barrier connected to leads A and B on the lower display.
- (5) Press **ENT** to memorize the difference (A—B) between the resistances to the controller.
- (6) Press **DISP** to set the DCP301 to the basic display state.
- (7) Turn the power OFF, and remove the short across A and B.

**Handling Precautions**

- The resistance error of the Zener barrier connected to leads A and B cannot be adjusted unless it is 20Ω or less.
- This adjustment is not required when a Zener barrier and an input other than an RTD are not used.
- Once the Zener barrier has been adjusted, compensation is carried out on the Zener barrier. When using on an RTD without a Zener barrier, re-adjust without the Zener barrier.

---

- **㉑㉓ (CPL communications port selection)**

- When set to 0, CPL communications from the loader jack is not possible. In this case, CPL communications is possible from the add-on terminal under setup ㉑㉒ and ㉑㉓ communications conditions if the controller model supports CPL communications.
- When set to 1 to 15, CPL communications from the loader jack is not possible, and the ㉑㉓ setting becomes the CPL communications address.

Communications conditions are also 4800bps, even parity and 1 stop bit.

In this case, CPL communications is not possible from the add-on terminal even if the controller model supports CPL communications.

- Use the special cable to connect the RS-232C port on the personal computer and the loader jack on the equipment.
- When the setup ㉑㉑ (ROM revision) setting indication is 0 or 1, the setup ㉑㉓ setting indication cannot be set at “---”.

Also, communications from the loader jack is not possible.

■ Table data settings “ $t-b$ ”

No.	Item Code	Item	Factory Setting	User Setting	Setting
1	$t-A.1$	Input linearization table approximation A1	0U		-1999 to 9999U [Note] When setup data $\zeta 08$ setting is 0, “- - - -” is displayed and setting is not possible. Item An displays input (X-axis) and Bn displays output (Y-axis). In principle, set so that A1 is $\leq$ A2, A2 $\leq$ A3 and so forth up to A10 $\leq$ A11. Linear interpolation is carried out between points on the linearization table. The ends of the linearization table are fixed to (A0, B0) = (-2000, -2000) and (A12, B12) = (10000, 10000). When $A_n \leq X \leq A_{n+1}$ , Y becomes $(X-A_n) \times (B_{n+1}-B_n)/(A_{n+1}-A_n)+B_n$ .
2	$t-A.2$	Input linearization table approximation A2	1000U		
3	$t-A.3$	Input linearization table approximation A3	1000U		
4	$t-A.4$	Input linearization table approximation A4	1000U		
5	$t-A.5$	Input linearization table approximation A5	1000U		
6	$t-A.6$	Input linearization table approximation A6	1000U		
7	$t-A.7$	Input linearization table approximation A7	1000U		
8	$t-A.8$	Input linearization table approximation A8	1000U		
9	$t-A.9$	Input linearization table approximation A9	1000U		
10	$t-A.A$	Input linearization table approximation A10	1000U		
11	$t-A.b$	Input linearization table approximation A11	1000U		
12	$t-b.1$	Input linearization table approximation B1	0U		
13	$t-b.2$	Input linearization table approximation B2	1000U		
14	$t-b.3$	Input linearization table approximation B3	1000U		
15	$t-b.4$	Input linearization table approximation B4	1000U		
16	$t-b.5$	Input linearization table approximation B5	1000U		
17	$t-b.6$	Input linearization table approximation B6	1000U		
18	$t-b.7$	Input linearization table approximation B7	1000U		
19	$t-b.8$	Input linearization table approximation B8	1000U		
20	$t-b.9$	Input linearization table approximation B9	1000U		
21	$t-b.A$	Input linearization table approximation B10	1000U		
22	$t-b.b$	Input linearization table approximation B11	1000U		

■ Description of table data settings

- $t - a, 1$  to  $t - a, b$
- $t - b, 1$  to  $t - b, b$

- These settings are for the A-axis (input) and B-axis (output) settings of input 1 linearization table approximation.
- Both ends of the linearization table are fixed at -2000U, -2000U and 10000U,10000U. The linearization table is formed by connecting 11 points of table data settings between the two ends.
- Table data is set not by percentages but directly by engineering unit. When the range type is set to linear, set scaled values.

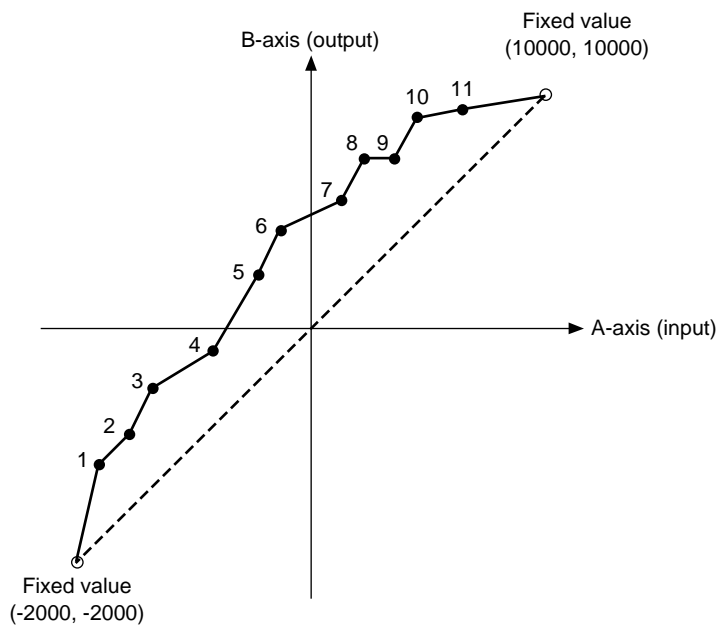

- Points on the broken-line,  $A_n$  and  $B_n$ , must be set so that they increase in the following way  $(A_1, B_1) = (0, 0)$ ,  $(A_2, B_2) = (100, 100)$  and so forth. If set points break this relationship, the point in conflict must be excluded to create the linearization table.

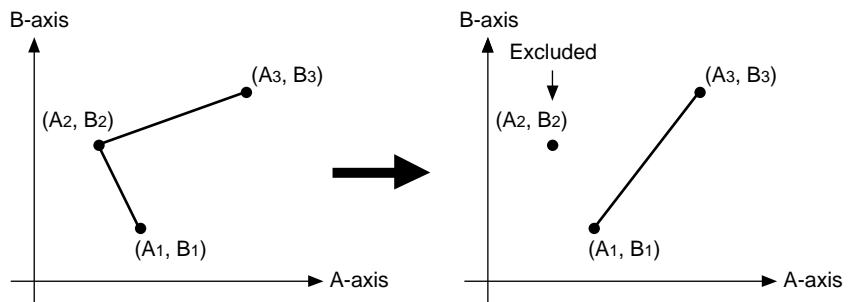

- When two equal points such as  $A_1$  and  $A_2$  are set for the A-axis,  $B_1$  shall be taken as the output value.

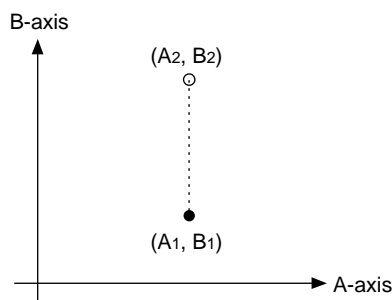

■ Constant-value operation data settings “*5 t*”

No.	Item Code	Item	Factory Setting	User Setting	Setting
1	<i>n o d E</i>	Operation mode	0		0: Program operation 1: Constant-value operation [Note] This setting can be changed only in the READY mode.
2	<i>S P</i>	SP1	0		This setting can be set in the SP1 lower to upper limit range in setup data settings <i>0 9</i> and <i>1 0</i> .
3	<i>S P 2</i>	Unused	0		[Note] “----” is displayed and setting is not possible.
4	<i>E v 1</i>	Event 1 setting value	9999		-1999 to 9999U (event type is deviation or SP) 0 to 9999U (event type is absolute value deviation)
5	<i>E v 2</i>	Event 2 setting value	9999		-10.0 to 110.0% (event type is MV or MFB) [Note]
6	<i>E v 3</i>	Event 3 setting value	9999		When the event configuration data type setting is ≥ 50 for each event, “----” is displayed and setting is not possible.
7	—	Unused	—		[Note]
8	—	Unused	—		“----” is displayed and setting is not possible.
9	—	Unused	—		
10	—	Unused	—		
11	<i>P .</i>	Proportional band (CH1)	100.0		<p><i>P</i> : 0.0 to 999.9% (0D, 6D output models) 0.0 enables ON-OFF control. 0.1 to 999.9% (models other than 0D and 6D models)</p> <p><i>i</i> : 0 to 3600s 0 disables integral action.</p> <p><i>d</i> : 0 to 1200s 0 disables derivative action.</p> <p><i>o L</i> : -10.0 to MV upper limit % <i>o H</i> : MV lower limit to 110.0% <i>r E</i> : 0.0 to 100.0% <i>b r</i> : 0 to 30 0 disables the brake function.</p> <p><i>d P</i> : 0.1 to 999.9% <i>d i</i> : 1 to 3600s <i>d d</i> : 0 to 1200 0 disables derivative action.</p> <p>[Note] • On 0D and 6D output models, when <i>P</i> setting is 0.0, ON-OFF control is enabled. “----” is displayed for items <i>i</i>, <i>d</i>, <i>o L</i>, <i>o H</i>, <i>r E</i>, <i>d P</i>, <i>d i</i> and <i>d d</i>, and setting is not possible. • When variable parameter <i>n . - E</i> setting is 2 (estimated position control only) on 2G output models, “----” is displayed for items <i>o L</i> and <i>o H</i>, and setting is not possible. • When <i>i</i> setting is not 0, “----” is displayed for <i>r E</i> and setting is not possible. • When variable parameter <i>5 t</i> setting is 0 (smart-tuning disabled), “----” is displayed for <i>b r</i> and setting is not possible. • When variable parameter <i>2 P i d</i> setting is 0 (2 degrees of freedom PID disabled), the items for <i>d P</i>, <i>d i</i>, <i>d d</i> are not displayed. For details, see the Note for PID parameters.</p>
12	<i>i .</i>	Reset time (CH1)	0		
13	<i>d .</i>	Rate time (CH1)	0		
14	<i>o L .</i>	MV lower limit (CH1)	0.0		
15	<i>o H .</i>	MV upper limit (CH1)	100.0		
16	<i>r E .</i>	Manual reset (CH1)	50.0		
17	<i>b r .</i>	Brake (CH1)	0		
18	<i>d P .</i>	Disturbance inhibit proportional band (CH1)	100.0		
19	<i>d i .</i>	Disturbance inhibit reset time (CH1)	120		
20	<i>d d .</i>	Disturbance inhibit rate time (CH1)	0		
21	<i>P . - E</i>	Proportional band (for cool control)	100.0		
22	<i>i . - E</i>	Reset time (CH1) (for cool control)	0		
23	<i>d . - E</i>	Rate time (CH1) (for cool control)	0		
24	<i>o L . - E</i>	MV lower limit (CH1) (for cool control)	0.0		
25	<i>o H . - E</i>	MV upper limit (CH1) (for cool control)	100.0		
26	<i>r E . - E</i>	Manual reset (CH1) (for cool control)	50.0		
27	—	Unused	—		[Note]
28	—	Unused	—		“----” is displayed and setting is not possible.
29	—	Unused	—		
30	—	Unused	—		

# Chapter 8. PROGRAM SETUP

## 8-1 Program Setup

Programs can be set up when the DCP301 is in the basic display state. This is sometimes referred to as “programming” in this manual.

If the DCP301 is not in the basic display state, press  $\overline{\text{DISP}}$  to set the controller to the basic display state.

Programming can be carried out more easily if the details of the setup are entered to a program chart before starting programming.

### ■ How to enter program setup

#### ● Key operation

Press  $\overline{\text{FUNC}} + \overline{\text{PROG}}$  in the basic display state to enter program setup.

In the program setup state, the PRG LED on the console lights, and the decimal points in the program No. display and segment No. display light. However, note that the DCP301 does not enter the program setup state in the following cases:

- When in the constant-value operation mode (when constant-value operation data  $\overline{\text{N}} \cdot \overline{\text{O}} \cdot \overline{\text{D}} \cdot \overline{\text{E}}$  setting is 1)
- When key lock is active (variable parameter  $\overline{\text{L}} \cdot \overline{\text{O}} \cdot \overline{\text{K}}$  is set to 2 or 4)

Also, the setup cannot be changed even if the DCP301 is in the program setup in the following case:

- When the program is protected (variable parameter  $\overline{\text{P}} \cdot \overline{\text{R}} \cdot \overline{\text{L}} \cdot \overline{\text{K}}$  is set to 1)

#### ● Display start items

When the DCP301 enters the program setup state, display starts from the program No. and the segment No. pattern item.

### ■ Selecting the program No. to set up

There are two ways of selecting the program No. to set up.

- Selecting the program No. before entering program setup
- Selecting the program No. after entering program setup

#### ● Selecting the program No. before entering program setup

To select the program No. press  $\overline{\text{PROG}}$  or  $\overline{\text{▼}}$  if the DCP301 is in the basic display state in the READY mode.

#### ⓘ Handling Precautions

The program No. cannot be selected on the DCP301 when selecting the program No. by external switch inputs.

For details, see 6-3 Program Selection (page 6-7).

#### ● Selecting the program No. after entering program setup

Each press of  $\overline{\text{FUNC}} + \overline{\text{PROG}}$  in the program setup state increments the program No. When 19 is reached, the program No. returns to 1. Likewise, each press of  $\overline{\text{FUNC}} + \overline{\text{▼}}$  decrements the program No. When 1 is returned to, the program No. advances to 19.

However, note that when setup values are being entered (setting value is blinking) during program setup, press  $\overline{\text{ENT}}$  first to quit entry of values and then press  $\overline{\text{FUNC}} + \overline{\text{PROG}}$  or  $\overline{\text{FUNC}} + \overline{\text{▼}}$  to change the program No.



● **Selecting the program No. after entering program setup (continued)**

When you select the program No. by this method, the display changes to segment No.1 and the pattern item on the programming map.

This method can be used, for example, to select a program No. to set up a program other than the No. being operated in the RUN mode. It can also be used to select a program No. to set up a program other than the currently selected No. by external switch input.

■ **Mode transition**

The following diagram shows the transition between modes during program setup.

The following page describes the various mode transition states (1) to (16) in the diagram.

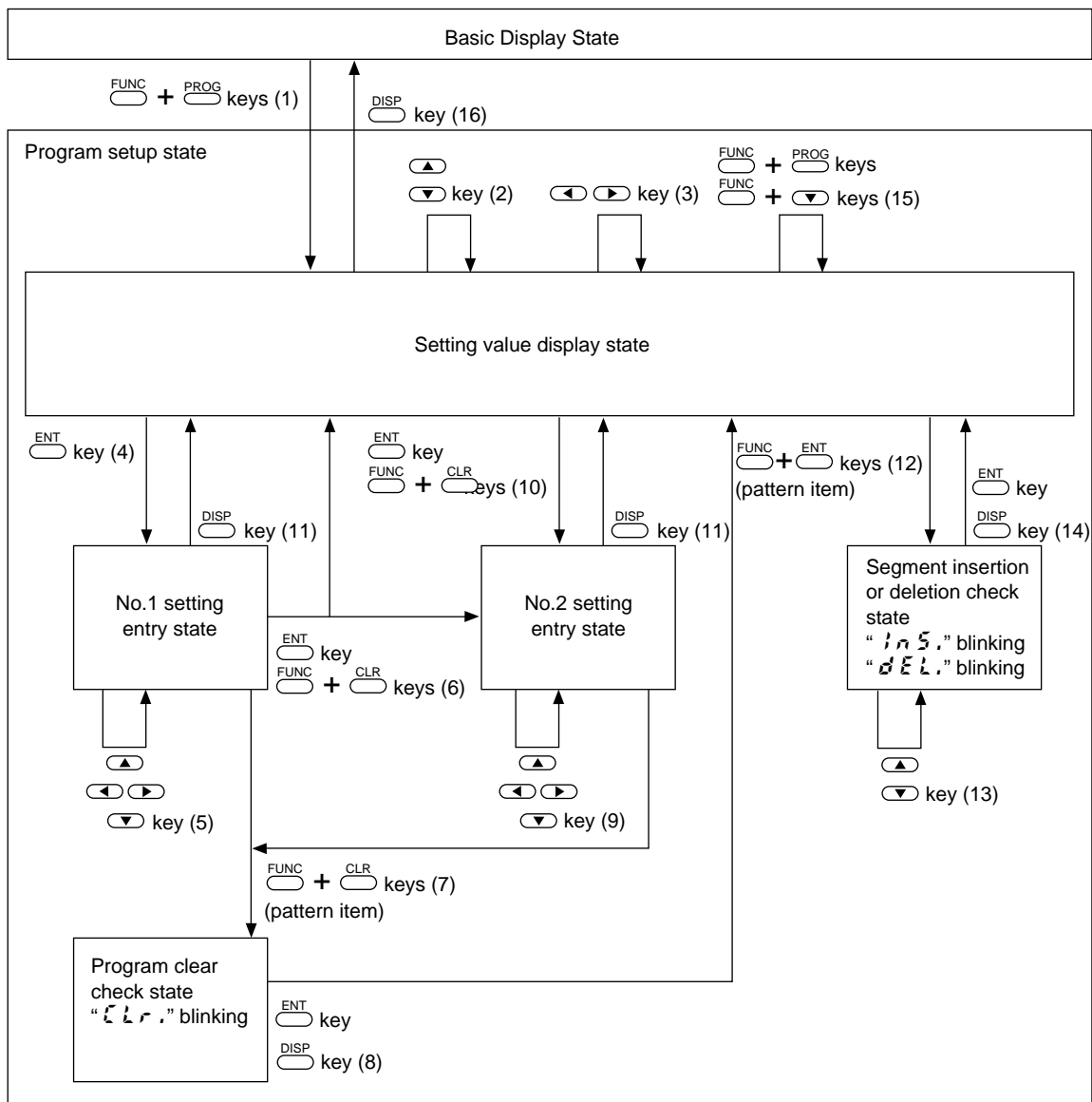

● Description of mode transition states (see page 8-2.)

- (1) Program setup is entered.
- (2) Setup item on programming map is moved.
- (3) Segment on programming map is moved.
- (4) Entry of the No.1 setup is started.
- (5) No.1 setting value incremented/decremented, and blinking digit is moved.
- (6) Entry of No.1 setup is completed.

$\overline{\text{ENT}}$  stores the value being entered to memory.

With items having a No.2 setup, entry of the No.2 setup value is started. When the item does not have a No.2 setup, the setup display is returned to.

When  $\overline{\text{FUNC}}$  +  $\overline{\text{CLR}}$  are pressed at an event/time event item, the setting for that segment is cleared.

When  $\overline{\text{FUNC}}$  +  $\overline{\text{CLR}}$  are pressed at a G.Soak item, the setting for that segment is cleared.

- (7) Pressing  $\overline{\text{FUNC}}$  +  $\overline{\text{CLR}}$  for a pattern item causes “ $\overline{\text{CLR}}$ ” to blink to confirm clearing of the program from that segment onwards.

However, note that  $\overline{\text{FUNC}}$  +  $\overline{\text{ENT}}$  is disabled for currently running programs.

- (8)  $\overline{\text{ENT}}$  clears the program from that segment onwards.

$\overline{\text{DISP}}$  does not clear the program and the setting display is returned to.

- (9) No.2 setup setting value incremented/decremented, and blinking digit moved
- (10) Entry of No.2 setup is completed.

$\overline{\text{ENT}}$  stores the value being entered to memory.

When  $\overline{\text{FUNC}}$  +  $\overline{\text{CLR}}$  are pressed at an event/time event item, the setting for that segment is cleared.

- (11) Entry of values currently being entered completed without being stored to memory
- (12) When  $\overline{\text{FUNC}}$  +  $\overline{\text{ENT}}$  are pressed at a pattern item, the display changes to the segment insert/delete screen, and “ $\overline{\text{INS}}$ ” is blinks.

However, note that  $\overline{\text{FUNC}}$  +  $\overline{\text{ENT}}$  is disabled for currently running programs.

- (13) “ $\overline{\text{DEL}}$ ” displayed blinking by  $\blacktriangledown$ , and “ $\overline{\text{INS}}$ ” displayed blinking by  $\blacktriangle$ .

- (14) If  $\overline{\text{ENT}}$  is pressed at the “ $\overline{\text{INS}}$ ” display, a segment is inserted. If  $\overline{\text{ENT}}$  is pressed, a segment is “ $\overline{\text{DEL}}$ ”.

- (15) If  $\overline{\text{DISP}}$  is pressed, neither of segment delete or insert are carried out.

Press  $\overline{\text{FUNC}}$  +  $\overline{\text{PROG}}$  to increment program Nos, and  $\overline{\text{FUNC}}$  +  $\blacktriangledown$  to decrement program Nos.

- (16) Basic display state is returned to.

### ■ Programming map

As shown in the figure below, the programming map is arranged in a matrix with the segment Nos. aligned along the horizontal axis and program setup items arranged along the vertical axis.

The area surrounded by thick black lines indicates the items that can be designated by segment No. and program setup item in the program setup state.

◀, ▶: Moves to the left or right (i.e. moves segments)

▲, ▼: Moves up or down (i.e. moves program items).

The programming map below shows an example where segments No.1 to No.10 have been set up.

Shaded items  cannot be moved.

		Segment No.						Remarks
Program Items	(1) No.1 setting (2) No.2 setting	1	2	....	10	11	12 to 30	
Pattern	(1) SP1	100	1000		100	----		*1
	(2) Time	0.30	3.00		10.00	----		
Event 1	(1) Operating point (ON time)	1100	----		----			*2
	(2) (OFF time)							
Event 2	(1) Operating point (ON time)	----	30		----			
	(2) (OFF time)							
Event 3	(1) Operating point (ON time)	0.00	0.00		0.00			
	(2) (OFF time)	0.01	0.01		0.01			
Time event 1	(1) ON time	----	0.00		----			*3
	(2) OFF time	----	1.00		----			
Time event 2	(1) ON time	----	1.00		----			
	(2) OFF time	----	2.00		----			
Time event 3	(1) ON time	----	2.00		----			
	(2) OFF time	----	3.00		----			
Time event 4	(1) ON time	----	----		----			
	(2) OFF time	----	----		----			
Time event 5	(1) ON time	----	----		0.00			
	(2) OFF time	----	----		----			
PID set No. (CH1)		1	2		8			*4
G.Soak (CH1)		----	----		----			
G.Soak time-out		----	----		----			
PV start		1	1		1			*5
Cycle		0	0		0			
Pattern link		0	0		0			

\*1 The No.10 segment is the final segment. A non-set segment is shown in the No.11 segment.

\*2 As PV type event is selected as the PV type for events 1 and 2, only the No.1 setting can be set up. As time event is selected as the event type for event 3, the No.1 and No.2 settings can be set up.

\*3 As all time events are selected as the event type in the time event, the No.1 and No.2 settings can be set up.

\*4 This can be set as controller functions are selected and PID or ON-OFF control is carried out.

\*5 As these are setting items for each program, the display and setting are common for all segments.

## ■ Display details

The following figure shows the conventions used for displays in this manual.

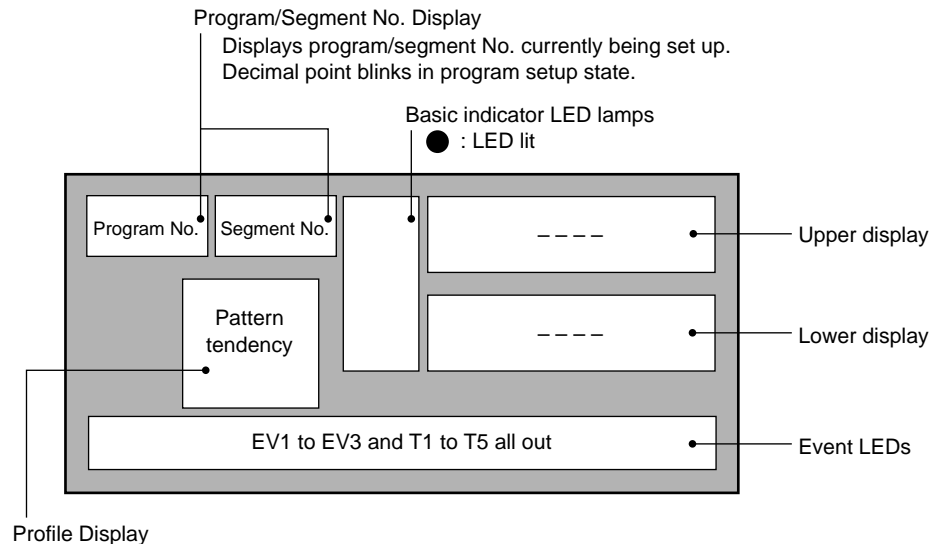

## ■ Setting up pattern items

- (1) In the setting display state, move to the pattern item of the segment to be set up on the programming map.
- (2) If you press  $\text{ENT}$ , the upper display starts blinking to indicate start of entry to the No.1 setup.
- (3) Press  $\uparrow$ ,  $\downarrow$ ,  $\leftarrow$  or  $\rightarrow$  to set to the No.1 setup SP setting.  
Setting range: SP1 lower to upper limit  
(Set the SP1 limit in setup data  $\text{C } 09$  or  $\text{C } 10$ .)
- (4) When you press  $\text{ENT}$ , blinking on the upper display stops. The lower display then starts blinking to indicate start of entry to the No.2 setup.
- (5) Press  $\uparrow$ ,  $\downarrow$ ,  $\leftarrow$  or  $\rightarrow$  to set to the No.2 setup time setting.  
Setting range: 0:00 to 99:59 (h:min/min:s)  
0.0 to 599.9 (0.1s)  
(Select either of h:min or min:s as the time unit in setup data  $\text{C } 54$ . ":" is substituted by "." as it cannot be displayed.)
- (6) When you press  $\text{ENT}$ , blinking on the lower display stops.

### ● Display

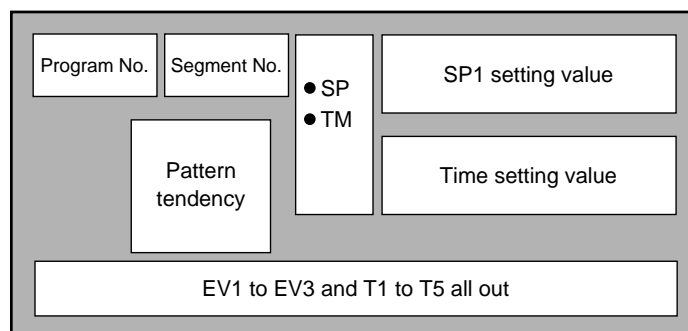

"- - -" is displayed for the SP and time setting values in non-set segments.

## ■ Setting up events 1 to 3 items

### ● When event type is PV type event

- (1) In the setting display state, move to the event 1 to 3 items of the segment to be set up on the programming map.
- (2) If you press  $\text{ENT}$ , the upper display starts blinking to indicate start of entry to the No.1 setup.
- (3) Press  $\uparrow$ ,  $\downarrow$ ,  $\leftarrow$  or  $\rightarrow$  to set to the No.1 setup event operating point setting.  
 Setting range: -1999 to 9999U  
 0 to 9999U (in case of absolute value deviation event)  
 -10.0 to 110.0% (in case of MV, MFB event)
- (4) When you press  $\text{ENT}$ , blinking on the upper display stops.  
 (When  $\text{FUNC}$  +  $\text{CLR}$  are pressed, the upper display returns to “- - - -” and stops blinking.)

### ● Display (PV type event)

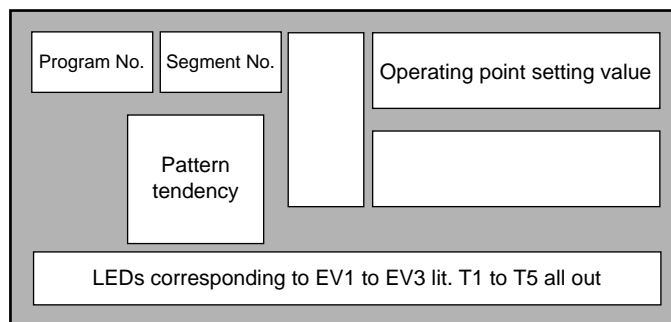

- “- - - -” is displayed for the setting values in non-set segments.
- When setup data  $\text{E} \text{ S} \text{ B}$  is set to 1, event 1 to 3 items on the programming map are skipped and not displayed.

### ● When event type is time event

- (1) In the setting display state, move to the event 1 to 3 items of the segment to be set up on the programming map.
- (2) If you press  $\text{ENT}$ , the upper display starts blinking to indicate start of entry to the No.1 setup.
- (3) Press  $\uparrow$ ,  $\downarrow$ ,  $\leftarrow$  or  $\rightarrow$  to set to the No.1 setup ON time setting.  
 Setting range: 0:00 to 99:59 (h:min/min:s)  
 0.0 to 599.9 (0.1s)  
 (Select either of h:min or min:s as the time unit in setup data  $\text{E54}$ . ":" is substituted by "." as it cannot be displayed.)
- (4) When you press  $\text{ENT}$ , blinking on the upper display stops. The lower display then starts blinking to indicate start of entry to the No.2 setup.  
 (When  $\text{FUNC}$  +  $\text{CLR}$  are pressed, the upper and lower displays both return to "- - -" and blinking stops.)
- (5) Press  $\uparrow$ ,  $\downarrow$ ,  $\leftarrow$  or  $\rightarrow$  to set to the No.2 setup ON time setting.  
 Setting range: ON time setting + 0:01 to 99:59 (h:min/min:s)  
 ON time setting + 0.1 to 599.9 (0.1s)  
 When you press  $\text{ENT}$ , blinking on the upper display stops.
- (6) (When  $\text{FUNC}$  +  $\text{CLR}$  are pressed, the upper display returns to "- - -" and stops blinking.)

### ● Display (time event)

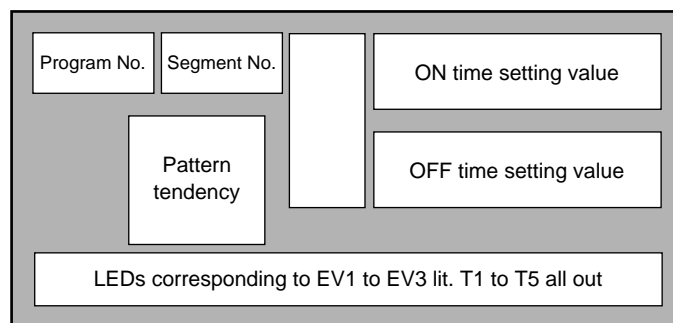

- "- - -" is displayed for the setting values in non-set segments.
- When setup data  $\text{E58}$  is set to 1, event 1 to 3 items on the programming map are all skipped and not displayed.
- When the event type is set to time event and the ON time is set to 99:59, "- - -" is displayed for the ON time and the display does not blink. In this case, the OFF time cannot be set.
- When the event type is set to time event and the ON time is set higher than the time setting of the pattern item, event output at that segment is OFF. However, note that event output is ON when the mode changes to the END mode at segments whose ON time and pattern item time are equal.

### ● When event type is controller status event

In this case, the event item on the programming map is skipped and not displayed.

■ Setting up time events 1 to 5

- (1) In the setting display state, move to the event 1 to 5 items of the segment to be set up on the programming map.
- (2) If you press **ENT**, the upper display starts blinking to indicate start of entry to the No.1 setup.
- (3) Press **▲**, **▼**, **◀** or **▶** to set to the No.1 setup ON time setting.  
 Setting range: 0:00 to 99:59 (h:min/min:s)  
 0.0 to 599.9 (0.1s)  
 (Select either of h:min or min:s as the time unit in setup data **54**. “:” is substituted by “.” as it cannot be displayed.)
- (4) When you press **ENT**, blinking on the upper display stops. The lower display then starts blinking to indicate start of entry to the No.2 setup.  
 (When **FUNC** + **CLR** are pressed, the upper and lower displays both return to “- - - -” and blinking stops.)
- (5) Press **▲**, **▼**, **◀** or **▶** to set to the No.2 setup ON time setting.  
 Setting range: ON time setting + 0:01 to 99:59 (h:min/min:s)  
 ON time setting + 0.1 to 599.9 (0.1s)
- (6) When you press **ENT**, blinking on the upper display stops.  
 (When **FUNC** + **CLR** are pressed, the upper display returns to “- - - -” and stops blinking.)

● Display

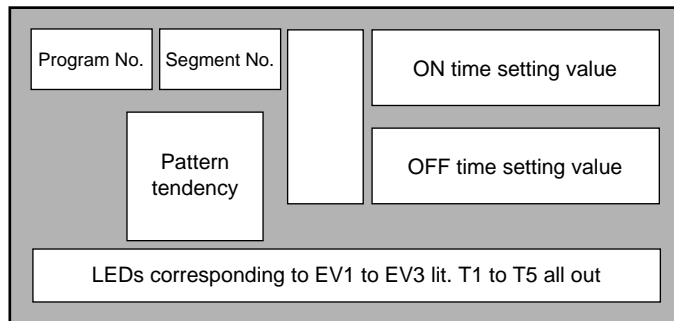

- “- - - -” is displayed for the setting values in non-set segments.
- On models that do not support time events, event 1 to 5 items on the programming map are all skipped and not displayed. The table below shows time events by a ○.

Time event No. T1 T2 T3 T4 T5 setting value	T1	T2	T3	T4	T5
0	○	○	○	○	○
1		○	○	○	○
2			○	○	○
3				○	○
4					○
5					

- When setup data **54** is set to 1, event 1 to 5 items on the programming map are all skipped and not displayed.
- When the ON time is set to 99:59, “- - - -” is displayed as the OFF time, and the display does not blink.
- When the ON time is set higher than the time setting of the pattern item, event output at that segment is OFF. However, note that event output is ON when the mode changes to the END mode at segments whose ON time and pattern item time are equal.

## ■ Setting up PID set No. items

- (1) In the setting display state, move to the PID set No. items of the segment to be set up on the programming map.
- (2) If you press  $\text{ENT}$ , the lower display starts blinking to indicate start of entry to the No.1 setup.
- (3) Press  $\uparrow$ ,  $\downarrow$ ,  $\leftarrow$  or  $\rightarrow$  to set to the No.1 setup PID set No. setting.  
 Setting range: 0 to 8 (non heat/cool models)  
 0 to 4 (heat/cool models)
- (4) When you press  $\text{ENT}$ , blinking on the upper display stops.

### ● Display

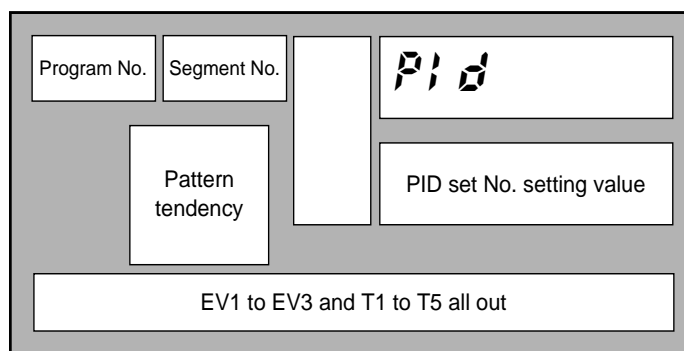

- When setup data  $\text{E}11$  is set to 1 and PID set auto-switching ON is selected, the PID set No. items on the programming map are skipped and not displayed.
- On 5G output models, when setup data  $\text{E}18$  is set to 1 and programmer functions are selected, the PID set No. items on the programming map are skipped and not displayed.
- On 3D output models, when setup data  $\text{E}45$  is set to 1 and 3-position-proportional control is selected, the PID set No. items on the programming map are skipped and not displayed.
- When setup data  $\text{E}70$  is set to 1, the PID set No. items on the programming map are all skipped and not displayed.
- When the PID set No. setting is set to 0, this means that the PID set No. of the previous segment is continued. When the PID set No. setting is set to 0 in the No.1 segments, this is the same as being set to 1.



### ■ Setting up G.Soak (guarantee soak) items

- (1) In the setting display state, move to the G.Soak item of the segment to be set up on the programming map.
- (2) If you press  $\text{ENT}$ , the lower display starts blinking to indicate start of entry to the No.1 setup.
- (3) Press  $\uparrow$ ,  $\downarrow$ ,  $\leftarrow$  or  $\rightarrow$  to set to the G.Soak width setting.  
Setting range: 0 to 1000U
- (4) When you press  $\text{ENT}$ , blinking on the lower display stops.  
(When  $\text{FUNC}$  +  $\text{CLR}$  are pressed, the lower display returns to “- - -” and blinking stops.)

● Display

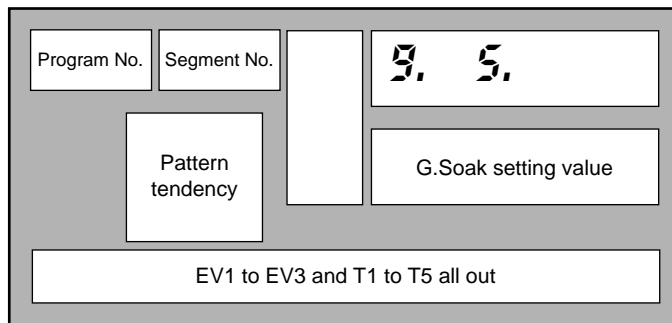

- “- - -” is displayed for the setting values in non-set segments.  
The G.Soak function does not work in non-set segments.
- When setup data  $\text{E}70$  is set to 1, G.Soak items on the programming map are skipped and not displayed.

### ■ Setting up G.Soak time-out items

- (1) In the setting display state, move to the G.Soak time-out item of the segment to be set up on the programming map.
- (2) If you press  $\text{ENT}$ , the lower display starts blinking to indicate start of entry to the No.1 setup.
- (3) Press  $\uparrow$ ,  $\downarrow$ ,  $\leftarrow$  or  $\rightarrow$  to set to the G.Soak time-out width setting.  
Setting range: 0:00 to 99:59 (h:min/min:s)  
0.0 to 599.9 (0.1s)  
(Select either of h:min or min:s as the time unit is setup data  $\text{E}64$ .  
“:” is substituted by “.” as it cannot display.)
- (4) When you press  $\text{ENT}$ , blinking on the lower display stops.  
(When  $\text{FUNC}$  +  $\text{CLR}$  are pressed, the lower display returns to “- - -” and blinking stops.)

● Display

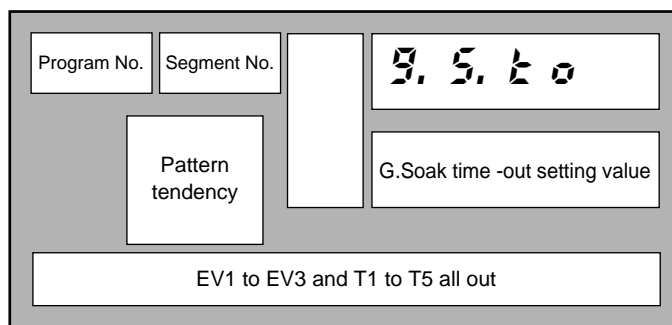

- “- - -” is displayed for the setting values in non-set segments.  
The G.Soak time out function does not work in non-set segments.
- When setup data  $\text{E}70$  is set to 1, G.Soak time-out items on the programming map are skipped and not displayed.

## ■ Setting up PV start items

- (1) In the setting display state, move to the PV start items on the programming map.  
(The settings are common to all segments as the PV start items are setting items provided for each program.)
- (2) If you press  $\text{ENT}$ , the lower display starts blinking to indicate start of entry to the No.1 setup.
- (3) Press  $\uparrow$ ,  $\downarrow$ ,  $\leftarrow$  or  $\rightarrow$  to set to the No.1 setup PV start setting.  
Setting range: 0 to 1  
0: PV start disabled  
1: PV start enabled
- (4) When you press  $\text{ENT}$ , blinking on the lower display stops.

### ● Display

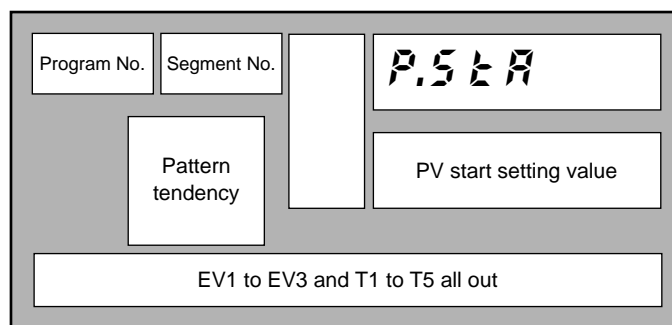

- The settings are common to all segments as the PV start items are setting items provided for each program.
- When setup data  $\text{ENT}$  is set to 1, PV start items on the programming map are skipped and not displayed.

## ■ Setting up cycle items

- (1) In the setting display state, move to the cycle items on the programming map.  
(The settings are common to all segments as the cycle items are setting items provided for each program.)
- (2) If you press  $\text{ENT}$ , the lower display starts blinking to indicate start of entry to the No.1 setup.
- (3) Press  $\uparrow$ ,  $\downarrow$ ,  $\leftarrow$  or  $\rightarrow$  to set to the No.1 setup cycle setting.  
Setting range: 0 to 9999
- (4) When you press  $\text{ENT}$ , blinking on the lower display stops.

### ● Display

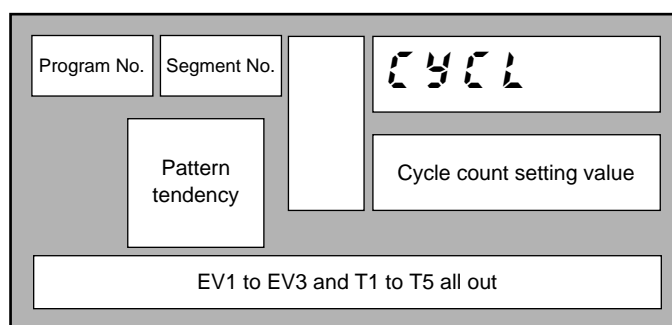

- The settings are common to all segments as the cycle items are setting items provided for each program.
- When setup data  $\text{ENT}$  is set to 1, cycle items on the programming map are skipped and not displayed.

■ Setting up pattern link items

- (1) In the setting display state, move to the pattern link items on the programming map.  
(The settings are common to all segments as the pattern link items are setting items provided for each program.)
- (2) If you press  $\text{ENT}$ , the lower display starts blinking to indicate start of entry to the No.1 setup.
- (3) Press  $\uparrow$ ,  $\downarrow$ ,  $\leftarrow$  or  $\rightarrow$  to set to the No.1 setup pattern link setting.  
Setting range: 0 to 19  
0: Pattern link disabled  
1 to 19: Pattern link destination program No.
- (4) When you press  $\text{ENT}$ , blinking on the lower display stops.

● Display

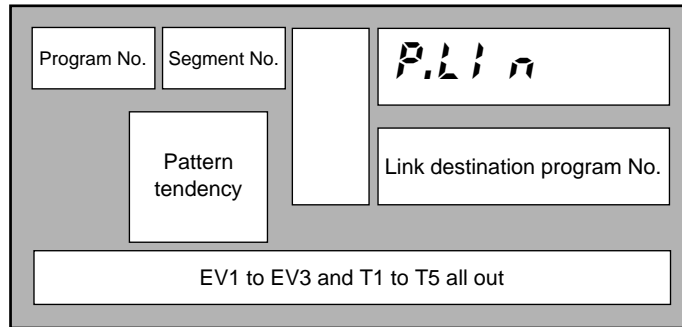

- The settings are common to all segments as the pattern link items are setting items provided for each program.
- When setup data  $\text{L7}$  is set to 1, pattern link items on the programming map are skipped and not displayed.

■ Deleting programs

- (1) In the setting display state, move to the pattern item of the segment from which the program is to be deleted on the programming map.  
To delete all the segments of a particular program, move to the No.1 segment.
- (2) If you press  $\text{ENT}$ , the upper display starts blinking to indicate start of entry to the No.1 setup.  
(So far, the procedure is the same as that for setting the pattern item.)
- (3) If you press  $\text{FUNC} + \text{CLR}$ , the display changes to confirm clearing of the program, and “ $\text{CLR}$ .” is displayed blinking in the upper display.
- (4) Press  $\text{ENT}$  to execute deletion of the program.
- (5) The DCP301 returns to the setting display state, both the upper and lower displays change to “- - -” to indicate no setting.

● Display

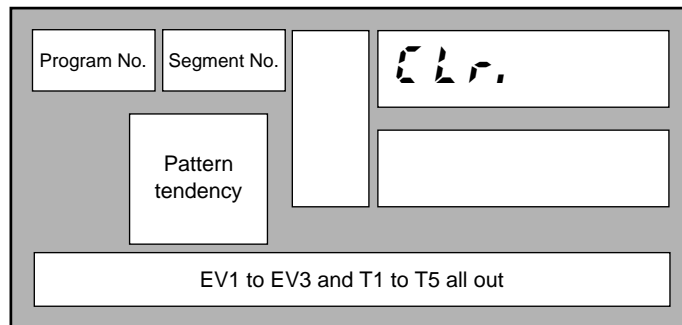

- In the above procedure,  $\text{FUNC} + \text{CLR}$  are pressed while entering values (SP setting value) to the No.1 setup. However, the program can also be deleted by pressing  $\text{FUNC} + \text{CLR}$  while entering values (time setting value) to the No.2 setup.
- “- - -” is displayed for the SP and time setting values in non-set segments.
- Currently running (RUN, HOLD, FAST, END) programs cannot be deleted.

## ■ Inserting and deleting segments

- (1) In the setting display state, move to the pattern item of the segment where the segment is to be inserted or deleted on the programming map.
- (2) If you press  $\text{FUNC}$  +  $\text{ENT}$ , the display changes to confirm insertion of the segment, and “INS.” is displayed blinking in the upper display.
- (3) If you press  $\blacktriangle$ , the display changes to confirm insertion of the segment, and “INS.” is displayed blinking in the upper display.  
If you press  $\blacktriangledown$ , the display changes to confirm deletion of the segment, and “DEL.” is displayed blinking in the upper display.
- (4) If you press  $\text{ENT}$  while “INS.” is displayed on the upper display, the segment is inserted.  
If you press  $\text{ENT}$  while “DEL.” is displayed on the upper display, the segment is deleted.
- (5) The DCP301 returns to the setting display state.

### ● Display (inserting segment)

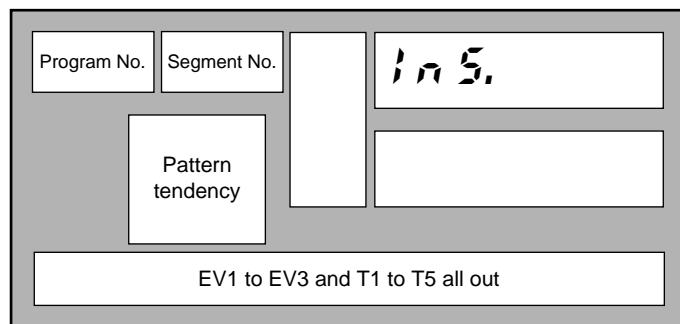

### ● Display (deleting segment)

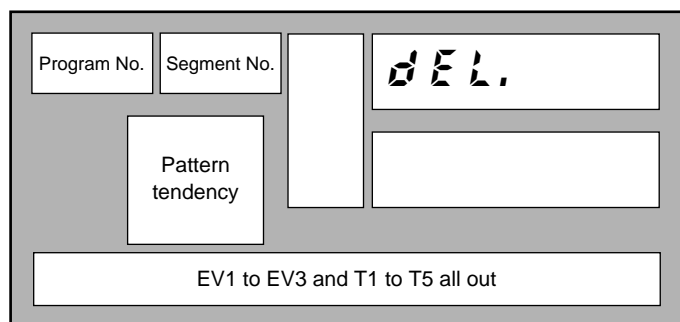

- When you insert a segment, a new segment is automatically created at the currently displayed segment No., and all segment Nos. onward are incremented by one. The setting of the inserted segment is as follows:  
SP setting value: Same value as original segment before the new segment was inserted  
Time setting value: 0:10  
Events, time events and G.Soak are not set, and the PID set No. is set to 0.
- If you try to insert a segment in a program already containing 30 segments, pressing  $\text{ENT}$  will not insert the segment.
- When you delete a segment, the next segment shifts down to the currently displayed segment No. and subsequent segment Nos. are decremented by one.  
When you delete the last segment, the display changes to “- - -” indicating that nothing is set.
- Segments cannot be inserted or deleted from currently running (RUN, HOLD, FAST, END) programs.

## 8-2 Copying Programs

The DCP301 can be set for copying programs in the program operation READY mode in the basic display state. If the DCP301 is not in the basic display state, press  $\text{DISP}$ .

### ■ Operation

- (1) Set the DCP301 to the program operation READY mode.

Set variable parameter  $\text{L O Z}$  to either of 0, 1 or 3, and variable parameter  $\text{P r t Z}$  to 0.

- (2) In the basic display state, press  $\text{PROG}$  or  $\text{▼}$  to select the copy source program No.

However, note that the program No. cannot be selected on the console when controlling the DCP301 by external switch inputs.

For details, see 6-3 Program Selection (page 6-7).

- (3) If you press  $\text{▲} + \text{PROG}$ , “ $\text{C O P Y}$ ” is displayed on the upper display, and the copy destination program No. is displayed on the lower display.

- (4) If you press  $\text{▲}$  or  $\text{▼}$ , currently non-set program Nos. are displayed blinking in order as the copy destination program No.

When there are no non-set program Nos., “- - -” is displayed on the lower display.

- (5) If you press  $\text{ENT}$ , program copy is executed, and the lower display stops blinking. To repeat the procedure, carry out steps (4) and (5) again.

- (6) To quit program copy, press  $\text{DISP}$ .

### ● Display

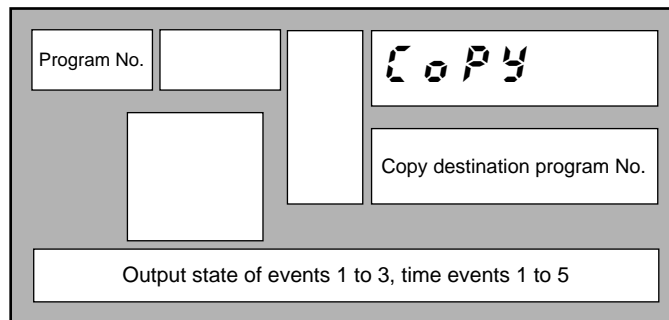

## 8-3 General Reset

A general reset can be executed when the DCP301 is in the READY AUTO mode in the basic display state. If the DCP301 is not in the basic display state, press  $\overline{\text{DISP}}$ .

A “general reset” involves the following operations:

- Clearing all program setups for program Nos.1 to 19
- Returning parameter setups to their factory settings
- Changing the mode to the program operation READY AUTO mode

### ■ Operation

(1) Set the DCP301 to the READY AUTO mode.

Set variable parameter  $\text{L02}$  and  $\text{Pr22}$  to 0.

(2) If you press  $\overline{\text{FUNC}} + \overline{\text{CLR}} + \overline{\text{DISP}}$  in the basic display state, the display changes to confirm execution of general reset, and “ $\text{G.R.E.S}$ ” is displayed on the upper display.

(3) If you press  $\overline{\text{ENT}}$ , the general reset is executed, and operation starts from startup at power ON.

If you press  $\overline{\text{DISP}}$ , general reset is not executed, and the DCP301 returns to the basic display state.

### ● Display

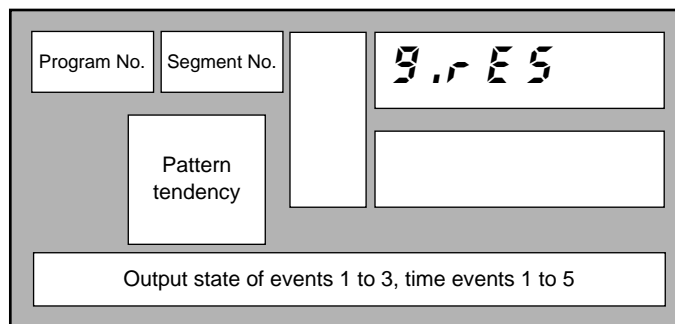

In the constant-value operation mode, all of the program No., segment No. and profiles displays are cleared.

- If a RAM backup error occurs when the power is turned ON, the display changes to confirm general reset without pressing any of the keys on the console, and “ $\text{G.R.E.S}$ ” is displayed in the upper display.

If you press  $\overline{\text{ENT}}$ , the general reset is executed. Other keys, however, cannot be operated.

- The following setup data items are not returned to their factory settings.

$\text{C02}, \text{C03}$ : Save setting values.

However, note that if a RAM backup error occurs when the power is turned ON,  $\text{C02}$  and  $\text{C03}$  settings become 0.

$\text{C04}, \text{C05}$ : These are set to 0 when the input 1 range type is set to linear.

$\text{C06}$ : This is set to 1000 when the input 1 range type is set to linear.

# Chapter 9. TROUBLESHOOTING

## 9-1 Self-diagnostics and Alarm Code Display

---

Self-diagnostics functions are incorporated into the controller. The table on the following page shows the alarm codes that are displayed as a result of self-diagnostics.

### ■ Self-diagnostics at power ON

- **PROM error**

An error in the system program stored to PROM has been detected. However, note that not all PROM errors are detected. Some errors are detected as controller operation errors.

The corresponding alarm code is displayed when this error is detected.

- **Adjustment value error**

An error in the analog I/O adjustment data stored to volatile memory has been detected.

The corresponding alarm code is displayed when this error is detected.

- **RAM backup error**

An error in the RAM backup function has been detected.

When this error is detected, a general reset is carried out.

An alarm code is not displayed for this error.

- **Board configuration error**

An error in the board configuration (combination of different PCBs) has been detected according to the catalog No. of the controller.

The corresponding alarm code is displayed when this error is detected.

### ■ Self-diagnostics at each sampling cycle

- **Analog input error**

A probable cause of this error is a disconnected analog input. This error is detected when the analog input is outside the -10.0 to 110.0% range.

The corresponding alarm code is displayed when this error is detected.

- **MFB (motor feedback) input error**

Disconnected MFB input or a short-circuit has been detected on 2G output models.

The corresponding alarm code is displayed when this error is detected.

### ■ Intermittent self-diagnostics during operation

- **Program error**

An error in the program setup data stored to backup RAM has been detected.

The corresponding alarm code is displayed when this error is detected.

- **Parameter error**

An error in the parameter setup data stored to backup RAM has been detected.

The corresponding alarm code is displayed when this error is detected.

- **Low battery voltage error**

A drop in the battery voltage for backing up RAM data has been detected.

When the low battery voltage error is detected, the red BAT LED on the console blinks.

■ Self-diagnostics only when certain functions are operating

● MFB (motor feedback) adjustment error

This error is detected when MFB automatic adjustment is not going smoothly on 2G output models.

The corresponding alarm code is displayed when this error is detected.

To clear this alarm, either execute automatic adjustment again or turn the power OFF then back ON again.

■ Alarm code display

When an input error or controller error is detected in the basic display state, the alarm code and regular display are displayed alternately every second on the program No. and segment No. displays. The table below shows alarm codes and alarm descriptions.

When two or more alarms occur at the same time, the alarm codes are displayed from the smallest number upwards together with the regular display.

However, note that when setup data **57** has been set to "1", alarm codes are not displayed.

■ Alarm categories

PV range alarm groups: **AL01** to **AL12**

Controller alarm groups: **AL81** to **AL99**, and low battery voltage

(BAT LED on console blinks in case of low battery voltage.)

Alarm Code	Alarm Name	Description	Remedy
<b>AL01</b>	Input 1 over-range	Input 1 has exceeded 110%FS	Check input 1
<b>AL02</b>	Input 1 under-range	Input 1 has fallen below -10%FS	
<b>AL07</b>	Input 1 RTD disconnection A	RTD line A is disconnected.	Check line of RTD (resistance temperature detector) connected to input 1 for disconnection, and terminal connections.
<b>AL08</b>	Input 1 RTD disconnection B	RTD line B or lines ABC are disconnected.	
<b>AL09</b>	Input 1 RTD disconnection C	RTD line C is disconnected.	
<b>AL10</b>	MFB disconnection	MFB (Y, T, G) line(s) is disconnected.	Check MFB wiring.
<b>AL11</b>	MFB short-circuit	Y-G line or Y-T-G line is short-circuited.	
<b>AL12</b>	MFB adjustment impossible	Faulty wiring, motor incompatibility etc.	Check wiring of MFB switching relay or motor specifications.
<b>AL70</b>	A/D trouble	A/D converter has malfunctioned.	Ask for repair.
<b>AL81</b>	Board configuration error	Faulty board configuration	Ask for repair.
<b>AL96</b>	Program error	Damaged program setup data	Check program setup, and reset damaged data. *1
<b>AL97</b>	Parameter error	Damaged parameter setup data	Check parameter setup, and reset damaged data. *2
<b>AL98</b>	Adjustment value error	Damaged analog input/output adjustment data	Ask for repair.
<b>AL99</b>	PROM error	Damaged system program	Ask for repair.

\*1 **AL96** goes out even if program setup data other the damaged data is reset.

\*2 **AL97** goes out even if parameter setup data other the damaged data is reset.





## 9-2 Trouble during Key Entry

### ■ The program No. does not change by pressing in basic display state

Cause	Remedy
Program selection by external switch input not 0.	Set all external switch inputs RSW8 to 12 OFF.
The controller is not in the READY mode.	Reset the controller.
The controller is in the constant-value operation mode.	Set constant-value operation data $\bar{n}.o.d.E$ setting to 0.
Key lock is enabled.	Set variable parameter $\bar{l}.o.l$ setting to 0 to 2.

### ■ The program No. does not change by pressing in the basic display state

Cause	Remedy
Program selection by external switch input not 0	Set all external switch inputs RSW8 to 12 OFF.
The controller is not in the READY mode.	Reset the controller.
The controller is in the constant-value operation mode.	Set constant-value operation data $\bar{n}.o.d.E$ setting to 0.
Entry changeable display state by   in MANUAL mode	Press  .
Key lock is enabled.	Set variable parameter $\bar{l}.o.l$ setting to 0 to 2.

### ■ The controller does not change to RUN mode by pressing in the basic display state

Cause	Remedy
The currently selected program in READY mode has not been set up.	Select an already set up program.
The controller is in the END mode.	Reset the controller to READY mode.
Key lock is enabled.	Set variable parameter $\bar{l}.o.l$ setting to 0 to 2.

### ■ The controller does not change to HOLD mode by pressing in the basic display state

Cause	Remedy
The controller is in the READY or FAST mode.	RUN mode is entered from READY or FAST mode. Press RUN/HOLD key again.
The controller is in the END mode.	Reset the controller to READY mode, and press  twice.
The controller is in the constant-value operation mode.	Set constant-value operation data $\bar{n}.o.d.E$ setting to 0.
Key lock is enabled.	Set variable parameter $\bar{l}.o.l$ setting to 0 to 2.

### ■ The controller cannot be reset by pressing + in the basic display state

“Reset in the program operation mode” refers to switching to the READY mode and returning to the No.1 segment.

“Reset in the constant-value mode” refers to switching to the READY mode.

Cause	Remedy
The controller is in the READY mode.	Press  to set the controller to the RUN mode. (The controller can be reset in case of external switch input or communications even in the READY mode.)
Key lock is enabled.	Set variable parameter $\bar{l}.o.l$ setting to 0 to 2.

■ The program is not advanced by pressing **PROG** + **DISP** in the basic display state

Cause	Remedy
The controller is in the READY mode.	Press <b>RUNHOLD</b> to set the controller to the RUN mode. (The controller can be reset in case of external switch input or communications even in the READY mode.)
The controller is in the END mode.	Press <b>PROG</b> + <b>RUNHOLD</b> to set the controller to the READY mode, and press <b>RUNHOLD</b> again to set the controller to the RUN mode.
The controller is in the constant-value operation mode.	Set constant-value operation data <b>n.o.d.E</b> setting to 0.
Key lock is enabled.	Set variable parameter <b>L.o.L</b> setting to 0 to 2.

■ The controller does not change to FAST mode by pressing **FUNC** + **▶** in the basic display state

Cause	Remedy
The controller is in the READY mode.	Press <b>RUNHOLD</b> to set the controller to the RUN mode. (The controller can be reset in case of external switch input or communications even in the READY mode.)
The controller is in the END mode.	Press <b>PROG</b> + <b>RUNHOLD</b> to set the controller to the READY mode, and press <b>RUNHOLD</b> again to set the controller to the RUN mode.
The controller is in the constant-value operation mode.	Set constant-value operation data <b>n.o.d.E</b> setting to 0.
Key lock is enabled.	Set variable parameter <b>L.o.L</b> setting to 0 to 2.

■ The controller does not change to MANUAL mode by pressing **AM** in the basic display state

Cause	Remedy
ON-OFF control is being carried out by 0D and 6D outputs.	Set PID set <b>P</b> setting in use to other than 0.0 and switch to PID control from ON-OFF control.
3-position-proportional control is selected by 3D output.	Set setup data <b>L45</b> setting to 0 and switch to PID control from 3-position-proportional control.
Key lock is enabled.	Set variable parameter <b>L.o.L</b> setting to 0 to 2.

■ The controller does not change to AUTO mode by pressing **AM** in the basic display state

Cause	Remedy
Key lock is enabled.	Set variable parameter <b>L.o.L</b> setting to 0 to 2.

■ Auto-tuning (AT) is not started by pressing **AT** in the basic display state

Cause	Remedy
The controller is in the READY mode.	Press <b>RUNHOLD</b> to set the controller to the RUN mode.
The controller is in the MANUAL mode.	Press <b>AM</b> to set the controller to the AUTO mode.
Input 1 over-range	Correctly wire input 1 to correct input state.
Controller set not to execute AT.	Set variable parameter <b>n.t</b> setting to other than 0.
The controller is set to programmer functions by 5G output.	Set setup data <b>L18</b> setting to 0.
This is a heat/cool model.	AT cannot be executed by 3D and 5K outputs.
Key lock is enabled.	Set variable parameter <b>L.o.L</b> setting to 0 to 2.

■ Auto-tuning (AT) is not canceled by pressing  $\text{AT}$  in the basic display state

Cause	Remedy
Key lock is enabled.	Set variable parameter $\text{L o E}$ setting to 0 to 2.

■ Setting group other than “ $\text{P R R}$ ” is not displayed by pressing  $\text{PARA}$  by selecting the setting group in parameter set state

Cause	Remedy
Key lock is enabled.	Set variable parameter $\text{L o E}$ setting to 0, 1 or 3.

■ Setting group other than “ $\text{S E E}$ ” is not displayed by pressing  $\text{PARA}$  by selecting the setting group in parameter set state

Cause	Remedy
Key lock is enabled.	Set variable parameter $\text{L o E}$ setting to 0 or 3.

■ The controller does not enter the setting entry state by pressing  $\text{ENT}$  in the parameter setup state

Cause	Remedy
“- - - -” is displayed on the lower display.	This cannot be displayed nor set. This item sometimes can be displayed or set by changing the setting of related items.
Unchangeable data is displayed on the lower display.	This is a display-only item.

■ The controller does not change to setup group selection state and setting entry state continues by pressing  $\text{PARA}$  in parameter setting entry state

Cause	Remedy
The controller displays items by $\text{PARA}$ assignment.	Press $\text{DISP}$ to return the controller to the basic display state, and press $\text{FUNC} + \text{PARA}$ .



■ The controller does not change to program setup state by pressing  $\text{FUNC} + \text{PROG}$  in the basic display state

Cause	Remedy
The controller is in the constant-value operation mode.	Set constant-value operation data $\text{N o E}$ setting to 0.
Key lock is enabled.	Set variable parameter $\text{L o E}$ setting to 0, 1 or 3.





■ The controller does not change to the setting entry state by pressing  $\text{ENT}$  in the basic display state

Cause	Remedy
The program setup cannot be changed.	Set program parameter $\text{P r E}$ setting to 0.



■ Items cannot be changed by pressing   in program setup state

Cause	Remedy
The pattern item has not been set.	Set SP and time data.
Programming items are set to "display OFF".	All setup data  to  settings are "1". Set necessary items to 0.





■ Event items cannot be displayed by repeatedly pressing   in program setup state

Cause	Remedy
Event type is controller status event.	Set event type (  ,  ,  ) in event configuration date to one of 0 to 11 or 50.
Programming items are set to "display OFF".	Set setup data  setting to 0.

■ Time events cannot be displayed by repeatedly pressing   in program setup state

Cause	Remedy
Time event is assigned to segment No. event.	Change event configuration data  setting and assign to time event.
This model does not support time events.	Select a mode that supports time events (option).
Programming items are set to "display OFF".	Set setup data  setting to 0.

■ PID set items cannot be displayed by repeatedly pressing   in program setup state

Cause	Remedy
PID set auto-switching is set to ON.	Set setup data  setting to 0.
The controller is set to programmer function by 5G output.	Set setup data  setting to 0.
3-position control is selected by 3D output.	Set setup data  setting in use to 0 and switch to PID control from 3-position control.
Programming items are set to "display OFF".	Set setup data  setting to 0.

■ G.Soak items cannot be displayed by repeatedly pressing   in program setup state

Cause	Remedy
Programming items are set to "display OFF".	Set setup data  setting to 0.

■ PV start items, cycle items and pattern link items cannot be displayed by repeatedly pressing   in program setup state

Cause	Remedy
Programming items are set to "display OFF".	Set setup data  setting to 0.

■ **Insertion/deletion of segments cannot be confirmed by pressing  +  in program setup state**

Cause	Remedy
The program setup cannot be changed.	Set program parameter $P r t \xi$ setting to 0.
The program being set up is being operated (RUN, HOLD, FAST, END).	Reset the controller.
Not pattern item on programming map	Move to pattern item on programming map.
Pattern item of non-set segment on programming map	Either move to already set up segment, or set up segment.

■ **Program deletion cannot be confirmed by pressing  +  while entering pattern items in program setup state**

Cause	Remedy
The program being set up is being operated (RUN, HOLD, FAST, END).	Reset the controller.

■ **The program cannot be copied by pressing  +  in the basic display state**

Cause	Remedy
The mode is not the READY mode.	Reset the controller.
The program of the currently selected program No. is not set up.	Select a program No. whose program is already set.
The controller is in the constant-value operation mode.	Set constant-value operation data $n.o.d \xi$ setting to 0.
The program is protected.	Set variable parameter $P r t \xi$ setting to 0.
Key lock is enabled.	Set variable parameter $k.o \xi$ setting to 0, 1 or 3.

■ **General reset is not applied by pressing  +  +  in the basic display state**

Cause	Remedy
The mode is not the READY mode.	Reset the controller.
The mode is the MANUAL mode.	Execute auto operation.
Program is protected.	Set variable parameter $P r t \xi$ setting to 0.
Key lock is enabled.	Set variable parameter $k.o \xi$ setting to 0.

## 9-3 Motor Adjustment is Impossible

There are two ways of wiring a motor to the DCP301: wiring for direct motor rotation and wiring for reverse motor rotation. When wired for direct motor rotation, the motor rotates in clockwise (CW ↻) direction when DCP301 output increases. There are two ways of making the motor rotate in the reverse direction (counterclockwise: CCW) depending on your control requirements (e.g. cooling control):

- By switching the control operating direction on the DCP301 with the motor wired to the DCP301 for direct motor rotation as it is, or
- By wiring the motor to the DCP301 for reverse motor rotation.

The control operating direction (direct/reverse) can be switched on this controller. If the motor is wired to the controller for direct motor rotation, the DCP301 can be easily set up for control in either direction. This makes it easier to remedy trouble that may occur during controller operation. For this reason, we recommend wiring the motor to the DCP301 for direct motor operation.

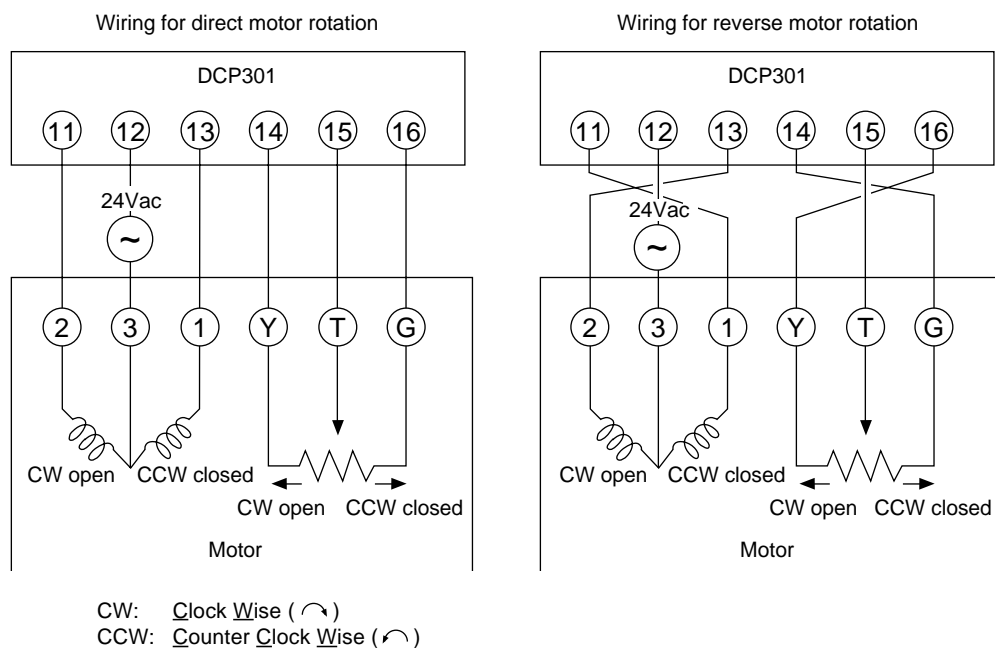

The DCP301 is also provided with a function (**RL 10** to **RL 12**) for detecting MFB disconnection or short-circuit if the motor has been wired to the controller in the wrong way.

By this function, the DCP301 judges reverse direction wiring in the same way as direct direction wiring, and does not generate an alarm. If the setting of variable parameter **RL 12** is left at the factory setting ("0"), motor operation is continued.

The following tables summarize the phenomena that occur according to how the motor and DCP301 are wired when the motor is automatically adjusted (variable parameter **RL 12** setting 1 is input). Motor rotation is started from the fully closed position (motor is turned as far as possible CCW).

The values displayed in the lower display in the tables are only examples. Alarms are displayed after the motor fully closes or fully opens.

### ■ Normal wiring for direct motor rotation

Upper Display	Lit LEDs	Lower Display	Motor Action	Remarks
CA.LL ↓	OT2	Readout decreases from 1000 to 500 and stabilizes.	CCW	If the motor rotates CCW when OT2 lights, motor terminals 1 and 2 are wired for direct rotation.
CA.OP	OT1	Readout increases from 500 to 9500 and stabilizes.	CW	

### ■ Normal wiring for reverse motor rotation

Upper Display	Lit LEDs	Lower Display	Motor Action	Remarks
CA.LL ↓	OT2	Readout decreases from 9000 to 500 and stabilizes.	CW	If the motor rotates CW when 1↔2 and G↔Y are reversed and OT2 lights, motor terminals 1 and 2 are wired for reverse rotation.
CA.OP	OT1	Readout increases from 500 to 9500 and stabilizes.	CCW	

### ■ Alarm display caused by wrong wiring and causes

Upper Display	Lit LEDs	Lower Display	Motor Action	Alarm Display	Cause
CA.LL ↓ CA.OP	OT2  OT1	Display increases and stabilizes. Display decreases and stabilizes.	CCW CW	AL12	G↔Y reversed
CA.LL ↓ CA.OP	OT2 OT1	Display decreases and stabilizes. Display stabilizes at 9999.	CCW CW	AL12	T↔G reversed
CA.LL	OT2	Display stabilizes at 9999.	CCW	AL11 AL12	T↔Y reversed
CA.LL ↓ CA.OP	OT2 OT1	Display increases and stabilizes. Display decreases and stabilizes.	CW CCW	AL12	1↔2 reversed
CA.LL	OT2	Display stabilizes at 9999.	CW	AL11 AL12	1↔2 reversed, T↔G reversed
CA.LL ↓ CA.OP	OT2 OT1	Display decreases and stabilizes. Display stabilizes at 9999.	CW CCW	AL12	1↔2 reversed, T↔Y reversed

## 9-4 Replacing the Battery

### CAUTION



Before replacing the battery, be sure to turn the power OFF. Failure to do so might cause electric shock.



Do not touch internal components immediately after turning the power OFF to replace the battery. Doing so might cause burns.



- Do not insert the battery with the polarities (+,-) reversed.
- Do not use damaged (broken battery skin, leaking battery fluid) batteries.
- Do not throw batteries into fires, or charge, short-circuit, disassemble or heat batteries.
- Store batteries in low-temperature, dry locations.

Failure to observe the above cautions may cause batteries to emit heat or split, or battery fluid to lead.



Store batteries out of the reach of small children.

Batteries are small and are easy to swallow. If a child swallows a battery, consult a physician immediately.



Return used batteries to Honeywell sales/service office or your dealer. When disposing of used batteries at the user site, observe local bylaws.

#### Handling Precautions

- Before handling components inside the controller, touch a grounded metal part to remove any static electricity from the body. Static electricity may cause damage to controller components.
- Batteries left in storage for a long time discharge electricity, reducing their service life. Purchase new batteries as required.

The parameter setups and program setups on the DCP301 are stored to battery backed up memory (RAM). So, stored setups are held in memory even if the controller is turned OFF.

However, when battery voltage becomes low, stored setups are no longer held in memory when the controller is turned OFF.

#### ■ BAT LED blinking

When low battery voltage is detected, the BAT LED on the console blinks. The voltage level for detection of low battery voltage is set higher than the required voltage level for holding stored setups in memory.

Accordingly, as soon as the BAT LED starts blinking, stored setups can still be held in memory. However, if the controller is turned back ON after being left for a long time and the BAT LED blinks, setups stored to memory may be damaged.

#### ■ Items to prepare

- Phillips head screwdriver
- New lithium battery: Model No. 81446431-001



## ■ Replacement procedure

### ! Handling Precautions

- Replace with the lithium battery set (model No.: 81446431-001). The lithium battery set can be ordered from Yamatake Corporation.
- When removing or mounting the RAM board or battery connectors, do not use metallic tools. Doing so might short-circuit electrical circuits.
- While the battery is removed for battery replacement, the capacitor on the RAM board backs up the contents of memory.

As this capacitor is charged, make sure that the controller is left ON for at least 1h before replacing the battery. Insert the new battery on the RAM board within 24h of turning the controller OFF.

When the BAT LED starts blinking, follow the procedure below to replace the battery.

- (1) Leave the controller turned ON for at least 1h.
- (2) Turn the power OFF.
- (3) Remove the key cover from the console, and fully loosen the lock screw under  with a Phillips screwdriver.
  - >> The body comes out towards you.

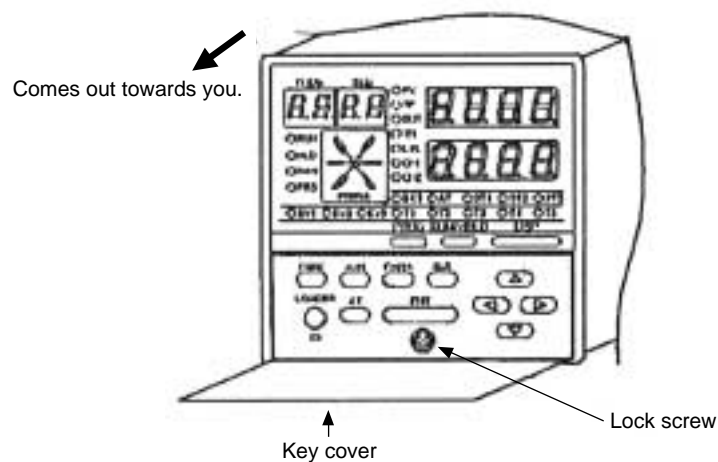

- (4) Before handling components inside the controller, touch a grounded metal part to remove any static electricity from the body.
- (5) Pull the body out towards you to remove from the case.
  - >> You should be able to see the button-shaped battery on the left facing the body.

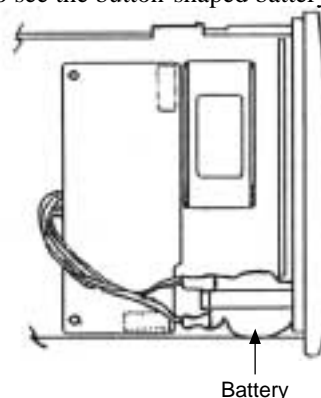

- (6) Place the body on its save on a desk or flat surface so that the side on which the battery is installed is facing up.
- (7) Remove the battery from its gray holder.
- (8) Remove the RAM board (approx. 3cm x 8cm) with the battery still connected to the board.  
The RAM board is connected to the base board by two connectors.

**! Handling Precautions**

When placing the RAM board on the desk, make sure that the solder surface of the board is face down. If the component mounting surface is placed face down, the components may become damaged.

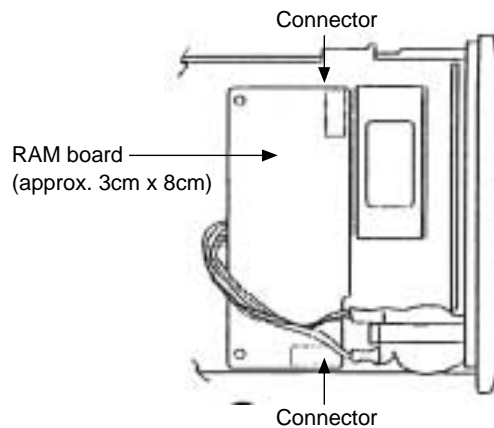

- (9) Remove the battery connector from the RAM board.



- (10) Connect the connector of the new battery to the RAM board making sure that it is inserted the correct direction.
- (11) Mount the RAM Board making sure that it is mounted in the correct direction. Do not insert the battery cable under the RAM board.

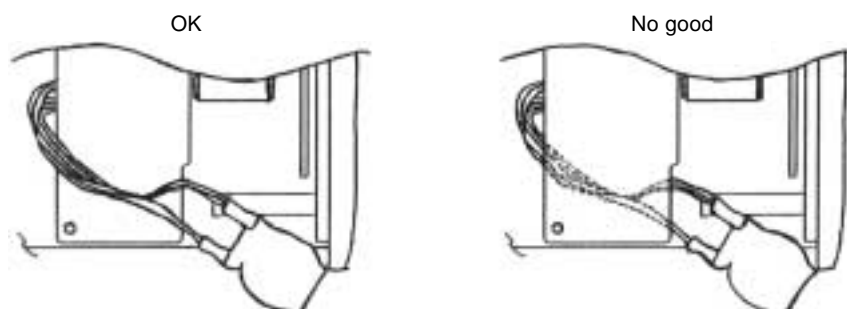

- (12) Fit the battery into the gray holder so that the battery cable is above the RAM board.

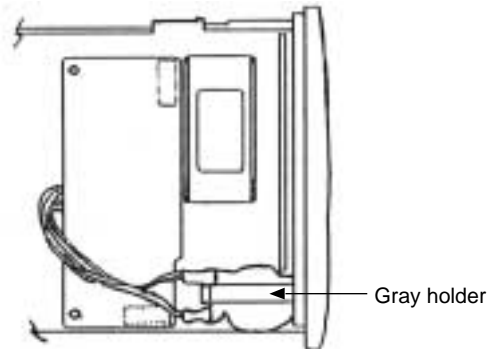

- (13) Insert the body into the case.  
Do not exert excessive force if the body cannot easily fit into the case. Also, make sure that the boards mounted on the body are not loose or twisted.
- (14) Tighten the lock screw while slightly pushing in the controller's console. Take care not to overtighten the screw.
- (15) Turn the controller ON, and make sure that the BAT LED is out.

### Note

- The following serves as a general guideline for when to replace the battery:
  - About 3 years when using the controller under standard operating conditions (operating temperature:  $23\pm 2^{\circ}\text{C}$ ) with the controller ON
  - About 10 years when using the controller under standard operating conditions (operating temperature:  $23\pm 2^{\circ}\text{C}$ ) with the controller OFF
- Using the controller in a higher operating temperature will shorten its service life.
- Setups are held in memory even if the BAT LED is blinking.
- The controller operates in one of two ways when memory contents are damaged.
  - (1) "G. r. E 5" is displayed when the controller is turned ON and regular operation is not started.  
(If this happens, press  to execute a general reset. This restores parameter setups to factory settings and clears the program setup.)
  - (2) Regular operation is started when the controller is turned ON, and one or both of alarm codes  $\overline{AL96}$  and/or  $\overline{AL97}$  is displayed.

# Chapter 10. SPECIFICATIONS

## 10-1 Specifications

Item		Specification
Program	Number of programs	19
	Number of segments	30 per program
	Segment setting system	RAMP-X system: Set by set points (SP) and time.
	Segment time	0 to 99h 59min, or 0 to 99min 59s (time unit selectable)
	Basic time accuracy	±0.01% (0.1s delay when segment time setting=0)
	Events (3)	Set operating point.
	Time events (5)	Set ON and OFF times.
	PID set No.	Set 0 to 8 (Set 0 for continuation of previous segment) (Set 0 to 4 on heat/cool models.)
	G.Soak	Sets G.Soak width 0 to 1000U.
	PV start	Sets program ON/OFF.
	Cycle	Sets program count 0 to 9999.
	Pattern link	Sets program No.0 to 19 (0: no link)
Tag	Sets 8 alphanumerics for each program (not displayed on controller)	
Input	Input type	Thermocouple, resistance temperature detector, dc voltage, dc current multi-range (See pages 2-8 and 2-9.)
	Input readout accuracy	±0.1%FS±1U (varies according to standard conditions, display value conversion and range) <ul style="list-style-type: none"> <li>• At -100°C max. of K and T thermocouples: ±1°C1U</li> <li>• At 260°C max. of B thermocouple: ±4%FS±1U</li> <li style="padding-left: 20px;">At 260 to 800°C: ±0.4%FS±1U</li> <li style="padding-left: 20px;">At 800 to 1800°C: ±0.2%FS±1U</li> <li>• At 100°C max. of R and S thermocouples: ±0.2%FS±1U</li> <li style="padding-left: 20px;">At 100 to 1600°C: ±0.15%FS±1U</li> <li>• At 300°C max. of PR40-20 thermocouple: ±2.5%FS±1U</li> <li style="padding-left: 20px;">At 300 to 800°C: ±1.5%FS±1U</li> <li style="padding-left: 20px;">At 800 to 1900°C: ±0.5%FS±1U</li> <li>• Golden iron chromel thermocouple: ±1.5K±1U</li> <li>• 2-digit range past decimal point by resistance thermometer detector input: ±0.15%±1U</li> <li style="padding-left: 20px;">At 0 to 10mV range: ±0.15%FS±1U</li> <li>• At -100°C max. of DIN U thermocouple: ±2°C±1U</li> <li style="padding-left: 20px;">At -100 to 0°C: ±1°C±1U</li> <li>• At -100°C max. of DIN L thermocouple: ±1.5°C±1U</li> </ul>
	Input sampling cycle	0.1s
	Input bias current	Thermocouple, dc voltage input: ±1.3µA max. (at peak value, under standard conditions) At 1V min. range: 3µA max.
	Input impedance	dc current input: 50Ω ±10% (under operating conditions)
	Measuring current	RTD input: 1.04mA ±0.02mA, current flow from terminal A (under operating conditions)
	Influence of wiring resistance	Thermocouple, dc voltage input: Changes in readout value at wiring resistance of 250Ω at both ends are as follows by input conversion: <ul style="list-style-type: none"> <li>• 0 to 10mV, -10 to 10mV: Within 35µV</li> <li>• 0 to 100mV: Within 60µV</li> <li>• Other: Within 750µV</li> </ul> RTD input: ±0.01%FS max. in wiring resistance range 0 to 10Ω Range of F01, F33, F38, P01, P33 and P38: ±0.02%FS/Ω max. Allowable wiring resistance is 85Ω max. (including Zener barrier resistance. When Zener barrier is used, this applies only to ranges other than F01, F33, F38, P01, P33 and P38. Note that site adjustment is required.)
	Allowable parallel resistance	Thermocouple disconnection detection allowable parallel resistance: 1MΩ min.
	Max. allowable input	Thermocouple, dc voltage input: -5 to +15Vdc dc current input: 50mAdc, 2.5Vdc
	Burnout	Upscale and downscale can be internally selected. (dc current input and dc voltage input of 1V or more are only downscaled.)

## Chapter 10. SPECIFICATIONS

Item		Specification
Input	Over-range detection threshold	110%FS min.: Upscaled -10%FS max.: Downscaled (Note that F50 range is not downscaled. Lower readout limit of B18 range is 20°C, 68°F.)
	Cold junction compensation accuracy	±0.5°C (under standard conditions)
	Influence of surrounding temperature on cold junction compensation	±0.2°C (at 0 to 50°C range)
	Cold junction compensation system	Internal/external (0°C only) compensation selectable
	Scaling	-1999 to 9999U (settable at dc voltage and dc current ranges. Reverse scaling and decimal point repositioning possible)
	Square root extraction	Dropout 0.1 to 10.0%, Possible by dc current and voltage ranges
	Linearization table approximation	12 (both line ends fixed, 11 points variable)
	Input bias	-1000 to 1000U variable
	Digital filter	0.0 to 120.0s variable (filter OFF at 0.0)
External Switch (RSW)	Number of inputs	12
	Types of connectable outputs	Dry contacts (relay contact) and open-collector (current sink to ground)
Input	Terminal voltage (open)	10.4 to 12.6V (under operating conditions) across common terminal (terminal ②5) and each input terminal
	Terminal current (short-circuit)	5.0 to 6.6mA across each terminal (under operating conditions)
	Allowable contact resistance (dry contact)	ON: 700Ω max. (under operating conditions) OFF: 10kΩ min. (under operating conditions)
	Residual current (allowable open-collector ON)	3V max. (under operating conditions)
	Leakage current (allowable open-collector OFF)	0.1mA max. (under operating conditions)
	Parallel connection to other instruments	Can be connected to DCP301/302 series.
	Assignments (fixed)	RUN, HOLD, RESET, ADV, program No.
	Assignments (variable)	FAST, PV start, AT, AUTO/MANUAL, G.Soak cancel, reverse/direct action
	Input sampling cycle	0.1s
	ON detection min. hold time	0.2s (program No. 0.4s)
Indication /Programmer	Upper display	Green 4-digit, 7-segment LED This normally displays PV values. Item codes are displayed in parameter setup.
	Lower display	Orange 4-digit, 7-segment LED This normally displays SP values. Setting values are displayed in parameter setup.
	Program No. display	Green 2-digit, 7-segment LED This normally displays program No.
	Segment No. display	Green 2-digit, 7-segment LED This normally displays segment No. Item Nos. are displayed in parameter setup, and alarm No. is displayed when alarm occurs.
	Profile display	6 orange LEDs Displays program pattern rise, soak and fall tendencies.
	Status displays	22 round LEDs Modes: RUN, HLD, MAN, PRG (green) Display details: PV, SP, OUT, TM, CYC (green) Battery voltage: BAT (red) (blinks at low voltage) Status: AT, OT1, OT2, OT3 (orange) Events: EV1, EV2, EV3, T1, T2, T3, T4, T5 (orange)
	Operation keys	13 rubber keys
	Loader connector port	1 (dedicated cable with stereo miniplugs)

Item		Specification		
Mode	Program operation mode	READY:	Ready to run program (control stop/program No. selectable)	
		RUN:	Program run	
	HOLD:	Program hold		
	FAST:	Program fast-forward		
		END:	Program end	
		AUTO:	Automatic operation	
		MANUAL:	Manual operation (output controlled on console)	
	Constant-value operation mode	READY:	Ready to run program (control stop)	
		RUN:	Program run	
		AUTO:	Automatic operation	
		MANUAL:	Manual operation (output controlled on console)	
Control	PID control	Proportional band (P)	0.0 to 999.9% (0D, 6D output), ON-OFF control by 0.0 0.1 to 999.9% (2G, 5G, 3D, 5K output)	
		Rate time (I)	0 to 3600s, PD control by 0	
		Reset time (D)	0 to 1200s, PI control by 0	
		MV limit	Lower limit: -10.0 to upper limit % Upper limit: Lower limit to 110.0%	
		Manual reset	0.0 to 100.0%	
		Number of PID sets	8 sets for program operation + 1 set for constant-value operation	
		PID set selection	Segment designation/automatic zone selection can be switched by program operation	
		MV change limit	0.0 to 10.0%/0.01s, no limit by 0.0	
		Auto-tuning	Automatic setting of PID value by limit cycle system + Neuro & Fuzzy (2 degrees of freedom PID) and Smart systems (executable by 0D, 2G, 5G and 6D outputs)	
		ON-OFF control differential	0 to 1000U (settable by 0D and 6D outputs)	
		Position-proportional dead zone	0.5 to 25.0% (settable by 2G output)	
		Heat/cool dead zone	-100.0 to 50.0% (settable by 3D and 5K outputs)	
		3-position control	Deviation lower limit	0 to 1000U (settable when 3-position control is selected by 3D output)
			Deviation upper limit	
	Deviation lower limit hysteresis			
	Deviation upper limit hysteresis			
	Reverse/direct action switching	Switchable	(0D, 2G, 5G, 6D outputs)	
	Programmer function	Switching	MV output can be switched to SP output (5G output).	
		Scaling	Supported	
		Output resolution	1/10000	

Item		Specification	
Control	Auxiliary output	Type	PV, SP, deviation, MV, MFB
		Scaling	Supported
		Output resolution	1/10000
Output	0D output 1 3D outputs 1, 2	Relay contact output	Contact type: 1a1b Contact rating: 5A (30Vdc, resistive load) 5A (120Vac, resistive load) 4A (240Vdc, resistive load) Allowable contact voltage: 250Vac, resistive load 125Vdc, resistive load Max. switching power: 150W, resistive load 960VA, resistive load Life: 100,000 operations (resistive load at contact rating, frequency: 30 operations/minute) Min. switching voltage: 5V Min. switching current: 100mA Output resolution: 1/1000 Time-proportional cycle: 5 to 120s
	2G output 1	M/M drive relay	Contact type: 1a (2 circuits) Contact rating: 2.5A (30Vdc, L/R=0.7ms) 4A (120Vac, cos $\phi$ =0.4) 2A (240Vac, cos $\phi$ =0.4) Allowable contact voltage: 250Vac, cos $\phi$ =0.4 125Vdc, L/R=0.7ms Max. switching power: 75W (L/R=0.7ms) 480VA (cos $\phi$ =0.4) Life: 100,000 operations (cos $\phi$ =0.4 at contact rating, frequency: 30 operations/minute) Min. switching voltage: 5V Min. switching current: 100mA MFB (motor feedback) input range: 100 to 2500 $\Omega$ Control at MFB (motor feedback) disconnection: ON/OFF for continuation of operation according to MFB estimated position can be selected.
	5G output 1 5K outputs 1, 2 Auxiliary outputs 1, 2	Current output (4 to 20mA)	Output current: 4 to 20/0 to 20mAdc Allowable load resistance: 600 $\Omega$ max. (under operating conditions) Output accuracy: $\pm$ 0.1%FS max. (under standard conditions) $\pm$ 0.5%FS at output 5% or less of 0 to 20mA output Output resolution: 1/10000 Inrush current: 25mA max. for 50ms max. (at 250 $\Omega$ load) Max. output current: 22.0mAdc Min. output current: 0.0mAdc Output updating cycle: 0.1s Open terminal voltage: 25V max. (output 1) 18V max. (output 2, auxiliary outputs 1, 2)
	6D output 1 5K outputs 1, 2 (when current output is switched to voltage output)	Voltage output	Allowable load resistance: 600 $\Omega$ max. (under operating conditions) Inrush current: 25mA max. for 50ms max. (at 250 $\Omega$ load) Load current adjustment: 2 to 22mA variable Open terminal voltage: 25V max. (output 2 of 5K output) 18V max. (output 2 of 5K output) OFF leakage current: 100 $\mu$ A max. Output response time: At ON-OFF 600 $\Omega$ load: 0.5ms max. At OFF-ON 600 $\Omega$ load: 1.0ms max. Output resolution: 1/1000 Time-proportional cycle: 1 to 60s variable

Item		Specification		
Event/ Time Event Output	Events 1, 2	Relay contact output	Contact type: 1a Contact rating: 1A (240Vac/30Vdc, resistive load) Life: 100,000 operations (at rating) Min. switching voltage, current: 10V, 10mA	
	Event 3	Relay contact output	Contact type: 1a1b Contact rating: 2A (240Vac/30Vdc, resistive load) Life: 100,000 operations (at rating) Min. switching voltage, current: 10V, 10mA	
	Time events 1 to 5	Open-collector output	External supply voltage: 10 to 29Vdc Max. load current: 70mA/load OFF leakage current: 0.1mA ON residual voltage: 1.6V max.	
	Event 1 to 3 settings	Event type	PV type events:	PV, deviation, absolute value deviation, SP, MV, MFB
			Controller status events:	RUN+HOLD+FAST+END, READY, RUN, HOLD, FAST, END, G.Soak standby, MANUAL, auto-tuning executing, constant-value operation, MFB estimated position control, sum of all alarms, PV range alarm, controller alarms, low battery voltage, setting on console, ADV
			Time events	
			Event standby	ON/OFF selectable
	Event hysteresis	0 to 200U (event types PV, deviation, absolute value deviation or SP) 0.0 to 20.0% (event types MV or MFB)		
	Event ON delay	0 to 3600s		
Time event 1 to 5 settings	Time event type	Time events, segment No. events		
Commu- nications	Communications system	Communications standard	RS-485	
		Network	Multidrop (DCP301 provided with only slave node functionality) 1 to 31 units max.	
		Data flow	Half duplex	
		Synchronization	Start-stop synchronization	
	Interface system	Transmission system	Balanced (differential)	
		Data line	Bit serial	
		Signal line	5 transmit/receive lines (3-wire connection also possible)	
		Transmission speed	4800, 9600bps	
		Transmission distance	500m max. (total)	
Other	Conforming to RS-485			



## Chapter 10. SPECIFICATIONS

Item		Specification		
	Display characters	Char. bit count	11bits/character	
		Format	1 start bit, even parity, 1 stop bit; or 1 start bit, no parity, and 2 stop bits	
		Data length	8bits	
	Isolation	All inputs and outputs are completely isolated.		
RS-485 communications can be performed by connecting to a computer equipped with an RS-485 interface.				
General Specifications	Memory backup	Memory	Battery backed-up RAM	
		Battery life	Controller power OFF    Approx. 3 years under standard conditions Controller power ON    Approx. 10 years under standard conditions	
	Rated power voltage	90 to 264Vac, 50/60Hz		
	Power consumption	30VA max.		
	Power ON rush current	15A max., 10ms (under operating conditions)		
		<b>! Handling Precautions</b> When starting up a number of DCP31s simultaneously, ensure ample power is supplied or stagger startup times. Otherwise, the controllers may not start normally due to inrush current induced-voltage drop. Voltage must stabilize within 2s after power ON.		
	Power ON operation	Reset time:	15s max. (time until normal operation possible under normal operating conditions)	
	Allowable transient power loss	20ms max. (under operating conditions)		
	Insulation resistance	Min. 20MΩ across power terminal (1) or (2) and ground terminal (3) (using a 500Vac megger)		
	Dielectric strength	1500Vac 50/60Hz for 1min across power terminal and ground terminal 1500Vac 50/60Hz for 1min across relay output and ground terminal 500Vac 50/60Hz for 1min across non-power terminal and ground terminal 500Vac 50/60Hz for 1min across isolated terminals		
	Standard conditions	Ambient temperature	23 ±2°C	
		Ambient humidity	60 ±5%RH	
		Rated power voltage	105Vac ±1%	
		Power frequency	50 ±1Hz or 60 ±1Hz	
		Vibration resistance	0m/s <sup>2</sup>	
		Impact resistance	0m/s <sup>2</sup>	
		Mounting angle	Reference plane (vertical) ±3°	
	Operating conditions	Altitude	2000m max.	
		Ambient temperature range	0 to 50°C (temperature at case bottom when closely mounted) 10 to 90%RH (no condensation)	
		Ambient humidity range	90 to 264Vac	
		Rated power voltage	50 ±2Hz or 60 ±2Hz	
		Power frequency	0 to 1.96m/s <sup>2</sup>	
		Vibration resistance	0 to 9.80m/s <sup>2</sup>	
Impact resistance		Reference plane (vertical) ±10°		
Mounting angle				
Installation mode	Permanently connected type controller, indoor installation, panel-mounted			
Applicable standards	EN61010-1, EN50081-2, EN50082-2 (CE statement), EN61326			
Installation category	Category II (IEC664-1, EN61010-1)			
Pollution degree	2			

Item		Specification		
General Specifications	Transport/storage conditions	Ambient temperature range	-20 to +70°C	
		Ambient humidity range	10 to 95%RH (no condensation)	
		Vibration resistance	0 to 4.90m/s <sup>2</sup> (10 to 60 Hz for 2h each in X, Y and Z directions)	
		Impact resistance	0 to 490m/s <sup>2</sup> (3 times vertically)	
		Package drop test	Drop height: 60cm (1 angle, 3 edges and 6 planes; free fall)	
	Fuse	Rated	IEC127	
		Cutoff speed	Delayed operation type (T)	
		Rated voltage	250V	
		Rated current	1A	
	Terminal screw	M3.5 self-tapping screw		
	Terminal screws tightening torque	0.78 to 0.98N•m		
	Mask/case materials	Mask: Multilon	Case: Polycarbonate	
	Mask/case color	Mask: Dark gray (Munsell 5Y3.5/1)	Case: Light gray (Munsell 2.5Y7.5/1)	
	Installation	Specially designed mounting bracket		
Mass	Approx. 900g			

### ■ Accessories/option list

	Item	Model No.	Q'ty
Standard accessories	Unit indicating label	N-3132	1
	Mounting bracket	81405411-001	1 set (2 brackets)
	User's Manual	EN11-6197	1
Options (sold separately)	Hard dust-proof cover set	81446083-001	—
	Soft dust-proof cover set	81446087-001	—
	Terminal cover set	81446084-001	—
	Lithium battery set	81446431-001	—

## 10-2 External Dimensions

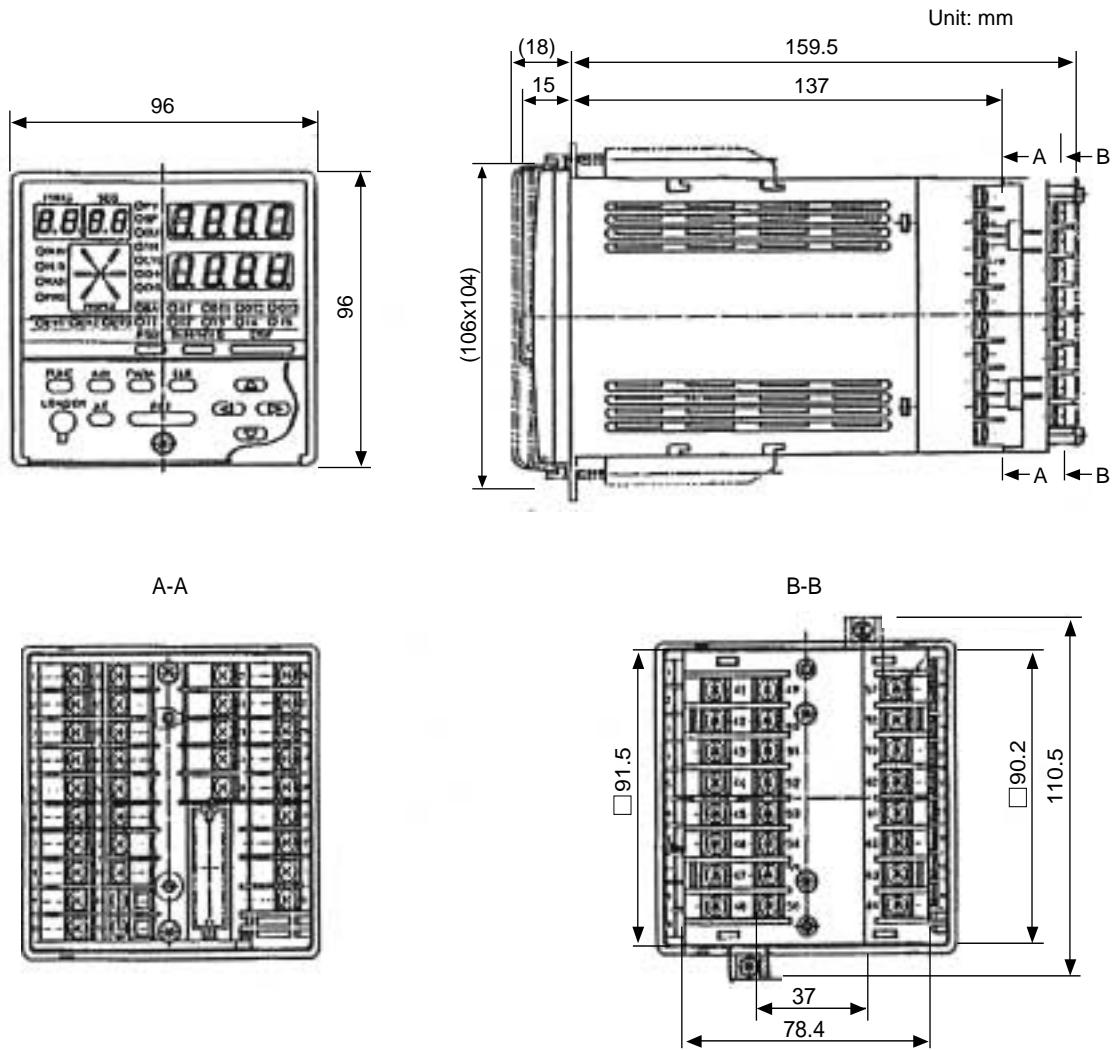

■ **Soft dust-proof cover set (sold separately)**

(transparent silicon rubber)  
 Model No.: 81446087-001

Unit: mm

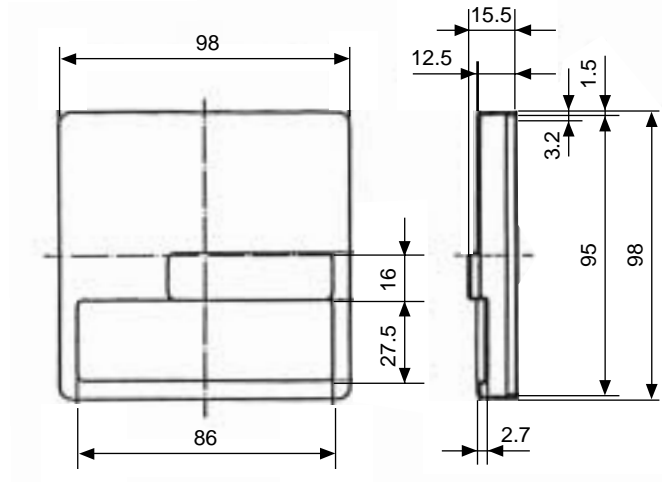

■ **Hard dust-proof cover set (sold separately)**

(transparent polycarbonate)  
 Model No.: 81446083-001

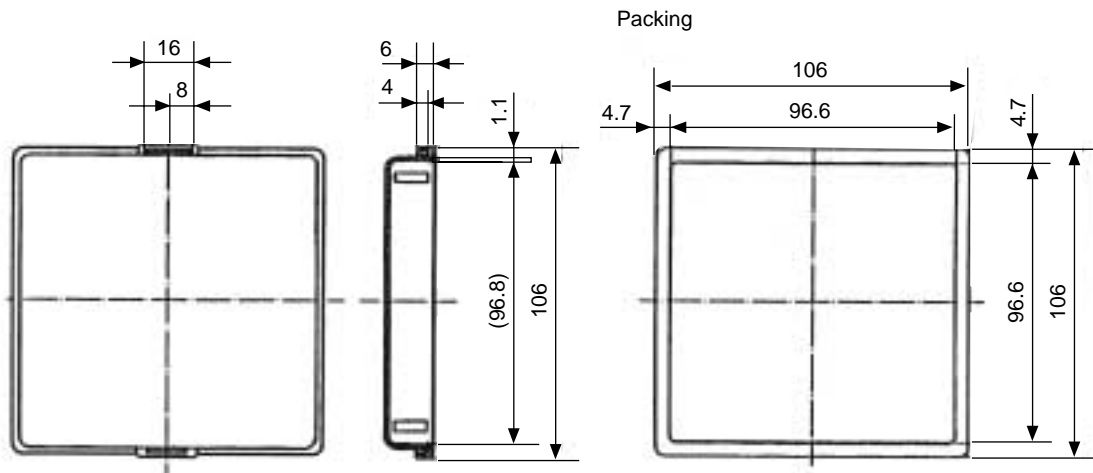

■ **Terminal cover set (sold separately)**

(gray non-flammable, heat-resistant PVC)  
 Model No.: 81446084-001

Can be attached to either of  
 standard or add-on terminal base.

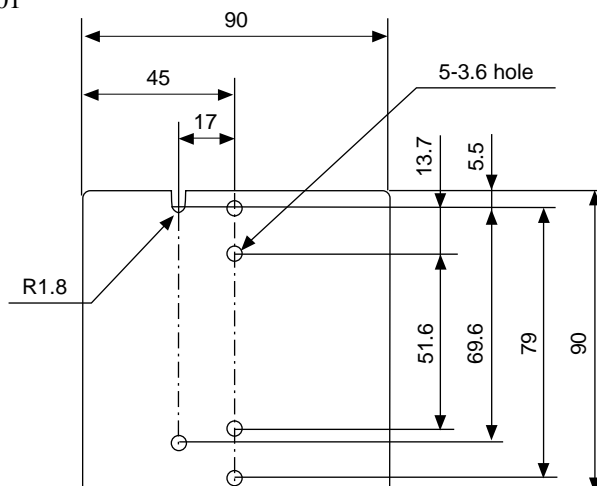

# Chapter 11. CALIBRATION

---

This chapter covers the field calibrations procedures for the inputs, outputs and various functions of the DCP301 and DCP302 controller after shipment from the factory. When calibration is made in the field, the original factory data is erased, and so the specified input/output accuracies of the controller cannot be assured. This manual is for users who are conversant with DCP301 and DCP302 use and operation.

## ■ Precautions before calibration

Apply power and allow the controller to warm up for 2 hours before you calibrate the DCP301 and DCP302. Confirm that the test equipment needed for calibration has stabilized.

Factory calibration has been made at a stable temperature of 23.0°C ( $\pm 2^\circ\text{C}$ ). Calibrate the DCP301 and DCP302 in this range, and where there are no significant fluctuations in air temperature.

If calibration equipment of a lower grade than specified below is used, calibration results may be unsatisfactory.

## ■ Equipment needed

- (1) Standard input source with  $\pm 0.02\%$  accuracy (having more than 5 effective digits and capable of generating both voltage and current outputs)
- (2) Decade resistance box with  $\pm 0.02\%$  accuracy (having a range of 10 to 500 $\Omega$  with a resolution of more than 0.01 $\Omega$ )
- (3) Digital ammeter with  $\pm 0.02\%$  accuracy (measurable in the range of 4 to 20mA with assured resolution of more than 0.01mA)
- (4) Thermometer with  $\pm 0.1^\circ\text{C}$  accuracy (resolution of more than 0.1 $^\circ\text{C}$ )

# 11-1 Quick Reference Table for Calibration Items

DCP301 and DCP302 controllers are numbered using the following format. Format items may require different calibration procedures, as shown in Table 11-1.

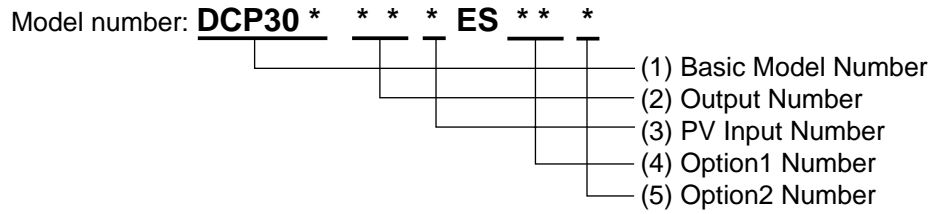

Table 11-1. Calibration Items for Each Model

Calibration & Test Item	Model	Basic Model: DCP301	Option2: 1, 2	Output and Option Model Number										
				Output:5G, 6D			Output:0D			Output:2G, 3D		Output:5K		
				Option1:00	Option1:01	Option1:02	Option1:00	Option1:01	Option1:02	Option1:00	Option1:01	Option1:00	Option1:01	
0 Function Test	Key Test	<input type="radio"/>												
	Indicator Test	<input type="radio"/>												
	DI Test(1 to 4)	<input type="radio"/>												
	DI Test(5 to 12)		<input type="radio"/>											
	DO Control Output Ch1 Test			<input type="radio"/>	<input type="radio"/>	<input type="radio"/>	<input type="radio"/>	<input type="radio"/>	<input type="radio"/>	<input type="radio"/>	<input type="radio"/>	<input type="radio"/>	<input type="radio"/>	<input type="radio"/>
	DO Control Output Ch2 Test													
	DO Control Output Ch3 Test													
	DO Test(1 to 3:Event)	<input type="radio"/>												
DO Test(4 to 8:Time Event)		<input type="radio"/>												
1 PV Input Calibration	Gain No.0 to 12	<input type="radio"/>												
	Gain No.16 to 20													
2 CJ Sensor Calibration		<input type="radio"/>												
4 Current Output Calibration	Output Ch1			<input type="radio"/>	<input type="radio"/>	<input type="radio"/>							<input type="radio"/>	<input type="radio"/>
	Output Ch2				<input type="radio"/>	<input type="radio"/>		<input type="radio"/>	<input type="radio"/>				<input type="radio"/>	<input type="radio"/>
	Output Ch3					<input type="radio"/>			<input type="radio"/>		<input type="radio"/>			<input type="radio"/>

Table 11-2. Item and Sub Item Table for Calibration

Item	Sub Item	Description	Upper Display Shows	Lower Display Shows
0	0	Item change code	<i>0.0.0.0.</i> etc.	<i>AdJS</i>
	1	Key test		
	2	Display test		
	3	Digital input test		
	4	Output test (control)		
	5	Output test (digital output)		
1	0	Item change code	<i>1.0.1.1.</i>	
	1	Gain No.		
	2	PV input 0%		
	3	PV input 100%		
2	0	Item change code	<i>2.0.2.2.</i>	<div style="border: 1px solid black; width: 20px; height: 20px; display: inline-block; vertical-align: middle;"></div> Previous adjustment value
	1	CJ input 0%		
	2	CJ count		
	3	CJ temperature		
4	0	Item change code	<i>4.0.4.4.</i>	<div style="border: 1px solid black; width: 20px; height: 20px; display: inline-block; vertical-align: middle;"></div> Previous adjustment value
	1	OUT ch1 4mA output		
	2	OUT ch1 20mA output		
	3	OUT ch2 4mA output		
	4	OUT ch2 20mA output		
	5	OUT ch3 4mA output		
	6	OUT ch3 20mA output		

- Notes:**
1. Items No. is shown on the PROG display.
  2. Sub item No. is shown on the SEG display.
  3. Item 0: Function check item
  4. Items 1, 2 and 6 : Calibration items

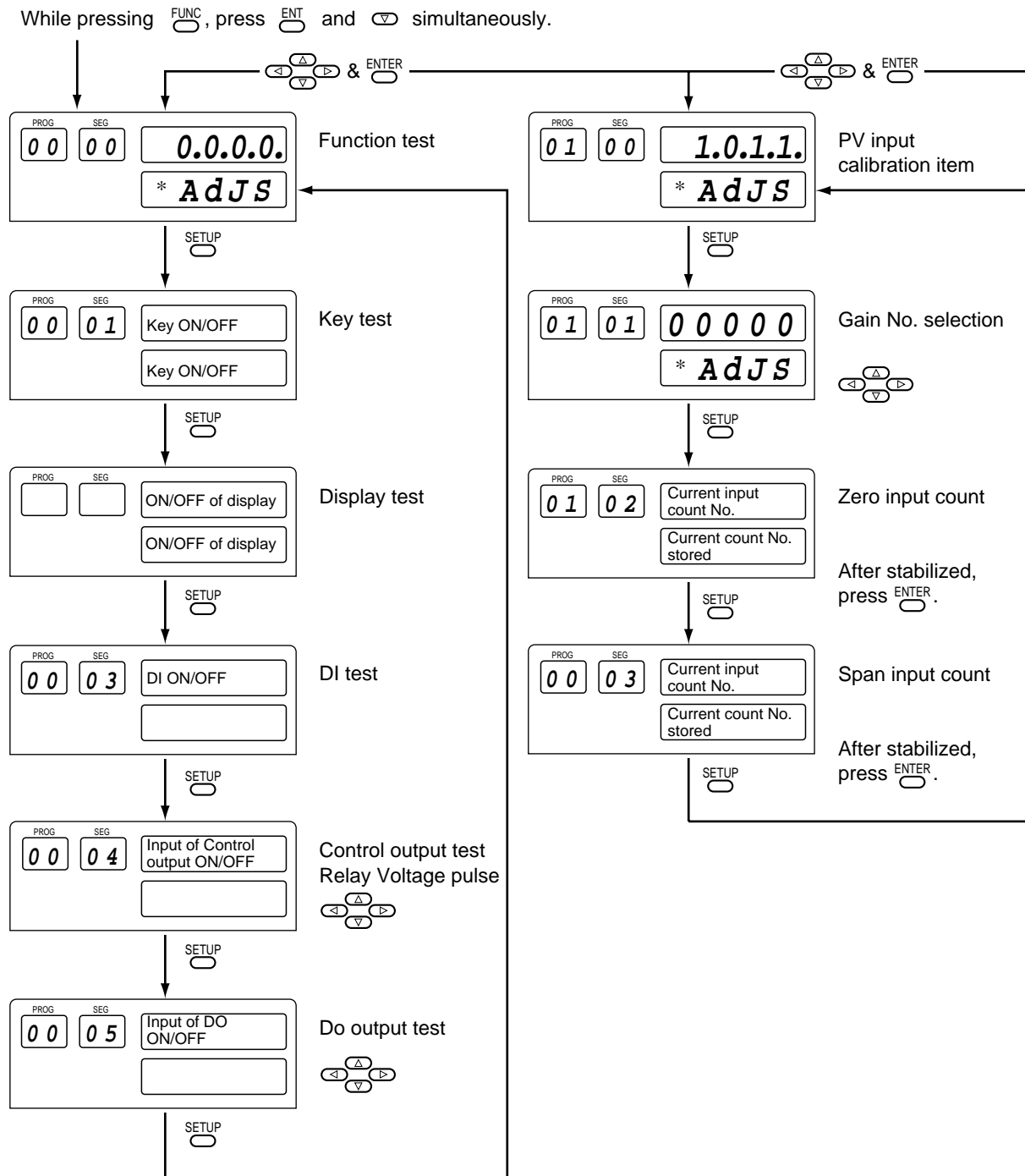

**Notes:** \*; 1. This display shows the digits shown in the previous indication.  
 2. If wrong key operation is made when moving from one to another item, the display is returned to the initial status of calibration mode. But, the mode is still in the calibration mode.

Figure 11-1. Calibration Flowchart (1/2)



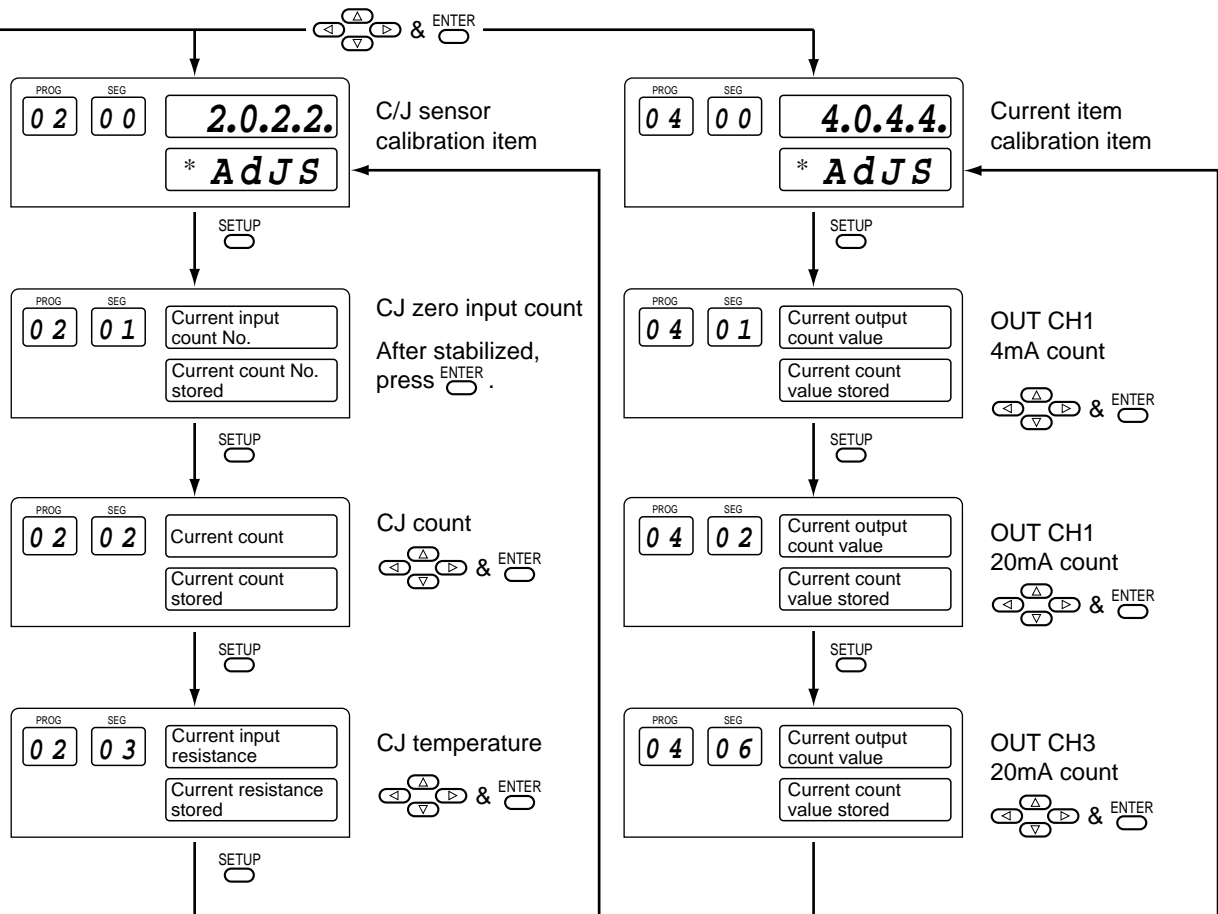

Figure 11-1. Calibration Flowchart (2/2)

## 11-2 Calibration Procedures

### ■ Enter calibration mode

- (1) Release keylock. (**PARA LoC=0** and **PrtC=0**)
- (2) Press **DISP key** to permit ordinary indication condition.  
Change to **READY (RUN and HLD are off)** and **AUTO (MAN off)** modes.  
The following LEDs will illuminate after the above operations.  
**RUN LED is OFF**  
**HLD LED is OFF**  
**MAN LED is OFF**

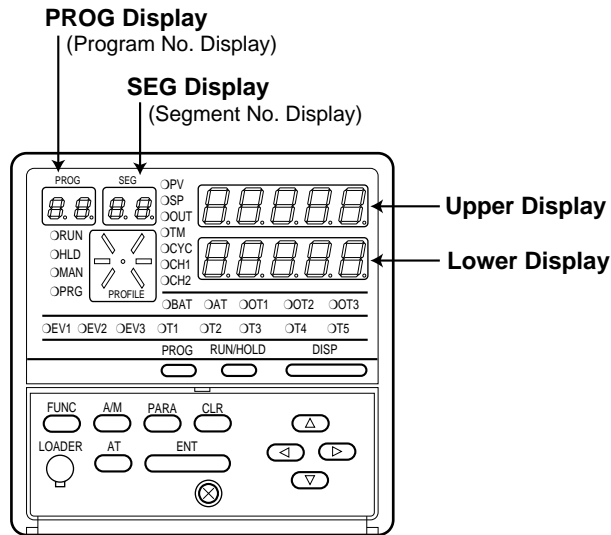

Figure 11-2.

- (3) To enter calibration mode, hold down the **FUNC key**, and press **ENT key** and **↓ key** simultaneously.  
The display will show the symbols described in Figure 11-3. If the indication is different, repeat the above procedure after pushing **DISP key** to refresh the display.
- (4) To select individual calibration items, press **↑, ↓, ←, or → keys** to select the item by scrolling, then **PARA key**, and **ENT key**.  
The order of calibration items is described in Table 11-2.

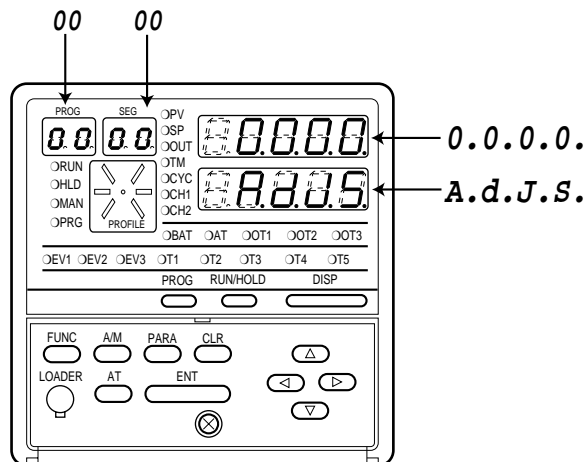

Figure 11-3.

## ■ Function test











Press  $\uparrow$ ,  $\downarrow$ ,  $\leftarrow$ , or  $\rightarrow$  **keys** to show (0.0.0.0) on upper display, then press **ENT key**.

### ● Key test (00-01)

Press **PARA key** until the PROG/SEG display shows (00-01).

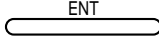
When you press each key, the data appears in the upper display (shown in Table 11-3).

Table 11-3. Upper Display

Key	Data	Key	Data
PROG 	0.0.4.0.	RUN/HOLD 	4.0.0.0.
FUNC 	0.0.2.0.	A/M 	0.0.0.1.
CLR 	0.0.0.4.	AT 	0.1.0.0.
	0.0.0.8.	ENT 	0.2.0.0.
	0.8.0.0.		0.0.1.0.
			1.0.0.0.

## ! HANDLING PRECAUTIONS

1. When you press **DISP key**, calibration mode will be exited.
2. When you press **PARA key**, the next calibration menu will be entered (Display test).

● **Display test (00-02)**

Press **PARA key** until the display test starts.  
 Then, each 7-segment LED, LED indicators and LCD illuminates at every 0.5 sec.  
 This is to check if each LED/LCD illuminates.

● **Digital input test (00-03)**

Press **PARA key** until the PROG/SEG display shows (00-03).  
 When you turn on or off each remote switch, the upper display will show the data described in Table 11-4.

**Table 11-4. DI**

Upper Display \ DI Terminal Number	(21)	(22)	(23)	(24)	(41)	(42)	(43)	(44)	(45)	(46)	(47)	(48)
	↓ (25)	↓ (25)	↓ (25)	↓ (25)	↓ (25)	↓ (25)	↓ (25)	↓ (25)	↓ (25)	↓ (25)	↓ (25)	↓ (25)
0.0.0.0.	—	—	—	—	—	—	—	—	—	—	—	—
0.0.0.1.	ON	—	—	—	—	—	—	—	—	—	—	—
0.0.0.2.	—	ON	—	—	—	—	—	—	—	—	—	—
0.0.0.4.	—	—	ON	—	—	—	—	—	—	—	—	—
0.0.0.8.	—	—	—	ON	—	—	—	—	—	—	—	—
0.0.1.0.	—	—	—	—	ON	—	—	—	—	—	—	—
0.0.2.0.	—	—	—	—	—	ON	—	—	—	—	—	—
0.0.4.0.	—	—	—	—	—	—	ON	—	—	—	—	—
0.0.8.0.	—	—	—	—	—	—	—	ON	—	—	—	—
0.1.0.0.	—	—	—	—	—	—	—	—	ON	—	—	—
0.2.0.0.	—	—	—	—	—	—	—	—	—	ON	—	—
0.4.0.0.	—	—	—	—	—	—	—	—	—	—	ON	—
0.8.0.0.	—	—	—	—	—	—	—	—	—	—	—	ON

**Notes:** 1. "ON" means to short the terminals by a jumper.  
 2. "—" means to open the terminals.

**Example:**

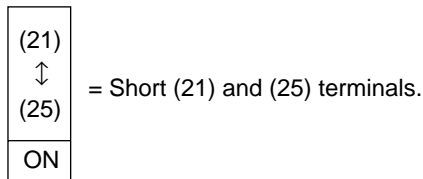

● **Digital output test for control output (00-04)**

Press **PARA key** until the PROG/SEG display shows (00-04).

When the digit of upper display is changed by ↑, ↓, ←, or → **keys**, the state of voltage pulse or relay control output is changed as shown in Table 11-5.

Since the 6D hardware is of voltage pulse output (0D and 2G hardware is of relay) specification, the ON/OFF check must be performed in meeting with the specification.

Table 11-5.

Upper Display	State
0.0.0.0.	All OFF
0.0.0.1.	6D, 0D, 2G output CH1 ON
0.0.0.2.	6D, 2G output CH2 ON
0.0.0.4.	6D output CH3 ON

● **Digital output test for event (00-05)**

Press **PARA key** until the PROG/SEG display shows (00-05).

Table 11-6. DO

Upper Display \ DO Terminal Number	(4)	(6)	(8)	(49)	(50)	(51)	(52)	(53)
	↓ (5)	↓ (7)	↓ (9)	↓ (55)	↓ (55)	↓ (55)	↓ (55)	↓ (55)
0.0.0.0.	—	—	—	—	—	—	—	—
0.0.0.1.	ON	—	—	—	—	—	—	—
0.0.0.2.	—	ON	—	—	—	—	—	—
0.0.0.4.	—	—	ON	—	—	—	—	—
0.0.0.8.	—	—	—	ON	—	—	—	—
0.0.1.0.	—	—	—	—	ON	—	—	—
0.0.2.0.	—	—	—	—	—	ON	—	—
0.0.4.0.	—	—	—	—	—	—	ON	—
0.0.8.0.	—	—	—	—	—	—	—	ON

**Notes:** 1. “—” in the table means “OFF”.

2. Since the DO hardware is of open collector specification, the ON/OFF check must be performed in meeting with the specification.

## ■ PV calibration

Scroll  $\uparrow$ ,  $\downarrow$ ,  $\leftarrow$ , or  $\rightarrow$  **keys** to show (1.0.1.1.) on upper display, then press **ENT key**.

### ● Gain No. select

Press **PARA key** until the PROG/SEG display shows (01-01). Connect calibration device (See Section “11-3 Set Up”).

Input the gain number (See Table 11-9 and Table 11-10) by scrolling  $\uparrow$ ,  $\downarrow$ ,  $\leftarrow$ , or  $\rightarrow$  **keys** the upper display ( **ENT key** not required).

### ● PV zero, span

#### (1) PV zero adjustment

- Press **PARA key** until the PROG/SEG display shows (01-02).
- Adjust your calibration device to an output signal equal to the 0% range value (See Table 11-9), the signal need to be on the input for 10 to 15 seconds.
- Press **ENT key** after display stabilizes.

#### (2) PV span adjustment

- Press **PARA key** until the PROG/SEG display shows (01-03).
- Adjust your calibration device to an output signal equal to the 100% range value (See Table 11-9 and table 11-10).
- Press **ENT key** after display stabilizes.

Table 11-9.

Gain No.	PV Input 0%	PV Input 100%	Connecting Position
0	-12.785mV	110.000mV	Between 34(+) and 33(-)
1	-8.565mV	58.303mV	Between 34(+) and 33(-)
2	-13.788mV	40.481mV	Between 34(+) and 33(-)
3	-12.000mV	23.300mV	Between 34(+) and 33(-)
4	-1.000mV	11.000mV	Between 34(+) and 33(-)
5	-0.100V	1.100V	Between 34(+) and 33(-)
6	-0.500V	5.500V	Between 34(+) and 33(-)
7	-1.000V	11.000V	Between 34(+) and 33(-)
8	0.000mA	22.000mA	Between 34(+) and 33(-)
9	10.000Ω	480.000Ω	Between 34 and 33
10	10.000Ω	178.000Ω	Between 34 and 33
11	0.000Ω	110.000Ω	Between 34 and 33
12	0.000Ω	45.000Ω	Between 34 and 33

Table 11-10.

Gain No.	PV Input 0%	PV Input 100%	Connecting Position
16	-8.000mV	20.000mV	Between 28(+) and 29(-)
17	-20.000mV	70.500mV	Between 28(+) and 29(-)
18	-1.000V	11.000V	Between 27(+) and 26(-)
19	10.000Ω	380.000Ω	Between 30 and 29
20	0.000Ω	110.000Ω	Between 30 and 29

Table 11-11.

Range Table of CH1 TC					Range Table of CH1 RTD				
Group	Type	Code	Range No.	Gain No.	Group	Type	Code	Range No.	Gain No.
T/C	K (CA)	K09	0	1	RTD	JIS '89 Pt100 (IEC Pt100Ω)	F50	32	9
	K (CA)	K08	1	2			F46	33	9
	K (CA)	K04	2	3			F32	34	9
	K (CA)	K29	3	1			F36	35	9
	K (CA)	K44	4	3			F38	36	10
	K (CA)	K46	5	3			F33	37	10
	E (CRC)	E08	6	0			F05	38	9
	J (IC)	J08	7	1			F03	39	9
	T (CC)	T44	8	3			F01	40	10
	B (PR30-6)	B18	9	3			JIS '89 JPt100	P50	48
	R (PR13)	R16	10	3		P46		49	9
	S (PR10)	S16	11	3		P32		50	9
	W (WRe5-26)	W23	12	2		P36		51	9
	W (WRe5-26)	W14	13	2		P38		52	10
	PR40-20	D19	14	4		P33		53	10
	Ni-Ni-Mo	Z13	15	0		P05		54	9
	N	U13	16	1		P03		55	9
	PL II	Y13	17	1		P01		56	10
	DIN U	Z08	18	2					
	DIN L	Z07	19	0					
Fe-Au-Cr	Z06	20	4						

Range Table of CH2 T/C				
Group	Type	Code	Range No.	Gain No.
T/C	K (CA)	K44	128	16
	K (CA)	K29	129	17

Range Table of CH2 RTD				
Group	Type	Code	Range No.	Gain No.
RTD	JIS '89 Pt100 (IEC Pt100Ω)	F36	160	19
		F01	161	19
	JIS '89 JPt100	P36	176	19
		P01	177	19

Range Table of CH2 Linear				
Group	Type	Code	Range No.	Gain No.
Linear mA	4 to 20mA	C01	64	8
	0 to 20mA	C08	65	8
Linear mV	0 to 10mV	M01	66	4
	-10 to +10mV	L02	67	3
Linear V	0 to +100mV	L01	68	0
	0 to 1V	L04	69	5
	-1 to 1V	L08	70	5
	1 to 5V	V01	71	6
	0 to 5V	L05	72	6
	0 to 10V	L07	73	7

Range Table of CH2 Linear				
Group	Type	Code	Range No.	Gain No.
Linear V	0 to 10V	L07	192	18
	0 to 5V	V01	193	18

---

## ■ Cold junction sensor calibration

Scroll ↑, ↓, ←, or → **keys** to show (2.0.2.2.) on upper display, then press **ENT key**.

### ● The cold junction input 0%

- (1) Press **SETUP key** until the PROG/SEG display shows (02-01).
- (2) Press **ENT key** after display stabilizes, AD count is shown on lower display.

### ● The cold junction AD count data

- (1) Press **SETUP key** until the PROG/SEG display shows (02-02).
- (2) Press **ENT key** after display stabilizes, AD count is shown on lower display.

### ● The cold junction temperature data

- (1) Press **SETUP key** until the PROG/SEG display shows (02-03).
- (2) Connect the thermometer (55).
- (3) Scroll ↑, ↓, ←, or → **keys** to set above temperature value(°C).
- (4) Press **ENT key**.

## ■ Current output calibration

Scroll ↑, ↓, ←, or → **keys** to show (4.0.4.4.) on the upper display, then press **ENT key**.

Connect the digital ammeter across terminals (See Figure 11-9).

### ● OUT CH1 output calibration

- (1) Press **PARA key** until the PROG/SEG display shows (04-01).  
Scroll ↑, ↓, ←, or → **keys** until meter indicates 4.00mA, then press **ENT key**.
- (2) Press **PARA key** until the PROG/SEG display shows (04-02).  
Scroll ↑, ↓, ←, or → **keys** until meter indicates 20.00mA, then press **ENT key**.

### ● OUT CH2 output calibration

- (1) Press **PARA key** until the PROG/SEG display shows (06-03).  
Scroll ↑, ↓, ←, or → **keys** until meter indicates 4.00mA, then press **ENT key**.
- (2) Press **PARA key** until the PROG/SEG display shows (06-04).  
Scroll ↑, ↓, ←, or → **keys** until meter indicates 20.00mA, then press **ENT key**.

### ● OUT CH1 output calibration

- (1) Press **PARA key** until the PROG/SEG display shows (04-05).  
Scroll ↑, ↓, ←, or → **keys** until meter indicates 4.00mA, then press **ENT key**.
- (2) Press **PARA key** until the PROG/SEG display shows (04-06).  
Scroll ↑, ↓, ←, or → **keys** until meter indicates 20.00mA, then press **ENT key**.



# 11-3 Set Up

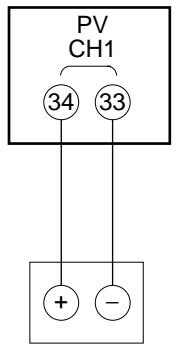

Gain No. 0 to 7

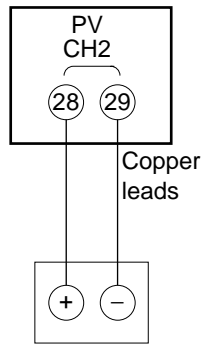

Gain No. 16 to 17

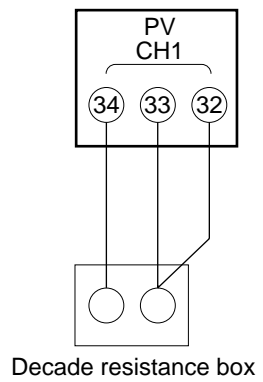

Gain No. 9 to 10

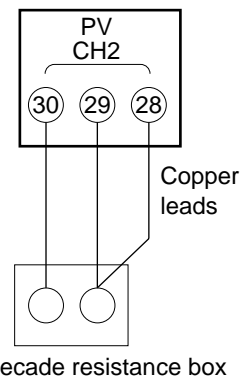

Gain No. 19

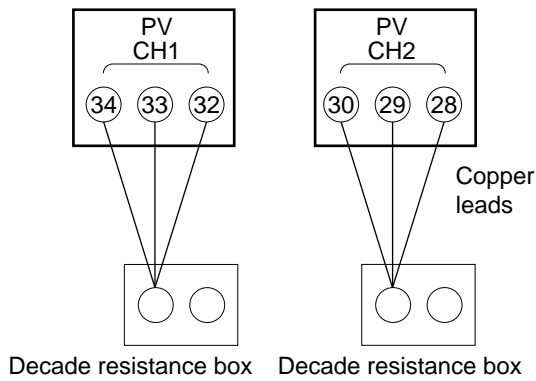

Gain No. 11 to 12(0%)

Gain No. 20(0%)

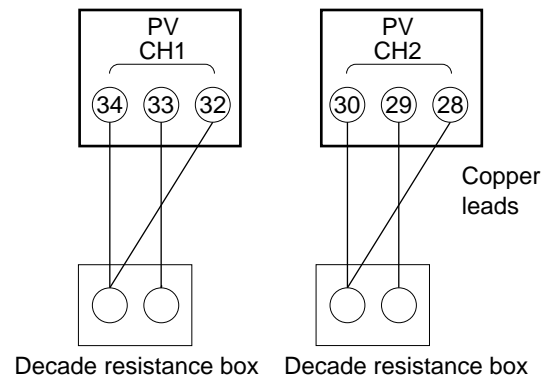

Gain No. 11 to 12(100%)

Gain No. 20(100%)

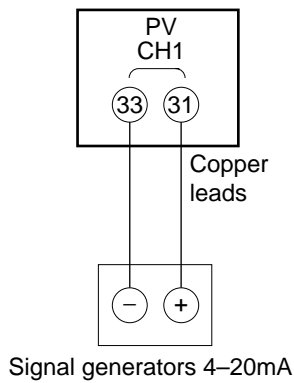

Gain No. 8

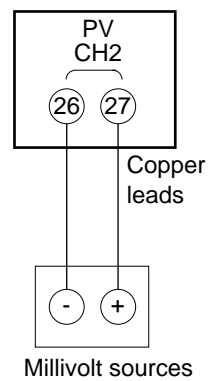

Gain No. 18

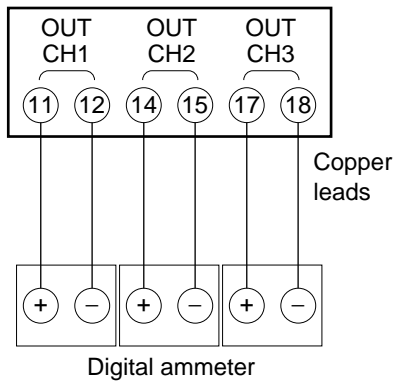

Figure 11-11. Current Outputs





To reduce risk of electric shock which could cause personal injury, all safety notices in this documentation.



This symbol warns the user of a potential shock hazard where hazardous live voltages may be accessible.

- If the equipment is used in a manner not specified by the manufacturer, the protection provided by the equipment must be impaired.
- Do not replace any component (or part) not explicitly specified as replaceable by your supplier.
- All wiring must be in accordance with local norms and carried out by authorized experienced personnel.
- The ground terminal must be connected before any other wiring (and disconnected last).
- A switch in the main supply is required near the equipment.
- Mains power supply wiring requires a (T) 1.0A, 250V fuse(s).(IEC127)

## **EQUIPMENT RATINGS**

Supply voltages	100 to 240Vac (operation power voltages 90 to 264Vac)
Frequency	50/60Hz
Power or current ratings	30VA maximum

## **EQUIPMENT CONDITIONS**

Do not operate the instrument in the presence of flammable liquids or vapors. Operation of any electrical instrument in such an environment constitutes a safety hazard.

Temperature	0 to 50°C
Humidity	10 to 90%RH
Vibration	Frequency 10 to 60Hz Acceleration 1.96m/s <sup>2</sup> maximum
Installation category	Category II (IEC664-1, EN61010-1)
Pollution degree	2

## **EQUIPMENT INSTALLATION**

The controller must be mounted into a panel to limit operator access to the rear terminal. Specification of common mode voltage; The common mode voltages of all I/O except for main supply and relay outputs are less than 30Vrms, 42.4V peak and 60Vdc.

## **APPLICABLE STANDARDS**

EN61010-1, EN50081-2, EN50082-2, EN61326

### **CAUTION**

Danger of explosion if battery is incorrectly replaced.

Replace only with the same or equivalent type recommended by the manufacturer.  
Dispose of used batteries according to the manufacturer's instructions.

# Index

---

2 degrees of freedom PID selection..... 7-12  
3-position control deviation lower limit..... 7-15  
3-position control deviation upper limit..... 7-15  
3-position control lower limit hysteresis ..... 7-15  
3-position control upper limit hysteresis ..... 7-15  
3-wire system RS-485 mutual connection..... 4-18  
5-wire system RS-485 mutual connection..... 4-17

## -A-

Accessories..... 10-7  
Add-on terminal base..... 2-1  
Add-on terminal layout ..... 4-7  
ADV (advance)..... 5-14  
Alarm code ..... 9-2  
AUTO (automatic) ..... 5-12, 5-14  
Auto-tuning (AT) ..... 6-11  
Auxiliary output 1 lower limit..... 7-33  
Auxiliary output 1 upper limit..... 7-33  
Auxiliary output 2 lower limit..... 7-33  
Auxiliary output 2 upper limit..... 7-33  
Auxiliary outputs (outputs 2, 3)..... 4-11

## -B-

Basic display state..... 2-2  
Basic display selection ..... 6-2  
Basic function block diagram ..... 1-2  
Basic indicator LED lamps ..... 2-2, 2-3  
BAT (Low voltage battery LED)..... 2-2, 2-3  
Battery Life ..... 9-13  
Battery replacing ..... 9-10  
Body..... 2-1

## -C-

Cable..... 4-3  
Case ..... 2-1  
Cold junction compensation ..... 7-34  
Communications connection..... 4-16  
Console..... 2-1, 2-2, 2-4  
Constant-value operation..... 5-11, 5-13  
Constant-value operation data setting..... 7-42  
Constant-value operation display..... 6-5, 6-6  
Control outputs (outputs 1, 2) connection ..... 4-9  
    Current output (5G)  
    Heat/cool output (3D)  
    Heat/cool output (5K)

    Position-proportional output (2G)  
    Relay output (0D)  
    Voltage output (6D)  
Control/output state LED..... 2-2, 2-3  
Controller function..... 5-16  
Controller status events..... 5-5  
CPL communications..... 1-4  
CPL communications port selection ..... 7-39  
CR filter..... 3-4  
Crimped terminal ..... 4-4  
Cycle ..... 5-9, 8-11

## -D-

Data structure..... 1-3  
Data types ..... 5-1  
DC current input..... 2-9, 4-8  
DC voltage input..... 2-9, 4-8  
Displays..... 2-2  
Dust-proof covers..... 3-4

## -E-

END..... 5-12  
Event 1 ON delay time ..... 7-22  
Event 1 standby..... 7-22  
Event 2 ON delay time ..... 7-22  
Event 2 stand by..... 7-22  
Event 3 ON delay time ..... 7-22  
Event 3 standby..... 7-22  
Event configuration data settings ..... 7-18  
Event LEDs ..... 2-2, 2-3  
Event output (relay output) connection ..... 4-12  
Events 1 to 3 ..... 5-3, 8-6  
External dimensions ..... 3-1, 10-8  
External switch inputs connection ..... 4-15  
External switch operation..... 6-8

## -F-

FAST (fast forward) ..... 5-12, 5-14  
Feedback resistor..... 4-9  
Functions using two or more keys ..... 2-7

## -G-

G.Soak (guarantee soak) ..... 5-8, 8-10  
G.Soak time-out ..... 8-10  
General reset ..... 8-15

Ground..... 4-6

**-H-**

Hard dust-proof cover set ..... 3-1, 10-7, 10-9  
Heat/cool control dead zone ..... 7-13  
HOLD..... 5-12, 5-14  
How to use PARA key ..... 7-4

**-I-**

Input 1 connection ..... 4-8  
Input 1 square root extraction dropout ..... 7-33  
Input 1 Zener barrier adjustment ..... 7-38  
Input processing functions ..... 5-17  
Input Type and Range No. .... 2-8  
Inputs and outputs isolation..... 4-19

**-K-**

Key cover ..... 2-1  
Key lock ..... 7-10  
Keys ..... 2-4

**-L-**

Loader jack..... 2-4, 2-7  
Lock screw ..... 2-1  
Lower display ..... 2-2, 2-3

**-M-**

MANUAL ..... 5-12, 5-14  
MANUAL operation ..... 6-11  
Mode indicator LED lamps ..... 2-2, 2-3  
Mode transition ..... 5-13  
Mode types ..... 5-11  
Model selection guide ..... 1-5  
Motor adjustment is impossible ..... 9-8  
Motor control method selection ..... 7-16  
Motor valve opening adjustment fully  
open/close time ..... 7-17  
Motor valve opening automatic adjustment ..... 7-17  
Mounting bracket ..... 3-1, 3-5, 10-7  
Mounting locations ..... 3-3  
Mounting method ..... 3-5  
MV change limit..... 7-11

**-N-**

Noise..... 3-4

**-O-**

ON-OFF control differential ..... 7-13  
Optional parts ..... 10-7  
Output processing functions ..... 5-18  
    Auxiliary output  
    Control output  
    SP output

**-P-**

Panel cutout dimensions ..... 3-2  
Parameters set up ..... 7-1  
Pattern link ..... 5-10, 8-12  
Patterns ..... 5-2, 8-5  
PID operation initial MV ..... 7-11  
PID operation initialization ..... 7-11  
PID set automatic switching ..... 5-8  
PID set No. .... 8-9  
PID set selection ..... 5-8  
Position-proportional control dead zone ..... 7-13  
Power ON operation..... 6-1  
Power supply connection ..... 4-6  
Profile display ..... 2-2, 2-3  
Program end..... 5-14  
Program No. display..... 2-2  
Program operation..... 5-11, 5-13  
Program operation display ..... 6-3, 6-4, 6-5  
Program patterns..... 1-3, 5-2  
Program patterns selection ..... 6-7  
Program protect..... 7-10  
Programmer function..... 5-16  
Program copy..... 8-14  
Program deletion..... 8-12  
Program set up..... 8-1  
PV display ..... 7-34  
PV start..... 5-9, 8-11  
PV type events..... 5-3

**-R-**

Range No. .... 2-8  
READY ..... 5-11  
RESET ..... 5-14  
Resistance temperature detector (RTD)..... 2-8, 4-7  
RS-485 connection..... 4-16

---

**-S-**

Segment No. display .....	2-2
Segment deletion .....	8-13
Segment insertion.....	8-13
Self-diagnostics.....	9-1
Setup data setting .....	7-27
Smart-tuning method selection.....	7-12
Soft dust-proof cover set.....	3-1, 10-7, 10-9
SP1 lower limit .....	7-33
SP1 upper limit .....	7-33
Special functions.....	7-37
Specifications.....	10-1
Standard terminal base .....	2-1
Standard terminal layout.....	4-7
System configuration.....	1-4

**-T-**

Table data settings .....	7-40
Terminal cover set .....	3-1, 10-7, 10-9
Terminals connection.....	4-4
Thermocouple inputs.....	2-8, 4-8
Time display .....	6-4, 7-34
Time event output (open-collector) connection..	4-13
Time event outputs .....	1-2
Time events 1 to 5 selection.....	5-6
Time events .....	5-5, 5-6
Trouble during key entry .....	9-3

**-U-**

Upper display .....	2-2, 2-3
---------------------	----------

**-V-**

Variable parameter settings .....	7-7
Varister .....	3-4
Voltage output 1 adjustment .....	7-35
Voltage output 2 adjustment .....	7-35
Voltage time-proportional output system.....	7-34

**-W-**

Wiring .....	4-1
Wiring for reverse motor rotation.....	9-8

# Revision History

Printed Date	Manual Number	Edition	Revised pages	Description
99-04	EN11-6197	1st Edition		
00-06		2nd Edition	iv SERVICE CENTERS	Instruction Manual.was changed to User's Manual Address of JAPAN was changed
00-08		3rd Edition	7-32 11-10	No. 84 and No. 85 Items was changed PV Input 100% of Gain No. 1 and Gain No. 8 was changed
01-06		4th Edition	7-32	No. 94 Unused → PID type changed
03-06		5th Edition	8-4 8-10 10-6, SAFETY REQUIREMENTS Programming Map Draft Form	G.Soak time-out added ■ Setting up G.Soak time-out items added Applicable standards added, EN61326  G.Soak time-out added
03-08		6th Edition	4-3 4-17, 4-18  8-5, 8-7, 8-8 8-7, 8-8 8-10  Index-1 to 3	Fujikura Cable Co. → Fujikura Ltd. Handling Precautions added, to connect SG terminals each others. Setting range: 0.0 to 599.9 (0.1s) added. ON time setting + 0.1 to 599.9 (0.1s) added. Setting range changed “0 to 1000U” to “0.00 to 99.59 (h:min/min:s) or 0.0 to 599.9 (0.1s)” in G. Soak time-out items. Allover revised.
04-02		7th Edition	4-2 10-6 10-6, 1 to 11	The 8th item of Handling Precautions added. Item of Altitude added. Description change based on the European standards revision.



# HONEYWELL SERVICE CENTERS

## **NETHERLANDS**

HONEYWELL BV  
Laaderhoogtweg 18  
NL-1101 EA AMSTERDAM ZO  
THE NETHERLANDS  
Tel.:31 20 56 56 911

## **POLAND**

HONEYWELL Ltd  
Ul Augustowka 3  
PL-02981 WARSAW  
POLAND  
Tel.:48 2 642 25 70

## **REPUBLIC OF IRELAND**

HONEYWELL  
Unit 5  
Long Mile Road  
DUBLIN 12  
Republic of Ireland  
Tel.:353 1 565944

## **RUSSIA**

HONEYWELL INC  
Tryokhprundny Pereulok 11.13  
SU 10 3001 MOSCOW  
Tel.:7095 29 92 531

## **SOUTH AFRICA**

HONEYWELL LTD  
34 Harry Street  
Robertsham  
JOHANNESBURG 2001  
REPUBLIC OF SOUTH AFRICA  
Tel.:27 11 680 3440

## **SWEDEN**

HONEYWELL A.B.  
Storsatragrand 5  
S-127 86 STOCKHOLM  
SWEDEN  
Tel.:46 8 775 55 00

## **UNITED KINGDOM**

HONEYWELL HOUSE  
Charles Square  
BRACKNELL, BERKS. RG12 1EB  
UNITED KINGDOM  
Tel.:44 344 424 555

## **VENEZUELA**

HONEYWELL CA  
APARTADO 61314  
1060 CARACAS  
VENEZUELA  
Tel.:58 2 239 7533

## **NORWAY**

HONEYWELL A/S  
Askerveien 61  
PO Box 263  
N-1371 ASKER  
NORWAY  
Tel.:47 66 90 20 30

## **PORTUGAL**

HONEYWELL PORTUGAL LDA  
Edificio Suecia II  
Av.do Forte nr 3-Piso 3  
CARNAXIDE  
2795 LINDA A VELHA  
PORTUGAL  
Tel.:351 4172 602

## **REP.OF SINGAPORE**

HONEYWELL PTE LTD.  
BLOCK 750E CHAI CHEE ROAD  
06-01 CHAI CHEE IND.PARK  
1646 SINGAPORE  
REP OF SINGAPORE  
Tel.:65 449 7609

## **SLOVAK REPUBLIC**

HONEYWELL  
Trnavska 3  
831 04 BRATISLAVA  
SLOVAKIA  
Tel.:42 7 601 23

## **SPAIN**

HONEYWELL  
Josefa Valcarcel, 24  
PO Box 29106  
28080 MADRID  
SPAIN  
Tel.:34 1 32 02 112

## **SWITZERLAND**

HONEYWELL A.G.  
Hertistrasse 2  
8304 WALLISELLEN  
SWITZERLAND  
Tel.:41 1 839 2525

## **U.S.A**

HONEYWELL INC  
INDUSTRIAL CONTROLS DIV.  
1100 VIRGINIA DRIVE  
PA 19034-3260 FT.WASHINGTON  
U.S.A  
Tel.:215 641 3000

# HONEYWELL SERVICE CENTERS

## ARGENTINA

HONEYWELL S.A.I.C.  
BELGRANO 1156  
BUENOS AIRES  
ARGENTINA  
Tel.:54 1 383 9290

## AUSTRALIA

HONEYWELL LIMITED  
5 Thomas Holt Drive  
North Ryde Sydney  
NSW AUSTRALIA 2113  
Tel.:61 2 353 7000

## BELGIUM

HONEYWELL S.A.  
Avenue de Schipol, 3  
1140 BRUSSELS  
BELGIUM  
Tel.:32 2 728 27 11

## CANADA

HONEYWELL LIMITED  
THE HONEYWELL CENTRE  
155 GORDON BAKER RD  
M2H 3N7 NORTH YORK, ONTARIO  
CANADA  
Tel.:416 499 6111

## DENMARK

HONEYWELL A/S  
Lyngby Hovedgade 98  
2800 LYNGBY  
DENMARK  
Tel.:45 45 93 56 56

## FRANCE

HONEYWELL S.A.  
4, Avenue Ampere  
MONTIGNY LE BRETONNEUX  
F-78886 ST QUENTIN EN YVELINES  
FRANCE  
Tel.:(1) 30 58 80 00

## HUNGARY

HONEYWELL Kft  
Volgy U 30  
H-1026 BUDAPEST  
HUNGARY  
Tel.:36 1 116 76 59

## JAPAN

HONEYWELL KK  
14-6, Shibaura 1-chome,  
Minato-ku, Tokyo 150-0023  
Japan  
Tel.:81-3-5440-1395

## ASIA PACIFIC

HONEYWELL ASIA PACIFIC Inc.  
Room 3213-3225  
Sun Kung Kai Centre  
No 30 Harbour Road  
WANCHAI  
HONG KONG  
Tel.:852 829 82 98

## AUSTRIA

HONEYWELL AUSTRIA G.m.b.H.  
Handelskai 388  
A1020 VIENNA  
AUSTRIA  
Tel.:43 1 213 300

## BRAZIL

HONEYWELL DO BRAZIL AND CIA  
Rua Jose Alves Da Chunha  
Lima 172  
BUTANTA  
05360 SAO PAULO SP  
BRAZIL  
Tel.:55 11 819 3755

## CZECHIA

HONEYWELL PRAGUE  
Krocínovska 3  
CS16000 PRAGUE 6  
CZECHIA  
Tel.:422 243 10 754

## FINLAND

HONEYWELL OY  
Ruukintie 8  
SF-02320 ESPOO  
FINLAND  
Tel.:358 0 80101

## GERMANY

HONEYWELL AG  
Kaiserleistrasse 39  
Postfach 10 08 65  
D-63067 OFFENBACH/MAIN  
GERMANY  
Tel.:49 69 80 640

## ITALY

HONEYWELL S.p.A.  
Via Vittor Pisani, 13  
20124 MILANO  
ITALY  
Tel.:39 2 67 731

## MEXICO

HONEYWELL S.A.DE CV  
AV. CONSTITUYENTES 900  
COL. LOMAS ALTAS  
11950 MEXICO CITY  
MEXICO  
Tel.:52 5 259 1966



## Free Manuals Download Website

<http://myh66.com>

<http://usermanuals.us>

<http://www.somanuals.com>

<http://www.4manuals.cc>

<http://www.manual-lib.com>

<http://www.404manual.com>

<http://www.luxmanual.com>

<http://aubethermostatmanual.com>

Golf course search by state

<http://golfingnear.com>

Email search by domain

<http://emailbydomain.com>

Auto manuals search

<http://auto.somanuals.com>

TV manuals search

<http://tv.somanuals.com>