

HealthyWhite

700 series

Rechargeable
sonic toothbrush



PHILIPS
sonicare
the **sonic** toothbrush

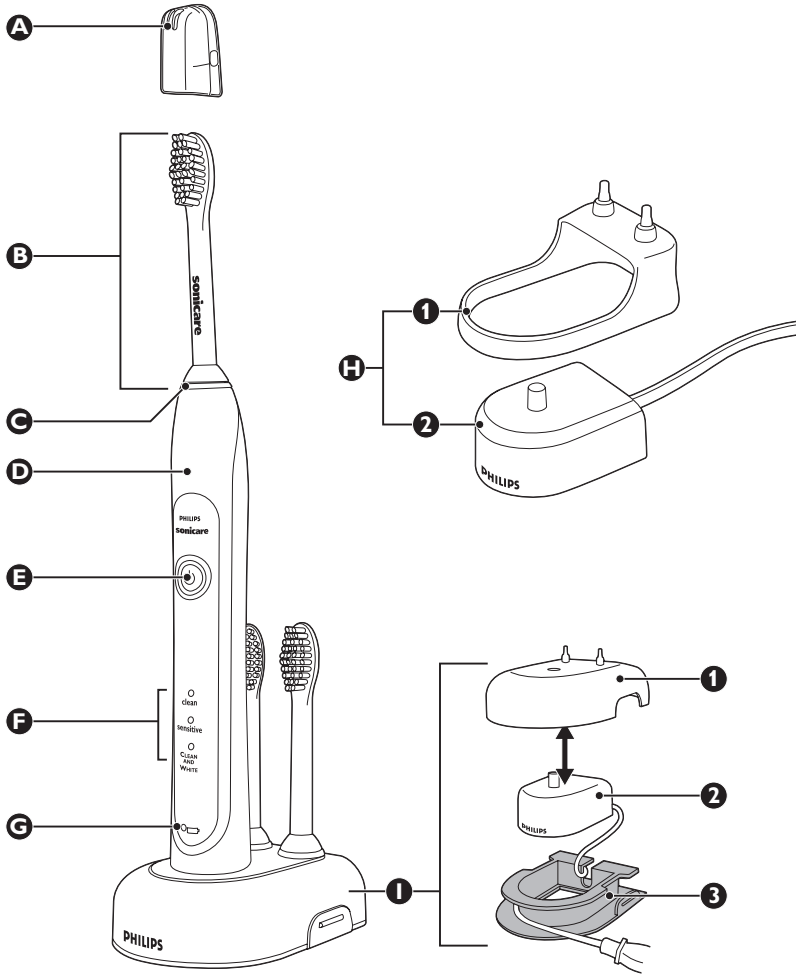

Sonicare 700 series

ENGLISH 4

IMPORTANT SAFEGUARDS

READ ALL INSTRUCTIONS BEFORE USE

Read this user manual carefully before you use the appliance and save it for future reference.

DANGERS

To reduce the risk of electrocution:

- 1 DO NOT place or store the product where it can fall or be pulled into a tub or sink.
- 2 Do not place the product in or drop it into water or any other liquid.
- 3 DO NOT reach for a product that has fallen into water. Unplug immediately.
- 4 Do not use the product while bathing.

WARNINGS

To reduce the risk of burns, electrocution, fire to persons:

- 1 DO NOT plug the product into an outlet with a voltage other than specified on the bottom of the charger. This product is designed to operate within a range of 100 to 240 volts. Voltage converters DO NOT guarantee voltage compatibility.
- 2 Never force the plug into an outlet; if it does not easily fit into the outlet, discontinue use.
- 3 Discontinue use if this product appears damaged in any way (brush head, handle, charger). This product contains no serviceable parts. Refer to chapter 'Guarantee and service' if your Sonicare no longer works properly or needs repair.
- 4 Never use the charger if it has a damaged cord or plug.
- 5 Keep the cord away from heated surfaces.
- 6 Do not use the charger outdoors.
- 7 Do not use the charger if dropped into water.
- 8 Avoid using a brush head with crushed or bent bristles. Damaged bristles may break off while brushing. Replace the brush head with a new one every 3 months or sooner if signs of wear appear. Inappropriate cleaning may cause bristle damage. (See chapter 'Cleaning').
- 9 This product is designed to clean your teeth, gums and tongue only. Use this product only for its intended use as described in this booklet. Discontinue use of this product and contact a physician/dentist if discomfort or pain is experienced.
- 10 This appliance is not intended for use by persons (including children) with reduced physical, sensory or mental capabilities, or lack of experience and knowledge, unless they have been given supervision or instruction concerning use of the appliance by a person responsible for their safety.
- 11 Children should be supervised to ensure that they do not play with the appliance.

- 12 Sonicare is a personal care device and is not intended for use on multiple patients in a dental office or institution.
- 13 Do not use attachments other than those recommended by the manufacturer.
- 14 If your toothpaste includes peroxide, baking soda or other bicarbonate (common in whitening toothpastes), thoroughly clean your brush head and handle with soap and water after each use. Otherwise plastic cracking may occur.
- 15 To avoid damage to the product, do not place the brush head, handle, charger or charger covers in the dishwasher for cleaning.

MEDICAL WARNINGS

- 1 Consult your dental professional before you use this product if you have had oral or gum surgery in the previous 2 months.
- 2 Contact your dental professional if excessive bleeding occurs after using this product or bleeding continues to occur after 1 week of use.
- 3 If you have a pacemaker or other implanted device contact your physician or the device manufacturer prior to use.
- 4 Sonicare has been tested and is compliant with safety standards for electromagnetic devices.
- 5 Consult your physician prior to using the Sonicare if you have medical concerns.

SAVE THESE INSTRUCTIONS

Your Sonicare (Fig. 1)

- A** Hygienic travel cap
- B** Brush head
- C** Interchangeable color code ring
- D** Handle with soft grip
- E** Power on/off button
- F** Brushing modes
- G** Charge light indicator
 - Deluxe charge indicator (select models)
 - Standard charge indicator (select models)
- H** Standard charger (select models)
 - H1 Charger cover with brush head holder
 - H2 Travel charger
- I** Deluxe charger (select models)
 - I1 Charger cover with brush head holder
 - I2 Travel charger
 - I3 Charger base with cord wrap

Getting started

Changing the color code ring

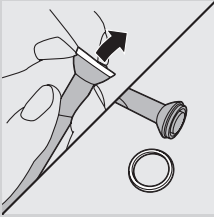

Sonicare brush heads come with interchangeable color code rings to identify your brush head.
To change the color code ring:

1 Pull the color code ring from the bottom of the brush head.

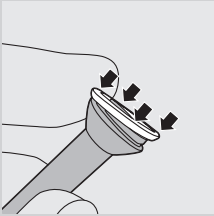

2 Install a new ring by slipping one edge of the new ring over the bottom of the brush head. Then press down on the other side to snap the ring into place.

Attaching the brush head

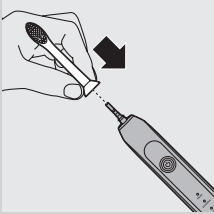

1 Align the brush head so the bristles face the front of the handle.

2 Firmly press the brush head down onto the metal shaft until it stops.

Note: There is a small gap between the color code ring and the handle.

Charging your Sonicare

1 Plug the charger into a live outlet.

2 Place the handle on the charger.

► The battery charge indicator next to the battery symbol flashes to indicate that the toothbrush is charging.

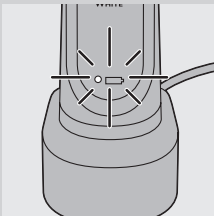

Battery charge indicator

The battery charge indicator shows the approximate remaining battery charge.

Deluxe charge indicator (select models):

- Solid green: 50-100%
- Flashing green: 10-49%

- Flashing yellow: less than 10%
- Standard charge indicator (select models):
- Solid green: 50-100%
 - Flashing green: less than 50%

Note: When the battery of your Sonicare is low, you hear 3 beeps after the completion of the brushing cycle and the battery charge indicator flashes for 30 seconds.

Note: To keep the battery fully charged, you may keep your Sonicare on the charger when not in use. It takes 24 hours to fully charge the battery.

Using your Sonicare

Brushing instructions

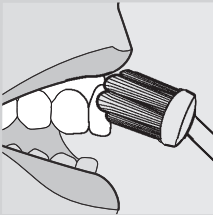

- 1 Wet the bristles and apply a small amount of toothpaste.
- 2 Place the toothbrush bristles against the teeth at a slight angle towards the gumline.
- 3 Press the power on/off button to turn on the Sonicare.
- 4 Apply light pressure to maximize Sonicare's effectiveness and let the Sonicare toothbrush do the brushing for you.
- 5 Gently move the brush head slowly across the teeth in a small back and forth motion so the longer bristles reach between your teeth. Continue this motion throughout your brushing cycle.

Note: To make sure you brush evenly throughout the mouth, divide your mouth into 4 sections using the Quadpacer® feature (see chapter 'Features').

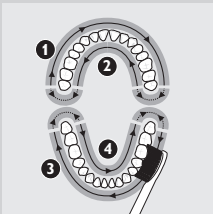

- 6 Begin brushing in section 1 (outside top teeth) and brush for 30 seconds before moving to section 2 (inside top teeth). Continue brushing in section 3 (outside bottom teeth) and brush for 30 seconds before moving to section 4 (inside bottom teeth).

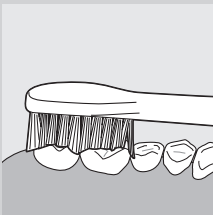

- 7 After you have completed the brushing cycle, you can spend additional time brushing the chewing surfaces of your teeth and areas where staining occurs. You may also brush your tongue, with the toothbrush turned on or off, as you prefer.

Your Sonicare is safe to use on:

- Braces (brush heads wear out sooner when used on braces)
- Dental restorations (fillings, crowns, veneers)

Note: The toothbrush may be turned off at any time by pressing and holding the power on/off button for 2 seconds.

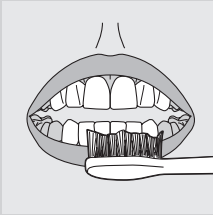

Clean and White mode brushing instructions

The Clean and White mode combines 2 minutes of Clean mode for a whole mouth clean, with an additional 30 seconds of White mode to focus on the visible front teeth.

- 1** Brush the first 2 minutes as instructed in steps 1-6 above.
- 2** After the 2 minutes of Clean mode, the White mode begins with a change in brushing sound and motion. That is your signal to start brushing the upper front teeth for 15 seconds
- 3** At the next beep and pause, move to the bottom front teeth for the final 15 seconds of brushing.

Brushing modes

Sonicare automatically starts in the default Clean mode. To select a different brushing mode:

- 1** Press the on/off button to toggle between modes.
 - ▶ The green LED indicates the selected mode.

Note: You can only switch between modes when the toothbrush is turned on.

Clean mode

Standard mode for superior teeth cleaning.

Sensitive mode (select models)

Gentle, yet thorough cleaning for sensitive gums and teeth.

Clean and White mode

2 minutes of Clean mode, with an additional 30 seconds of White mode to focus on your visible front teeth.

Note: When Sonicare is used in clinical studies, the default 2-minute Clean mode must be selected. However, in whitening/stain reduction studies, the Clean and White mode must be selected. The handle should be fully charged and the Easy-start feature deactivated.

Features

Easy-start®

- This Sonicare model comes with the Easy-start® feature activated.
- The Easy-start feature gently increases power over the first 14 brushings to ease into the Sonicare experience.

Note: Each of the first 14 brushings must be at least 1 minute in length to move through the Easy-start ramp-up cycle properly.

Note: When the Clean and White mode is selected, the Easy-start feature is inactive.

Deactivating or activating the Easy-start feature

1 Attach your brush head to the handle.

2 Place the handle in the plugged-in charger.

- To deactivate Easy-start:

Press and hold the power on/off button for 2 seconds. You hear 1 beep to indicate that the Easy-start feature has been deactivated.

- To activate Easy-start:

Press and hold the power on/off button for 5 seconds. You hear 2 beeps to indicate that the Easy-start feature has been activated.

Note: Using the Easy-start feature beyond the initial ramp-up period is not recommended and reduces Sonicare's effectiveness in removing plaque.

Smartimer®

The Smartimer® indicates that your brushing cycle is complete by automatically turning off the toothbrush at the end of the brushing cycle. Dental professionals recommend brushing no less than 2 minutes twice a day.

If you want to pause or stop brushing during your 2-minute cycle, press and hold the power on/off button for 2 seconds. Press the power on/off button again and the Smartimer picks up where you left off.

The Smartimer automatically resets to the beginning of a 2-minute cycle if:

- brushing is paused for 30 seconds or longer.
- the handle is returned to the charger.

Quadpacer® (select models)

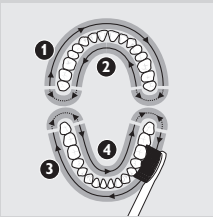

- The Quadpacer® is an interval timer that has a short beep and pause to remind you to brush the 4 sections of your mouth evenly and thoroughly.
- When you use the two-minute Clean or Sensitive mode, you hear a short beep and a pause in brushing action at 30, 60 and 90 second intervals.

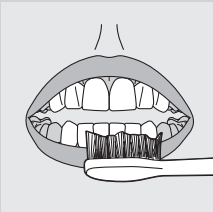

- When you use the Clean and White mode, you hear and feel a change in the brush head sound and motion after 2 minutes of Clean mode. Then move the brush head to the visible top front teeth and brush them for 15 seconds. At the final beep and pause, move to the visible bottom teeth and brush them for 15 seconds.

Cord wrap on deluxe charger (select models)

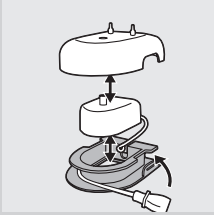

If your model includes the deluxe charger cover and base, the travel charger is pre-installed inside the cover. If you want to shorten the power cord, you can store excess cord in the cord wrap feature built into the charger base.

1 To separate the charger cover from the charger base, press the two gray snap bars on the charger base and pull the white charger cover upwards.

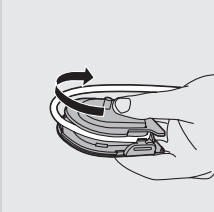

2 Wrap excess power cord around the gray charger base as shown in the picture. Be sure to wrap the cord on the inside of the two snap levers.

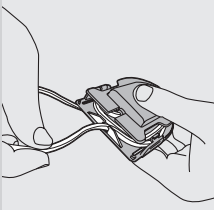

3 When you have stored the excess cord, guide the power cord through the small groove in the rear of the gray charger base.

4 Reattach the charger cover by pressing it down over the charger base until it snaps into place.

Tip: For extra convenience during travel, you can remove the travel charger and use it without the charger cover and charger base.

Cleaning

Do not clean brush heads, handle, charger or charger covers in the dishwasher.

Toothbrush handle

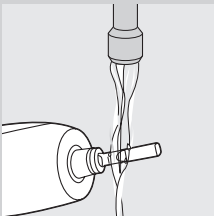

1 Remove the brush head and rinse the metal shaft area with warm water.

Do not push on the rubber seal on the metal shaft with sharp objects, as this may cause damage.

2 Use a damp cloth to wipe the entire surface of the handle.

Brush head

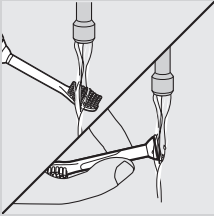

- 1 Rinse the brush head and bristles after each use.
- 2 Remove the brush head from the handle and rinse the brush head connection at least once a week with warm water.

Charger

- 1 Unplug the charger before cleaning.
- 2 Use a damp cloth to wipe the surface of the charger.

Storage

- If you are not going to use the product for an extended period of time, unplug it from the electrical outlet, clean it and store it in a cool and dry place away from direct sunlight. You can use the cord wrap (select models) to store the power cord in an organized manner.
- You can store brush heads on the pegs at the back of the charger.

Replacement

Brush head

- Replace Sonicare brush heads every 3 months to achieve optimal results.
- Use only Sonicare ProResults replacement brush heads.

Disposal



- At the end of product life and prior to disposal, please remove the rechargeable battery from the handle by following the instructions below.
- Do not throw away the appliance with the normal household waste at the end of its life, but hand it in at an official collection point for recycling. By doing this, you help to preserve the environment.
- The built-in rechargeable battery contains substances that may pollute the environment. Always remove the battery before you discard the appliance, and recycle or dispose of the battery according to local waste management requirements.
- If you have any recycling questions, contact your local waste management office.

Removing the rechargeable battery

Please note that this process is not reversible.

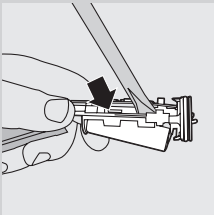
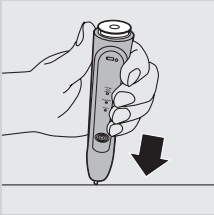
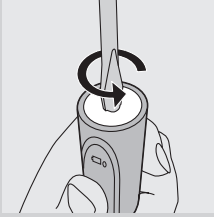

- To remove the rechargeable battery, you need a flat-head (standard) screwdriver. Observe basic safety precautions when you follow the procedure outlined below. Be sure to protect your eyes, hands, fingers, and the surface on which you work.

- 1** To deplete the rechargeable battery of any charge, remove the handle from the charger, turn on the Sonicare and let it run until it stops. Repeat this step until you can no longer switch on the Sonicare.
- 2** Insert a screwdriver into the slot located at the bottom of the handle and turn counterclockwise to release the bottom cap.
- 3** Hold the handle upside down and push down on the shaft to release the internal components of the handle.

- 4** Insert the screwdriver under the circuit board, next to the battery connections, and twist to break the connections. Remove the circuit board and pry the battery from the plastic carrier.

The rechargeable battery can now be recycled or disposed of and the rest of the product discarded appropriately.

Guarantee and service

Philips guarantees its products for two years after the date of purchase. Defects due to faulty materials and workmanship will be repaired or replaced at Philips expense provided that convincing proof of purchase in the qualifying period is provided.

Contact our Customer Service Center at 1-800-682-7664 (North America), outside North America contact your local Philips Customer Care Center.

WARRANTY EXCLUSIONS

What is not covered under warranty:

- Brush heads
- Damage caused by misuse, abuse, neglect, alterations or unauthorized repair.
- Normal wear and tear, including chips, scratches, abrasions, discoloration or fading.

IMPLIED WARRANTIES

ANY IMPLIED WARRANTIES, INCLUDING IMPLIED WARRANTIES OF MERCHANTABILITY AND FITNESS FOR A PARTICULAR PURPOSE, SHALL BE LIMITED TO THE DURATION OF THE EXPRESS WARRANTIES SET FORTH ABOVE. IN SOME STATES LIMITATIONS ON DURATION OF IMPLIED WARRANTIES DO NOT APPLY.

LIMITATION OF REMEDIES

IN NO EVENT SHALL PHILIPS OR ANY OF ITS AFFILIATED OR SUBSIDIARY COMPANIES BE LIABLE FOR ANY SPECIAL, INCIDENTAL OR CONSEQUENTIAL DAMAGES BASED UPON BREACH OF WARRANTY, BREACH OF CONTRACT, NEGLIGENCE, TORT, OR ANY OTHER LEGAL THEORY. SUCH DAMAGES INCLUDE, WITHOUT LIMITATION, LOSS OF SAVINGS OR REVENUE; LOSS OF PROFIT; LOSS OF USE; THE CLAIMS OF THIRD PARTIES INCLUDING, WITHOUT LIMITATION, DENTISTS AND DENTAL HYGIENISTS; AND COST OF ANY SUBSTITUTE EQUIPMENT OR SERVICES. SOME STATES DO NOT ALLOW THE EXCLUSION OR LIMITATION OF INCIDENTAL OR CONSEQUENTIAL DAMAGES.

Frequently asked questions

This chapter lists the questions most frequently asked about the appliance. If you cannot find the answer to your question, contact the Customer Care Center in your country.

Question	Answer
Why doesn't the Sonicare work?	You may need to recharge the Sonicare. Charge the Sonicare for at least 24 hours. Make sure that your Sonicare charger is plugged into a live electrical outlet and not into an outlet controlled by a light switch. You may need to reattach or replace the brush head.
Why do I feel a tickling sensation when I use the Sonicare?	You may experience a slight tickling/tingling sensation when you use the Sonicare for the first time. As you become accustomed to brushing with Sonicare, this sensation diminishes.
The brush head chatters against my teeth. What can I do about this?	To avoid this, keep the brush head properly oriented, with the bristles placed on the gumline at a slight angle.

Question	Answer
Why does the Sonicare seem less powerful?	You may need to charge the Sonicare. The Easy-start feature may be on. Deactivate the Easy-start feature (See chapter 'Features'). You may need to replace your brush head.
Why does the Sonicare seem to change power during brushing?	You may be in the Clean and White brushing mode. If this is the case, the toothbrush starts in the Clean mode for 2 minutes and then changes to the White mode for 30 seconds. The Clean and White mode has a different sound and brush movement.
Do I need a special charger if I travel with my Sonicare?	Travel tip: the Sonicare charger can be used with common worldwide voltages between 100-240V AC, at either 50 or 60Hz. A simple plug adapter is all that is required.

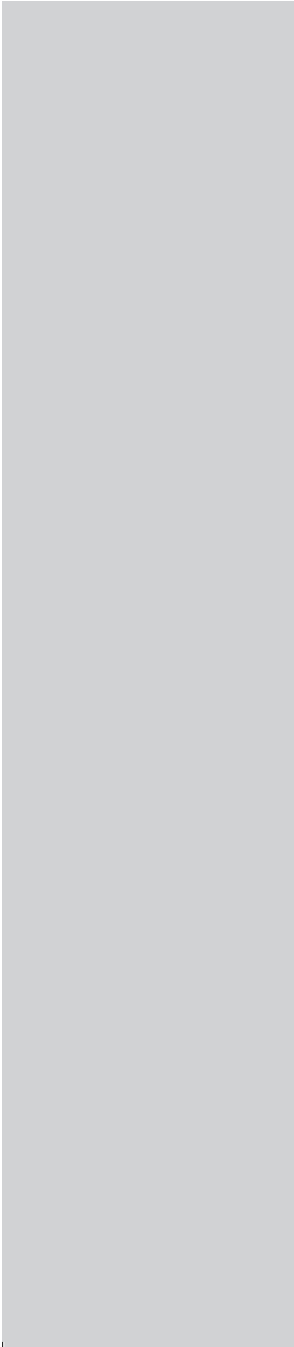



www.philips.com/support

For support call 1-800-682-7664

© 2008 Koninklijke Philips Electronics NV (KPEENV). All rights reserved. PHILIPS and the Philips shield are registered trademarks of KPEENV. Smartimer, Easy-start, Quadpacer, Sonicare and the Sonicare logo are trademarks of Philips Oral Healthcare, Inc. and/or KPEENV.

Printed in the U.S.A.



Printed on 100% recycled paper

Protected by U.S. and international patents.
Other patents pending.

4235.020.2526.3

Free Manuals Download Website

<http://myh66.com>

<http://usermanuals.us>

<http://www.somanuals.com>

<http://www.4manuals.cc>

<http://www.manual-lib.com>

<http://www.404manual.com>

<http://www.luxmanual.com>

<http://aubethermostatmanual.com>

Golf course search by state

<http://golfingnear.com>

Email search by domain

<http://emailbydomain.com>

Auto manuals search

<http://auto.somanuals.com>

TV manuals search

<http://tv.somanuals.com>