



To find out useful hints, tips and information about Sony products and services please visit: www.sony-europe.com/myproduct

AVCHD™

HDMI



<http://www.sony.net/>



Printed on 70% or more recycled paper using VOC (Volatile Organic Compound)-free vegetable oil based ink.

3-452-775-11(1)



1-3452775113

Printed in Malaysia

© 2008 Sony Corporation

Download from www.Somanuals.com. All Manuals Search And Download.

Operating Instructions

Blu-ray Disc / DVD Player

BDP-S350

WARNING

To reduce the risk of fire or electric shock, do not expose this apparatus to rain or moisture.

To avoid electrical shock, do not open the cabinet. Refer servicing to qualified personnel only.

Batteries or batteries installed apparatus shall not be exposed to excessive heat such as sunshine, fire or the like.

CAUTION

The use of optical instruments with this product will increase eye hazard. As the laser beam used in this Blu-ray Disc/DVD player is harmful to eyes, do not attempt to disassemble the cabinet. Refer servicing to qualified personnel only.

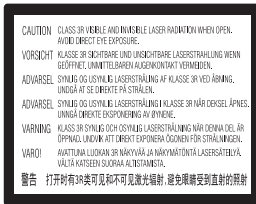



This label is located on the laser protective housing inside the enclosure.



This appliance is classified as a CLASS 1 LASER product. The CLASS 1 LASER PRODUCT MARKING is located on the laser protective housing inside the enclosure.

Notice for customers in the United Kingdom and Republic of Ireland

A molded plug complying with BS1363 is fitted to this equipment for your safety and convenience. Should the fuse in the plug supplied need to be replaced, a 5 AMP fuse approved by ASTA or BSI to BS1362, (i.e., marked with  or  mark) must be used. If the plug supplied with this equipment has a detachable fuse cover, be sure to attach the fuse cover after you change the fuse. Never use the plug without the fuse cover. If you should lose the fuse cover, please contact your nearest Sony service station.



Disposal of Old Electrical & Electronic Equipment (Applicable in the European Union and other European countries with separate collection systems)

This symbol on the product or on its packaging indicates that this product shall not be treated as household waste. Instead it shall be handed over to the applicable collection point for the recycling of electrical and electronic equipment. By ensuring this product is disposed of correctly, you will help prevent potential negative consequences for the environment and human health, which could otherwise be caused by inappropriate waste handling of this product. The recycling of materials will help to conserve natural resources. For more detailed information about recycling of this product, please contact your local Civic Office, your household waste disposal service or the shop where you purchased the product.



Disposal of waste batteries (applicable in the European Union and other European countries with separate collection systems)

This symbol on the battery or on the packaging indicates that the battery provided with this product shall not be treated as household waste.

By ensuring these batteries are disposed of correctly, you will help prevent potentially negative consequences for the environment and human health which could otherwise be caused by inappropriate waste handling of the battery. The recycling of the materials will help to conserve natural resources.

In case of products that for safety, performance or data integrity reasons require a permanent connection with an incorporated battery, this battery should be replaced by qualified service staff only.

To ensure that the battery will be treated properly, hand over the product at end-of-life to the applicable collection point for the recycling of electrical and electronic equipment.

For all other batteries, please view the section on how to remove the battery from the product safely. Hand the battery over to the applicable collection point for the recycling of waste batteries.

For more detailed information about recycling of this product or battery, please contact your local Civic Office, your household waste disposal service or the shop where you purchased the product.

The manufacturer of this product is Sony Corporation, 1-7-1 Konan Minato-ku Tokyo, 108-0075 Japan. The Authorized Representative for EMC and product safety is Sony Deutschland GmbH, Hedelfinger Strasse 61, 70327 Stuttgart, Germany. For any service or guarantee matters please refer to the addresses given in separate service or guarantee documents.

Precautions

- This unit operates on 220 V – 240 V AC, 50 Hz/60 Hz. Check that the unit's operating voltage is identical with your local power supply.
- To prevent fire or shock hazard, do not place objects filled with liquids, such as vases, on the apparatus.
- Install this unit so that the mains lead can be unplugged from the wall socket immediately in the event of trouble.

Notes About the Discs

- To keep the disc clean, handle the disc by its edge. Do not touch the surface. Dust, fingerprints, or scratches on the disc may cause it to malfunction.

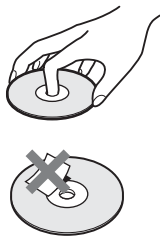

- Do not expose the disc to direct sunlight or heat sources such as hot air ducts, or leave it in a car parked in direct sunlight as the temperature may rise considerably inside the car.
- After playing, store the disc in its case.

- Clean the disc with a cleaning cloth. Wipe the disc from the centre out.



- Do not use solvents such as benzene, thinner, commercially available disc/lens cleaners, or anti-static spray intended for vinyl LPs.
- If you have printed the disc's label, dry the label before playing.
- Do not use the following discs.
 - A disc that has a non-standard shape (e.g., card, heart).
 - A disc with a label or sticker on it.
 - A disc that has cellophane tape or sticker adhesive on it.
- Do not resurface the playing side of a disc to remove surface scratches.

Precautions

On safety

- To prevent fire or shock hazard, do not place objects filled with liquids, such as vases, on the player, or place the player near water, such as near a bathtub or shower room. Should any solid object or liquid fall into the cabinet, unplug the player and have it checked by qualified personnel before operating it any further.
- Do not touch the AC power cord (mains lead) with wet hands. Doing so may cause an electric shock.

On placement

- Place the player in a location with adequate ventilation to prevent heat build-up in the player.
- Do not place the player on a soft surface such as a rug that might block the ventilation holes.
- Do not install this player in a confined space, such as a bookshelf or similar unit.
- Do not place the player in a location near heat sources, or in a place subject to direct sunlight, excessive dust, or mechanical shock.
- If the player is brought directly from a cold to a warm location, or is placed in a very damp room, moisture may condense on the lenses inside the player. Should this occur, the player may not operate properly. In this case, remove the disc and leave the player turned on for about half an hour until the moisture evaporates.
- Do not install the player in an inclined position. It is designed to be operated in a horizontal position only.
- Keep the player and the discs away from equipment with strong magnets, such as microwave ovens, or large loudspeakers.

- Do not place heavy or unstable objects on the player.
- Do not place any objects other than discs on the disc tray. Doing so may cause damage to the player or the object.
- When you move the player, take out any discs. If you don't, the disc may be damaged.
- When you move the player, disconnect the AC power cord (mains lead) and all other cables from the player.

On power sources

- The player is not disconnected from the AC power source (mains) as long as it is connected to the wall outlet, even if the player itself has been turned off.
- If you are not going to use the player for a long time, be sure to disconnect the player from the wall outlet. To disconnect the AC power cord (mains lead), grasp the plug itself; never pull the cord.
- Observe following points to prevent the AC power cord (mains lead) being damaged. If the AC power cord (mains lead) is damaged, it may result in a fire or an electric shock.
 - Do not pinch the AC power cord (mains lead) between the player and wall, shelf, etc.
 - Do not put anything heavy on the AC power cord (mains lead) or pull on the AC power cord (mains lead) itself.

On adjusting volume

Do not turn up the volume while listening to a section with very low level inputs or no audio signals. If you do, the speakers may be damaged when a peak level section is played.

On cleaning

Clean the cabinet, panel, and controls with a soft cloth slightly moistened with a mild detergent solution. Do not use any type of abrasive pad, scouring powder or solvent such as alcohol or benzene.

On cleaning discs, disc/lens cleaners

Do not use cleaning discs or disc/lens cleaners (including wet or spray types). These may cause the apparatus to malfunction.

On replacement of parts

In the events that this player is repaired, repaired parts may be collected for reuse or recycling purposes.

Copyrights and Trademarks

- This product incorporates copyright protection technology that is protected by U.S. patents and other intellectual property rights. Use of this copyright protection technology must be authorized by Macrovision, and is intended for home and other limited viewing uses only unless otherwise authorized by Macrovision. Reverse engineering or disassembly is prohibited.
- "AVCHD" and the "AVCHD" logo are trademarks of Matsushita Electric Industrial Co., Ltd. and Sony Corporation.
- Java and all Java-based trademarks and logos are trademarks or registered trademarks of Sun Microsystems, Inc.
- , "XMB," and "cross media bar" are trademarks of Sony Corporation and Sony Computer Entertainment Inc.

- This Blu-ray Disc/DVD player incorporates High-Definition Multimedia Interface (HDMI™) technology. HDMI, the HDMI logo and High-Definition Multimedia Interface are trademarks or registered trademarks of HDMI Licensing LLC.
- "Blu-ray Disc" is a trademark.
- "Blu-ray Disc," "DVD+RW," "DVD-RW," "DVD+R," "DVD-R," "DVD VIDEO," and "CD" logos are trademarks.
- "BonusView" is a trademark of Blu-ray Disc Association.
- "x.v.Colour" and "x.v.Colour" logo are trademarks of Sony Corporation.
- "BRAVIA Sync" is a trademark of Sony Corporation.
- "PhotoTV HD" and the "PhotoTV HD" logo are trademarks of Sony Corporation.
- Other system and product names are generally trademarks or registered trademarks of the manufacturers. ™ and ® marks are not indicated in this document.

IMPORTANT NOTICE

Caution: This player is capable of holding a still video image or on-screen display image on your television screen indefinitely. If you leave the still video image or on-screen display image displayed on your TV for an extended period of time you risk permanent damage to your television screen. Plasma display panel televisions and projection televisions are susceptible to this.

If you have any questions or problems concerning your player, please consult your nearest Sony dealer.

About this manual



- In this manual, “disc” is used as a general reference for the BDs, DVDs, or CDs unless otherwise specified by the text or illustrations.
- Icons, such as , listed at the top of each explanation indicate what kind of media can be used with the function being explained.
For details, see “Playable Discs” (page 59).
- Instructions in this manual describe the controls on the remote. You can also use the controls on the player if they have the similar symbols as those on the remote.
- The on-screen display illustrations used in this manual may not match the graphics displayed on your TV screen.
- NEED-to-know information (to prevent incorrect operation) is listed under the  icon. NICE-to-know information (tips and other useful information) is listed under the  icon.

Table of Contents

WARNING	2
Precautions	3
Guide to Parts and Controls	8

Hookups and Settings

Hooking Up the Player	13
Step 1: Connecting to Your TV	14
Connecting to an HDMI jack	15
About the BRAVIA Sync features (for HDMI connections only)	16
Connecting to component video jacks (Y, Pb/Cb, Pr/Cr)	17
Connecting to an audio/video or S VIDEO jack	18
Step 2: Connecting to Your AV Amplifier (Receiver)	19
Connecting to an HDMI jack	20
Connecting to digital jacks (OPTICAL/COAXIAL)	21
Connecting to audio L/R jacks	22
Step 3: Inserting the External Memory	23
Step 4: Connecting to the Network	24
When connecting to a broadband router directly	24
When connecting via a wireless LAN router	25
Step 5: Connecting the Mains Lead	25
Step 6: Preparing the Remote	26
Controlling TVs with the remote	26
Step 7: Easy Setup	27

Playback

Playing BDs/DVDs	30
Using the BD's or DVD's menu	32
Enjoying BonusView	32
Searching for a scene quickly (Scene Search)	33
Searching for a Title/Chapter	33
Displaying the playing time and play information	34
Adjusting pictures and sound for videos	34
Playing CDs	36
Playing Photo Files	37

Settings and Adjustments

Using the Settings Displays	39
Network Update	40
Video Settings	41
Audio Settings	44
BD/DVD Viewing Settings	47
Photo Settings	49
System Settings	50
Network Settings	51
Easy Setup	53
Resetting	53

Additional Information

Troubleshooting	54
Self-Diagnosis Function	58
Playable Discs	59
Video Output Resolution	62
Audio Output Signals	63
Specifications	64
Language Code List	65
Parental Control/Area Code	65
Terms and Conditions of Use and End User License Agreement	66
Glossary	68
Index	70

Before operating the player, please read “Terms and Conditions of Use and End User License Agreement” (page 66).

Guide to Parts and Controls

For more information, see the pages in parentheses.

Remote

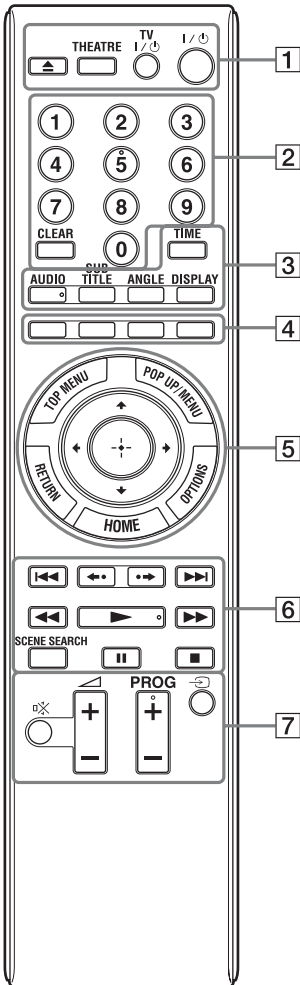

Number 5, AUDIO, PROG +, and ► buttons have a tactile dot. Use the tactile dot as a reference when operating the player.

1 ▲ (open/close) (page 30)

Opens or closes the disc tray.

THEATRE (page 16)

Switches to the optimum video mode for watching movies automatically. When connected with an AV amplifier (receiver) using the HDMI cable, the speaker output also switches automatically. Press the button again to return to the original setting.

When connected with a Theatre Mode-compatible TV using the HDMI cable, the TV's video mode switches to Theatre Mode.



The THEATRE button functions only when connected to a Theatre Mode-compatible TV.

TV I/⏻ (on/standby) (page 26)

Turns on the TV, or sets to standby mode.

I/⏻ (on/standby) (page 27)

Turns on the player, or sets to standby mode.

2 Number buttons (page 33, 52)

Enters the title/chapter numbers, etc.

CLEAR

Clears the entry field.

3 TIME (page 11)

Displays the elapsed/remaining playback time in the front panel display. Each time you press the button, the display switches between elapsed playback time and remaining playback time.

AUDIO (page 47)

Selects the language track when multi-lingual tracks are recorded on BD-ROMs/DVD VIDEOS.

Selects the sound track on CDs.

SUBTITLE (page 47)

Selects the subtitle language when multi-lingual subtitles are recorded on BD-ROMs/DVD VIDEOS.

ANGLE

Switches to other viewing angles when multi-angles are recorded on BD-ROMs/DVD VIDEOS.

DISPLAY (page 34)

Displays the playback information on the screen.

4 Colour buttons (red/green/yellow/blue)

Short cut keys for selecting items on some BD's menus (can also be used for BD's Java interactive operations).

5 TOP MENU (page 32)

Opens or closes the BD's or DVD's Top Menu.

POP UP/MENU (page 32)

Opens or closes the BD-ROM's Pop-up Menu, or the DVD's menu.

OPTIONS (page 32, 37)

The options menu that can be selected appears on the screen.

HOME (page 39)

Enters the player's home menu.
Exits the home menu when a CD is inserted.

RETURN

Returns to the previous display.



Moves the highlight to select a displayed item.

Centre button (ENTER)

Enters the selected item.

6 ◀◀/▶▶ (previous/next)

Skips to the previous/next chapter, track, or file.

To go to the beginning of the previous track, press ◀◀ twice.

◀•/•▶ (instant replay/instant advance)

Replays the scene/briefly fast forwards the scene.



(fast reverse/fast forward)

Fast reverses/fast forwards the disc when pressed during playback.

Each time you press the button, search speed changes as follows*:

Playback direction

▶▶1 (x10) → ▶▶2 (x30) → ▶▶3 (x120)

Reverse direction

◀◀1 (x1) → ◀◀1 (x10) → ◀◀2 (x30) → ◀◀3 (x120)

When you press and hold the button, fast forward/fast reverse continues at the selected speed until you release the button.

* Search speed does not change when playing CDs.

Speed multiple values are approximate.

– To resume normal playback, press ▶.

▶ (play) (page 30)

Starts or re-starts playback.

Resumes playback from the point where you press ■ (Resume Play).

Plays a slideshow when a disc containing JPEG image files is inserted.

SCENE SEARCH (page 33)

Switches to Scene Search mode that lets you move quickly between scenes within the title currently being played back.

|| (pause)

Pauses or re-starts playback.

■ (stop)

Stops playback and remembers the stop point (resume point) (page 31, 36).

The resume point for a title/track is the last point you played or the last photo for a photo folder.

7 For TVs operable with the following buttons, see page 26.

⊗ (muting)

Mutes the TV sound.

◁ (volume) +/-

Adjusts the TV volume.

PROG (programme) +/-

Selects the TV channels up and down.

⊞ (input select)

Switches between TV and other input sources.

Front panel

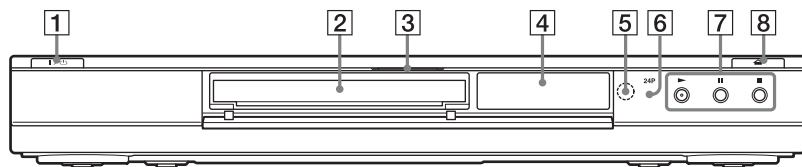

1 I/O (on/standby) (page 27)

Turns on the player, or sets to standby mode.

2 Disc tray (page 30)

3 Blu-ray Disc indicator

Lights up when a BD is recognised.



When the player is turned on for the first time, the Blu-ray Disc indicator lights up, then turns off when Easy Setup is complete.

4 Front panel display (page 11)

5 Remote sensor (page 26)

6 24P indicator (page 43)

Lights up when outputting 1080p/24 Hz video signals of BD-ROMs.

7 ► (play), || (pause), ■ (stop) (page 30)

Starts, pauses, or stops playback.

8 ≡ (open/close) (page 30)

Opens or closes the disc tray.

To lock the disc tray (Child Lock)

You can lock the disc tray to prevent it being opened by mistake.

When the player is turned on, hold down **||** on the player for more than 10 seconds until "LOCKED" appears in the front panel display. The disc tray is locked.

To unlock the disc tray, hold down **||** on the player until "UNLOCK" appears in the front panel display.

Front panel display

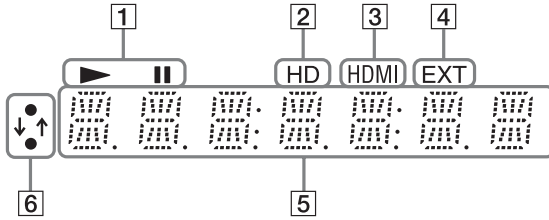

1 ▶, ||

Lights up during playback or pause.

2 HD (page 42)

Lights up when outputting 720p/1080i/1080p video signals from the HDMI OUT jack or 720p/1080i video signals from the COMPONENT VIDEO OUT jacks.

3 HDMI (page 16)

Lights up when an HDMI device is connected.

4 EXT (page 23)

Lights up when the external memory is recognised.

5 Playback information

You can check the time information. Press TIME repeatedly during playback. The display changes as follows.

When playing a BD-ROM/DVD VIDEO

Elapsed time of the current title



Remaining time of the current title

When playing a CD

Elapsed time of the current track



Remaining time of the current track



Elapsed time of the current disc



Remaining time of the current disc



“T” (Title or Track), “C” (Chapter), or “D” (Disc) may be displayed depending on the disc.

6 Network connection indicator

Lights up when downloading the player’s software.

For details on downloading the player’s software, see page 40.

Rear panel

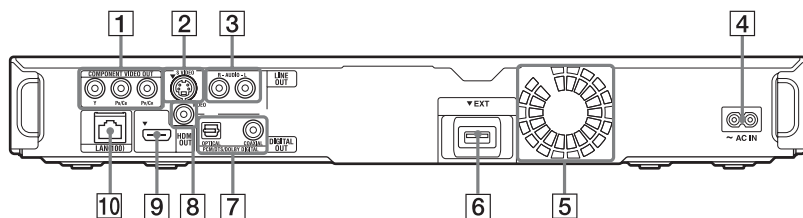

- 1 COMPONENT VIDEO OUT (Y, PB/CB, PR/CR) jacks (page 17)**
- 2 LINE OUT (S VIDEO) jack (page 18)**
- 3 LINE OUT (R-AUDIO-L) jacks (page 18, 22)**
- 4 AC IN terminal (page 25)**
- 5 Ventilation holes**
The ventilation fan is inside the player.
- 6 EXT slot (page 23)**
- 7 DIGITAL OUT (OPTICAL/COAXIAL) jacks (page 21)**
- 8 LINE OUT (VIDEO) jack (page 18)**
- 9 HDMI OUT jack (page 15, 20)**
- 10 LAN (100) terminal (page 24)**

Hooking Up the Player

Check that you have the following items.

- Audio/video cable (phono plug x3) (1)
- Mains lead (1)
- Remote commander (remote) (1)
- R6 (size AA) batteries (2)

Follow steps 1 through 7 to hook up and adjust the settings of the player. Do not connect the mains lead until you reach “Step 5: Connecting the Mains Lead” (page 25).

Hookups and Settings

Step 1: Connecting to Your TV

About video/HDMI OUT jacks

The player has the following video jacks. Connect the player to your TV according to the input jack on your TV.

When connecting the player to your TV using the HDMI cable, you can enjoy high quality digital pictures and sound through the HDMI OUT jack.

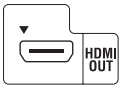
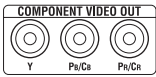
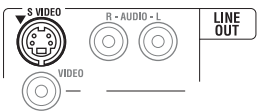
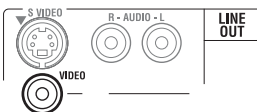
Jack type	Video resolution	Hookup
High quality Digital 	High Definition: 1080/24p, 1080p, 1080i, 720p Standard Definition: 576p/480p, 576i/ 480i	See "Connecting to an HDMI jack" (page 15).
Analogue 	High Definition: 1080i, 720p Standard Definition: 576p/480p, 576i/ 480i	See "Connecting to component video jacks (Y, Pb/Cb, Pr/ Cr)" (page 17).
	Standard Definition: 576i/480i	See "Connecting to an audio/video or S VIDEO jack" (page 18).
	Standard Definition: 576i/480i	See "Connecting to an audio/video or S VIDEO jack" (page 18).
Standard quality		



- Plug in cables securely to prevent unwanted noise.
- Refer to the instructions supplied with the components to be connected.
- You cannot connect this player to a TV that does not have a video input jack.
- Do not apply too much pressure on the connecting cables. Pushing against the cabinet wall, etc., may damage the cable.

To connect to a TV with DVI input

Use an HDMI-DVI converter cable (not supplied). The DVI jack will not accept any audio signals, so you have to use another audio connection in addition to this connection (page 19).

Furthermore, you cannot connect the HDMI OUT jack to DVI jacks that are not HDCP compliant (e.g., DVI jacks on PC displays).

Connecting to an HDMI jack

Connect the player and your TV using an HDMI cable to enjoy high quality digital pictures and sound through the HDMI OUT jack.

If you connect a Sony TV that is compatible with the "Control for HDMI" function (page 16), refer to the operating instructions supplied with the TV.

If you connect a 1080/24p- or 1080p-compatible TV, use a High Speed HDMI cable.

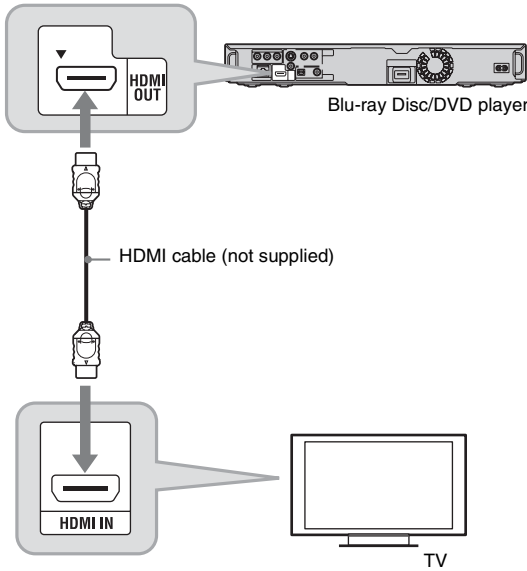

Notes on connecting to the HDMI OUT jack

Observe the following as improper handling may damage the HDMI OUT jack and the connector.

- Carefully align the HDMI OUT jack on the rear of the player and the HDMI connector by checking their shapes. Make sure the connector is not upside down or tilted.

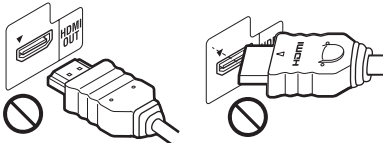

- Be sure to disconnect the HDMI cable when moving the player.



- If you place the player on a cabinet with the HDMI cable connected, do not apply too much pressure to the cabinet wall. It may damage the HDMI OUT jack or the HDMI cable.
- When connecting or disconnecting, do not screw in or rotate the HDMI connector.

About indicators for HDMI connection

When connecting an HDMI compatible component, the HDMI indicator lights up in the front panel display.



- Consumers should note that not all high definition television sets are fully compatible with this product and may cause artifacts to be displayed in the picture. In the case of 480p/576p/720p/1080i/1080p scan picture problems, it is recommended that the user switch the connection to the 'standard definition' output. If there are questions regarding our TV set compatibility with this model 480p/576p/720p/1080i/1080p Blu-ray Disc/DVD player, please contact our customer service centre.
- If the picture is not clear, not natural or not to your satisfaction, change the video output resolution in step 3 of "Output Video Format" under the "Video Settings" setup (page 42).
- Be sure to use only an HDMI cable that bears the HDMI logo.

About the BRAVIA Sync features (for HDMI connections only)

By connecting Sony components that are compatible with the "Control for HDMI" function with an HDMI cable (not supplied), operation is simplified as below:

- **One-Touch Play**
With one touch of the following buttons, the connected TV turns on and the input selector on the TV is switched to the player automatically.
 - : HOME: The home menu appears automatically (page 39).
 - : Playback starts automatically (page 31).
- **System Power-Off**
When you turn off the TV using the power button on the TV's remote, the player and HDMI-compatible components turn off automatically.

- **Theatre**

When you press THEATRE, the player automatically switches to the optimum video mode for watching movies. When connected with an AV amplifier (receiver) using the HDMI cable, the speaker output also switches automatically. When connected with a Theatre Mode-compatible TV using the HDMI cable, the TV's video mode switches to Theatre Mode. Press the button again to return to the original setting.

- **Language Follow**

When you change the language for the on-screen display on your TV, the player's language for the on-screen display is also changed after turning the player off and on.

To prepare for the BRAVIA Sync features

Set "Control for HDMI" to "On" in the "System Settings" setup (page 50).

For details on settings of your TV or other connected components, refer to the operating instructions supplied with the TV or components.



- When connecting the Sony TV that is compatible with the "Control for HDMI" Easy Setting function using the HDMI cable, the "Control for HDMI" setting of the player automatically switches to "On" if the "Control for HDMI" setting on the connected TV is set to "On." Refer to the operating instructions supplied with the TV.
- When connecting the Sony TV that is compatible with the BRAVIA Sync features using the HDMI cable, you can control the basic functions of the player with the TV's remote if the "Control for HDMI" setting on the connected TV is set to "On." Refer to the operating instructions supplied with the TV.



Depending on the connected component, the "Control for HDMI" function may not work. Refer to the operating instructions supplied with the component.

Connecting to component video jacks (Y, P_B/C_B, P_R/C_R)

Connect the COMPONENT VIDEO OUT jacks of the player and your TV using a component video cable (not supplied) of the same kind and length. You can enjoy high-quality pictures.

Be sure to connect to the LINE OUT (R-AUDIO-L) jacks using the audio/video cable.

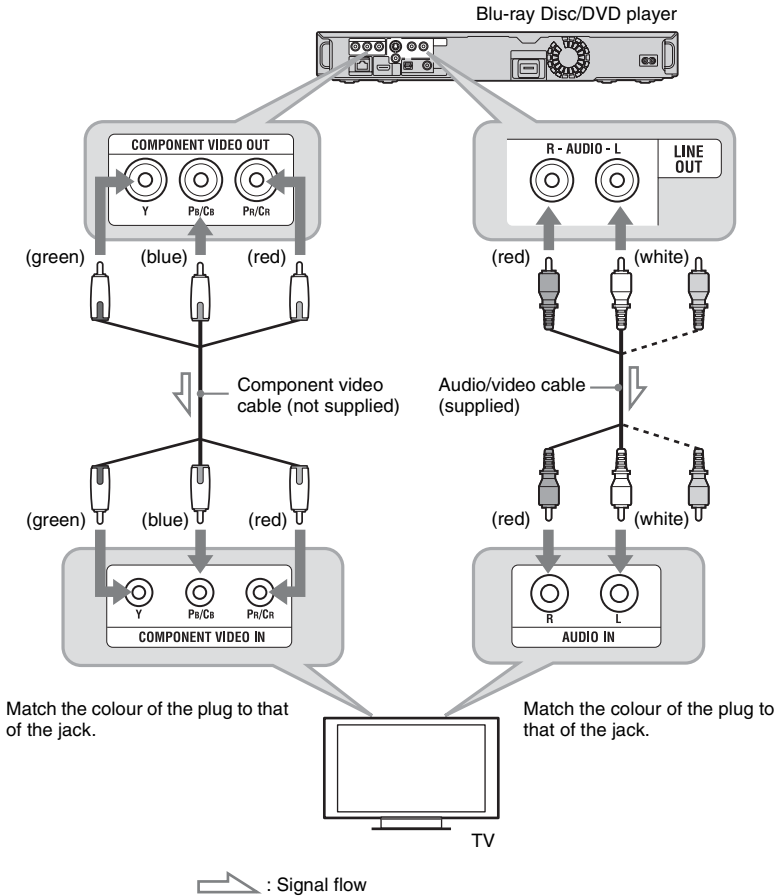

When you connect the player and TV using a component video cable, disconnect the video plug (yellow) of the audio/video cable.

Connecting to an audio/video or S VIDEO jack

Connect the LINE OUT (VIDEO, R-AUDIO-L) jacks of the player and your TV using the audio/video cable. You can enjoy standard quality pictures and sound.

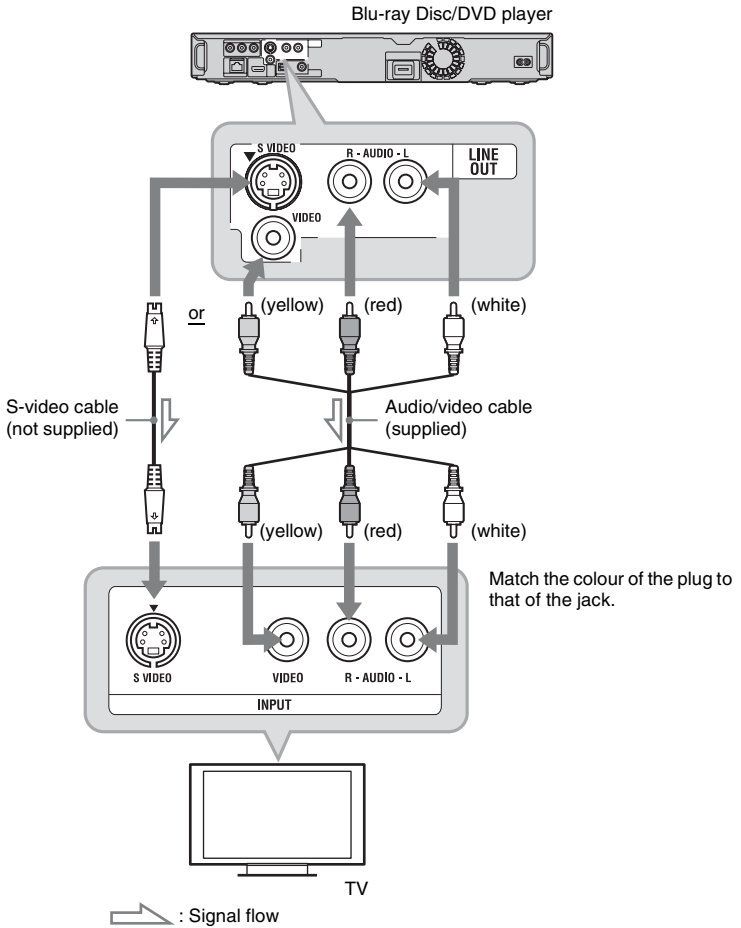



When you connect the player and TV using an S-video cable, disconnect the video plug (yellow) of the audio/video cable.

Step 2: Connecting to Your AV Amplifier (Receiver)

About audio/HDMI OUT jacks

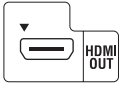
The player has the following audio jacks. Connect the player to your AV amplifier (receiver) according to the input jack on your AV amplifier (receiver).

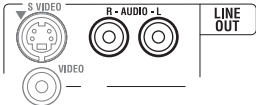
Jack type		Hookup
Digital		See “Connecting to an HDMI jack” (page 20).
		See “Connecting to digital jacks (OPTICAL/COAXIAL)” (page 21).
Analogue		See “Connecting to audio L/R jacks” (page 22).



For correct speaker location, refer to the operating instructions supplied with the connected components.



- When you connect the player to your AV amplifier (receiver) using an HDMI cable, do one of the following:
 - Connect your AV amplifier (receiver) to your TV using an HDMI cable, or
 - Connect the player to your TV using a video cable other than an HDMI cable (component video cable, S-video cable, or audio/video cable).
- If you connect a component that does not conform to the selected audio signal, a loud noise (or no sound) will come from the speakers, which could damage your ears or the speakers.

Connecting to an HDMI jack

If your AV amplifier (receiver) has an HDMI input, you can enjoy surround sound. If you connect a Sony AV amplifier (receiver) that is compatible with the “Control for HDMI” function (page 16), refer to the operating instructions supplied with the AV amplifier (receiver).

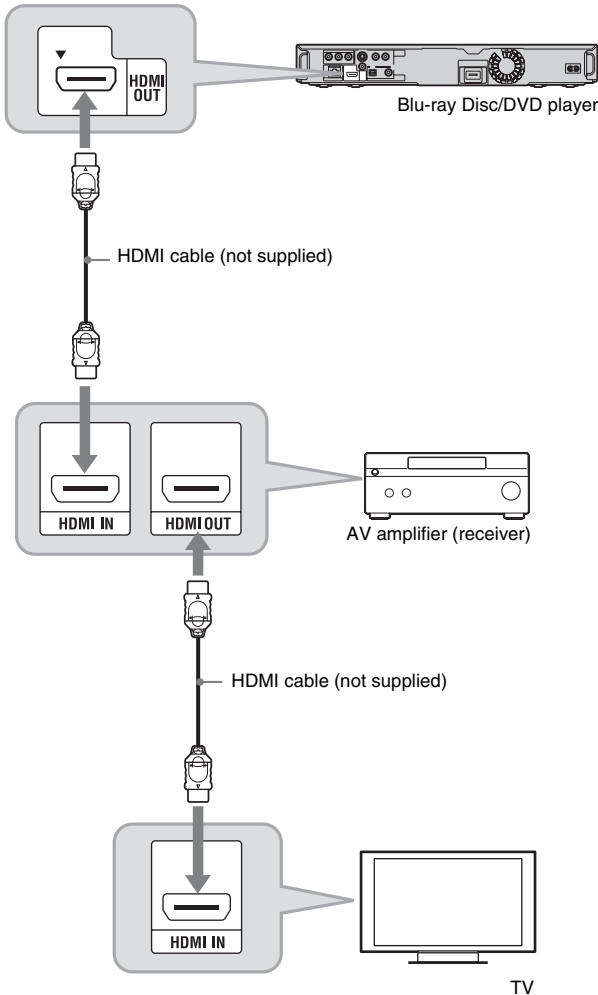

Set the following settings and you can enjoy higher quality sound from the connected AV amplifier (receiver).

- Set “Audio Output Priority” to “HDMI” in the “Audio Settings” setup (page 44).
- Set “Audio (HDMI)” to “Auto” in the “Audio Settings” setup (page 44).
- Set “BD Audio Setting” to “Direct” in the “Audio Settings” setup (page 45).



Not all HDMI-compatible AV amplifiers (receivers) accept 8ch Linear PCM signals. Refer as well to instructions supplied with the connected AV amplifier (receiver).

Connecting to digital jacks (OPTICAL/COAXIAL)

If your AV amplifier (receiver) has a Dolby^{*1} Digital, Dolby Pro Logic, or DTS^{*2} decoder and a digital input jack, you can enjoy Dolby Digital (5.1ch), Dolby Pro Logic (4.0ch), or DTS (5.1ch) surround effects.

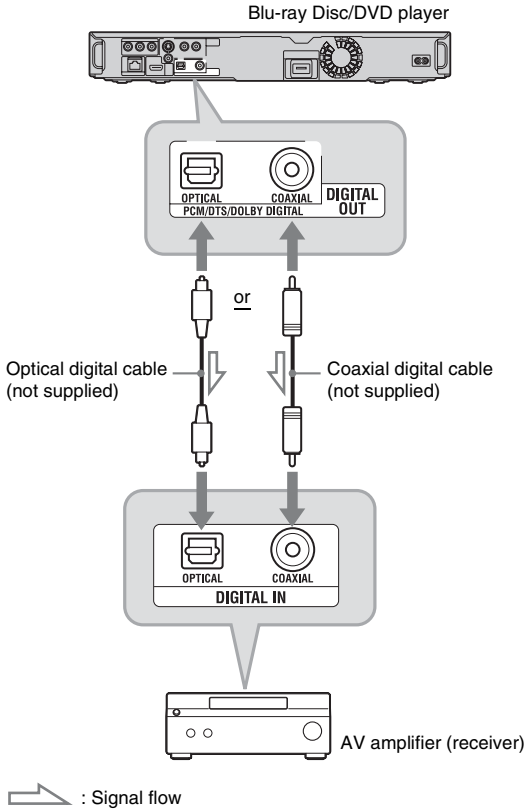

1 Connect the digital jack of the player and your AV amplifier (receiver).

2 Set “Audio Output Priority” to “Coaxial/Optical” in the “Audio Settings” setup (page 44).

3 Make the appropriate settings in “Dolby Digital” and “DTS” under the “Audio Settings” setup (page 45).

Otherwise, no sound or a loud noise will come from your speakers.

^{*1} Manufactured under license from Dolby Laboratories. Dolby, Pro Logic, and the double-D symbol are trademarks of Dolby Laboratories.

^{*2} Manufactured under license under U.S. Patent #s: 5,451,942; 5,956,674; 5,974,380; 5,978,762; 6,487,535 & other U.S. and worldwide patents issued & pending. DTS is a registered trademark and the DTS logos, Symbol, DTS-HD and DTS-HD Advanced Digital Out are trademarks of DTS, Inc. © 1996-2007 DTS, Inc. All Rights Reserved.

Connecting to audio L/R jacks

If your AV amplifier (receiver) only has L and R audio input jacks, use this connection.

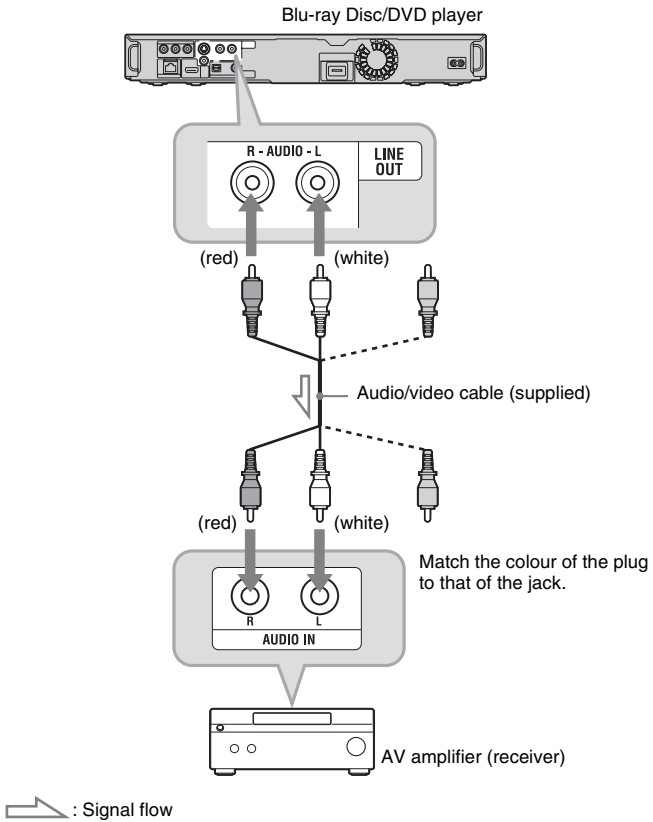

Step 3: Inserting the External Memory

To enjoy additional content (such as BonusView) on certain Blu-ray Disc titles, you will need to use external memory. Insert the external memory device (1 GB or larger USB flash memory, such as Sony USM1GH) into the EXT slot as your local storage.

Insert the external memory in the ▼ direction into the EXT slot as far as it will go.

Check that the EXT indicator lights up in the front panel display when turning the player on.

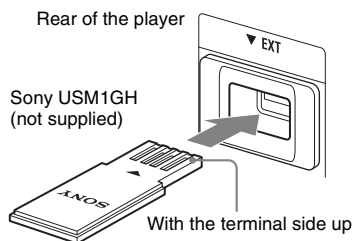

- Do not connect anything other than a USB flash memory, such as an HDD, etc., to the EXT slot.
- Insert the external memory straight. If you force the external memory into the slot, this will cause damage to both the external memory and the player.
- Keep the external memory away from small children to prevent them from accidentally swallowing the external memory.
- Do not apply too much pressure to the external memory in the slot, as it may cause a malfunction.
- We recommend use of the Sony USM1GH available as of April 2008.
- Other USB flash devices may support this function. However we cannot guarantee compatibility with all USB flash memories.
- When inserting a USB flash memory other than Sony USM1GH, check the insertion direction before inserting it.
- Depending on the USB flash memory, it may stick out from the EXT slot. Do not force into the slot or apply pressure to the protruding portion of the USB flash memory.
- To avoid data corruption or damage to the external memory, turn the player off when inserting or removing the external memory.
- When the EXT indicator does not light up, turn the player off, remove and re-insert the external memory, then turn the player on again.
- Do not insert the external memory that contains photo or music files to avoid corrupting the external memory data.

To enjoy BonusView

See “Enjoying BonusView” (page 32).

To remove the external memory

- 1 Press to turn the player off.
- 2 Pull out the external memory from the EXT slot.

Step 4: Connecting to the Network

Connect the LAN (100) terminal of the player to your Internet source using a network cable to update the player's software using the network.

1 Connect the LAN (100) terminal of the player to your Internet source.

Methods to connect to your Internet source include:

- Connecting to a broadband router directly
 - Connecting via a wireless LAN router
- Refer also to the instructions supplied with the broadband router or the wireless LAN router.

2 Make the appropriate settings in "Internet Settings" under the "Network Settings" setup (page 51).

To update the player's software using the network

See "Network Update" (page 40) and "Software Update Notification" (page 50).



Do not connect a phone line to the LAN (100) terminal, as it may cause a malfunction.

When connecting to a broadband router directly

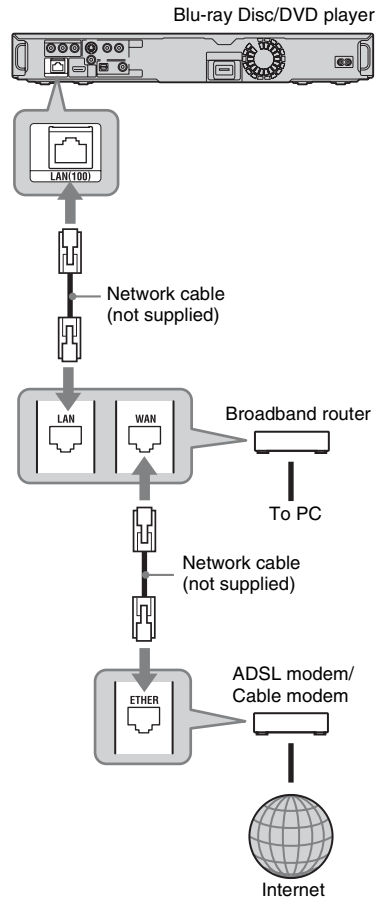

About network (LAN) cables

Depending on the modem or router, the type of network (LAN) cable, straight or crossing, differs. For details on the network (LAN) cables, refer to the operating instructions supplied with the modem or router.

When connecting via a wireless LAN router

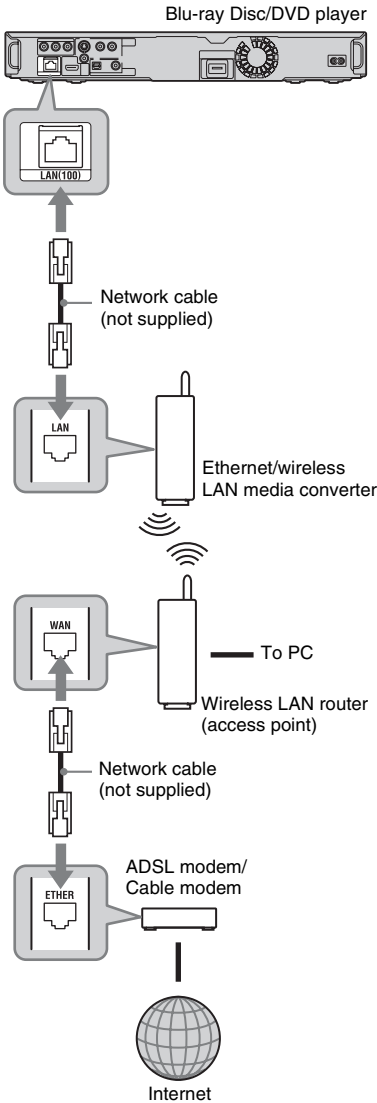

Do not connect the LAN terminal of the player to the LAN terminal of the PC.

Step 5: Connecting the Mains Lead

After all of the other connections are complete, connect the supplied mains lead (AC power cord) to the AC IN terminal of the player. Then plug the player and TV mains leads (AC power cords) into the mains.

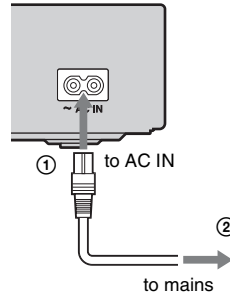

Step 6: Preparing the Remote

You can control the player using the supplied remote. Insert two R6 (size AA) batteries by matching the ⊕ and ⊖ ends on the batteries to the markings inside the battery compartment. When using the remote, point it at the remote sensor  on the player (page 10).

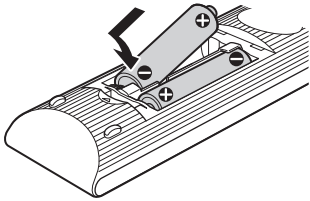

- Use the batteries correctly to avoid possible leakage and corrosion. Should leakage occur, do not touch the liquid with bare hands. Observe the following:
 - Do not use a new battery with an old battery, or batteries of different manufacturers.
 - Do not attempt to recharge the batteries.
 - If you do not intend to use the remote for an extended period of time, remove the batteries.
 - If battery leakage occurs, wipe out any liquid inside the battery compartment, and insert new batteries.
- Do not expose the remote sensor (marked  on the front panel) to strong light, such as direct sunlight or a lighting apparatus. The player may not respond to the remote.

Controlling TVs with the remote

You can control the volume, input source, programme position, and power switch of your Sony TV with the supplied remote.



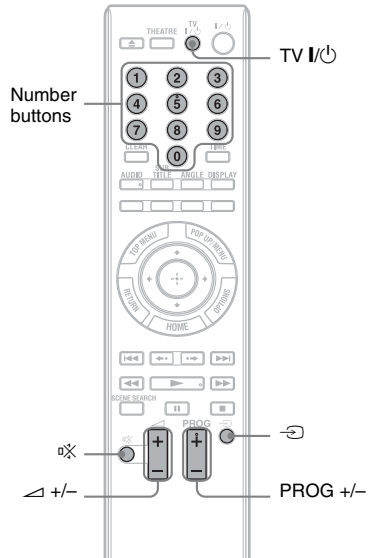

When you replace the batteries of the remote, the code number may be reset to the default setting. Set the appropriate code number again.



Available buttons

Depending on the connected unit, you may not be able to control your TV with some or all of the buttons (TV I/O, PROG +/-, +/-, +/-, +/-, or number buttons).

Buttons	Operations
TV I/O	Turns your TV on or off.
+/- (volume) +/-	Adjusts the volume of your TV.
PROG (programme) +/-	Selects the programme position on your TV.
 (input select)	Switches your TV's input source between the TV and other input sources.
 (muting)	Mutes the sound.

To control other TVs with the remote

You can control the volume, input source, programme position, and power switch of non-Sony TVs as well.

If your TV is listed in the table below, set the appropriate manufacturer's code.



If you enter a new code number, the code number previously entered will be erased.

- 1 While holding down TV I/⏻, enter the TV's manufacturer code using the number buttons.
For instance, to enter "09," press "0" then "9."

Code numbers of controllable TVs

If more than one code number is listed, try entering them one at a time until you find the one that works with your TV.

Manufacturer	Code number
Sony	01 (default)
Hitachi	24
JVC	33
LG/Goldstar	76
Panasonic	17, 49
Philips	06, 08, 72
Samsung	71
Sharp	29
Toshiba	38

- 2 Release TV I/⏻.

Step 7: Easy Setup

Follow the steps below to make the minimum number of basic adjustments for using the player. If you do not complete Easy Setup, it will appear each time you turn on your player.

Make the settings below in the following order.

When turned on for the first time

Wait for a short while before the player turns on and starts Easy Setup.

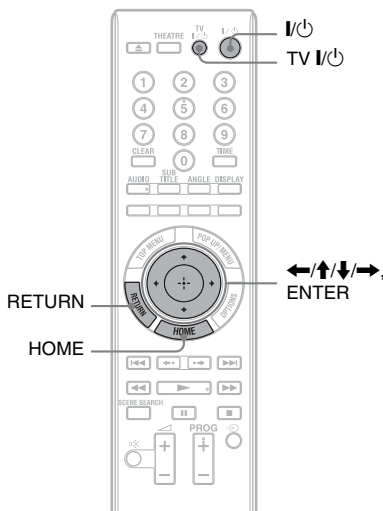

- 1 Turn on the TV.
- 2 Press I/⏻ to turn on the player.
The player turns on after a moment.
- 3 Switch the input selector on your TV so that the signal from the player appears on your TV screen.
The display for OSD language selection appears.
 - If the display for OSD language selection does not appear Press HOME, and select "Easy Setup" in the "Setup" setup (page 53). Then, select "Start," and press ENTER.

4 Select a language for the on-screen displays using **↑/↓**, and press **ENTER**.

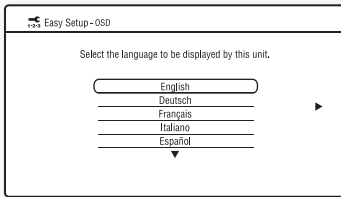

The initial settings message appears.

5 Select **“Start,”** and press **ENTER**.

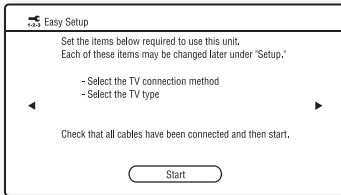

6 Select the cable type used to connect the player and your TV, and press **ENTER**.

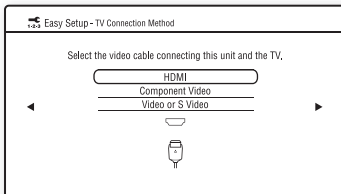

Select **“HDMI”** when connecting your TV using the HDMI cable, and go to step 7.



When connecting the HDMI OUT jack and other video output jacks at the same time, select **“Component Video.”**

Select **“Component Video”** when connecting your TV using the component video cable, and go to step 7.

Select **“Video or S Video”** when connecting your TV using the video cable or S-video cable, and go to step 8.

7 Select a video output resolution for the connected TV, and press **ENTER**.

For details about the video output resolution, see page 43.

When you select “HDMI” in step 6

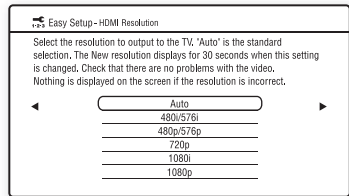

Select from **“Auto,” “480i/576i,” “480p/576p,” “720p,” “1080i,”** or **“1080p.”**

When connecting the HDMI OUT jack and other video output jacks at the same time, video signals may not output from the jacks, other than from the HDMI OUT jack, when **“Auto”** or **“1080p”** is selected.

When connecting other equipment at the same time, press **RETURN** to return to step 6 and change the **“TV Connection Method”** setting.

When you select “Component Video” in step 6

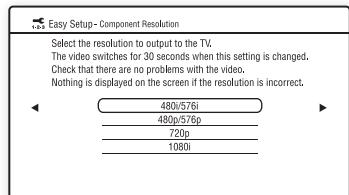

Select from **“480i/576i,” “480p/576p,” “720p,”** or **“1080i.”**

When you change the video output resolution, a picture is displayed in the selected resolution for about 30 seconds, then the display asks for confirmation. Follow the on-screen instructions and go to the next step.



If the picture is distorted or no picture appears, wait for about 30 seconds without pressing any buttons. The display returns to the resolution setting screen.

If the selected video output resolution is incorrect, no picture appears on the screen when you press any button in 30 seconds. In this case, press **■** on the player for more than 10 seconds to reset the video output resolution to the lowest resolution. To change the video output resolution, set "Output Video Format" in the "Video Settings" setup (page 42).

8 Select an aspect ratio that matches your TV, and press ENTER.

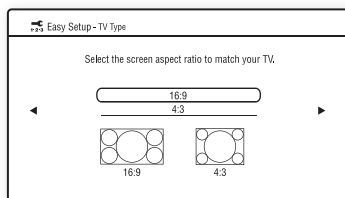

Select "16:9" when connecting to a wide-screen TV or a TV with a wide mode function.

Select "4:3" when connecting to a 4:3 screen TV without a wide mode function.

9 (Only when connecting your TV using the HDMI cable)

Set the "Control for HDMI" function to "On" or "Off," and press ENTER.

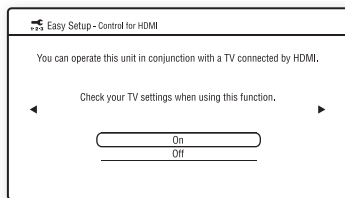

Select "On" to use the "Control for HDMI" function when connecting Sony components that are compatible with the "Control for HDMI" function (page 16). If you do not use the "Control for HDMI" function, select "Off."

10 Select "Finish," and press ENTER.

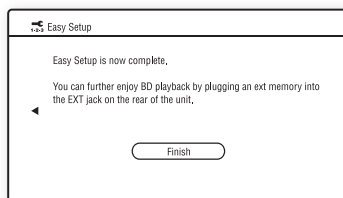

- You can reset settings to their factory settings (page 53).
- You can run "Easy Setup" again from "Easy Setup" in "Setup" (page 53).

Playing BDs/DVDs

BD **DVD**

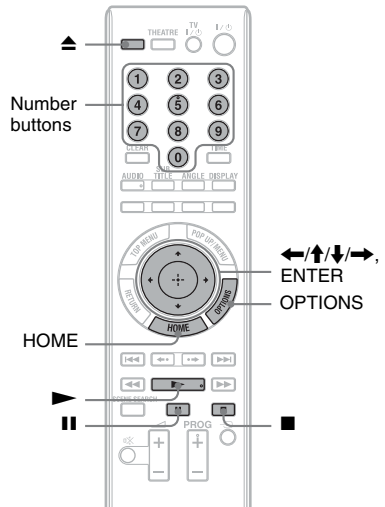

Playback

- 1** Switch the input selector on your TV so that the signal from the player appears on your TV screen.
- 2** Press **▲**, and place a disc on the disc tray.

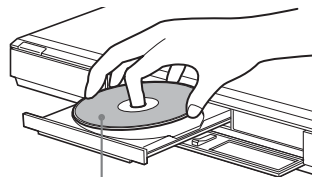

Playing side facing down

- 3** Press **▲** to close the disc tray.
 - When you insert a commercially available BD-ROM or DVD VIDEO, playback automatically starts depending on the disc.
- ⚡** Playback does not start by pressing **▶** while the disc tray is open.

- 4 Press HOME.
- 5 Select "Video" using ←/→.
- 6 Select  using ↑/↓, and press ► or ENTER.

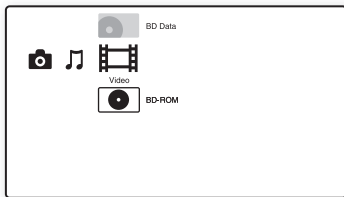

For commercially available BD-ROMs or DVD VIDEOS, playback starts. For BDs or DVDs recorded on other equipment, the title list appears. Select a title using ↑/↓, and press ► or ENTER. Playback starts.

To stop playback

Press ■.

To pause playback

Press ||.



In the title list, "PL" (Playlist) is displayed next to the name of titles that are created and edited from their originals.



- Depending on the disc you may not be able to do some of the playback operations. Refer to the instruction manual supplied with the disc.
- Depending on BDs or DVDs recorded on other equipment, title lists or title names may not be displayed.

To resume playback from the point where you stopped (Resume Play)

After stopping playback, select  using ↑/↓, and press ► or ENTER.

The player resumes playback from the point where you pressed ■.

To start from the beginning, press OPTIONS to select "Play from start," and press ENTER. Playback starts from the beginning of the title.



- The point where you stopped playing is cleared from memory when:
 - you open the disc tray,
 - you play another title,
 - you change the settings on the player, or
 - you remove the external memory (for BD-ROMs).
- The player may not resume playback depending on the disc or stop point.

To play restricted BDs or DVDs (Parental Control)

When you play a restricted BD, change the "BD Parental Control" setting in the "BD/DVD Viewing Settings" setup (page 47). When you play a restricted DVD, the display for entering your password appears on the screen.

Enter your four-digit password using the number buttons, and press ENTER. Playback starts.

To register or change the password, see "Password" (page 49).

To play restricted BD-REs or BD-Rs (Disc Lock)

When you play a BD-RE or BD-R restricted by the Disc Lock function, the display for entering your password appears on the screen.

- 1 Enter the four-digit password that has been registered when creating the disc using the number buttons, and press ENTER.
- 2 Select a title, and press ► or ENTER. Playback starts.

One-Touch Play (for HDMI connection only)

Press ►.

The player and the connected TV turn on and the input selector on the TV is switched to the player, then playback starts automatically.



- When using the HDMI connection, there may be a delay before the playback picture appears on the screen, and the beginning portion of the playback picture may not be displayed.
- To use the One-Touch Play function, set "Control for HDMI" to "On" in the "System Settings" setup (page 50).

Available OPTIONS

- 1 Press **OPTIONS**.
The options menu appears.
- 2 Select an item using **↑/↓**, and press **ENTER**.
The available items differ depending on the disc type or player situation.

Items	Details
A/V Settings	Adjusts settings for picture and sound. <ul style="list-style-type: none">• Video Settings (page 34)• Audio Settings (page 35)
Title List	Displays the title list.
Play	Plays the title from the point where you pressed ■ .
Play from start	Plays the title from the beginning.
Top Menu	Displays the disc's Top Menu (page 32).
Menu/Popup Menu	Displays the BD-ROM's Pop-up Menu or DVD's menu (page 32).
Stop	Stops playback.
Title Search	Searches for a title and starts playback from the beginning (page 33).
Chapter Search	Searches for a chapter and starts playback from the beginning (page 33).

Using the BD's or DVD's menu

BD **DVD**

To display Top Menu

When you play a BD or DVD, you can display the Top Menu.

- 1 Press **TOP MENU** during playback.
The Top Menu appears.
- 2 Select an item using **←/↑/↓/→**.

To display Pop-up Menus

Some BD-ROMs contain Pop-up Menus that appear without interrupting playback.

- 1 Press **POP UP/MENU** during playback.
The Pop-up Menu appears.
- 2 Select an item using **←/↑/↓/→**, colour buttons, or the number buttons, and follow the on-screen instructions.

Enjoying BonusView

BD

Some BD-ROMs have bonus contents and other data that can be downloaded to the external memory (local storage) for enjoyment.

- 1 **Turn the player off.**
- 2 **Insert the external memory (not supplied) into the EXT slot on the rear of the player.**

The external memory is used as the local storage.

Make sure that the external memory is properly inserted into the player (page 23).

- 3 **Turn the player on.**
- 4 **Insert a BD-ROM with BonusView.**

The operation method differs depending on the disc. Refer to the instruction manual supplied with the disc.

To delete data in the external memory

You can delete all unnecessary data at once.

- 1 Press HOME.
- 2 Select "Video" using \leftarrow/\rightarrow .
- 3 Select "BD Data" using \uparrow/\downarrow , and press OPTIONS.
- 4 Select "Erase," and press ENTER.
- 5 Select "OK," and press ENTER.

Searching for a scene quickly (Scene Search)

BD DVD

You can move quickly between scenes within the title currently being played back.

- 1 **Press SCENE SEARCH during playback or in pause mode.**

Playback pauses and a bar with a scene indicator (square-shaped – indicates the current point) appears at the bottom of the screen.

- 2 **Move the scene indicator to the scene you are searching for using \leftarrow/\rightarrow or \ll/\gg .**

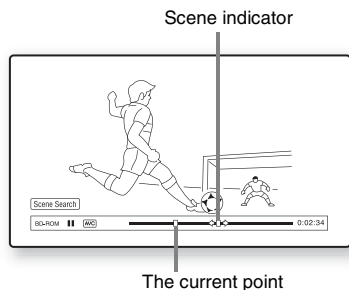

The scene indicator on the bar is displayed around the playing point.

- 3 **Release the button at the point you want to watch.**

The scene at which you released the button is displayed in pause mode. To search for a scene again, move the scene indicator using \leftarrow/\rightarrow or \ll/\gg .

- 4 **Press SCENE SEARCH, ENTER, \blacktriangleright , or \parallel .**

Playback starts.

To cancel Scene Search mode

Press SCENE SEARCH, ENTER, \blacktriangleright , or \parallel . Playback starts from the point you pressed the button.



- The Scene Search function is available for titles longer than 100 seconds and shorter than 100 hours.
- The Scene Search function may not be available depending on the disc.

Searching for a Title/Chapter

BD DVD

You can search for a chapter if the title contains chapter marks.

- 1 **Press OPTIONS during playback or in pause mode.**

The options menu appears.

- 2 **Select a search method using \uparrow/\downarrow , and press ENTER.**

"Title Search" (for BD-ROMs/DVD VIDEOS)

"Chapter Search"

The display for entering the number appears.

Example: Chapter Search

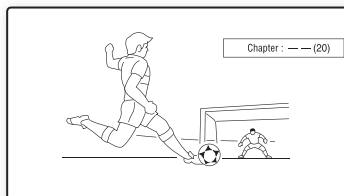

- 3 **Enter the number of the title or chapter using the number buttons.**

If you make a mistake, press CLEAR, and re-enter another number.

- 4 **Press ENTER.**

After a while, the player starts playback from the selected number.

Displaying the playing time and playing information

BD DVD

You can check the title information, including the video transmission rate, etc.

Press DISPLAY.

The displayed information differs depending on the disc type and player status.

Example: When playing a BD-ROM

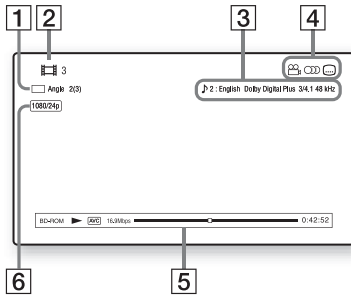

- 1 The current selected angle
- 2 Title number or name
- 3 The currently selected audio or subtitle setting
- 4 Available functions (🗨️ angle/🔊 audio/⋮ subtitle)
- 5 Playback information
Displays Disc type/Play mode/Video codec/Bit rate/Playing status bar/Playing time (Remaining time*)
- 6 Output resolution/Video frequency

* Displayed when you press TIME repeatedly.



- You can also check the playback information in the front panel display (page 11).
- Press SUBTITLE, AUDIO, or ANGLE, and you can check each type of information.

Adjusting pictures and sound for videos

BD DVD

To adjust the picture

- 1 Press **OPTIONS** during playback. The options menu appears.
- 2 Select “A/V Settings” using **↑/↓**, and press **ENTER**.
- 3 Select “Video Settings” using **↑/↓**, and press **ENTER**. The “Video Settings” screen appears.

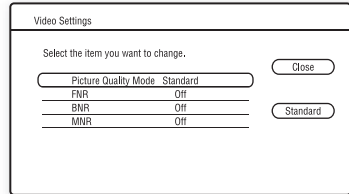

- 4 Select an item using **↑/↓**, and press **ENTER**. The default settings are underlined.

Items	Details
Picture Quality Mode (Standard/ Brighter Room/Theatre Room)	Optimises the picture settings for different lighting environments.
FNR (Off/Auto)	Reduces random noise appearing in the picture.
BNR (Off/Auto)	Reduces mosaic-like block noise in the picture.
MNR (Off/Auto)	Reduces minor noise around the picture outlines (mosquito noise).

- 5 Select or adjust the settings using **←/↑/↓/→**, and press **ENTER**. To adjust any other items, repeat steps 4 and 5.



- Set the picture setting of your TV to 'Standard' before changing the "Picture Quality Mode" settings.
- "Video Settings" is not available when the connected TV is set to Theatre Mode (page 16).
- Depending on the disc or the scene being played, "FNR," "BNR" or "MNR" effects may be hard to discern.



- The "Audio Filter" function does not work for digital audio signals output from the HDMI OUT/ DIGITAL OUT (OPTICAL/COAXIAL) jacks.
- There may be little effect by changing the "Audio Filter" setting depending on the disc or playback environment.

To adjust the audio characteristics

- 1 Press **OPTIONS** during playback.
The options menu appears.
- 2 Select "A/V Settings" using **↑/↓**, and press **ENTER**.
- 3 Select "Audio Settings" using **↑/↓**, and press **ENTER**.
The "Audio Settings" screen appears.

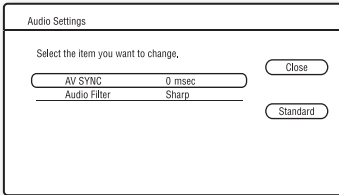

- 4 Select an item using **↑/↓**, and press **ENTER**.
The default settings are underlined.

Items	Details
AV SYNC (short) <u>0</u> ~ 120 msec (long)	Adjusts the gap between picture and sound, by delaying the sound output in relation to the picture output (0 to 120 milliseconds).
Audio Filter (for analogue audio signals only)	<ul style="list-style-type: none"> • <u>Sharp</u>: Provides a wide frequency range and spatial feeling. Normally select this. • Slow: Provides smooth and warm sound.

- 5 Select or adjust the settings using **←/↑/↓/→**, and press **ENTER**.
To adjust any other items, repeat steps 4 and 5.

Playing CDs

CD

- 1 **Insert a CD.**
The Music Player screen appears.
- 2 **Press ►.**
Playback starts.

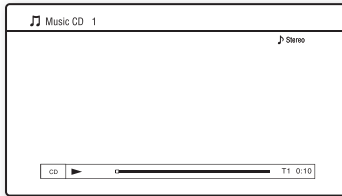

To select a track

- 1 Press HOME.
 - 2 Select (Music) using / .
 - 3 Select , and press ENTER.
The music list appears.
 - 4 Select a track using / .
- To play the selected track, press or ENTER.

Available OPTIONS

- 1 Press OPTIONS.
The options menu appears.
- 2 Select an item using / , and press ENTER.
The available items differ depending on the situation.

Items	Details
Play	Plays the selected track.
Play from start	Plays the current track from the beginning.
Stop	Stops playing the track.

Various music playback operations

Buttons	Operations
	Starts playback from the point where you pressed .
	Stops playback.
	Pauses playback.
	Skips to the beginning of the current or next track. To go to the previous track press twice.
	Fast reverse/fast forwards when pressed during playback.
TIME	Switches time information on the screen and the front panel display (page 11).



The point where you stopped playing (resume point) is cleared from memory when:

- you open the disc tray, or
- you turn off the player.

Playing Photo Files

BD *1 **DATA DVD** *2 **DATA CD** *3

- *1 BD-REs/BD-Rs containing JPEG image files
- *2 DVD+RWs/DVD+Rs/DVD-RWs/DVD-Rs containing JPEG image files
- *3 CD-RWs/CD-Rs containing JPEG image files

- 1 Press **HOME**.
- 2 Select **Photo** using **←/→**.

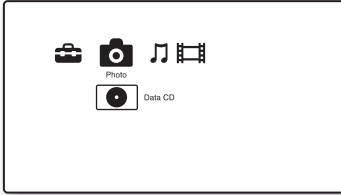

- 3 Select **Photo**, and press **ENTER**.
The file list or folder list appears.

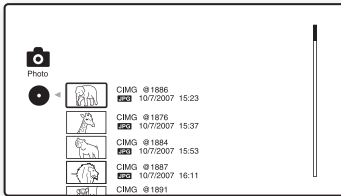

- 4 Select a file or folder using **↑/↓**, and press **ENTER**.
When you select a folder, select a file in the folder using **↑/↓**, and press **ENTER**.
The selected photo file is displayed.
• To play a slideshow, press **▶**.

Available OPTIONS during playback

- 1 Press **OPTIONS** during playback.
The options menu appears.
- 2 Select an item using **↑/↓**, and press **ENTER**.
The available items differ depending on the situation.

Items	Details
Slideshow Speed	Changes the slideshow speed. • Fast • Normal • Slow
Stop	Stops a slideshow.
Rotate Left	Rotates the photo counterclockwise by 90 degrees.
Rotate Right	Rotates the photo clockwise by 90 degrees.

Various photo playback operations

Buttons	Operations
RETURN	Stops a slideshow.
 	Pauses a slideshow.
◀◀/▶▶	Displays the previous or next photo.
DISPLAY	Displays the file information.



- When you attempt to play the following photo files, the  mark appears on the screen and they cannot be played.
 - photo files larger than 8,192 pixels (width or height)
 - photo files smaller than 15 pixels (width or height)
 - photo files exceeding 32 MB
 - photo files with extreme aspect ratios (greater than 50:1 or 1:50)
 - photo files in Progressive JPEG format
 - photo files that have a “.jpeg” or “.jpg” extension, but not in JPEG format
 - photo files that have an extremely long name
- The following photo files cannot be played.
 - photo files recorded on BD-Rs in any format other than UDF (Universal Disk Format) 2.6
 - photo files recorded on BD-REs in any format other than UDF (Universal Disk Format) 2.5
- The following photo files or folders cannot be displayed in the file list or folder list.
 - photo files that have an extension other than “.jpeg” or “.jpg”
 - photo files that have an extremely long name
 - photo files in the 5th tree or lower
 - 501th or more folders when the total number of folders and files in a single tree exceeds 500
- Photo files edited on a PC may not be played.
- Thumbnail images of some photo files may not be displayed.
- Large photo files may take some time to display or to start a slideshow.

To view best quality images



If you have a Sony TV compatible with “PhotoTV HD,” you can enjoy best quality images by the following connection and setting.

- 1** Connect the player to the TV using an HDMI cable (not supplied).
- 2** Set the TV’s video setting to [VIDEO-A] mode.
For details on [VIDEO-A], refer to the operating instructions supplied with the TV.

Settings and Adjustments

Using the Settings Displays

Select  (Setup) on the home menu when you need to change the settings of the player.

- 1 Press HOME.
- 2 Select  (Setup) using / .

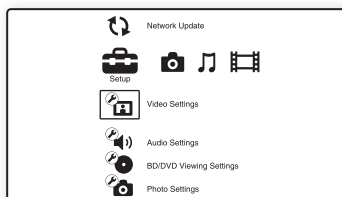

- 3 Select the setup category icon to change using / , and press ENTER.

For details on setting options and setup category icons, see "Setting list" (page 40).



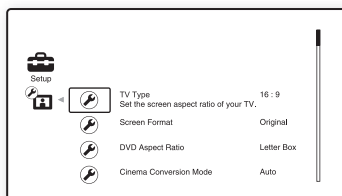





Example: Video Settings



- 4 Set the options.

Setting list

You can setup the following options.

Icon	Explanation
	Network Update (page 40) Updates the software of the player.
	Video Settings (page 41) Makes the video settings according to the type of connecting jacks.
	Audio Settings (page 44) Makes the audio settings according to the type of connecting jacks.
	BD/DVD Viewing Settings (page 47) Makes detailed settings for BD/DVD playback.
	Photo Settings (page 49) Makes the photo-related settings.
	System Settings (page 50) Makes the player-related settings.
	Network Settings (page 51) Makes detailed settings for Internet and network.
 1-2-3	Easy Setup (page 53) Re-runs the Easy Setup to make the basic settings.
	Resetting (page 53) Resets the player to the factory settings.

Network Update

You can update and improve the functions of the player.

For information about update functions, refer to the following website;

<http://www.sony.net/>

1 Select “Network Update” using , and press ENTER.

The player connects to the network, and the display asks for confirmation.

2 Select “OK” using , and press ENTER.

The player starts downloading, then updating the software automatically.

When updating finishes, “FINISH” appears for 5 seconds in the front panel display, then the player automatically turns off.

3 Press to turn on the player.

The player starts up with the updated software.



- The “VUP */9” counter (“*” indicates update step) in the front panel display also shows progress of the update.
- You can check the current software version by selecting “System Information” in the “System Settings” setup (page 50).
- The “Setup” settings remain after updating.
- The player informs you of newer software version information when “Software Update Notification” is set to “On” (default) (page 50).



- Do not disconnect the mains lead or network cable while downloading or updating software.
- Any operations, including opening the disc tray, are not available while updating.
- Downloading times may differ depending on the server provider or line status.
- When error messages on network connections appear, check the network connections using “Network Diagnostic” of “Internet Settings” in the “Network Settings” setup (page 51).

To update the software using an update disc

You can update and improve the functions of the player using an update disc provided by Sony dealer or local authorised Sony service facility.

- 1 Insert the update disc.
The display asks for confirmation.
- 2 Select "OK," and press ENTER.
Software update starts.
When updating finishes, "FINISH" appears for 5 seconds in the front panel display, then the disc tray automatically opens.
- 3 Remove the disc.
The player automatically turns off.
- 4 Press **I/C** to turn the player on.
The player starts up with the updated software.



- The "VUP */9" counter ("*" indicates update step) in the front panel display also shows progress of the update.
- You can check the current software version by selecting "System Information" in the "System Settings" setup (page 50).
- The "Setup" settings remain after updating.
- For information about other software update methods, refer to the following website or consult your nearest Sony dealer or local authorised Sony Service facility;
<http://www.sony.net/>



- Do not disconnect the mains lead while updating.
- Any operations, including opening the disc tray, are not available while updating.



Video Settings

The default settings are underlined.

TV Type

Selects your TV type.

<u>16:9</u>	Select this when connecting to a wide-screen TV or a TV with a wide mode function.
4:3	Select this when connecting to a 4:3 screen TV without a wide mode function.

Screen Format

Selects the display configuration for a 4:3 screen picture on a 16:9 wide screen TV.

<u>Original</u>	Select this when connecting to a TV with a wide mode function. Displays a 4:3 screen picture in 16:9 aspect ratio even on a wide-screen TV.
Fixed Aspect Ratio	Changes the picture size to fit the screen size with the original picture aspect ratio.

DVD Aspect Ratio

Selects the display configuration for playback of 16:9 screen pictures on a 4:3 screen TV (selectable when “TV Type” is set to “4:3” and “Screen Format” is set to “Fixed Aspect Ratio”).

<u>Letter Box</u>	Displays a wide picture with black bands on the top and bottom.
Pan & Scan	Displays a full-height picture on the entire screen, with trimmed sides.

Letter Box



Pan & Scan



Cinema Conversion Mode

Sets the video conversion method for 480p/576p, 720p, 1080i, or 1080p* signals from the HDMI OUT jack or the COMPONENT VIDEO OUT jacks.

* HDMI only

<u>Auto</u>	Normally select this. The player automatically detects whether the material is video-based or film-based, and switches to the appropriate conversion method.
Video	The conversion method suited for video-based material will always be selected regardless of the material.

Output Video Format

Selects the jack type to output video signals (“TV Connection Method”) and output resolution (“HDMI Resolution”/“Component Resolution”).

- 1 Select “Output Video Format” in “Video Settings,” and press ENTER.
- 2 Select the jack type to output video signals using \uparrow/\downarrow , and press ENTER.



When connecting the HDMI OUT jack and other video output jacks at the same time, select “Component Video.”

TV Connection Method

HDMI	Outputs signals from the HDMI OUT jack according to the “HDMI Resolution” setting below.
Component Video	Outputs signals from the COMPONENT VIDEO OUT jacks according to the “Component Resolution” setting below.
<u>Video or S Video</u>	Outputs signals from the LINE OUT VIDEO or S VIDEO jack.

- 3 (When you select “HDMI” or “Component Video” only)
Select the signal type for the HDMI OUT jack or COMPONENT VIDEO OUT jacks using \uparrow/\downarrow , and press ENTER. When you change the video output resolution, a picture is displayed in the selected resolution for about 30 seconds, then the display asks for confirmation. Follow the on-screen instructions.

The HD indicator lights up when outputting 720p/1080i/1080p video signals.



- If the picture is distorted or no picture appears, wait for about 30 seconds without pressing any buttons. The display returns to the resolution setting screen.
If the selected video output resolution is incorrect, no picture appears on the screen when you press any button in 30 seconds. In this case, press **■** on the player for more than 10 seconds to reset the video output resolution to the lowest resolution.
- When connecting the HDMI OUT jack and other video output jacks at the same time, video signals may not output from the jacks, other than from the HDMI OUT jack, when “Auto” or “1080p” is selected.
When connecting other equipment at the same time, press RETURN to return to step 2 and change the “TV Connection Method” setting.

HDMI Resolution/Component Resolution

Auto (HDMI only)	Normally select this. The player outputs signals starting from the highest resolution acceptable to the TV: 1080p > 1080i > 720p > 480p > 480i If the resulting image format is undesirable, try another setting that suits your TV.
480i/576i	Outputs 480i/576i video signals.
480p/576p	Outputs 480p/576p video signals.
720p	Outputs 720p video signals.
1080i	Outputs 1080i video signals.
1080p (HDMI only)	Outputs 1080p video signals.

BD-ROM 1080/24p Output

Sets to output 1920 × 1080p/24 Hz video signals when playing film-based materials on BD-ROMs (720p/24 Hz or 1080p/24 Hz). 1920 × 1080p/24 Hz video signals can be output when all of the following conditions are met.

- You connect a 1080/24p-compatible TV using the HDMI OUT jack,
- “Output Video Format” is set to “HDMI,” and
- “HDMI Resolution” is set to “Auto” or “1080p.”

The 24P indicator lights up when outputting 1920 × 1080p/24 Hz video signals.

Auto	Outputs 1920 × 1080p/24 Hz video signals only when connecting a 1080/24p-compatible TV using the HDMI OUT jack.
On	Outputs 1920 × 1080p/24 Hz video signals regardless of the connected TV type.
Off	Select this when your TV is not compatible with 1080/24p video signals.



No BD-ROM picture appears when the connected TV is non-compatible with 1080/24p and “BD-ROM 1080/24p Output” is set to “On.” In this case, press HOME to display the home menu, and change the “BD-ROM 1080/24p Output” setting.

YCbCr/RGB (HDMI)

Sets the colour setting for video signals output from the HDMI OUT jack. Select the setting that matches the connected TV type.

<u>Auto</u>	Automatically detects the type of external device, and switches to the matching colour setting.
YCbCr (4:2:2)	Outputs YCbCr 4:2:2 video signals.
YCbCr (4:4:4)	Outputs YCbCr 4:4:4 video signals.
RGB (16-235)	Select this when connecting to a device with an HDCP-compliant DVI jack.
RGB (0-255)	Select this when connecting to an RGB (0-255) device.

x.v.Colour Output

Sets whether to send xvYCC information to the connected TV.

Combining xvYCC-compatible video with a TV that supports x.v.Colour display makes it possible to more accurately reproduce object colours present in the natural world.

<u>Auto</u>	Normally select this.
Off	Select this when the picture is unstable or colours appear unnatural.

Pause Mode

Sets the picture mode for DVD playback pause status. For BD-ROMs or discs containing AVCHD files, "Pause Mode" automatically switches to "Auto."

<u>Auto</u>	Normally select this. Dynamic moving pictures appear without blurring.
Frame	Displays static pictures at high resolution.

Audio Settings

The default settings are underlined.

Audio Output Priority

Selects the jack type to output audio signals. 2-channel linear PCM signals are output at 48 kHz maximum from output jacks other than the priority jacks.

<u>HDMI</u>	Outputs audio signals from the HDMI OUT jack.
Coaxial/ Optical	Outputs audio signals from the DIGITAL OUT (OPTICAL/COAXIAL) jack.
Stereo Analogue	Outputs audio signals from the LINE OUT (R-AUDIO-L) jacks.

Audio (HDMI)

Selects the signal type for the HDMI OUT jack.

<u>Auto</u>	Normally select this. Outputs audio signals according to the status of the connected HDMI device.
2ch PCM	Downmixes to 2-channel Linear PCM signals before outputting from the HDMI OUT jack.



Select "2ch PCM" when connecting a TV or an AV amplifier (receiver) that does not support Dolby Digital or DTS, otherwise noise or no sound may result.

BD Audio Setting

Selects whether to mix or not mix interactive audio and secondary audio (commentary) when playing a BD that contains such audio.

Mix	Outputs the audio obtained by mixing the interactive audio and secondary audio to the primary audio.
Direct	Outputs the primary audio only.

Audio ATT

Lowers the audio output level to prevent sound distortion.

On	Enables Audio Attenuation.
Off	Disables Audio Attenuation.



“Audio ATT” does not affect the output from the HDMI OUT jack and the DIGITAL OUT (OPTICAL/COAXIAL) jack.

Dolby Digital

Selects the audio signals output when playing Dolby Digital discs.

This setting affects the output from the DIGITAL OUT (COAXIAL/OPTICAL) jack.

Downmix PCM	Converts to output Linear PCM signals. Select this when connecting an audio device without a built-in Dolby Digital decoder.
Dolby Digital	Select this when connecting an audio device with a built-in Dolby Digital decoder.

DTS

Selects the audio signals output when playing DTS discs. This setting affects the output from the DIGITAL OUT (COAXIAL/OPTICAL) jack.

Downmix PCM	Converts to output Linear PCM signals. Select this when connecting to an audio device without a built-in DTS decoder.
DTS	Select this when connecting to an audio device with a built-in DTS decoder.

48kHz/96kHz PCM

Selects the maximum sampling frequency for the PCM signals output from the DIGITAL OUT (OPTICAL/COAXIAL) jack.

48kHz/16bit	Outputs audio signals of 96 kHz sampling as 48 kHz/16 bit.
96kHz/24bit	Outputs audio signals of 96 kHz sampling as 96 kHz/24 bit. However, the signals will be output as 48 kHz/16 bit if the source is copy-protected.



- If you select “96kHz/24bit” when an AV amplifier (receiver) that does not support 96 kHz is connected, no sound or a loud sound may result.
- “48kHz/96kHz PCM” is not effective when “Audio Output Priority” is set to “HDMI” or “Stereo Analogue.”

Audio DRC

Selects the dynamic range (compression level of the sound) setting when playing a BD or DVD that conforms to “Audio DRC.”

Auto	Performs playback at the dynamic range specified by the disc (BD-ROM only). Other discs are played back at the “Standard” level.
Standard	Performs playback at a compression level between “TV Mode” and “Wide Range.”
TV Mode	Sounds are compressed heavily. Low sounds are easier to hear.
Wide Range	No compression works. A more dynamic sound is produced.



- “Audio DRC” is effective only when playing Dolby Digital, Dolby Digital Plus, and Dolby TrueHD audio signals.
- When “Dolby Digital” is set to “Dolby Digital” in the “Audio Settings” setup (page 45), “Audio DRC” has no effect on the audio output from the DIGITAL OUT (OPTICAL/COAXIAL) jack. However, this excludes the following cases.
 - when “BD Audio Setting” is set to “Mix” when playing a BD.
 - when “Audio Output Priority” is set to “HDMI” or “Stereo Analogue.”

Downmix

Sets the downmix method of multi-channel to two-channel sound.

Dolby Surround	Outputs the Dolby Surround (Pro Logic) signals in 2 channels. Select this when connecting an audio device that supports Dolby Surround (Pro Logic).
Normal	Outputs audio signals without Dolby Surround (Pro Logic) effect. Select this when connecting an audio device that does not support Dolby Surround (Pro Logic).



“Downmix” has no effect on the bitstream audio output from the DIGITAL OUT (OPTICAL/COAXIAL)/HDMI OUT jack.

BD/DVD Viewing Settings

The default settings are underlined>.

BD/DVD Menu

Selects the default menu language for BD-ROMs or DVD VIDEOS.

When you select “Select Language Code,” the display for entering the language code appears. Enter the code for your language by referring to “Language Code List” (page 65).

Audio

Selects the default track language for BD-ROMs or DVD VIDEOS.

When you select “Original,” the language given priority in the disc is selected.

When you select “Select Language Code,” the display for entering the language code appears. Enter the code for your language by referring to “Language Code List” (page 65).

Subtitle

Selects the default subtitle language for BD-ROMs or DVD VIDEOS.





When you select “Select Language Code,” the display for entering the language code appears. Enter the code for your language by referring to “Language Code List” (page 65).

BD Parental Control

Playback of some BD-ROMs can be limited according to the age of the users. Scenes may be blocked or replaced with different scenes.

- 1** Select “BD Parental Control” in “BD/DVD Viewing Settings,” and press ENTER.
- 2** Enter your four-digit password using the number buttons.
- 3** Select “OK,” and press ENTER.
- 4** Select the age restriction, and press ENTER.

The lower the value, the stricter the limitation.

If you select “Select Age Restriction,” you can enter the age from “0” to “255” using /// or the number buttons.

- To cancel the Parental Control setting, select “No Restrictions.”



You can change the password (see “Password” on page 49).



- If you forget the password, reset the player (page 53) and set a new password (see “Password” on page 49).
- When you play discs which do not have the Parental Control function, playback cannot be limited on this player.
- Depending on the disc, you may be asked to change the Parental Control level while playing the disc. In this case, enter your password, then change the level.
- When “255” is selected in “Select Age Restriction,” the Parental Control setting is cancelled.

DVD Parental Control

Playback of some DVD VIDEOS can be limited according to the age of the users. Scenes may be blocked or replaced with different scenes.

- 1** Select “DVD Parental Control” in “BD/DVD Viewing Settings,” and press ENTER.
- 2** Enter your four-digit password using the number buttons.
- 3** Select “OK,” and press ENTER.
- 4** Select a level, and press ENTER.
The lower the value, the stricter the limitation.
 - To cancel the Parental Control setting, select “No Restrictions.”



You can change the password (see “Password” on page 49).



- If you forget the password, reset the player (page 53) and set a new password (see “Password” on page 49).
- When you play discs which do not have the Parental Control function, playback cannot be limited on this player.
- Depending on the disc, you may be asked to change the Parental Control level while playing the disc. In this case, enter your password, then change the level.

Parental Control Region Code

Playback of some BD-ROMs or DVD VIDEOS can be limited according to the geographic area. Scenes may be blocked or replaced with different scenes.

- 1** Select “Parental Control Region Code” in “BD/DVD Viewing Settings,” and press ENTER.
- 2** Enter your four-digit password using the number buttons.
- 3** Select “OK,” and press ENTER.
- 4** Select the area restriction, and press ENTER.
When you select “Select Region Code,” the display for entering the region code appears. Enter the code for the area restriction by referring to “Parental Control/Area Code” (page 65).



You can change the password (see “Password” on page 49).



- If you forget the password, reset the player (page 53) and set a new password (see “Password” on page 49).
- When you play discs which do not have the Parental Control function, playback cannot be limited on this player.
- Depending on the disc, you may be asked to change the Parental Control level while playing the disc. In this case, enter your password, then change the level.

Password

Sets or changes the password for the Parental Control function. A password allows you to set a restriction on BD-ROM or DVD VIDEO playback. If necessary, you can differentiate the restriction levels for BD-ROMs and DVD VIDEOS.

- 1** Select “Password” in “BD/DVD Viewing Settings,” and press **ENTER**.
- 2** Enter your four-digit password using the number buttons.
- 3** Select “OK,” and press **ENTER**.

To change the password

- 1** After step 3, enter a new password using the number buttons.
- 2** Select “OK,” and press **ENTER**.

Hybrid Disc Playback Layer

Selects the layer priority when playing a Hybrid Disc. To change the setting, turn the player off and on again.

<u>BD</u>	Plays BD layer.
DVD/CD	Plays DVD or CD layer.



Photo Settings

The default setting is underlined.

Slideshow Speed

Changes the slideshow speed.

Fast	Photos change rapidly.
<u>Normal</u>	Photos change at normal speed.
Slow	Photos change slowly.

System Settings

The default settings are underlined.

OSD

Selects your language for the player on-screen displays.

Dimmer

Adjusts the lighting of the front panel display.

<u>Bright</u>	Bright lighting.
Dark	Low lighting.
Off	Turns off the lighting during playback. Low lighting other than during playback.

Control for HDMI

On	Allows you to use the “Control for HDMI” function (page 16).
<u>Off</u>	Turns off the function.

Standby Mode

Quick Start	Shortens the startup time from standby mode. You can operate the player quickly after turning it on.
<u>Normal</u>	The default setting.



When “Standby Mode” is set to “Quick Start,”

- power consumption will be higher than when “Standby Mode” is set to “Normal” and
- the ventilation fan may turn on depending on the surrounding temperature.

Auto Display

<u>On</u>	Automatically displays information on the screen when changing the viewing titles, picture modes, audio signals, etc.
Off	Displays information only when you press DISPLAY.

Screen Saver

The screen saver image appears when you do not use the player for more than 15 minutes while an on-screen display, such as the home menu, is displayed on your TV screen. The screen saver image helps prevent your display device from becoming damaged (ghosting).

<u>On</u>	Turns on the screen saver function.
Off	Turns off the function.

Software Update Notification

Informs you of newer software version information. Network connections and settings are required when using this function (page 51).

<u>On</u>	Sets the player to inform you of newer software version information (page 40).
Off	Turns off the function.

System Information

Displays the player’s software version information and the MAC address.



Network Settings

Internet Settings

These items are necessary when you connect to the Internet via a network cable. Enter the respective (alphanumeric) values for your broadband router or Wireless LAN router. The items that need to be set may differ, depending on the Internet service provider or the router. For details, refer to the instruction manuals that have been provided by your Internet service provider or supplied with the router.

- 1** Select “Internet Settings” in “Network Settings,” and press ENTER.
- 2** Select “IP Address Acquisition,” and press ENTER.
- 3** Select an item, and press ENTER.

Use DHCP	Select this when DHCP (Dynamic Host Configuration Protocol) server settings are available from your Internet service provider. The network settings necessary for the player will be assigned automatically.
Use Static IP Address	Set the IP address manually according to your network environment.

- When you select “Use DHCP”
If you set “DNS Server Auto Acquisition” to “Off,” set the following item:
– DNS Server (Primary)/DNS Server (Secondary)
- When you select “Use Static IP Address”
Set the following items:
– IP Address
– Subnet Mask
– Default Gateway
– DNS Server (Primary)/DNS Server (Secondary)



When you set the “DNS Server (Primary)”/“DNS Server (Secondary)” addresses manually, enter the “DNS Server (Primary)” address. Otherwise, the “Internet Settings” will be set incorrectly.

- 4** If your ISP has a specific proxy server setting, select “Proxy Settings” using **↑/↓**, and press ENTER.

The “Proxy Settings” display appears. If the proxy server does not have a specific setting, go to step 8.

- 5** Set “Use of Proxy Server” to “On.”
- 6** Select “Proxy Server” and “Port,” and enter the settings.

To enter the proxy server, see “To enter characters” (page 52).

- 7** Press RETURN.
- 8** Select “Network Diagnostic” using **↑/↓**, and press ENTER.
- 9** Select “Start,” and press ENTER.

- 10** Check that the message “Network connections are correct.” appears.

The setup is finished. If the message does not appear, follow the on-screen messages.

To enter characters

The display for entering characters appears when you select “Proxy Server” in “Proxy Settings.”

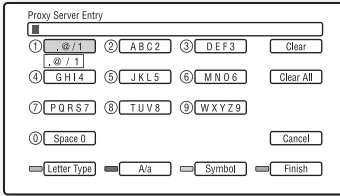

- 1 Press a number button repeatedly to select a character.
Example:
Press the number 3 button once to enter “D.”
Press the number 3 button three times to enter “F.”
- 2 Press \rightarrow , and enter the next character.
- 3 Press the blue button (“Finish”) to finish.

◆ Available buttons

Buttons	Details
Red button (Letter Type)	Switches the keyboard between alphabet and numbers.
Green button (A/a)	Switches the keyboard between upper case and lower case.
Yellow button (Symbol)	Displays the keyboard for symbols.
Blue button (Finish)	The input is entered, and the player returns to the previous display.
CLEAR (Clear/Clear All)	Erases the selected character. To erase all displayed characters, press and hold CLEAR for 2 seconds or more.
RETURN (Cancel)	Returns to the previous display, cancelling the input.
$\leftarrow/\uparrow/\downarrow/\rightarrow$, ENTER	<ul style="list-style-type: none"> • Select an input function using $\leftarrow/\uparrow/\downarrow/\rightarrow$, and press ENTER. • Enter characters as follows: ①Select a character selection panel using $\leftarrow/\uparrow/\downarrow/\rightarrow$, and press ENTER. ②Select a character using \leftarrow/\rightarrow, and press ENTER.



Easy Setup

Re-runs the Easy Setup to make the basic settings.

- 1** Select “Easy Setup,” and press ENTER.
- 2** Select “Start” using \leftarrow/\rightarrow , and press ENTER.
- 3** Follow the instructions for “Step 7: Easy Setup” (page 27) from step 4.



Resetting

You can reset the player settings to the factory default by selecting the group of settings. All the settings within the group will be reset.

- 1** Select “Resetting,” and press ENTER.
- 2** Select “Reset to Factory Default Settings,” and press ENTER.
- 3** Select the settings you want to reset to default, and press ENTER.
The display asks for confirmation. You can reset the following settings:
 - Video Settings
 - Audio Settings
 - BD/DVD Viewing Settings
 - Photo Settings
 - System Settings
 - Network Settings
 - All Settings
- 4** Select “Start” using \leftarrow/\rightarrow , and press ENTER.



When “All Settings” is selected in step 3, the Blu-ray Disc indicator lights up, then turns off when Easy Setup is complete.

Additional Information

Troubleshooting

If you experience any of the following difficulties while using the player, use this troubleshooting guide to help remedy the problem before requesting repairs. Should any problem persist, consult your nearest Sony dealer.

Power

The power does not turn on.

- ➔ Check that the mains lead is connected securely.
- ➔ It takes a short while before the player turns on.

The message “A new software version has been found on the network.” appears on the screen when turning the player on.

- ➔ See “Network Update” (page 40) to update the player to a newer software version.

Disc

The disc does not play.

- ➔ The disc is dirty.
- ➔ The disc is upside down. Insert the disc with the playback side facing down.
- ➔ The disc is skewed.
- ➔ You are attempting to play a disc with a format that cannot be played back by this player (page 60).
- ➔ The region code on the BD or DVD does not match the player.
- ➔ The player cannot play a recorded disc that is not correctly finalised (page 60).

Picture

See also “Connecting to an HDMI jack” (page 15) when connecting equipment using the HDMI cable.

There is no picture/picture noise appears.

- ➔ Check that all the connecting cables are securely connected.
- ➔ Check whether the connecting cables are damaged.

- ➔ Check the connection to your TV (page 14) and switch the input selector on your TV so that the signal from the player appears on the TV screen.
- ➔ When playing a double-layer DVD, the video and audio may be momentarily interrupted at the point where the layers switch.

No picture appears when the video output resolution selected in “Output Video Format” is incorrect.

- ➔ Press ■ on the player for more than 10 seconds to reset the video output resolution to the lowest resolution.

The picture does not fill the screen, even though the aspect ratio is set in “DVD Aspect Ratio” under “Video Settings.”

- ➔ The aspect ratio of the disc is fixed on your DVD (page 42).

Video signals are not output from the jacks, other than from the HDMI OUT jack, when connecting the HDMI OUT jack and other video output jacks at the same time.

- ➔ Set “Output Video Format” to “Component Video” in the “Video Settings” setup (page 42).

The dark area of the picture is too dark/the bright area is too bright or unnatural.

- ➔ Set “Picture Quality Mode” to “Standard” (default) (see “Adjusting pictures and sound for videos” on page 34).

The picture is not output correctly.

- ➔ Check the “Output Video Format” settings in the “Video Settings” setup (page 42).

No BD-ROM picture appears.

- ➔ Check the “BD-ROM 1080/24p Output” setting in the “Video Settings” setup (page 43).

Sound

See also “Connecting to an HDMI jack” (page 20) when connecting equipment using the HDMI cable.

There is no sound.

- ➔ Check that all the connecting cables are securely connected.
- ➔ Check whether the connecting cables are damaged.
- ➔ Check the connection to your AV amplifier (receiver) (page 19) and switch the input selector on your AV amplifier (receiver) so that the audio signals of the player are output from your AV amplifier (receiver).
- ➔ The player is in scan mode.
- ➔ If the audio signal does not come through the DIGITAL OUT (OPTICAL/COAXIAL)/HDMI OUT jack, check the audio settings (page 44).

The sound is not output correctly.

- ➔ Check the “Audio Output Priority” setting in the “Audio Settings” setup (page 44).

The sound volume is low.

- ➔ The sound volume is low on some BDs or DVDs.
- ➔ Try setting “Audio DRC” to “TV Mode” in the “Audio Settings” setup (page 46).
- ➔ Set “Audio ATT” to “Off” in the “Audio Settings” setup (page 45).

The HD Audio (Dolby Digital Plus, Dolby TrueHD, DTS-HD High Resolution Audio, and DTS-HD Master Audio) is not output by bitstream.

- ➔ Set “BD Audio Setting” to “Direct” in the “Audio Settings” setup (page 45).
- ➔ Check that the connected AV amplifier (receiver) is compatible with each HD Audio format.

The interactive audio is not output.

- ➔ Set “BD Audio Setting” to “Mix” in the “Audio Settings” setup (page 45).

HDMI

There is no picture or no sound when connected to the HDMI OUT jack.

- ➔ Try the following: ① Turn the player off and on again. ② Turn the connected equipment off and on again. ③ Disconnect and then reconnect the HDMI cable.

There is no picture or picture noise appears when connected to the HDMI OUT jack.

- ➔ The HDMI OUT jack is connected to a DVI device that does not support copyright protection technology.
- ➔ If the HDMI OUT jack is used for video output, changing the video output resolution may solve the problem (page 42).

No sound is output from the HDMI OUT jack.

- ➔ The HDMI OUT jack is connected to a DVI device (DVI jacks do not accept audio signals).

The sound is not output correctly when connected to the HDMI OUT jack.

- ➔ The device connected to the HDMI OUT jack does not support the audio format of the player. Check the audio settings (page 44).

The display language on the screen switches automatically when connected to the HDMI OUT jack.

- ➔ When “Control for HDMI” is set to “On” (page 50), the display language on the screen automatically switches according to the language setting of the connected TV (if you change the setting on your TV, etc.).

The “Control for HDMI” function does not work (BRAVIA Sync).

- ➔ Check that the mains lead of the connected component is securely connected.
- ➔ If the HDMI indicator does not appear in the front panel display, check the HDMI connection (page 15, 20).
- ➔ Set “Control for HDMI” to “On” (page 50).

- ➔ Make sure that the connected component is compatible with the “Control for HDMI” function. For details, refer to the operating instructions supplied with the component.
- ➔ Check the connected component’s setting for the “Control for HDMI” function. For details, refer to the operating instructions supplied with the component.
- ➔ If you change the HDMI connection, turn the player off and on again.
- ➔ If power failure occurs, set “Control for HDMI” to “Off.” then set “Control for HDMI” to “On” (page 50).
- ➔ For details on the “Control for HDMI” function, see “About the BRAVIA Sync features (for HDMI connections only)” (page 16).
- ➔ If you connect the player to a TV through an AV amplifier (receiver) that is not compatible with the “Control for HDMI” function, you may be unable to control the TV from the player.

External memory (local storage)

The external memory is not recognised.

- ➔ Try the following: ① Turn the player off. ② Align the ▼ mark of the EXT slot with the ▼ mark on the external memory, and insert the external memory (page 23). ③ Turn the player on. ④ Check that the EXT indicator lights up in the front panel display.

Bonus contents or other data that are contained in a BD-ROM cannot be played.

- ➔ Try the following: ① Remove the disc. ② Turn the player off. ③ Remove and re-insert the external memory (page 23). ④ Turn the player on. ⑤ Check that the EXT indicator lights up in the front panel display. ⑥ Insert the BD-ROM with BonusView.

A message indicating that the local storage does not have enough space appears on the screen.

- ➔ Delete unnecessary data in the external memory (page 33).

Operation

The remote does not function.

- ➔ The batteries in the remote are weak (page 26).
- ➔ The distance between the remote and the player is too far.
- ➔ The remote is not pointed at the remote sensor on the player.

The file name is not correctly displayed.

- ➔ The player can only display ISO 8859-1-compliant character formats. Other character formats may be displayed differently.
- ➔ Depending on the writing software used, the input characters may be displayed differently.

The disc does not start playing from the beginning.

- ➔ Resume Play is on (page 31).

Some functions such as Stop or Search cannot be performed.

- ➔ Depending on the disc, you may not be able to do some of the operations above. Refer to the operating manual supplied with the disc.

The language for the soundtrack/subtitle or angles cannot be changed.

- ➔ Try using the BD's or DVD's menu instead of the direct selection button on the remote (page 32).
- ➔ Multi-lingual tracks/subtitles or multi-angles are not recorded on the BD or DVD being played.
- ➔ The BD or DVD prohibits the changing of the language for the sound track/subtitle or angles.

The disc tray does not open and "LOCKED" or "TLK ON" appears in the front panel display.

- ➔ When "LOCKED" appears, the player is locked. To cancel the Child Lock, hold down **II** on the player until "UNLOCK" appears in the front panel display (page 10).
- ➔ When "TLK ON" appears, contact your Sony dealer or local authorized Sony service facility.

The disc tray does not open and you cannot remove the disc even after you press **⏏**.

- ➔ Try the following: ① Turn the player off, and disconnect the mains lead. ② Reconnect the mains lead while pressing down **⏏** on the player. ③ Keep pressing down **⏏** on the player until the tray opens. ④ Remove the disc. ⑤ When "WAIT" appears in the front panel display, hold down **I/⏏** on the player for more than 10 seconds until the player turns on again.

The player does not respond to any button.

- ➔ Moisture has condensed inside the player (page 3).
- ➔ Hold down **I/⏏** on the player for more than 10 seconds until the indicators in the front panel display turn off. If the player still does not respond to any button, disconnect then reconnect the mains lead.

Self-Diagnosis Function

When the self-diagnosis function is activated to prevent the player from malfunctioning, an error code appears in the front panel display, or just  appears without any messages on the entire screen.

In these cases, check the following.

When an error code appears in the front panel display

Error code	Corrective action
Exxxx SYS ERR	Contact your nearest Sony dealer or local authorised Sony service facility and give the error code.
FAN ERR	<ul style="list-style-type: none">• Check that the ventilation holes on the rear of the player are not blocked.• Place the player in a location with adequate ventilation to prevent heat build-up in the player.

When just appears without any messages on the entire screen

Contact your nearest Sony dealer or local authorised Sony service facility.

Playable Discs

Type	Disc Logo	Icon used in this manual	Characteristics
Blu-ray Disc			BD-ROMs and BD-REs/BD-Rs in BDMV and BDAV mode, including 8 cm discs (single layer) and DL discs
DVD VIDEO			Discs such as movies that can be purchased or rented
DVD	  		DVD+RWs/DVD+Rs in +VR mode or DVD-RWs/DVD-Rs in video and VR mode, including 8 cm discs (single layer) and DVD+R DL/DVD-R DL discs
DATA DVD	DVD + ReWritable  DVD + R  DVD + R DL		DVD+RWs/DVD+Rs/DVD-RWs/DVD-Rs containing JPEG* image files
CD			Music CDs or CD-Rs/CD-RWs in music CD format
DATA CD	—		CD-Rs/CD-RWs containing JPEG* image files

* JPEG format conforming to UDF (Universal Disk Format).

Notes about BD-ROM compatibility

Since the Blu-ray Disc specifications are new and evolving, some discs may not be playable depending on the disc type and the version. The audio output differs depending on the source, connected output jack, and selected audio settings. For details, see page 63.

Discs that cannot be played

- BDs with cartridge
- DVD-RAMs
- HD DVDs
- DVD Audio discs
- PHOTO CDs
- Data part of CD-Extras
- VCDs/Super VCDs
- HD layer on Super Audio CDs
- BD-ROMs/DVD VIDEOS with a different region code (page 60).

Note on playback operations of BDs/DVDs

Some playback operations of BDs/DVDs may be intentionally set by software producers. Since this player plays BDs/DVDs according to the disc contents the software producers designed, some playback features may not be available. Refer to the instructions supplied with the BDs/DVDs.

Region code (BD-ROM/DVD VIDEO only)

Your player has a region code printed on the rear of the unit and will only play BD-ROMs/DVD VIDEOS (playback only) labelled with identical region codes. This system is used to protect copyrights.

DVD VIDEOS labelled  will also play on this player.

Depending on the BD-ROM/DVD VIDEO, no region code may be indicated even though playing the BD-ROM/DVD VIDEO is prohibited by area restrictions.



Notes about BD-REs/BD-Rs, DVD+RWs/DVD+Rs, DVD-RWs/DVD-Rs, or CD-Rs/CD-RWs

Some BD-REs/BD-Rs, DVD+RWs/DVD+Rs, DVD-RWs/DVD-Rs, or CD-Rs/CD-RWs cannot be played on this player due to the recording quality or physical condition of the disc, or the characteristics of the recording device and authoring software.

A DVD disc will not play if it has not been correctly finalised. For more information, refer to the operating instructions supplied with the recording device. Note that some playback functions may not work with some DVD+RWs/DVD+Rs, even if they have been correctly finalised. In this case, view the disc using normal playback.

Music discs encoded with copyright protection technologies

This product is designed to play back discs that conform to the Compact Disc (CD) standard. Various music discs encoded with copyright protection technologies are being marketed by some record companies. Please be aware that among those discs, there are some that do not conform to the CD standard and may not be playable by this product.

Note on DualDiscs

A DualDisc is a two sided disc product which mates DVD recorded material on one side with digital audio material on the other side.

However, since the audio material side does not conform to the Compact Disc (CD) standard, playback on this product is not guaranteed.

Note about double-layer DVDs

The playback pictures and sound may be momentarily interrupted when the layers switch.

Note about 8 cm BD-REs/8 cm BD-Rs

Some 8 cm BD-REs/8 cm BD-Rs cannot be played on this player.

Note about BD-REs/BD-Rs

This player supports Ver. 2.1 BD-RE and Ver. 1.1 and 1.2 BD-R including organic pigment type BD-R (LTH type).

Note about DTS 5.1 MUSIC DISCS

This player can play DTS 5.1 MUSIC DISCS.

Audio signals are output in the formats specified under the "Audio Output Signals" table on page 63.

About playback of discs recorded in AVCHD format

This player can play AVCHD format discs.



◆ What is the AVCHD format?

The AVCHD format is a high-definition digital video camera format used to record SD (standard definition) or HD (high definition) signals of either the 1080i specification^{*1} or the 720p specification^{*2} on DVDs, using efficient data compression coding technology. The MPEG-4 AVC/H.264 format is adopted to compress video data, and the Dolby Digital or Linear PCM system is used to compress audio data. The MPEG-4 AVC/H.264 format is capable of compressing images at higher efficiency than that of the conventional image compressing format. The MPEG-4 AVC/H.264 format enables a high definition (HD) video signal shot on a digital video camera recorder to be recorded on DVD discs, in the same way as it would be for a standard definition (SD) television signal.

^{*1} A high-definition specification which utilizes 1080 effective scanning lines and the interlace system.

^{*2} A high-definition specification which utilizes 720 effective scanning lines and the progressive system.



- Some AVCHD format discs may not play, depending on the recording condition.
- The AVCHD format disc will not play if it has not been correctly finalised.

Video Output Resolution

Output resolution differs depending on the “Output Video Format” setting in the “Video Settings” setup (page 41).

Resolution setting	When “Output Video Format” is set to “HDMI”			When “Output Video Format” is set to “Component Video”		
	LINE OUT VIDEO/S VIDEO jack	COMPONENT VIDEO jack	HDMI OUT jack	LINE OUT VIDEO/S VIDEO jack	COMPONENT VIDEO jack	HDMI OUT jack
480i/576i	480i/576i	480i/576i	480i/576i	480i/576i	480i/576i	480i/576i
480p/576p	480i/576i	480i/576i	480p/576p	480i/576i	480p/576p	480p/576p
720p	480i/576i	480i/576i	720p	480i/576i	720p*	720p*
1080i	480i/576i	480i/576i	1080i	480i/576i	1080i*	1080i*
1080p	no picture	no picture	1080p	unselectable	unselectable	unselectable

* Protected contents on DVDs are output at 480p/576p resolution. Protected contents on BDs are output at 576p resolution.

◆ When “Output Video Format” is set to “Video or S Video”

480i/576i video signals are output from the LINE OUT VIDEO/S VIDEO or COMPONENT VIDEO jack, and 480p/576p video signals are output from the HDMI OUT jack.

Audio Output Signals

The audio output differs as follows, depending on the source, output jack, and the selected settings.

Disc/source		Digital				Analogue
		HDMI OUT jack*2		DIGITAL OUT (OPTICAL/ COAXIAL) jacks*2		LINE OUT (R-AUDIO-L) jacks
		Auto*3	2ch PCM*3	Bitstream*4	PCM	
BD	LPCM 2ch	LPCM 2ch	LPCM 2ch	LPCM 2ch	LPCM 2ch	2ch
	LPCM 5.1ch	LPCM 5.1ch	LPCM 2ch	LPCM 2ch	LPCM 2ch	2ch
	LPCM 7.1ch	LPCM 7.1ch	LPCM 2ch	LPCM 2ch	LPCM 2ch	2ch
	Dolby Digital	LPCM 5.1ch*5	LPCM 2ch	Dolby Digital/ LPCM 2ch*6	LPCM 2ch	2ch
	Dolby Digital Plus	LPCM 7.1ch*5	LPCM 2ch	Dolby Digital/ LPCM 2ch*6	LPCM 2ch	2ch
	Dolby TrueHD	LPCM 7.1ch*5	LPCM 2ch	Dolby Digital/ LPCM 2ch*6	LPCM 2ch	2ch
	DTS	LPCM 5.1ch*5	LPCM 2ch	DTS/ LPCM 2ch*6	LPCM 2ch	2ch
	DTS-HD High Resolution Audio	LPCM 5.1ch*5 (DTS core)	LPCM 2ch	DTS/ LPCM 2ch*6	LPCM 2ch	2ch
	DTS-HD Master Audio	LPCM 5.1ch*5 (DTS core)	LPCM 2ch	DTS/ LPCM 2ch*6	LPCM 2ch	2ch
DVD	LPCM	LPCM 2ch	LPCM 2ch	LPCM 2ch	LPCM 2ch	2ch
	Dolby Digital	Dolby Digital	LPCM 2ch	Dolby Digital	LPCM 2ch	2ch
	DTS	DTS	LPCM 2ch	DTS	LPCM 2ch	2ch
	MPEG	LPCM 2ch	LPCM 2ch	LPCM 2ch	LPCM 2ch	2ch
CD	LPCM	LPCM	LPCM 2ch	LPCM 2ch	LPCM 2ch	2ch
DTS 5.1 MUSIC DISC		DTS	LPCM 2ch	DTS	LPCM 2ch	2ch

*1 When “Audio Output Priority” is set to “Stereo Analogue,” LPCM 2ch signals are output from each jack.

*2 When “Audio Output Priority” is set to “HDMI” or “Coaxial/Optical,” LPCM 2ch signals are output from jacks other than the selected jack.

*3 Auto: when “Audio (HDMI)” is set to “Auto” in the “Audio Settings” setup (page 44).
2ch PCM: when “Audio (HDMI)” is set to “2ch PCM” in the “Audio Settings” setup (page 44).

*4 Bitstream: when “Dolby Digital” is set to “Dolby Digital” or “DTS” is set to “DTS” in the “Audio Settings” setup (page 44).

*5 When “BD Audio Setting” is set to “Direct,” audio recorded by the source is output by bitstream. However, this audio may be output as follows depending on the audio formats supported by the AV amplifier (receiver).

- When the AV amplifier (receiver) does not support HD Audio (Dolby Digital Plus, Dolby TrueHD, DTS-HD High Resolution Audio and DTS-HD Master Audio) but supports Multi-ch LPCM, up to LPCM 7.1ch is output.

– When the AV amplifier (receiver) does not support HD Audio or Multi-ch LPCM but supports Dolby Digital/DTS, a Dolby Digital or DTS bitstream is output.

– When the AV amplifier (receiver) does not support HD Audio, Multi-ch LPCM or Dolby Digital/DTS, LPCM 2ch is output.

*6 The 2-channel or less-channel primary/ secondary audio signals are output as LPCM 2ch signals.



When outputting 480i/576i or 480p/576p video signals from the HDMI OUT jack, Dolby TrueHD and DTS-HD Master Audio are output as LPCM, Dolby Digital, or DTS bitstream signals even if “BD Audio Setting” is set to “Direct” in the “Audio Settings” setup (page 45).

Specifications

System

Laser: Semiconductor laser

Inputs and outputs

(Jack name:

Jack type/Output level/Load impedance)

LINE OUT R-AUDIO-L:

Phono jack/2 V_{rms}/10 kilohms

DIGITAL OUT (OPTICAL):

Optical output jack/-18 dBm

(wave length 660 nm)

DIGITAL OUT (COAXIAL):

Phono jack/0.5 V_{p-p}/75 ohms

HDMI OUT:

HDMI 19-pin standard connector

COMPONENT VIDEO OUT

(Y, P_B/C_B, P_R/C_R):

Phono jack/Y: 1.0 V_{p-p}/

P_B/C_B, P_R/C_R: 0.7 V_{p-p}/75 ohms

LINE OUT VIDEO:

Phono jack/1.0 V_{p-p}/75 ohms

LINE OUT S VIDEO:

4-pin mini DIN/

Y: 1.0 V_{p-p}, C: 0.3 V_{p-p}/75 ohms

LAN (100):

100BASE-TX Terminal

EXT:

External memory slot (For connecting the external memory)

DC output: 5 V 500 mA Max

General

Power requirements:

220-240 V AC, 50/60 Hz

Power consumption:

26 W

Dimensions (approx.):

430 mm × 220 mm × 60 mm

(width/depth/height) incl. projecting parts

Mass (approx.):

2.9 kg

Operating temperature:

5 °C to 35 °C

Operating humidity:

25 % to 80 %

Supplied accessories

See page 13.

Specifications and design are subject to change without notice.

Language Code List

For details, see page 47.

The language spellings conform to the ISO 639: 1988 (E/F) standard.

Number, Language (BD Language Code/DVD Language Code)

1027, Afar (aar/aa)	1194, Galician (glg/gl)	1350, Malayalam (mal/ml)	1506, Slovenian (slv/sl)
1028, Abkhazian (abk/ab)	1196, Guarani (grn/gn)	1352, Mongolian (mon/mn)	1507, Samoan (smo/sm)
1032, Afrikaans (af/af)	1203, Gujarati (gu/gu)	1353, Moldavian (mol/mo)	1508, Shona (sna/sn)
1039, Amharic (amh/am)	1209, Hausa (hau/ha)	1356, Marathi (mar/mr)	1509, Somali (som/so)
1044, Arabic (ara/ar)	1217, Hindi (hin/hi)	1357, Malay (msa/ms)	1511, Albanian (sqi/sq)
1045, Assamese (asm/as)	1226, Croatian (hrv/hr)	1358, Malese; Maltese (mlt/mt)	1512, Serbian (srp/sr)
1051, Aymara (aym/ay)	1229, Hungarian (hun/hu)	1363, Burmese (mya/my)	1513, Siswati; Swati (ssw/ss)
1052, Azerbaijani (aze/az)	1233, Armenian (hye/hy)	1365, Nauru (nau/na)	1514, Sesotho; Sotho southern (sot/st)
1053, Bashkir (bak/ba)	1235, Interlingua (ina/ia)	1369, Nepali (nep/ne)	1515, Sundanese (sun/su)
1057, Byelorussian (bel/be)	1239, Interlingue (ile/ie)	1376, Dutch (nld/nl)	1516, Swedish (swe/sv)
1059, Bulgarian (bul/bg)	1245, Inupiak (ipk/ik)	1379, Norwegian (nor/no)	1517, Swahili (swa/sw)
1060, Bihari (bih/bh)	1248, Indonesian (ind/id)	1393, Occitan (oci/oc)	1521, Tamil (tam/ta)
1061, Bislama (bis/bi)	1253, Icelandic (isl/is)	1403, Oromo (orm/om)	1525, Telugu (tel/te)
1066, Bengali (ben/bn)	1254, Italian (ita/it)	1408, Oriya (ori/or)	1527, Tajik (tgk/tg)
1067, Tibetan (bod/bo)	1257, Hebrew (heb/he)	1417, Punjabi; Panjabi (pan/pa)	1528, Thai (tha/th)
1070, Breton (bre/br)	1261, Japanese (jpn/ja)	1428, Polish (pol/pl)	1529, Tigrinya (tir/ti)
1079, Catalan (cat/ca)	1269, Yiddish (yid/yi)	1435, Pashto; Pushto (pus/ps)	1531, Turkmen (tuk/tk)
1093, Corsican (cos/co)	1283, Javanese (jav/jv)	1436, Portuguese (por/pt)	1532, Tagalog (tgl/tl)
1097, Czech (ces/cs)	1287, Georgian (kat/ka)	1463, Quechua (que/qu)	1534, Setswana; Tswana (tsn/tn)
1103, Welsh (cym/cy)	1297, Kazakh (kaz/kk)	1481, Rhaeto-Romance (roh/rm)	1535, Tonga; Tonga islands (ton/to)
1105, Danish (dan/da)	1298, Greenlandic; Kalaallisut (kal/kl)	1482, Kirundi; Rundi (run/rn)	1538, Turkish (tur/tr)
1109, German (deu/de)	1299, Cambodian; Khmer (khm/km)	1483, Romanian (ron/ro)	1539, Tsonga (tso/ts)
1130, Bhutani; Dzongkha (dzo/dz)	1300, Kannada (kan/kn)	1489, Russian (rus/ru)	1540, Tatar (tat/tt)
1142, Greek (ell/el)	1301, Korean (kor/ko)	1491, Kinyarwanda (kin/rw)	1543, Twi (twi/tw)
1144, English (eng/en)	1305, Kashmiri (kas/ks)	1495, Sanskrit (san/sa)	1557, Ukrainian (ukr/uk)
1145, Esperanto (epo/eo)	1307, Kurdish (kur/ku)	1498, Sindhi (snd/sd)	1564, Urdu (urd/ur)
1149, Spanish (spa/es)	1311, Kirghiz (kir/ky)	1501, Sangho; Sango (sag/sg)	1572, Uzbek (uzb/uz)
1150, Estonian (est/et)	1313, Latin (lat/la)	1502, Serbo-Croatian (scr/hr)	1581, Vietnamese (vie/vi)
1151, Basque (eus/eu)	1326, Lingala (lin/ln)	1503, Sinhalese; Sinhalese (sin/si)	1587, Volapük (vol/vo)
1157, Persian (fas/fa)	1327, Laothian; Lao (lao/lo)	1505, Slovak (slk/sk)	1613, Wolof (wol/wo)
1165, Finnish (fin/fi)	1332, Lithuanian (lit/lt)		1632, Xhosa (xho/xh)
1166, Fiji (fij/fj)	1334, Latvian (lav/lv)		1665, Yoruba (yor/yo)
1171, Faroese (fao/fo)	1345, Malagasy (mlg/mg)		1684, Chinese (zho/zh)
1174, French (fra/fr)	1347, Maori (mri/mi)		1697, Zulu (zul/zu)
1181, Frisian (fry/fy)	1349, Macedonian (mkd/mk)		1703, not specified
1183, Irish (gle/ga)			
1186, Scots Gaelic (gla/gd)			

Parental Control/Area Code

For details, see page 47.

Number, Area (Code)

2044, Argentina (ar)	2200, Greece (gr)	2379, Norway (no)
2047, Australia (au)	2219, Hong Kong (hk)	2427, Pakistan (pk)
2046, Austria (at)	2248, India (in)	2424, Philippines (ph)
2057, Belgium (be)	2238, Indonesia (id)	2428, Poland (pl)
2070, Brazil (br)	2239, Ireland (ie)	2436, Portugal (pt)
2079, Canada (ca)	2254, Italy (it)	2489, Russia (ru)
2090, Chile (cl)	2276, Japan (jp)	2501, Singapore (sg)
2092, China (cn)	2304, Korea (kr)	2149, Spain (es)
2093, Colombia (co)	2333, Luxembourg (lu)	2499, Sweden (se)
2115, Denmark (dk)	2363, Malaysia (my)	2086, Switzerland (ch)
2165, Finland (fi)	2362, Mexico (mx)	2543, Taiwan (tw)
2174, France (fr)	2376, Netherlands (nl)	2528, Thailand (th)
2109, Germany (de)	2390, New Zealand (nz)	2184, United Kingdom (gb)

Terms and Conditions of Use and End User License Agreement

The Sony Blu-ray Disc player ("Product") and associated software ("Software") are provided and maintained by Sony Corporation and its affiliates ("Sony"). Sony also provides and maintains associated service (the "Service"), including any subsite accessible through the Service's Internet homepage (the "Site"). The Software includes software embedded in the Product; stored on any media, bundled with the Product or otherwise provided by Sony; downloaded from the Site or otherwise made accessible or provided by Sony; any such media and any printed or "on-line" or electronic documentation associated with the Product and all updates and upgrades thereto.

WHEN YOU ACCESS, BROWSE, OR USE THE SERVICE, PRODUCT, SOFTWARE, AND/OR SITE, YOU ACCEPT, WITHOUT LIMITATION OR QUALIFICATION, THE TERMS AND CONDITIONS SET FORTH HEREIN, SONY'S PRIVACY POLICY POSTED ON THE SITE, AND ANY ADDITIONAL TERMS AND CONDITIONS OF USE SET FORTH IN ANY PORTION OF THE SERVICE AND SITE (COLLECTIVELY THE "AGREEMENT"). IF YOU DO NOT AGREE WITH THE TERMS AND CONDITIONS OF THIS AGREEMENT, SONY DOES NOT GRANT THE LIMITED RIGHTS HEREIN, AND PLEASE DO NOT USE THE SERVICE, PRODUCT, SOFTWARE, AND/OR SITE.

1. Ownership

The Software and all materials on the Service and/or Site, including but not limited to images, software and text (the "Content") are protected by copyright under copyright law and international conventions. You cannot use the Software, Service, Product, Content, and Site except as specified herein. There may be proprietary logos, service marks, and trademarks found on this Service or Site. By making them available on the Service and/or Site, Sony is not granting you any license to utilize those proprietary logos, service marks, or trademarks. Any unauthorized use of the Service, Site, Content or Software may violate copyright laws, trademark laws, the laws of privacy and publicity, and civil and criminal statutes. All title and copyright in and to the Software or materials on the Service/Site and any copies of the Software, are owned by Sony, its licensors, or suppliers. All rights not specifically granted under this Agreement are reserved by Sony, its licensors, and suppliers.

2. Your Rights & Limited License

The Service, Site, Software, Content, and Product are only for your personal use. You are responsible for all your activities hereunder, including all legal liability incurred from your use of the Service or others who use the Service via your Product. You may use the Service, Site, Software, Content and Product for lawful purposes only. You may not distribute, exchange, modify, sell, or transmit anything you may copy from the Service or Site, including but not limited to any text, images, audio, and video, for any business, commercial, or public purpose. As long as you comply with the terms of this Agreement, Sony grants you a non-exclusive, non-transferable, limited right to enter, display, and use the Service, Site, and Software as set forth in this Agreement. You agree not to interrupt/disrupt or attempt to interrupt/disrupt the operation of this Service, Site or Software in any way.

3. Automatic Update

The Software contains a functionality by which it is updated automatically when the Product is connected to a server belonging to Sony or to a third party designated by Sony. When you specify your intention not to use this automatic update functionality, or when the setting asking whether you wish to update automatically is activated and you decline to execute updates, it is assumed that you agree that the security functionality improvements, error corrections, other functional updates or any other changes offered by Sony through such updates would not be made to the Software and that your current and further use of the Software may be affected thereby.

When the automatic update functionality described in the previous paragraph is activated, it is assumed that you agree (a) that the Software will be automatically updated as necessary to improve security functionality, to correct errors, to improve update functionality, or for other purposes, and (b) that this updating of the Software may be accompanied by the augmenting, modifying, or removing of functionality of the Software.

4. Additional Terms Governing Product Software

You may use the Software solely in conjunction with the Product that accompanied the Software. The Software is licensed, not sold. In addition to the terms set forth in other portions of this Agreement, the Software is subject to the following:

Use of Software. You may use the Software in conjunction with the Product for personal use.

Limitation on Reverse Engineering, Decompilation and

Disassembly. You may not modify, reverse engineer, decompile, or disassemble the Software in whole or in part. **Separation of Components.** The Software is licensed as a single product. Its component parts may not be separated for use on more than one device unless expressly authorized by Sony.

Data Files. The Software may create data files automatically for use with the Software. Any such data files will be deemed as part of the Software.

Rental. You may not rent or lease the Software.

Software Transfer. You may permanently transfer all of your rights under this Agreement only as part of a sale or transfer of Software accompanying the sale or transfer of your Product, provided you retain no copies, transfer all of the Software (including all copies, component parts, the media and printed materials, all versions and any upgrades of the Software and this Agreement), and the recipient agrees to the terms of this Agreement.

Dependent Software. The software, network services or other products other than Software upon which the Software's performance depends on might be interrupted or discontinued at the discretion of the suppliers (software suppliers, service providers or Sony).

High Risk Activities. The Software is not fault-tolerant and is not designed, manufactured or intended for use or resale as on-line control equipment in hazardous environments requiring fail-safe performance, such as in the operation of nuclear facilities, aircraft navigation or communication systems, air traffic control, direct life support machines, or weapons systems, in which the failure of the Software could lead to death, personal injury, or severe physical or environmental damage ("High Risk Activities"). Sony and its suppliers specifically disclaim any express or implied warranty of fitness for High Risk Activities.

GNU General Public, Lesser General Public, & Other Licenses.

Notwithstanding terms in this Agreement, certain portions of the Software are governed by the GNU Lesser General Public License, Version 2.1 (LGPL), GNU General Public License Version 2 (GPL), and other open source code licenses ("Open Source Licenses"), copies of which are attached hereto and incorporated herein. For such portions of the Software, to the extent there is any conflict between this Agreement and the Open Source Licenses, the Open Source Licenses shall govern as applicable.

Certain Source Code Availability. Sony is making available the source code of certain portions of the SOFTWARE per the GPL/LGPL LICENSES. Please see <http://www.sony.com/linux> for access to and instructions on obtaining such source code.

5. Changes to Service

Sony reserves the right to discontinue one, some, or all of the features of the Service you receive at any time at its discretion. Sony may, at its discretion and from time to time change, add or remove features and functionality, upgrade or modify the Service, Site and/or Software without notice. You may, at Sony's discretion, receive messages regarding these changes and new features/functionality. Any new text, content, file, data, product, services, information, software, software tool or other feature provided by Sony (through the network or by CD-ROM or other means)(including, but not limited to, any update to Software provided to you automatically pursuant to Section 3 of this Agreement) will be subject to this Agreement; provided that, if separate terms and conditions applicable to such feature are provided to you, such terms and conditions shall apply to such feature in priority to this Agreement.

6. Confidentiality

You shall maintain the confidentiality of any information with regard to the Product and Documentation that is provided under this Agreement and is not publicly known. You agree not to disclose such information to any third party without the prior written consent.

7. Export Control

You agree not to export from anywhere the Software or thereof provided to you except in compliance with, and with all licences and approvals required under, applicable export laws, rules and regulations.

8. Sony's Right to Terminate or Modify Terms or Conditions of this Agreement

Sony may add to, change, or remove any part, term, or condition of this Agreement at any time, without prior notice. Any changes to this Agreement or any terms posted on the Service and/or Site apply as soon as they are posted. By continuing to use the Service, Product, Software and/or Site after any changes are posted, you are indicating your acceptance of those changes. SONY MAY ADD, CHANGE, DISCONTINUE, REMOVE, OR SUSPEND ANY OTHER CONTENT POSTED ON THE SERVICE AND/OR SITE, INCLUDING FEATURES AND SPECIFICATIONS OF PRODUCTS DESCRIBED OR DEPICTED ON THE SERVICE AND/OR SITE, TEMPORARILY OR PERMANENTLY, AT ANY TIME, WITHOUT NOTICE AND WITHOUT LIABILITY. WITHOUT PREJUDICE TO ANY OTHER RIGHTS, SONY MAY SUSPEND OR TERMINATE THIS AGREEMENT IMMEDIATELY UPON NOTICE IF YOU FAIL TO COMPLY WITH THE TERMS AND CONDITIONS OF THIS AGREEMENT. Upon termination, you shall destroy the Software within fourteen (14) days after the date of such termination, and upon Sony's request, provide Sony with the certification of such destruction. Sony may take any legal and technical remedies to prevent the violation of and/or to enforce this Agreement, including without limitation, immediate termination of your access to the Service if we believe in our discretion you are violating this Agreement.

9. Indemnification

You agree to indemnify, defend, and hold Sony and all of its agents, directors, employees, information providers, licensors and licensees, affiliates, content providers, officers, and parent (collectively, "Indemnified Parties"), harmless from and against any and all liability and costs (including, without limitation, attorneys' fees and costs), incurred by the Indemnified Parties in connection with any claim arising out of (i) any breach or alleged breach by you of this Agreement in any manner, (ii) any information you submit to Sony hereunder, (iii) any breach or alleged breach by you of a third party's rights or (iv) any damage caused by or alleged to have been caused by you to the Service. You will cooperate as fully as reasonably required in Indemnified Party(s) defense of any claim. Sony and/or Indemnified Parties reserve the right, at its own expense, to assume the exclusive defense and control of any matter otherwise subject to indemnification by you and you shall not in any event settle any matter without the written consent of Sony and/or Indemnified Parties.

10. DISCLAIMER OF WARRANTIES AND DAMAGES; LIMITATION OF LIABILITY

YOU UNDERSTAND THAT USAGE OF THE PRODUCT AND SERVICE REQUIRES INTERNET SERVICE PROVIDED BY YOU, FOR WHICH YOU ARE SOLELY RESPONSIBLE. OPERATION OF THE PRODUCT AND/OR SERVICE MAY BE LIMITED OR RESTRICTED DEPENDING UPON THE CAPABILITIES OR TECHNICAL LIMITATIONS OF YOUR INTERNET SERVICE.

YOUR USE OF THE SOFTWARE, SERVICE, PRODUCT, CONTENT AND/OR SITE IS AT YOUR OWN RISK. THE SOFTWARE, SERVICE, CONTENT AND SITE ARE PROVIDED "AS IS" AND, TO THE FULLEST EXTENT PERMISSIBLE BY LAW, SONY MAKES NO REPRESENTATIONS OR WARRANTIES OF ANY KIND WHATSOEVER (1) FOR THE ACCURACY, MERCHANTABILITY, FITNESS FOR A PARTICULAR PURPOSE, OR NON-INFRINGEMENT ASSOCIATED WITH THE SERVICE, SITE, AND/OR SOFTWARE; (2) THAT THE SERVER(S) THAT MAKES THE SERVICE, SOFTWARE, AND/OR SITE AVAILABLE ARE FREE OF VIRUSES OR OTHER COMPONENTS THAT MAY INFECT, HARM, OR CAUSE DAMAGE TO YOUR COMPUTER, TELEVISION, OTHER EQUIPMENT, OR ANY OTHER PROPERTY. FURTHERMORE, SONY DOES NOT WARRANT OR MAKE ANY REPRESENTATIONS REGARDING THE USE OR THE RESULTS OF THE USE OF THE SOFTWARE, SERVICE, AND/OR SITE IN TERMS OF ITS CORRECTNESS, ACCURACY, RELIABILITY, OR OTHERWISE. NO ORAL OR WRITTEN INFORMATION OR ADVICE GIVEN BY SONY OR A SONY AUTHORIZED REPRESENTATIVE SHALL CREATE A WARRANTY OR IN ANY WAY INCREASE THE SCOPE OF THIS WARRANTY. SHOULD THE SOFTWARE, SERVICE, AND/OR SITE PROVE DEFECTIVE YOU (AND NOT SONY OR A SONY AUTHORIZED REPRESENTATIVE) ASSUME THE ENTIRE COST OF ALL NECESSARY SERVICING, REPAIR OR CORRECTION.

UNDER NO CIRCUMSTANCES, INCLUDING BUT NOT LIMITED TO SONY'S NEGLIGENCE OR ISSUES RELATED TO THIRD PARTY CONTENT PROVIDERS, SHALL SONY BE LIABLE FOR ANY CONSEQUENTIAL, DIRECT, INCIDENTAL, INDIRECT, PUNITIVE, OR SPECIAL DAMAGES RELATED TO (A) THE USE OF, (B) THE INABILITY TO USE, OR (C) ERRORS OR OMISSIONS IN THE SOFTWARE, SERVICE, PRODUCT, AND/OR SITE, EVEN IF SONY OR AN AUTHORIZED REPRESENTATIVE THEREOF HAS BEEN ADVISED OF THE POSSIBILITY OF SUCH DAMAGES. SOME STATES DO NOT ALLOW THE EXCLUSION OR LIMITATION OF CONSEQUENTIAL OR INCIDENTAL DAMAGES, SO THE ABOVE LIMITATION OR EXCLUSION MAY NOT APPLY TO YOU. IN NO EVENT SHALL SONY'S TOTAL LIABILITY TO YOU FOR ALL DAMAGES, LOSSES, AND CAUSES OF ACTION (WHETHER IN CONTRACT OR TORT, INCLUDING, BUT NOT LIMITED TO, NEGLIGENCE OR OTHERWISE) EXCEED THE AMOUNT PAID FOR THE PRODUCT.

SOME STATES, TERRITORIES AND COUNTRIES DO NOT ALLOW CERTAIN WARRANTY EXCLUSIONS, SO TO THAT EXTENT THE ABOVE DISCLAIMER AND LIMITATION OF LIABILITY MAY NOT APPLY TO YOU.

THE TERMS OF THIS DISCLAIMER DO NOT AFFECT OR PREJUDICE YOUR STATUTORY RIGHTS AS CONSUMER, NEITHER DO THEY LIMIT OR EXCLUDE ANY LIABILITY FOR DEATH OR PERSONAL INJURY CAUSED BY THE NEGLIGENCE OF SONY OR ANY OTHER LIABILITY IF AND TO THE EXTENT THAT IT CANNOT BE LIMITED OR EXCLUDED BY APPLICABLE LAW.

11. General Provisions

This Agreement, the limited warranty accompanying the Product, plus any additional terms posted on the Service or Site, together constitute the entire agreement between Sony and you with respect to your use of the Product, Service, Site, Content, and Software. Any notice by Sony hereunder may be made by letter, email, or posting on the Service or Site. Any cause of action you may have with respect to your use of this Site must be commenced within one (1) year after the claim or cause of action arises. If for any reason a court of competent jurisdiction finds any provision of this Agreement, or portion thereof, to be unenforceable, that provision shall be enforced to the maximum extent permissible so as to affect the intent of this Agreement, and the remaining terms and conditions of the Agreement shall continue in full force and effect. This Agreement shall be governed by and construed in accordance with the laws of Japan.

Glossary

AACS

“Advanced Access Content System” is a specification for managing digital entertainment contents stored on the next generation of prerecorded and recorded optical media. The specification enables consumers to enjoy digital entertainment content, including high-definition content.

AVCHD (page 61)

The AVCHD format is a high definition digital video camera format used to record SD (standard definition) or HD (high definition) signals of either the 1080i specification*1 or the 720p specification*2 on DVDs, using efficient data compression coding technology. The MPEG-4 AVC/H.264 format is adopted to compress video data, and the Dolby Digital or Linear PCM is used to compress audio data. The MPEG-4 AVC/H.264 format is capable of compressing images at higher efficiency than that of the conventional image compression format. The MPEG-4 AVC/H.264 format enables a high definition (HD) video signal shot on a digital video camera recorder to be recorded on DVDs in the same way as for a standard definition (SD) television signal.

*1 A high definition specification that utilises 1080 effective scanning lines and the interlace format.

*2 A high definition specification that utilises 720 effective scanning lines and the progressive format.

BD-J application

The BD-ROM format supports Java for interactive functions.

“BD-J” offers content providers almost unlimited functionality when creating interactive BD-ROM titles.

BD-R (page 59)

BD-R (Blu-ray Disc Recordable) is a recordable, write-once Blu-ray Disc, available in the same capacities as the BD below. Since contents can be recorded and cannot be overwritten, a BD-R can be used to archive valuable data or storing and distributing video material.

BD-RE (page 59)

BD-RE (Blu-ray Disc Rewritable) is a recordable and rewritable Blu-ray Disc, available in the same capacities as the BD below. The re-recordable feature makes extensive editing and time-shifting applications possible.

BD-ROM (page 59)

BD-ROMs (Blu-ray Disc Read-Only Memory) are commercially produced discs and are available in the same capacities as the BD below. Other than conventional movie and video contents, these discs have enhanced features such as interactive content, menu operations using pop-up menus, selection of subtitle display, and slideshow. Although a BD-ROM may contain any form of data, most BD-ROM discs will contain movies in High Definition format, for playback on Blu-ray Disc/DVD players.

Blu-ray Disc (BD) (page 59)

A disc format developed for recording/playing high-definition (HD) video (for HDTV, etc.), and for storing large amounts of data. A single layer Blu-ray Disc holds up to 25 GB, and a dual-layer Blu-ray Disc holds up to 50 GB of data.

Dolby Digital Plus (page 63)

Developed as an extension to Dolby Digital, the audio coding technology supports 7.1 multi-channel surround sound.

Dolby TrueHD (page 63)

Dolby TrueHD is a lossless coding technology that supports up to 8 channels of multi-channel surround sound for the next generation optical discs. The reproduced sound is true to the original source bit-for-bit.

DTS-HD High Resolution Audio (page 63)

Developed as an extension to DTS Digital Surround format. It supports a maximum sampling frequency of 96 kHz, and 7.1 multi-channel surround.

DTS-HD High Resolution Audio has a maximum transmission rate of 6 Mbps, with lossy compression (Lossy).

DTS-HD Master Audio (page 63)

DTS-HD Master Audio has a maximum transmission rate of 24.5 Mbps, and uses lossless compression (Lossless), and DTS-HD Master Audio corresponds to a maximum sampling frequency of 192 kHz, and maximum of 7.1ch.

HDMI (High-Definition Multimedia Interface) (page 15)

HDMI is an interface that supports both video and audio on a single digital connection. The HDMI connection carries standard- to high-definition video signals and multi-channel audio signals to AV components such as HDMI equipped TVs, in digital form without degradation.

The HDMI specification supports HDCP (High-bandwidth Digital Contents Protection), a copy protection technology for digital entertainment contents for HDMI.

LTH (Low to High) (page 60)

LTH is a recording system that supports organic pigment type BD-R.

PhotoTV HD (page 38)

“PhotoTV HD” allows for a highly-detailed pictures, and photo-like expression of subtle textures and colours. By connecting Sony “PhotoTV HD” compatible devices using an HDMI cable, whole new world of photos can be enjoyed in breathtaking Full HD quality. For instance, the delicate texture of the human skin, flowers, sand and waves can now be displayed on a large screen in beautiful photo-like quality.

Pop-up menu (page 32)

An enhanced menu operation available on BD-ROMs. The pop-up menu appears when POP UP/MENU is pressed during playback, and can be operated while playback is in progress.

x.v.Colour (page 44)

x.v.Colour is a familiar term for the xvYCC standard proposed by Sony.

xvYCC is an international standard for Colour space in video.

This standard can express a wider colour range than the currently used broadcast standard.

24p True Cinema (page 43)

Movies shot with a film camera consist of 24 frames per second.

Since conventional televisions (both CRT and flat panels) display frames either at 1/60 or 1/50 second intervals, the 24 frames do not appear at an even pace.

When connected to a TV with 24p capabilities, the player displays each frame at 1/24 second intervals — the same interval originally shot with the film camera, thus faithfully reproducing the original cinema image.

Index

Words in quotations appear in the on-screen displays.

Numerics

24p True Cinema 69

A

“A/V Settings” 34
AACs 68
ANGLE 8
AUDIO 8
“Audio Output Priority” 44
Audio output signals 63
“Audio Settings” 35, 44
AVCHD 61, 68

B

Batteries 26
“BD Data” 33, 56
“BD/DVD Viewing Settings” 47
BD-R 59, 68
BD-RE 59, 68
Bitstream 63
Blu-ray Disc 59, 68
BonusView 23, 32
BRAVIA Sync 16, 56

C

CD 59
Chapter 33
Child Lock 10, 57
Colour buttons 9
Connecting
 AV amplifier (receiver) 19
 TV 14
“Control for HDMI” 16, 31, 50, 56

D

“Dimmer” 50
Disc information 34
Disc Lock 31
DISPLAY 8
Dolby Digital 21, 45
Dolby Digital Plus 63, 68
Dolby TrueHD 63, 69
DTS 21, 45
DTS-HD 63, 69
DVD 59

E

Easy Setup 27, 53
Enter characters 52
External memory 23, 32, 56

F

Front panel display 11

H

HDMI 15, 20, 28, 42, 44, 56, 69
HOME 9
Home menu 36, 37, 39

L

Language Follow 16
Local storage 23, 32, 56
LTH 69

M

“Music” 36

N

“Network Diagnostic” 51
“Network Settings” 51
“Network Update” 24, 40

O

One-Touch Play 16, 31
OPTIONS 9, 32, 36, 37
“OSD” 50

P

Parental Control 31, 47
“Photo” 37
“Photo Settings” 49
PhotoTV HD 38, 69
Playable discs 59
POP UP/MENU 9, 32

Q

“Quick Start” 50

R

Region code 60
Remote 8, 26, 27
“Resetting” 53
Resetting the player 53
Resume 9, 31, 36

S

SCENE SEARCH 9
Searching 33
Self-diagnosis function 58
“Setup” 39
Slideshow 37
Software update 24, 40, 50
“Standby Mode” 50
SUBTITLE 8
System Power-Off 16
“System Settings” 50

T

THEATRE 8, 16
Title 33
TOP MENU 9
Troubleshooting 54
“TV Type” 41

U

Update 24, 40

V

“Video” 30
Video output resolution 62
“Video Settings” 34, 41

X

x.v.Colour 44, 69

Free Manuals Download Website

<http://myh66.com>

<http://usermanuals.us>

<http://www.somanuals.com>

<http://www.4manuals.cc>

<http://www.manual-lib.com>

<http://www.404manual.com>

<http://www.luxmanual.com>

<http://aubethermostatmanual.com>

Golf course search by state

<http://golfingnear.com>

Email search by domain

<http://emailbydomain.com>

Auto manuals search

<http://auto.somanuals.com>

TV manuals search

<http://tv.somanuals.com>