

Portable Blu-ray Disc™ / DVD Player

Operating Instructions

Preparations

Playback

Settings and Adjustments

Additional Information



WARNING

To reduce the risk of fire or electric shock, do not expose this apparatus to rain or moisture.

To avoid electrical shock, do not open the cabinet. Refer servicing to qualified personnel only.

The AC power cord must be changed only at a qualified service shop.

Batteries or batteries installed apparatus shall not be exposed to excessive heat such as sunshine, fire or the like.

CAUTION

The use of optical instruments with this product will increase eye hazard. As the laser beam used in this Blu-ray Disc/DVD player is harmful to eyes, do not attempt to disassemble the cabinet. Refer servicing to qualified personnel only.

CAUTION CLASS 3R VISIBLE AND INVISIBLE LASER RADIATION WHEN OPEN AND INTERLOCKS DEFEATED. AVOID DIRECT EYE EXPOSURE.

This label is located on the bottom of the unit.



This symbol is intended to alert the user to the presence of uninsulated "dangerous voltage" within the product's enclosure that may be of sufficient magnitude to constitute a risk of electric shock to persons.



This symbol is intended to alert the user to the presence of important operating and maintenance (servicing) instructions in the literature accompanying the appliance.

Precautions

- To prevent fire or shock hazard, do not place objects filled with liquids, such as vases, on the apparatus.

- Install this unit so that the AC power cord can be unplugged from the wall socket immediately in the event of trouble.
- The player is not disconnected from the AC power source as long as it is connected to the wall outlet, even if the player itself has been turned off.

FCC WARNING

You are cautioned that any changes or modifications not expressly approved in this manual could void your authority to operate this equipment.



This equipment has been tested and found to comply with the limits for a Class B digital device, pursuant to Part 15 of the FCC Rules. These limits are designed to provide reasonable protection against harmful interference in a residential installation. This equipment generates, uses, and can radiate radio frequency energy and, if not installed and used in accordance with the instructions, may cause harmful interference to radio communications. However, there is no guarantee that interference will not occur in a particular installation. If this equipment does cause harmful interference to radio or television reception, which can be determined by turning the equipment off and on, the user is encouraged to try to correct the interference by one or more of the following measures:

- Reorient or relocate the receiving antenna.
- Increase the separation between the equipment and receiver.
- Connect the equipment into an outlet on a circuit different from that to which the receiver is connected.
- Consult the dealer or an experienced radio/TV technician for help.

Owner's Record

The model and serial numbers are located at the bottom of the unit. Record the serial number in the space provided below. Refer to them whenever you call upon your Sony dealer regarding this product.

Model No. _____

Serial No. _____

If this product is not working properly, please call 1-866-909-7669.

Important Safety Instructions

- 1) Read these instructions.
- 2) Keep these instructions.
- 3) Heed all warnings.
- 4) Follow all instructions.
- 5) Do not use this apparatus near water.
- 6) Clean only with dry cloth.
- 7) Do not block any ventilation openings. Install in accordance with the manufacturer's instructions.
- 8) Do not install near any heat sources such as radiators, heat registers, stoves, or other apparatus (including amplifiers) that produce heat.
- 9) Do not defeat the safety purpose of the polarized or grounding-type plug. A polarized plug has two blades with one wider than the other. A grounding type plug has two blades and a third grounding prong. The wide blade or the third prong are provided for your safety. If the provided plug does not fit into your outlet, consult an electrician for replacement of the obsolete outlet.
- 10) Protect the power cord from being walked on or pinched particularly at plugs, convenience receptacles, and the point where they exit from the apparatus.
- 11) Only use attachments/accessories specified by the manufacturer.
- 12) Use only with the cart, stand, tripod, bracket, or table specified by the manufacturer, or sold with the apparatus. When a cart is used, use caution when moving the cart/apparatus combination to avoid injury from tip-over.



- 13) Unplug this apparatus during lightning storms or when unused for long periods of time.
- 14) Refer all servicing to qualified service personnel. Servicing is required when the apparatus has been damaged in any way, such as power-supply cord or plug is damaged, liquid has been spilled or objects have fallen into the apparatus, the apparatus has been exposed to rain or moisture, does not operate normally, or has been dropped.

Do not take apart or remodel the player. Doing so can result in electric shock. Consult your nearest Sony dealer or Sony Service Center for exchange of rechargeable batteries, internal checks or repair.

Precautions

Road safety

Do not use the monitor unit and headphones while driving, cycling, or operating any motorized vehicle. Doing so may create a traffic hazard and is illegal in some areas. It can also be potentially dangerous to play your headsets at high volume while walking, especially at pedestrian crossings. You should exercise extreme caution or discontinue use in potentially hazardous situations.

On safety

Should any solid object or liquid fall into the cabinet, unplug the player and have it checked by qualified personnel before operating it any further.

On power sources

- If you are not going to use the player for a long time, be sure to disconnect the player from the wall outlet. To disconnect the AC adaptor, grasp the plug itself; never pull the cord.
- Do not touch the AC adaptor with wet hands. Doing so may cause shock hazard.
- Use a commercially available AC plug adaptor, if necessary, depending on the design of the wall outlet.

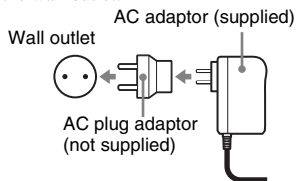

- Do not connect the AC adaptor to a traveler's electric transformer, which may generate heat and cause a malfunction.

On temperature increases

Heat may build up inside the player during charging or if it is being used for a long time. This is not a malfunction.

On placement

- Do not place the player in a confined space such as a bookshelf or similar unit.
- Do not cover the ventilation of the player with newspapers, tablecloths, curtains, etc. And do not place the player on a soft surface, such as a rug.
- Do not place the player and adaptors in a location near heat sources, or in a place subject to direct sunlight, excessive dust, sand, moisture, rain, or mechanical shock, or in a car with its windows closed.
- Do not place the player in an inclined position. It is designed to be operated in a horizontal position only.
- Keep the player and discs away from equipment with strong magnet, such as microwave ovens, or large loudspeakers.
- Do not drop or apply strong shock. Do not place heavy objects on the player and accessories.

On operation

- If the player is brought directly from a cold to a warm location, or is placed in a very damp room, moisture may condense on the lenses inside the player. Should this occur, the player may not operate properly. In this case, remove the disc and leave the player for about half an hour until the moisture evaporates. Wipe off moisture attached to the LCD surface with tissue etc. Turn on the power again later.
- Keep the lens on the player clean and do not touch it. Touching the lens may damage the lens and cause the player to malfunction. Leave the disc lid closed except when you insert or remove discs.
- Do not use the player in an area subject to excessive dust or cigarette smoke. Dust build-up or cigarette smoke residue on internal components such as the lens may cause the player to malfunction.
- Do not turn off the player during software update, as it may cause a malfunction.

On Liquid Crystal Display

- Although manufactured with high precision technology, the LCD may occasionally display dots of various colors. That is not a malfunction.
- Do not place or drop any object onto the LCD surface. Also, do not apply pressure from hands or elbows.
- Do not damage the LCD surface with a sharp edged tool.

On rechargeable battery

- Because of the battery's limited life, its capacity gradually deteriorates over time and repeated use. Exchange a new one for the old one when the battery holds about only half the normal period.
- To prevent battery deterioration, charge the battery at least once every half a year or every year.
- Certain countries may regulate disposal of the battery used to power this product. Please consult with your local authority.

On AC adaptor and car battery adaptor

- Use the supplied adaptors for the player, as other adaptors may cause a malfunction.
- Do not disassemble or reverse-engineer.
- Do not touch the metal parts, as it may cause a short and damage the adaptors, especially if touched by other metal objects.

On adjusting volume

Do not turn up the volume while listening to a section with very low level inputs or no audio signals. If you do, the speakers may be damaged when a peak level section is played.

On headphones

- Preventing hearing damage: Avoid using headphones at high volumes. Hearing experts advise against continuous, loud, and extended play. If you experience a ringing in your ears, reduce the volume or discontinue use.
- Showing consideration for others: Keep the volume at a moderate level. This will allow you to hear external sounds and still be considerate to the people around you.

On cleaning

- Clean the cabinet, panel, and controls with a soft cloth slightly moistened with a mild detergent solution. Do not use any type of abrasive pad, scouring powder or solvent such as alcohol or benzine.
- Wipe the LCD surface with the soft dry cloth lightly. To prevent dirt buildup, wipe it frequently.
Do not wipe the LCD surface with a wet cloth. If water enters, a malfunction may result.
- If picture/sound is distorted, the lens may be covered with dust. In this case, use a commercially-available blower brush for camera lenses to clean the lens.
Avoid touching the lens directly during cleaning.

On cleaning discs, disc/lens cleaners

Do not use cleaning discs or disc/lens cleaners (including wet or spray types). These may cause the apparatus to malfunction.

On replacement of parts

In the events that this player is repaired, repaired parts may be collected for reuse or recycling purposes.

On connecting to the HDMI OUT jack

Observe the following as improper handling may damage the HDMI OUT jack and the connector.

- Carefully align the HDMI OUT jack on the right of the player and the HDMI connector by checking their shapes. Make sure the connector is not upside down or tilted.

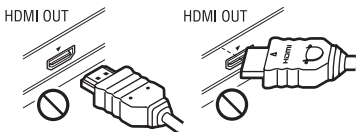

- Be sure to disconnect the HDMI cable when moving the player.



- Hold the HDMI connector straight when connecting or disconnecting the HDMI cable. Do not twist or force the HDMI connector into the HDMI OUT jack.

Notes About the Discs

- To keep the disc clean, handle the disc by its edge. Do not touch the surface.
Dust, fingerprints, or scratches on the disc may cause it to malfunction.



- Do not expose the disc to direct sunlight or heat sources such as hot air ducts, or leave it in a car parked in direct sunlight as the temperature may rise considerably inside the car.
- After playing, store the disc in its case.
- Clean the disc with a cleaning cloth. Wipe the disc from the center out.



- Do not use solvents such as benzine, thinner, commercially available disc/lens cleaners, or anti-static spray intended for vinyl LPs.
- If you have printed the disc's label, dry the label before playing.
- Do not use the following discs.
 - A lens cleaning disc.
 - A disc that has a non-standard shape (e.g., card, heart).
 - A disc with a label or sticker on it.
 - A disc that has cellophane tape or sticker adhesive on it.
- Do not resurface the playing side of a disc to remove surface scratches.

IMPORTANT NOTICE

Caution: This player is capable of holding a still video image or on-screen display image on your television screen indefinitely. If you leave the still video image or on-screen display image displayed on your TV for an extended period of time you risk permanent damage to your television screen. Plasma display panel televisions and projection televisions are susceptible to this.

If you have any questions or problems concerning your player, please consult your nearest Sony dealer.

Cinavia Notice

This product uses Cinavia technology to limit the use of unauthorized copies of some commercially-produced film and videos and their soundtracks. When a prohibited use of an unauthorized copy is detected, a message will be displayed and playback or copying will be interrupted.

More information about Cinavia technology is provided at the Cinavia Online Consumer Information Center at <http://www.cinavia.com>. To request additional information about Cinavia by mail, send a postcard with your mailing address to: Cinavia Consumer Information Center, P.O. Box 86851, San Diego, CA, 92138, USA.

Copyrights and Trademarks

- “AVCHD” and the “AVCHD Progressive” logo are trademarks of Panasonic Corporation and Sony Corporation.
- Java and all Java-based trademarks and logos are trademarks or registered trademarks of Oracle and/or its affiliates. Other names may be trademarks of their respective owners.
- , “XMB,” and “xross media bar” are trademarks of Sony Corporation and Sony Computer Entertainment Inc.
- This product incorporates High-Definition Multimedia Interface (HDMI™) technology. HDMI, the HDMI Logo, and High-Definition Multimedia Interface are trademarks or registered trademarks of HDMI Licensing LLC in the United States and other countries.

- Blu-ray Disc™, Blu-ray™, BONUSVIEW™ and the logos are trademarks of Blu-ray Disc Association.
- “DVD Logo” is a trademark of DVD Format/Logo Licensing Corporation.
- “BRAVIA” is a trademark of Sony Corporation.
- “PhotoTV HD” and the “PhotoTV HD” logo are trademarks of Sony Corporation.
- MPEG Layer-3 audio coding technology and patents licensed from Fraunhofer IIS and Thomson.
- This product incorporates proprietary technology under license from Verance Corporation and is protected by U.S. Patent 7,369,677 and other U.S. and worldwide patents issued and pending as well as copyright and trade secret protection for certain aspects of such technology. Cinavia is a trademark of Verance Corporation. Copyright 2004-2010 Verance Corporation. All rights reserved by Verance. Reverse engineering or disassembly is prohibited.
- Windows Media is either a registered trademark or trademark of Microsoft Corporation in the United States and/or other countries.
This product contains technology subject to certain intellectual property rights of Microsoft. Use or distribution of this technology outside of this product is prohibited without the appropriate license(s) from Microsoft.
- Other system and product names are generally trademarks or registered trademarks of the manufacturers. ™ and ® marks are not indicated in this document.

Table of Contents

WARNING	2
Precautions	3
Guide to Parts and Controls	8
Rotating and Folding Down the LCD Panel	11

Preparations

Checking the Supplied Accessories	12
Charging the Rechargeable Battery	12
Using the Car Battery Adaptor	13
Connecting to a TV	13

Playback

Playing a Disc	14
Playing from a USB Device	15
Available Options	15

Settings and Adjustments

Using the Settings Displays	17
Screen Settings	17
Audio Settings	18
BD/DVD Viewing Settings	19
Parental Control Settings	19
System Settings	20
Resetting	20

Additional Information

Troubleshooting	21
Specifications	23
Index	27

Guide to Parts and Controls

The available functions of the player and remote differ depending on the disc or the situation.

Player

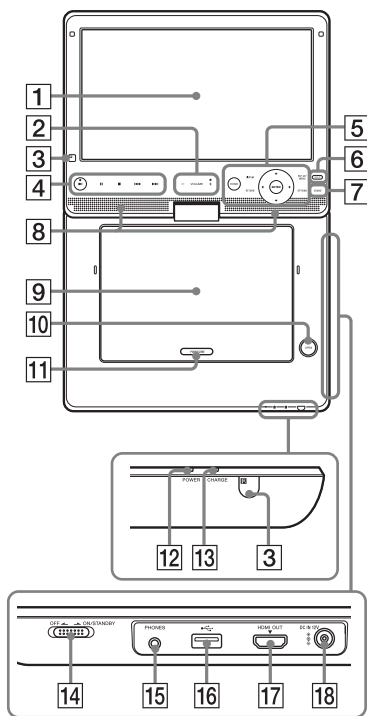

The VOLUME + and ► (play) buttons have a tactile dot. Use the tactile dot as a reference when operating the player.

- 1 LCD panel
- 2 VOLUME (sound volume) +/- Adjusts the volume.
- 3 Remote sensor
- 4 ► (play)

Starts or re-starts playback.

II (pause)

Pauses or re-starts playback.

■ (stop)

Stops playback and remembers the stop point (resume point).

The resume point for a title/track is the last point you played or the last photo for a photo folder.

◀◀/▶▶ (previous/next)

Skips to the previous/next chapter, track, or file.

Only the buttons on the player have the following functions:

- Fast reverses/fast forwards the disc when pressed for more than one second during playback. Each time you press the button briefly, the search speed changes.
- Plays in slow motion when pressed for more than one second in pause mode.

5 HOME

Enters the player's home menu.

Displays the wallpaper when pressed on the category icon of the home menu.

DISPLAY (page 14)

Displays the playback information on the screen.

POP UP/MENU

Opens or closes the BD-ROM's Pop-up Menu, or the DVD's menu.

OPTIONS (page 15)

The options menu that can be selected appears on the screen.

RETURN

Returns to the previous display.



Moves the highlight to select a displayed item.

ENTER (center button)

Enters the selected item.

6 HOLD

To avoid accidental button operation of the player, press the button for more than two seconds. All the buttons on the player are locked, while the buttons on the remote remain operable.

7 SOUND

Switches among 4 different sound modes each time pressed. This function is available for the sound output from the player's speaker and headphones.

8 Speaker

9 Disc lid

10 OPEN button

Opens the disc lid.

11 PUSH CLOSE

Closes the disc lid.

12 POWER indicator

Lights up when the player is turned on.

13 CHARGE indicator

Lights up when charging the rechargeable battery.

Flashes when the battery is empty.

14 ON/STANDBY / OFF (power switch)

- Turns on the player or sets to standby mode when slid to ON/STANDBY.
- Turns the main power off when set to OFF. The player does not respond to the remote. You can prevent battery consumption when not in use.

15 PHONES (headphones) jack

16 (USB) jack

Connect a USB device to this jack.

17 HDMI OUT jack

18 DC IN 12V jack

Connect the AC adaptor or car battery adaptor.

Remote

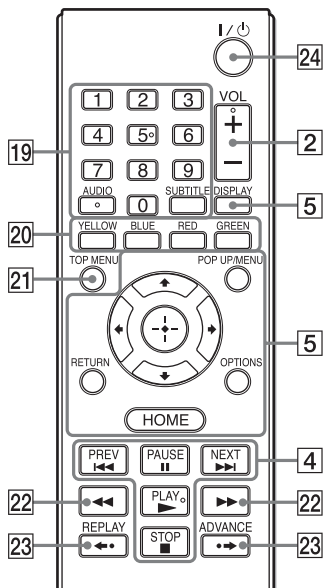

Number 5, AUDIO, VOL +, and ► PLAY buttons have a tactile dot. Use the tactile dot as a reference when operating the player.

19 Number buttons (0 - 9)

Enters the title/chapter numbers, etc.

AUDIO (page 19)

Selects the language track when multi-lingual tracks are recorded on BD-ROMs/DVD VIDEOS.

Selects the sound track on CDs.

SUBTITLE (page 19)

Selects the subtitle language when multi-lingual subtitles are recorded on BD-ROMs/DVD VIDEOS.

20 Color buttons (YELLOW/BLUE/RED/GREEN)

Shortcut keys for interactive functions.

21 TOP MENU

Opens or closes the BD's or DVD's Top Menu.

22 ◀◀/▶▶ (fast reverse/fast forward)

- Fast reverses/fast forwards the disc when pressed during playback. Each time you press the button during playback of videos, the search speed changes.
- Plays in slow motion, when pressed for more than one second in pause mode.
- Plays one frame at a time, when pressed briefly in pause mode.

23 ◀•/•▶ (replay/advance)

Briefly replays the current scenes for 10 seconds/briefly fast forwards the current scenes for 15 seconds.





24 I/⏻ (on/standby)

Turns on the player, or sets to standby mode.

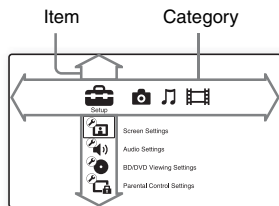
Home menu display

The home menu appears when you press HOME. Select a category using ◀/▶. Select an item using ↑/↓, and press ENTER.



-  (Setup): Adjusts the player settings.
-  (Photo): Displays photos.
-  (Music): Plays music.
-  (Video): Plays videos.

Rotating and Folding Down the LCD Panel

Open the LCD panel to the vertical position, then slowly rotate it 180 degrees.

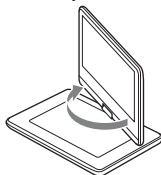

After rotating the LCD panel 180 degrees clockwise, push the LCD panel down onto the main body of the player. In this position the panel is facing up.

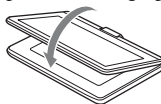

To return the LCD panel to its original position

Open the LCD panel to the vertical position and slowly rotate the LCD panel counter-clockwise.



Return the LCD panel to its original position after use, so the LCD panel will not be damaged by sudden shocks or rough treatment.

Checking the Supplied Accessories

Check that you have the following items:

- AC adaptor (1)
- Car battery adaptor (1)
- Remote commander (remote) (1)
- Size AA (R6) batteries (2)

To prepare the remote

Insert two Size AA (R6) batteries by matching the ⊕ and ⊖ ends on the batteries to the markings inside the battery compartment.

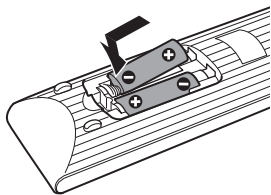

Charging the Rechargeable Battery

Charge the rechargeable battery before using the player for the first time, or when the battery is depleted.

Connect the AC adaptor.

Charging begins. The CHARGE indicator lights up while charging.

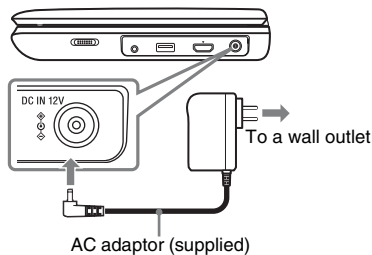

Charge the battery in an ambient temperature of between 5°C (41°F) and 35°C (95°F).

Charging time and playing time

Charging time: approx. 4.5 hours

Playing time: approx. 4.5 hours

Times indicated are under the following conditions:

- Charging time
 - moderate temperature (20°C (68°F))
 - power-off
- Playing time
 - moderate temperature (20°C (68°F))
 - headphone use
 - backlight set to minimum

Depending on the ambient temperature or rechargeable battery condition, charging time may be longer, or playing time may be reduced.

To check the battery level

When the player is stopped, the battery indicator is displayed. When the battery is empty,  is displayed or the CHARGE indicator flashes.



Using the Car Battery Adaptor

The car battery adaptor is for a 12V car battery, negative earth (do not use it with a 24V car battery, positive earth).

Connect the car battery adaptor.

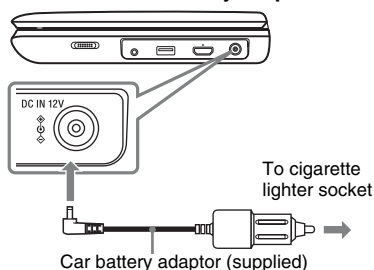

After using the player in a car

Disconnect the car battery adaptor from the cigarette lighter socket.



- The driver should not connect or disconnect the car battery adaptor while driving.
- Arrange the cord so as not to interfere with the driver. Also, do not place the LCD panel where the driver can watch.
- Clean the cigarette lighter socket. If dirty, the cigarette lighter socket may cause contact failure or malfunction.
- Use the car battery adaptor with the car engine running. If it is used with the car engine off, the car battery may become depleted.
- Do not leave the player or accessories in the car.

Connecting to a TV

You can enjoy images on your TV or monitor.

1 Connect the player to your TV or monitor using the HDMI cable.

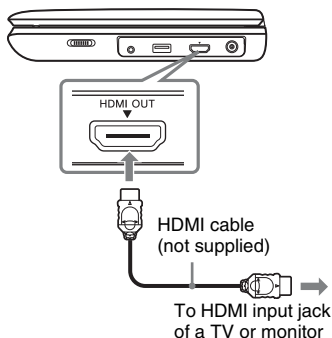

2 Turn on the player.

Check the “HDMI/LCD Video Format” settings in the “Screen Settings” setup (page 18).



The player can connect to an AV amplifier in the same way as a TV.



- Refer to the instruction manual supplied with the equipment to be connected.
- Before connecting, turn off the player and the equipment to be connected, then unplug them from their wall sockets.
- No sound is output from the player’s speaker and headphones when connecting with an HDMI cable.

Playing a Disc

For playable discs, see “Playable discs” (page 24).

- 1 Open the LCD panel, and turn on the player.**
- 2 Press OPEN to open the disc lid, and place the disc.**
Place with the playback side down and push gently until it clicks. Do not touch the lens surface.

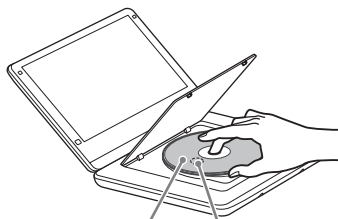

Playing side facing down Lens down

- 3 Close the disc lid.**
Playback starts.
If playback does not start automatically, select (Video), (Music), or (Photo) category, and press ENTER.

Enjoying BONUSVIEW

Some BD-ROMs have bonus content and other data that can be downloaded for enjoyment.

- 1 Connect a USB memory to the USB jack on the player (page 9).**
As your local storage, use a 256 MB or larger USB memory.
- 2 Insert a BD-ROM with BONUSVIEW.**
The operation method differs depending on the disc. Refer to the instruction manual supplied with the disc.



When you select “All Settings” in the “Resetting” setup under (Setup) with the USB memory connected, the data stored in the USB memory will be erased. All data stored in the buda folder will be erased.

Displaying the playback information



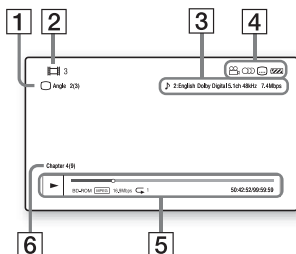

You can check the playback information, etc., by pressing DISPLAY.

The displayed information differs depending on the disc type and player status.

Example: when playing a BD-ROM



- 1** The currently selected angle

- 2 Title number or name
- 3 The currently selected audio setting
- 4 Available functions ( angle,  audio,  subtitle,  battery status)
- 5 Displays the Play mode, Playing status bar, Disc type, Video codec, Bitrate, Repeat type, Elapsed time, and Total playing time.
- 6 Chapter number

Playing from a USB Device



You can play video/music/photo files on the connected USB device.

For playable USB devices, see “Playable types of files” (page 25).

1 Connect the USB device to the USB jack on the player.

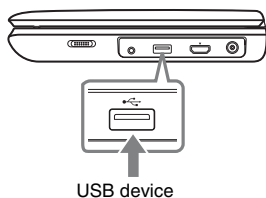
Refer to the instruction manual supplied with the USB device before connecting.



- 2 Select , , or  on the home menu using /.
- 3 Select  (USB device) using /, and press ENTER.

Available Options

Various settings and playback operations are available by pressing OPTIONS. The available items differ depending on the situation.

Common options

Item	Details
LCD Mode	<ul style="list-style-type: none"> • LCD Aspect: Changes the picture size. • Backlight: Adjusts the brightness. • Contrast: Adjusts the difference between light and dark areas. • Hue: Adjusts the red and green color balance. • Color: Adjusts the richness of colors. • Default: Returns all settings to the factory defaults.
Repeat Setting	Sets the repeat mode.
Play/Stop	Starts or stops the playback.
Play from beginning	Plays the item from the beginning.

(Video) only

Item	Details
A/V SYNC	Adjusts the gap between picture and sound, by delaying the sound output in relation to the picture output (0 to 120 milliseconds).
Pause	Pauses the playback.
Top Menu	Displays the BD's or DVD's Top Menu.
Menu/Popup Menu	Displays the BD-ROM's Pop-up Menu or DVD's menu.

Item	Details
Title Search	Searches for a title on BD-ROMs/DVD VIDEOS and starts playback from the beginning.
Chapter Search	Searches for a chapter and starts playback from the beginning.
Angle	Switches to other viewing angles when multi-angles are recorded on BD-ROMs/DVD VIDEOS.
Audio	Switches the language track when multi-lingual tracks are recorded on BD-ROMs/DVD VIDEOS.
Subtitle	Switches the subtitle language when multi-lingual subtitles are recorded on BD-ROMs/ DVD VIDEOS.

🎵 (Music) only

Item	Details
Add Slideshow BGM	Registers music files in the USB memory as slideshow background music (BGM).

📷 (Photo) only







Item	Details
Slideshow Speed	Changes the slideshow speed.
Slideshow Effect	Sets the effect for slideshows.
Slideshow BGM	<ul style="list-style-type: none"> • Off: Turns off the function. • My Music from USB: Sets the music files registered in "Add Slideshow BGM." If no music file is registered, "(Not registered)" is displayed. • Play from Music CD: Sets the tracks in CD-DAs.
Slideshow	Plays a slideshow.
Rotate Left	Rotates the photo counterclockwise by 90 degrees.
Rotate Right	Rotates the photo clockwise by 90 degrees.

Using the Settings Displays

Select  (Setup) on the home menu when you need to change the settings of the player.

The default settings are underlined.

- 1 Select  (Setup) on the home menu using \leftarrow/\rightarrow .
- 2 Select the setup category icon using \uparrow/\downarrow , and press ENTER.

Icon	Explanation
	Screen Settings (page 17) Makes the video settings.
	Audio Settings (page 18) Makes the audio settings.
	BD/DVD Viewing Settings (page 19) Makes detailed settings for BD/DVD playback.
	Parental Control Settings (page 19) Makes detailed settings for the Parental Control function.
	System Settings (page 20) Makes the player-related settings.
	Resetting (page 20) Resets the player to the factory settings.

Screen Settings

TV Type

16:9: Select this when connecting to a wide-screen TV or a TV with a wide mode function.

4:3: Select this when connecting to a 4:3 screen TV without a wide mode function.

Screen Format

Original: Select this when connecting to a TV with a wide mode function. Displays a 4:3 screen picture in 16:9 aspect ratio even on a wide-screen TV.

Fixed Aspect Ratio: Changes the picture size to fit the screen size with the original picture aspect ratio.

DVD Aspect Ratio

Letter Box: Displays a wide picture with black bands on the top and bottom.



Pan & Scan: Displays a full-height picture on the entire screen, with trimmed sides.

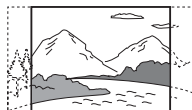

Cinema Conversion Mode

Auto: Normally select this. The player automatically detects whether the material is video-based or film-based, and switches to the appropriate conversion method.

Video: The conversion method suited for video-based material will always be selected regardless of the material.

HDMI/LCD Video Format

Normally select "Auto."

Select "Original Resolution" to output the resolution recorded on the disc. When the resolution is lower than the SD resolution, it is scaled up to the SD resolution.



If no picture appears on the connected TV after setting the resolution, try another resolution setting.

BD/DVD-ROM 1080/24p Output

Auto: Outputs 1920 × 1080p/24 Hz video signals only when connecting a 1080/24p-compatible TV using the HDMI OUT jack.

Off: Normally select this when your TV is not compatible with 1080/24p video signals.



No picture appears on the LCD screen when 24p video signals are output from the HDMI OUT jack.

YCbCr/RGB (HDMI)

Auto: Automatically detects the connected TV type, and switches to the matching color setting.

YCbCr (4:2:2): Outputs YCbCr 4:2:2 video signals.

YCbCr (4:4:4): Outputs YCbCr 4:4:4 video signals.

RGB: Outputs RGB video signals.

Pause Mode

Auto: Normally select this. Dynamic moving pictures appear without blurring.

Frame: Displays static pictures at high resolution.



Audio Settings

Audio (HDMI)

Auto: Normally select this. Outputs audio signals according to the status of the connected HDMI device.

PCM: Outputs PCM signals from the HDMI OUT jack.

BD Audio MIX Setting

On: Outputs the audio obtained by mixing the interactive and secondary audio to the primary audio.

Off: Outputs the primary audio only. Select this to output HD audio signals to an AV amplifier (receiver).

DTS Neo:6

Cinema: Outputs the simulated multi-channel sound from 2 channel sources via the HDMI OUT jack according to the capability of the connected device using "DTS Neo:6 Cinema" mode.

Music: Outputs the simulated multi-channel sound from 2 channel sources via the HDMI OUT jack according to the capability of the connected device using "DTS Neo:6 Music" mode.

Off: Outputs the sound with its original number of channels via the HDMI OUT jack.

Audio DRC

Auto: Performs playback at the dynamic range specified by the disc (BD-ROM only). Other discs are played back at the "On" level.

On: Performs playback at a standard compression level.

Off: No compression works. A more dynamic sound is produced.

Downmix

Surround: Outputs audio signals with surround effects. Select this when connecting an audio device that supports Dolby Surround (Pro Logic)^{*1} or DTS Neo:6^{*2}.

Stereo: Outputs audio signals without surround effects. Select this when connecting an audio device that does not support Dolby Surround (Pro Logic) or DTS Neo:6.

^{*1} Manufactured under license from Dolby Laboratories. Dolby, Pro Logic, and the double-D symbol are trademarks of Dolby Laboratories.

^{*2} Manufactured under license under U.S. Patent Nos: 5,956,674; 5,974,380; 6,226,616; 6,487,535; 7,212,872; 7,333,929; 7,392,195; 7,272,567 & other U.S. and worldwide patents issued & pending. DTS-HD, the Symbol, & DTS-HD and the Symbol together are registered trademarks & DTS-HD Master Audio is a trademark of DTS, Inc. Product includes software. © DTS, Inc. All Rights Reserved.

BD/DVD Viewing Settings

BD/DVD Menu

Selects the default menu language for BD-ROMs or DVD VIDEOS.

When you select “Select Language Code,” the display for entering the language code appears. Enter the code for your language by referring to “Language code list” (page 25).

Audio

Selects the default track language for BD-ROMs or DVD VIDEOS.

When you select “Original,” the language given priority in the disc is selected. When you select “Select Language Code,” the display for entering the language code appears. Enter the code for your language by referring to “Language code list” (page 25).

Subtitle

Selects the default subtitle language for BD-ROMs or DVD VIDEOS.

When you select “Select Language Code,” the display for entering the language code appears. Enter the code for your language by referring to “Language code list” (page 25).

BD Hybrid Disc Playback Layer

BD: Plays BD layer.

DVD/CD: Plays DVD or CD layer.

Parental Control Settings

Password

Sets or changes the password for the Parental Control function. A password allows you to set a restriction on BD-ROMs or DVD VIDEOS playback. If necessary, you can differentiate the restriction levels for BD-ROMs and DVD VIDEOS.

Parental Control Area Code

Playback of some BD-ROMs or DVD VIDEOS can be limited according to the geographic area. Scenes may be blocked or replaced with different scenes. Follow the on-screen instructions and enter your four-digit password.

BD Parental Control

Playback of some BD-ROMs can be limited according to the age of the users. Scenes may be blocked or replaced with different scenes. Follow the on-screen instructions and enter your four-digit password.

DVD Parental Control

Playback of some DVD VIDEOS can be limited according to the age of the users. Scenes may be blocked or replaced with different scenes. Follow the on-screen instructions and enter your four-digit password.



System Settings

OSD

Selects your language for the player on-screen displays.

Control for HDMI

On: The following BRAVIA sync features are available:

- One-Touch Play
- System Power-Off
- Language Follow

Off: Turns off the function.



For details, refer to the instruction manual supplied with the TV or components.

HDMI: Linked to TV-off

On: Automatically turns off the player and HDMI-compatible components when the connected TV enters standby mode (BRAVIA sync).

Off: Turns off the function.

Auto Standby

On: Turns on the “Auto Standby” function. Automatically returns to standby mode if no button on the player or remote is pressed for more than 30 minutes.

Off: Turns off the function.

Auto Display

On: Automatically displays information on the screen when changing the viewing titles, picture modes, audio signals, etc.

Off: Displays information only when you press DISPLAY.

Screen Saver

On: Turns on the screen saver function.

The screen saver image appears when the player is not used for more than 10 minutes while displaying an on-screen display.

Off: Turns off the function.

System Information

Displays the player’s software version information.

Software License Information

Displays the information about software license.



Resetting

Reset to Factory Default Settings

You can reset the player settings to the factory default by selecting the group of settings. All the settings within the group will be reset.

Additional Information

Troubleshooting

If you experience any of the following difficulties while using the player, use this troubleshooting guide to help remedy the problem before requesting repairs. Should any problem persist, consult your nearest Sony dealer.

Power

The power is not turned on.

- Check that the AC adaptor is securely connected (page 12).
- Check that the rechargeable battery is sufficiently charged (page 12).

The power is not turned on even if you press I/⏻ on the remote.

- The power switch is set to OFF. Slide the power switch to ON/STANDBY.

The rechargeable battery cannot be charged or charging time is long.

- If the CHARGE indicator flashes with the AC adaptor connected, the ambient temperature is not appropriate. Charge the battery in an ambient temperature of between 5°C (41°F) and 35°C (95°F).
- Charging takes longer if the player is turned on. Before charging, turn off the player.
- If you have not used the player for more than a year, the battery may have deteriorated. Consult your nearest Sony dealer.

Picture

There is no picture.

- No picture appears on the LCD screen when 24p video signals are output from the HDMI OUT jack. Set “BD/DVD-ROM 1080/24p Output” to “Off” in the “Screen Settings” setup (page 18).

The black points appear and the red, blue, green points remain on the LCD.

- This is a structural property of the LCD and not a malfunction.

Sound

There is no sound.

- The player is in pause mode or in slow play mode.
- The player is in fast forward or fast reverse mode.

The HD Audio (Dolby Digital Plus, Dolby TrueHD, DTS-HD High Resolution Audio, and DTS-HD Master Audio) is not output by bitstream.

- Set “BD Audio MIX Setting” to “Off” in the “Audio Settings” setup (page 18).

The interactive audio is not output.

- Set “BD Audio MIX Setting” to “On” in the “Audio Settings” setup (page 18).

Disc

The disc does not play.

- The disc is dirty or skewed.
- The disc is not set until it clicks (page 14).
- The disc is upside down. Insert the disc with the playback side facing down.
- The disc has a format that cannot be played back by this player (page 24).
- The player cannot play a recorded disc that is not correctly finalized.

- The region code on the BD or DVD does not match the player (page 24).

Operations

Playback does not start from the beginning of content.

- Press **OPTIONS**, and select “Play from beginning.”

Playback does not start from the resume point where you last stopped playing.

- The resume point may be cleared from memory when
 - you open the disc lid.
 - you disconnect the USB device.
 - you play other content.
 - you turn off the player.
 - you change some settings under the “Setup.”

The player does not respond to any button.

- The **HOLD** function has been set. To cancel the function, press the button for more than two seconds.
- Moisture has condensed inside the player (page 4).
- Set the power switch to **OFF** and leave it for one minute.

USB device

The player does not detect a USB device connected to the player.

- Make sure that the USB device is securely connected to the USB jack.
- Check if the USB device or a cable is damaged.
- Check if the USB device is on.
- If the USB device is connected via a USB hub, connect the USB device directly to the player.

Hookup

There is no picture or the picture is not output correctly.

- Check that all the connecting cables are securely connected.
- Switch the input selector on your TV to display the signal from the player.
- Try the following: ① Turn the player off and on again. ② Turn the connected equipment off and on again. ③ Disconnect and then reconnect the HDMI cable.
- The HDMI OUT jack is connected to a DVI device that does not support copyright protection technology.
- Check the “HDMI/LCD Video Format” settings in the “Screen Settings” setup (page 18).
- For BD-ROMs, check the “BD/DVD-ROM 1080/24p Output” setting in the “Screen Settings” setup (page 18).

There is no sound or the sound is not output correctly.

- Check that all the connecting cables are securely connected.
- Try the following: ① Turn the player off and on again. ② Turn the connected equipment off and on again. ③ Disconnect and then reconnect the HDMI cable.
- The HDMI OUT jack is connected to a DVI device (DVI jacks do not accept audio signals).
- The device connected to the HDMI OUT jack does not support the audio format of the player. Check the audio settings (page 18).
- Set “Audio (HDMI)” to “Auto” in the “Audio Settings” setup (page 18).
- The sound mode can be switched only for the sound output from the player’s speaker and headphones. Only “Standard” is available for the sound output from the HDMI OUT jack.

The display language on the screen switches automatically when connected to the HDMI OUT jack.

- ▶ When “Control for HDMI” is set to “On” (page 20), the display language on the screen automatically switches according to the language setting of the connected TV (if you change the setting on your TV, etc.).

“Control for HDMI” (BRAVIA Sync)

The “Control for HDMI” function does not work (BRAVIA Sync).

- ▶ Check that “Control for HDMI” is set to “On” (page 20).
- ▶ If you change the HDMI connection, turn the player off and on again.
- ▶ If power failure occurs, set “Control for HDMI” to “Off,” then set “Control for HDMI” to “On” (page 20).
- ▶ Check the following and refer to the instruction manual supplied with the component.
 - the connected component is compatible with the “Control for HDMI” function.
 - the connected component’s setting for the “Control for HDMI” function is correct.

The System Power-Off function does not work (BRAVIA Sync).

- ▶ Check that “Control for HDMI” and “HDMI: Linked to TV-off” are set to “On” (page 20).

Specifications

System

Laser: Semiconductor laser

Signal format system: NTSC

Inputs/Outputs

PHONES (headphones):

Stereo minijack

USB:

USB jack Type A, maximum current 500 mA (For connecting a USB memory, memory card reader, digital still camera, and digital video camera)

HDMI OUT:

HDMI 19-pin standard connector

Liquid Crystal Display

Panel size (approx.):

9 inches wide (diagonal)

Driving system:

TFT active matrix

Resolution:

800 × 480

General

Power requirements:

DC 12 V 1.5 A (AC adaptor/Car battery adaptor)

Power consumption:

8.5 W (when playing a BD-ROM using headphones)

Dimensions (approx.):

246.7 mm × 184.7 mm × 42.2 mm
(9 3/4 in. × 7 3/8 in. × 1 11/16 in.)
(width/depth/height) incl. projecting parts

Mass (approx.):

1.31 kg (2.89 lbs)

Operating temperature:

5 °C to 35 °C (41 °F to 95 °F)

Operating humidity:

25 % to 80 %

AC adaptor:

110-240 V AC, 50/60 Hz

Car battery adaptor:

12 V DC

Supplied accessories

See page 12.

Specifications and design are subject to change without notice.

Playable discs

Blu-ray Disc *1*2	BD-ROM BD-R*3/BD-RE*3
DVD *4	DVD-ROM DVD-R*5/DVD-RW DVD+R*5/DVD+RW
CD *4	CD-DA (Music CD) CD-ROM CD-R/CD-RW

*1 Since the Blu-ray Disc specifications are new and evolving, some discs may not be playable depending on the disc type and the version. The audio output differs depending on the source, connected output jack, and selected audio settings.

*2 The player supports BD-ROM Profile 1 Ver.1.1 only.

*3 BD-RE: Ver.2.1
BD-R: Ver.1.1, 1.2, 1.3 including organic pigment type BD-R (LTH type)
The BD-Rs recorded on a PC cannot be played if postscripts are recordable.

*4 A CD or DVD disc will not play if it has not been correctly finalized. For more information, refer to the instruction manual supplied with the recording device.

*5 Only BDP-SX910 supports double-layer discs.

Discs that cannot be played

- BDs with cartridge
- BDXLs
- DVD-RAMs
- HD DVDs
- DVD Audio discs
- PHOTO CDs
- Data part of CD-Extras
- VCDs/Super VCDs
- HD layer on Super Audio CDs

- Audio material side on DualDiscs
- A disc recorded in a color system other than NTSC, such as PAL (this player conforms to the NTSC color system).

Note on Discs

This product is designed to playback discs that conform to the Compact Disc (CD) standard. DualDiscs and some of the music discs encoded with copyright protection technologies do not conform to the Compact Disc (CD) standard, therefore, these discs may not be playable by this product.

Note on playback operations of BDs/DVDs

Some playback operations of BDs/DVDs may be intentionally set by software producers. Since this player plays BDs/DVDs according to the disc contents the software producers designed, some playback features may not be available.

Note about double-layer BDs/DVDs

The playback pictures and sound may be momentarily interrupted when the layers switch.

Region code (BD-ROM/DVD VIDEO only)

The system that is used to protect copyrights. The region code is shown on the BD-ROM/DVD VIDEO packages according to the region of sale. BD-ROMs labeled "A" will play on the player.



DVD VIDEOS labeled "ALL" or "1" will play on the player.



Playable types of files

Video

File format	Extensions
MPEG-1 Video/PS* ¹ MPEG-2 Video/PS, TS* ¹	“.mpg,” “.mpeg,” “.m2ts,” “.mts”
MPEG-4 AVC* ¹	“.mkv,” “.mp4,” “.m4v,” “.m2ts,” “.mts”
WMV9* ¹	“.wmv,” “.asf”
AVCHD* ²	*3

Music

File format	Extensions
MP3 (MPEG-1 Audio Layer III)	“.mp3”
AAC/HE-AAC* ¹ * ⁴	“.m4a”
WMA9 Standard* ¹ * ⁴	“.wma”
LPCM	“.wav”

Photo

File format	Extensions
JPEG	“.jpg,” “.jpeg”
PNG	“.png* ⁵ ”
GIF	“.gif* ⁵ ”

*¹ The player does not play coded files such as DRM.

*² The player plays AVCHD Ver.2.0 format.

*³ The player plays AVCHD format files that are recorded on a digital video camera, etc. The AVCHD format disc will not play if it has not been correctly finalized.

*⁴ The player does not play coded files such as Lossless.

*⁵ The player does not play animated PNG or animated GIF files.



- Some files may not play depending on the format, the encoding, or recording condition.
- Some files edited on a PC may not play.
- The player can recognize the following files or folders in BDs, DVDs, CDs and USB devices:
 - up to folders in the 3rd tree
 - up to 500 files in a single tree
 The number of files or folders differs depending on the conditions.
- Some USB devices may not work with this player.
- The player can recognize Mass Storage Class (MSC) devices such as flash memory, as well as Still Image Capture Device (SICD) class devices.
- To avoid data corruption or damage to the USB memory or devices, turn the player off when connecting or removing the USB memory or devices.
- The player may not play high bit rate video files on DATA CDs smoothly. You are recommended to play such files using DATA DVDs.

Language code list

For details, see “BD/DVD Viewing Settings” (page 19).

The language spellings conform to the ISO 639: 1988 (E/F) standard.

Code Language

1027	Afar	1028	Abkhazian
1032	Afrikaans	1039	Amharic
1044	Arabic	1045	Assamese
1051	Aymara	1052	Azerbaijani
1053	Bashkir	1057	Byelorussian
1059	Bulgarian	1060	Bihari
1061	Bislama	1066	Bengali
1067	Tibetan	1070	Breton
1079	Catalan	1093	Corsican
1097	Czech	1103	Welsh
1105	Danish	1109	German
1130	Bhutani; Dzongkha	1142	Greek
1144	English	1145	Esperanto
1149	Spanish	1150	Estonian
1151	Basque	1157	Persian
1165	Finnish	1166	Fiji

Code Language

1171	Faroese	1174	French
1181	Frisian	1183	Irish
1186	Scots Gaelic	1194	Galician
1196	Guarani	1203	Gujarati
1209	Hausa	1217	Hindi
1226	Croatian	1229	Hungarian
1233	Armenian	1235	Interlingua
1239	Interlingue	1245	Inupiak
1248	Indonesian	1253	Icelandic
1254	Italian	1257	Hebrew
1261	Japanese	1269	Yiddish
1283	Javanese	1287	Georgian
1297	Kazakh	1298	Greenlandic; Kalaallisut
1299	Cambodian; Khmer	1300	Kannada
1301	Korean	1305	Kashmiri
1307	Kurdish	1311	Kirghiz
1313	Latin	1326	Lingala
1327	Laothian; Lao	1332	Lithuanian
1334	Latvian	1345	Malagasy
1347	Maori	1349	Macedonian
1350	Malayalam	1352	Mongolian
1353	Moldavian	1356	Marathi
1357	Malay	1358	Malese; Maltese
1363	Burmese	1365	Nauru
1369	Nepali	1376	Dutch
1379	Norwegian	1393	Occitan
1403	Oromo	1408	Oriya
1417	Punjabi; Panjabi	1428	Polish
1435	Pashto; Pusho	1436	Portuguese
1463	Quechua	1481	Rhaeto- Romance
1482	Kirundi; Rundi	1483	Romanian
1489	Russian	1491	Kinyarwanda
1495	Sanskrit	1498	Sindhi
1501	Sangho; Sango	1502	Serbo- Croatian
1503	Singhalese; Sinhalese	1505	Slovak
1506	Slovenian	1507	Samoan
1508	Shona	1509	Somali
1511	Albanian	1512	Serbian
1513	Siswati; Swati	1514	Sesotho; Sotho southern
1515	Sundanese	1516	Swedish
1517	Swahili	1521	Tamil
1525	Telugu	1527	Tajik

Code Language

1528	Thai	1529	Tigrinya
1531	Turkmen	1532	Tagalog
1534	Setswana; Tswana	1535	Tonga; Tonga islands
1538	Turkish	1539	Tsonga
1540	Tatar	1543	Twi
1557	Ukrainian	1564	Urdu
1572	Uzbek	1581	Vietnamese
1587	Volapük	1613	Wolof
1632	Xhosa	1665	Yoruba
1684	Chinese	1697	Zulu
1703	not specified		

Parental control area code

For details, see “Parental Control Area Code” (page 19).

Code Area

2044	Argentina	2047	Australia
2046	Austria	2057	Belgium
2070	Brazil	2090	Chile
2092	China	2093	Colombia
2115	Denmark	2165	Finland
2174	France	2109	Germany
2200	Greece	2219	Hong Kong
2248	India	2238	Indonesia
2239	Ireland	2254	Italy
2276	Japan	2304	Korea
2333	Luxembourg	2363	Malaysia
2362	Mexico	2376	Netherlands
2390	New Zealand	2379	Norway
2427	Pakistan	2424	Philippines
2428	Poland	2436	Portugal
2489	Russia	2501	Singapore
2149	Spain	2499	Sweden
2086	Switzerland	2543	Taiwan
2528	Thailand	2184	United Kingdom

Index

Words in quotations appear in the on-screen displays.

A

AUDIO 9
“Audio Settings” 18
“Auto Standby” 20

B

Batteries 12
“BD/DVD Viewing Settings” 19
BD-R 24
BD-RE 24
Bitstream 21
Blu-ray Disc 24
BONUSVIEW 14
BRAVIA Sync 23

C

CD 24
Charging time and playing time 12
Color buttons 10
Connecting to a TV 13
“Control for HDMI” 20, 23

D

DISPLAY 8
Dolby Digital 19
DTS 18
DVD 24

H

HDMI 18
HOME 8, 17
Home menu 17

L

“LCD Mode” 15

O

OPTIONS 8
“OSD” 20

P

Parental Control 19
“Parental Control Settings” 19
Playable discs 24
Playback information 14
POP UP/MENU 8

R

Region code 24
Remote 9, 12
“Resetting” 20
Resetting the player 20
Resume 8, 22

S

“Screen Settings” 17
“Setup” 17
SOUND 9
SUBTITLE 10
“System Settings” 20

T

TOP MENU 10
Troubleshooting 21
“TV Type” 17

U

USB 15

The software of this player may be updated in the future. For information about any available updates and the latest Operating Instructions, please visit the following website:

<http://www.sony.com/blu-raysupport/>

AVCHD™
Progressive

HDMI

BONUS VIEW™

DVD
VIDEO™

COMPACT
disc
DIGITAL AUDIO



BRAVIA
Sync

PhotoTV
HD

Java
POWERED

<http://www.sony.net/>



1-4411688112

© 2012 Sony Corporation Printed in China

4-411-688-11(1)

Free Manuals Download Website

<http://myh66.com>

<http://usermanuals.us>

<http://www.somanuals.com>

<http://www.4manuals.cc>

<http://www.manual-lib.com>

<http://www.404manual.com>

<http://www.luxmanual.com>

<http://aubethermostatmanual.com>

Golf course search by state

<http://golfingnear.com>

Email search by domain

<http://emailbydomain.com>

Auto manuals search

<http://auto.somanuals.com>

TV manuals search

<http://tv.somanuals.com>