

# Trinitron® Color TV

## Operating Instructions

Before operating your TV, please read this manual thoroughly and retain it for future reference.

KV-13TR28/29	KV-2150R	KV-21STR2
KV-1430R	KV-2160WR	KV-20TS32
KV-1440WR	KV-20TS29	KV-20TS50
KV-20TR23	KV-2170RS	

## Owner's Record

The model and serial numbers are located at the rear of the TV. Record these numbers in the spaces provided below. Refer to them whenever you call upon your Sony dealer regarding this product.

Model No. \_\_\_\_\_ Serial No. \_\_\_\_\_

## Contents

### Preface

This section tells you about special features, safety information, and preparatory information for using this manual.

### Chapter 1: Setting Up

This section shows you the steps necessary for installing and presetting you TV, and how to connect optional video and audio equipment.

### Chapter 2: Using Basic Features

This section gives you basic information about operating and adjusting your TV.

### Chapter 3: Using Advanced Features

This section shows you the steps for other useful features with using the On-Screen Menus.

### Appendix

This section gives you specifications and troubleshooting information.

- For a detailed table of contents, see page 3.

# WARNING

To prevent fire or shock hazard, do not expose the unit to rain or moisture.

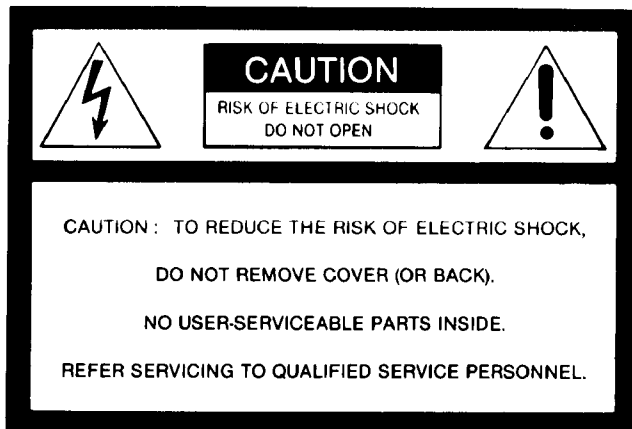

This symbol is intended to alert the user to the presence of uninsulated "dangerous voltage" within the product's enclosure that may be of sufficient magnitude to constitute a risk of electric shock to persons.



This symbol is intended to alert the user to the presence of important operating and maintenance (servicing) instructions in the literature accompanying the appliance.

## CAUTION:

TO PREVENT ELECTRIC SHOCK, DO NOT USE THIS POLARIZED AC PLUG WITH AN EXTENSION CORD, RECEPTACLE OR OTHER OUTLET UNLESS THE BLADES CAN BE FULLY INSERTED TO PREVENT BLADE EXPOSURE.

## Note to CATV system installer

This reminder is provided to call the CATV system installer's attention to Article 820-40 of the NEC that provides guidelines for proper grounding and, in particular specifies that the cable ground shall be connected to the grounding system of the building, as close to the point of cable entry as practical.

Use of this television receiver for other private viewing of programs broadcast on UHF or VHF or transmitted by cable companies for the use of the general public may require authorization from the broadcaster/cable company and/or program owner.

# Precautions

## Safety

- Operate the TV only on 120 V AC (except for KV-1440WR/2160WR/21STR2).
- Operate the TV on 110 – 120 V or 220 – 240 V AC (KV-1440WR/2160WR/21STR2 only).
- One blade of the plug is wider than the other for safety purposes and will fit into the power outlet only one way. If you are unable to insert the plug fully into the outlet, contact your dealer.
- Should any liquid or solid object fall into the cabinet, unplug the TV and have it checked by qualified personnel before operating it any further.
- Unplug the TV from the wall outlet if you are not going to use it for several days or more. To disconnect the cord, pull it out by the plug. Never pull the cord itself.

## Installing

- To prevent internal heat build-up, do not block the ventilation openings.
- Do not install the TV in a hot or humid place, or in a place subject to excessive dust or mechanical vibration.

## Cleaning

Clean the TV with a soft dry cloth. Never use strong solvents such as thinner or benzene, which might damage the finish of the cabinet.

## Repacking

Keep the original carton and packing materials to use for safe transport of your TV in the future.

If you have any questions or problems concerning your TV, please contact your nearest Sony dealer.

For details concerning safety precautions, see the supplied leaflet "IMPORTANT SAFEGUARDS."

## CAUTION:

When using TV games, computers, and similar products with your TV, keep the brightness and contrast functions at low settings. If a fixed (non-moving) pattern is left on the screen for long periods of time at a high brightness or contrast setting, the image can be permanently imprinted onto the screen. These types of imprints are not covered by your warranty because they are the result of misuse.

This television receiver provides display of television closed captioning in accordance with § 15.119 of the FCC rules. (USA models only)

# Table of Contents

---

## Preface

Warning/Precautions .....	2
Introducing the Sony Trinitron® Color TV .....	4
Identifying Your TV .....	5
Locating the Controls .....	7

---

## Chapter 1: Setting Up

Connecting TV Antenna/Cable .....	11	Erasing unnecessary channels – CHANNEL ERASE .....	20
Using the On-Screen Menus .....	13	Presetting only desired channels – CHANNEL ADD .....	22
Navigating through the menus .....	15	Connecting Other Equipment .....	23
Changing the menu language .....	15	Connecting video equipment .....	23
Turning the Cable Mode On or Off .....	17	Connecting headphones .....	26
Presetting TV Channels .....	18	Watching a video with your S video-equipped VCR .....	27

---

## Chapter 2: Using Basic Features

Watching TV Programs .....	28	Adjusting Picture and Sound Quality .....	30
Using Convenient Features .....	29	Adjusting picture quality .....	30
Muting the sound – MUTING .....	29	Receiving Multichannel TV Sound programs – MTS .....	32
Keeping the displays on-screen – DISPLAY .....	29	Turning the speaker on or off .....	34
Setting the sleep timer – SLEEP .....	29	Using Closed Caption .....	35
Switching quickly between two channels – JUMP .....	29		

---

## Chapter 3: Using Advanced Features

Using the Timer-Activated Functions .....	36	Setting channel captions – CH CAPTION .....	42
Setting the clock – CURRENT TIME SET .....	36	Viewing the captioned channels – CHANNEL GUIDE .....	44
Setting the ON/OFF TIMER .....	38	Using the Cordless Headphones .....	45
Setting CHANNEL BLOCK .....	40		
Customizing the Screen Display .....	42		

---

## Appendix

Specifications .....	47
Troubleshooting .....	Back cover

---

# Introducing the Sony Trinitron® Color TV

## About the Manual

This manual covers 11 different models. The illustrations and menu displays are based on model KV-20TS32, the model with the most functions. If a particular function does not apply to your model, this will be noted in the manual.

We highly recommend that you read this manual before using your TV. Keep the manual handy for future reference.

## Feature

With the following features, you can:

- Watch up to 125 cable channels for a total of 181 possible off-air and cable channels with the **multiband VHF/UHF/CATV tuner**.
- Watch the picture and listen the sound of your VCR through the **video input jacks**.
- Watch superior VCR playback pictures when you connect a VCR equipped with an S VIDEO output jack to the **S VIDEO input jack**.
- Watch your portable camera images (8mm, video, etc.) by connecting to the **video input jacks** on the front panel.
- Enjoy stereo programs and Second Audio Program (SAP) broadcasts with the built-in **Multichannel TV Sound (MTS) decoder**.
- Set the Menu screen either in English or Spanish with **Dual Language** function.
- Call up on-screen menus to set timer-activated functions (Current Time Set, On/Off Timer, and Channel Block) by using the **TIME** feature.
- Call up on-screen menus to set the Cable On/Off, Channel Erase/Add, and Channel Caption/Guide by using the **SET UP** feature.
- Enjoy using the cordless headphones by connecting to the **IR EMITTER terminal** (Infrared emitter terminal) (KV-20TS50 only).
- View the closed caption and the text by using **Closed Caption**.

With the supplied Remote Commander, you can:

- Switch quickly between two channels by using **JUMP**.
- Set the TV to automatically shut off after 30, 60, and 90 minutes by using the **SLEEP** timer.

And enjoy other features giving you a high quality picture...

- **Colorpure Filter™** produces fine picture detail without color spill or color noise.
- The **New Dynamic Picture™** system adjusts picture contrast automatically to produce more detail in both bright and dark areas of every scene.

# Identifying Your TV



## Identifying Your TV

Check the model number of your TV set.

This manual covers 11 models and there are slight differences among them. Check the table below to see what your TV is equipped with before you start operating it.



Introducing the Sony Trinitron® Color TV  
Identifying Your TV

Table of models	YES: equipped	NO: not equipped			
	KV-13TR28/29 KV-1430R KV-1440WR	KV-20TR23 KV-2150R KV-2160WR	KV-20TS29 KV-2170RS KV-21STR2	KV-20TS32	KV-20TS50
MTS stereo	NO	NO	YES	YES	YES
Headphones jack	YES*	YES*	NO	YES	NO
Video input jack	NO	NO	NO	YES	NO
Front panel A/V jacks	YES	NO	NO	YES	YES

\* Monaural sound is output by both headphone speakers.

	KV-13TR28/29 KV-20TR23 KV-20TS29	KV-20TS32 KV-20TS50	KV-1430R KV-2150R KV-2170RS	KV-1440WR KV-2160WR KV-21STR2
Model destination	U.S.A./Canda		Central South America and other area	
Closed caption	YES**		NO	
Dual Language	NO		YES	

\*\* U.S.A. models only.

# Identifying Your TV

## Design

KV-13TR28/29 KV-1430R  
KV-1440WR

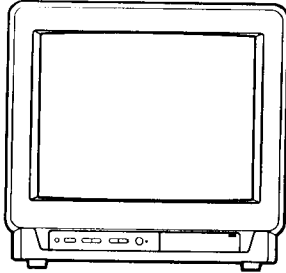

KV-20TR23 KV-2150R  
KV-2160WR

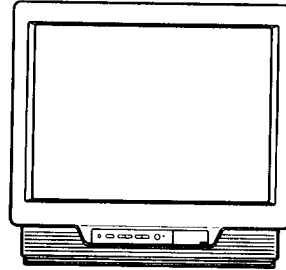

KV-20TS29 KV-2170RS  
KV-21STR2

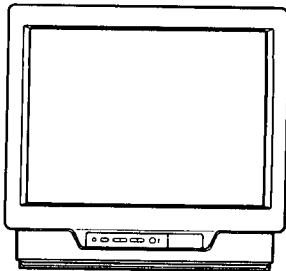

KV-20TS32 KV-20TS50

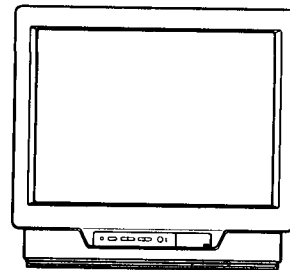

# Locating the Controls



## Screen Displays

For details, see the pages indicated by the numbered black circles ●.

Identifying Your TV  
Locating the Controls

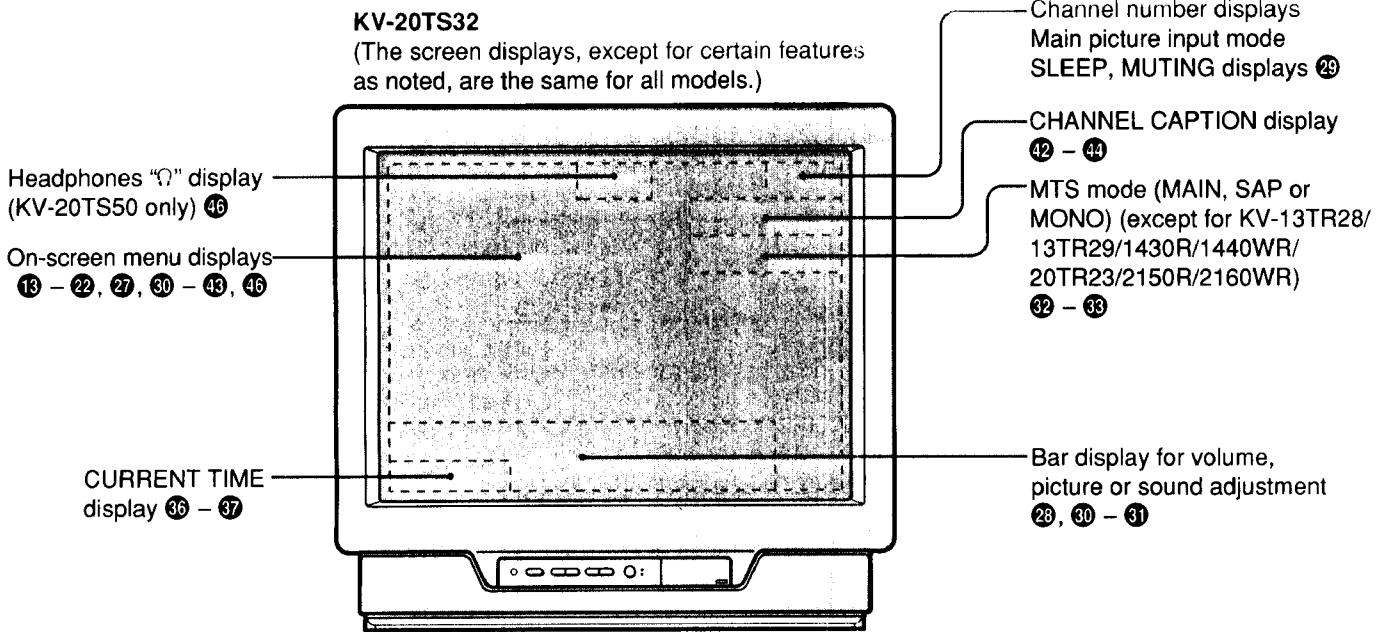

# Locating the Controls

## Front Panel

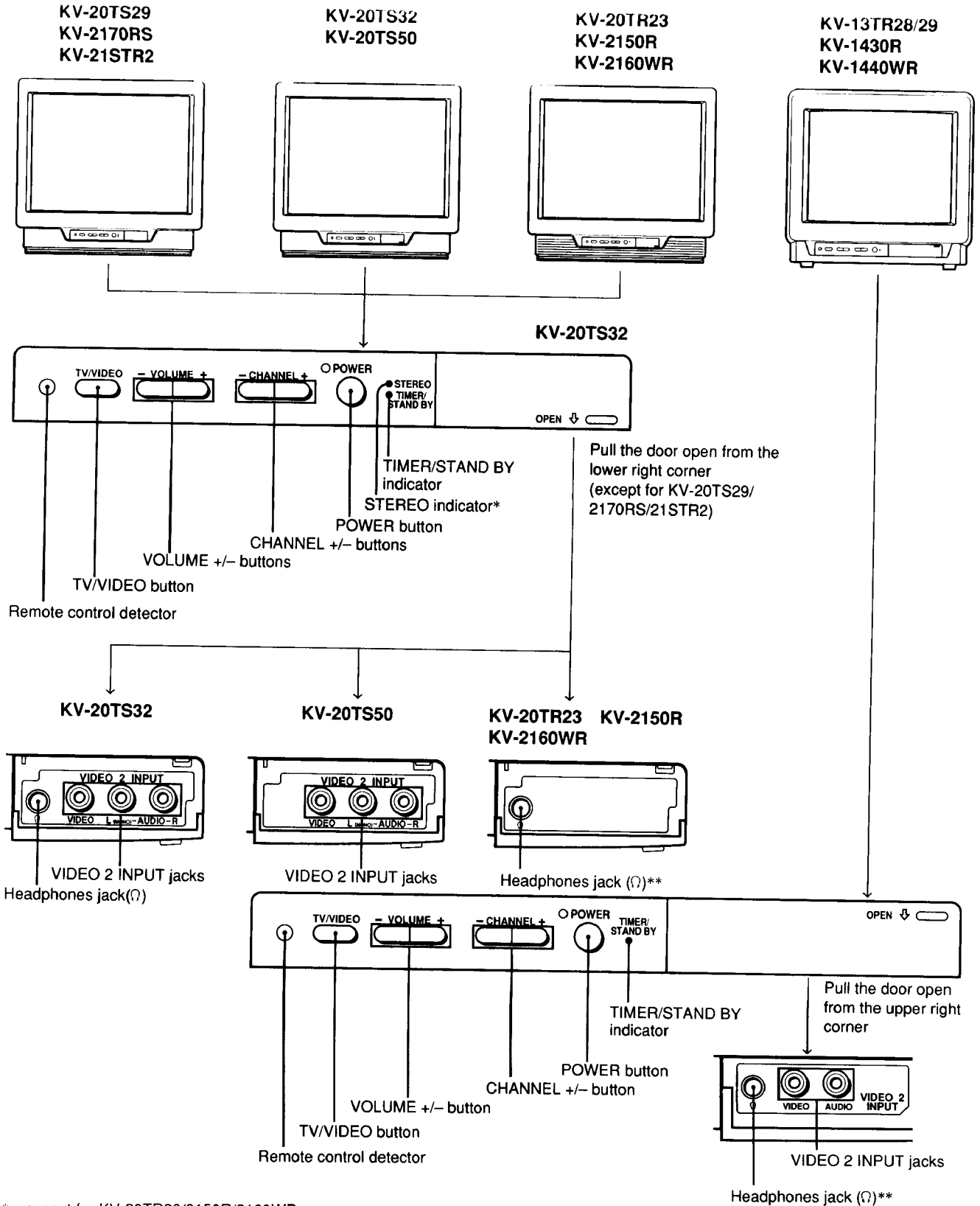

\* except for KV-20TR23/2150R/2160WR

\*\* Monaural sound is output by both headphone speakers.





# Rear Panel

For details, see the pages indicated by the numbered black circles ●.

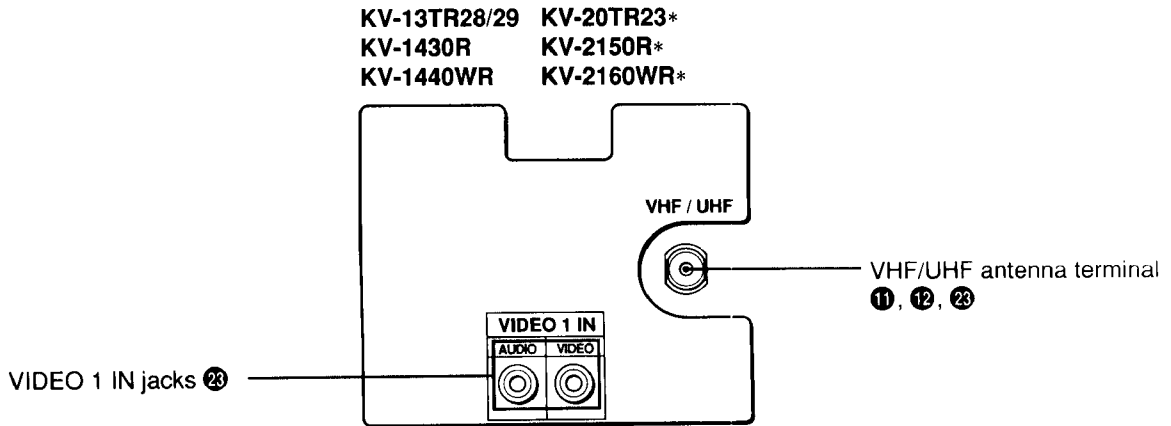
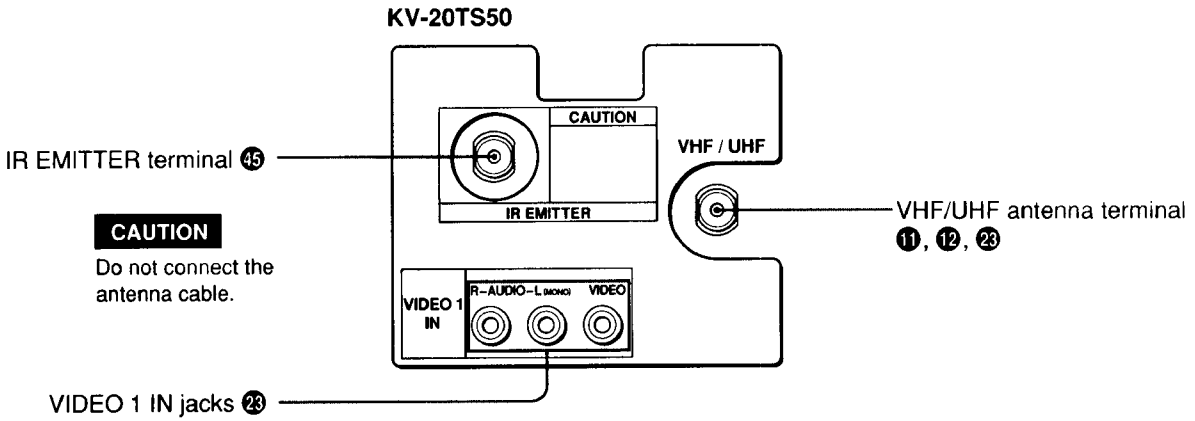
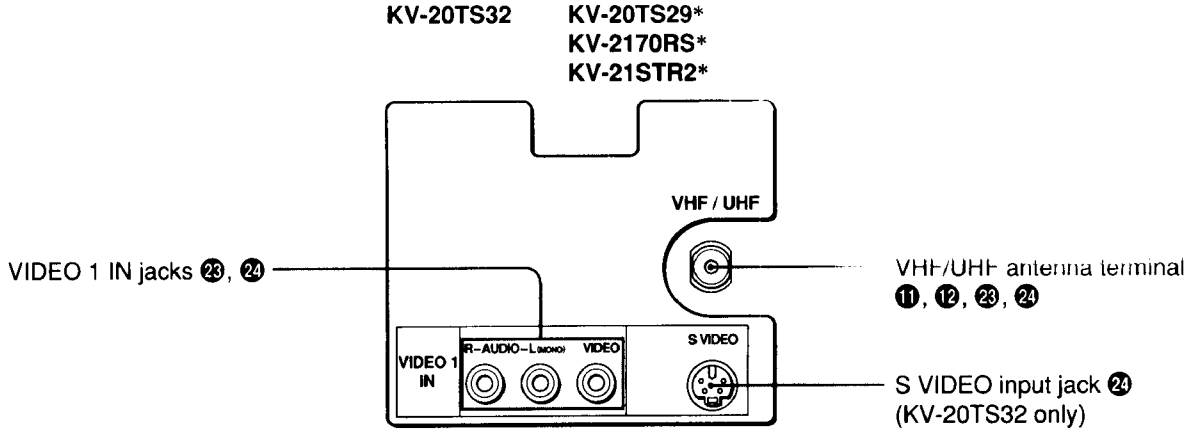

\* These models are equipped with only one set of video input jacks.

# Locating the Controls

## Remote Commander

For details, see the pages indicated by the numbered black circles ●.

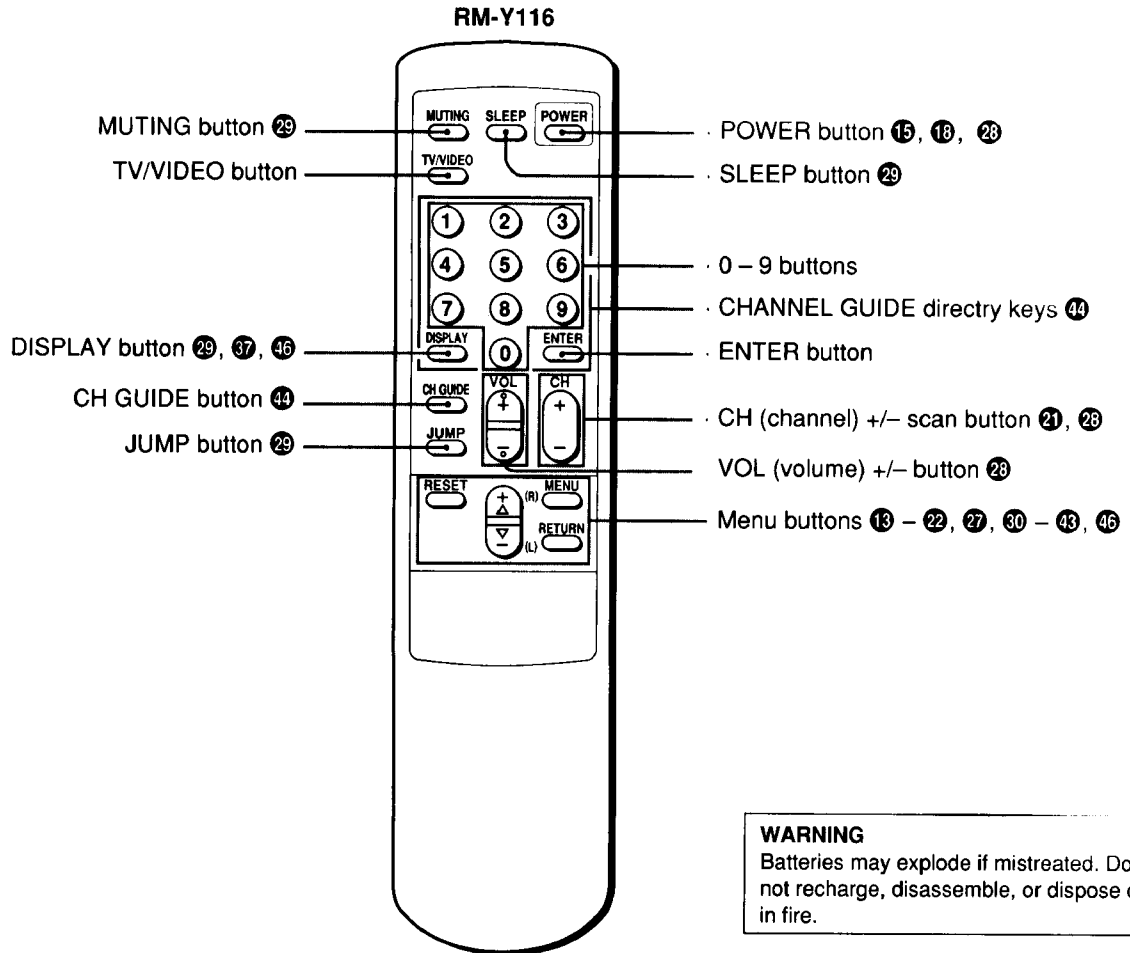

## Installing batteries

- 1 Remove the battery compartment cover.

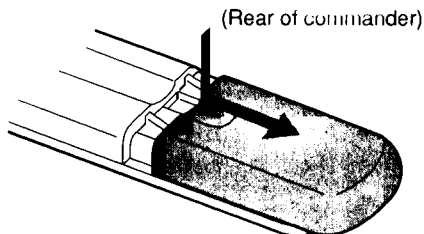

- 2 Insert two size AA (R6) batteries in correct polarity.

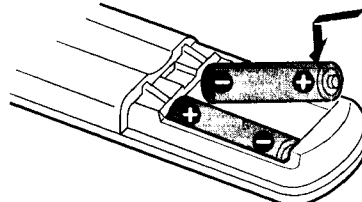

### Battery life

With normal operation, batteries will last up to half a year. If the Remote Commander dose not operate properly, the batteries might be exhausted. Replace both of them with new ones.

### To avoid damage from possible battery leakage

Remove the batteries if you do not plan to use the Remote Commander for a fairly long time.



Although you can use either an indoor or outdoor antenna with the TV, an outdoor antenna will provide you with better picture quality. You can receive cable TV by connecting a cable supplied by your local cable company.

## Connecting VHF, UHF or VHF/UHF Combination Antenna\*, or CATV Cable

### 75-ohm coaxial cable (round)

- 1 Check your antenna cable type and prepare the end of the cable using the F-type connector.

Attach an F-type connector (not supplied).

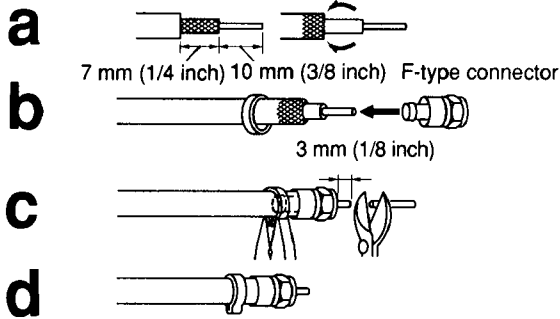

- 2 Plug the connector into the VHF/UHF terminal at the rear of the TV.

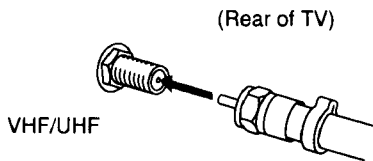

### 300-ohm twin-lead cable (flat)

- 1 Check your antenna cable type and prepare the end of the cable using the 300-ohm twin-lead cable.

Attach the supplied antenna connector.

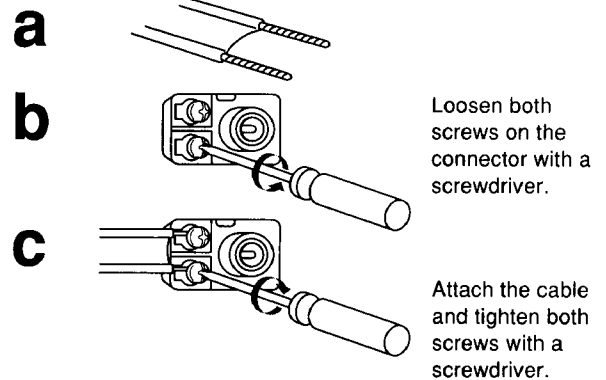

- 2 Plug the connector into the VHF/UHF terminal at the rear of the TV.

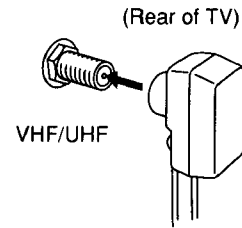

\* Most combination antennas are equipped with a signal splitter. Remove the splitter and attach the appropriate connector.

### CAUTION (for KV-20TS50)

Do not connect the antenna cable to the IR EMITTER terminal. If you do so, the TV antenna could break. The IR EMITTER terminal is covered with a plastic cap to prevent misconnection.

# Connecting TV Antenna/Cable

## Connecting Both VHF and UHF Antennas

Use the EAC-66 U/V mixer (not supplied).

- 1** Prepare the VHF antenna end using the appropriate connector (p. 11).
- 2** Connect the cables to the mixer.
- 3** Attach the mixer to the VHF/UHF terminal.

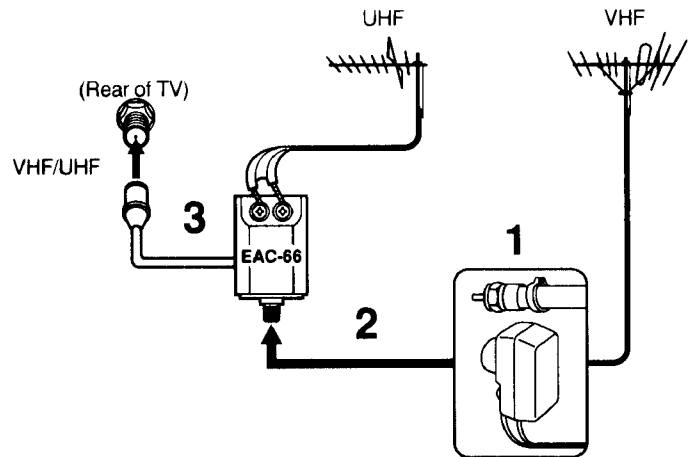

### When the U/V mixer is used

Snow and noise may appear in the pictures when viewing cable TV channels over 37 (W + 1).

## Connecting a Dipole Antenna

Use the dipole antenna.

- 1** Attach the supplied antenna connector to the end of the dipole antenna cable.

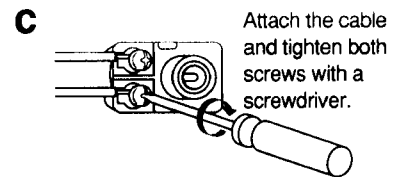
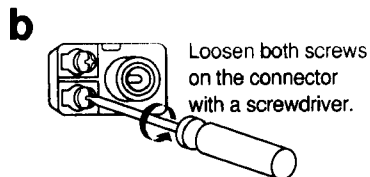
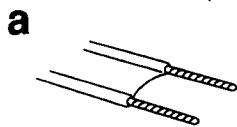

- 2** Put the dipole antenna into the slot at the top of the TV. Plug the dipole antenna connector into the VHF/UHF terminal at the rear of the TV.

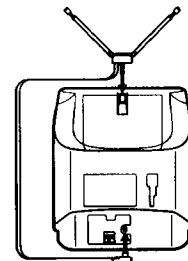

- 3** Adjust the dipole antenna for better picture quality.

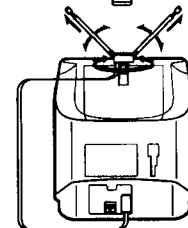

VHF/UHF

### Note

For better picture quality, we would recommend you to connect an outdoor antenna.

# Using the On-Screen Menus



The following flow chart shows the different levels of on-screen menus that you can use to make various adjustments and settings. See the indicated pages for instructions on using each feature.

## For picture quality adjustment

Main menu

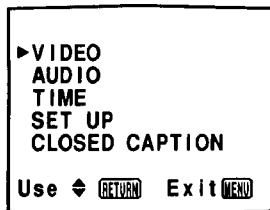

VIDEO menu (pp. 30-31)

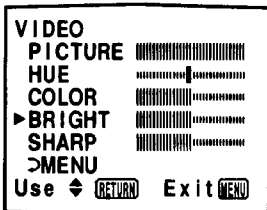

Adjustment bar

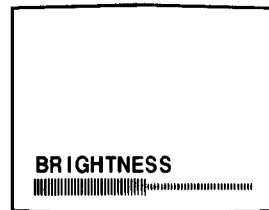

## For sound quality adjustment

Main menu

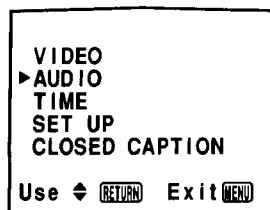

AUDIO menu (pp. 32-34)

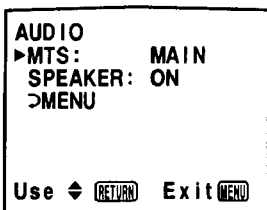

## For time-related setting

Main menu

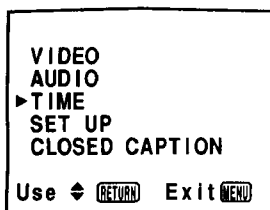

TIME menu

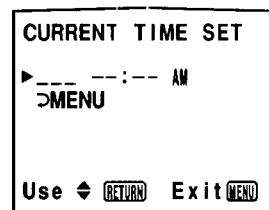
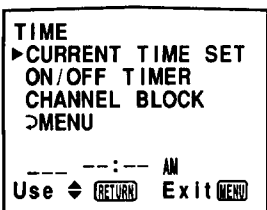

CURRENT TIME SET screen (pp. 36-37)

## For language setting (pp. 15-16)

Main menu

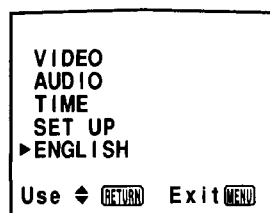

(KV-1430R/2150R/2170RS/1440WR/2160WR/21STR2 only)

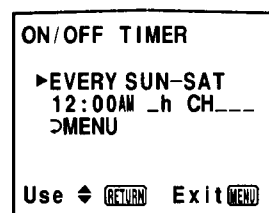

ON/OFF TIMER screen (pp. 38-39)

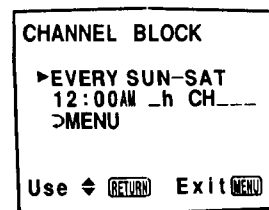

CHANNEL BLOCK screen (pp. 40-41)

## For cordless headphones setting (p. 46)

(KV-20TS50 only)

Main menu

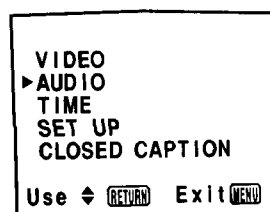

AUDIO menu

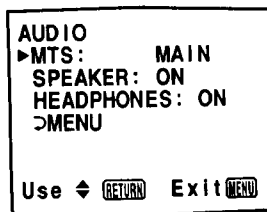

Connecting TV Antenna/Cable Using the On-Screen Menus

# Using the On-Screen Menus

For presetting and other functions

Main menu

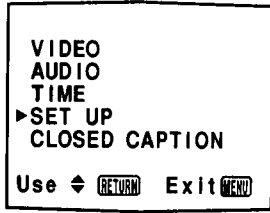

SET UP menu

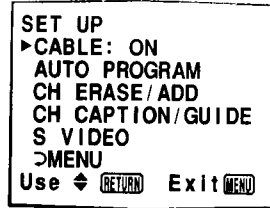
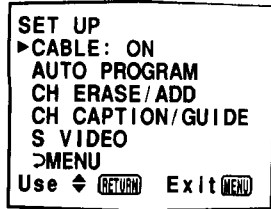

CABLE ON/OFF screen  
(p. 17)

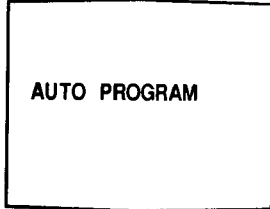

AUTO PROGRAM screen  
(pp. 18-19)

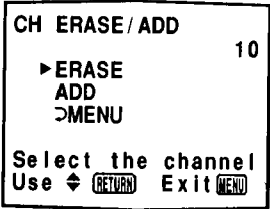

CHANNEL ERASE/ADD screen  
(pp. 20-22)

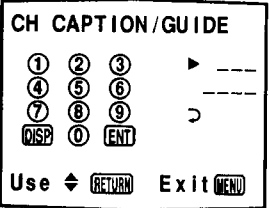

CHANNEL CAPTION/GUIDE  
screen (pp. 42-43)

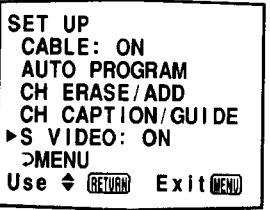

S VIDEO ON/OFF screen  
(p. 27)

For closed caption setting (p. 35)

Main menu

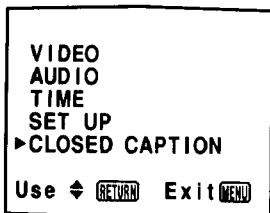

CLOSED CAPTION screen

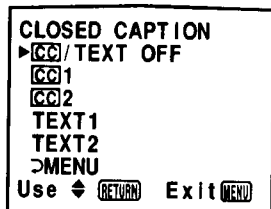

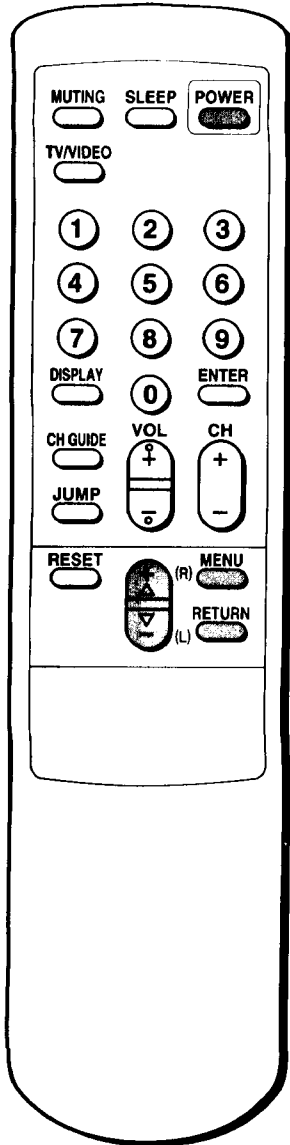

RM-Y116

### Navigating Through the Menu

**To display the main menu**  
Press MENU.

**To return to the previous menu**  
Press  $\Delta+$  or  $\nabla-$  to select  $\square$  MENU.  
Then press RETURN.

**To return to the main menu**  
Repeat the above, until you reach the main menu.

**To return to the normal screen**  
Press MENU on the Remote Commander.

#### Note

The menu disappear automatically if you do not press a button within 90 seconds.

### Changing the Menu Language

(KV-1430R/2150R/2170RS/1440WR/2160WR/21STR2 only)

The menu language is factory-set to ENGLISH. Follow these instructions to change the menu language to Spanish or back to English.

**1** Press POWER on the TV or the Remote Commander to turn the TV on.

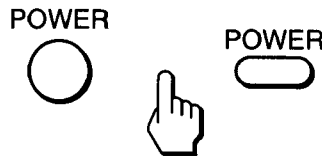

**2** Press MENU.  
*The main menu appears.*

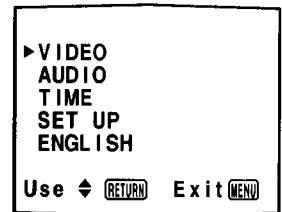

**3** Press the  $\Delta+$  or  $\nabla-$  to select ENGLISH.  
Then press RETURN.

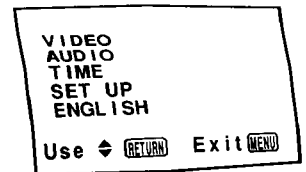
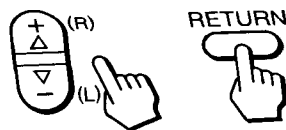

# Using the On-Screen Menus

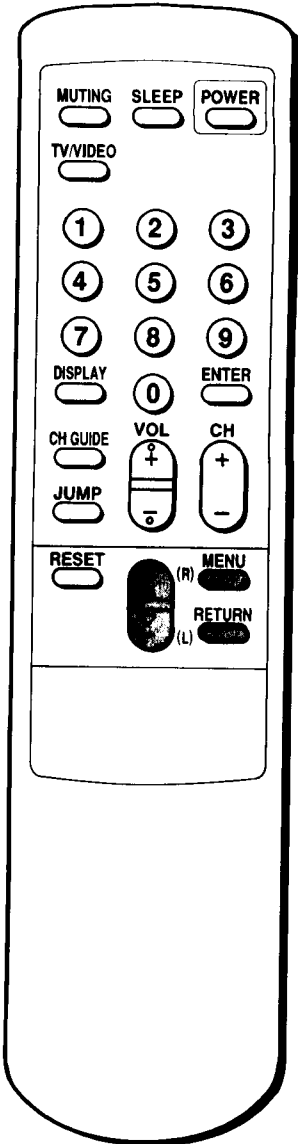

RM-Y116

To return to the normal screen  
Press MENU.

- 4** Press  $\Delta+$  or  $\nabla-$  to select the language.  
Each time you press  $\Delta+$  or  $\nabla-$ , the ESPAÑOL and ENGLISH menus appear.

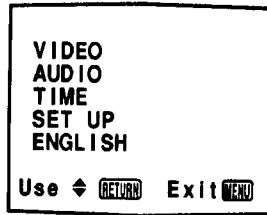
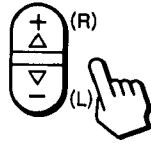

**Note**

Certain parts of the ESPAÑOL menus remain in English.

- 5** Press RETURN.  
The language is selected.

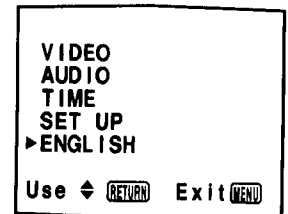



# Turning the Cable Mode On or Off

All of the controls are on the Remote Commander.

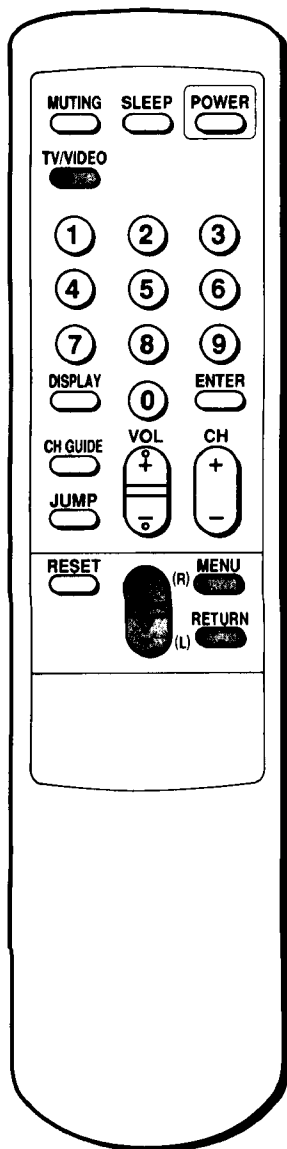

RM-Y116

If you have cable connected to your TV (p.11), follow the steps below to turn the cable connection on or off. CABLE is preset to ON when you use your TV for the first time. Turn CABLE to OFF to preset or watch VHF or UHF channels (pp. 18–22, 28).

**1** Press MENU.  
The main menu appears.

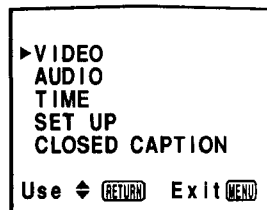

**2** Press  $\Delta+$  or  $\nabla-$  to select SET UP.

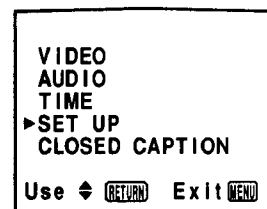
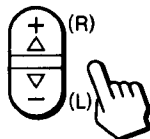

Press RETURN.  
The SET UP menu appears, and the cursor points to CABLE.

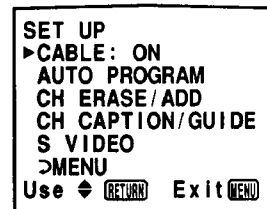

**Note**

If the CABLE display appears in black, the TV is in video mode and you cannot select CABLE. Press TV/VIDEO to change to TV mode.

**3** Press RETURN again.



Press  $\Delta+$  or  $\nabla-$  to select ON or OFF alternately.

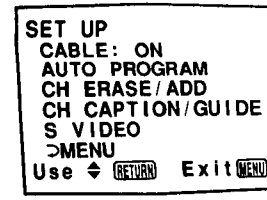
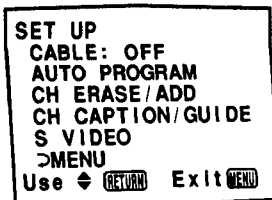

To return to the normal screen  
Press MENU.

Press RETURN.  
The setting is completed.

Using the On-Screen Menus  
Turning the Cable Mode On or Off

# Presetting TV Channels

By presetting TV channels to the TV, you can select channels by pressing CHANNEL +/- on the TV or CH +/- on the Remote Commander.

## Presetting TV Channels Automatically

### Note

Perform auto programming during the day rather than late at night, when some channels may not be broadcasting.

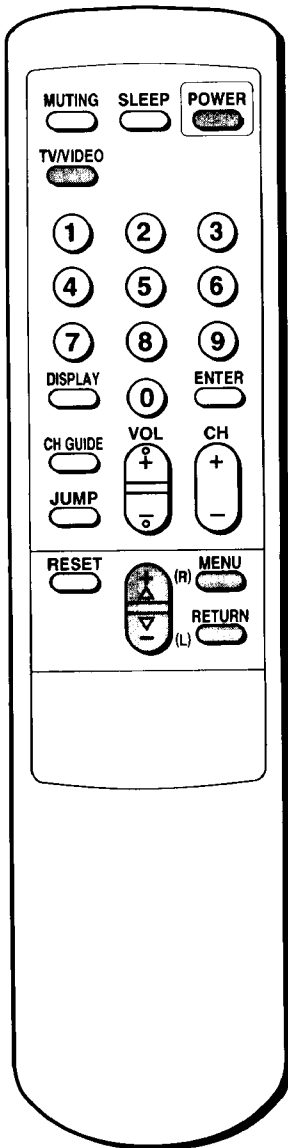

RM-Y116

- 1 Press POWER on the TV or the Remote Commander to turn the TV on.

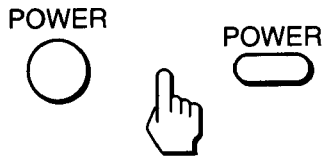

- 2 Turn the cable connection on or off to select the type of channel you want to preset, VHF/UHF or cable TV. (Follow the steps in "Turning the Cable Mode On or Off," p. 17.)

- 3 Press MENU. The main menu appears.

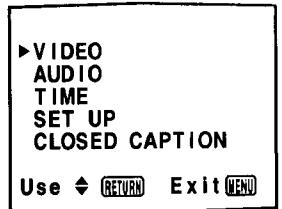

- 4 Press  $\blacktriangleup$  or  $\blacktriangledown$  to select SET UP.

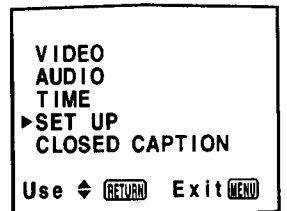
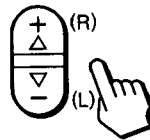

Press RETURN. The SET UP menu appears.

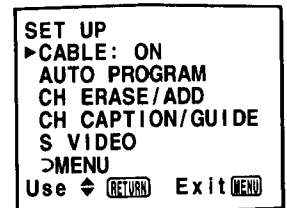

### Note

If the AUTO PROGRAM display appears in black, the TV is in video mode and you cannot select AUTO PROGRAM. Press TV/VIDEO to change to TV mode.



# 5 Press Δ+ or ▽- to select AUTO PROGRAM.

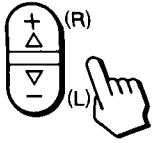

```

SET UP
CABLE: ON
▶AUTO PROGRAM
CH ERASE/ADD
CH CAPTION/GUIDE
S VIDEO
>MENU
Use ◀ RETURN Exit MENU
  
```

Press RETURN.

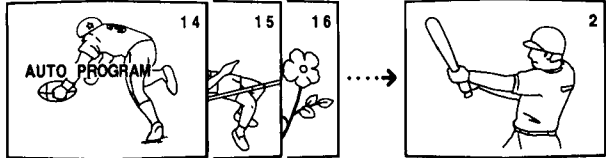

*"AUTO PROGRAM" appears on the screen and receivable channels (other than the channels already preset) are preset in numerical sequence. The channels previously preset will not remain in the TV's memory. When no more channels can be found, the programming stops and the lowest numbered channel is displayed.*

**Receivable channels for this TV**  
VHF: 2 – 13  
UHF: 14 – 69  
Cable: 1 – 125

**To select TV channels without presetting**  
Press 0 – 9 and ENTER.

**To return to the normal screen**  
Press MENU.

**To erase unnecessary channels, or to add channels that could not be preset automatically** because their signal was too weak, follow the steps in "Erasing Unnecessary Channels – CHANNEL ERASE" (pp. 20–21) and "Presetting Only Desired Channels – CHANNEL ADD" (p. 22).

# Presetting TV Channels

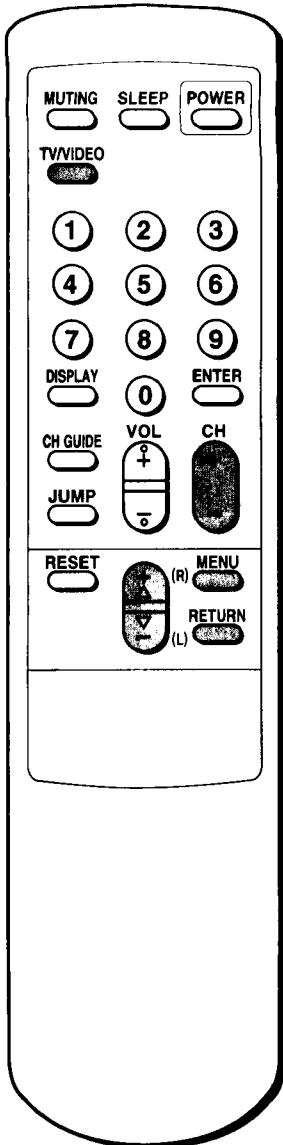

RM-Y116

## Erasing Unnecessary Channels — CHANNEL ERASE

Use this feature to erase unnecessary TV channels, so that when you press CH +/-, the channel(s) are skipped.

- 1 Press MENU.  
*The main menu appears.*

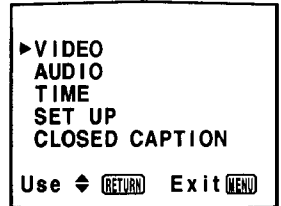

- 2 Press  $\blacktriangle$ + or  $\blacktriangledown$ - to select SET UP.

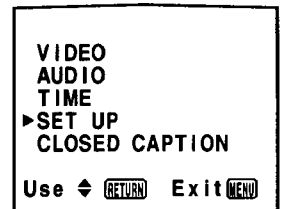
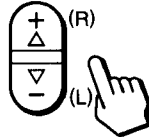

Press RETURN.  
*The SET UP menu appears.*

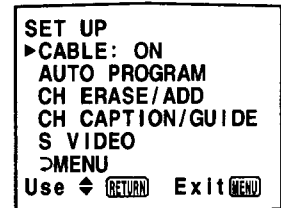

- 3 Press  $\blacktriangle$ + or  $\blacktriangledown$ - to select CH ERASE/ADD.

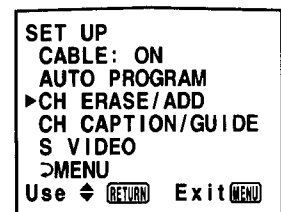
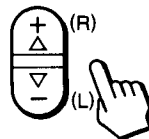

Press RETURN.  
*The CH ERASE/ADD screen appears, and the cursor points to ERASE.*

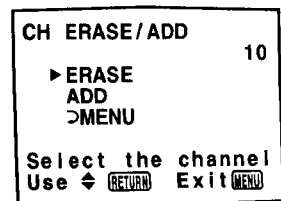

### Note

If the CHANNEL ERASE/ADD display appears in black, the TV is in video mode and you cannot select CHANNEL ERASE/ADD. Press TV/VIDEO to change to TV mode.



**4** Press the CH +/- button to select the channel you want to erase.  
For example, to erase channel 8, press CH + or - until 8 appears.

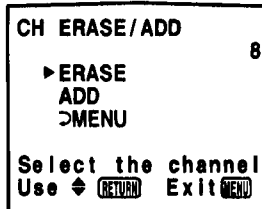
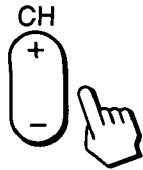

Press RETURN.  
A "-" sign appears in front of the channel number display showing that the channel is erased from the channel scan memory.

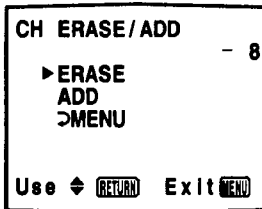

The next time you press the CH +/- buttons, channel 8 will be skipped.

**To erase other channels**  
Repeat step 4.

**To return to the normal screen**  
Press MENU.

**Note**

If you erase a VHF or UHF channel, the cable TV channel with the same number is also erased, and vice versa.

**Cable TV channel chart\***

Cable TV systems use letters or numbers to designate channels. To tune in a channel, refer to the chart below.

Number on this TV	Corresponding cable TV channel
1	A-8
5	A-7
6	A-6
14	A
15	B
16	C
17	D
18	E
19	F
20	G
21	H
22	I
23	J
24	K
25	L
26	M
27	N
28	O
29	P
30	Q
31	R
32	S
33	T
34	U
35	V
36	W
37	W+1
38	W+2
39	W+3
⋮	⋮
93	W+57
94	W+58
95	A-5
96	A-4
97	A-3
98	A-2
99	A-1
100	W+59
101	W+60
102	W+61
⋮	⋮
123	W+82
124	W+83
125	W+84

\* This designation of cable TV channels conforms to the EIA/NCTA recommendation. Check with your local cable TV company for more complete information on the available channels.

Presetting TV Channels

# Presetting TV Channels

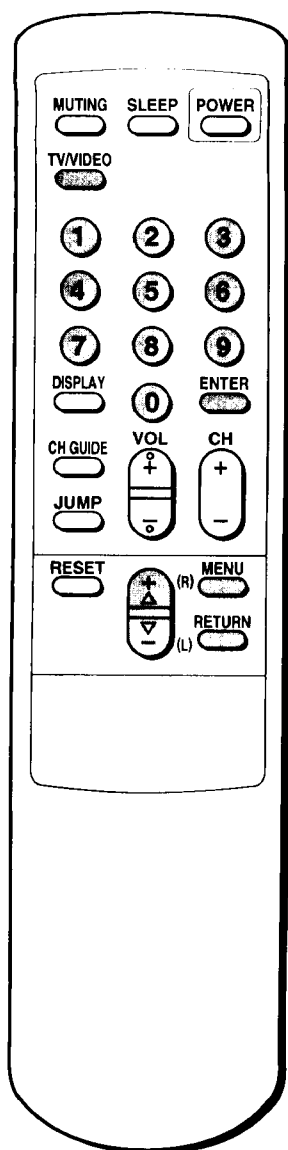

RM-Y116

## Presetting Only Desired Channels—CHANNEL ADD

Use this feature to add channels one by one to the channel scan memory.

**1-3** (Follow steps 1-3 in "Erasing Unnecessary Channels – CHANNEL ERASE," p. 20.)

### Note

If CH ERASE/ADD display appears in black, the TV is in video mode and you cannot select CH ERASE/ADD. Press TV/VIDEO to change to TV mode.

**4** Press  $\Delta+$  or  $\nabla-$  to select ADD.

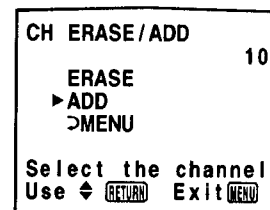
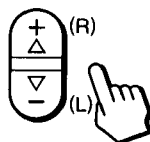

**5** Press 0–9 and ENTER to select the channel you want to add. For example, to add channel 25, press 2, 5 and ENTER.

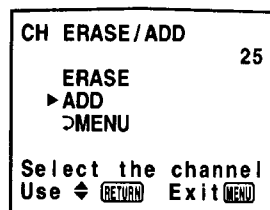
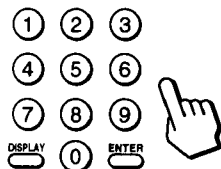

Press RETURN.

A "+" sign appears in front of the channel number display showing that the channel is added to the channel scan memory.

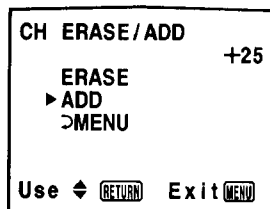

**To add other channels**

Repeat step 5.

**To return to the normal screen**  
Press MENU.

### Note

If you add a VHF or UHF channel, the cable TV channel with the same number is also added, and vice versa.

# Connecting Other Equipment



## Connecting Video Equipment

After connecting, you will be able to play back video tapes.

### Connecting video equipment to a stereo TV

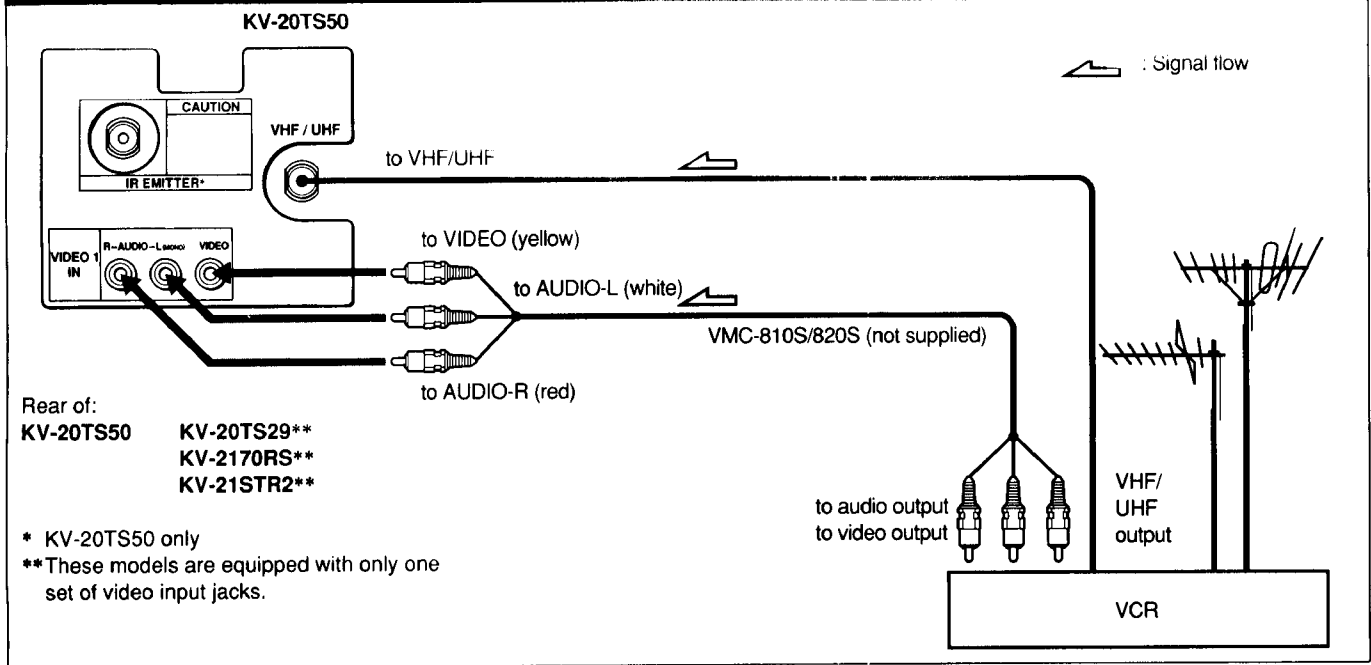

Presetting TV Channels  
Connecting Other Equipment

#### Note

If you connect a monaural VCR, connect the audio output of the VCR to the L (MONO) jack of VIDEO IN on the TV. The monaural sound will be heard from both speakers.

### Connecting video equipment to a monaural TV

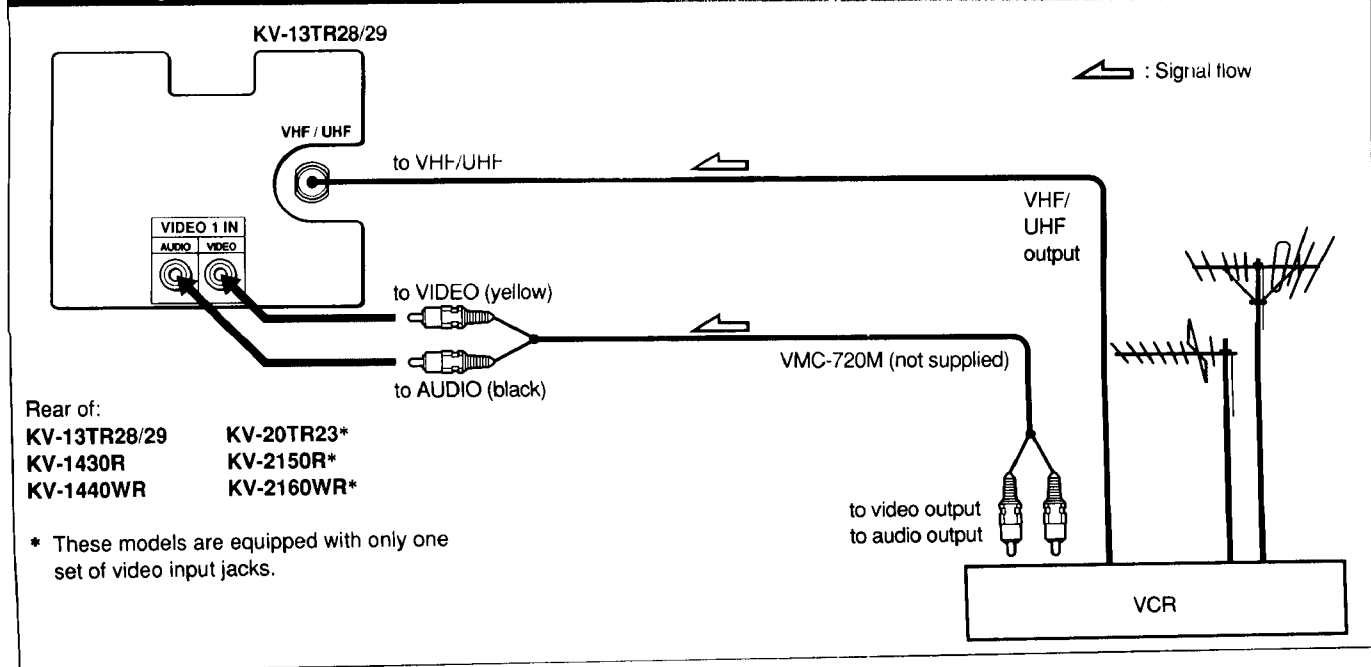

## Connecting video equipment to a stereo TV with an S video input jack (KV-20TS32 only)

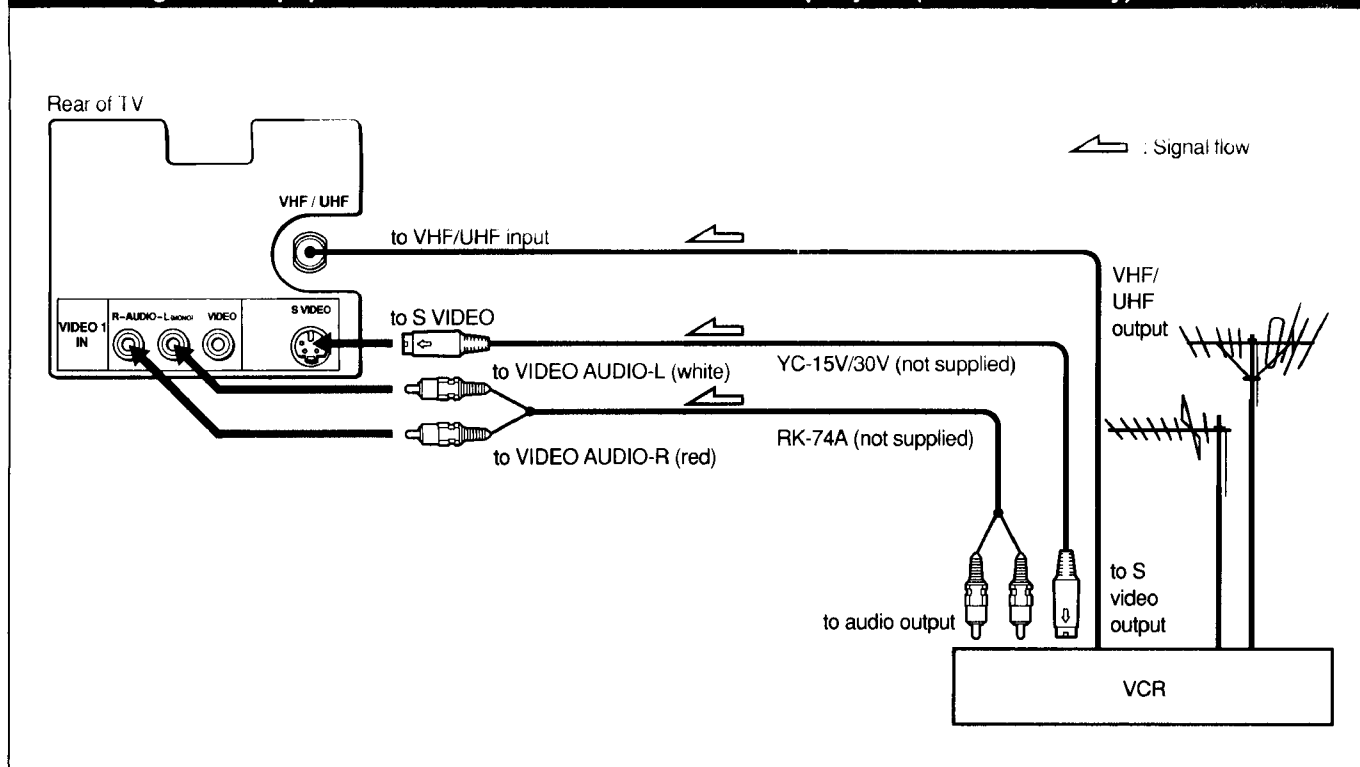

### Preparing for use

- 1 Turn on the TV.
- 2 Press the TV/VIDEO button on the TV or on the Remote Commander so that "VIDEO" appears on the screen.

### When you cannot obtain a clear picture and/or sound

Make sure that the TV/VTR on the VCR is set to TV.  
Reselect the channel you want to view with the controls on the TV or the Remote Commander.

### To return to TV mode

Press the TV/VIDEO button on the TV or Remote Commander so that a channel number appears on the screen.

### About S video input

Video input and output signals can be separated into Y (luminance or brightness) and C (chroma or color) signals. Usually these two signals are combined in a VCR and sent as one signal to a TV. Separation of the Y and C signals prevents them from interfering with one another, thereby improving picture (especially color) quality.

This TV is equipped with an S video input jack through which these separated signals can be input directly. This way you can connect your S video-equipped VCR separately from a non-S video VCR.

### Notes

- For operating instructions, refer to the instruction manual furnished with the VCR.
- If the picture or sound is affected, move the VCR away from the TV.
- If S VIDEO is set to OFF, you cannot watch VCR playback pictures from the S VIDEO input. To set S VIDEO to ON, see "Watching a Video with Your S Video-Equipped VCR," p. 27.





## Connecting Camcorders

### Playing back recorded tapes

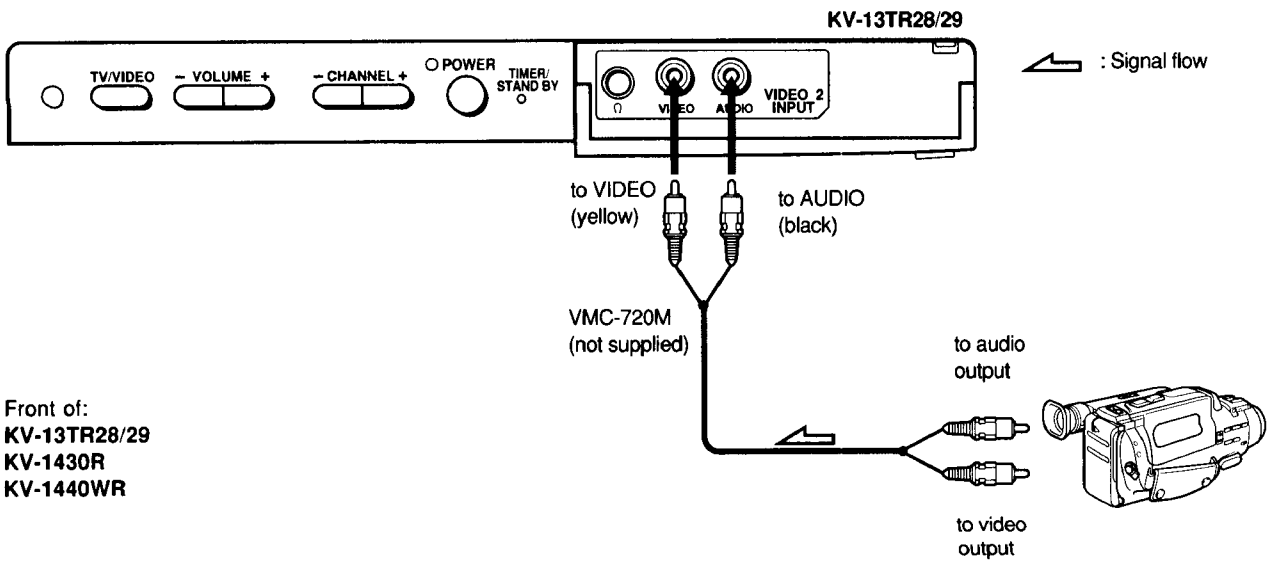
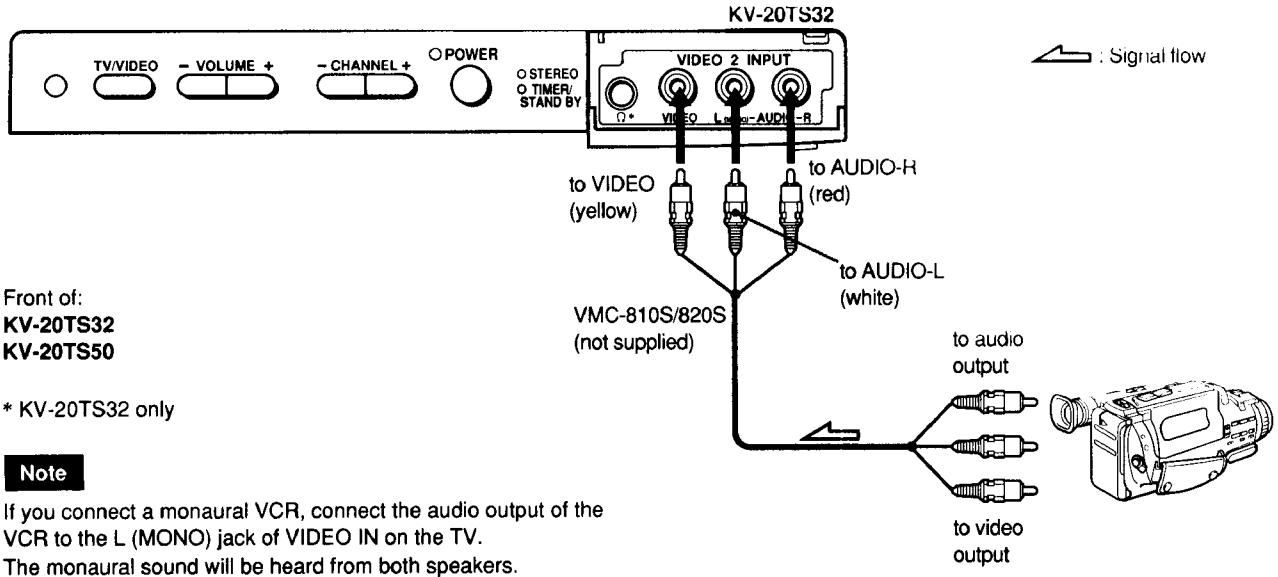

## Connecting Other Equipment

### Connecting Headphones (except for KV-20TS50/20TS29/2170RS/21STR2)

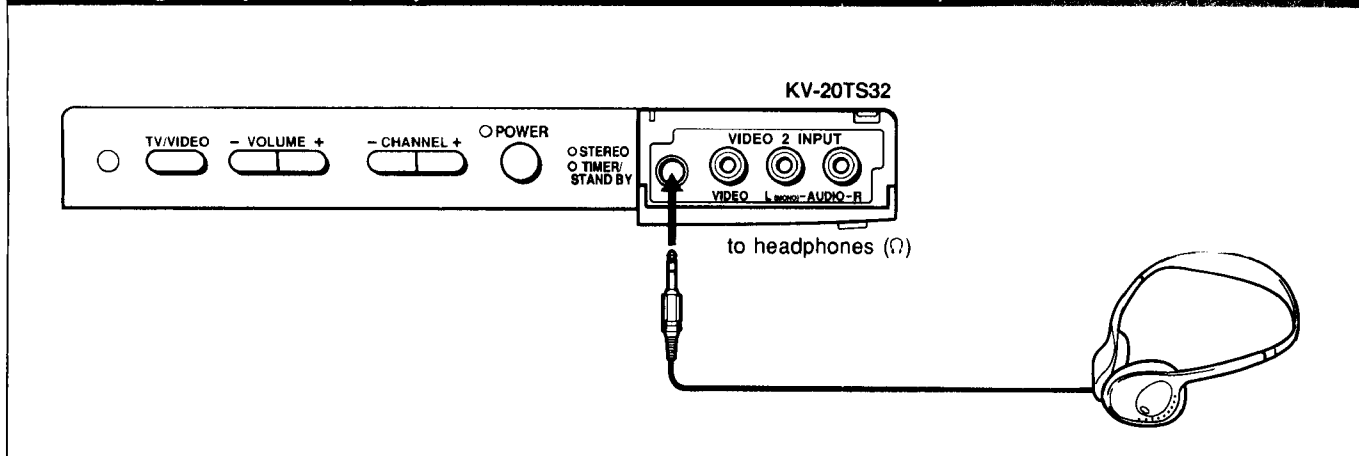

#### Notes

- To prevent hearing damage due to sudden or prolonged excessive volume, do not raise the headphones volume too high while listening.
- If your TV is a monaural TV, the monaural sound will be heard from both headphones.

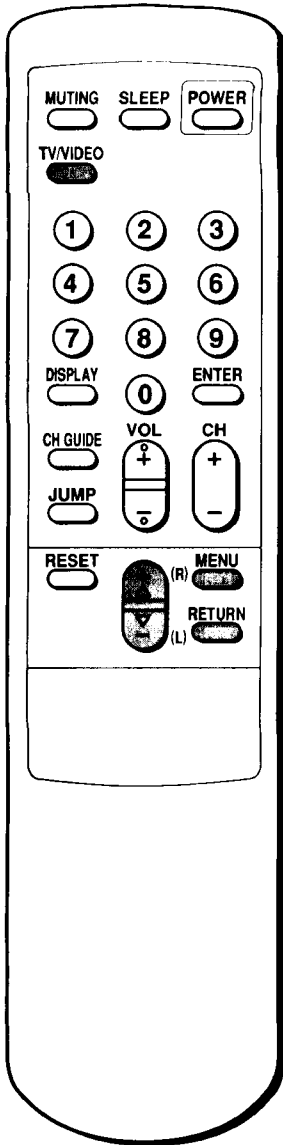

RM-Y116

## Watching a Video with Your S Video-Equipped VCR

**(KV-20TS32 only)**

Use this feature to set S VIDEO to ON or OFF depending on the kind of video equipment you have connected to the TV.

For instructions on connecting video equipment, see p. 24.

### Note

If the TV is in TV or VIDEO 2 mode, the S VIDEO display appears in black and cannot be selected.

Press TV/VIDEO to change to VIDEO 1 mode.

- 1 Press MENU.  
*The main menu appears.*

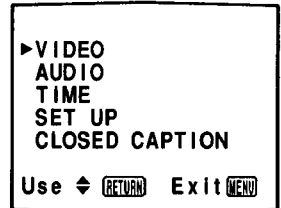

- 2 Press  $\Delta+$  or  $\nabla-$  to select SET UP.

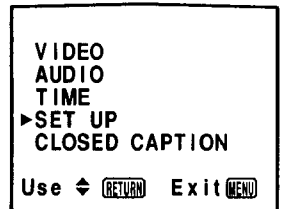
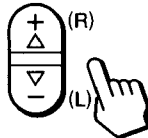

Press RETURN.  
*The SET UP menu appears.*

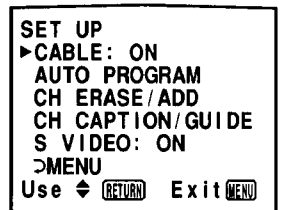

- 3 Press  $\Delta+$  or  $\nabla-$  to select S VIDEO.  
Then press RETURN.

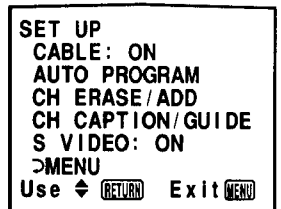
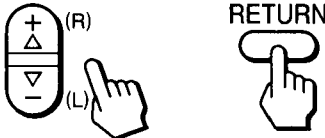

Press  $\Delta+$  or  $\nabla-$  to select ON or OFF alternately.

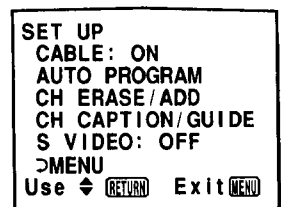
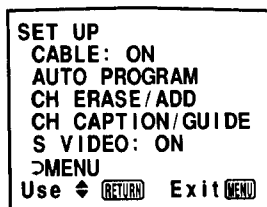

Press RETURN.  
*The setting is completed.*

**To return to the normal screen**  
Press MENU.

### Note

If you set S VIDEO to ON, the TV automatically receives S video signals whenever a VCR with S video is connected.

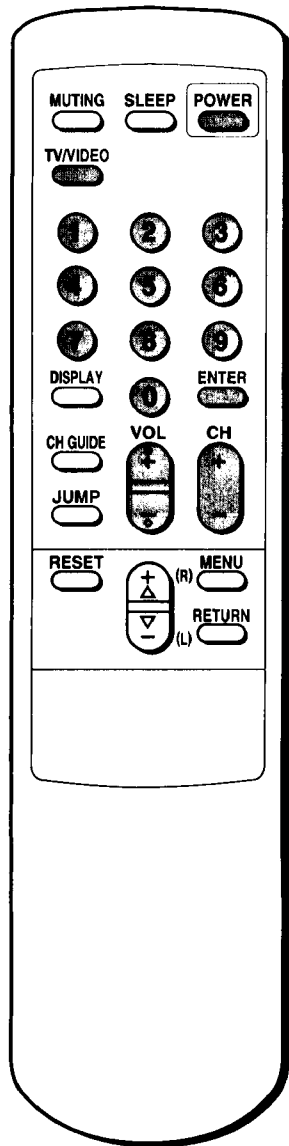
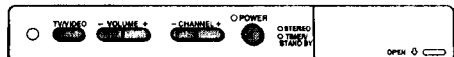

RM-Y116

**1** Press POWER on the TV or the Remote Commander to turn the TV on.

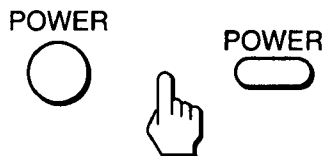

The TIMER/STANDBY indicator blinks until the picture appears on the screen.

**2** Turn the cable mode on or off to select the type of channel you want to watch, VHF/UHF or cable TV.  
(Follow the steps in "Turning the Cable Mode On or Off," p. 17.)

If "VIDEO" or "S VIDEO" is displayed on the screen, press the TV/VIDEO button on the TV or on the Remote Commander so that the channel number appears.

**3** Select a channel in one of the following two ways:

**To scan the preset channels\* in numerical sequence**  
Press CH +/-.

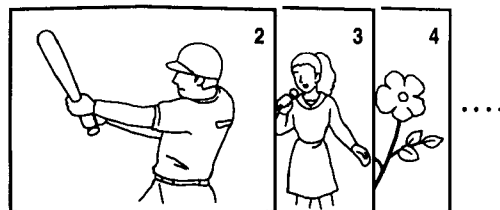
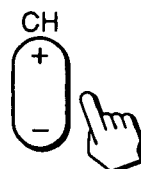

\* For more information on presetting channels, see pp. 18 – 22.

**To select a channel directly**  
Press 0 – 9 and ENTER.  
For example, to select channel 14, press 1, 4 and ENTER.

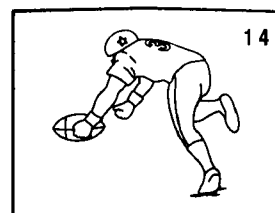
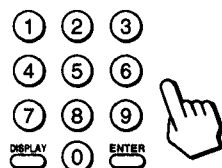

**4** Press VOL +/- to adjust the volume.

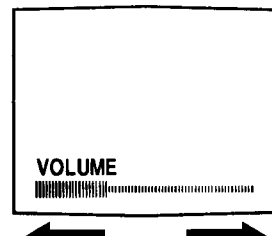

The display will disappear automatically after 3 seconds.

Press + to increase the volume.  
Press - to decrease the volume.

**To turn off the TV**  
Press POWER on the TV or the Remote Commander again.

# Using Convenient Features

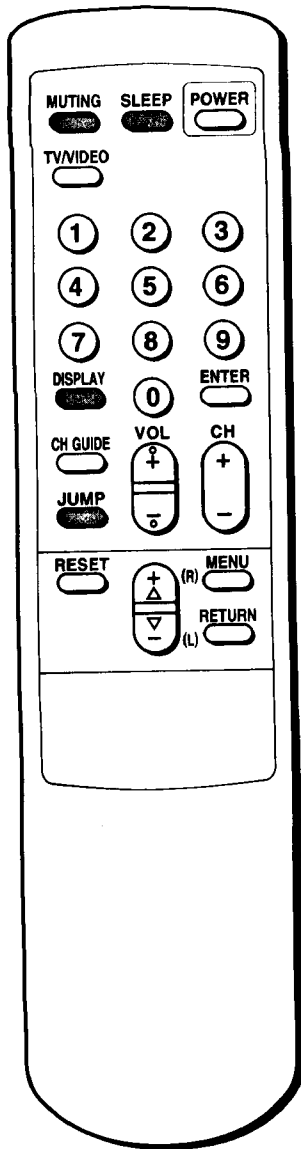

RM-Y116

## Muting the Sound — MUTING

Press MUTING  
*The display "MUTING" will appear on the screen.*



**To restore the sound**  
Press MUTING again, or press VOL +.

## Keeping the Displays On-Screen — DISPLAY

**To display the channel**  
Press DISPLAY.  
*All the existing displays appear: channel number, channel caption (if set), MTS mode (SAP only) and the current time ("AM" or "PM" disappears after about three seconds).*

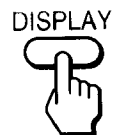

**To cancel the display**  
Press DISPLAY again.  
*The channel display will disappear.*

## Setting the Sleep Timer — SLEEP

The sleep timer turns off the TV automatically after the amount of time you select.

Press SLEEP.  
*Each time you press SLEEP, the time increments 30, 60, 90 and OFF mode appear in sequence.*



SLEEP 30
SLEEP 60
SLEEP 90
SLEEP OFF

*The SLEEP display appears about one minute before the TV turns off.*

**To cancel the setting**  
Press SLEEP until OFF mode appears.  
*The "SLEEP OFF" display appears for about three seconds.*  
OR  
Turn the TV off.  
*The sleep timer setting is cancelled.*

## Switching Quickly Between Two Channels — JUMP

Press JUMP once to recall the channel you were watching previously. Press JUMP again to switch back. Use this feature to keep track of two programs alternately.



# Adjusting Picture and Sound Quality

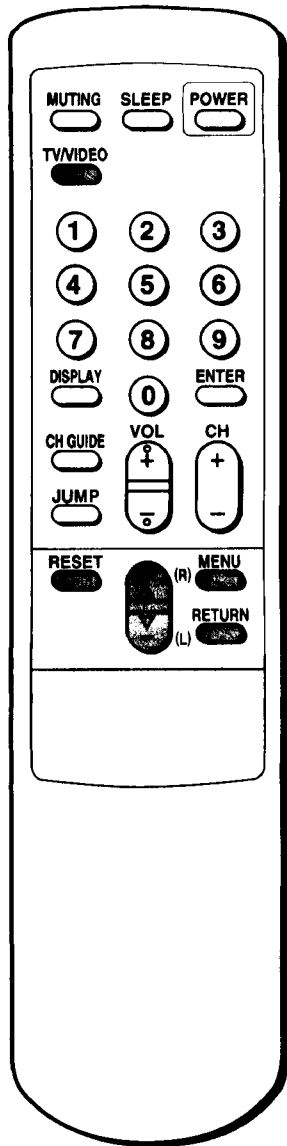

RM-Y116

## Adjusting Picture Quality

You can adjust the picture for each input mode (TV, VIDEO 1, VIDEO 2) by pressing TV/VIDEO to select the input mode before making the adjustments. These adjustments are retained in memory even when you turn off the TV until you change the adjustments again.

- 1 Press MENU.  
The main menu appears, and the cursor points to VIDEO.

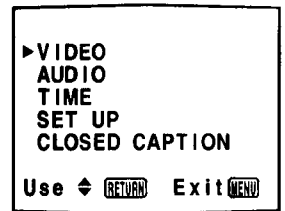

- 2 Press RETURN.  
The VIDEO menu appears.

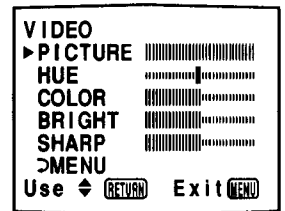

- 3 Press  $\blacktriangle+$  or  $\blacktriangledown-$  to select the item you want to adjust.  
For example, to adjust the picture brightness, select BRIGHT.

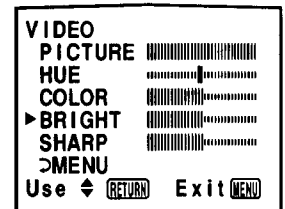
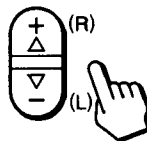

Press RETURN.  
The adjustment bar appears.

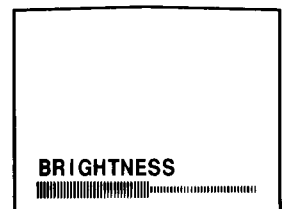

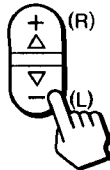

# 4

 Press  $\Delta+$  or  $\nabla-$  to make the adjustment.

Press RETURN.  
The new setting appears in the VIDEO menu.



**To adjust other items**  
Repeat steps 3 – 4.

	Press $\nabla-$ to:	Press $\Delta+$ to:
PICTURE	decrease picture contrast with soft color	increase picture contrast with vivid color
HUE	make skin tones become purplish	make skin tones become greenish
COLOR	decrease color intensity	increase color intensity
BRIGHTNESS	darken the picture	brighten the picture
SHARPNESS	soften the picture	sharpen the picture

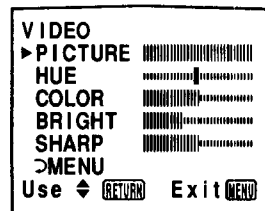
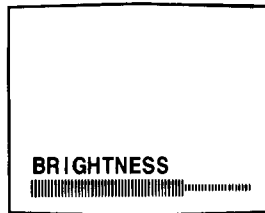

To return to the normal screen  
Press MENU.

To restore the factory (mid-level) setting  
Go to the VIDEO menu and press RESET.  
All the settings except for PICTURE will be restored to the mid-level setting.

### Note

The menus and adjustment bars will disappear automatically after 90 seconds if you do not press any other buttons during that time.

# Adjusting Picture and Sound Quality

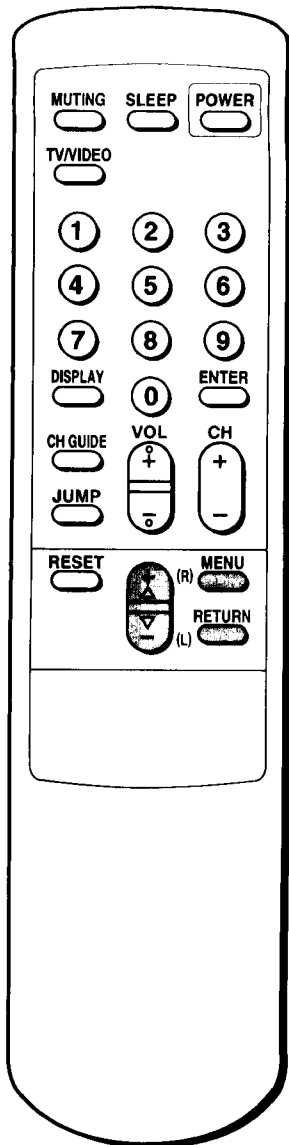

RM-Y116

## Receiving Multichannel TV Sound Programs — MTS

(KV-20TS29/2170RS/21STR2/20TS32/20TS50 only)

- 1 Press MENU.  
The main menu appears.

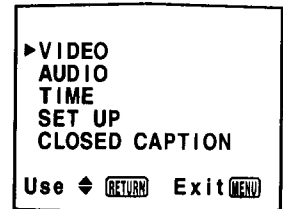

- 2 Press  $\blacktriangle+$  or  $\blacktriangledown-$  to select AUDIO.

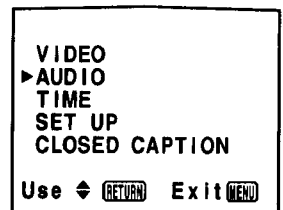
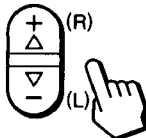

Press RETURN.  
The AUDIO menu appears, and the cursor points to MTS.

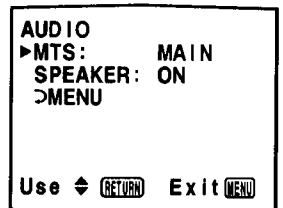

- 3 Press RETURN.



- 4 Press  $\blacktriangle+$  or  $\blacktriangledown-$  to select the mode you want.  
Each time you press  $\blacktriangle+$  or  $\blacktriangledown-$ , "MAIN", "SAP" and "MONO" appear in sequence.

Select the MAIN mode to listen to STEREO sound.  
The STEREO indicator on the TV lights up whenever a stereo broadcast is received.

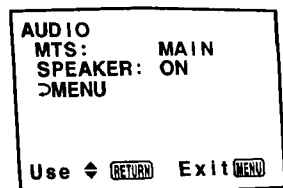
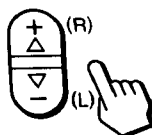





To return to the normal screen  
Press MENU.

Select the SAP mode to listen to Second Audio Programs.

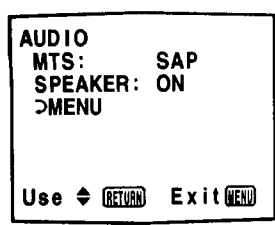
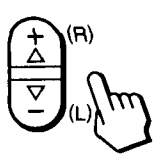

**Note**

During SAP mode, the sound of non-SAP programs will be muted.

Select the MONO mode to eliminate excessive noise during stereo broadcasts, caused by a weak signal.

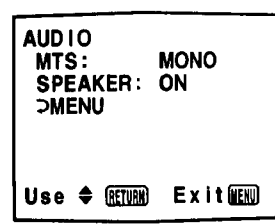
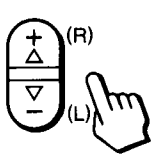

Press RETURN  
The mode is selected.



# Adjusting Picture and Sound Quality

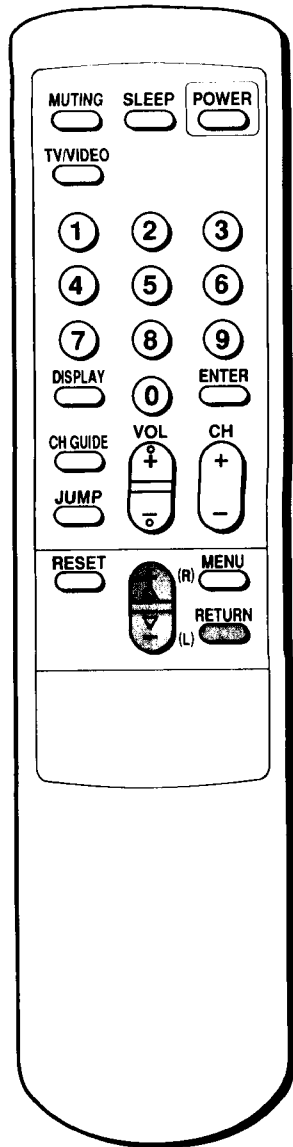

RM-Y116

## Turning the Speaker On or Off

(KV-20TS29/2170RS/21STR2/20TS32/20TS50 only)

**1-2** (Follow steps 1-2 in "Receiving Multichannel TV Sound Programs — MTS," p. 32.)

**3** Press  $\Delta+$  or  $\nabla-$  to select SPEAKER. Then press RETURN.

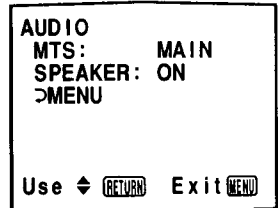
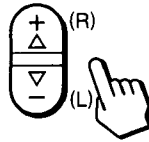

**4** Press  $\Delta+$  or  $\nabla-$  to select ON or OFF alternately.

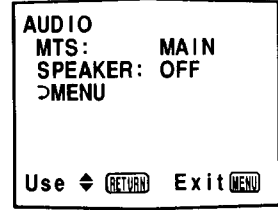
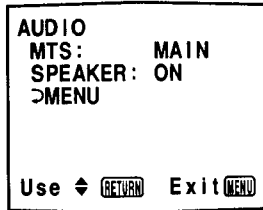
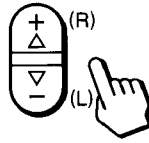

Press RETURN.  
The setting is completed.

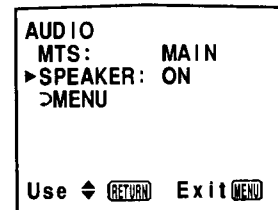

# Using Closed Caption (U.S.A. models only)

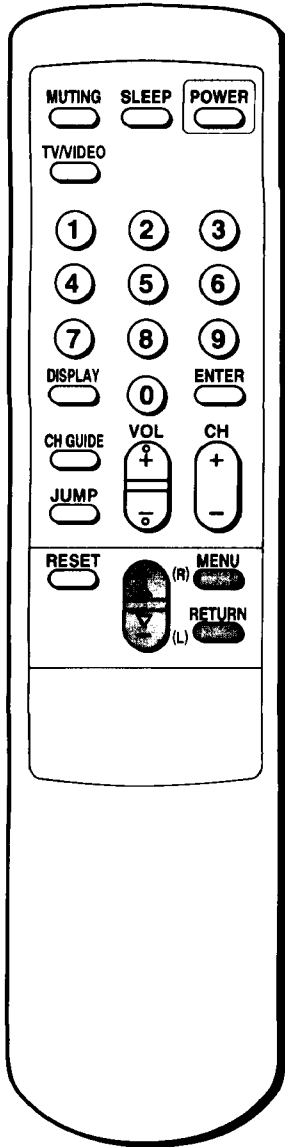

RM-Y116

**To return to the normal screen**  
Press MENU.

**Note**

The closed caption system checks for errors before captions or text appear. If an error is found, the mistake does not appear; a white box appears instead. In most cases, this allows you to read the caption without difficulty. Of course, not all errors can be found, and in some cases mistakes may appear. Poor reception of any TV station can cause poor reception of the closed caption signal causing errors or missing captions.

**1** Press MENU.  
The main menu appears.

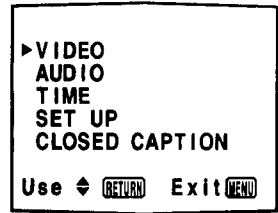

**2** Press  $\blacktriangleup$  or  $\blacktriangledown$  to select CLOSED CAPTION.  
Then press RETURN.  
The CLOSED CAPTION screen appears.

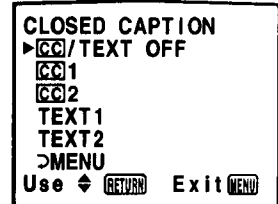

**3** Press  $\blacktriangleup$  or  $\blacktriangledown$  to select closed caption mode.

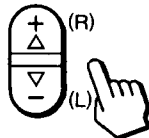

Select CC1 or CC2 to view Captions.  
A Caption is a printed version of the dialogue or sound effects of a program. (The mode should be set to CC1 for most programs.)

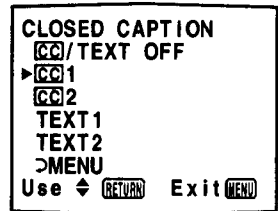

Select TEXT1 or TEXT2 to view Text.  
Text is information that is presented using the half to full television screen.  
It is usually not related to the program.

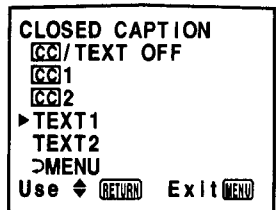

Select CC/TEXT OFF if you do not want to use the CLOSED CAPTION mode.

Press RETURN.  
The Setting is completed.

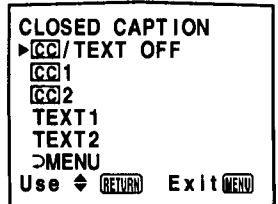

Adjusting Picture and Sound Quality  
Using Closed Caption

# Chapter 3: Using Advanced Features

## Using the Timer-Activated Functions

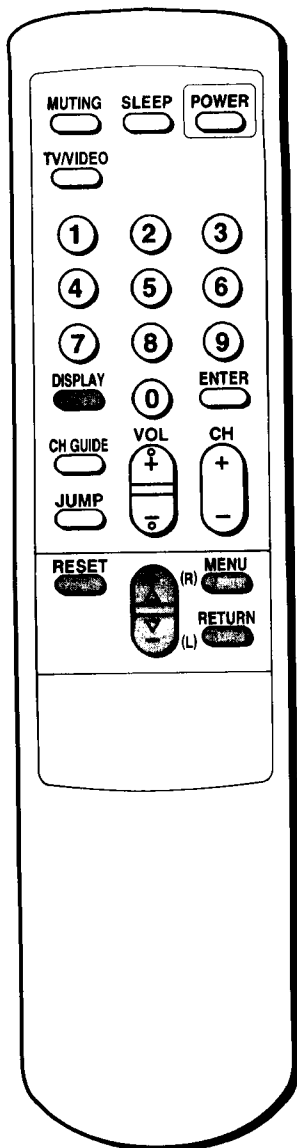

RM-Y116

### Setting the Clock – CURRENT TIME SET

Follow these instructions to set the current time. The correct time must be set in order to use the other timer-activated functions (ON/OFF TIMER, CHANNEL BLOCK).

EXAMPLE: Set the time to 3:15 PM, Monday.

- 1** Press MENU.  
The main menu appears.

MENU



▶ VIDEO  
AUDIO  
TIME  
SET UP  
CLOSED CAPTION

Use  $\blacktriangleleft$  (RETURN) Exit (MENU)

- 2** Press  $\Delta+$  or  $\nabla-$  to select TIME.

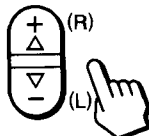

VIDEO  
AUDIO  
▶ TIME  
SET UP  
CLOSED CAPTION

Use  $\blacktriangleleft$  (RETURN) Exit (MENU)

Press RETURN.  
The TIME menu appears, and the cursor points to CURRENT TIME SET.

RETURN



TIME  
▶ CURRENT TIME SET  
ON/OFF TIMER  
CHANNEL BLOCK  
>MENU

--- :-- :-- AM  
Use  $\blacktriangleleft$  (RETURN) Exit (MENU)

- 3** Press RETURN.  
The CURRENT TIME SET screen appears.

RETURN



CURRENT TIME SET

▶ --- :-- :-- AM  
>MENU

Use  $\blacktriangleleft$  (RETURN) Exit (MENU)

- 4** Press RETURN again.  
"Set the day." appears on the screen.

RETURN



CURRENT TIME SET

SUN 12:00 AM  
>MENU

Set the day.  
Use  $\blacktriangleleft$  (RETURN) Exit (MENU)



**5** Press  $\Delta+$  or  $\nabla-$  to set the day.  
 Each time you press  $\Delta+$  or  $\nabla-$ , the day changes consecutively.

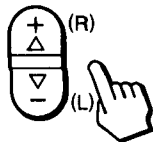

Press RETURN.  
 "Set the time." appears on the screen.

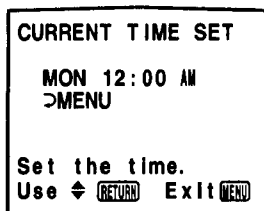

**To reset the time**  
 Press RESET while in the CURRENT TIME screen, and repeat steps 4–7.

**To display the time**  
 Press DISPLAY.

**To return to the normal screen**  
 Press MENU.

**Notes**

- The internal clock of this TV operates on a 12-hour cycle. If a 24-hour cycle number (for instance, 13:00) is entered, it will be cleared when you press RETURN.

12:00 AM stands for midnight.  
 12:00 PM stands for noon.

**6** Press  $\Delta+$  or  $\nabla-$  to set the hour.  
 Each time you press  $\Delta+$  or  $\nabla-$ , the hour changes starting with "12:00 AM."

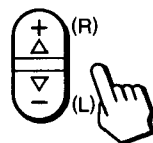

Press RETURN.

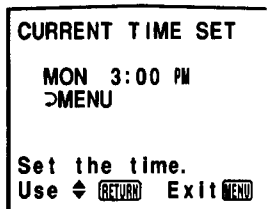

- All the settings including CURRENT TIME SET will be erased if you unplug the TV or a power failure occurs. Reset the current time by following steps 1–7.

**7** Press  $\Delta+$  or  $\nabla-$  to set the minutes.  
 Each time you press  $\Delta+$  or  $\nabla-$ , the minutes change in sequence.

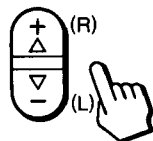

Press RETURN.  
 The setting is completed, and the clock starts.

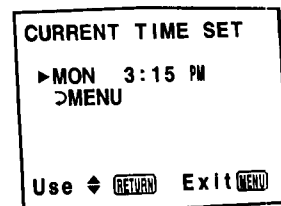
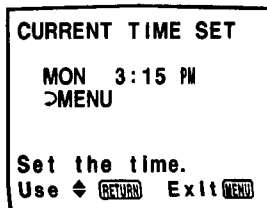

# Using the Timer-Activated Functions

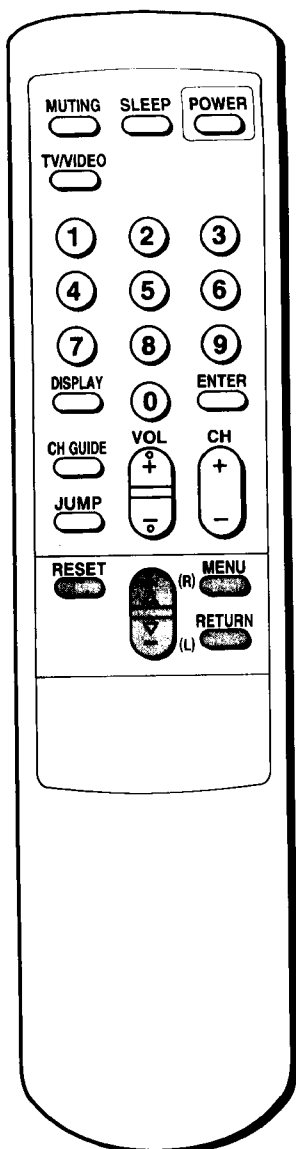

RM-Y116

## Setting the ON/OFF TIMER

With this function you can set your favorite program to appear on the screen at the time that you set.

EXAMPLE: Set the timer to turn on the TV every Monday through Friday at 3:15 PM for 2 hours, on channel 21.

- 1 Press MENU.  
The main menu appears.

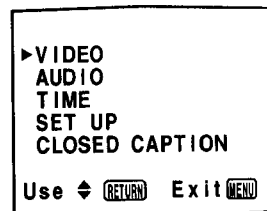

- 2 Press  $\blacktriangle+$  or  $\blacktriangledown-$  to select TIME.  
Then press RETURN.  
The TIME menu appears.

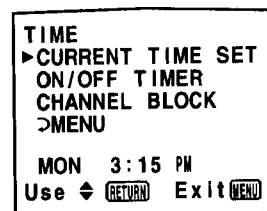
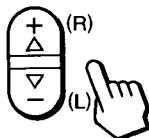

- 3 Press  $\blacktriangle+$  or  $\blacktriangledown-$  to select ON/OFF TIMER.  
Then press RETURN.  
The ON/OFF TIMER screen appears.

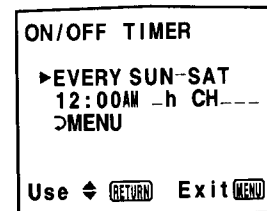
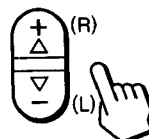

### Note

If the ON/OFF TIMER display appears in black, the current time has not been set and you cannot select ON/OFF TIMER. To set the clock, see "Setting the Clock - CURRENT TIME SET," pp. 36-37.

- 4 Press RETURN again.  
"Set the day." appears on the screen.

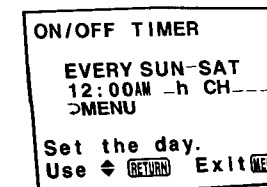



**5** Press  $\Delta+$  or  $\nabla-$  to set the day.  
 Each time you press  $\Delta+$  or  $\nabla-$ , the days of the week change as shown in Fig. 1.  
 Then press RETURN.  
 "Set the time." appears on the screen.

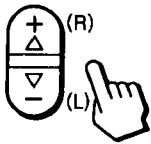

ON/OFF TIMER  
 EVERY MON-FRI  
 12:00AM \_h CH\_\_\_  
 >MENU  
 Set the time.  
 Use  $\blacktriangleleft$  RETURN Exit  $\blacktriangleright$  MENU

**6** Press  $\Delta+$  or  $\nabla-$  to set the hour that you want the TIMER to start.  
 Each time you press  $\Delta+$  or  $\nabla-$ , the hour changes in sequence.  
 Then press RETURN.

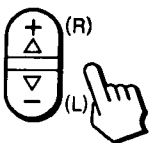

ON/OFF TIMER  
 EVERY MON-FRI  
 3:00PM \_h CH\_\_\_  
 >MENU  
 Set the time.  
 Use  $\blacktriangleleft$  RETURN Exit  $\blacktriangleright$  MENU

**7** Press  $\Delta+$  or  $\nabla-$  to set the minutes.  
 Each time you press  $\Delta+$  or  $\nabla-$ , the minutes change in sequence.  
 Then press RETURN.  
 "Set the duration." appears on the screen.

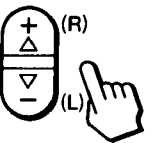

ON/OFF TIMER  
 EVERY MON-FRI  
 3:15PM \_h CH\_\_\_  
 >MENU  
 Set the duration.  
 Use  $\blacktriangleleft$  RETURN Exit  $\blacktriangleright$  MENU

**8** Press  $\Delta+$  or  $\nabla-$  to set the duration of time.  
 Each time you press  $\Delta+$  or  $\nabla-$ , the duration changes from "1" to "6" in sequence.  
 Then press RETURN.  
 "Select the channel" appears on the screen.

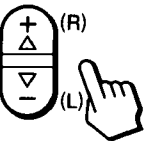

ON/OFF TIMER  
 EVERY MON-FRI  
 3:15PM 2h CH\_\_\_  
 >MENU  
 Select the channel  
 Use  $\blacktriangleleft$  RETURN Exit  $\blacktriangleright$  MENU

**9** Press  $\Delta+$  or  $\nabla-$  to set the channel that you want the TV to tune in.  
 Each time you press  $\Delta+$  or  $\nabla-$ , the channel number changes from 1 to 125 in sequence.

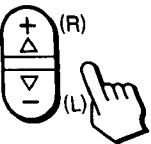

ON/OFF TIMER  
 EVERY MON-FRI  
 3:15PM 2h CH 21  
 >MENU  
 Select the channel  
 Use  $\blacktriangleleft$  RETURN Exit  $\blacktriangleright$  MENU

Press RETURN.  
 The setting is completed, and the TIMER indicator on the front of the TV lights up.



ON/OFF TIMER  
 >EVERY MON-FRI  
 3:15PM 2h CH 21  
 >MENU  
 Use  $\blacktriangleleft$  RETURN Exit  $\blacktriangleright$  MENU

To clear the ON/OFF TIMER setting  
 Press RESET while in the ON/OFF TIMER screen.

To return to the normal screen  
 Press MENU.

**Notes**

- While the TIMER is set, the TIMER indicator on the TV is on.
- One minute before the timer goes off, the "TV will turn off" display will appear on the screen.
- If you have not set the clock correctly, the ON/OFF TIMER will not operate at the proper time. To set the clock, see "Setting the Clock-CURRENT TIME SET," pp. 36-37.
- All the settings including ON/OFF TIMER will be erased if you unplug the TV or a power failure occurs. Reset the TIMER by following steps 1-9.

**Fig. 1**  
**Selecting the day(s) of the week**  
 When you press  $\Delta+$ , the days of the week appear in the following order.

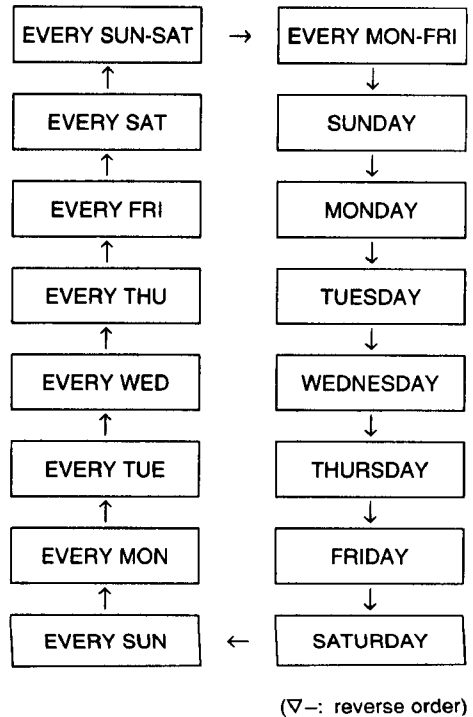

Using the Timer-Activated Functions

# Using the Timer-Activated Functions

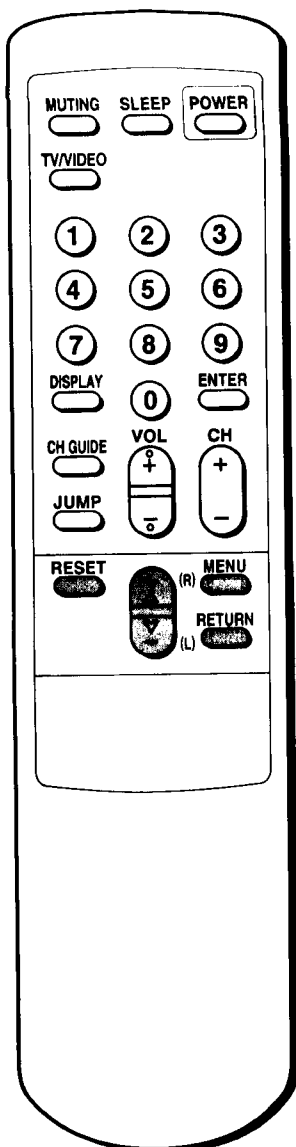

RM-Y116

## Setting CHANNEL BLOCK

Use this function to block a channel from appearing on the screen during the time you specify. You can use this function to prevent children from watching undesirable programs.

EXAMPLE: Set CHANNEL BLOCK every Sunday at 8:45 PM for one hour, on channel 38.

- 1** Press MENU.  
The main menu appears.



► VIDEO  
AUDIO  
TIME  
SET UP  
CLOSED CAPTION

Use ◀ (RETURN) Exit (MENU)

- 2** Press Δ+ or ▽- to select TIME.  
Then press RETURN.  
The TIME menu appears.

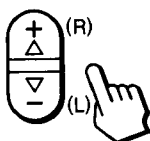

TIME  
► CURRENT TIME SET  
ON/OFF TIMER  
CHANNEL BLOCK  
► MENU

MON 3:15 PM  
Use ◀ (RETURN) Exit (MENU)

- 3** Press Δ+ or ▽- to select CHANNEL BLOCK.  
Then press RETURN.  
The CHANNEL BLOCK screen appears.

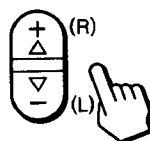

CHANNEL BLOCK

► EVERY SUN-SAT  
12:00AM -h CH---  
► MENU

Use ◀ (RETURN) Exit (MENU)

### Note

If the CHANNEL BLOCK display appears in black, the current time has not been set and you cannot select CHANNEL BLOCK. To set the clock, see "Setting the Clock - CURRENT TIME SET," pp. 36-37.

- 4** Press RETURN again.  
"Set the day." appears on the screen.



CHANNEL BLOCK

EVERY SUN-SAT  
12:00AM -h CH---  
► MENU

Set the day.

Use ◀ (RETURN) Exit (MENU)



- 5** Press  $\Delta+$  or  $\nabla-$  to set the day.  
 Each time you press  $\Delta+$  or  $\nabla-$ , the days of the week change as shown in Fig. 1.  
 (See p.39.)  
 Then press RETURN.  
 "Set the time." appears on the screen.



```

CHANNEL BLOCK
EVERY SUNDAY
12:00AM _h CH___
>MENU

Set the time.
Use  $\blacktriangleleft$  RETURN Exit  $\blacktriangleright$  MENU
  
```

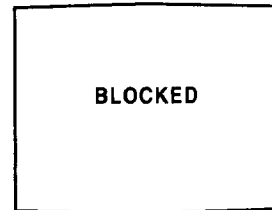

- 6** Press  $\Delta+$  or  $\nabla-$  to set the hour.  
 Each time you press  $\Delta+$  or  $\nabla-$ , the hour changes in sequence.  
 Then press RETURN.



```

CHANNEL BLOCK
EVERY SUNDAY
8:00PM _h CH___
>MENU

Set the time.
Use  $\blacktriangleleft$  RETURN Exit  $\blacktriangleright$  MENU
  
```

**To clear the BLOCK setting**  
 Press RESET while in the CHANNEL BLOCK screen.

**To return to the normal screen**  
 Press MENU.

**Notes**

- If you set a new CHANNEL BLOCK by following steps 1-9, the original setting will be erased.
- If you have not set the clock correctly, CHANNEL BLOCK will not operate at the proper time. To set the current time, see "Setting the Clock – CURRENT TIME SET," pp. 36-37.

- 7** Press  $\Delta+$  or  $\nabla-$  to set the minutes.  
 Each time you press  $\Delta+$  or  $\nabla-$ , the minutes change in sequence.  
 Then press RETURN.  
 "Set the duration." appears on the screen.

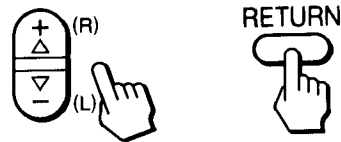

```

CHANNEL BLOCK
EVERY SUNDAY
8:45PM _h CH___
>MENU

Set the duration.
Use  $\blacktriangleleft$  RETURN Exit  $\blacktriangleright$  MENU
  
```

- 8** Press  $\Delta+$  or  $\nabla-$  to set the duration of time that you want the TV remain blocked.  
 Each time you press  $\Delta+$  or  $\nabla-$ , the duration changes from "1" to "6" in sequence.  
 Then press RETURN.  
 "Select the channel" appears on the screen.

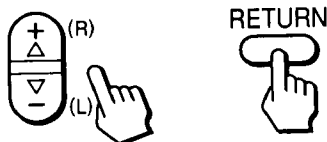

```

CHANNEL BLOCK
EVERY SUNDAY
8:45PM 1h CH___
>MENU

Select the channel
Use  $\blacktriangleleft$  RETURN Exit  $\blacktriangleright$  MENU
  
```

- 9** Press  $\Delta+$  or  $\nabla-$  to set the channel that you want to block.  
 Each time you press  $\Delta+$  or  $\nabla-$ , the channel number changes from 1 to 125 in sequence.

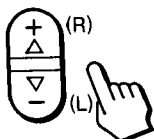

Press RETURN.  
 The setting is completed.



```

CHANNEL BLOCK
EVERY SUNDAY
8:45PM 1h CH 38
>MENU

Select the channel
Use  $\blacktriangleleft$  RETURN Exit  $\blacktriangleright$  MENU
  
```

```

CHANNEL BLOCK
▶EVERY SUNDAY
8:45PM 1h CH 38
>MENU

Use  $\blacktriangleleft$  RETURN Exit  $\blacktriangleright$  MENU
  
```

# Customizing the Screen Display

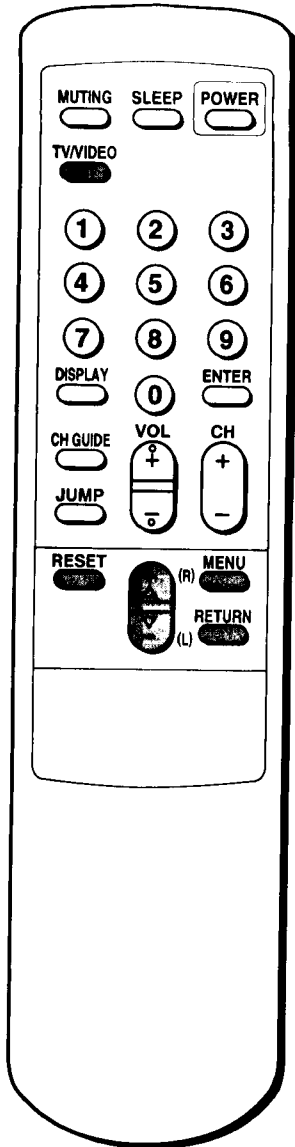

RM-Y116

## Setting Channel Captions – CH CAPTION

Use this feature to caption up to 12 channel number displays with the matching channel call letters.

EXAMPLE: Caption channel 20 with ESPN at the caption position number 4.

- 1 Press MENU.  
The main menu appears.

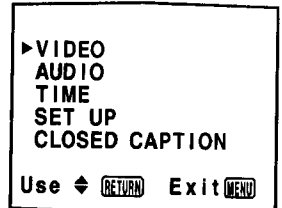

- 2 Press  $\Delta$ + or  $\nabla$ - to select SET UP.  
Then press RETURN.  
The SET UP menu appears.

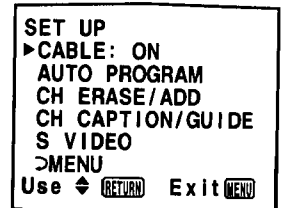
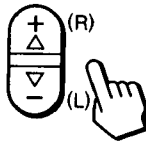

- 3 Press  $\Delta$ + or  $\nabla$ - to select CH CAPTION/GUIDE.  
Then press RETURN.  
The CH CAPTION/GUIDE screen appears.

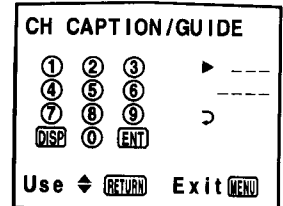
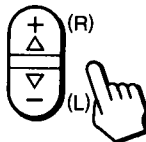

### Note

If the CH CAPTION/GUIDE display appears in black, the TV is in video mode and you cannot select CH CAPTION/GUIDE. Press TV/VIDEO to change to TV mode.

- 4 Press RETURN again.  
"Select a position." appears on the screen.

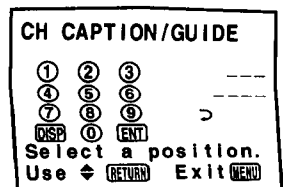



**5** Press  $\Delta+$  or  $\nabla-$  to select a caption position number.  
 Each time you press  $\Delta+$  or  $\nabla-$ , the caption position number is marked in sequence.  
 Then press RETURN.  
 "Select the channel" appears on the screen.

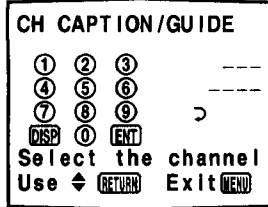
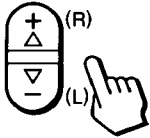

To erase unneeded captions  
 Call the caption setting screen by following  
 steps 1 - 5, and press RESET.

To return to the normal screen  
 Press MENU.

**6** Press  $\Delta+$  or  $\nabla-$  to select the channel you want to caption.  
 Each time you press  $\Delta+$  or  $\nabla-$ , the channel number changes from 1 to 125.  
 Then press RETURN.  
 "Select the letter." appears on the screen.

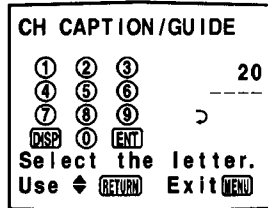
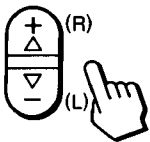

**7** Press  $\Delta+$  or  $\nabla-$  to select the first letter.  
 Each time you press  $\Delta+$  or  $\nabla-$ , "0-9," "A-Z,"  
 "&," "I," "L," and " (blank space)" appear in sequence.  
 Then press RETURN.

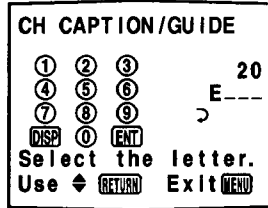
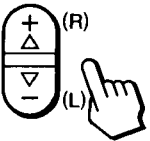

**8** Repeat step 7 to select each remaining letter.  
 (For a 3-letter caption, leave a space by pressing RETURN only.)

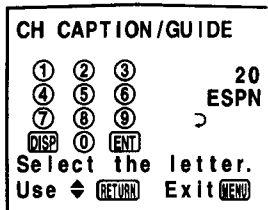
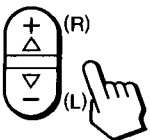

**9** Press RETURN.  
 The setting is completed.

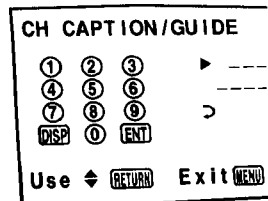

To caption other channels  
 Repeat steps 4-9.



# Customizing the Screen Display

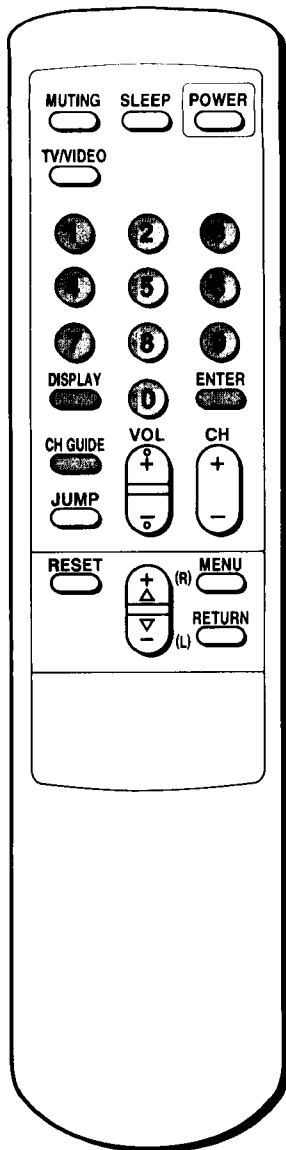

RM-Y116

## Viewing the Captioned Channels – CHANNEL GUIDE

Use this feature to display the captions you set, and to select a channel directory for viewing.

- 1 Press CH GUIDE.  
A directory appears, corresponding to the directory keys on the Remote Commander.

CH GUIDE



To cancel the CHANNEL GUIDE screen  
Press CH GUIDE again.

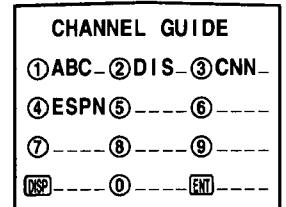

- 2 Press the directory key of the channel you want to watch.

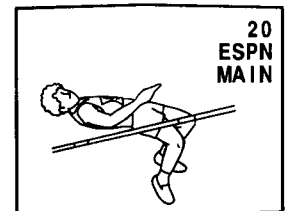
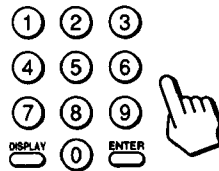

# Using the Cordless Headphones (KV-20TS50 only)



## Installing Batteries

- 1 Push the tabs on the edges of both receivers down and up to open the battery compartment covers.



- 2 Insert a size AA (R6) battery into each of the compartments. Make sure the polarity is correct.

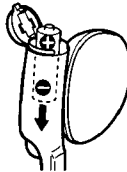

- 3 Close the battery compartment cover.

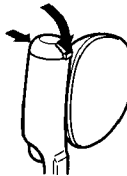

### Battery life

With continuous use, batteries will last:

- up to 120 hours (size AA (R6) alkaline battery).
- up to 60 hours (size AA (R6) manganese battery).

If the power indicator darkens and the sound deteriorates, the batteries might be weak. Replace both of them with new ones.

### To avoid damage from possible battery leakage

Remove the batteries if you do not plan to use the cordless headphones for a fairly long time.

### WARNING

Batteries may explode if mistreated. Do not recharge, disassemble, or dispose of in fire.

## Using the Cordless Headphones

- 1 Turn the headphones power on by using the control on the headphones. The power indicator lights up.

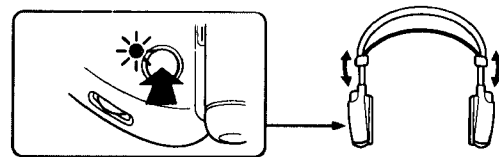

- 2 Set HEADPHONES to ON. For instructions, see "Setting HEADPHONES to ON or OFF," p.46.

- 3 Adjust the headphone speakers volume by using the controls on the headphones. You can adjust the volume to the right and left speakers separately.



### Note

To prevent hearing damage due to sudden or prolonged excessive volume, do not raise the headphones volume too high, while listening.

## Connecting Cordless Headphones

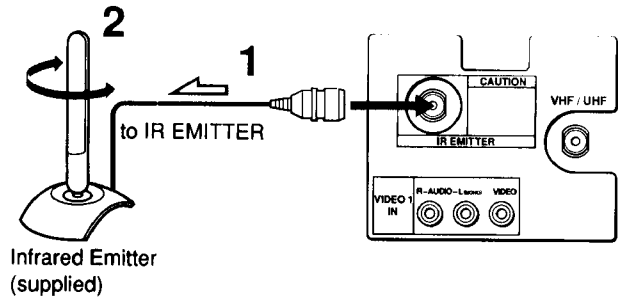

Infrared Emitter (supplied)

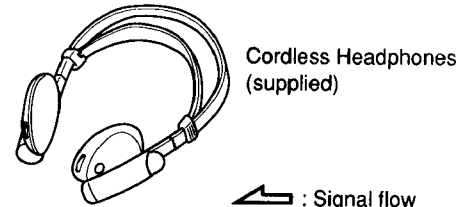

Signal flow

- 1 Plug the infrared emitter cable into the IR EMITTER terminal.

### CAUTION

Do not connect the antenna cable into the IR EMITTER terminal. If you do so, the antenna could break. The IR EMITTER terminal is covered with a plastic cap to prevent misconnection.

- 2 Adjust the position and the direction of the infrared emitter.

### Note

- Do not cover the infrared emitter.
- Remove obstacles between the emitter and the cordless headphones.

# Using the Cordless Headphones

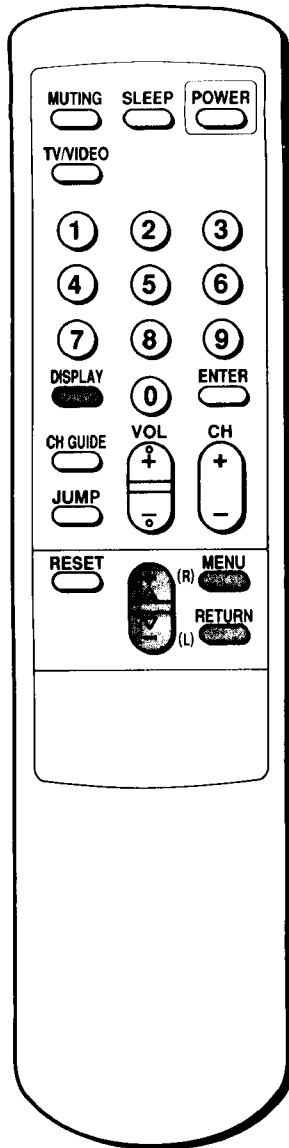

**To return to the normal screen**  
Press MENU.

**To display  $\Omega$  on the screen**  
Press DISPLAY.

### Notes

- If you want to listen to the sound from the headphones only, turn off the TV speaker sound by pressing VOL - or setting SPEAKER to OFF. For details on setting SPEAKER to OFF, see "Turning the Speaker On or Off," p. 34.
- To listen to the sound from the headphones clearly, adjust the direction and the position of the infrared emitter.

## Setting HEADPHONES to ON or OFF

Set HEADPHONES to ON in order to use the cordless headphones.

### Note

Each time you turn the TV off, HEADPHONES is automatically set to OFF. Set HEADPHONES to ON whenever you want to use the cordless headphones.

- 1 Press MENU.  
*The main menu appears.*



```

▶VIDEO
AUDIO
TIME
SET UP
CLOSED CAPTION
    
```

Use  $\blacktriangleleft$  (RETURN) Exit (MENU)

- 2 Press  $\Delta+$  or  $\nabla-$  to select AUDIO.  
Then press RETURN.  
*The AUDIO menu appears.*

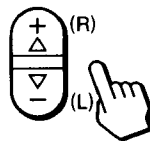

```

AUDIO
▶MTS:      MAIN
SPEAKER:  ON
HEADPHONES: OFF
>MENU
    
```

Use  $\blacktriangleleft$  (RETURN) Exit (MENU)

- 3 Press  $\Delta+$  or  $\nabla-$  to select HEADPHONES.  
Then press RETURN.

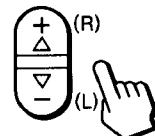

```

AUDIO
MTS:      MAIN
SPEAKER:  ON
HEADPHONES: OFF
>MENU
    
```

Use  $\blacktriangleleft$  (RETURN) Exit (MENU)

- 4 Press  $\Delta+$  or  $\nabla-$  to select ON or OFF alternately.

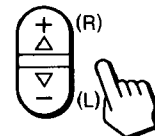

```

AUDIO
MTS:      MAIN
SPEAKER:  ON
HEADPHONES: ON
>MENU
    
```

Use  $\blacktriangleleft$  (RETURN) Exit (MENU)



```

AUDIO
MTS:      MAIN
SPEAKER:  ON
HEADPHONES: OFF
>MENU
    
```

Use  $\blacktriangleleft$  (RETURN) Exit (MENU)

Press RETURN.  
*The setting is completed.*

# Appendix Specifications

<b>Television system</b>	American TV standards
<b>Channel coverage</b>	VHF: 2-13 UHF: 14-69 Cable TV: 1-125
<b>Picture tube</b>	Microblack™ Trinitron® tube 13-inch picture measured diagonally 14-inch picture tube measured diagonally (KV-13TR28/13TR29/1430R/1440WR) 20-inch picture measured diagonally 21-inch picture tube measured diagonally (KV-20TS29/2170RS/21STR2/20TS32/20TS50/20TR23/2150R/2160WR)
<b>Antenna</b>	75-ohm external antenna terminal for VHF/UHF
<b>Input</b>	VIDEO and S VIDEO S VIDEO IN (S terminal) (KV-20TS32 only) Y: 1 Vp-p, 75-ohms unbalanced, sync negative C: 0.286 Vp-p (Burst signal), 75-ohms Video (phono jacks): 1 Vp-p, 75-ohms unbalanced, sync negative Audio (phono jacks): 500 mVrms (100% modulation) Impedance: 47 kilohms
<b>Speaker output</b>	1W KV-13TR28/29 KV-1430R KV-1440WR 2W KV-20TR23 KV-2160WR KV-2150R 2W × 2 KV-20TS29 KV21STR2 KV2170RS KV-20TS50 KV-20TS32
<b>Power requirements</b>	120 V AC, 60 Hz (except for KV-1440WR/2160WR/21STR2) 110-127 V or 220-240 V AC, 50-60Hz (KV-1440WR/2160WR/21STR2 only)

## Power consumption

KV-13TR28/29	KV-1430R KV-1440WR	85 W
KV-20TR23	KV-2150R KV-2160WR	115 W
KV-20TS29 KV-2170RS KV-21STR2	KV-20TS32 KV-20TS50	120 W

<b>Standby mode</b>	4W (except for KV-1440WR/2160WR/21STR2) 5.5W (KV-1440WR/2160WR/21STR2 only)
---------------------	--

## Dimensions/Weight

	Dimensions (w/h/d)	Weight
KV-13TR28/29 KV-1430R KV-1440WR	372 × 339 × 408 mm (14 <sup>3</sup> / <sub>4</sub> × 13 <sup>3</sup> / <sub>8</sub> × 16 <sup>1</sup> / <sub>8</sub> in.)	11.2 kg (24 lbs 11 oz)
KV-20TR23 KV-2150R KV-2160WR	526 × 488 × 477.5 mm (20 <sup>3</sup> / <sub>4</sub> × 19 <sup>1</sup> / <sub>4</sub> × 18 <sup>7</sup> / <sub>8</sub> in.)	22.4 kg (49 lbs 6 oz)
KV-20TS29 KV-2170RS KV-21STR2 KV-20TS32 KV-20TS50	526 × 488 × 477.5 mm (20 <sup>3</sup> / <sub>4</sub> × 19 <sup>1</sup> / <sub>4</sub> × 18 <sup>7</sup> / <sub>8</sub> in.)	22.8 kg (50 lbs 4 oz)

## Supplied accessories

Remote commander RM-Y116 (1)  
with 2 size AA (R6) EVEREADY  
batteries  
Dipole antenna (1)  
Antenna connector (1)

(KV-20TS50)  
Cordless headphones system (1)  
with 2 size AA (R6) EVEREADY  
batteries

(KV-1440WR/2160WR/21STR2)  
Power cord plug adaptor\*

## Recommended accessories

U/V mixer EAC-66  
Connecting cable  
VMC-810S/820S, VMC-720M,  
YC-15V/30V, RK-74A

Design and specifications are subject to change without notice.

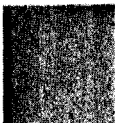

Using the Cordless Headphones  
Specifications

\* AC power cord connection  
If the power cord plug cannot be inserted into the wall outlet, use the supplied power cord plug adaptor.

# Troubleshooting

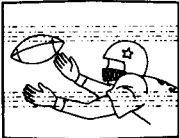
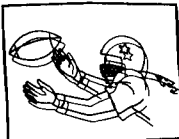
Symptom	Possible causes and remedies
Poor or no picture (screen not lit), good sound	<ul style="list-style-type: none"> <li>• Adjust PICTURE.</li> <li>• Adjust BRIGHTNESS.</li> <li>• Check antenna/cable connections.</li> </ul>
Good picture, no sound	<ul style="list-style-type: none"> <li>• Press VOLUME + on the TV or VOL + on the Remote Commander.</li> <li>• Press MUTING on the Remote Commander.</li> <li>• Check that the MTS setting is set correctly.</li> <li>• Check that the TV/VIDEO button is set correctly.</li> <li>• Check that "SPEAKER ON" is set.</li> </ul>
Good picture, no sound from the cordless headphones	<ul style="list-style-type: none"> <li>• Is the battery used up?</li> <li>• Is the cordless headphones power turned on?</li> <li>• Adjust the cordless headphones volume control.</li> <li>• Make sure HEADPHONES is set to ON.</li> </ul>
Good picture, noisy sound from the cordless headphones	<ul style="list-style-type: none"> <li>• Is the battery used up?</li> <li>• Remove obstacles between the infrared emitter and the cordless headphones.</li> <li>• Is the infrared detector covered by your hands, hair, etc?</li> <li>• Adjust the direction and the position of the infrared emitter.</li> </ul>
No picture (screen not lit), no sound	<ul style="list-style-type: none"> <li>• Is POWER switched on?</li> <li>• Plug the unit into a wall outlet.</li> <li>• Check that the TV/VIDEO button is set correctly.</li> <li>• Make sure S VIDEO is set to on.</li> </ul>
No color	<ul style="list-style-type: none"> <li>• Is it a color program?</li> <li>• Adjust COLOR.</li> </ul>
Snow and noise only	<ul style="list-style-type: none"> <li>• Is it an active or the correct channel?</li> <li>• Check the CABLE setting.</li> <li>• Check antenna/cable connections.</li> </ul>
 <p>Dotted lines or stripes</p>	<p>This is often caused by local interference. (e.g. cars, neon signs, hairdryers etc.) Adjust the antenna for minimum interference.</p>
 <p>Double images or ghosts</p>	<p>Reflections from nearby mountains or buildings often cause this problem. A highly directional outdoor antenna or a CATV cable may improve the picture.</p>
<p>Try another channel. It could be station trouble.</p>	

If the problem persists, contact your nearest service facility.



## Free Manuals Download Website

<http://myh66.com>

<http://usermanuals.us>

<http://www.somanuals.com>

<http://www.4manuals.cc>

<http://www.manual-lib.com>

<http://www.404manual.com>

<http://www.luxmanual.com>

<http://aubethermostatmanual.com>

Golf course search by state

<http://golfingnear.com>

Email search by domain

<http://emailbydomain.com>

Auto manuals search

<http://auto.somanuals.com>

TV manuals search

<http://tv.somanuals.com>