

SONY®

SONY

Digital HD Video Camera Recorder

US

Digital HD Video Camera Recorder

Operating Guide

Before operating the unit, please read this manual thoroughly, and retain it for future reference

HDV
HDV 1080i

DVCAM™

Mini **DV** Digital Video Cassette

PROGRESSIVE

InfoLITHIUM™ **L** SERIES

MEMORY STICK™

HDMI

G

HVR-Z5U/Z5N

© 2008 Sony Corporation

<http://www.sony.net/>

 Printed on 70% or more recycled paper using VOC (Volatile Organic Compound) -free vegetable oil based ink.

Printed in Japan



4 114 857 110

Read this first

Before operating this unit, please read this manual thoroughly, and retain it for future reference.

Notes on use

Types of cassette you can use in your camcorder

Your camcorder is capable of recording in HDV, DVCAM and DV formats.

When recording in HDV/DV format, Sony recommends that you use mini DV cassettes.

When recording in DVCAM format, Sony recommends that you use mini DVCAM cassettes. Your camcorder does not support the Cassette Memory function (p. 119).

The HDV format

- Digital high-definition (HD) video signals are recorded and played back on a DV format cassette.
- HDV signals are compressed in MPEG2 format, which is adopted in BS (broadcast satellite) digital and terrestrial digital HDTV broadcastings and in Blu-ray disc recorders.

Types of “Memory Stick” you can use in your camcorder

You can use any “Memory Stick” that has the following markings.

MEMORY STICK DUO MEMORY STICK PRO DUO
MEMORY STICK PRO-HG DUO

“Memory Stick Duo”

(This size can be used with your camcorder.)



“Memory Stick”

(You cannot use it in your camcorder.)



Notes

- You cannot use any type of memory card except “Memory Stick Duo.”
- “Memory Stick PRO Duo” can be used only with “Memory Stick PRO” compatible equipment.
- Do not attach a label or the like on a “Memory Stick Duo” or a “Memory Stick Duo” Adaptor.
- When using a “Memory Stick Duo” with “Memory Stick” compatible equipment, insert the “Memory Stick Duo” into the “Memory Stick Duo” Adaptor.

Using the camcorder

- Do not hold the camcorder by the following part.

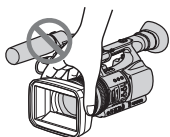

Lens hood

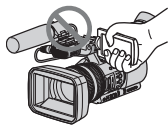

LCD panel

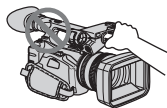

Internal microphone



Microphone or
Microphone holder



Viewfinder

Notes

- The camcorder is not dustproof, dripproof or waterproof.
See “About handling of your camcorder” (p. 125).
- Do not connect cables to your camcorder with their terminals placed the wrong way. Squeezing the terminals into your camcorder’s jacks may damage them or result in a malfunction of your camcorder.

About menu items, LCD panel, viewfinder, and lens

- A menu item that is grayed out is not available under the current recording or playback conditions.
- The LCD screen and the viewfinder are manufactured using extremely high-precision technology, so over 99.99% of the pixels are operational for effective use. However, there may be some tiny black points and/or bright points (white, red, blue, or green in color) that appear constantly on the LCD screen and the viewfinder. These points are normal results of the manufacturing process and do not affect the recording in any way.

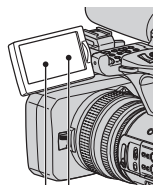

Black point

White, red, blue or green point

Do not expose your camcorder’s viewfinder, lens, or LCD screen to the sun or strong light source for extended periods.

- Intense light sources, especially the sun will converge on the viewfinder or lens and damage the internal parts of your camcorder. Avoid sunlight or other strong light sources when storing your camcorder. Protect this device by always closing the lens cover or by placing it in its bag when not in use.

About temperature of your camcorder and battery pack

- Your camcorder has a protective function that disables recording or playback if the temperature of your camcorder or battery

Read this first (Continued)

pack is beyond the safely operable range. In this case, a message appears on the screen or in the viewfinder (p. 116).

On recording

- Before starting to record, test the recording function to make sure the picture and sound are recorded without any problems.
- Compensation for the contents of recordings cannot be provided, even if recording or playback is not possible due to a malfunction of the camcorder, storage media, etc.
- TV color systems differ depending on the countries/regions. To view your recordings on a TV, you need an NTSC system-based TV.
- Television programs, films, video tapes, and other materials may be copyrighted. Unauthorized recording of such materials may be contrary to the copyright laws.
- Because of the way that the image device (CMOS sensor) reads out image signals, the subjects passing by the frame rapidly might appear crooked depending on the recording conditions. This phenomenon may be notable in displays having high motion resolution.

On playing back HDV tapes on other devices

A tape recorded in the HDV format cannot be played back on a device that is not compatible with the HDV format. Check the contents of tapes by playing them back on this camcorder prior to playing them back on other devices.

Notes on the icons used in this manual

 Features available for the HDV format only.

 Features available for the DVCAM format only.

 Features available for the DV SP format only.

 The function that can be used when i.LINK cable is connected.

 The function that can be assigned to an ASSIGN button.

About this manual

- The images of the LCD screen and the viewfinder used in this manual for illustration purposes are captured using a digital still camera, and therefore may appear different.
- The on-screen displays in each local language are used for illustrating the operating procedures. Change the screen language before using your camcorder if necessary (p. 21).
- Design and specifications of recording media and other accessories are subject to change without notice.
- Illustrations of battery packs in this manual show the NP-F770 unless otherwise specified.

Table of Contents

Read this first	2
-----------------------	---

Getting Started

Step 1: Checking supplied items	8
Step 2: Attaching the supplied microphone and the lens hood with lens cover	10
Step 3: Charging the battery pack	13
Step 4: Turning the power on and holding your camcorder properly	17
Step 5: Adjusting the LCD panel and viewfinder	18
Step 6: Setting the date and time	20
Changing the language setting	21
Step 7: Inserting a tape or a "Memory Stick Duo"	22









Recording/Playback

Recording	24
Changing the settings of your camcorder recordings	28
Adjusting the zoom	28
Adjusting the focus manually	29
Adjusting the image brightness	30
Adjusting to natural color (White balance).....	33
Customizing the picture quality (Picture profile).....	35
Adjusting the volume	44
Attaching a Memory Recording Unit.....	44
Assigning the functions to the ASSIGN buttons	46
Recording an index signal	47
Playing back the most recently recorded movies (Last scene review).....	48
Reviewing the most recently recorded scenes (Rec review).....	48
Searching for the last scene of the most recent recording (End search)	48
Using the Shot transition	48
Playback	51
Changing/checking the settings in your camcorder	54
Changing the screen	54
Displaying recording data (Data code)	54
Displaying the settings in your camcorder (Status check)	55
Checking the remaining battery (Battery Info).....	55

Table of Contents (Continued)

Locating a scene on a tape	56
Searching for a scene by date of recording (Date search)	56
Searching for a recording start point (Index search)	56
Playing the picture on a TV	58

Using the Menu

<i>Using the menu items</i>	64
Menu items	66
 (CAMERA SET) menu	69
Settings to adjust your camcorder to the recording conditions (GAIN SETUP/ BACK LIGHT/STEADYSHOT, etc.)	
 (AUDIO SET) menu	77
Settings for the audio recording (DV AU.MODE (DV Audio mode)/XLR SET, etc.)	
 (DISPLAY SET) menu	80
Display settings of the display and the viewfinder (MARKER/VF B.LIGHT/DISP OUTPUT, etc.)	
 (IN/OUT REC) menu	85
Recording settings, input and output settings (REC FORMAT/HDV PROGRE./ VIDEO OUT/EXT REC CTRL, etc.)	
 (TC/UB SET) menu	89
(TC PRESET/UB PRESET/TC LINK, etc.)	
 (MEMORY SET) menu	91
Settings for the "Memory Stick Duo" (ALL ERASE/FORMAT, etc.)	
 (OTHERS) menu	92
Settings while recording on a tape or other basic settings (QUICK REC/BEEP, etc.)	

Dubbing/Editing

Dubbing to VCR, DVD/HDD device, etc.	96
Recording pictures from a VCR	100
Copying movies on a tape to a computer	102
Copying still images to a computer	105

Troubleshooting

Troubleshooting	106
Warning indicators and messages	116

Additional Information

Using your camcorder abroad	118
Maintenance and precautions	119
HDV format and recording/playback	119
Compatibility of the DVCAM/DV formats	120
About the "Memory Stick"	122
About the "InfoLITHIUM" battery pack	123
About i.LINK	124
About x.v.Color	125
About handling of your camcorder	125
Specifications	129

Quick Reference

Identifying parts and controls	134
Indicators for the LCD screen and viewfinder	140
Index	143

Step 1: Checking supplied items

Make sure that you have following items supplied with your camcorder.

The number in the parentheses indicates the number of that item supplied.

- The cassette tape and “Memory Stick Duo” are not included. See pages 2, 119 and 122 for types of cassette tapes and “Memory Stick Duo” that you can use on your camcorder.

AC Adaptor/Charger (AC-VQ1050) (1)
(p. 13)

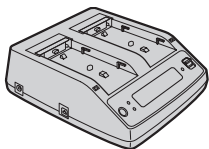

Power cord (mains lead) (1) (p. 13)



Wireless Remote Commander (RMT-831)
(1) (p. 139)



A button-type lithium battery is already installed.

Component A/V cable (1) (p. 58)

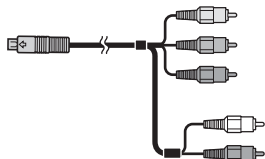

A/V connecting cable (1) (p. 58, 96)



Large eyecup (1) (p. 19)

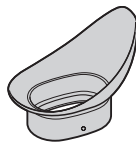

Rechargeable battery pack (NP-F770) (1)
(p. 13, 123)
(Only for models HVR-Z5U)

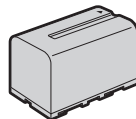

Rechargeable battery pack (NP-F570) (1)
(p. 13, 123)
(Only for models HVR-Z5N)

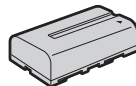

Lens hood with lens cover (1) (p. 12)
This lens hood is pre-mounted.

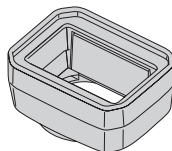

Wind Screen (1), Microphone (ECM-XM1)
(1) (p. 10)

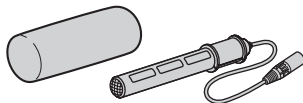

Accessory shoe kit (Accessory shoe (1),
Accessory shoe plate (1), screws (4))
(p. 134)

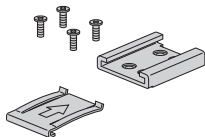

Connecting cord (DK-415) (1) (p. 15)
CD-ROM "Manuals for Digital HD Video
Camera Recorder" (1)
Operating Guide (2)

Step 2: Attaching the supplied microphone and the lens hood with lens cover

Attaching the supplied microphone

When you use the supplied microphone (ECM-XM1) for recording sound, do the following steps.

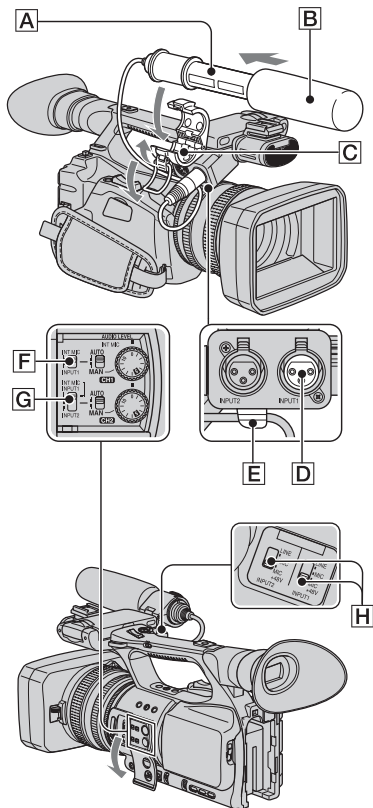

- 1 Attach the wind screen **B** to the supplied microphone **A**.

- 2 Place the microphone **A** in the microphone holder **C** with the model name facing upward, close the cover, and shut the clamp.

- 3 Connect the plug of the microphone to the INPUT1 jack **D**.

- 4 Put the microphone cable into the cable holder **E**.

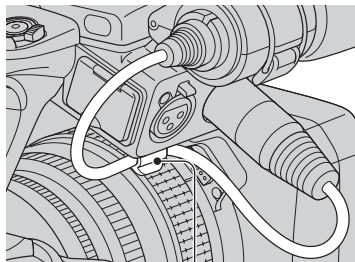

Put the cable in the outer cable holder.

- 5 Select channels with the CH1 (INT MIC/INPUT1) switch **F** and the CH2 (INT MIC/INPUT1/INPUT2) switch **G**.

See the table below for the recording channels.

When the CH1 switch is set to INT MIC

CH2 switch position	Input channel and source	
INT MIC	Internal microphone (L)	→ CH1
	Internal microphone (R)	→ CH2*
INPUT1	Internal microphone (mono)	→ CH1
	XLR INPUT1	→ CH2**
INPUT2	Internal microphone (mono)	→ CH1
	XLR INPUT2	→ CH2**

When the CH1 is set to INPUT1

CH2 switch position	Input channel and source	
INT MIC	XLR INPUT1	→ CH1
	Internal microphone (mono)	→ CH2**
INPUT1	XLR INPUT1	→ CH1 → CH2**
	XLR INPUT2	→ CH2**

* The recording level of channel 2 is synchronized with that of channel 1 when only the internal microphone is used. The recording level of channel 2 is controlled with the CH1 (AUDIO LEVEL) dial and the CH1 (AUTO/MAN) switch.

** You can adjust the recording levels of channel 1 and channel 2 separately.

6 Set the INPUT1 switch [H] to an appropriate position for the microphone connected to the INPUT1 jack [D].

LINE: For inputting sound from an audio device

MIC: For inputting sound from an external microphone that does not support the +48V power source.

MIC+48V: For inputting sound from a device that supports the +48V power source including the supplied microphone.

When you connect a microphone to the INPUT2 jack, set the INPUT2 switch to an appropriate position for that microphone.

Notes

- When you connect a device that supports the +48V power source to the INPUT1 or INPUT2 jack, set the INPUT1/INPUT2 switch to MIC prior to connecting the device. When you disconnect the device, set the INPUT1/INPUT2 switch to MIC first, then disconnect it.
- When you connect a microphone that does not support the +48V power source to the INPUT1 or INPUT2 jack, set the INPUT1/INPUT2 switch to MIC. If you use it with the INPUT1/INPUT2 switch set to MIC+48V, it may be damaged or the recorded sound may be distorted.

Tips

- See page 44 for adjusting the volume.

Step 2: Attaching the supplied microphone and the lens hood with lens cover (Continued)

Attaching the lens hood with lens cover

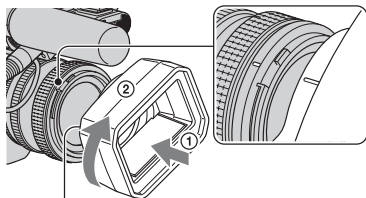

PUSH (lens hood release) button

Align the marks on the lens hood to those on the camcorder, and turn the lens hood in the direction of the arrow ②.

To remove the lens hood with lens cover

Turn the lens hood in the opposite direction to the arrow ② in the illustration while pressing the PUSH (lens hood release) button.

Tips

- If you attach or remove a 72mm (2 7/8 in.) PL filter or MC protector, remove the lens hood with lens cover.

To open or close the shutter of the lens hood with lens cover

Move the lens cover lever up or down to open or close the lens cover.

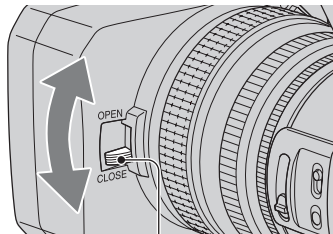

Move the lens cover lever to OPEN to open the lens cover, and move the lever to CLOSE to close the lens cover.

Step 3: Charging the battery pack

You can charge the “InfoLITHIUM” battery pack (L series) with the supplied AC Adaptor/Charger.

Notes

- You cannot use batteries other than the “InfoLITHIUM” battery pack (L series) (p. 123).

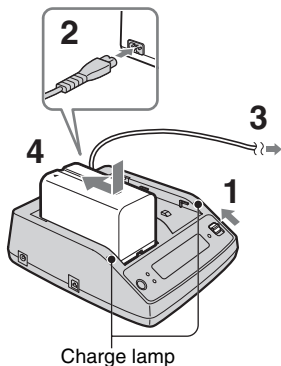

1 Set the mode change switch to **CHARGE**.

2 Connect the power cord (mains lead) to the AC Adaptor/Charger.

3 Connect the power cord (mains lead) to the wall outlet (wall socket).

4 Place the battery pack in the slot of the AC Adaptor/Charger, press it down, and slide it in the direction of the arrow as illustrated.

The charge lamp turns on and charging starts.

After charging the battery

All segments of the battery mark () appear in the display window when the normal charge of the battery is completed. You can fully charge the battery pack if you continue charging the battery pack after the charge lamp turns off until the battery mark with “FULL” appears (full charge). The battery life of the fully charged battery is slightly longer than that of the normally charged battery. Remove the battery pack from the AC Adaptor/Charger when the charge is completed.

Tips

- You can check the remaining battery life with the battery info function (p. 55).

To attach the battery pack

Press the battery pack against the back of your camcorder and slide it down.

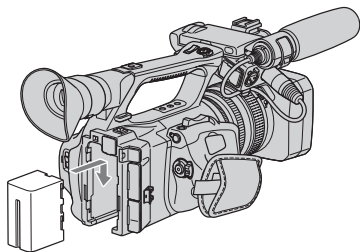

Step 3: Charging the battery pack (Continued)

To remove the battery pack

Slide the POWER switch to OFF. Push the BATT RELEASE (battery release) button and remove the battery pack.

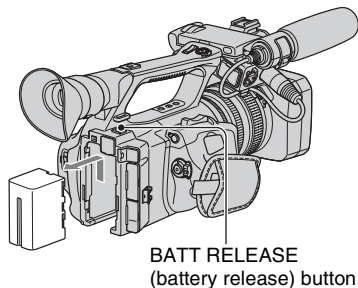

To store the battery pack

If the battery pack will not be used for a while, run down the battery and store it. See page 124 for details on storage of the battery pack.

Charging time

Approximate time (min.) required when you fully charge a fully discharged battery pack.

Battery pack	Charging time
NP-F570	145
NP-F770	230
NP-F970	310

Notes

- For HVR-Z5N*:
 - The supplied battery pack is NP-F570.
 - You cannot use the NP-F330 battery pack with your camcorder.
- For HVR-Z5U*:
 - The supplied battery pack is NP-F770.
 - You cannot use the NP-F330/F570 battery pack with your camcorder.

* You can find the model name at the bottom of your camcorder.

Recording time

Approximate time (min.) available when you use a fully charged battery pack.

Recording in the HDV format

Battery pack	Continuous recording time	Typical recording time*
NP-F570	125	60
	130	65
NP-F770	260	130
	265	130
NP-F970	390	195
	395	195

Recording in the DVCAM (DV) format

Battery pack	Continuous recording time	Typical recording time*
NP-F570	130	65
	135	65
NP-F770	270	135
	280	140
NP-F970	400	200
	415	205

Top: When the LCD backlight turns on.

Bottom: When recording with the viewfinder while the LCD panel is closed.

* Typical recording time shows the time when you repeat recording start/stop, turning the power on/off and zooming.

Playing time

Approximate time (min.) available when you use a fully charged battery pack.

HDV format pictures

Battery pack	LCD panel opened*	LCD panel closed
NP-F570	170	180
NP-F770	355	370
NP-F970	530	555

DVCAM (DV) format pictures

Battery pack	LCD panel opened*	LCD panel closed
NP-F570	180	190
NP-F770	375	390
NP-F970	570	595

* When the LCD backlight turns on.

On the battery pack

- Before changing the battery pack, slide the POWER switch to OFF.
- The Battery Info (p. 55) will not be correctly displayed under the following conditions.
 - The battery pack is not attached correctly.
 - The battery pack is damaged.
 - The battery pack is worn-out.
- Sony recommends that you use an NP-F970 battery pack when you use your camcorder with the Memory Recording Unit (optional).

On the charging/recording/playback time

- Times measured with the camcorder at 25 °C (77 °F). 10 to 30 °C (50 °F to 86 °F) is recommended.
- The recording and playback time will be shorter when you use your camcorder in low temperatures.
- The recording and playback time will be shorter depending on the conditions under which you use your camcorder.

Using an outside power source

You can use the AC Adaptor/Charger to obtain AC power.

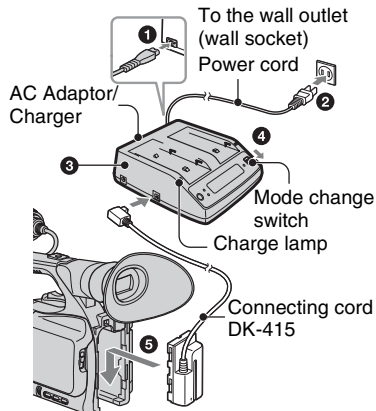

- 1 Connect the power cord (mains lead) to the AC Adaptor/Charger.
- 2 Connect the power cord (mains lead) to the wall outlet (wall socket).
- 3 Connect the connecting cable (DK-415) to the AC Adaptor/Charger.
- 4 Set the mode change switch of the AC Adaptor/Charger to VCR/CAMERA.
- 5 Press the connecting part of the connecting cable (DK-415) against the back of your camcorder in the battery slot and slide it down.

On the AC Adaptor/Charger

- Use the nearby wall outlet when using the AC Adaptor/Charger. Disconnect the AC Adaptor/Charger from the wall outlet (wall socket) immediately if any malfunction occurs while using your camcorder.
- Do not use the AC Adaptor/Charger placed in a narrow space, such as between a wall and furniture.

Step 3: Charging the battery pack (Continued)

- Do not short-circuit the DC plug of the AC Adaptor/Charger or battery terminal with any metallic objects. This may cause a malfunction.
- Even if your camcorder is turned off, AC power (house current) is still supplied to it while connected to the wall outlet (wall socket) via the AC Adaptor/Charger.

Step 4: Turning the power on and holding your camcorder properly

To record or play back, set the POWER switch to the respective positions. When you use your camcorder for the first time, the [CLOCK SET] screen appears (p. 20).

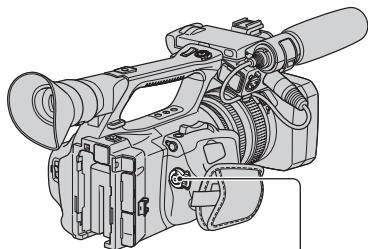

POWER switch

- 1 Slide the POWER switch to CAMERA or VCR while you press the green button.

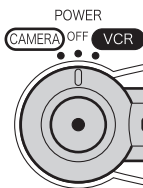

Slide the POWER switch while pressing the green button.

CAMERA: To record pictures.
VCR: To play or edit pictures.

Notes

- The current date and time appear on the LCD screen for a few seconds when you turn on your camcorder once you set the date and time ([CLOCK SET], p. 20).

- 2 Hold the camcorder properly.

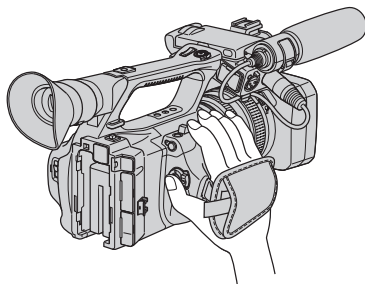

- 3 Ensure a good grip, then fasten the grip belt.

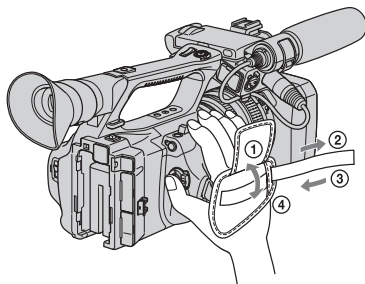

To turn off the power

Slide the POWER switch to OFF while pressing the green button.

Notes

- If warning messages appear on the screen, follow the instructions.

Step 5: Adjusting the LCD panel and viewfinder

The LCD panel

Open the LCD panel 180 degrees (①), then rotate it to the best angle to record or play back (②).

① Open 180 degrees.

② 90 degrees (max.)

② 180 degrees (max.)

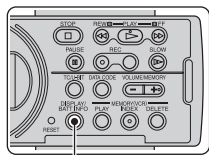

DISPLAY/BATT INFO button

💡 Tips

- You can see your mirror image on the LCD screen by setting the LCD panel facing you. The image will be recorded in a normal image.

To turn off the LCD backlight to make the battery last longer

Press and hold the DISPLAY/BATT INFO button for a few seconds until ☐_{OFF} appears. This setting is practical when you use your camcorder in bright conditions or when you want to save battery power. The recorded picture will not be affected by the setting. To turn on the LCD backlight, press and hold the DISPLAY/BATT INFO button for a few seconds until ☐_{OFF} disappears.

💡 Tips

- You can adjust the brightness of the LCD screen from [LCD BRIGHT] (p. 83).

The viewfinder

Viewfinder lens adjustment lever
Move it until the picture becomes clear.

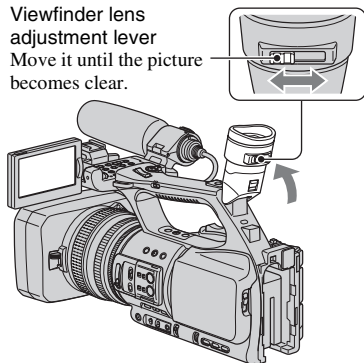

⚙️ Notes

- You may see primary colors shimmering in the viewfinder when you move your eye line. This is not a malfunction. The shimmering colors will not be recorded on the recording media.

💡 Tips

- You can adjust the brightness of the viewfinder backlight from [VF B.LIGHT] (p. 83).
- To display images both on the LCD display and in the viewfinder, set [VF POWERMODE] to [ON] (p. 84).
- To display images in black and white in the viewfinder, set [VF COLOR] to [OFF] (p. 84).

When the picture in the viewfinder is hard to see

If you cannot see the picture in the viewfinder clearly under bright circumstances, use the supplied large eyecup. To attach the large eyecup, stretch it slightly and align it with the eyecup groove in the viewfinder. You can attach the large eyecup facing either the right or left side.

⚡ Notes

- Do not remove the pre-attached eyecup.

Large eyecup (supplied)

Attach with the protruding part at the top.

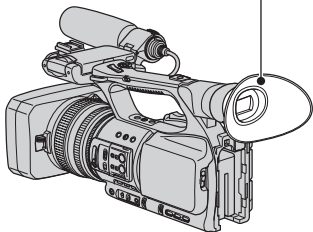
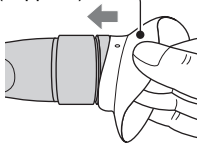

Step 6: Setting the date and time

Set the date and time when using your camcorder for the first time. If you do not set the date and time, [CLOCK SET] screen appears every time you turn on your camcorder or change the POWER switch positions.

💡 Tips

- If you do not use your camcorder for **about 3 months**, the built-in rechargeable battery gets discharged and the date and time settings may be cleared from the memory. In that case, charge the rechargeable battery and then set the date and time again (p. 128).

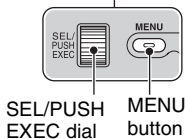
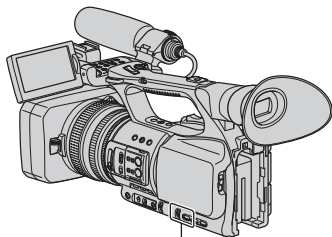

Skip to step 4 when you set the clock for the first time.

1 Press the MENU button.

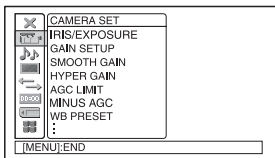

2 Select [OTHERS] by turning the SEL/PUSH EXEC dial, then press the dial.

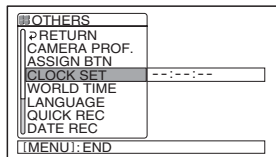

3 Select [CLOCK SET] by turning the SEL/PUSH EXEC dial, then press the dial.

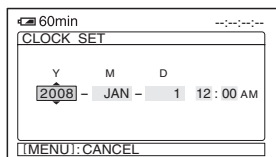

4 Set [Y] (year) by turning the SEL/PUSH EXEC dial, then press the dial.

You can set any year up to the year 2079.

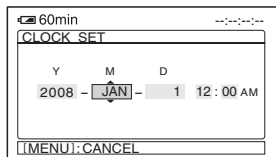

5 Set [M] (month), [D] (day), hour and minute, then press the dial.

The clock starts.

For midnight, set it to 12:00 AM.

For midday, set it to 12:00 PM.

Tips

- The date and time are automatically recorded on the tape, and can be displayed during playback (DATA CODE button, p. 54).

Changing the language setting

You can change the on-screen displays to show messages in a specified language.

Press the MENU button and select the

 (OTHERS) with the SEL/PUSH EXEC dial. Select the screen language in [LANGUAGE] (p. 93).

Step 7: Inserting a tape or a “Memory Stick Duo”

Cassette tape

See page 119 for details on tapes including which tapes can be used and how to protect from overwriting tapes.

- 1 Slide and hold the  **OPEN/EJECT** lever in the direction of the arrow and open the lid.

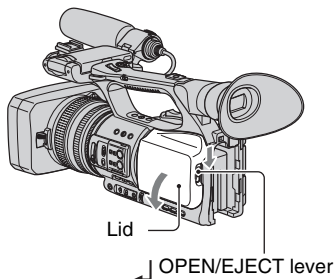

The cassette compartment automatically comes out.

- 2 Insert a cassette with its window facing outwards, then press **PUSH**.

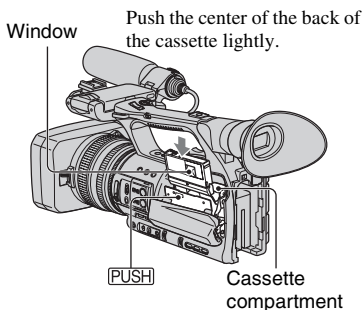



The cassette compartment automatically slides back in.

Notes

- Do not push the portion marked **DO NOT PUSH** while the cassette compartment is sliding in. Doing so may cause a malfunction.

- 3 Close the lid.

Tips

- The recordable time varies depending on [DV REC MODE] (p. 86).  

To eject the cassette

Open the lid following the same procedure as described in step 1 and remove the cassette.

“Memory Stick Duo”

You can use only a “Memory Stick Duo” marked with **MEMORY STICK DUO**, **MEMORY STICK PRO DUO** or **MEMORY STICK PRO-HG DUO** (p. 122).

- 1 Open the “Memory Stick Duo” slot cover in the direction of the arrow.

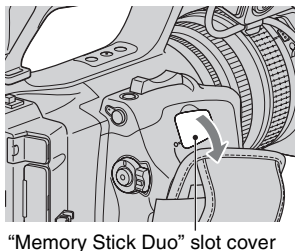

-
- 2** Insert the “Memory Stick Duo” into the “Memory Stick Duo” slot in the right direction until it clicks.

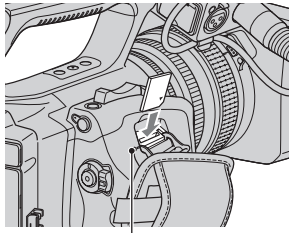

Access lamp

🔗 Notes

- If you insert the “Memory Stick Duo” into the slot in the wrong direction, the “Memory Stick Duo,” the “Memory Stick Duo” slot, or image data may be damaged.

To eject a “Memory Stick Duo”

Lightly push the “Memory Stick Duo” once.

🔗 Notes

- When the access lamp is lit or flashing, your camcorder is reading/writing data. Do not shake or knock your camcorder, turn the power off, eject the “Memory Stick Duo,” or remove the battery pack. Otherwise, image data may be damaged.
- When inserting or ejecting the “Memory Stick Duo,” be careful with the “Memory Stick Duo” from popping out and dropping.

Recording

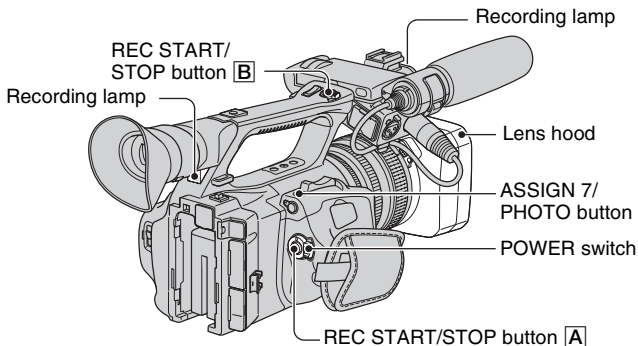

Your camcorder records movies on tape and still images on “Memory Stick Duo.” Do the following steps to record movies.

- This camcorder can record movies in HDV or DVCAM (DV) format. The factory setting is HDV format ([REC FORMAT], p. 85).

1 Open the shutter of the lens hood.

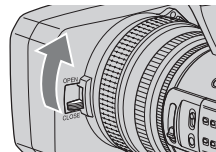

2 Slide the POWER switch to CAMERA while pressing the green button.

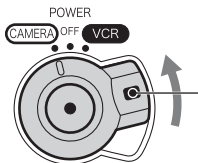

Press and hold the green button when you slide the POWER switch from OFF.

3 Press the REC START/STOP button **A** (or **B**).

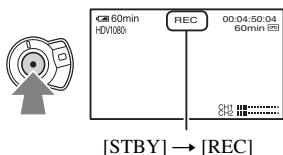

The recording lamp lights up during recording.

To stop the movie recording, press the REC START/STOP button again.

Tips

- When recording in HDV format, the aspect ratio is fixed to 16:9. When recording in DVCAM (DV) format, you can switch the aspect ratio to 4:3 ([DV WIDE REC], p. 86).
- You can change the screen display during recording (p. 54).
- Indicators displayed on the screen during recording are shown on page 140.
- The recording lamp can be set to stay off ([REC LAMP[F]], [REC LAMP[R]], p. 94).
- You cannot record movies on a "Memory Stick Duo."
- For low angle recording, the REC START/STOP button on the handle is convenient. Release the HOLD lever to enable the REC START/STOP button. It might be helpful if you set the LCD panel face up or close it after turning it face down, or lift the viewfinder up during the low angle recording.

To capture still images

- Assign [PHOTO] to the ASSIGN 7/PHOTO button (p. 46).
- Press the ASSIGN 7/PHOTO button or the PHOTO button on the Remote Commander.





A still image will be recorded on the “Memory Stick Duo.”  disappears when the recording is completed.

You can capture still images during movie recording.

Tips

- See page 142 for indicators that appear on the screen during recording.
- You can assign [PHOTO] to another ASSIGN button from  (OTHERS) → [ASSIGN BTN] and use that ASSIGN button as a PHOTO button.

Capacity of the “Memory Stick Duo” (MB) and the number of recordable pictures

	1.2M 1440 × 810 	0.9M 1080 × 810 	VGA 640 × 480 	0.2M 640 × 360 
512MB	770	1000	2900	3650
1GB	1550	2100	6000	7500
2GB	3150	4300	12000	15000
4GB	6300	8500	23500	29500
8GB	12500	17000	48000	60000
16GB	25500	34500	97500	122000

Notes

- Specifications are for Sony “Memory Stick Duo.” The actual number of recordable pictures can vary depending on the recording environment and the type of “Memory Stick Duo.”
- You cannot store a still image under the following conditions:
 - When [SCAN TYPE] is set to [24] or [24A] and the shutter speed is slower than 1/48 (p. 85, 86)

- When [SCAN TYPE] is set to [60] or [30] and the shutter speed is slower than 1/60 (p. 85, 86)
- While using the fader
- While using [SMTH SLW REC]
- While using shot transition
- The unique pixel array of Sony’s ClearVid CMOS sensor and image processing system (Enhanced Imaging Processor) allows for still image resolution equivalent to the sizes described.

Tips

- Image sizes of still images are as follows:
 - Recording in HDV format/DVCAM (DV) format (16:9): 1.2M
 - Recording in DVCAM (DV) format (4:3): 0.9M
 - Playing back in HDV format: 1.2M
 - Playing back in DVCAM (DV) format (16:9): 0.2M
 - Playing back in DVCAM (DV) format (4:3): VGA

To store still images captured from movies on a tape on “Memory Stick Duo”

You can capture an image in a movie and record it on a “Memory Stick Duo” as a still image. Be sure to insert a recorded tape and a “Memory Stick Duo” in your camcorder.

- Assign [PHOTO] to the ASSIGN 7/PHOTO button (p. 46).
- Set the POWER switch to VCR.
- Press the  (play) button to search for the scene you want to save as a still image. Press the ASSIGN 7/PHOTO button or the PHOTO button on your Remote Commander at the scene.

Notes

- The recorded date and time on the tape and the stored date and time on the “Memory Stick Duo” are both saved on the “Memory Stick Duo.” When you view the still images, only the recorded date and time on the tape will be displayed on the screen (Data code, p. 54).

- Camera data stored on the tape will not be copied to the “Memory Stick Duo.”
- You cannot store a still image during using your camcorder with [PB ZOOM] set to [ON] (p. 93).

Changing the settings of your camcorder recordings

Adjusting the zoom

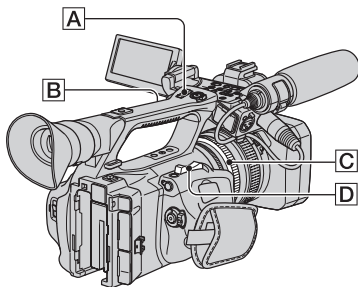

Using the zoom lever

Move the power zoom lever **D** slightly for a slower zoom. Move it further for a faster zoom.

Wide view: (Wide angle)

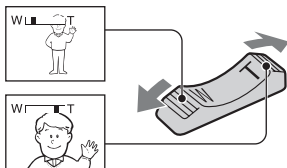

Close view: (Telephoto)

⚡ Tips

- The minimum distance required between your camcorder and the subject for focus is about 1 cm (about 13/32 in.) for wide angle and about 80 cm (about 2 5/8 feet) for telephoto.
- The focus may not be adjusted at certain zoom positions if the subject is within 80 cm (about 2 5/8 feet) from your camcorder.
- When you set [FOCUS MACRO] to [OFF], you cannot focus on a subject within 80 cm (about 2 5/8 feet) regardless of the zoom position (p. 73).
- Be sure to keep your finger on the power zoom lever **D**. If you move your finger off the power zoom lever **D**, the operation sound of the power zoom lever **D** may also be recorded.

- You can increase the zoom speed of the zoom lever **D** or the handle zoom **A** ([SPEED ZOOM], p. 73).

Using the handle zoom

- ① Set the handle zoom switch **B** to VAR or FIX.

💡 Tips

- When you set the handle zoom switch **B** to VAR, you can zoom in or out at variable speed.
 - When you set the handle zoom switch **B** to FIX, you can zoom in or out at fixed speed set in [HANDLE ZOOM] (p. 73).
- ② Press the handle zoom lever **A** to zoom in or out.

⚙ Notes

- You cannot use the handle zoom lever **A** when the handle zoom switch **B** is set to OFF.
- You cannot change the zoom speed of the zoom lever **D** with the handle zoom switch **B**.

Using the zoom ring

You can zoom at the desired speed by turning the zoom ring **C**. Fine adjustment is also possible.

⚙ Notes

- Turn the zoom ring **C** at a moderate speed. If you turn it too fast, the zoom speed may lag behind the zoom ring rotation speed, or the operation sound of the zoom may also be recorded.

Adjusting the focus manually

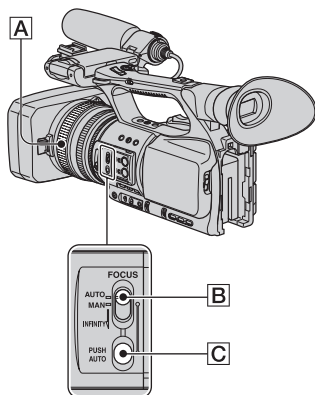

You can adjust the focus manually for different recording conditions. Use this function in the following cases.

- To record a subject behind a window covered with raindrops.
- To record horizontal stripes.
- To record a subject with little contrast between the subject and its background.
- When you want to focus on a subject in the background.

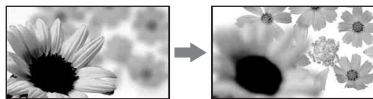

- To record a stationary subject using a tripod.

1 During recording or standby, set the FOCUS switch [B] to MAN.

appears.

2 Rotate the focus ring [A] and adjust the focus.

changes to when the focus cannot be adjusted any farther. changes to when the focus cannot be adjusted any closer.

Tips

For focusing manually

- It is easier to focus on the subject when you use the zoom function. Move the power zoom lever towards T (telephoto) to adjust the focus, and then, towards W (wide angle) to adjust the zoom for recording.
- When you want to record a close-up image of a subject, move the power zoom lever towards W (wide angle) to fully magnify the image, then adjust the focus.

To restore automatic adjustment

Set the FOCUS switch [B] to AUTO. disappears and the automatic focus adjustment is restored.

Using automatic focus temporarily (Push auto focus)

Record the subject while pressing and holding the PUSH AUTO button [C]. If you release the button, the setting returns to manual focusing. Use this function to shift the focus on one subject to another. The scenes will shift smoothly.

Tips

- The focal distance information (for when it is dark and hard to adjust the focus) appears for about 3 seconds in the following cases. (It will not be displayed correctly if you are using a conversion lens (optional)).
 - When you set the FOCUS switch to MAN and appears on the screen
 - When you rotate the focus ring while is displayed on the screen.

Using the expanded focus (Expanded focus)

Assign [EXP.FOCUS] to any one of the ASSIGN buttons beforehand (p. 46). During standby, press the ASSIGN button to which [EXP.FOCUS] is assigned. [EXPANDED FOCUS] appears and the center of the screen is magnified by about 2.0 times. It will be easier to confirm the focus setting during manual focusing. The screen returns to the original size when you press the button again.

Notes

- The screen returns to the original size when you start recording during the expanded focus display.

Tips

- You can select a type of an expanded image displayed during the expanded focus ([EXP.FOCUS TYPE], p. 82).

Focusing on a distant subject (Focus infinity)

Slide the FOCUS switch [B] to INFINITY and hold it there.

▲ appears on the screen.

To return to manual focus mode, release the FOCUS switch [B]. This function enables you to set focus on a distant subject even when the focus is automatically set on a close subject.

Notes

- This function is only available during the manual focus. It is not available during the automatic focus.

Adjusting the image brightness

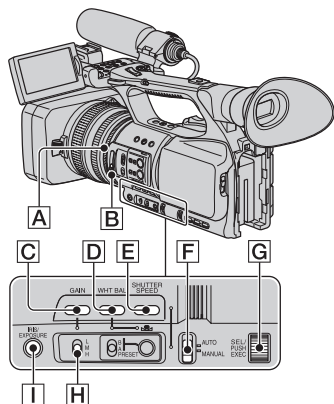

You can adjust the image brightness by adjusting the iris, gain or shutter speed, or by reducing the light volume with the ND filter [B]. Also, when [EXPOSURE] is assigned to the iris ring [A], you can adjust the iris, gain and shutter speed with the iris ring [A]. You can assign [IRIS] or [EXPOSURE] to the iris ring [A] from [IRIS/EXPOSURE] of the  (CAMERA SET) menu (p. 69). The default setting is [IRIS].





Notes

- You cannot use the back light function and the spotlight function if at least two of iris, gain and shutter speed are adjusted manually.
- [AE SHIFT] is not effective while you adjust the iris, gain and shutter speed all manually.

Adjusting the iris

You can manually adjust the iris to control the volume of the light entering the lens. By adjusting the iris, you can change or close the aperture of the lens, which is expressed as an F value between F1.6 and F11. The volume of the light increases the more that you open the aperture (decreasing F value).



The volume of the light decreases the more that you close the aperture (increasing F value). The current F value appears on the screen.

- ① Select  (CAMERA SET) menu → [IRIS/EXPOSURE] → [RING ASSIGN] → [IRIS] (p. 69).
- ② During recording or standby, set the AUTO/MANUAL switch  to MANUAL.
- ③ When the iris is automatically adjusted, press the IRIS/EXPOSURE button .  next to the iris value disappears (p. 82), or the iris value appears on the screen.
- ④ Adjust the iris with the iris ring . When you assign [PUSH AT IRIS] to one of the ASSIGN buttons, you can automatically adjust the iris while pressing and holding that ASSIGN button. See page 46 for details on the ASSIGN button.

Tips

- The F value becomes close to F3.4 as the zoom position changes from W to T even when you open the aperture by setting the F value lower than F3.4, such as F1.6.
- The range of focus, an important effect of the aperture, is called the depth of field. The depth of field gets shallower as the aperture is opened, and deeper as the aperture is closed. Use the aperture creatively to obtain the desired effect in your photography.
- This is handy for making the background blurred or sharp.

To adjust the iris automatically

Press the IRIS/EXPOSURE button , or set the AUTO/MANUAL switch  to AUTO.

The iris value disappears, or  appears next to the iris value.



Notes



- When you set the AUTO/MANUAL switch  to AUTO, other manually adjusted items (gain,



shutter speed, white balance) also become automatic.



Adjusting the exposure

When [IRIS/EXPOSURE] is set to [EXPOSURE], you can adjust the image brightness by adjusting the iris, gain and shutter speed with the iris ring. You can also manually preset one or two of these parameters and adjust the remaining parameter(s) with the iris ring.

- ① Select  (CAMERA SET) menu → [IRIS/EXPOSURE] → [RING ASSIGN] → [EXPOSURE] (p. 69)
- ② During recording or standby, set the AUTO/MANUAL switch  to MANUAL.
- ③ When [EXPOSURE] is automatically adjusted, press the IRIS/EXPOSURE button .

The iris, gain and shutter speed values and  appear on the screen. You can adjust the iris, gain and shutter speed with the iris ring .

When  is not displayed, do the following operation.  appears next to the items, indicating that you can adjust them with the iris ring .

- Gain
Press the GAIN button .
- Shutter speed
Press the SHUTTER SPEED button  twice. When the shutter speed is not locked, press the button once.

- ④ Adjust the image brightness by turning the iris ring .

When you assign [PUSH AT IRIS] to one of the ASSIGN buttons, you can automatically adjust the exposure while pressing and holding that ASSIGN button. See page 46 for details on the ASSIGN button.

To restore automatic adjustment

Press the IRIS/EXPOSURE button **[I]**, or set the AUTO/MANUAL switch **[F]** to AUTO.

The values next to which **[E]** is displayed disappear, or **[A]** appears next to those values.

⚡ Notes

- When you set the AUTO/MANUAL switch **[F]** to AUTO, other manually adjusted items (gain, shutter speed, white balance) also become automatic.

💡 Tips

- When you press the GAIN button **[C]** while **[E]** is displayed on the screen next to the gain value, **[E]** disappears and you can adjust the gain manually. When you press the GAIN button **[C]** again, **[E]** appears and you can adjust the gain with the iris ring **[A]**. See step ② in “Adjusting the gain” for details on how to adjust the gain.
- When you press the SHUTTER SPEED button **[E]** while **[E]** is displayed on the screen next to the shutter speed value, **[E]** disappears and you can adjust the shutter speed manually. When you press the SHUTTER SPEED button **[E]** again, **[E]** appears and you can adjust the shutter speed with the iris ring **[A]**. See steps ③ and ④ in “Adjusting the shutter speed” on page 32 for details on how to adjust the shutter speed.

Adjusting the gain

You can adjust the gain manually when you do not want to use the AGC (automatic gain control).

- ① Set the AUTO/MANUAL switch **[F]** to MANUAL during recording or standby.
- ② When the gain is automatically adjusted, press the GAIN button **[C]**. **[A]** next to the gain value disappears, or the gain value appears on the screen.
- ③ Set the gain switch **[H]** to H, M or L. The gain value set for the selected gain switch position appears on the screen. You can set the gain value for each gain switch position from [GAIN SETUP] of the **[CAMERA SET]** menu (p. 69).

To adjust the gain automatically

Press the GAIN button **[C]**, or set the AUTO/MANUAL switch **[F]** to AUTO. The gain value disappears, or **[A]** appears next to the gain value.

⚡ Notes

- When you set AUTO/MANUAL switch **[F]** to AUTO, other manually adjusted items (iris, shutter speed, white balance) also become automatic.

💡 Tips

- When you record a movie with the gain set to [-6dB] and play it back with the data code, the gain value is displayed as [---].

Adjusting the shutter speed



You can manually adjust and fix the shutter speed. You can make a moving subject look still or emphasize the movement of a moving subject by adjusting the shutter speed.

- ① During recording or standby, set AUTO/MANUAL switch **[F]** to MANUAL.
- ② Press the SHUTTER SPEED button **[E]** until the shutter speed value is highlighted.
- ③ Change the shutter speed displayed on the screen by turning the SEL/PUSH EXEC dial **[G]**.
You can adjust the shutter speed in a range of 1/4 second through 1/10000 second or the extended clear scan (**[ECS]**).
The denominator of the set shutter speed appears on the screen. For example, [100] appears on the screen when you set the shutter speed to 1/100 second. The larger the value on the screen, the faster the shutter speed.
- ④ Press the SEL/PUSH EXEC dial **[G]** to lock the shutter speed.
To readjust the shutter speed, do steps ② to ④.

💡 Tips

- You can set the shutter speed between 1/3 second and 1/10000 second in the following settings:
 - [HDV PROGRE.]→[SCAN TYPE]→[24] or [24A]
 - [DV PROGRE.]→[SCAN TYPE]→[24]
- It is difficult to focus automatically at a lower shutter speed. Manual focusing with your camcorder attached to a tripod is recommended.
- The picture may flicker or change colors under fluorescent lamps, sodium lamps, or mercury lamps. You can reduce flickering by setting the shutter speed to an appropriate frequency in the extended clear scan (ECS) range ([ECS] range ([ECS FREQ.], p. 71).
- When recording a subject such as a monitor screen, set the shutter speed in the extended clear scan (ECS) range in order to obtain images with no horizontal bands of noise. You can set the shutter speed for the extended clear scan from [ECS FREQ.] in the  (CAMERA SET) menu (p. 71).

To adjust the shutter speed automatically

Press the SHUTTER SPEED button  twice, or set the AUTO/MANUAL switch  to AUTO. The shutter speed value disappears, or  appears next to the shutter speed value.

🔍 Notes

- When you set the AUTO/MANUAL switch  to AUTO, other manually adjusted items (iris, gain, white balance) also become automatic.

Adjusting the volume of light (ND filter)

You can record the subject clearly by using the ND filter  when the recording environment is too bright. The ND filters 1, 2 and 3 reduce the volume of light to about 1/4, 1/16 and 1/64, respectively.

If $\text{ND}^1_{1/4}$ flashes during the iris automatic adjustment, set the ND filter to 1. If $\text{ND}^2_{1/16}$ flashes during the iris automatic

adjustment, set the ND filter to 2. If $\text{ND}^3_{1/64}$ flashes during the iris automatic adjustment, set the ND filter to 3. The ND filter indicator will stop flashing and remain on the screen. If $\text{ND}^{\text{OFF}}_{\text{CLR}}$ flashes, set the ND filter to OFF. $\text{ND}^{\text{OFF}}_{\text{CLR}}$ will disappear from the screen.

🔍 Notes

- If you change the ND filters  during recording, the movie and sound may be distorted.
- When adjusting the iris manually, the ND icon does not flash even if the light volume should be adjusted with the ND filter.



💡 Tips

- While recording a bright subject, diffraction may occur if you close the aperture further down, resulting in a fuzzy focus (this is a common phenomenon with video cameras). The ND filter  suppresses this phenomenon and gives better recording results.

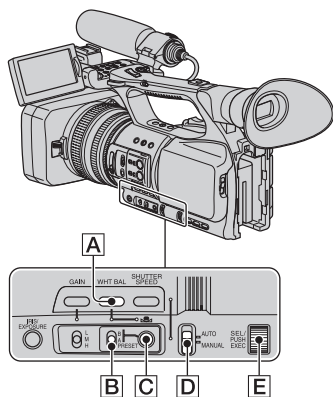
Adjusting to natural color (White balance)





You can adjust and fix the white balance according to the lighting conditions of recording environment.

You can store white balance values in memory A () and memory B (),

Changing the settings of your camcorder recordings (Continued)

respectively. Unless a white balance is readjusted, values will remain even after the power has been turned off.



When you select PRESET, [OUTDOOR], [INDOOR] or [MANU WB TEMP] is selected, according to which one you previously set with [WB PRESET] in the  (CAMERA SET) menu.

1 During recording or standby, set the AUTO/MANUAL switch  to MANUAL.

2 Press the WHT BAL button .









3 Set the white balance memory switch  to any one of PRESET/A/B.

Select A or B for recording with the white balance setting stored in memory A or B.







Indicator	Shooting conditions
 A (Memory A)	• White balance values adjusted for light sources can be stored in memory A and memory B. Follow the steps in "To save the adjusted white balance value in memory A or B" (p. 34).
 B (Memory B)	
 Outdoor ([OUTDOOR])	• Recording neon signs or fireworks • Recording sunset/sunrise, just after sunset or just before sunrise • Under daylight color fluorescent lamps



Indicator	Shooting conditions
 Indoor ([INDOOR])	• Under the lighting conditions that change in many ways, such as a party hall • Under strong light such as in a photography studio • Under sodium lamps or mercury lamps
Color temperature ([MANU WB TEMP])	• Color temperature can be set between 2300K and 15000K (the default setting is 6500K).

Tips



- You can change the outdoor white balance setting by setting offset. Press  (one push) button  while  (outdoor) is selected and turn the SEL/PUSH EXEC dial  to select an offset value from -7 (bluish) to 0 (normal, the default setting) to +7 (reddish). You can also set the white balance offset value from the menu ([WB OUTDR LVL], p. 70).
- You can change the color temperature. Set [WB PRESET] to [MANU WB TEMP] and the white balance memory switch  to PRESET, then press the  (one push) button . Turn the SEL/PUSH EXEC dial  until the desired temperature appears on the screen, then press the dial to set the temperature. You can also set the color temperature from the menu ([WB TEMP SET], p. 70).

To save the adjusted white balance value in memory A or B

- ① Set the white balance memory switch to A ( A) or B ( B) in step 3 of "Adjusting to natural color (White balance)."
- ② Capture a white subject, such as white paper, full-screen in the same lighting condition as the one in which the subject is.
- ③ Press  (one push) button .  A or  B starts flashing rapidly. It will stay on when the white balance adjustment is completed and the

adjusted value is stored in  A or  B.

To adjust the white balance automatically

Press the WHT BAL button  A or set the AUTO/MANUAL switch  D to AUTO.

Notes

- When you set the AUTO/MANUAL switch  D to AUTO, other manual adjustments (iris, gain, and shutter speed) also become automatic.

Customizing the picture quality (Picture profile)

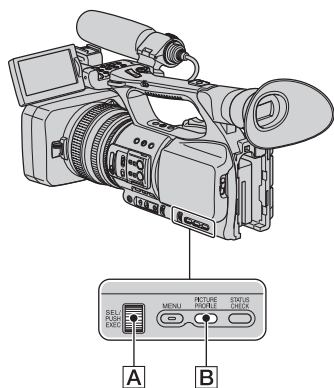

You can customize the picture quality by adjusting picture profile items such as [GAMMA] and [DETAIL].

Connect your camcorder to a TV or monitor, and adjust the picture quality while observing the picture on the TV or monitor screen.

Picture quality settings for different recording conditions are stored in [PP1] through [PP6] as default settings.

Notes

- When you set [x.v.Color] of the  (CAMERA SET) menu to [ON], the picture profile will be disabled.

Picture profile number (setting name)	Recording condition name
PP1 :USER	Default settings the same as when Picture Profile is [OFF]
PP2 :USER	Default settings the same as when Picture Profile is [OFF]
PP3 :PRO COLOR	Example settings of pictures recorded by a professional shoulder camcorder with ITU709 gamma
PP4 :PD COLOR	Example settings of pictures recorded by a professional handy camcorder with PD gamma
PP5 :FILM LOOK1	Example settings of pictures recorded on cinema color negative film
PP6 :FILM LOOK2	Example settings of pictures screened with cinema color print film

1 During standby, press the **PICTURE PROFILE** button  B.

2 Select a picture profile number with the **SEL/PUSH EXEC** dial  A.

You can record with the settings of the selected picture profile.

3 Select [OK] with the SEL/PUSH EXEC dial **[A]**.

To cancel the picture profile recording

Select [OFF] in step 2 with the SEL/PUSH EXEC dial **[A]**.

To change the picture profile

You can change the settings stored in [PP1] through [PP6].

- ① Press the PICTURE PROFILE button **[B]**.
- ② Select the PICTURE PROFILE number with the SEL/PUSH EXEC dial **[A]**.
- ③ Select [SETTING] with the SEL/PUSH EXEC dial **[A]**.
- ④ Select an item to be adjusted with the SEL/PUSH EXEC dial **[A]**.
- ⑤ Adjust the picture quality with the SEL/PUSH EXEC dial **[A]**.
- ⑥ Repeat steps ④ and ⑤ to adjust other items.
- ⑦ Select [ RETURN] with the SEL/PUSH EXEC dial **[A]**.
- ⑧ Select [OK] with the SEL/PUSH EXEC dial **[A]**.

A picture profile indicator appears.

Tips

- You can assign picture profiles to the ASSIGN buttons and use them to turn the picture profiles on and off (p. 46).

BLACK LEVEL

To set the black level.

Item	Description and settings
[MASTER BLACK]	Sets the master black level. -15 to +15
[BLACK R]	Sets the black level of Rch. [MASTER BLACK] + [BLACK R] is the black level of Rch. -15 to +15
[BLACK G]	Sets the black level of Gch. [MASTER BLACK] + [BLACK G] is the black level of Gch. -15 to +15
[BLACK B]	Sets the black level of Bch. [MASTER BLACK] + [BLACK B] is the black level of Bch. -15 to +15

GAMMA

To select a gamma curve.

Item	Description and settings
[STANDARD]	Standard gamma curve
[CINEMATONE1]	Gamma curve 1 for producing tone of film camera images
[CINEMATONE2]	Gamma curve 2 for producing tone of film camera images
[ITU709]	Gamma curve that corresponds to ITU-709. Gain in low intensity area: 4.5
[G5.0]	Gamma curve with 5.0 of a low intensity area gain
[PD]	Gamma curve for producing tone similar to DCR-PD series
[x.v.]	Gamma curve similar to x.v.Color

BLACK GAMMA

To correct gamma in low intensity area.

Item	Description and settings
[RANGE]	Selects a correcting range. HIGH / MIDDLE / LOW
[LEVEL]	Sets the correcting level. -7 (maximum black compression) to +7 (maximum black stretch)

Changing the settings of your camcorder recordings (Continued)

KNEE

To set knee point and slope for video signal compression to reduce over-highlighting by limiting signals in high contrast area of the subject to the dynamic range of your camcorder.

Item	Description and settings
[MODE]	Selects a mode either automatic or manual. [AUTO] : to set the knee point and slope automatically. [MANUAL] : to set the knee point and slope manually.
[AUTO SET]	Sets the maximum point and sensitivity in the automatic mode. [MAX POINT] : Sets the maximum point. 90% to 100% [SENSITIVITY] : Sets the sensitivity. HIGH/MIDDLE/LOW
[MANUAL SET]	Sets the knee point and slope manually. [POINT] : Sets the knee point. 75% to 105% [SLOPE] : Sets the knee slope. -5(gentle) to +5(steep)

COLOR MODE

To set type and level of colors.

Item	Description and settings
[TYPE]	Selects a type of colors. [STANDARD] : Standard colors [CINEMATONE1] : Film camera image-like colors good with [GAMMA] set to [CINEMATONE1] [CINEMATONE2] : Film camera image-like colors good with [GAMMA] set to [CINEMATONE2] [ITU709 MTX] : Colors corresponding to ITU-709
[LEVEL]	Sets a color level when you set [TYPE] to the settings other than [STANDARD]. 1 (close to color settings of [STANDARD]) to 8 (color settings of the selected type)

COLOR LEVEL

To set the color level.

Item	Description and settings
	-7 (light) to +7 (dark), -8: black and white

COLOR PHASE

To set the color phase.

Item	Description and settings
	-7 (greenish) to +7 (reddish)

COLOR DEPTH

To set the color depth for each color phase.

This function is more effective for chromatic colors and less effective for achromatic colors. The color looks deeper as you increase the setting value to more positive side, and lighter as you decrease the value to more negative side. This function is effective even if you set [COLOR LEVEL] to [-8] (monotone).

Item	Description and settings
[R]	-7 (light red) to +7 (deep red)
[G]	-7 (light green) to +7 (deep green)
[B]	-7 (light blue) to +7 (deep blue)
[C]	-7 (light cyan) to +7 (deep cyan)
[M]	-7 (light magenta) to +7 (deep magenta)
[Y]	-7 (light yellow) to +7 (deep yellow)

COLOR CORRECT

To set items for the color correction.

Item	Description and settings
[TYPE]	Selects color correction type. [OFF] : Not correct colors. [COLOR REVISN] : Corrects colors stored in memory. Colors not stored in memory (displayed in black and white when [COLOR EXTRCT] is set) will not be corrected. [COLOR EXTRCT] : Displays areas in colors that are stored in the memory. The other areas are displayed in black and white. You can use this function to add effects on your movies or to confirm the colors to be stored in the memory.
[MEMORY SEL]	Selects a memory to be effective. [1]: Sets Memory 1 to be effective. [2]: Sets Memory 2 to be effective. [1&2]: Sets both Memory 1 and 2 to be effective.

COLOR CORRCT (Continued)

Item	Description and settings
[MEM1 COLOR]	Sets colors stored in Memory 1. [PHASE] : Sets color phase. 0 (purple) → 8 (red) → 16 (yellow) → 24 (green) → 31 (blue) [RANGE] : Sets color phase range. 0 (no color selection), 1 (narrow: to select only a single color) to 31 (wide: to select multiple colors in similar color phase) [SATURATION] : Sets saturation. 0 (to select from light colors to dark colors) to 31 (to select dark color) [ONE PUSH SET]: Automatically sets [PHASE] for a subject at the center of the marker. [SATURATION] is set to 0.
[MEM1 REVISN]	Corrects colors in Memory 1. [R GAIN] : Corrects the redness of the color in Memory 1. Tone of cyan becomes higher as the redness decreases. -15 (less reddish) to +15 (more reddish) 0 for no correction [B GAIN] : Corrects the blueness of the color in Memory 1. Tone of yellow becomes higher as the blueness decreases. -15 (less bluish) to +15 (more bluish) 0 for no correction
[MEM2 COLOR]	Sets colors stored in Memory 2. See [MEM1 COLOR] for description and settings.
[MEM2 REVISN]	Corrects colors in Memory 2. See [MEM1 REVISN] for description and settings.

Tips

- Setting both memories to the same setting doubles the color correction effect.
- The settings of [COLOR CORRCT] will be retained even if the power is turned off. However, if you want to correct colors that may change according to time of the day, weather, location, etc., it is recommended that you set [COLOR CORRCT] again prior to recording.
- If you change the white balance value or the settings of [WB SHIFT], [COLOR LEVEL] or [COLOR PHASE] of the picture profile, the settings of [RANGE] and [PHASE] of the selected memory will change. When you change the white balance value or the settings of the above picture profile items after you have set [RANGE] and [PHASE], check the settings of [COLOR CORRCT] prior to recording.
- During the automatic white balance adjustment, the white balance value automatically varies according to the lighting conditions of your recording environment. The manual white balance adjustment is recommended when you use [COLOR CORRCT].

WB SHIFT

To set items for the white balance shift.

Item	Description and settings
[FILTER TYPE]	Selects a color filter type for the white balance shift. [LB-CC] : Film type (color conversion and correction) [R-B] : Video type (correction of R and B levels)
[LB[COL TEMP]]	Sets a color temperature offset value. -9 (bluish) to +9 (reddish)
[CC[MG/GR]]	Sets a color correct offset value. -9 (greenish) to +9 (magentish)
[R GAIN]	Sets an R level. -9 (low R level) to +9 (high R level)
[B GAIN]	Sets a B level. -9 (low B level) to +9 (high B level)

DETAIL

To set items for the detail.

Item	Description and settings
[LEVEL]	Sets the detail level. -7 to +7
[MANUAL SET]	[ON/OFF] : Turns on and off the manual detail adjustment. [ON] : Enables the manual detail adjustment (automatic optimization will not be performed). [OFF] : Disables the manual detail adjustment.
[V/H BALANCE]	: Sets the horizontal (H) and vertical (V) balance of detail.
[B/W BALANCE]	: Selects the balance of the upper DETAIL (P) and the lower DETAIL (N). TYPE 1 (off to the lower DETAIL (N) side) to TYPE 5 (off to the upper DETAIL (P) side)
[BLACK LIMIT]	: Sets the limit level of the lower DETAIL (N). 0 (Low limit level: likely to be limited) to 7 (High limit level: not likely to be limited)
[WHITE LIMIT]	: Sets the limit level of the upper DETAIL (P). 0 (Low limit level: likely to be limited) to 7 (High limit level: not likely to be limited)
[CRISPENING]	: Sets the crispening level. 0 (shallow crispening level) to 7 (deep crispening level)
[HI-LIGHT DTL]	: Sets the DETAIL level in the high intensity areas. -2 to +2

Changing the settings of your camcorder recordings (Continued)

SKINTONE DTL

To adjust the detail of skintone areas to reduce wrinkles.

Item	Description and settings
[ON/OFF]	Suppresses details in skin-tone areas to reduce wrinkles. Select [ON] when you want to use this function. You can also select other areas.
[LEVEL]	Sets the adjustment level. 1 (less adjust the detail) to 8 (more adjust the detail)
[COLOR SEL]	Sets color items for the detail adjustment. [PHASE] : Sets the color phase. 0 (purple) → 32 (red) → 64 (yellow) → 96 (green) → 127 (blue) [RANGE] : Sets the color range. 0 (selects no color), 1 (narrow: selects a single color) to 31 (wide: selects multiple colors in similar color phases and saturation) The detail will not be adjusted when you set [RANGE] to 0. [SATURATION] : Sets the color saturation. 0 (selects a light color) to 31 (selects a deep color) [REVERSE] : Reverses the selected color range. If you execute this function when a color has been selected, colors that were not selected will be selected instead. [Y LEVEL] : Sets the color brightness. 0 (selects a dark color) to 31 (selects a bright color) [Y RANGE] : Sets the color brightness range. 1 (narrows the brightness range) to 32 (expands the brightness range) [ONE PUSH SET]: Automatically adjusts [PHASE], [SATURATION] and [Y LEVEL] for a subject at the center of the marker. [RANGE] and [Y RANGE] will not be changed.

PROFILE NAME

To name the picture profiles set in [PP1] through [PP6] (p. 43).

COPY

To copy the settings of the picture profile to another picture profile number.

RESET

To reset the picture profile to the default setting.

To name the picture profile settings

You can name picture profile1 through 6.

- ① Press the PICTURE PROFILE button **[B]**.
- ② Select the picture profile that you want to name with the SEL/PUSH EXEC dial **[A]**.
- ③ Select [SETTING] → [PROFILE NAME] with the SEL/PUSH EXEC dial **[A]**.
- ④ Select a letter with the SEL/PUSH EXEC dial **[A]**. Repeat this operation until a complete name is entered.

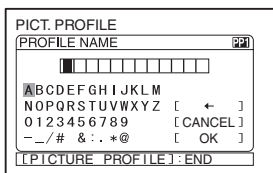

Tips

- Each name can be up to 12 characters long. Characters that can be used in profile names:
 - A to Z
 - 0 to 9
 - - _ / # & : . * @

- ⑤ Select [OK] with the SEL/PUSH EXEC dial **[A]**.
The profile name is changed.
- ⑥ Select [↶ RETURN] → [OK] with the SEL/PUSH EXEC dial **[A]**.

To copy the picture profile setting to other picture profiles

- ① Press the PICTURE PROFILE button **[B]**.
- ② Select the picture profile that you want to copy from with the SEL/PUSH EXEC dial **[A]**.
- ③ Select [SETTING] → [COPY] with SEL/PUSH EXEC dial **[A]**.

- ④ Select the number of the picture profile that you want to copy to with the SEL/PUSH EXEC dial **[A]**.
- ⑤ Select [YES] with the SEL/PUSH EXEC dial **[A]**.
- ⑥ Select [↶ RETURN] → [OK] with the SEL/PUSH EXEC dial **[A]**.

To reset the picture profile settings

You can reset the picture profile settings by each picture profile number. You cannot reset all picture profile settings at once.

- ① Press the PICTURE PROFILE button **[B]**.
- ② Select the number of the picture profile that you want to reset with the SEL/PUSH EXEC dial **[A]**.
- ③ Select [SETTING] → [RESET] → [YES] → [↶ RETURN] → [OK] with the SEL/PUSH EXEC dial **[A]**.

Changing the settings of your camcorder recordings (Continued)

Adjusting the volume

You can adjust the volume of an internal microphone or a microphone connected to the INPUT1/INPUT2 jack.

💡 Tips

- See page 10 for details on attaching the supplied microphone, and on the CH1 (INT MIC/INPUT1) and the CH2 (INT MIC/INPUT1/INPUT2) switches.

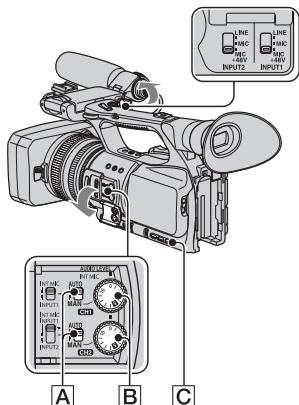

- 1** Set the **AUTO/MAN (CH1/CH2)** switch **A** of the channel to be adjusted to **MAN**.

Ⓐ appears on the screen.

- 2** Turn the **AUDIO LEVEL** dial **B** to adjust the volume during recording or standby.

To restore automatic adjustment

Set the **AUTO/MAN (CH1/CH2)** switch **A** of the manually adjusted channel to **AUTO**.

💡 Tips

- To check other audio settings, press the **STATUS CHECK** button **C**.
- For other settings, see the (AUDIO SET) menu (p. 77).

Attaching a Memory Recording Unit

You can attach an optional Memory Recording Unit HVR-MRC1 to your camcorder for recording. To attach it to your camcorder, do the following. Refer to the Memory Recording Unit operating instructions for details on its operation.

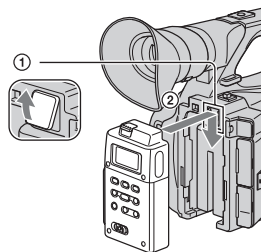

Remove the Memory Recording Unit jack cover (1). Insert the terminal of the Memory Recording Unit in the Memory Recording Unit jack and slide the unit down (2).



To remove the Memory Recording Unit

Slide the Memory Recording Unit upward while pushing its RELEASE lever downward.

🔗 Notes

- You cannot use the  HDV/DV jack when the Memory Recording Unit is attached to your camcorder.
- When you use the Memory Recording Unit, set appropriate items in [EXT REC CTRL] of the  (IN/OUT REC) menu (p. 88).

Assigning the functions to the ASSIGN buttons

Some functions need to be assigned to the ASSIGN buttons for use. You can assign a single function to any one of the ASSIGN 1 to 7 buttons.

Functions you can assign to the ASSIGN buttons

The buttons in parentheses indicate that the functions are assigned to the buttons by default.

- EXP.FOCUS (p. 30)
- FOCUS MACRO (p. 73)
- D.EXTENDER (p. 73)
- RING ROTATE (p. 69)
- HYPER GAIN (p. 70)
- AE SHIFT (p. 71) (ASSIGN 2 button)
- PUSH AT IRIS (p. 30)
- INDEX MARK (p. 47)
- STEADYSHOT (p. 72)
- BACK LIGHT (p. 72)
- SPOTLIGHT (p. 72)
- FADER (p. 73)
- SMTH SLW REC (p. 27)
- COLOR BAR (p. 76)
- LAST SCN RVW (p. 48)
- REC REVIEW (p. 48) (ASSIGN 3 button)
- END SEARCH (p. 48)
- ZEBRA (p. 80) (ASSIGN 1 button)
- MARKER (p. 81)
- PEAKING (p. 81)
- TC RESET (p. 89)
- TC COUNTUP (p. 89)
- PHOTO (p. 26) (ASSIGN 7 button)
- PICTURE PROFILE (p. 35)
- SHOT TRANSITION (p. 48)

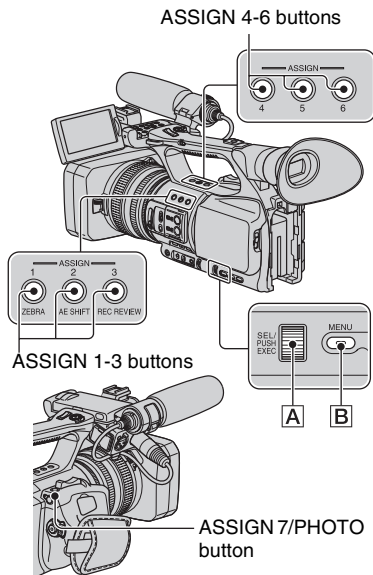

1 Press the MENU button **[B]**.

2 Select the **[OTHERS]** →
[ASSIGN BTN] with the SEL/PUSH
EXEC dial **[A]**.

3 Select the ASSIGN button to
which you want to assign a
function with the SEL/PUSH
EXEC dial **[A]**.

- [-----] appears if no function is assigned to the ASSIGN button.
- Select [YES] when you select [SHOT TRANSITION], then do step 5.

4 Select the function that you want to assign with the SEL/PUSH EXEC dial **[A]**.

5 Select **[OK]** with the SEL/PUSH EXEC dial **[A]**.

6 Select **[↵ RETURN]** with the SEL/PUSH EXEC dial **[A]**.

7 Press the MENU button **[B]** to hide the menu screen.

Tips

- Shot transition is assigned to the ASSIGN 4, 5 and 6 buttons (p. 48). Cancel the shot transition assignment to return to the pre-setting assignment.
- To cancel the shot transition, select **[SHOT TRANSITION] → [YES]** in step 3.

Recording an index signal

If you record a scene with an index signal, you can easily find that scene during playback (p. 56).

The index function will make it easier to check the transition of recording or edit your pictures using index signals.

1 Assign **[INDEX MARK]** to one of the ASSIGN buttons (p. 46).

2 Press the ASSIGN button to which **[INDEX MARK]** is assigned.

During recording

 appears for about 7 seconds and an index signal is recorded.

During standby

 flashes.

After you press the REC START/STOP button to start recording,  appears for about 7 seconds and an index signal is recorded.

To cancel the operation

Press the ASSIGN button to which **[INDEX MARK]** is assigned again before you start recording.

Notes

- You cannot record an index signal on a recorded tape afterward.

Playing back the most recently recorded movies (Last scene review)

You can set your camcorder to automatically rewind the tape to the beginning of the most recently recorded scene, play back to the end of the scene, then stop the tape.

1 Assign [LAST SCN RVW] to an ASSIGN button (p. 46).

2 During standby, press the ASSIGN button to which [LAST SCN RVW] is assigned.

The last scene review starts.

Notes

- If the recording time of the movie is short, [LAST SCN RVW] may not work correctly.
- [LAST SCN RVW] does not work once you take out a tape.

Tips

- If you press the ASSIGN button again during the last scene review, your camcorder plays back the last 5 seconds of the most recently recorded movie, then goes standby at the end of the recording.

Reviewing the most recently recorded scenes (Rec review)

You can view about 2 seconds of the scene recorded just before you stopped the tape. This is convenient during playback of the latest scene check.

Press the REC REVIEW button or the ASSIGN button to which [REC

REVIEW] is assigned during standby.

The last 2 seconds (approx.) of the most recently recorded scenes will be played back, then your camcorder returns to standby.

Searching for the last scene of the most recent recording (End search)

1 Assign [END SEARCH] to one of the ASSIGN buttons (p. 46).

2 Press the ASSIGN button to which [END SEARCH] is assigned.

The last scene of the most recent recording will be played back for about 5 seconds, and the camcorder goes standby at the point where the last recording has finished.

Notes

- End search will not work once you eject the tape.
- End search will not work correctly if a blank section exists between recorded sections on the tape.

Using the Shot transition

You can store settings of focus, zoom, iris, gain, shutter speed and white balance, and smoothly shift from the current settings to the stored settings (shot transition). For example, you can shift the focus from closer objects to farther objects, or change the depth of field by adjusting the iris. You can also develop scenes under different

conditions smoothly. If you store manually adjusted settings of white balance, you can smoothly shift from one scene to another under different conditions, such as from indoor to outdoor.

Sony recommends that you use a tripod to avoid image blurring.

You can set the items, such as transition curve and transition time, in [SHOT TRANSITION] of the  (CAMERA SET) menu (p. 75).

ASSIGN 4 - 6 buttons

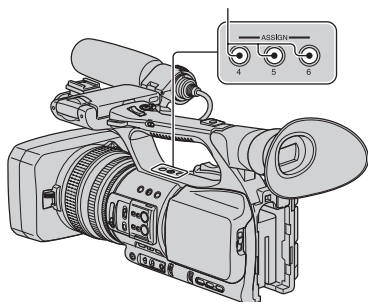

1 Assign [SHOT TRANSITION] to the ASSIGN buttons (p. 46).

Tips

- Shot transition is assigned to ASSIGN 4, 5 and 6 buttons.

2 Store the settings (shot).

- ① Press the ASSIGN 4 button repeatedly to bring up the SHOT TRANSITION STORE screen.
- ② Manually adjust the settings.
See pages 28 to 43 for details on how to adjust the settings manually.
- ③ Press the ASSIGN 5 button for storing the settings in SHOT-A, or the ASSIGN 6 button for storing the settings in SHOT-B.

Notes

- The settings stored in SHOT-A or SHOT-B will be erased when you set the POWER switch to OFF.

3 Check the stored settings.

- ① Press the ASSIGN 4 button repeatedly to bring up the SHOT TRANSITION CHECK screen.
- ② Press the ASSIGN 5 button to check the SHOT-A. Press the ASSIGN 6 button to check the SHOT-B.
The image will be displayed with the settings stored in the selected SHOT. The focus, zoom, iris, gain, shutter speed and white balance are automatically adjusted to the stored settings.

Notes

- On the shot transition check screen, the settings do not shift to the stored settings of the transition time and curve set in [TRANS TIME] and [TRANS CURVE] (p. 75)

4 Execute the shot transition.

- ① Press the ASSIGN 4 button repeatedly to bring up the SHOT TRANSITION EXEC screen.
- ② Press the REC START/STOP button.
- ③ Press the ASSIGN 5 button for recording with SHOT-A, or the ASSIGN 6 button for recording with SHOT-B.
The settings shift from the current ones to the stored ones.

Tips

- Press the ASSIGN 4 button repeatedly to cancel the shot transition.

Notes

- When you change [SHOT TRANSITION] (p. 48), press the ASSIGN 4 button repeatedly to exit the shot transition screen.
- You cannot return from the stored SHOT-A or SHOT-B settings to previous settings after you execute the shot transition during recording.
- If you press the following buttons during the shot transition operation, the operation will be canceled:
 - PICTURE PROFILE button
 - MENU button
 - ASSIGN button to which [EXP.FOCUS] is assigned
 - STATUS CHECK button
 - ASSIGN button to which [SMTH SLW REC] is assigned
- You can also make a transition from the SHOT-A to the SHOT-B or from the SHOT-B to the SHOT-A. For example, to make a transition from the SHOT-A to the SHOT-B, display the shot transition check screen, press the ASSIGN 5 button to bring up the SHOT-A and press the REC START/STOP button. Then, display the shot transition execution screen and press the ASSIGN 6 button.
- You can rehearse the shot transition by pressing the respective buttons (ASSIGN 5 or ASSIGN 6) to which your customized settings are assigned before pressing the REC START/STOP button in step 4.

To cancel the operation

Press the ASSIGN 4 button repeatedly to exit the shot transition screen.

Playback

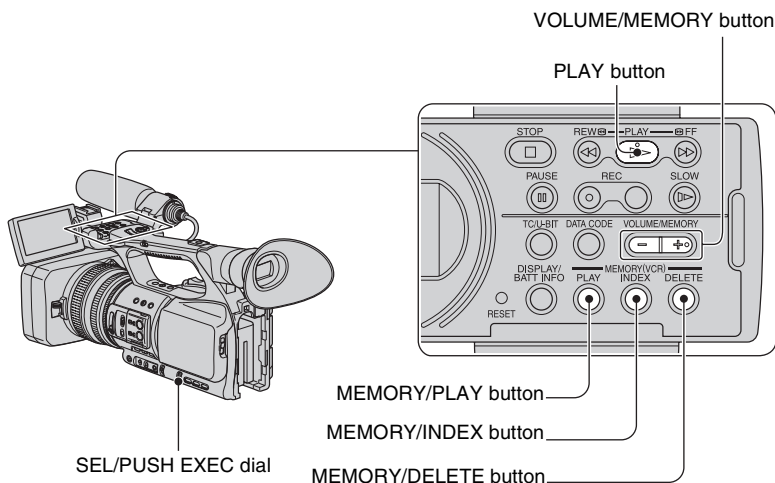

You can play back movies as follows:

1 Slide the POWER switch to VCR while pressing the green button.

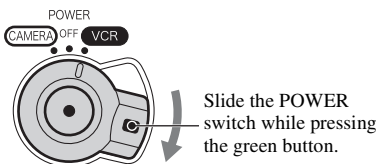

2 Start playing back.

Press ◀◀ (rewind) to go to the point you want to view, then press ▶▶ (play) to start playback.

- ■ : STOP
- || : PAUSE (Press ▶▶ or || again to restart the playback)
- ◀◀ : REW ◀◀ (Rewind, review)
- ▶▶ : ▶▶ FF (Cue, fast forward)
- ▶▶ : SLOW

🔊 Notes

- Your camcorder automatically goes into a stopped state when it is in pause for more than 3 minutes.
- The screen may temporarily go blank losing images and sound when signals switch between HDV and DVCAM (DV) during playback of a tape in which HDV format and DVCAM (DV) format are mixed.

Playback (Continued)

- You cannot play back movies recorded in HDV format on DVCAM (DV) format video cameras or mini DV players.
- You can play back a DV format tape on your camcorder only when its contents are recorded in the SP mode. You cannot play back movies recorded on the DV format tape in the LP mode.
- Time code and user bits will not be displayed correctly when you play back a tape with no time code or user bit data, or a tape with time code that your camcorder does not support.

Tips

- See page 142 for indicators displayed on the screen during playback.
- See page 55 for how to switch displays during playback.

To search for a scene while viewing a movie

Press and hold ◀◀/▶▶ during playback (Picture Search). To view during fast forward, press and hold ▶▶. To view during rewind, press and hold ◀◀ (Skip Scan).

To adjust the volume

Adjust the volume with the VOLUME/MEMORY button.

To view still images

- ① Set the POWER switch to VCR.
- ② Press the MEMORY/PLAY button.
- ③ Select still image that you want to view using the VOLUME/MEMORY button.
To stop viewing still images, press the MEMORY/PLAY button again.

To display the list of still images (index screen)

- ① Set the POWER switch to VCR.
- ② Press the MEMORY/INDEX button.

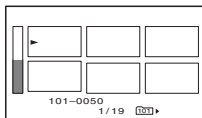

- ③ Select a still image using the VOLUME/MEMORY button.
To display a single image, move ▶ to that image and press the MEMORY/PLAY button.
To stop displaying the list of still images, press the MEMORY/INDEX button again.

To delete still images from the “Memory Stick Duo”

- ① Do the steps of “To view still images” to display still images that you want to delete.
- ② Press the MEMORY/DELETE button.
- ③ Select [YES] with the SEL/PUSH EXEC dial.
The still image will be deleted.

🔗 Notes

- Still images cannot be restored once you delete them.
- You cannot delete still images when the “Memory Stick Duo” is write-protected (p. 122) or the still image is protected (p. 107).

💡 Tips

- To delete a still image in the index, move ▶ to the still image using the VOLUME/MEMORY button, then do steps ② and ③.
- To delete all still images, do [☐ ALL ERASE] of the  (MEMORY SET) menu (p. 91).

Changing/checking the settings in your camcorder

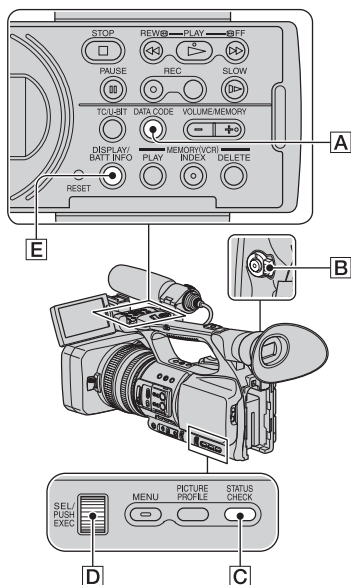

Changing the screen

You can turn on and off the display of the time code, tape counter, and other information on the screen.

Press the DISPLAY/BATT INFO button **E**.

The screen indicators turn on (displayed) and off (not displayed) as you press the button.

When the POWER switch is set to CAMERA, the screen changes (detailed display → simple display → no display) as you press the button.

💡 Tips

- You can display the screen indicators during playback on a TV. Select [V-OUT/PANEL] or [ALL OUTPUT] of [DISP OUTPUT] (p. 84).

Displaying recording data (Data code)

You can display information, including date, time and camera data, automatically stored during recording on the screen during playback.

1 Set the POWER switch **B** to VCR.

2 Press the DATA CODE button **A** during playback or pause.

The screen changes (date and time display → camera data display → no display) as you press the button.

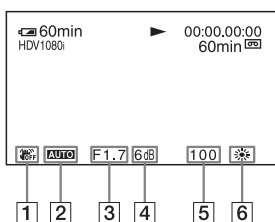

1 SteadyShot off

2 Exposure

AUTO appears during playback of the movie recorded with the iris, gain and shutter speed automatically adjusted.

MANUAL appears during playback of the movie recorded with the iris, gain and shutter speed manually adjusted.

3 Iris

CLOSE appears in the iris value display area during playback of the movie recorded with the iris manually adjusted to its maximum value.

4 Gain

5 Shutter speed

6 White balance

PWB appears during playback of the movie recorded with the shot transition or [MANU WB TEMP].

Notes

- The exposure correction value (0EV), shutter speed and iris will be displayed during viewing of still images on "Memory Stick Duo."
- Date and time will be displayed in the same area when you select the date and time display. If you record without setting date and time, [--- -- ----] and [--:--:--] will be displayed.
- An accurate shutter speed may not be displayed when you play back a tape recorded with your camcorder on another device. Check the data code that is displayed on the screen when you play back the tape on your camcorder for the accurate shutter speed.

Displaying the settings in your camcorder (Status check)

You can check the settings of the following items.

- Audio setup such as microphone volume level (p. 44, 77)
- Output signal setup ([VCR HDV/DV], etc.) (p. 85)
- Functions assigned to the ASSIGN buttons (p. 46)
- Camera setup (p. 69)
- Optional external recording unit HVR-MRC1 or HVR-DR60

1 Press the STATUS CHECK button **[C]**.

2 Turn the SEL/PUSH EXEC dial **[D]** until a desired display shows up on the screen.

When the POWER switch **[B]** is set to CAMERA, the display changes in the following sequence:

AUDIO → OUTPUT → ASSIGN → CAMERA → EXT DEVICE (when an external device is connected)

When the POWER switch **[B]** is set to VCR, the display changes in the following sequence:

AUDIO → OUTPUT → ASSIGN → EXT DEVICE (when an external device is connected)

To hide the display

Press the STATUS CHECK button **[C]**.

Checking the remaining battery (Battery Info)

Set the POWER switch **[B]** to OFF, then press the DISPLAY/BATT INFO button **[E]**. The approximate recordable time in the selected format and battery information appear for about 7 seconds. You can view the battery information for up to 20 seconds by pressing the button again while the information is displayed.

Remaining battery (approx.)

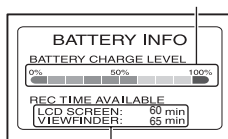

Recording capacity (approx.)

Locating a scene on a tape

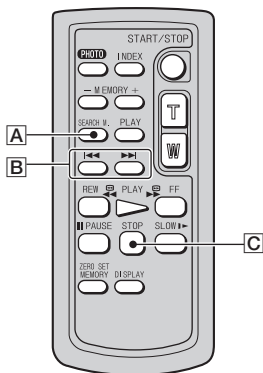

Notes

- See page 139 for details on how to use the Remote Commander.

Searching for a scene by date of recording (Date search)

You can search scenes by recording dates.

- 1** Set the POWER switch to VCR.
- 2** Press the SEARCH M. button **A** on the Remote Commander repeatedly to select [DATE SEARCH].
- 3** Press the **◀◀** (previous)/**▶▶** (next) button **B** on the Remote Commander to select a recording date.

You can select a date previous or next to the date of the current tape position. Playback automatically starts from the scene recorded on the selected date.

To cancel the operation

Press the STOP button **C** on the Remote Commander.

Notes

- Each day of recording must be longer than 2 minutes. Your camcorder may not detect the date if the recording of that date is short.
- The date search may not work properly if a blank section exists on the tape.

Searching for a recording start point (Index search)

You can search scenes by indexes recorded at the start of recording (p. 47).

- 1** Set the POWER switch to VCR.
- 2** Press the SEARCH M. button **A** on the Remote Commander repeatedly to select [INDEX SEARCH].
- 3** Press the **◀◀** (previous)/**▶▶** (next) button **B** on the Remote Commander to select an index point.

You can select an index previous or next to the index of the current tape position. Playback automatically starts from the scene marked by the index.

To cancel the operation

Press the STOP button  on the Remote Commander.

Notes

- Recording between indexes must be longer than 2 minutes. Your camcorder may not detect the date if the recording between the indexes is short.
- The index search may not work properly if a blank section exists on the tape.

Playing the picture on a TV

Connection methods and image quality differ depending on what type of TV is connected and connectors used.

Use the supplied AC Adaptor/Charger to obtain AC power (p. 13).

Refer also to the instruction manuals supplied with the device to be connected.

Jacks on your camcorder

Open the jack cover and connect the cable.

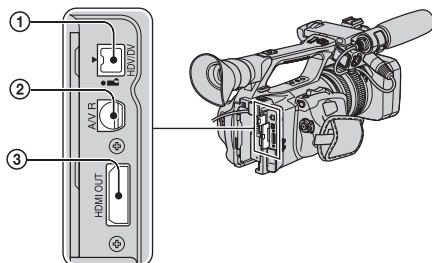

Notes

- Set all the necessary menu items before you connect your camcorder to a TV. If you change the settings of [VCR HDV/DV] or [i.LINK SET] after connecting your camcorder to the TV with an i.LINK cable, the TV may not recognize video signals properly.

Connecting to a high definition TV

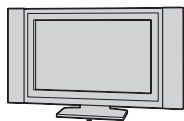

A movie recorded in HD quality is played back in HD quality.
A movie recorded in SD quality is played back in SD quality.

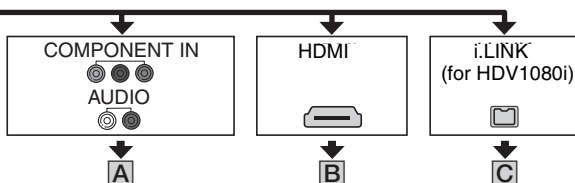

↗ : Signal flow, () : Reference pages

Type	Camcorder	Cable	TV	Menu Setting
------	-----------	-------	----	--------------

A

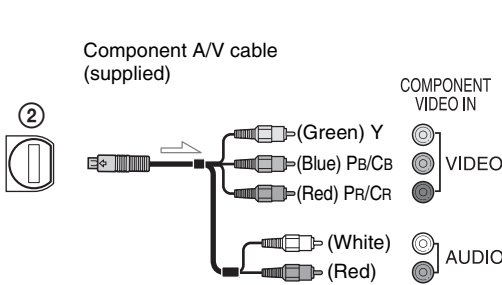

↔ (IN/OUT REC)
[VCR HDV/DV] →
[AUTO] (85)
[VIDEO OUT] →
[COMPONENT] →
[1080i/480i] (87)

Notes

- If you connect only component video plugs, audio signals are not output. Connect the white and red plugs to output audio signals.

B

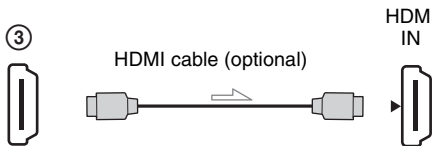

↔ (IN/OUT REC)
[VCR HDV/DV] →
[AUTO] (85)

Notes





- **Use an HDMI cable with the HDMI logo.**
- Pictures in the DVCAM (DV) format are not output from the HDMI OUT jack, if copyright protection signals are recorded in the pictures.
- DVCAM (DV) format pictures input to the camcorder via i.LINK cable (p. 100) cannot be output.
- Your TVs may not function correctly (for example, no sound or image). Do not connect the HDMI OUT jack of your camcorder and HDMI OUT jack of the external device with the HDMI cable. This may cause a malfunction.

Tips

- HDMI (High-Definition Multimedia Interface) is an interface to send both video and audio signals. Connecting HDMI OUT jack to an external device supplies high quality images and digital audio to you.

Playing the picture on a TV (Continued)

 : Signal flow, (): Reference pages

Type	Camcorder	Cable	TV	Menu Setting
				<p> (IN/OUT REC) [VCR HDV/DV] → [AUTO] (85) [i.LINK SET] → [HDV → DV CONV] → [OFF] (87)</p>

Notes

- Your TV needs to have an i.LINK jack compatible with HDV1080i. For details, confirm the specifications of your TV.
- If your TV is not compatible with HDV1080i, connect your camcorder and TV with the supplied component A/V cable and A/V connecting cable as illustrated in [A](#).
- The TV needs to be set so that it recognizes that the camcorder is connected. Refer to the instruction manuals supplied with your TV.
- This camcorder has a 4-pin i.LINK terminal. Select a cable that fits the terminal on the TV to be attached.

Connecting to a 16:9 (wide) or 4:3 TV

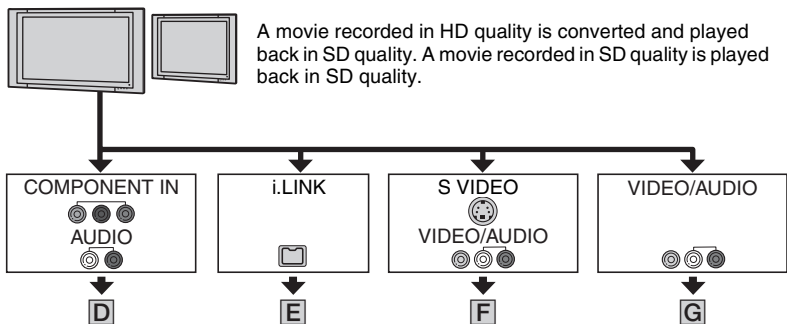

To set the aspect ratio according to the connected TV (16:9/4:3)

Set the down-convert setting as follows:

For HDV format signals:

⇄ (IN/OUT REC) menu → [VIDEO OUT] → [DOWN CONVERT]

For DV format signals:



⇄ (IN/OUT REC) menu → [VIDEO OUT] → [DV WIDE CONV]

💡 Tips

- When your TV is monaural (When your TV has only one audio input jack), connect the yellow plug of the A/V connecting cable to the video input jack and connect the white (left channel) or the red (right channel) plug to the audio input jack of your TV or VCR. When you want to play back the sound in monaural mode, use a connecting cable for that purpose.

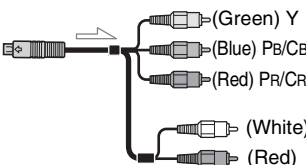

Playing the picture on a TV (Continued)

↔ : Signal flow, () : Reference pages

Type	Camcorder	Cable	TV	Menu Setting
D		Component A/V cable (supplied) 		↔ (IN/OUT REC) [VCR HDV/DV] → →[AUTO] (85) [VIDEO OUT] →[COMPONENT] →[1080i/480i] (87) [VIDEO OUT] →[DOWN CONVERT]/ [DV WIDE CONV] →[SQUEEZE]/ [LETTER BOX]/[EDGE CROP]* (87)

Notes

- If you connect only component video plugs, audio signals are not output. Connect the white and red plugs to output audio signals.

E		i.LINK cable (optional) 		↔ (IN/OUT REC) [VCR HDV/DV] → [AUTO] (85) [i.LINK SET] → [HDV → DV CONV] → [ON] (87)
---	---	--	---	---

Notes

- The TV needs to be set so that it recognizes that the camcorder is connected. Refer to the instruction manuals supplied with your TV.
- This camcorder has a 4-pin i.LINK terminal. Select a cable that fits the terminal on the TV to be attached.

* Change the settings according to the TV connected.

↔ : Signal flow, (): Reference pages

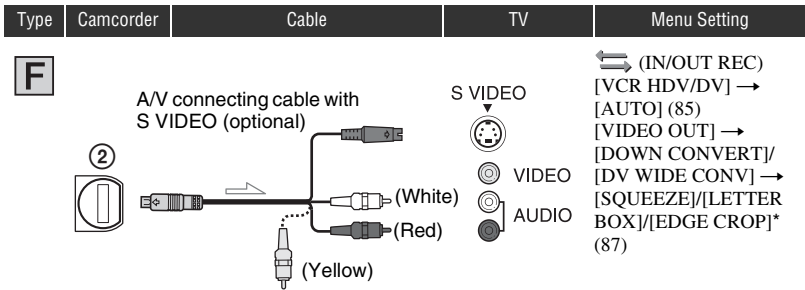

Notes

- When connecting only an S VIDEO plug (S VIDEO channel), audio signals are not output. To output audio signals, connect the white and red plugs of the A/V connecting cable with S VIDEO to the audio input jack of your TV.
- This connection produces higher resolution pictures compared with the A/V connecting cable (Type G).

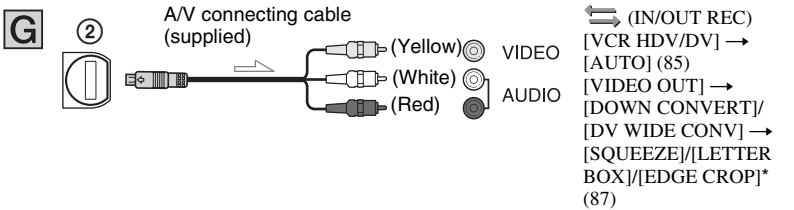

* Change the settings according to the TV connected.

Tips

- If you connect your camcorder to the TV using more than one type of cable to output images, the order of priority of the TV input jacks is as follows:
HDMI → component video → S VIDEO → video.
- See page 124 for the details of i.LINK.

When connecting to your TV via a VCR

Select the connecting method on page 96 depending on the input jack of the VCR. Connect your camcorder to the LINE IN input on the VCR using the A/V connecting cable. Set the input selector on the VCR to LINE (VIDEO 1, VIDEO 2, etc.).

Using the menu items

You can change various settings or make detailed adjustments using the menu items displayed on the screen.

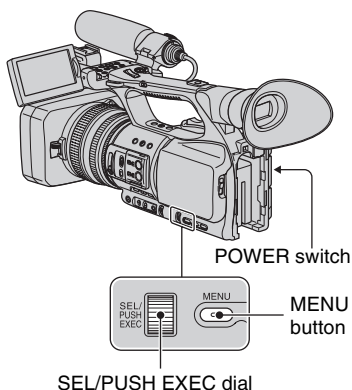

- 1 Set the POWER switch to CAMERA or VCR.

- 2 Press the MENU button.

The menu index screen appears.

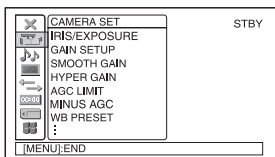

- 3 Turn the SEL/PUSH EXEC dial until the icon of the desired menu is highlighted, then press the dial to select the menu.

- CAMERA SET (p. 69)
- AUDIO SET (p. 77)
- DISPLAY SET (p. 80)
- IN/OUT REC (p. 85)
- TC/UB SET (p. 89)
- MEMORY SET (p. 91)
- OTHERS (p. 92)

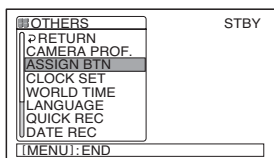

- 4 Turn the SEL/PUSH EXEC dial until the desired menu item is highlighted, then press the dial to select the item.

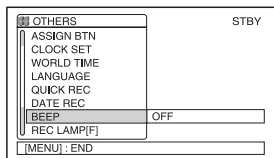

The available menu items vary depending on the position of the power switch of your camcorder. Unavailable items will be grayed out.

-
- 5** Turn the SEL/PUSH EXEC dial until the desired setting is highlighted or to bring up the desired setting, then press the dial to confirm the setting.

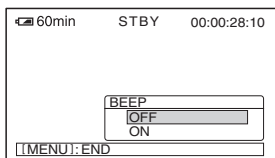

-
- 6** Press the MENU button to hide the menu screen.

To return to the previous screen, select [↩ RETURN].

Menu items

Available menu items (●) vary depending on the POWER switch position.

Position of POWER switch:

CAMERA

VCR



(CAMERA SET) menu (p. 69)

IRIS/EXPOSURE (AS)	●	—
GAIN SETUP	●	—
SMOOTH GAIN	●	—
HYPER GAIN (AS)	●	—
AGC LIMIT	●	—
MINUS AGC	●	—
WB PRESET	●	—
WB OUTDR LVL	●	—
WB TEMP SET	●	—
ATW SENS	●	—
SMOOTH WB	●	—
AE SHIFT (AS)	●	—
AE RESPONSE	●	—
AT IRIS LMT	●	—
ECS FREQ.	●	—
FLCKR REDUCE	●	—
CNTRST ENHCR	●	—
BACK LIGHT (AS)	●	—
SPOTLIGHT (AS)	●	—
STEADYSHOT (AS)	●	—
AF ASSIST	●	—
FOCUS MACRO (AS)	●	—
HANDLE ZOOM	●	—
SPEED ZOOM	●	—
D.EXTENDER (AS)	●	—
FADER (AS)	●	—
SMTH SLW REC (AS)	●	—
INTERVAL REC	●	—
DV FRAME REC (DVCAM DV 2)	●	—
SHOT TRANSITION (AS)	●	—
x.v.Color (HDV100)	●	—
COLOR BAR (AS)	●	—



(AUDIO SET) menu (p. 77)

DV AU.MODE (DVCAM DV 2)	●	—
AUDIO LIMIT	●	—
INT MIC SET	●	—
XLR SET	●	—
AUDIO CH SEL	—	●
DV AUDIO MIX (DVCAM DV 2)	—	●

Position of POWER switch:

CAMERA

VCR

**(DISPLAY SET) menu (p. 80)**

	CAMERA	VCR
ZEBRA (AS)	●	-
HISTOGRAM	●	-
PEAKING (AS)	●	-
MARKER (AS)	●	-
EXP.FOCUS TYPE	●	-
CAM DATA DSP	●	-
AU.LVL DISP	●	-
ZOOM DISPLAY	●	-
FOCUS DISP	●	-
SHUTTER DISP	●	-
LCD BRIGHT	●	●
LCD COLOR	●	●
LCD BL LEVEL	●	●
VF B.LIGHT	●	●
VF COLOR	●	●
VF POWERMODE	●	●
LETTER SIZE	●	●
REMAINING	●	●
DISP OUTPUT	●	●

**(IN/OUT REC) menu (p. 85)**

REC FORMAT	●	-
VCR HDV/DV	-	●
HDV PROGRE.	●	-
DV PROGRE.	●	-
DV REC MODE	●	●
DV WIDE REC	●	-
VIDEO OUT	●	●
i.LINK SET	●	●
EXT REC CTRL	●	-

Menu items (Continued)

Position of POWER switch:

CAMERA

VCR

00:00

(TC/UB SET) menu (p. 89)

TC PRESET	●	●
TC COUNTUP (AS)	●	●
UB PRESET	●	●
TC FORMAT	●	●
TC RUN	●	●
TC MAKE	●	●
TC LINK	●	—
UB TIME REC	●	●
UB-DATE/TC-TIME	●	●

◀

(MEMORY SET) menu (p. 91)

<input type="checkbox"/> ALL ERASE	—	●
<input type="checkbox"/> FORMAT	●	●
FILE NO.	●	●
NEW FOLDER	●	●
REC FOLDER	●	●
PB FOLDER	—	●

⏏

(OTHERS) menu (p. 92)

CAMERA PROF.	●	●
ASSIGN BTN	●	●
CLOCK SET	●	●
WORLD TIME	●	●
LANGUAGE	●	●
PB ZOOM	—	●
QUICK REC (D/100)	●	—
DATE REC	●	—
BEEP	●	●
REC LAMP[F]	●	—
REC LAMP[R]	●	—
REMOTE CTRL	●	●
HOURS METER	●	●

(CAMERA SET) menu

Settings to adjust your camcorder to the recording conditions (GAIN SETUP/BACK LIGHT/STEADYSHOT, etc.)

The default settings are marked with ►.
The indicators in parentheses appear when the items are selected.

See page 64 for details on selecting menu items.

Press the MENU button → select the  (CAMERA SET) with the SEL/PUSH EXEC dial.

IRIS/EXPOSURE (AS)

■ RING ASSIGN

You can select either [IRIS] (default setting) or [EXPOSURE] as the function assigned to the iris ring (p. 30).

■ RING ROTATE

You can select the rotation direction of the iris ring.

► NORMAL

Makes images dark with clockwise rotation of the iris ring.

OPPOSITE

Makes images dark with counter-clockwise rotation of the iris ring.

🔍 Notes

- You cannot assign [RING ASSIGN] to an ASSIGN button.
- When the AUTO/MANUAL switch is set to AUTO, the IRIS/EXPOSURE button is not available.

💡 Tips

- The iris, gain and shutter speed values are adjusted as follows when you change the [RING ASSIGN] setting with the AUTO/MANUAL switch set to MANUAL.
 - When you change [RING ASSIGN] from [IRIS] to [EXPOSURE]
The adjustment remains in the same mode that it was in prior to changing [RING ASSIGN]. If it is in automatic adjustment, it

remains in automatic adjustment after changing [IRIS] to [EXPOSURE]. If it is in manual adjustment, it remains in manual adjustment after changing [IRIS] to [EXPOSURE].

You can adjust the iris, gain and shutter speed with the iris ring when  is displayed next to the values on the screen.

Adjustment for the gain and shutter speed can be switched between [EXPOSURE] and manual.

- When you change [RING ASSIGN] from [EXPOSURE] to [IRIS]

The adjustment remains in the same mode that it was in prior to changing [RING ASSIGN]. If it is in automatic adjustment, it remains in automatic adjustment after changing [EXPOSURE] to [IRIS]. If it is in manual adjustment, it remains in manual adjustment after changing [EXPOSURE] to [IRIS].

Adjustments for the gain and shutter speed can be switched between automatic and manual.

- You can assign [RING ROTATE] to one of the ASSIGN buttons (p. 46).

GAIN SETUP

You can set gain values for H, M and L positions of the gain switch. The default settings of [H], [M] and [L] are 18dB, 9dB and 0dB, respectively.

- ① Select [H], [M] or [L] with the SEL/PUSH EXEC dial.
- ② Set the gain value with the SEL/PUSH EXEC dial, and press the dial.
You can select the value between -6dB and 21dB by 3dB. The larger the value, the higher the gain.
- ③ Select [OK] with the SEL/PUSH EXEC dial.
- ④ Press the MENU button to hide the menu screen.

Press the MENU button → select the  (CAMERA SET) with the SEL/PUSH EXEC dial.

SMOOTH GAIN

You can set the transition speed at which the gain setting shifts from one value to another, set for the gain switch positions, when you switch the gain switch from a position to another. You can select the transition speed from [FAST], [MIDDLE] and [SLOW] or set to [OFF]. The default setting is [OFF].

HYPER GAIN

When you set this function to [ON] () , you can increase the gain to its limit. The default setting is [OFF].

Notes

- During the hyper gain, the picture quality will be reduced due to noise.
- [HYPER GAIN] is automatically set to [OFF] if you turn the power off and back on.
- When you record a movie with [HYPER GAIN] set to [ON] or the gain set to [-6dB] and play it back with the data code, the gain value is displayed as [--].

Tips

- You are recommended to use this function with manual focus.

AGC LIMIT

You can select the upper limit for the Auto Gain Control (AGC) from [OFF] (21dB, the default setting), [18dB], [15dB], [12dB], [9dB], [6dB], [3dB] and [0dB].

Notes

If you adjust the gain manually, you cannot obtain the effect of [AGC LIMIT].

MINUS AGC

When you set this function to [ON], the automatic gain control range can be expanded to the negative range. Especially in a bright environment, minus gain control allows more suitable gain setting and

enables low noise recording. The dynamic range of your camcorder is not reduced when you set [MINUS AGC] to [ON].

▶ ON

Enables minus gain control during automatic gain control, as required.

OFF

Disables minus gain control during automatic gain control.

WB PRESET

You can use the preset white balance. For more details, see page 33.

WB OUTDR LVL

You can set an offset value to adjust the outdoor white balance when you set [WB PRESET] to [OUTDOOR]. You can select the offset value from [-7] (bluish) - [0] (normal) - [+7] (reddish). The default setting is [0] .

WB TEMP SET

You can set the color temperature between 2300K and 15000K in 100K steps when you set [WB PRESET] to [MANU WB TEMP].

ATW SENS

You can set the auto white balance operation under a reddish light source such as an incandescent lamp or candle, or under a bluish light source such as in outdoor shade.

▶ INTELLIGENT

Automatically adjusts the white balance so that scenes look natural for the light source.

HIGH

Automatically adjusts the white balance while reducing redness or blueness.

MIDDLE

LOW

Automatically adjusts the white balance while increasing redness or blueness.

🔌 Notes

- This is only effective when white balance is adjusted automatically.
- [ATW SENS] is not effective under a clear sky or the sun.

SMOOTH WB

You can set the transition speed at which the color temperature values shifts from one value to another, set for the white balance memory switch positions, when you switch the white balance memory switch from a position to another. You can select the transition speed from [FAST], [MIDDLE] and [SLOW] or set to [OFF]. The default setting is [OFF].

AE SHIFT **AS**

You can set an offset value to adjust the automatic exposure adjustment value between [-7] (dark) and [+7] (bright) with the SEL/PUSH EXEC dial. The default setting is [0]. **AS** and selected value appears on the screen when you change the value from the default setting.

🔌 Notes

- This function is not effective while you adjust the iris, shutter speed and gain all manually.
- [AE SHIFT] is canceled when [EXPOSURE] is manually adjusted.
- This function is not effective when [HYPER GAIN] is set to [ON].

AE RESPONSE

You can select the speed at which the automatic exposure adjustment function follows changes in the brightness of the subject. You can select the speed from [FAST], [MIDDLE] and [SLOW]. The default setting is [FAST].

AT IRIS LMT

You can select the highest iris value for the automatic adjustment from [F11], [F9.6], [F8], [F6.8], [F5.6], [F4.8] and [F4]. The default setting is [F11].

🔌 Notes

- This function is not effective during the manual iris adjustment.

ECS FREQ.

You can set the shutter speed so that horizontal strips do not appear on a monitor screen, which is likely to occur when you record a monitor screen. Change the setting with the SEL/PUSH EXEC dial, then press the dial to confirm the setting. The default setting is [59.94Hz].

You must set the shutter speed to the ECS (**ECS**) prior to setting this function (p. 32). You can set the shutter speed in the following frequency ranges depending on the setting of [SCAN TYPE]. How to select [SCAN TYPE] depends on the setting of [REC FORMAT] of  (IN/OUT REC) menu.

[HDV 1080i]: [HDV PROGRE.] → [REC TYPE] → [SCAN TYPE]

[DV]: [DV PROGRE.] → [SCAN TYPE]

SCAN TYPE	Frequency range
60	59.94 Hz to 199.8 Hz
30	29.97 Hz to 199.8 Hz
24, 24A*	23.98 Hz to 199.8 Hz

* Adjustable when [HDV PROGRE.] → [REC TYPE] → [INTERLACE].

Press the MENU button → select the  (CAMERA SET) with the SEL/PUSH EXEC dial.

Notes

- When you record a movie with the shutter speed set in [ECS FREQ.] and play it back with the data code, the shutter speed value is displayed as [---].

FLCKR REDUCE

ON

Reduces flickering. Flickering of the screen under a light source such as fluorescent lamps will be reduced.

OFF

Not reduce flickering.

Notes

- Flickering may not be reduced for certain light sources.

CNTRST ENHCR

When you set this function to [ON], your camcorder detects high contrast images, such as backlit scenes, and automatically improves the unexposed images. The default setting is [OFF].

Notes

- When you set [BACK LIGHT] to [ON], [CNTRST ENHCR] is temporarily disabled.

BACK LIGHT (AS)

When you set this function to [ON] () , you can correct backlighting. The default setting is [OFF].

Notes

- [BACK LIGHT] is set to [OFF] when you set [SPOTLIGHT] to [ON].
- [BACK LIGHT] is set to [OFF] when [EXPOSURE] is manually adjusted.
- [BACK LIGHT] is set to [OFF] if at least two of iris, gain, and shutter speed are adjusted manually.
- [BACK LIGHT] is set to [OFF] when [HYPER GAIN] is set to [ON].

SPOTLIGHT (AS)

When you set this function to [ON] () , you can prevent overexposure of light during recording of a subject under strong light, such as a stage. For example, you can prevent people's faces from over-highlighting. The default setting is [OFF].

Notes

- [SPOTLIGHT] is set to [OFF] when you set [BACK LIGHT] to [ON].
- [SPOTLIGHT] is set to [OFF] when [EXPOSURE] is manually adjusted.
- You cannot use the spotlight function if at least two of iris, gain, and shutter speed are adjusted manually.
- [SPOTLIGHT] is set to [OFF] when [HYPER GAIN] is set to [ON].

STEADYSHOT (AS)

ON/OFF

When you select [ON], you can reduce camera shakes. Select [OFF] () when you use a tripod (optional) to make images look natural. The default setting is [ON].

TYPE

You can select a type of camera-shake reduction for different recording situations.

HARD

Reduces camera shakes at a high level. This setting is not suitable for panorama tilt recordings.

STANDARD

Reduces camera shakes at a standard level.

SOFT

Reduces camera shakes at a low level. Slight unsteadiness remains in movies, which make the movies look as they are.

WIDE CONV.

This item is provided for a wide conversion lens (optional), and especially effective for Sony VCL-HG0872A wide conversion lens.

AF ASSIST

When you set this function to [ON], you can temporarily focus manually using the focus ring during the auto focus adjustment. The default setting is [OFF].

Notes

- This function is effective only when the FOCUS switch is set to AUTO (p. 29).

FOCUS MACRO AS

When you set this function to [ON], you can focus on a subject within 80 cm (about 2 5/8 feet). The default setting is [ON]. When you set this function to [OFF] (OFF), you can set fine focus on a subject further than 80 cm regardless of the zoom position although you will lose focus on a subject within 80 cm.

HANDLE ZOOM

You can select the zoom speed for the FIX position of the handle zoom switch from [1] (slow) through [8] (fast). The default setting is [3].

SPEED ZOOM

When you set this function to [ON], you can increase the zoom speed of the zoom lever and the handle zoom. The default setting is [OFF].

Notes

- When you set this function to [ON], the operation sound of the zoom may also be recorded.

D.EXTENDER AS

When you set this function to [ON] (ON), the displayed image becomes 1.5 times larger. The image quality decreases because the image is digitally processed. This function helps you to focus on far-away

subjects such as a wild bird away at a distance. The default setting is [OFF].

Notes

- This function is automatically set to [OFF] when you turn the power off and back on.

FADER AS

You can add visual effects to transition between scenes.

- ① Select [WHITE FADER] or [BLACK FADER] during standby to fade in with the selected effect or recording to fade out with the selected effect.
- ② Press the REC START/STOP button.
The fader indicator stops flashing and disappears when the fading is complete.

To cancel before starting the operation, select [OFF] in step ①.

The setting will be cleared every time you press the REC START/STOP button.



WHITE FADER



BLACK FADER



Notes

- This function is automatically set to [OFF] when you turn the power off and back on.

SMTH SLW REC AS

Fast moving subjects and actions, which cannot be captured under the general recording conditions, can be recorded in smooth moving slow-motion. This is useful for recording fast actions such as a golf or tennis swing.

Press the MENU button → select the (CAMERA SET) with the SEL/PUSH EXEC dial.

Select [EXECUTE], and press the REC START/STOP button on the [SMTH SLW REC] screen.

A recording of the length set in [REC TIME] is stretched by 4 times and recorded as a slow-motion movie.

Recording ends when [Recording...] disappears from the screen.

To cancel [SMTH SLW REC], press the MENU button.

You can select the [SMTH SLW REC] settings suitable for your recording.

■ REC TIMING

You can use this to select when recording starts in relation to when the REC START/STOP button is pressed.

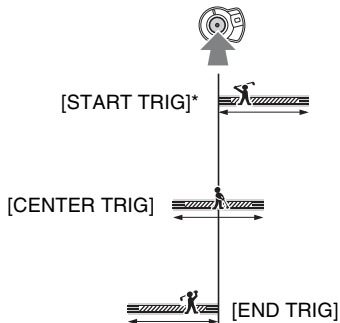

* The default setting is [START TRIG].

■ REC TIME

You can select the recording time from [3sec], [6sec] and [12sec]. The default setting is [3sec].

The picture quality deteriorates as the recording time increases.

■ TRIG

When you set this function to [ON], recording automatically starts in response to a preset sound level instead of the REC START/STOP button being pressed. The [TRIG] setting is canceled when you turn the power off and back on.

■ TRIG LEVEL

You can select the sound level at which recording is triggered from [HIGH], [MIDDLE] and [LOW] in [TRIG LEVEL]. The default setting is [HIGH].

⚡ Notes

- Sounds cannot be recorded.
- The shutter speed is automatically set to 1/250 second when you start [SMTH SLW REC].
- The recording time may be shorter than the set time, depending on recording conditions.
- The image quality is lower than with the regular recording.

💡 Tips

- After executing [SMTH SLW REC] with an ASSIGN button, you can also cancel [SMTH SLW REC] by pressing the ASSIGN button again. See page 46 for details on how to use the ASSIGN buttons.
- When [TRIG] is set to [ON], you can also start recording by pressing the REC START/STOP button.
- When you manually set the microphone volume to a low level, [TRIG] may not work properly. We recommend that you set [TRIG LEVEL] to [MIDDLE] or [LOW].

INTERVAL REC

You can record a series of movies on a tape at regular intervals. This function is useful to observe things like cloud movements or daylight changes. The scenes run smoothly into each other when you play back the tape. Use the AC Adapter/Charger to obtain AC power for long recording.

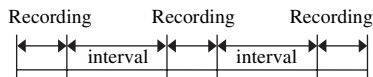

- ① Select [ON/OFF] → [ON] with the SEL/PUSH EXEC dial.
- ② Perform the following step if you are changing the recording time from the default setting of [0.5sec]. If you are keeping the default recording time, go straight to step ③.

Select [REC TIME] → [0.5sec], [1sec], [1.5sec] or [2sec] with the SEL/PUSH EXEC dial.

- ③ Perform the following step if you are changing the interval time from the default setting of [30sec]. If you are keeping the default interval time, go straight to step ④.
Select [INTERVAL] → [30sec], [1min], [5min] or [10min].
- ④ Select [OK] with the SEL/PUSH EXEC dial.
- ⑤ Press the MENU button to hide the menu screen.
- ⑥ Press the REC START/STOP button.
The [INTERVAL REC] recording starts.

To cancel [INTERVAL REC], press the REC START/STOP button.

The operation of your camcorder differs depending on when you press the REC START/STOP button.

If you press the button during [INTERVAL REC] recording, the recording temporarily stops. If you press it again, the [INTERVAL REC] recording restarts. If you press the button during [INTERVAL REC] interval, the [INTERVAL REC] recording stops and regular recording starts. If you press it again, regular recording stops. If you press the button once again, the [INTERVAL REC] recording restarts. To cancel the [INTERVAL REC] recording, select [ON/OFF] → [OFF] with the SEL/PUSH EXEC dial.

⚡ Notes

- The recording time and interval time may differ slightly from the settings.
- If you focus manually, you can get sharp images even if the lighting changes.

DV FRAME REC

You can record stop motion (or frame-by-frame) animation movies. That type of animation uses a technique of changing the subject, such as a doll or a toy's positions and recording it at each different position while your camcorder sits still. Use the Remote Commander to reduce camera shakes.

▶ OFF

Not use this function.

ON

Records a movie by stop motion (or frame-by-frame) technique.

- ① Select [ON] with the SEL/PUSH EXEC dial.
- ② Press the MENU button to hide the menu screen.
- ③ Press the REC START/STOP button.
Your camcorder records a movie for about 6 frames and returns to standby.
- ④ Move the subject and repeat step ③.

⚡ Notes

- When you use frame recording continuously, the remaining tape time will not be indicated correctly.
- The last scene will be longer than other scenes.
- You cannot record index signals during frame recording.
- This function is automatically set to [OFF] when you turn the power off and back on.

SHOT TRANSITION

You can set [TRANS TIME], [TRANS CURVE], [START TIMER] and [REC LINK].

See page 48 for details on the shot transition function.

■ TRANS TIME

You can set the transition time between [3.5sec] and [90.0sec]. The default setting is [4.0sec].

Press the MENU button → select the  (CAMERA SET) with the SEL/PUSH EXEC dial.

■ TRANS CURVE

You can select the transition curve. Characteristics of the transition curves are illustrated in the following graphs.

*1: parameter level

*2: time

LINEAR

Makes the transition linearly.

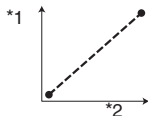

▶ SOFT STOP

Makes the transition slowly at the end.

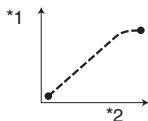

SOFT TRANS

Makes the transition slowly at the beginning and end, and linearly in between.

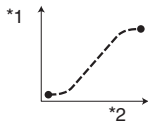

ⓘ Notes

- You cannot change [TRANS TIME] and [TRANS CURVE] settings during store, check, or execution of [SHOT TRANSITION]. Cancel [SHOT TRANSITION] setting by pressing the ASSIGN 4 button several times before changing [TRANS TIME] or [TRANS CURVE] setting.

■ START TIMER

You can set the timer for starting the shot transition. You can select the time from [5sec], [10sec] and [20sec]. The default setting is [OFF].

■ REC LINK

▶ OFF

Not use this function

SHOT-A

Starts transition to SHOT-A when recording is started.

SHOT-B

Starts transition to SHOT-B when recording is started.

x.v.Color

When you set this function to [ON], you can record with the wider color range. Your camcorder can reproduce brilliant and vivid colors for flowers and the beautiful blue-green of tropical oceans that cannot be matched by conventional technologies. The default setting is [OFF].

ⓘ Notes

- The colors may not be well reproduced when you play back a movie recorded with this function set to [ON] on a TV that does not support x.v.Color.
- You cannot set [x.v.Color] in the following cases:
 - When recording in SD (standard) format
 - When recording movies
- When you set [x.v.Color] to [ON], the picture profile will be disabled.

COLOR BAR

■ ON/OFF

When you select [ON], you can display color bars on the screen or record them on a tape. This function helps you to adjust colors when you view movies recorded with your camcorder on a TV or a monitor. The default setting is [OFF].

ⓘ Notes

- This function is automatically set to [OFF] when you turn the power off and back on.

(AUDIO SET) menu

Settings for the audio recording (DV AU.MODE/XLR SET, etc.)

■ TYPE

Selects a type of the color bars.

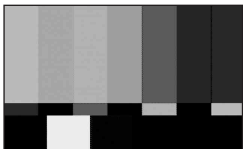

TYPE 1

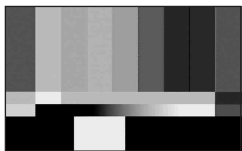

TYPE 2



TYPE 3



TYPE 4 (75% brightness of TYPE 3)

■ TONE

Outputs audio tone signals (1 kHz: full bit -20 dB) when you set [TONE] to [ON]. The default setting is [OFF].

The default settings are marked with ►. The indicators in parentheses appear when the items are selected.

See page 64 for details on selecting menu items.

Press the MENU button → select the  (AUDIO SET) with the SEL/PUSH EXEC dial.

DV AU.MODE
(DV Audio mode) **DVCAM** **DV**

► FS32K (32k)

Records in the 12-bit mode (2 stereo sounds). Select this setting for the DVCAM/DV SP recording.

► FS48K (48k)

Records in the 16-bit mode (1 stereo sound with high quality). Select this setting for the DVCAM/DV SP recording.

⚙ Notes

- When recording in the HDV format, sound is automatically recorded in the [FS48K] mode.
- **NS** appears when the DVCAM standard is not met (p. 120).

AUDIO LIMIT

You can set the clipping-noise reduction function for CH1/CH2.

► OFF

Disables the function.

ON

Enables the function.

⚙ Notes

- This function is available only when you set the AUTO/MAN switch to MAN.

INT MIC SET

■ INT MIC NR

You can reduce noise from the internal microphone.

▶ ON

Reduces noise from the internal microphone.

NR appears on the status check screen.

OFF

Does not reduce noise from the internal microphone.

■ INT MIC SENS

You can set recording sensitivity of the internal microphone.

▶ NORMAL

Sensitivity that is normally used in professional recordings.

HIGH

Sensitivity that is normally used in consumer recordings.

SNS-HI appears on the status check screen.

■ INT MIC WIND

▶ OFF

Disables wind noise reduction.

ON

Enables wind noise reduction.

 appears on the status check screen.

XLR SET

■ XLR AGC LINK

You can select either linked or separate AGC (Auto Gain Control) of CH1 and CH2 when using an external microphone.

▶ SEPARATE

Separately applies the AGC for CH1/CH2. Sound inputs from CH1/CH2 will be recorded as separate sound.

LINKED

Applies the AGC of CH1 linked with that of CH2. Sound inputs from CH1/CH2 will be recorded as a set of sound such as stereo sound. **A** appears on the status check screen.

⚙ Notes

- This function is available when the CH1 and CH2 switches are set to AUTO and the INPUT1 and INPUT2 switches are both set to MIC or both set to LINE (p. 44).

■ AU.MAN GAIN

You can select either linked or separate audio level control of CH1 and CH2 when using an external microphone.

▶ SEPARATE

Separately controls the audio levels of CH1 and CH2. Sound inputs from CH1 and CH2 will be recorded as separate sound.

LINKED ()

Controls the audio level of CH1 linked with that of CH2. Sound inputs from CH1 and CH2 will be recorded as a set of sound such as stereo sound. **M** appears on the status check screen.

⚙ Notes

- This function is available when the CH1 and CH2 switches are set to MAN and the INPUT1 and INPUT2 switches are both set to MIC or both set to LINE (p. 44).
- When you select [LINKED], you can adjust the volume with the AUDIO LEVEL dial of CH1 (p. 44).

■ INPUT1 MIC NR

You can reduce noise from the microphone.

▶ ON

Reduces noise from the microphone.

NR appears on the status check screen.

OFF

Does not reduce noise from the microphone.

🔊 Notes

- The setting is not effective when you set the INPUT1 switch to LINE.

■ INPUT1 TRIM

You can adjust the input signal level from INPUT1.

You can select from [-18dB], [-12dB], [-6dB], [0dB], [+6dB] and [+12dB]. The default setting is [0dB].

🔊 Notes

- The setting is not effective when you set the INPUT1 switch to LINE.

■ INPUT1 WIND

▶ OFF

Disables wind noise reduction.

ON

Enables wind noise reduction.

 appears on the status check screen.

🔊 Notes

- The setting is not effective when you set the INPUT1 switch to LINE.

■ INPUT2 MIC NR

■ INPUT2 TRIM

■ INPUT2 WIND

You can set INPUT2 in the same way as INPUT1.

💡 Tips

- -48dBu is set as 0dB in your camcorder.
- Set [INPUT TRIM] to [0dB] for the supplied microphone (ECM-XM1).
- Set [INPUT TRIM] to [+12dB] for a microphone with an average sensitivity, including the optional microphone (Sony ECM-NV1).
- The INPUT TRIM function adjusts the input level from an external microphone. When using a highly sensitive microphone or recording loud sound, set this to the minus side. When using a less sensitive microphone or recording quiet sound, set it to the plus side.
- When recording loud sound, the sound may be distorted at either the input point or the

recording point. If it is distorted at the input point, adjust the sound using the INPUT TRIM function. If it is distorted at the recording point, lower the total volume level manually.

- If you set INPUT TRIM too far to the minus side, the microphone volume becomes too low, resulting in a poor signal to noise ratio.
- Test the effect of the INPUT TRIM function according to the microphone used or the sound field of the recording site before actual recording.

AUDIO CH SEL

▶ CH1,CH2

Reproduces sound of CH1 and CH2 in respective channels.

CH1

Reproduces sound of CH1 in channels 1 and 2.

CH2

Reproduces sound of CH2 in channels 1 and 2.

CH1+CH2

Reproduces mixed sound of CH1 and CH2 in channels 1 and 2.

💡 Tips

- When you select [CH1,CH2] and play back a tape on your camcorder, sound of CH1 + CH2 comes out of the speakers.
- When you select [CH1+CH2], the same sound is outputted from right and left speakers of a device to be connected.

DV AUDIO MIX DVCAM DV

You can monitor the sound dubbed from another device or recorded through 4-channel microphone during playback. You can set how to output the sound.

▶ CH1,CH2

Outputs only the sound recorded in CH1 and CH2 during recording.

MIX

Outputs mixed sound of the sound recorded in CH1 and CH2 during

Press the MENU button → select the  (AUDIO SET) with the SEL/PUSH EXEC dial.

recording and the sound dubbed in CH3 and CH4.

CH3, CH4

Outputs only the sound dubbed in CH3 and CH4.

(DISPLAY SET) menu

Display settings of the display and the viewfinder (MARKER/VF B.LIGHT/DISP OUTPUT, etc.)

The default settings are marked with ►. The indicators in parentheses appear when the items are selected.

See page 64 for details on selecting menu items.

Press the MENU button → select the  (DISPLAY SET) with the SEL/PUSH EXEC dial.

ZEBRA

You can display a zebra pattern as a guide for adjusting brightness.

■ ON/OFF

When you select [ON],  and the brightness level appear on the screen. The zebra pattern will not be recorded on a tape or a “Memory Stick Duo.” The default setting is [OFF].

■ LEVEL

You can select the brightness level between 70 and 100 or 100+. The default setting is [70].

Tips

- The zebra pattern is a strip pattern displayed over a part of an image on the screen when the part is higher than a preset brightness level.

HISTOGRAM

You can adjust the iris while referring to a histogram. A histogram is a graph that shows the distribution of the image brightness. You can use the histogram as a guide for adjusting the iris. The histogram will not be recorded on a tape or a “Memory Stick Duo.”

► OFF

Does not display a histogram.

NORMAL

Displays a histogram.

ADVANCE

Displays a histogram, and a bar that indicates an average of the brightness levels around the center of an image (within the marker) on the histogram.

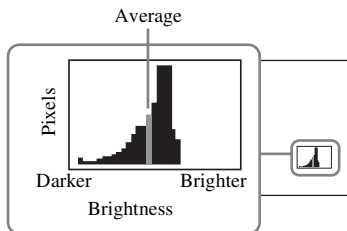

💡 Tips

- The left area on the graph shows the darker areas of the image while the right area shows the brighter areas.
- A vertical line that indicates the brightness level of [ZEBRA] will be displayed on the histogram when you set [ZEBRA] to [ON].

PEAKING AS

■ ON/OFF

When you select [ON], you can display an image on the screen with its details enhanced. This function helps you to adjust the focus. The default setting is [OFF].

■ COLOR

You can select peaking color from [WHITE], [RED] and [YELLOW]. The default setting is [WHITE].

■ LEVEL

You can select a peaking sensitivity from [HIGH], [MIDDLE] and [LOW]. The default setting is [MIDDLE].

📌 Notes

- You cannot record an image with enhanced details on a tape or a "Memory Stick Duo."

💡 Tips

- You can focus more easily using this function in combination with the expanded focus function (p. 30).

MARKER AS

■ ON/OFF

When you select [ON], you can display markers. The default setting is [OFF]. Markers will not be recorded on a tape or "Memory Stick Duo."

■ CENTER

When you select [ON], you can display a marker at the center of the screen. The default setting is [ON].



■ ASPECT

When you select [ON], you can display markers at boundaries of display area defined by the aspect ratio, which you can select from [4:3], [13:9] and [14:9]. The default setting is [OFF].



■ SAFETY ZONE

When you select [ON], then [80%] or [90%], you can display markers at boundaries of display area that regular home TVs can display. The default setting is [OFF].



Press the MENU button → select the  (DISPLAY SET) with the SEL/PUSH EXEC dial.

GUIDEFAME

When you select [ON], you can display frame markers that help you to check horizontal and vertical positions of a subject. The default setting is [OFF].



Notes

- You cannot output display information, such as the time code, to an external device via external output jacks when [MARKER] is set to [ON].
- You cannot display markers when you set [DATE REC] to [ON].

Tips

- You can display all types of markers at the same time.
- You can obtain a balanced composition by positioning the subject at the cross points of the guideframe marker.
- You can display markers only on the LCD panel and viewfinder. You cannot display them on an external device.

EXP.FOCUS TYPE

You can set a type of the expanded focus display.

TYPE 1

Simply enlarges images.

TYPE 2

Enlarges and shows images in white and black.

CAM DATA DSP (Camera data display)

When you set this function to [ON], you can constantly display the iris, shutter speed and gain settings on the screen. The default setting is [OFF].

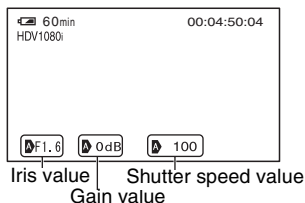

Tips

- The settings appear on the screen during the manual adjustment regardless of the settings of this function.
-  indicates that the settings are automatically adjusted values.
- The displayed settings are different from the settings that will be displayed when you press the DATA CODE button (p. 54).

AU.LVL DISP (Audio level display)

When you set this function to [ON], you can display the audio level meter on the screen. The default setting is [ON].



Audio level meter

ZOOM DISPLAY

BAR

Displays a bar that indicates the zoom position.

NUMBER

Displays a number (0 through 99) that indicates the zoom position.

FOCUS DISP

You can select how to display the focal distance during manual focus.

► METER

Displays the focal distance in meters.

FEET

Displays the focal distance in feet.

SHUTTER DISP

You can select how to display the shutter speed.

► SECOND

Displays the shutter speed in seconds.

DEGREE

Displays the shutter speed in degrees. The shutter speed equal to the period that your camcorder reads image data from the image sensor is defined as 360 degrees. The degree is calculated based on this definition and displayed.

- When [SCAN TYPE] is set to [60], 1/60 second is defined as 360 degrees.
- When [SCAN TYPE] is set to [24] or [24A], 1/24 second is defined as 360 degrees.
- When [SCAN TYPE] is set to [30], 1/30 second is defined as 360 degrees.

For details on [SCAN TYPE], see [HDV PROGRE.] (p. 85) or [DV PROGRE.] (p. 86).

⚙ Notes

- When you press the DATA CODE button, the shutter speed will be displayed in seconds regardless of the setting of this function.

💡 Tips

- Shutter speed slower than 360° are displayed in multiples of 360°, such as 360° × 2.

LCD BRIGHT

You can adjust the brightness of the LCD screen. Changes in the LCD brightness will not affect the brightness of recording images.

💡 Tips

- You can also turn off the LCD backlight (p. 18).

LCD COLOR

You can adjust the color level of the LCD panel. Changes in the LCD color level will not affect the color level of recording images.

LCD BL LEVEL

You can adjust the backlight level of the LCD screen.

► NORMAL

Standard brightness.

BRIGHT

Brightens the LCD screen.

⚙ Notes

- When you connect your camcorder to outside power sources, [LCD BL LEVEL] is automatically set to [BRIGHT].
- When you select [BRIGHT], the recordable time with the battery is slightly reduced.

VF B. LIGHT

You can adjust the brightness of the viewfinder.

► NORMAL

Standard brightness.

BRIGHT

Brightens the viewfinder screen.

⚙ Notes

- When you connect your camcorder to outside power sources, [BRIGHT] is automatically selected for the setting.

Press the MENU button → select the  (DISPLAY SET) with the SEL/PUSH EXEC dial.

- When you select [BRIGHT], the recordable time with the battery is slightly reduced.

VF COLOR

▶ ON

Displays images in the viewfinder in color.

OFF

Displays images in the viewfinder in black and white.

VF POWERMODE

▶ AUTO

Turns on the viewfinder while you close the LCD panel or record in mirror mode.

ON

Always turns on the viewfinder.

LETTER SIZE

▶ NORMAL

Displays the menu in regular letter size.

2x

Displays the selected menu items in letter size, the height of which is doubled.

REMAINING

▶ AUTO

Displays the remaining time of a tape for about 8 seconds in the following situation:

- When you set the POWER switch to VCR or CAMERA with a cassette inserted.
- When you press  (Play) or the DISPLAY/BATT INFO button.

ON

Always displays the remaining time of a tape. The remaining time is not displayed when you insert a new tape or a tape that is rewound to the beginning. It is displayed when you start playback or recording.

DISP OUTPUT

You can select outputs to which display information, such as time code, is outputted.

▶ LCD PANEL

Outputs the information to the LCD screen and viewfinder.

V-OUT/PANEL

Outputs the information to the LCD screen, viewfinder and composite output.

ALL OUTPUT

Outputs the information to the LCD screen, viewfinder, HDMI output, component output and composite output.

Notes

- You cannot output display information, such as the time code, to an external device when [MARKER] is set to [ON].

⇌ (IN/OUT REC)

menu

Recording settings, input and output settings (REC FORMAT/HDV PROGRE./VIDEO OUT/EXT REC CTRL, etc.)

The default settings are marked with ►. The indicators in parentheses appear when the items are selected.

See page 64 for details on selecting menu items.

Press the MENU button → select the ⇌ (IN/OUT REC) with the SEL/PUSH EXEC dial.

REC FORMAT

You can select a recording format.

► HDV1080i (HDV1080i)

Records in the HDV1080i format.

DV (DVCAM DV)

Records in the DVCAM (DV) format.

Set also [DV REC MODE] when you record in this format (p. 86).

Notes

- Set also [i.LINK SET] as necessary when you output a movie to an external device through an i.LINK cable (p. 87).

VCR HDV/DV

You can select a type of output signal to an external device for playing back a movie on the device. Select [AUTO] in most cases. When you connect your camcorder to an external device with an i.LINK cable, select a type of input and output signals to and from the external device via the  HDV/DV jack. You can record or play back a movie reproduced by the selected type of signals.

► AUTO

Automatically switches between HDV signals and DV signals during playback. During the i.LINK connection, recognizes HDV signals and DVCAM (DV) signals, and automatically inputs or outputs the

signals to or from the external device via the  HDV/DV (i.LINK) jack for recording or playback.

HDV (HDV1080i)

Plays back only HDV format sections of a tape.

During the i.LINK connection, inputs or outputs only HDV signals to or from an external device via the  HDV/DV (i.LINK) jack for recording or playback. Select this setting when you connect your camcorder to your computer.

DV (DVCAM DV)

Plays back only DVCAM (DV) format sections of a tape.

During the i.LINK connection, inputs or outputs only DVCAM (DV) signals to or from an external device via the  HDV/DV (i.LINK) jack for recording or playback. Select this setting when you connect your camcorder to your computer.

Notes

- Make sure to disconnect the i.LINK cable prior to changing the setting. Otherwise, a video device may not recognize video signals.
- When you select [AUTO], images and sounds may be cut off on switching between HDV signals and DVCAM (DV) signals.
- When you set [i.LINK SET] → [HDV → DV CONV] to [ON], the following signals will be outputted:
 - [AUTO]: HDV signals are converted to DVCAM (DV) signals and outputted. DVCAM (DV) signals are outputted without any conversion.
 - [HDV]: HDV signals are converted to DVCAM (DV) signals and outputted. DVCAM (DV) signals will not be outputted.
 - [DV]: DVCAM (DV) signals are outputted without any conversion. HDV signals will not be outputted.

HDV PROGRE. (HDV1080i)

■ REC TYPE

You can select an HDV recording format from [INTERLACE] and

Press the MENU button → select the  (IN/OUT REC) with the SEL/PUSH EXEC dial.

[PROGRESSIVE]. The default setting is [INTERLACE].

■ SCAN TYPE

You can select a scan type for recording in HDV format.

▶ 60

Captures 60 fields per second in an interlace scan.

24

Captures 24 frames per second.

24A



Captures 24 frames per second.

The phase of the 60i conversion is reset each time recording starts.

30

Captures 30 frames per second.

⚡ Notes

- Selectable [SCAN TYPE] settings differ depending on the setting of [REC TYPE].
 - [INTERLACE]: [60], [24], [24A], [30]
 - [PROGRESSIVE]: [24], [30]
- You can only play back a tape recorded with the [REC TYPE] set to [PROGRESSIVE] on a device that supports playback of a tape recorded by progressive scanning.
- When recording in HDV format in [24A] mode, the time code does not progress correctly from scene to scene.
When playing back those movies, a momentary pause will occur between scenes. In this case, you can copy the movies without the pause from your camcorder to a computer via an i.LINK cable and use them on the computer as normal movies.
- When [REC TYPE] is set to [PROGRESSIVE] and [SCAN TYPE] to [24], movies and time codes are recorded at 24 frames per second and indicators are displayed at 30 frames per second. When using the , HDV/DV jack, the recorded signal is outputted at the following frame rate depending on the setting of  (IN/OUT REC) menu → [i.LINK SET] → [HDV → DV CONV]:
[OFF]: 24 frames per second
[ON]: 30 frames per second
When using other jacks, the recorded signal is outputted at 30 frames per second.

DV PROGRE.

■ SCAN TYPE

You can select a scan type for recording in DVCAM/DV format.

▶ 60

Captures 60 fields per second in an interlace scan.

24

Captures 24 frames per second.

30

Captures 30 frames per second.

DV REC MODE (DV Recording mode)

This function is available only when you set [REC FORMAT] to [DV].

▶ DVCAM (DVCAM)

Records in the DVCAM format.

DV SP (DV)

Records in the SP (Standard Play) mode of the DV format to record for a longer time than in the DVCAM format.

⚡ Notes

- Mosaic-like disturbance or audio interruption may occur when you play back a movie recorded in the DV SP mode by another device.
- Image may be distorted or time code may not be properly connected between the scenes recorded in the DVCAM mode and DV SP mode.

DV WIDE REC

You can record a movie in an aspect ratio that matches that of a TV that you want to connect. Refer also to the instruction manuals that come with the TV.

▶ ON

Records a movie in an aspect ratio that matches the full screen of a 16:9 (wide) TV.

OFF (4:3)

Records a movie in an aspect ratio that matches the full screen of a 4:3 TV.

Notes

- Set [DV WIDE CONV] correctly to suite a TV that you want to connect for playback (p. 86).
- The aspect ratio will be fixed to 16:9 and you cannot set it to 4:3 when you record in HDV format.

VIDEO OUT**COMPONENT**

You can select [480i] or [1080i/480i] depending on your TV when you connect your camcorder to a TV via a component cable.

480i

Supports connection between your camcorder and a TV with a component input jack that supports the 480i format.

▶ 1080i/480i

Supports connection between your camcorder and a TV with a component input jack that supports the 1080i format.

DOWN CONVERT

You can select a down convert type when you down-convert HDV signal to DV signal. Use this function for signals outputting from the following output jacks:

- Component (480i)
- S Video
- Audio/Video

▶ SQUEEZE

Outputs a horizontally compressed image while maintaining its original height.

LETTER BOX

Outputs an image with black bars added to the top and bottom of the original image, while maintaining the original aspect ratio.

EDGE CROP

Outputs the central portion of the original image by cropping its right and left edges.

Notes

- When you view a movie recorded in the DVCAM (DV) format with [DV WIDE REC] set to [ON] on a standard 4:3 TV, images of the movie may appear vertically compressed. In such a case, set [DV WIDE CONV] to [LETTER BOX] or [EDGE CROP].

DV WIDE CONV

You can select a down convert type when you down-convert DV widescreen signal to DV signal.

Use this function for signals outputting from the following output jacks:

- Component (480i)
- S Video
- Audio/Video

▶ SQUEEZE

Outputs a horizontally compressed image while maintaining its original height.

LETTER BOX

Outputs an image with black bars added to the top and bottom of the original image, while maintaining the original aspect ratio.

EDGE CROP

Outputs the central portion of the original image by cropping its right and left edges.

i.LINK SET**HDV → DV CONV**

When you set this function to [ON], you can convert HDV format signals to DV format signals and output the DV format signals to an external device via the  HDV/DV (i.LINK) jack. You can output DV format signals without any format conversion. The default setting is [OFF].

DOWN CONVERT

You can set a down convert type when you set [HDV → DV CONV] to [ON] to convert HDV format signals to DV format signals.

▶ SQUEEZE

Outputs a horizontally compressed image while maintaining its original height.

EDGE CROP

Outputs the central portion of the original image by cropping its right and left edges.

Notes

- For i.LINK connection, see [VCR HDV/DV] (p. 85).
- Disconnect the i.LINK cable before setting [i.LINK SET]. Otherwise, the connected video device may not be able to recognize the video signal from your camcorder.

EXT REC CTRL

You can connect your camcorder to an HDV/DVCAM/DV compatible device (digital HD video camera recorder, digital video camera recorder, hard disc recorder, etc.) with an i.LINK cable, and record movies on your camcorder and the connected device simultaneously, or continue recording from your camcorder to the connected device.

Refer also to the instruction manuals supplied with the connecting devices.

REC CTL MODE

▶ OFF

Does not record on a connected device.

SYNCHRONOUS (EXT)

Records movies, sound and time code on a connected device in synchronization with your camcorder.

RELAY (EXT)



Records movies, sound and time code on a connected device when a tape on your camcorder reaches close to the end during recording.

EXT ONLY (EXT)

You can operate an external recording unit* with the REC START/STOP button of your camcorder.

*HVR-MRC1(optional) or HVR-DR60 (optional)

Notes

- When this function is set to [EXT ONLY],  does not flash even when there is no tape inserted.
- You can use the REC START/STOP button of your camcorder as a recording start/stop button for the external recording unit when you set this function to [EXT ONLY]. Use the REC button of the video control buttons (p. 138) to start recording on a tape or the STOP button to stop recording.
- EXT  (EXT ONLY) flashes when you connect an external recording unit that is not supported by [EXT ONLY].

STBY COMMAND

▶ REC PAUSE

Stops recording operation of a connected device by putting it in pause when you stop recording operation of your camcorder.

STOP

Stops recording operation of a connected device when you stop recording operation of your camcorder.

00:00 (TC/UB SET) menu

(TC PRESET/UB PRESET/TC LINK, etc.)

The default settings are marked with ▶.
The indicators in parentheses appear when the items are selected.

See page 64 for details on selecting menu items.

Press the MENU button → select the 00:00 (TC/UB SET) with the SEL/PUSH EXEC dial.

TC PRESET

■ PRESET

You can preset the time code.

- ① Select [TC PRESET] with the SEL/PUSH EXEC dial.
- ② Select [PRESET] with the SEL/PUSH EXEC dial.
- ③ Select the first 2 digits with the SEL/PUSH EXEC dial.
You can set the time code between 00:00:00:00 and 23:59:59:29.
- ④ Set other digits by repeating step ③.
- ⑤ Select [OK] with the SEL/PUSH EXEC dial.

■ RESET

You can reset the time code (00:00:00:00). Select [RESET] in step ① of the [PRESET].

TC COUNTUP (AS)

You can increment the hour of time code by 1 and reset the minute, second and frame of time code when you execute this function.

🔊 Notes

- This function is available only when you set [TC MAKE] to [PRESET].

UB PRESET

■ PRESET

You can preset the user bit.

- ① Select [UB PRESET] with the SEL/PUSH EXEC dial.

- ② Select [PRESET] with the SEL/PUSH EXEC dial.
- ③ Select the first 2 digits with the SEL/PUSH EXEC dial.
- ④ Set other digits by repeating step ③.
- ⑤ Select [OK] with the SEL/PUSH EXEC dial.

■ RESET

You can reset the user bit (00 00 00 00). Select [RESET] in step ① of the [PRESET].

TC FORMAT

You can select the frame mode.

▶ AUTO

Select the frame mode automatically in accordance with the inserted cassette.

DF

Select the frame mode to the drop frame mode.

NDF

Select the frame mode to the non-drop frame mode.

💡 Tips

What is drop frame?

Although 30 frames are considered as 1 second in time code processing, the actual frame frequency of an NTSC image signal is 29.97 frames/sec. As a result, the time code gradually lags behind real time as the recording gets longer. The drop frame function adjusts the time code to real time. In the drop frame process, the first 2 frames of each second are not recorded except in every tenth minute. Recording without the drop frame process is called non-drop frame recording.

Press the MENU button → select the 00=00 (TC/UB SET) with the SEL/PUSH EXEC dial.

TC RUN

You can select how the time code advances.

► REC RUN

Advances the time code only during recording.

Select this setting to record the time code continuous from the last time code of the previous recording.

FREE RUN

Advances the time code regardless of operation of your camcorder.

Select this setting to save the actual time in the time code.

TC MAKE

► REGENERATE

Reads the last time code of the previous recording from the tape and records the new time code consecutively from the last time code during the backspace editing. The time code runs in [REC RUN] mode regardless of the setting of [TC RUN].

PRESET

Records the newly set time code on the tape.

TC LINK

You can synchronize the time codes of multiple camcorders.

This function is useful for editing movies recorded by multiple camcorders.

- ① Insert a tape to the main camcorder from which you want to generate the time code.
- ② Set the POWER switches of the main and sub camcorders to CAMERA.
- ③ Connect the sub camcorder to the main camcorder with an i.LINK cable.
- ④ Set the main and sub camcorder as follows:
 - Set [TC RUN] to [FREE RUN] (p. 90).
 - Set [TC MAKE] to [PRESET] (p. 90).
 - Set [TC FORMAT] of the main and sub camcorders to the same settings (p. 89).

Set the sub camcorders as follows:

- ⑤ Select [TC/UB SET] → [TC LINK] with the SEL/PUSH EXEC dial.

The message [Synchronize TC with connected device?] appears.

- ⑥ Select [YES] to synchronize the time code of the sub camcorder with that of the main camcorder. Disconnect the i.LINK cable from your camcorders when synchronization is completed. You can record with the synchronized time codes using those camcorders.

⚡ Notes

- If you want to execute [TC LINK] for more than two camcorders, repeat the steps for multiple sub camcorders with one main camcorder.
- Some frame shifting may occur over time after time code synchronization.
- Some frame shifting may occur if you turn the power off and back on. In such a case, set [TC LINK] again.

UB TIME REC

► OFF

Does not save the actual time in the user bit code.

ON

Saves the actual time in the user bit code.

UB-DATE/TC-TIME

You can save the date and time set in your camcorder in the user bit and time code, respectively, when you do this function.

⚡ Notes

- This function is available in the following cases:
 - [TC MAKE] : [PRESET]
 - [TC RUN] : [FREE RUN]
 - [UB TIME REC] : [OFF]
- The time lag may occur between the set time code and the actual time as time goes on. Do [UB-DATE/TC-TIME] again prior to recording.
- The date saved in the user bit will not be automatically updated even when the actual date has been changed.

(MEMORY SET) menu

Settings for the “Memory Stick Duo” (ALL ERASE/FORMAT, etc.)

The default settings are marked with ►.
The indicators in parentheses appear when the items are selected.

See page 64 for details on selecting menu items.

Press the MENU button → select the  (MEMORY SET) with the SEL/PUSH EXEC dial.

ALL ERASE

You can delete all the still images without image protection on a “Memory Stick Duo” or in the selected folder.

- ① Select [ALL FILES] or [CURRENT FLDR].

[ALL FILES]: Deletes all the images on the “Memory Stick Duo.”

[CURRENT FLDR]: Deletes all the images in the currently selected folder.

- ② Select [YES] → [YES] with the SEL/PUSH EXEC dial.

[Erasing all data...] appears.

[Completed.] appears when all unprotected images are deleted.

Notes

- Release the write protect tab on the “Memory Stick Duo” beforehand for the “Memory Stick Duo” with the write-protect tab (p. 122).
- The folder will not be deleted even when you delete all the images in the folder.
- Do not do any of the following while [Erasing all data...] is displayed:
 - Operate the POWER switch/buttons.
 - Eject the “Memory Stick Duo.”

FORMAT

You do not need to format the “Memory Stick Duo” since it is already formatted at the factory. If you want to format the “Memory Stick Duo,” select [YES]→[YES].

Notes

- Do not do any of the following while [Formatting...] is displayed:
 - Operate the POWER switch/buttons.
 - Eject the “Memory Stick Duo.”
- Formatting erases everything on the “Memory Stick Duo” including protected image data and newly created folders.

FILE NO.

► SERIES

Assigns file numbers in sequence even if the “Memory Stick Duo” is replaced with another one. The file number is reset when a new folder is created or the recording folder is replaced with another.

RESET

Resets the file number to 0001 each time the “Memory Stick Duo” is changed.

NEW FOLDER

When you select [YES], you can create a new folder (102MSDCF to 999MSDCF) on a “Memory Stick Duo.” When a folder is full (a maximum of 9,999 images are stored), a new folder is automatically created.

Notes

- You cannot delete the new folder once you have created it on your camcorder. Format the “Memory Stick Duo” (p. 91) or delete it on your computer.
- The number of recordable pictures on a “Memory Stick Duo” may decrease as the number of folders increases.

REC FOLDER (Recording folder)

You can select a folder in which you want to store still images.
Select the folder with the SEL/PUSH EXEC dial.

Tips

- The still images will be stored in the 101MSDCF folder by default.

Press the MENU button → select the  (MEMORY SET) with the SEL/PUSH EXEC dial.

- Once you store the still images in the current folder, the folder is selected as a playback folder.

PB FOLDER (Playback folder)

You can select a folder in which still images you want to view are stored. Select the folder with the SEL/PUSH EXEC dial.

(OTHERS) menu

Settings while recording on a tape or other basic settings (QUICK REC/BEEP, etc.)

The default settings are marked with ►. The indicators in parentheses appear when the items are selected.

See page 64 for details on selecting menu items.

Press the MENU button → select the  (OTHERS) with the SEL/PUSH EXEC dial.

CAMERA PROF. (Camera profile)

You can save up to 99 camera setting profiles on a “Memory Stick Duo” and two profiles in your camcorder. Using these saved profiles let you quickly obtain suitable camera settings later. When using multiple camcorders of this model, you can save the setting on a “Memory Stick Duo” and load them into the other camcorders.

Tips

- You can save menu settings, picture profiles and button settings as a camera profile.

■ To load a camera profile

You can load a camera profile and use it on your camcorder.

- ① Select [LOAD] with SEL/PUSH EXEC dial.
- ② Select the camera profile that you want to load with the SEL/PUSH EXEC dial.
- ③ Select [YES] in the check screen.
Your camcorder is restarted and the selected camera profile becomes effective.

Notes

- You cannot load camera profile that has been saved by a different model of camcorder or edited on a computer.

■ To save a camera profile

- ① Select [SAVE] with the SEL/PUSH EXEC dial.
- ② Select [MEMORY STICK] with the SEL/PUSH EXEC dial to save the camera profile on the “Memory Stick Duo” or [CAMERA] to save it in your camcorder.

- ③ Select [NEW FILE] or an existing profile name with the SEL/PUSH EXEC dial.
- ④ Select [YES] in the check screen with the SEL/PUSH EXEC dial.
The camera profile is saved.

Tips

- When you select [NEW FILE] in [MEMORY STICK], a camera profile is saved as [MS01] the first time you save a camera profile.
- When you select [NEW FILE] in [CAMERA], a camera profile is saved as [CAM1] or [CAM2].
- When you select an existing camera profile, the new camera profile is overwritten.
- You cannot view nor edit a camera profile saved on a “Memory Stick Duo” on your computer.
- You can save a camera profile on a “Memory Stick Duo” that has still image data.

■ To change the camera profile name

You can change the camera profile name.

- ① Select [PROFILE NAME] with the SEL/PUSH EXEC dial.
- ② Select the camera profile of which you want to change the name with the SEL/PUSH EXEC dial.
[PROFILE NAME] screen appears.
- ③ Change the profile name with the SEL/PUSH EXEC dial.

Tips

- You can enter the name in the same way as the picture profile (p. 43).
- ④ Select [OK] with the SEL/PUSH EXEC dial.
Profile name is changed.

■ To delete camera profile settings

- ① Select [DELETE] with the SEL/PUSH EXEC dial.
- ② Select the camera profile you want to delete with the SEL/PUSH EXEC dial.
- ③ Select [YES] on the check screen.

■ To copy a camera profile

You can copy camera profile saved on your camcorder to a “Memory Stick Duo.”

- ① Select [COPY] with the SEL/PUSH EXEC dial.

- ② Select the camera profile that you want to copy with the SEL/PUSH EXEC dial.
- ③ Select [MEMORY STICK] or [CAMERA] for a “Memory Stick Duo” or your camcorder as a copy destination of the camera profile.
- ④ Select [NEW FILE] or an existing profile name with the SEL/PUSH EXEC dial.
- ⑤ Select [YES] on the check screen.

Tips

- You can copy a camera profile saved on a “Memory Stick Duo” to your camcorder.

ASSIGN BTN

See page 46.

CLOCK SET

See page 20.

WORLD TIME

When you use your camcorder abroad, you can adjust the clock to the local time by setting the time difference with the SEL/PUSH EXEC dial.

When you set the time difference to 0, the clock returns to the original setting.

LANGUAGE

You can select the language to be used on the LCD screen.

Tips

- Your camcorder offers [ENG[SIMP]] (simplified English) in case that you cannot find your native tongue among the options.

PB ZOOM (Playback zoom)

When you set this function to [ON], you can enlarge movie images about 1.1 to 5 times (still images about 1.5 to 5 times)

Press the MENU button → select the  (OTHERS) with the SEL/PUSH EXEC dial.

with the handle zoom lever. The default setting is [OFF]. To end the zoom, press and hold the W side of the handle zoom lever until it stops.

Tips

- To move the zoom horizontally, press the SEL/PUSH EXEC dial, then turn the dial. To move the zoom vertically, press the SEL/PUSH EXEC dial one more time, then turn the dial.

QUICK REC

You can slightly reduce the recording start point time when resuming recording by changing the POWER switch from OFF to CAMERA.

▶ OFF

It takes some time to restart recording from the state that the drum has stopped rotating, but the transition from the last recorded scene is smooth.

ON

The time shortens slightly until recording restarts from the state that the drum has stopped rotating, but the transition from the last recorded scene may not be smooth.

Select this when you do not want to miss a recording chance.

Tips

- When this function is set to [ON], the interval between scenes freezes for a moment (editing on your computer is recommended).
- When the camcorder is left in standby for more than about 3 minutes, your camcorder exits from standby (the drum stops rotating) to prevent tape wear and battery loss. Since the power does not turn off, you can restart recording by pressing the REC START/STOP button again.

DATE REC

▶ OFF

Does not superimpose the date and time on images.

ON

Superimposes the date and time on images.

Tips

- When [DV WIDE REC] is set to [OFF], the date and time are displayed outside the 4:3 area but properly recorded on images.
- When you record in the HDV format, the date and time are displayed at different positions during recording and playback.

BEEP

▶ OFF

Cancels the melody.

ON

Activates a melody when you start/stop recording.

REC LAMP[F] (Recording lamp [front])

When you set this function to [OFF], you can turn off the front camera recording lamp during recording. The default setting is [ON].

REC LAMP[R] (Recording lamp [rear])

When you set this function to [OFF], you can turn off the rear camera recording lamp during recording. The default setting is [ON].

REMOTE CTRL (Remote control)

When you set this function to [ON], you can use the supplied Remote Commander (p. 139). The default setting is [ON].

Tips

- Set to [OFF] to prevent your camcorder from responding to a command sent by another VCR remote control unit.

HOURS METER

You can display the cumulative operation time of your camcorder with the total hours of operation, drum rotation, tape running, or

the total number of tape unthreading operations.

OPERATION

Displays the total hours of operation in 10-hour increments.

DRUM RUN

Displays the total hours of drum rotation in 10-hour increments.

TAPE RUN

Displays the total hours of tape running in 10-hour increments.

THREADING

Displays the total number of tape unthreading operation in 10-operation increments.

Dubbing to VCR, DVD/HDD device, etc.

Connect your camcorder to the wall outlet (wall socket) using the supplied AC Adaptor/Charger for this operation (p. 13). Refer also to the instruction manuals supplied with the devices to be connected.

Connecting to external devices

The connection method and the image quality will differ depending on the VCR, DVD/HDD device and the connectors used.

Jacks on your camcorder

Open the jack cover and connect the cable.

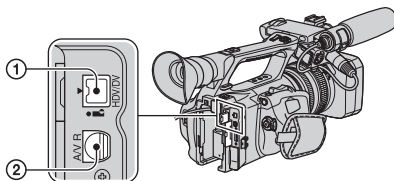

→ : Signal flow

Camcorder	Cable	External device
	i.LINK cable (optional) 	HDV1080i compatible device → HD quality*
	i.LINK cable (optional) 	AV device with i.LINK jack → SD quality*
	A/V connecting cable with S VIDEO (optional) 	AV device with S VIDEO jack → SD quality*

* i.LINK jack which is compatible with HDV1080i specification is required on the external device.

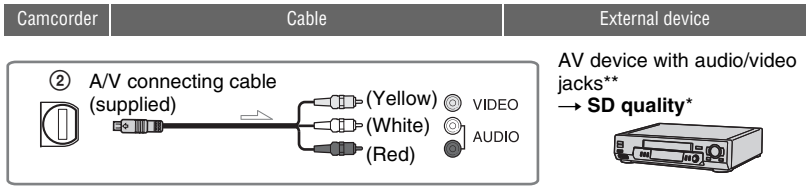

* Pictures recorded in the DVCAM (DV) format are dubbed in the SD (standard definition) quality, regardless of the connection.

** When connecting your camcorder to a monaural device, connect the yellow plug of the A/V connecting cable to the video jack on the device, and connect the white (left channel) or red (right channel) plug to the audio jack on the device.

⚡ Notes

- You cannot dub pictures using the HDMI cable.

Using an i.LINK cable (optional)

The dubbed format (HDV/DV) differs depending on the recording format or the format supported by the VCR/DVD device. See the table below for selecting the appropriate settings, and perform necessary menu setting.

⚡ Notes

- Disconnect the i.LINK cable before changing these menu settings, otherwise the VCR/DVD device may not correctly identify the video signal.

💡 Tips

- This camcorder has a 4-pin i.LINK terminal. Select a cable that fits the terminal on the device to be connected.

Dubbing to VCR, DVD/HDD device, etc. (Continued)

Copy format	Camcorder recording format	Format supported by the VCR/DVD device		Menu setting	
		HDV format* ¹	DVCAM (DV) format	[VCR HDV/DV] (p. 85)	[i.LINK SET] (p. 87)
Copy HDV recording as HDV	HDV	HDV	—* ³		[OFF]
Convert HDV recording to DVCAM (DV)	HDV	DVCAM (DV)	DVCAM (DV)	[AUTO]	[ON]
Copy DVCAM (DV) recording as DVCAM (DV)	DVCAM (DV)	DVCAM (DV)	DVCAM (DV)		[OFF]
When tape is recorded in both HDV and DVCAM (DV) format					
Convert both HDV and DVCAM (DV) format to DVCAM (DV)	HDV/DVCAM (DV)	DVCAM (DV)	DVCAM (DV)	[AUTO]	[ON]
Copy only portions recorded in HDV format	HDV	HDV	—* ³		
	DVCAM (DV)	—* ²	—* ³	[HDV]	[OFF]
Copy only portions recorded in DVCAM (DV) format	HDV	—* ²	—* ²		
	DVCAM (DV)	DVCAM (DV)	DVCAM (DV)	[DV]	[OFF]

*¹ Recording device compliant with the HDV1080i specification.

*² The tape advances, but no video or sound is recorded (blank).

*³ Picture is not recognized (no recording is made).

🔊 Notes

- When [VCR HDV/DV] is set to [AUTO], and the signal switches between HDV and DVCAM (DV) formats, the picture and sound are interrupted temporarily.
- When the recorder is HVR-Z5U/Z5N, set [VCR HDV/DV] to [AUTO] (p. 85).
- When the player and the recorder are both HDV1080i compatible devices such as HVR-Z5U/Z5N and connected with the i.LINK cable, after pausing or stopping and then resuming the recording, the images will be a bit choppy or rough at that point.
- Set [DISP OUTPUT] to [LCD PANEL] (the default setting) when connecting with an A/V connecting cable (p. 84).

When connecting with the A/V connecting cable with S VIDEO (optional)

Connect with S VIDEO jack instead of the video plug (yellow). This connection produces pictures more faithfully. This connection produces higher quality DVCAM (DV) format pictures. The audio will not be output when you connect with the S VIDEO cable alone.

Dubbing to another device

1 Prepare your camcorder for playback.

Insert the recorded cassette.
Slide the POWER switch to VCR.

Set [DOWN CONVERT]/[DV WIDE CONV] according to the playback device (TV, etc.) (p. 87).

2 Prepare your VCR/DVD device for recording.

When dubbing to the VCR, insert a cassette for recording.
When dubbing to the DVD recorder, insert a DVD for recording.

If your recording device has an input selector, set it to the appropriate input (such as video input1 and video input2).

3 Connect your VCR/DVD device to your camcorder as a recording device.



See page 96 for connection details.

4 Start playback on the camcorder, and recording on the VCR/DVD device.



Refer to the operating instructions supplied with your recording device for details.

5 When dubbing is complete, stop your camcorder and the VCR/DVD device.

Notes

- The following cannot be output via the  HDV/DV interface (i.LINK):
 - Indicators
 - Titles that are recorded on other camcorders
- Pictures recorded in the HDV format are not output from the  HDV/DV interface (i.LINK) jack during playback pause or in any playback mode other than normal playback.
- Note the following when connecting with an i.LINK cable:
 - The recorded picture becomes rough when a picture is paused on your camcorder while recording to a VCR/DVD device.
 - Data codes (date/time/camera settings data) may not be displayed or recorded depending on the device or application.
 - You cannot record the picture and sound separately.
- When dubbing to a DVD recorder from your camcorder through an i.LINK cable, you may not operate your camcorder on your DVD recorder even if its instruction manual says you can. If you can set the input mode to HDV or DV on your DVD recorder and can input/output pictures, follow the steps in “Using an i.LINK cable (optional).”

Tips

- To record the date/time and camera settings data when connected by the A/V connecting cable, display them on the screen.
- When you use an i.LINK cable, the video and sound signals are transmitted digitally, producing high quality pictures.
- When an i.LINK cable is connected, the format of the output signal (HDVout  or DVout ) will be indicated on the LCD screen of your camcorder.

Recording pictures from a VCR i.LINK

You can record pictures from a VCR on a tape. You can record a scene as a still image on a "Memory Stick Duo." You can record pictures in the HDV format by connecting an HDV1080i specification compatible device. Be sure to insert a cassette or a "Memory Stick Duo" for recording in your camcorder beforehand.

You can connect your camcorder to a VCR device using an i.LINK cable.

Connect your camcorder to the wall outlet (wall socket) using the supplied AC Adaptor/Charger for this operation (p. 13). Refer also to the instruction manuals supplied with the devices to be connected.

Notes

- You need an i.LINK cable for this operation.
- You cannot perform this operation with the A/V connecting cable.
- Your camcorder has a 4-pin i.LINK terminal. Select a cable that fits the terminal on the device to be attached.
- Your camcorder can only record from an NTSC source. For example, French video or TV programs (SECAM) cannot be recorded correctly. See page 118 for details on TV color systems.

HDV1080i compatible device



→ HD quality

AV device with i.LINK jack



→ SD quality

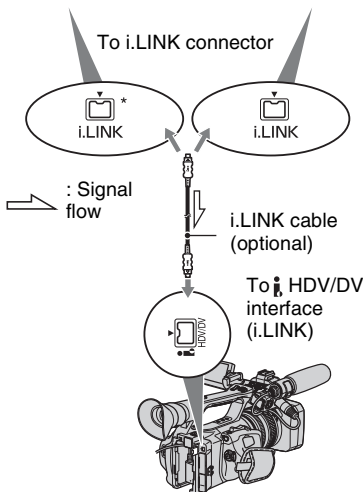

* An i.LINK jack which is compatible with HDV1080i specification is required.

Recording movies



1 Set the **POWER** switch to **VCR**.

2 Set the input signal of your camcorder.

Set [VCR HDV/DV] to [AUTO] when recording from an HDV format compatible device.



Set [VCR HDV/DV] to [DV] or [AUTO] when recording from a DVCAM (DV) format compatible device (p. 85).

3 Connect your VCR as a player to your camcorder.

When an i.LINK cable is connected, the format of the input signal (**HDV IN**  or **DV IN** ) will be indicated on the LCD screen of your camcorder (This indicator may appear on the screen of the playback device but it will not be recorded).

4 Insert a cassette into the VCR.

5 Set your camcorder to recording pause.

While pressing  (PAUSE), press both  REC (record) buttons simultaneously.

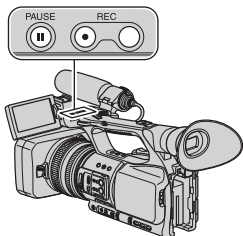



6 Start playing the cassette on your VCR.

The picture played on the VCR appears on the LCD screen of your camcorder.

7 Press (PAUSE) again at the point you want to start recording.

8 Press (STOP) to stop recording.

Notes

- You cannot record TV programs from the  HDV/DV interface (i.LINK).
- User bits are not recorded when dubbing from a DVCAM (DV) device via an i.LINK cable.
- You can record pictures from DV devices only in the DVCAM (DV) format.
- Note the following when connecting with an i.LINK cable:
 - The recorded picture becomes rough when a picture is paused on your camcorder while recording to a VCR.
 - You cannot record the picture and sound separately.
 - If you pause or stop the recording and restart it, the picture may not be recorded smoothly.
- If video signals inputted to your camcorder via the  HDV/DV jack experience the phenomenon of jittering (variation in frequency), that jittering is transmitted to the video signals outputted from the A/V remote connector. When you monitor a movie on a TV connected to your camcorder via the A/V remote connector, images may be distorted or not be displayed. Jittering will not affect recording of the movie on a tape with your camcorder but may affect recording of the movie with another VCR connected to your camcorder via the A/V remote connector.

Tips

- When a 4:3 video signal is input, it appears with black bands on the right and left sides on the screen of your camcorder.

Recording still images

Be sure to insert a “Memory Stick Duo” for recording in your camcorder and assign [PHOTO] to the ASSIGN 7/PHOTO button (p. 46) beforehand.

1 Perform steps 1 to 4 in “Recording movies.”

2 Start playing the cassette.

The pictures on the VCR appear on the screen of your camcorder.

3 Press the ASSIGN 7/PHOTO button on your camcorder or the PHOTO button on the Remote Commander at the scene you want to record.

Notes

- The image size is 1.2M when capturing a still image from a movie recorded and played back in the HDV format. The image size is 0.2M when capturing a still image from a movie recorded and played back in the DVCAM (DV) and widescreen (16:9) formats, or VGA (0.3M) when the movie is recorded and played back in the DVCAM (DV) and 4:3 formats.

Copying movies on a tape to a computer

Connect your camcorder to the computer with an i.LINK cable.

The computer needs to have an i.LINK connector and be installed with editing software that can copy video signals. The software required depends on the format of the recorded pictures and the format for copying to the computer (HDV or DVCAM (DV)) as shown in the table below.

Recorded format	Format for copying to the computer	Required software
HDV	HDV	Editing software capable of copying HDV signal
HDV	DVCAM (DV)	Editing software capable of copying DVCAM (DV) signal
DVCAM (DV)	DVCAM (DV)	Editing software capable of copying DVCAM (DV) signal

Notes

- The **i** HDV/DV jack of your camcorder does not have a power-supply function.
- When you connect your camcorder to a computer via an i.LINK cable, make sure that the terminals of the i.LINK cable are placed the right way. Squeezing the terminals into jacks may damage the terminals and jacks, or result in a malfunction of your camcorder.
- You cannot copy image data stored on a “Memory Stick Duo” onto your computer via an i.LINK cable.
- Refer to the operating instructions of the software for the details on image copying.
- Refer to the operating instructions of the editing software for the recommended connection.
- Some editing software on the computer may not work correctly.
- You cannot change format DVCAM (DV) to HDV.

The required menu settings vary depending on the recorded images and the format

(HDV or DVCAM (DV)) to be copied to the computer.

Recorded format	Format for copying to the computer	Menu setting*
HDV	HDV	[VCR HDV/DV] → [HDV] [i.LINK SET] → [HDV → DV CONV] → [OFF]
HDV	DVCAM (DV)	[VCR HDV/DV] → [HDV] [i.LINK SET] → [HDV → DV CONV] → [ON]
DVCAM (DV)	DVCAM (DV)	[VCR HDV/DV] → [DV] [i.LINK SET] → [HDV → DV CONV] → [OFF]

* See page 64 for menu settings.

💡 Tips

- To copy HDV format images as they are without changing their format, an HDV compatible environment is required. For details, refer to your software instruction manual or contact the software manufacturer.
- To play movies by a regular DVD player, you need to create DVD video in the SD format. The DVD video is not in the HDV format.

Step 1 Connect an i.LINK cable

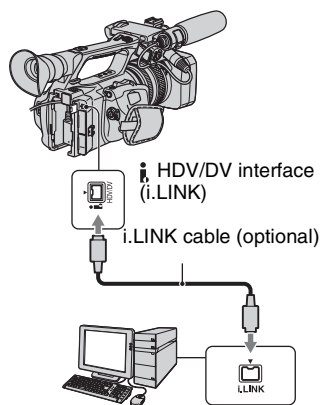

Notes on connecting to the computer

- Connect the i.LINK cable to the computer first, then to your camcorder. Connecting in the opposite order may cause static electricity to build up, resulting in a malfunction of your camcorder.
- The computer may freeze or may not recognize the signal from your camcorder in the following situations.
 - Connecting your camcorder to a computer that does not support the video signal formats appearing on the LCD screen of your camcorder display (HDV or DVCAM (DV)).
 - Changing [VCR HDV/DV] (p. 85) and [i.LINK SET] (p. 87) settings while connected with an i.LINK cable.
 - Changing [REC FORMAT] setting while connected with an i.LINK cable with the POWER switch set to CAMERA (p. 85).
 - Changing the POWER switch position while connected with an i.LINK cable.
- The format (HDV or DVCAM (DV)) of input/output signal appears on the LCD screen of your camcorder while connected with an i.LINK cable.

Step:2 Copying the movies

Use the supplied AC Adaptor/Charger to obtain AC power (p. 13).

- ① Prepare editing software (not provided).
- ② Turn on your computer.
- ③ Insert a tape into your camcorder and set the POWER switch to VCR.
- ④ Set the menu of your camcorder.
The menu settings vary depending on the copying image.
- ⑤ Copy images to the computer with your software.

Notes

- If images are copied in HDV format but are not recognized, your editing software may not support HDV format. Convert the images to DVCAM (DV) format according to step ④ and copy again.
- A tape recorded in DVCAM (DV) format cannot be copied to a computer in HDV format.

Tips

- When images recorded in HDV format are copied to a computer, the file size is about 2GB (almost the same as a DV file) for a 10-minute movie if the video compression format is MPEG2.

When copying the movie in the HDV format from the computer to your camcorder

Set [VCR HDV/DV] to [HDV] and [HDV → DV CONV] of [i.LINK SET] to [OFF] (p. 85, 87).

Notes

- To copy an HDV format movie edited on a computer back onto a tape in HDV format is possible so long as your editing software supports copying HDV movies onto tape. For details, contact the software manufacturer.

When copying the movie in the DVCAM (DV) format from the computer to your camcorder

Set [VCR HDV/DV] to [DV] (p. 85).

Copying still images to a computer

System requirements

- For details on precautions and compatible application software, refer also to the operating instructions of the device to be connected.
- Required hardware: “Memory Stick Duo” slot, Memory Stick Reader/Writer compatible with “Memory Stick Duo.”

Copying the pictures

For Windows users

You can copy still images stored on a “Memory Stick Duo” to your computer via the “Memory Stick Duo” slot of your computer.

- ① Turn on your computer.
- ② Insert the “Memory Stick Duo” into the “Memory Stick Duo” slot of your computer.
- ③ Double-click the [Removable Disk] icon displayed in [My Computer]. Then, drag and drop a still image from the folder onto the hard disk drive of your computer.

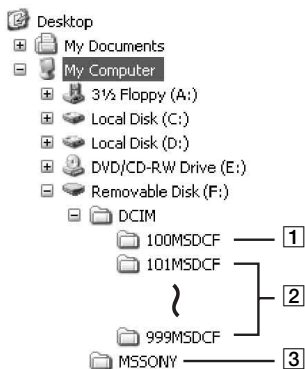

- ① Folder containing image files recorded by other camcorders without the folder creation function (for playback only).

- ② Folder containing image files recorded by your camcorder when no new folders have been created, only [101MSDCF] is displayed.
- ③ Folder containing movie data recorded by other camcorders without the folder creation function (for playback only)

Folder	File	Meaning
101MSDCF (up to 999MSDCF)	DSC0□□ □□.JPG	Still image file

□□□□ are numbers between 0001 and 9999.

For Macintosh users

Double-click the drive icon, then drag and drop the desired picture file onto the hard disk of your computer.

Troubleshooting

If you run into any problems using your camcorder, use the following table to troubleshoot the problem. If the problem persists, disconnect the power source and contact your Sony dealer.

- Power sources/LCD screen/Remote Commander...p. 106
- Cassette tapes/"Memory Stick Duo"...p. 107
- Recording...p. 108
- Playback...p. 111
- Connecting to TV...p. 113
- Dubbing/Editing/Connecting to other devices...p. 114
- Connecting to a computer...p. 115

Power sources/LCD screen/Remote Commander

The power does not turn on or abruptly turns off.

- Attach a charged battery pack to the camcorder (p. 13).
- Use the AC Adaptor/Charger to connect to a wall outlet (wall socket) (p. 13).

The camcorder does not operate even when the power is set to on.

- Disconnect the AC Adaptor/Charger from the wall outlet (wall socket) or remove the battery pack, then reconnect it after about 1 minute.
- Press the RESET button (p. 138) using a sharp-pointed object.

The camcorder gets warm.

- The camcorder may get warmer while you use it. This is not a malfunction.

The remaining battery time indicator does not indicate the correct time.

- Ambient temperature is too high or too low, or the battery pack has not been charged enough. This is not a malfunction.
- Fully charge the battery again. If the problem persists, the battery may be worn-out. Replace it with a new one (p. 13, 123).
- The indicated time may not be correct in certain circumstances. For example, when you open or close the LCD panel, it takes about 1 minute to display the correct remaining battery time.

The battery pack discharges too quickly.

- Ambient temperature is too high or low, or the battery pack has not been charged enough. This is not a malfunction.
- Fully charge the battery again. If the problem persists, the battery may be worn-out. Replace it with a new one (p. 13, 123).

The picture remains on the LCD screen.

- This occurs if you disconnect the DK-415 cable or remove the battery pack without turning off the power first. This is not a malfunction.

The picture in the viewfinder is not clear.

- Move the viewfinder lens adjustment lever until the picture appears clearly (p. 18).

The picture in the viewfinder has disappeared.

- If you change [VF POWERMODE] to [AUTO], the finder light remains off while the LCD panel is open (p. 83).

The supplied Remote Commander does not function.

- Set [REMOTE CTRL] to [ON] (p. 94).
- Remove any obstructions between the Remote Commander and the remote sensor.
- Keep strong light sources, such as sunlight or overhead lighting, away from the remote sensor, otherwise the Remote Commander may not function properly.
- Insert a fresh battery in the compartment with its +/- terminals matching those of the compartment (p. 139).

Another VCR malfunctions when you use the supplied Remote Commander.

- Select a commander mode other than VTR 2 for your VCR.
- Cover the sensor of your VCR with black paper.

Cassette tapes/“Memory Stick Duo”

The cassette cannot be ejected from the compartment.

- Make sure the power source (battery pack or AC Adaptor/Charger) is connected correctly (p. 13).
- Moisture condensation has occurred inside the camcorder (p. 126).

The Cassette Memory indicator or title display does not appear while using a cassette with the Cassette Memory function.

- This camcorder does not support the Cassette Memory function, so the indicator does not appear.

The remaining tape indicator is not displayed.

- Set [REMAINING] to [ON] to always display the remaining tape indicator (p. 84).

The cassette is noisier during rewinding or fast-forwarding.

- When using the DK-415 cable rewind/fast forward speed increases (compared with battery operation) and therefore increases noise. This is not a malfunction.

You cannot delete pictures on a “Memory Stick Duo.”

- The pictures are protected. Release the protect function on your computer, etc.

Recording

The recording does not start when you press the REC START/STOP button.

- Slide the POWER switch to CAMERA (p. 24).
- The tape has reached the end. Rewind it, or insert a new cassette.
- Set the write-protect tab of the cassette to REC or insert a new cassette (p. 119).
- The tape is stuck to the drum due to moisture condensation. Remove the cassette and leave your camcorder for at least 1 hour, then re-insert the cassette (p. 126).
- Set [REC CTL MODE] of [EXT REC CTRL] to other than [EXT ONLY] (p. 88).



The handle zoom does not work.

- Set the handle zoom speed switch to FIX or VAR (p. 28).

You cannot record on the “Memory Stick Duo.”

- The “Memory Stick Duo” is full. Delete unnecessary pictures recorded on the “Memory Stick Duo” (p. 122).
- Format the “Memory Stick Duo” on your camcorder (p. 91) or insert another “Memory Stick Duo” (p. 22).
- You cannot record still images on the “Memory Stick Duo” in the following cases.
 - While executing [FADER]
 - While executing [SMTH SLW REC]
 - When [SCAN TYPE] is set to [24] or [24A] and the shutter speed is slower than 1/48 (p. 85, 86)
 - When [SCAN TYPE] is set to [60] or [30] and the shutter speed is slower than 1/60 (p. 85, 86)
 - While using shot transition
- Assign [PHOTO] to the ASSIGN 7/PHOTO button or any one of the ASSIGN buttons.

You cannot record a smooth transition on a tape from the last recorded scene to the next.

- Do not record progressive pictures in different [REC TYPE] settings on the same tape.
- Perform End search (p. 48).
- Do not remove the cassette (the picture will be recorded continuously without a break even when you turn the power off).
- Do not record pictures in the HDV and DVCAM (DV) formats on the same tape.
- Do not record pictures in DVCAM mode and DV SP mode on the same tape. 
- When [QUICK REC] is set to [ON], you cannot record a smooth transition (p. 94). 
- When [SCAN TYPE] is set to [24A], you cannot record a smooth transition (p. 85).

The shutter sound is not heard when you record a still image.

- Set [BEEP] to [ON] (p. 94).
- No shutter sound will be outputted during movie recording or while an external device is connected.

End search or last scene review does not work.

- Do not eject the cassette after recording (p. 48).
- There is nothing recorded on the cassette.
- There is a blank section between recorded sections of the tape. This is not a malfunction.

Automatic focus does not function.

- Set the FOCUS switch to AUTO to enable the automatic focus function (p. 29).
- Adjust the focus manually if the automatic focus does not work properly (p. 30).

Menu items are grayed out or do not work.

- You cannot select grayed out display items in the current recording/playback situation.
- There are some functions you cannot activate simultaneously. The following list shows examples of unworkable combinations of functions and menu items.

Cannot use	Situation
[BACK LIGHT], [SPOTLIGHT]	Two or more of iris, gain, and shutter speed are set manually. [IRIS/EXPOSURE] is set to [EXPOSURE] and image brightness is adjusted with the iris ring [HYPER GAIN] is set to [ON].
[CNTRST ENHCR]	[BACK LIGHT] is set to [ON].
[FADER]	No tape is inserted. Moisture condensation has occurred inside the camcorder. The write-protect tab on the cassette is set to SAVE.
[ZEBRA], [PEAKING], [CAM DATA DSP], [HISTOGRAM]	[COLOR BAR] is set to [ON].
[SMTH SLW REC]	[REC TYPE] of [HDV PROGRE.] is set to [PROGRESSIVE]. [REC TYPE] of [HDV PROGRE.] is set to [INTERLACE] and [SCAN TYPE] is set to [24], [24A] or [30]. [SCAN TYPE] of [DV PROGRE.] is set to [24] or [30]. [REC CTL MODE] of [EXT REC CTRL] is set to [EXT ONLY]. [COLOR BAR] is set to [ON].
[MARKER]	[DATE REC] is set to [ON].
[LCD BL LEVEL], [VF B.LIGHT]	AC power source is being used.
[TC LINK]	Your camcorder is not connected to an external device via an i.LINK cable.
[TC COUNTUP]	[TC MAKE] is set to [REGENERATE].
[UB-DATE/TC-TIME]	[TC MAKE] is set to [REGENERATE]. [TC RUN] is set to [REC RUN]. [UB TIME REC] is set to [ON]. Date and time are not set.

Troubleshooting (Continued)

Cannot use	Situation
[WORLD TIME], [DATE REC]	Date and time are not set.
[x.v.Color]	[REC FORMAT] is set to [DV].
[ECS FREQ.]	The shutter speed is not set to the ECS .
[INTERVAL REC]	[REC CTL MODE] of [EXT REC CTRL] is set to [EXT ONLY]. [REC TYPE] of [HDV PROGRE.] is set to [PROGRESSIVE]. [REC TYPE] of [HDV PROGRE.] is set to [INTERLACE] and [SCAN TYPE] is set to [24], [24A] or [30]. [SCAN TYPE] of [DV PROGRE.] is set to [24] or [30].
[DV FRAME REC]	[REC CTL MODE] of [EXT REC CTRL] is set to [EXT ONLY]. When [REC FORMAT] is set to [HDV1080i]
[EXT REC CTRL]	[INTERVAL REC] is set to [ON]. [DV FRAME REC] is set to [ON].

Shutter speed, gain, white balance or iris cannot be adjusted manually.

- Set the AUTO/MANUAL switch to MANUAL.

Tiny spots in white, red, blue, or green appear on the screen.

- This phenomenon appears when using a slow shutter speed (p. 32). This is not a malfunction.

The subjects passing by the frame very fast appear crooked.

- This is called the focal plane phenomenon. This is not a malfunction. Because of the way that the image device (CMOS sensor) reads out image signals, the subjects passing by the frame rapidly might appear crooked depending on the recording conditions.

The screen picture is bright, and the subject does not appear on the screen.

- Set [BACK LIGHT] to [OFF].
- Set [HYPER GAIN] to [OFF].

The screen picture is dark, and the subject does not appear on the screen.

- Press and hold the DISPLAY/BATT INFO button for a few seconds to turn on the backlight (p. 18).

Horizontal stripes appear on the image.

- This occurs when recording pictures under a fluorescent lamp, sodium lamp, or mercury lamp. This is not a malfunction. This can be improved by changing the shutter speed (p. 32).

Black bands appear when you record a TV screen or computer screen.

- This can be improved by adjusting the shutter speed in the extended clear scan (ECS) range (p. 32).

Fine patterns flicker, diagonal lines look jagged.

- Adjust [DETAIL] to the negative side (p. 41).

Playback

If you are playing back pictures stored on a “Memory Stick Duo,” refer also to the Cassette tapes/“Memory Stick Duo” section (p. 107).

You cannot play back tape.

- Slide the POWER switch to VCR.
- Rewind the tape (p. 51).

Image data stored on a “Memory Stick Duo” cannot be played back correctly.

- Image data cannot be played back if you have modified file names or folders, or have edited the data on a computer (In this case, the file name flashes). This is not a malfunction (p. 123).
- Pictures recorded on other devices may not be played back correctly. This is not a malfunction.

The data file name is displayed incorrectly, or flashing.

- The file is damaged.
- The file format is not supported on your camcorder (p. 119).
- Only the file name is displayed if the folder structure does not conform to the universal standard.

Horizontal lines appear on the picture. The displayed pictures are not clear or do not appear.

- Video head is dirty. Clean the head using the cleaning cassette (optional) (p. 127).

You cannot hear the sound recorded with 4CH microphone recording on another camcorder.

- Set [DV AUDIO MIX] for the DVCAM (DV) format 4-ch recording (p. 79).
- You cannot reproduce the sound recorded in CH3 and CH4 on your camcorder for the HDV format 4-ch recording.

No sound or only a low sound is heard.

- Turn up the volume (p. 52).
- Set [DV AUDIO MIX] (p. 79).
- Pictures recorded using [SMTH SLW REC] do not have sounds.

The picture or sound breaks off.

- The tape was recorded in both of the HDV and DVCAM (DV) formats. This is not a malfunction.
-

The movies freeze for a while, or the sound breaks off.

- This occurs if the tape or video head is dirty (p. 127).
 - Use the Sony mini DV cassette tape.
-

“---” is displayed on the screen.

- The tape you are playing back was recorded without setting the date and time.
 - A blank section on the tape is being played back.
 - The data code on a tape with a scratch or noise cannot be read.
 - A movie recorded in the extended clear scan (ECS) range is being played back.
 - The tape you are playing was recorded with the gain set to -6dB.
 - The tape you are playing was recorded with [HYPER GAIN] set to [ON].
-

Noises appear and PAL or 50i is displayed on the screen.

- The tape was recorded in a TV color system other than that of your camcorder (NTSC). This is not a malfunction.
-

Date Search does not work correctly.

- Be sure to record more than 2 minutes after the date changed. If one day's recording is too short, your camcorder may not accurately find the point where the recording date changes.
 - There is a blank section between recorded sections of the tape. This is not a malfunction.
-

No picture appears during End search, Rec review or Last scene review.

- The tape was recorded in both HDV and DVCAM (DV) formats. This is not a malfunction.
-

New sound added to a recorded tape on another camcorder is not heard.



- Set [DV AUDIO MIX] from [CH1,CH2] (original sound) to [MIX] or [CH3,CH4] (p. 79).
-

2/2-ST appears on the LCD screen.

- This appears when you play back a tape recorded on other recording devices using a 4ch microphone. This camcorder does not comply with the 4ch microphone recording standard.

Connecting to TV

You cannot view the picture on the TV connected with the i.LINK cable.

- You cannot view the picture in the HD (high definition) quality on the TV if an i.LINK jack of the TV is not compatible with the HDV1080i specification (p. 58). Refer to the instruction manuals supplied with your TV.
- Down convert the pictures recorded in HDV format and play back in DVCAM (DV) format (SD image quality) (p. 87).
- Connect the TV with another connecting cable, and play back pictures (p. 58).

You cannot hear the sound on the TV connected with the S VIDEO plug (S VIDEO channel) or component video plugs.

- If you are using an S VIDEO plug or component video plugs, make sure the red and white plugs are also connected (p. 58).

You cannot view the picture or hear the sound on the TV connected with the component A/V cable.

- Set [COMPONENT] according to the requirements of the connected device (p. 87).
- When you are using the component A/V cable, make sure the red and white plugs are connected (p. 58).

You cannot view the picture or hear the sound on the TV connected with the HDMI cable.

- Pictures in the HDV format are not output from the HDMI OUT jack, if copyright protection signals are recorded in the pictures.
- DVCAM (DV) format pictures input to the camcorder via i.LINK cable (p. 100) cannot be output.
- This occurs if you record on a tape in both HDV and DVCAM (DV) formats. Disconnect and connect the HDMI cable, or slide the POWER switch to turn on your camcorder again.

The picture appears distorted on the 4:3 TV.

- This happens when viewing a picture recorded in 16:9 (wide) mode on a 4:3 TV. Select the down conversion type from one of the following menus, depending on the recording format.
 - If the recording format is HDV, select from [DOWN CONVERT] in [VIDEO OUT] (p. 87).
 - If the recording format is DVCAM (DV), select from [DV WIDE CONV] in [VIDEO OUT] (p. 87)

Black zone appears at top and bottom of a 4:3 TV screen.

- This happens when viewing a picture recorded in the 16:9 (wide) mode on a 4:3 TV. This is not a malfunction.

Dubbing/Editing/Connecting to other devices

Pictures from connected devices cannot be zoomed.

- You cannot zoom pictures from connected devices on your camcorder.

Time code and other information appear on the display of the connected device.

- Set [DISP OUTPUT] to [LCD PANEL] while connected with an A/V connecting cable (p. 84).

You cannot dub correctly using the A/V connecting cable.

- The A/V connecting cable is not connected properly.
Make sure that the A/V connecting cable is connected to the input jack of the other device for dubbing a picture from your camcorder.

When connected using an i.LINK cable, no picture appears on the monitor screen during dubbing.

- Set [VCR HDV/DV] according to the requirements of the connected device (p. 85).

You cannot add sound to the recorded tape.

- You cannot add sound to the recorded tape on this unit.

You cannot dub correctly using the HDMI cable.

- You cannot dub pictures using the HDMI cable.

When you copy a movie shot in wide (16:9) format using an i.LINK cable, the screen stretches vertically.

- You cannot output the aspect ratio setting using an i.LINK cable. Set the aspect ratio of the TV instead.
- Connect using an A/V connecting cable instead.

Connecting to a computer

The computer does not recognize your camcorder.

- Disconnect the cable from the computer, then connect it again securely.
 - Disconnect the cable from the computer, restart the computer, then connect the computer to your camcorder correctly.
-

You cannot view or copy a movie recorded on a tape to a computer.

- Disconnect the cable from the computer, then connect it again.
 - You need the editing software (optional) to copy a movie recorded on a tape to your computer (p. 102).
-

Your computer freezes.

- Set [VCR HDV/DV] correctly according to the connected device (p. 85).
- Disconnect the cable from your computer and camcorder. Reboot your computer, and connect your computer and camcorder following the steps in the correct order (p. 103).

Warning indicators and messages

Self-diagnosis display/Warning indicators

When an error occurs, a warning indicator appears on the LCD screen or in the viewfinder.

You can fix some problems associated with the symptoms yourself. If the problem persists even after you have tried a couple of times, contact your Sony dealer or local authorized Sony service facility.

C:(or E:) □□:□□ (Self-diagnosis display)

C:04:□□

- The battery pack is not an "InfoLITHIUM" battery pack. Use an "InfoLITHIUM" battery pack (p. 123).

C:06:□□

- The battery pack is too hot. Replace the battery pack, or remove it and put it in a cool place.

C:21:□□

- Moisture condensation has occurred. Remove the cassette and leave your camcorder for at least 1 hour, then reinsert the cassette (p. 126).

C:22:□□

- Clean the head using a cleaning cassette (optional) (p. 127).

C:31:□□ / C:32:□□

- Symptoms that are not described above have occurred. Remove and insert the cassette, then operate your camcorder again. Do not perform this procedure if moisture condensation has occurred (p. 126).
- Remove the power source. Reconnect it and operate your camcorder again.
- Change the cassette. Press the RESET button (p. 138), and operate your camcorder again.

E:61:□□ / E:62:□□

- Contact your Sony dealer or local authorized Sony service facility. Inform

them of the 5-digit code, which starts from "E."

101-1001(Warning indicator pertaining to files)

- The file is damaged.
- The file is unreadable (p. 123).

(Battery level warning)

- The battery pack is nearly used up.
- Depending on the operating environment, or battery conditions,  may flash, even if there are approximately 5 to 10 minutes remaining.

(Warning indicator pertaining to battery pack temperature)

- The battery pack is too hot. Replace the battery pack, or remove it and put it in a cool place.

(Moisture condensation warning)*

- Eject the cassette, remove the power source, and then leave it for about 1 hour with the cassette lid open (p. 126).

(Warning indicators pertaining to the tape)

Slow flashing:

- There is less than 5 minutes remaining on the tape.
- No cassette is inserted.*
- The write-protect tab on the cassette is set to lock (p. 119).*

Fast flashing:

- The tape has run out.*

▲ (Eject cassette warning)*

Slow flashing:

- The write-protect tab on the cassette is set to lock (p. 119).

Fast flashing:

- Moisture condensation has occurred (p. 126).
- The self-diagnosis display code is displayed (p. 116).

* When [BEEP] is set to [ON] (p. 94), you hear a melody when the warning indicators appear on the screen.

Warning messages

If messages appear on the screen, follow the instructions.

Using your camcorder abroad

Power supply

You can use your camcorder in any country/region using the AC Adaptor/Charger supplied with your camcorder within the AC 100 V to 240 V, 50/60 Hz range.

On TV color systems

Your camcorder is NTSC system, so its picture can only be viewed on an NTSC system TV with an AUDIO/VIDEO input jack.

System	Used in
NTSC	Bahama Islands, Bolivia, Canada, Central America, Chile, Colombia, Ecuador, Guyana, Jamaica, Japan, Korea, Mexico, Peru, Surinam, Taiwan, the Philippines, the U.S.A., Venezuela, etc.
PAL	Australia, Austria, Belgium, China, Czech Republic, Denmark, Finland, Germany, Holland, Hong Kong, Hungary, Italy, Kuwait, Malaysia, New Zealand, Norway, Poland, Portugal, Singapore, Slovak Republic, Spain, Sweden, Switzerland, Thailand, United Kingdom, etc.
PAL - M	Brazil
PAL - N	Argentina, Paraguay, Uruguay.
SECAM	Bulgaria, France, Guiana, Iran, Iraq, Monaco, Russia, Ukraine, etc.

Viewing HDV format pictures recorded in HDV format

You need an HDV1080i compatible TV (or monitor) with a component jack and AUDIO/VIDEO input jack or an HDMI jack. You also need a component A/V cable (supplied) or an HDMI cable (optional).

Viewing DVCAM (DV) format pictures recorded in DVCAM (DV) format

You need a TV with the AUDIO/VIDEO input jack. A connecting cable is also needed.

Simple setting of the clock by time difference

When you are abroad, you can easily adjust the clock to the local time by setting the time difference. Select [WORLD TIME], then set the time difference (p. 93).

Maintenance and precautions

HDV format and recording/ playback

Your camcorder is capable of recording in HDV/DVCAM/DV formats.

It is recommended to use a cassette with the Mini **DV** mark to record in the HDV/DVCAM/DV format.

It is recommended to use a cassette with the **DVCAM** mark to record in the DVCAM format.

Your camcorder is not compatible with the Cassette Memory function.

What is the HDV format?

The HDV format is a video format developed to record and play back digital high definition (HD) video signals on a DV cassette.

Your camcorder adopts the Interlace mode with 1,080 effective scan lines of screen ruling (1080i, number of pixels 1,440 × 1,080 dots).

The video bit rate for recording is about 25 Mbps.

i.LINK is adopted for the digital interface, enabling a digital connection with an HDV compatible TV or computer.

- HDV signals are compressed in MPEG2 format, which is adopted in BS (broadcast satellite) digital, terrestrial digital HDTV broadcastings, in Blu-ray Disc recorders, etc.

Playback

- Your camcorder can play back pictures in both the DVCAM (DV) format and HDV1080i specification.
- Your camcorder can play back pictures recorded in the HDV 720/30p format, but cannot output it from the **i** HDV/DV interface (i.LINK).

To prevent a blank section from being created on the tape

Go to the end of the recorded section using [END SEARCH] (p. 48) before you begin the next recording when you have played back the tape.

Copyright signal

■ When you play back

If the cassette you play back on your camcorder contains copyright signals, you cannot copy it to a tape in another video camera connected to your camcorder.

■ When you record

You cannot record software on your camcorder that contains copyright control signals for copyright protection of software. [Cannot record due to copyright protection.] appears on the LCD screen, or on the viewfinder if you try to record such software. Your camcorder does not record copyright control signals on the tape when it records.

Audio mode

The DVCAM format has 2 audio modes. You cannot dub sound onto a recorded tape with your camcorder.

■ FS32K (12-bit) mode

The original sound is recorded in channels 1 and 2, and the new sound in channels 3 and 4. The balance between channels 1/2 and channels 3/4 can be adjusted by selecting [DV AUDIO MIX] in the menu settings during playback. If you select [MIX], the sounds of channel 1/2 and channel 3/4 are synthesized to be output.

■ FS48K (16-bit) mode

The original sound can be recorded in high quality using 2 channels. The audio mode can be indicated on the LCD screen or in the viewfinder.

Notes on use

■ When not using your camcorder for a long time

Remove the cassette and store it.

Maintenance and precautions (Continued)

■ To prevent accidental erasure

Slide the write-protect tab on the cassette to set it to SAVE.



REC: The cassette can be recorded.

SAVE: The cassette cannot be recorded (write-protected).



■ When labeling the cassette

Be sure to place the label only on the locations shown in the following illustration so as not to cause a malfunction of your camcorder.

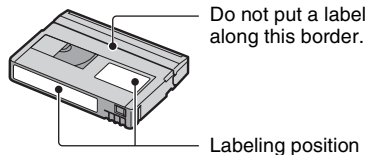

■ After using the cassette

Rewind the tape to the beginning to avoid distortion of the picture or the sound. The cassette should then be put in its case, and stored in an upright position.

■ When cleaning the gold-plated connector

Generally, clean the gold-plated connector on a cassette with a cotton-wool swab after every 10 times it has been ejected. If the gold-plated connector on the cassette is dirty or dusty, the remaining tape indicator may not show correctly.

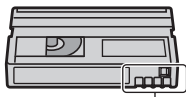

Gold-plated connector

On Sony HDV1080i compliant TVs

HDV1080i

An HDV format compatible TV with the component input jack is required to view playback pictures recorded in the HDV format.

Compatibility of the DVCAM/DV formats

The DVCAM format was developed as a more reliable and higher-end format than the consumer DV format. Explained here are the differences, compatibility, and limitations on editing for the DVCAM and DV formats. **NS** appears when the DVCAM standard is not met.

Differences between the DVCAM and DV formats

Specification	DVCAM	DV
TRACK Pitch	15 μ m	10 μ m
Audio sampling frequency	12 bit:32 kHz	12 bit:32 kHz 16 bit:48 kHz
Audio recording mode*	16 bit:48 kHz	44.1 kHz 48 kHz
Audio recording mode*	Lock mode	Lock/Unlock mode

* There are 2 modes for audio recording, lock mode and unlock mode. In lock mode, the sampling frequencies of audio and video are synchronized. Therefore, lock mode is more effective than unlock mode in digital processing and smooth transition during audio editing.

Mini DVCAM and mini DV cassettes

The recording format of the picture is defined according to the recorder's format as described below.

Recorder's format	Cassette's format	Recording format
DVCAM	DVCAM DV	DVCAM
DV	DVCAM DV	DV

Notes

- This camcorder complies with the DVCAM format. Though mini DV cassettes can be used for recording, we recommend you use mini DVCAM cassettes to get the most out of the high reliability of the DVCAM format.
- The recording time of mini DV cassettes is 1/3 shorter than that indicated on mini DV cassettes when recorded in the DVCAM format.

Compatibility on playback

Tape	On DV video equipment	On DVCAM video equipment
DV formatted	Can be played back	Can be played back only when recorded in SP mode
DVCAM formatted	Can be played back on some equipment	Can be played back

Compatibility on editing using DV jacks

When this camcorder is connected to other digital video equipment using an i.LINK cable, the recording format of edited tapes is defined according to the source tape and the recorder's format as described below. Playback or editing using the edited tape may be limited depending on dubbing operation. Start dubbing after reading "Limitations on editing" (p. 122).

Source tape	Player's format	Recorder's format	Recording format
DV formatted (SP mode only)	DVCAM	DVCAM DV	DVCAM ¹⁾ DV
DV formatted	DV	DVCAM DV	DVCAM DV
DVCAM formatted ²⁾	DVCAM	DVCAM DV	DVCAM DV
DVCAM formatted ²⁾	DV ³⁾	DVCAM DV	DVCAM (Compatibility depends on models.) DV DV

¹⁾ When using mini DVCAM video equipment to perform DV dubbing of a tape recorded in DV format, the tape produced will be in the DVCAM format which the time code format will be partly misadjusted. (there will be no effect on the recorded picture except in certain cases.)

²⁾ If the tape that is to be dubbed is in the DVCAM format as in 1), the tape produced will be in the DVCAM format and the time code format will be partly misadjusted.

³⁾ Some mini DV video equipment may be able to play back a DVCAM-formatted tape. Even if the tape is played back, quality of the playback cannot be guaranteed. The time code format will be partly misadjusted.

Maintenance and precautions (Continued)

Notes

- If you use tapes as in 1) to 3) above for editing, the functions may be limited regardless of the format of players and recorders.

Limitations on editing

You may find the following limitations when editing a tape produced by dubbing or editing using the HDV/DV Interface

 (i.LINK) jack:

- Due to the difference in track pitch, you cannot record or edit on DV-formatted tapes using mini DVCAM video equipment.
- Depending on the DVCAM video equipment used, you may not be able to edit DVCAM formatted tapes if the audio recording mode is unlock mode. In this case, dub using audio/video jacks.

About the “Memory Stick”

A “Memory Stick” is a compact, portable IC recording medium with a large data capacity.

You can use the following types of “Memory Stick” listed below on the camcorder. However, we do not guarantee the operation of all types of “Memory Stick” on your camcorder. (See the list below for more details.)

Types of “Memory Stick”	Recording /Playback
“Memory Stick Duo” (with MagicGate)	○
“Memory Stick PRO Duo”	○
“Memory Stick PRO-HG Duo”	○

- This product does not support high speed data transfer via a parallel interface.
- This product cannot record or play data that uses “MagicGate” technology. “MagicGate” is a copyright protection technology that records and transfers the contents in an encrypted format.
- This product is compatible with “Memory Stick Micro” (“M2”). “M2” is the abbreviation for the “Memory Stick Micro.”
- Still image format: Your camcorder compresses and records image data in the JPEG (Joint

Photographic Experts Group) format. The file extension is “.JPG.”

- A “Memory Stick Duo” formatted by a computer (Windows OS/Mac OS) does not have guaranteed compatibility with your camcorder.
- Data read/write speed may vary depending on the combination of the “Memory Stick Duo” and “Memory Stick Duo” compliant product you use.
- You can prevent accidental erasure of images when you slide the write-protect tab on the “Memory Stick Duo” with a small tapered object, to the write-protect position.
- Damaged or lost image data will not be compensated for, and may occur in the following cases:
 - If you eject the “Memory Stick Duo,” turn the power off on your camcorder, or remove the battery pack for replacement while your camcorder is reading or writing image files on the “Memory Stick Duo” (while the access lamp is lit or flashing).
 - If you use the “Memory Stick Duo” near magnets or magnetic fields.
- It is recommended to make a back-up of important data on the hard disk of a computer.
- Be careful not to apply excessive force when writing on a memo area on a “Memory Stick Duo.”
- Do not attach a label or the like on a “Memory Stick Duo” or a “Memory Stick Duo” adaptor.
- When you carry or store a “Memory Stick Duo,” put it in its case.
- Do not touch, or allow metallic objects to come into contact with the terminals.
- Do not bend, drop or apply strong force to the “Memory Stick Duo.”
- Do not disassemble or modify the “Memory Stick Duo.”
- Do not let the “Memory Stick Duo” get wet.
- Be careful to keep “Memory Stick Duo” media out of the reach of small children. There is danger that a child might swallow it.
- Do not insert anything other than a “Memory Stick Duo” into the “Memory Stick Duo” slot. Doing so may cause a malfunction.
- Do not use or keep the “Memory Stick Duo” in the following locations:
 - Places subject to extremely high temperature, such as a car parked outside in the summer.
 - Places under direct sunlight.

- Places with extremely high humidity or subject to corrosive gases.

■ On the “Memory Stick Duo” adaptor

- When using a “Memory Stick Duo” with a “Memory Stick” compliant device, make sure to insert the “Memory Stick Duo” into a “Memory Stick Duo” adaptor.
- When inserting a “Memory Stick Duo” into a “Memory Stick Duo” adaptor, make sure the “Memory Stick Duo” is inserted facing in the correct direction, then insert it all the way in. Note that improper use may cause a malfunction. Also, if you force the “Memory Stick Duo” into the “Memory Stick Duo” adaptor in the wrong direction, it may be damaged.
- Do not insert a “Memory Stick Duo” adaptor without a “Memory Stick Duo” attached. Doing so may result in malfunctions of the unit.

■ On a “Memory Stick PRO Duo”

- The maximum memory capacity of a “Memory Stick PRO Duo” that can be used on your camcorder is 16 GB.
- This unit does not support high speed data transfer.

Notes on using “Memory Stick Micro”

- To use a “Memory Stick Micro” with the camcorder, you need a Duo-sized M2 Adaptor. Insert the “Memory Stick Micro” into the Duo-sized M2 Adaptor, then insert the adaptor into the “Memory Stick Duo” slot. If you insert a “Memory Stick Micro” into the camcorder without using a Duo-sized M2 Adaptor, you might not be able to remove it from the camcorder.
- Do not leave the “Memory Stick Micro” within the reach of small children. They might accidentally swallow it.

On image data compatibility

- Image data files recorded on a “Memory Stick Duo” by your camcorder conform to the “Design rule for Camera File system” universal standard established by the JEITA (Japan Electronics and Information Technology Industries Association).
- On your camcorder, you cannot play back still images recorded on other devices (DCR-TRV900 or DSC-D700/D770) that do not

conform to the universal standard. (These models are not sold in some regions.)

- If you cannot use a “Memory Stick Duo” that has been used with another device, format it with your camcorder (p. 91). Note that formatting erases all information on the “Memory Stick Duo.”
- You may not be able to play back images with your camcorder:
 - When playing back image data modified on your computer.
 - When playing back image data recorded with other devices.

About the “InfoLITHIUM” battery pack

This unit is compatible with an “InfoLITHIUM” battery pack (L series). Your camcorder operates only with an “InfoLITHIUM” battery pack. “InfoLITHIUM” L series battery packs have the  mark.

What is an “InfoLITHIUM” battery pack?

An “InfoLITHIUM” battery pack is a lithium-ion battery pack that has functions for communicating information related to operating conditions between your camcorder and a supplied AC Adaptor/Charger.

The “InfoLITHIUM” battery pack calculates the power consumption according to the operating conditions of your camcorder, and displays the remaining battery time in minutes.

With an AC Adaptor/Charger, the remaining battery time and charging time appear.

To charge the battery pack

- Be sure to charge the battery pack before you start using your camcorder.
- We recommend charging the battery pack in an ambient temperature of between 10 °C to 30 °C (50 °F to 86 °F) until the charge lamp of the AC Adaptor/Charger turns off. If you charge the

Maintenance and precautions (Continued)

battery pack outside of this temperature range, you may not be able to charge it efficiently.

To use the battery pack effectively

- Battery pack performance decreases when the surrounding temperature is 10 °C (50 °F) or below, and the length of time you can use the battery pack becomes shorter. In that case, do one of the following to use the battery pack for a longer time.
 - Put the battery pack in a pocket to warm it up, and insert it in your camcorder right before you start taking shots.
 - Use a large capacity battery pack: NP-F770/F970 (optional).
- Frequent use of the LCD screen or a frequent playback, fast forward or rewind operation wears out the battery pack faster. We recommend using a large capacity battery pack: NP-F770/F970.
- Be sure to set the POWER switch to OFF when not recording or playing back on your camcorder. The battery pack is also consumed when your camcorder is in recording standby or playback pause.
- Have spare battery packs ready for two or three times the expected recording time, and make trial recordings before making the actual recording.
- Do not expose the battery pack to water. The battery pack is not water resistant.

About the remaining battery time indicator

- When the power goes off even though the remaining battery time indicator indicates that the battery pack has enough power to operate, charge the battery pack fully again. Remaining battery time will be indicated correctly. Note, however, that the battery indication will not be restored if it is used in high temperatures for a long time, or if left in a fully charged state, or when the battery pack is frequently used. Use the remaining battery time indication as a rough guide only.
- The  mark that indicates low battery flashes even if there are still 5 to 10 minutes of battery time remaining, depending on the operating conditions or ambient temperature.

About storage of the battery pack

- If the battery pack is not used for a long time, fully charge the battery pack and use it up on your camcorder once a year to maintain proper function. To store the battery pack, remove it from your camcorder and put it in a dry, cool place.
- To discharge the battery pack on your camcorder completely, leave your camcorder in tape recording standby until the power goes off (p. 17).

About battery life

- Battery capacity decreases over time and through repeated use. If decreased usage time between charges becomes significant, it is probably time to replace it with a new one.
- Each battery's life is governed by storage, operating and environmental conditions.

About i.LINK

The  HDV/DV (i.LINK) jack on your camcorder is an i.LINK-compliant 4-pin jack. This section describes the i.LINK standard and its features.

What is i.LINK?

i.LINK is a digital serial interface for transferring digital video, digital audio, and other data to other i.LINK-compatible devices. You can also control other devices using the i.LINK.

i.LINK-compatible devices can be connected using an i.LINK cable. Possible applications are operations and data transactions with various digital AV devices.

When two or more i.LINK-compatible devices are daisy-chained with the unit, operation becomes possible from any device in the chain. Note that operation method may vary, or data transactions may not be possible, depending on specifications and characteristics of the connected devices.

Notes

- Normally, only one device can be connected to this unit with an i.LINK cable. When connecting this unit to an HDV/DV compatible device having two or more i.LINK HDV/DV interfaces, refer to the operating instructions of the device to be connected.
- i.LINK is a more familiar term for the IEEE 1394 data transport bus proposed by Sony, and is a trademark approved by many corporations.
- IEEE 1394 is an international standard standardized by the Institute of Electrical and Electronics Engineers.

About the i.LINK Baud rate

i.LINK's maximum baud rate varies according to the device. There are 3 types.

S100 (approx. 100Mbps*)
S200 (approx. 200Mbps)
S400 (approx. 400Mbps)

The baud rate is listed under "Specifications" in the operating instructions of each piece of equipment. It is also indicated near the i.LINK interface on some devices.

The baud rate may differ from the indicated value when the unit is connected to a device with a different maximum baud rate.

* What is Mbps?

Mbps stands for "megabits per second," or the amount of data that can be sent or received in one second. For example, a baud rate of 100 Mbps means that 100 megabits of data can be sent in one second.

To use i.LINK functions on this unit

For details on how to dub when this unit is connected to other video devices having an i.LINK interface, see page 99.

This unit can also be connected to other i.LINK-compatible devices made by Sony (for example, a VAIO series personal computer) as well as to video devices. Some i.LINK compatible video devices, such as Digital Televisions, DVD, MICROMV or HDV recorders/players are

not compatible with this unit. Before connecting to other devices, be sure to confirm whether the device is compatible with an HDV/DV device or not. For details on precautions and compatible application software, refer also to the operating instructions for the device to be connected.

Notes

- When connecting a device with an i.LINK terminal to your camcorder via an i.LINK cable, switch off the device and unplug it from the power socket before plugging in or unplugging the i.LINK cable.

About x.v.Color

- x.v.Color is a more familiar term for the xvYCC standard proposed by Sony, and is a trademark of Sony.
- xvYCC is an international standard for color space in video. This standard can express a wider color range than the currently used broadcast standard.

About handling of your camcorder

On use and care

- Do not use or store the camcorder and accessories in the following locations.
 - Anywhere extremely hot or cold. Never leave them exposed to temperatures above 60 °C (140 °F), such as under direct sunlight, near heaters or in a car parked in the sun. They may malfunction or become deformed.
 - Near strong magnetic fields or mechanical vibration. The camcorder may malfunction.
 - Near strong radio waves or radiation. The camcorder may not be able to record properly.
 - Near AM receivers and video equipment. Noise may occur.
 - On a sandy beach or anywhere dusty. If sand or dust gets in your camcorder, it may malfunction. Sometimes this malfunction cannot be repaired.
 - Near windows or outdoors, where the LCD screen, the viewfinder, or the lens may be

Maintenance and precautions (Continued)

exposed to direct sunlight. This damages the inside of the viewfinder or the LCD screen.

- Anywhere very humid.
- Operate your camcorder on DC 7.2 V (battery pack) or DC 8.4 V (AC Adaptor).
- For DC or AC operation, use the accessories recommended in these operating instructions.
- Do not let your camcorder get wet, for example, from rain or sea water. If your camcorder gets wet, it may malfunction. Sometimes this malfunction cannot be repaired.
- If any solid object or liquid gets inside the casing, unplug your camcorder and have it checked by a Sony dealer before operating it any further.
- Avoid rough handling, disassembling, modifying, physical shock, or impact such as hammering, dropping or stepping on the product. Be particularly careful of the lens.
- Do not use a deformed or damaged battery pack.
- Keep the POWER switch setting to OFF when you are not using your camcorder.
- Do not wrap your camcorder with a towel, for example, and operate it. Doing so might cause heat to build up inside.
- When disconnecting the power cord (mains lead), pull it by the plug and not the lead.
- Do not damage the power cord (mains lead) such as by placing anything heavy on it.
- Keep metal contacts clean.
- Keep the Remote Commander and button-type battery out of children's reach. If the battery is accidentally swallowed, consult a doctor immediately.
- If the battery electrolytic liquid has leaked,
 - consult your local authorized Sony service facility.
 - wash off any liquid that may have contacted your skin.
 - if any liquid gets in your eyes, wash with plenty of water and consult a doctor.

■ When not using your camcorder for a long time



- Periodically turn on the camcorder and play a cassette for about 3 minutes.
- Use up the battery pack completely before storing it.

Moisture condensation

If your camcorder is brought directly from a cold place to a warm place, moisture may condense inside your camcorder, on the surface of the tape, or on the lens. In this state, the tape may stick to the head drum and be damaged or your camcorder may not operate correctly. If there is moisture inside your camcorder, [Moisture condensation. Eject the cassette] or [Moisture condensation. Turn off for 1H.] appears. The indicator will not appear when the moisture condenses on the lens.

■ If moisture condensation has occurred

None of the functions except cassette ejection will work. Eject the cassette, turn off your camcorder, and leave it for about one hour with the cassette lid open. Your camcorder can be used again when both of the following conditions are met:

- The warning message does not appear when the power is turned on.
- Neither  nor  flashes when a cassette is inserted and the video operation buttons are pressed.

If moisture starts to condense, your camcorder sometimes cannot detect condensation. If this happens, the cassette is sometimes not ejected for 10 seconds after the cassette lid is opened. This is not a malfunction. Do not close the cassette lid until the cassette is ejected.

■ Note on moisture condensation

Moisture may condense when you bring your camcorder from a cold place into a warm place (or vice versa) or when you use your camcorder in a humid place as shown below.

- When you bring your camcorder from a ski slope into a place warmed up by a heating device.
- When you bring your camcorder from an air conditioned car or room into a hot place outside.
- When you use your camcorder after a squall or a shower.
- When you use your camcorder in a hot and humid place.

■ How to avoid moisture condensation

When you bring your camcorder from a cold place into a warm place, put your camcorder in a plastic bag and seal it tightly. Remove the bag when the air temperature inside the plastic bag has reached the surrounding temperature (after about one hour).

Video head

If you play back a tape recorded in HDV format, the image and sound may freeze for a while (about 0.5 seconds).

This occurs if the HDV signals cannot be recorded or played back correctly because of dirt on the tape or video head. Depending on the cassette, this fairly infrequently occurs even if the cassette is brand new or is not used a lot.

If this freezing point is created while playing back, you can solve this problem and see the pictures by rewinding after slightly forwarding. Such a freezing point cannot be recovered if it was created while recording.

To prevent such a problem, use the Sony mini DV cassette.

- If the following problem occurs, clean the video heads for 10 seconds with the Sony cleaning cassette (optional).
 - Playback pictures do not move.
 - Playback pictures do not appear.
 - The sound breaks off.
 -  Dirty video head. Use a cleaning cassette.] appears on the screen during recording.
 - The following phenomenon occurs in HDV format.



The playback screen pauses.



The playback screen goes blank. (Solid blue screen)

- The following phenomenon occurs in DVCAM (DV) format.



Block-noise appears.



The playback screen goes blank. (Solid blue screen)

- The video heads will be worn after long use. If you cannot obtain a clear image even after using a cleaning cassette (optional), the video heads may be worn out. Please contact your Sony dealer or local authorized Sony service facility to have the video heads replaced.

LCD screen

- Do not exert excessive pressure on the LCD screen, as it may cause damage.
- If your camcorder is used in a cold place, a residual image may appear on the LCD screen. This is not a malfunction.
- While using your camcorder, the back of the LCD screen may heat up. This is not a malfunction.

■ To clean the LCD screen

If fingerprints or dust make the LCD screen dirty, it is recommended you use a soft cloth to clean it. When you use the LCD Cleaning Kit (optional), do not apply the cleaning liquid directly to the LCD screen. Use cleaning paper moistened with the liquid.

On handling the casing

- If the casing is soiled, clean the camcorder body with a soft cloth lightly moistened with water, and then wipe the casing with a dry soft cloth.
- Avoid the following to avoid damage to the finish.
 - Using chemicals such as thinner, benzene, alcohol, chemical cloths, repellent, insecticide and sunscreen.

Maintenance and precautions (Continued)

- Handling with above substances on your hands.
- Leaving the casing in contact with rubber or vinyl objects for a long period of time.

About care and storage of the lens

- Wipe the surface of the lens clean with a soft cloth in the following instances:
 - When there are fingerprints on the lens surface.
 - In hot or humid locations
 - When the lens is exposed to salty air such as at the seaside.
- Store in a well-ventilated location subject to little dirt or dust.
- To prevent mold, periodically clean the lens as described above. It is recommended that you operate your camcorder about once a month to keep it in optimum state for a long time.

On charging the pre-installed rechargeable battery

Your camcorder has a pre-installed rechargeable battery to retain the date, time, and other settings even when the POWER switch is set to OFF. The pre-installed rechargeable battery is always charged while your camcorder is connected to the wall outlet (wall socket) via the AC Adaptor/Charger or while the battery pack is inserted. The rechargeable battery will be fully discharged in about **3 months** if you do not use your camcorder at all without the AC Adaptor/Charger connected or the battery pack attached. Use your camcorder after charging the pre-installed rechargeable battery.

However, even if the pre-installed rechargeable battery is not charged, the camcorder operation will not be affected as long as you are not recording the date.

■ Procedures

Connect your camcorder to a wall outlet (wall socket) using the supplied AC Adaptor/Charger, and leave it with the POWER switch set to OFF for more than 24 hours.

Removing dust from inside the viewfinder

1 Remove the eye piece of the viewfinder.

Slide down the viewfinder release lever and hold it at the position (①), then lift the eye piece of the viewfinder as indicated with the arrow in the illustration (②).

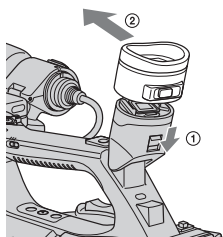

2 Remove dust inside the eye piece and viewfinder with a blower.

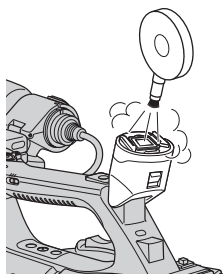

Specifications

System

Video recording system (HDV)

2 rotary heads, Helical scanning system

Video recording system (DVCAM (DV))

2 rotary heads, Helical scanning system

Still image recording system

Exif Ver. 2.2*

Audio recording system (HDV)

Rotary heads, MPEG-1 Audio Layer-2,

Quantization: 16 bits

Fs48kHz (stereo)

transfer rate: 384 kbps

Audio recording system (DVCAM (DV))

Rotary heads, PCM system

Quantization: 12 bits

Fs32kHz (channel 1/2 stereo),

Quantization: 16 bits



Fs48kHz (channel 1/2 stereo)

Video signal

NTSC color, EIA standards

1080/60i specification

Usable cassette

Mini DV cassette with the  mark printed or Mini DVCAM cassette with the  mark printed

Tape speed (HDV)

Approx. 18.812 mm/s

Tape speed (DVCAM)

Approx. 28.193 mm/s

Tape speed (DV SP)

Approx. 18.812 mm/s

Recording/playback time (HDV)

63 min (using a PHDVM-63DM cassette)

Recording/playback time (DVCAM)

41 min (using a PHDVM-63DM cassette)

Recording/playback time (DV SP)

63 min (using a PHDVM-63DM cassette)

Fast forward/rewind time

Approx. 2 min 40 s (using a PHDVM-63DM cassette and rechargeable battery pack)

Approx. 1 min 45 s (using a PHDVM-63DM cassette and AC Adaptor/Charger)

Viewfinder

Electric viewfinder (color, black and white)

Picture

1.1 cm (0.45 type, aspect ratio 16:9)

Total dot number

1 226 880 (approx. $852 \times 3[\text{RGB}] \times 480$)

Image device

6.0 mm (1/3 type) 3CMOS sensor
Recording Pixels (HDV/DV16:9 still recording):

Max. 1.20 Mega (1 440 × 810) pixels**

Gross: Approx. 1 120 000 pixels

Effective (movie, 16:9):

Approx. 1 037 000 pixels

Effective (movie, 4:3):

Approx. 778 000 pixels

Effective (still, 16:9):

Approx. 1 037 000 pixels

Effective (still, 4:3):

Approx. 778 000 pixels

Lens

G Lens

20 × (Optical), Approx. 30 × (Digital, when [D.EXTENDER] is set to [ON])

Focal length

f=4.1 - 82.0 mm (3/16 - 3 1/4 in.)

When converted to a 35 mm still camera

29.5 - 590 mm (1 3/16 - 23 1/4 in.) (16:9),

36.1 - 722 mm (1 7/16 - 28 1/2 in.) (4:3)

F1.6 - 3.4

Filter diameter: 72 mm (2 7/8 in.)

Specifications (Continued)

Color temperature

[AUTO]

 (one push) A/B

[INDOOR] (3 200K)

[OUTDOOR] (5 800K±7 offset levels)

[MANU WB TEMP] (2 300K -

15 000K in 100K steps)

Minimum illumination

1.5 lx (lux) (Fixed Shutter Speed 1/30, auto gain, auto iris) (F 1.6)

* "Exif" is a file format for still images, established by the JEITA (Japan Electronics and Information Technology Industries Association). Files in this format can have additional information such as your camcorder's setting information at the time of recording.

**The unique pixel array of Sony's ClearVid CMOS sensor and image processing system (Enhanced Imaging Processor) allows for still image resolution equivalent to the sizes described.

Output connectors

A/V Remote Connector

10-pin connector

When A/V connecting cable is connected

Video signal: 1 Vp-p, 75 Ω(ohms)

Luminance signal: 1 Vp-p, 75 Ω(ohms)

Chrominance signal: 0.286 Vp-p (burst signal), 75 Ω(ohms)

When component A/V cable is connected

Y: 1 Vp-p, 75 Ω(ohms), PB/PR, CB/CR: +/- 350 mV, 75 Ω(ohms)

Audio signal: -10 dBu (at load impedance 47 kΩ(kilohms)), Output impedance with less than 2.2 kΩ(kilohms)

(0 dBu=0.775 Vrms)

HDMI OUT jack

TypeA (19-pin)

(headphones) jack

Stereo-minijack (Ø 3.5 mm)

Input/Output connectors

LANC jack

Stereo mini-minijack (Ø 2.5 mm)

INPUT1/INPUT2 jack

XLR 3-pin, female,
-48 dBu: 3kΩ(kilohms)
+4 dBu: 10kΩ(kilohms)
(0 dBu=0.775 Vrms)

i.LINK DV jack

i.LINK interface (IEEE 1394, 4-pin connector S100)

LCD screen

Picture

8.0 cm (3.2 type, aspect ratio 16:9)

Total dot number

921 600 (1 920 × 480)

General

Power requirements

DC 7.2 V (battery pack)

DC 8.4 V (AC Adaptor/Charger)

Average power consumption*

During camera recording using the microphone ECM-XM1 and viewfinder with normal brightness:

HDV recording 7.1 W

DVCAM (DV) recording 6.8 W

During camera recording using the microphone ECM-XM1 and LCD with normal brightness:

HDV recording 7.3 W

DVCAM (DV) recording 7.0 W

Operating temperature

0 °C to 40 °C (32 °F to 104 °F)

Storage temperature

-20 °C to +60 °C (-4 °F to +140 °F)

Dimensions (approx.)**HVR-Z5U:**

169 × 188 × 451 mm
 (6 3/4 × 7 1/2 × 17 7/8 in.)
 (w/h/d)

including the projecting parts

169 × 188 × 451 mm
 (6 3/4 × 7 1/2 × 17 7/8 in.)
 (w/h/d)

including the projecting parts with the
 battery pack (NP-F770)

HVR-Z5N:

169 × 188 × 451 mm
 (6 3/4 × 7 1/2 × 17 7/8 in.)
 (w/h/d)

including the projecting parts

169 × 188 × 451 mm
 (6 3/4 × 7 1/2 × 17 7/8 in.)
 (w/h/d)

including the projecting parts with the
 battery pack (NP-F570)

Mass (approx.)**HVR-Z5U:**

2.2 kg (5 lb 1 oz) including the lens
 hood with lens cover
 2.6 kg (5 lb 10 oz) including the battery
 pack (NP-F770), cassette (PHDVM-
 63DM), lens hood with lens cover and
 microphone (ECM-XM1)

HVR-Z5N:

2.2 kg (5 lb 1 oz) including the lens
 hood with lens cover
 2.5 kg (5 lb 6 oz) including the battery
 pack (NP-F570), cassette (PHDVM-
 63DM), lens hood with lens cover and
 microphone (ECM-XM1)

* When the HVR-MRC1 is used, the average
 power consumption increases about 2.5 W.

AC Adaptor/Charger AC-VQ1050**Power requirements**

AC 100 V - 240 V, 50 Hz/60 Hz

Power consumption

22 W

Output voltage

DC 8.4 V*

Operating temperature

0 °C to 40 °C (32 °F to 104 °F)

Storage temperature

-20 °C to +60 °C (-4 °F to +140 °F)

Dimensions (approx.)

123 × 53 × 135 mm
 (4 7/8 × 2 1/8 × 5 3/8 in.) (w/h/d)
 excluding the projecting parts

Mass (approx.)

390 g (13.8 oz) excluding the power
 cord (mains lead)

* See the label on the AC Adaptor/Charger for
 other specifications.

**Rechargeable battery pack NP-F770
(supplied with HVR-Z5U)****Maximum output voltage**

DC 8.4 V

Output voltage

DC 7.2 V

Maximum charge voltage

DC 8.4 V

Maximum charge current

3.0 A

Capacity

31.7 Wh (4 400 mAh)

Type

Li-ion

**Rechargeable battery pack NP-F570
(supplied with HVR-Z5N)**

Maximum output voltage

DC 8.4 V

Output voltage

DC 7.2 V

Maximum charge voltage

DC 8.4 V

Maximum charge current

3.0 A

Capacity

15.8 Wh (2 200 mAh)

Type

Li-ion

Design and specifications are subject to change
without notice.

On trademarks

- “Memory Stick,”  “Memory Stick Duo,” “**MEMORY STICK DUO**,” “Memory Stick PRO Duo,” “**MEMORY STICK PRO DUO**,” “Memory Stick PRO-HG Duo,” “**MEMORY STICK PRO-HG DUO**,” “Memory Stick Micro,” “MagicGate,” “**MAGIC GATE**,” “MagicGate Memory Stick” and “MagicGate Memory Stick Duo” are trademarks of Sony Corporation.
- “InfoLITHIUM” is a trademark of Sony Corporation.
-  is a trademark of Sony Corporation.
- “x.v.Color” is a trademark of Sony Corporation.
- i.LINK and  are trademarks of Sony Corporation.
- Mini  Digital Video Cassette is a trademark.
-  is a trademark.
- Microsoft, Windows, Windows Vista, and Windows Media are trademarks or registered trademarks of U.S. Microsoft Corporation in the U.S. and other countries.
- Macintosh and Mac OS are registered trademarks of Apple Inc. in the U.S. and other countries.
- HDV and the HDV logo are trademarks of Sony Corporation and Victor Company of Japan, Ltd.
- HDMI, HDMI logo, and High-Definition Multimedia Interface are trademarks or registered trademarks of HDMI Licensing LLC.
- Pentium is a trademark or registered trademark of Intel Corporation.
- Adobe, and Adobe Reader are trademarks of Adobe Systems Incorporated.

All other product names mentioned herein may be the trademarks or registered trademarks of their respective companies. Furthermore, TM and “®” are not mentioned in each case in this manual.

Notes on the License

ANY USE OF THIS PRODUCT OTHER THAN CONSUMER PERSONAL USE IN ANY MANNER THAT COMPLIES WITH THE MPEG-2 STANDARD FOR ENCODING VIDEO INFORMATION FOR PACKAGED MEDIA IS EXPRESSLY PROHIBITED WITHOUT A LICENSE UNDER APPLICABLE PATENTS IN THE MPEG-2 PATENT PORTFOLIO, WHICH LICENSE IS AVAILABLE FROM MPEG LA, L.L.C., 250 STEELE STREET, SUITE 300, DENVER, COLORADO 80206.

Identifying parts and controls

The numbers in () are reference pages.

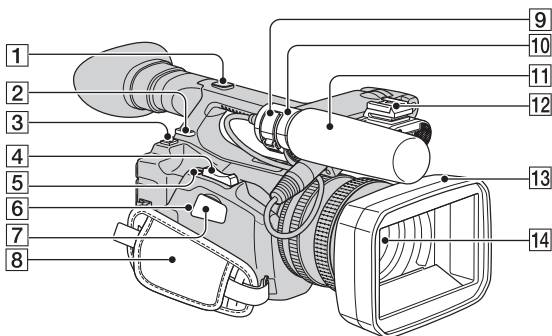

- | | |
|--|--|
| 1 Accessory shoe mount (134) | 8 Grip belt (17) |
| 2 Hook for shoulder strap (137) | 9 Microphone fixing clammer (10) |
| 3 BATT RELEASE button (14) | 10 Microphone holder (10) |
| 4 Zoom lever (28) | 11 Microphone (10) |
| 5 ASSIGN 7/PHOTO button (26) | 12 Accessory shoe (134) |
| 6 Access lamp (23) | 13 Lens hood with lens cover (12) |
| 7 "Memory Stick Duo" slot (22) | 14 Lens (12) |

To mount the accessory shoe

Mount the accessory shoe on the accessory shoe mount as illustrated.

Accessory shoe plate

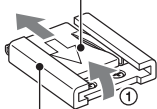

Accessory shoe

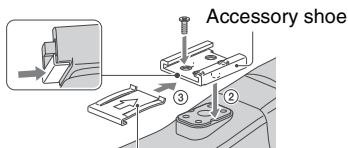

Accessory shoe plate

- ① Lift the edge of the accessory shoe plate and pull it in the direction opposite to that of the arrow on the accessory shoe plate and remove it from the accessory shoe.
- ② Place the accessory shoe as its protrusions matches recesses of the accessory shoe mount, then fix it to the mount with four screws.
- ③ Insert the accessory shoe plate in the direction of the arrow on the plate surface until the end of the plate engages the end of the shoe.

To remove the accessory shoe

Remove the shoe plate in the same way as step ① of "To mount the accessory shoe." Loosen the 4 screws and remove the accessory shoe from the accessory shoe mount.

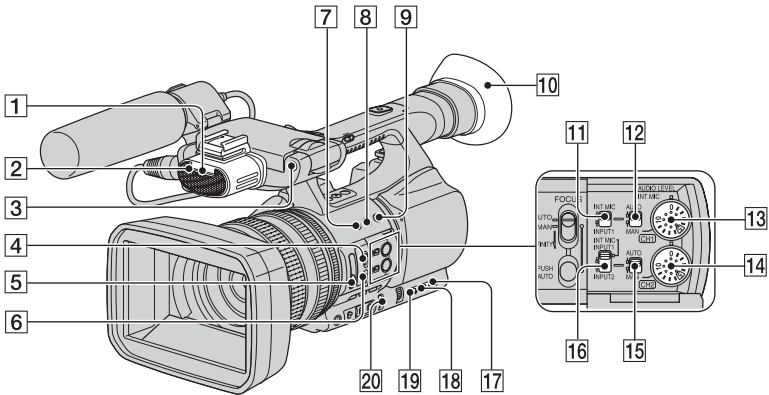

- 1** Front recording lamp (94)
The recording lamp flashes if the remaining tape or battery is low.
- 2** Internal microphone (10)
- 3** Front remote sensor (94)
- 4** FOCUS switch (29)
- 5** ND filter (33)
- 6** PUSH AUTO button (29)
- 7** ASSIGN 1 button/ZEBRA button (46)
- 8** ASSIGN 2 button/AE SHIFT button* (46)
- 9** ASSIGN 3 button/REC REVIEW button (46)
- 10** Large eyecup (19)
- 11** CH1 (INT MIC/INPUT1) switch (44)
- 12** AUTO/MAN (CH1) switch (44)
- 13** AUDIO LEVEL(CH1) dial (44)
- 14** AUDIO LEVEL(CH2) dial (44)
- 15** AUTO/MAN (CH2) switch (44)
- 16** CH2 (INT MIC/INPUT1/INPUT2) switch (44)
- 17** STATUS CHECK button (55)

18 PICTURE PROFILE button (35)





19 MENU button (20)

20 AUTO/MANUAL switch (30)

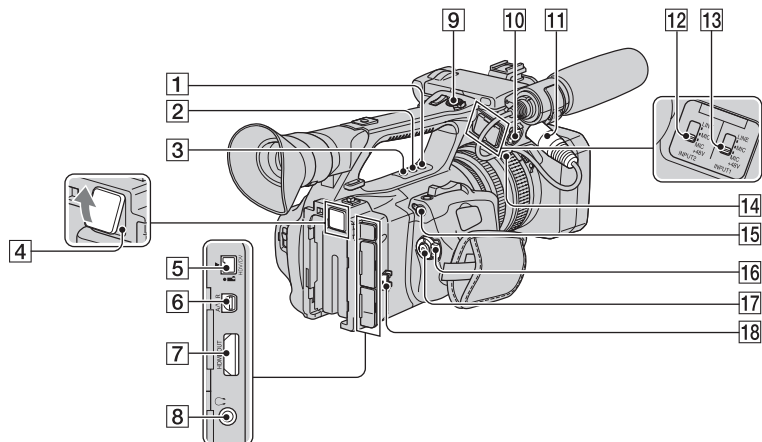
* The ASSIGN 2 button /AE SHIFT button has a raised tactile dot for your convenience in locating the button.





Identifying parts and controls (Continued)

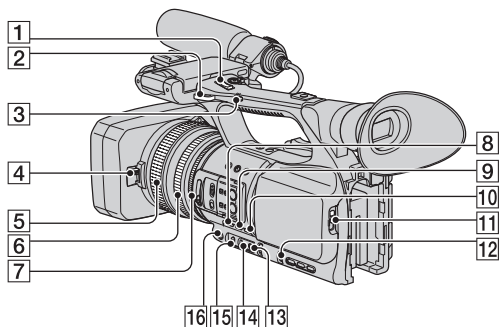

- 1** ASSIGN 4 button (46)
- 2** ASSIGN 5 button* (46)
- 3** ASSIGN 6 button (46)
- 4** Memory Recording Unit jack (44)
For an optional memory recording unit (HVR-DR60 or HVR-MRC1)
- 5**  HDV/DV jack (58)
- 6** A/V Remote Connector (58)
- 7** HDMI OUT jack (58)
- 8**  (headphones) jack
For stereo mini-jack headphones
- 9** REC START/STOP button (24)
- 10** INPUT2 jack (10)
- 11** INPUT1 jack (10)
- 12** INPUT2 switch (44)
- 13** INPUT1 switch (44)
- 14** Cable holder (10)
Inner cable holder and outer cable holder are provided for securing an i.LINK cable and a microphone cable, respectively.
- 15** LANC  jack
The LANC  control jack is used for controlling the tape transport of video device and peripherals connected to it.
- 16** POWER switch (17)
- 17** REC START/STOP button (24)
- 18** Cable holder (10)
For securing the i.LINK cable or other cables

* The ASSIGN 5 button has a raised tactile dot for your convenience in locating the button.



- 1 Handle zoom lever (28)
- 2 Hook for shoulder strap (137)
- 3 Handle zoom switch (28)
- 4 Lens cover lever (12)
- 5 Focus ring (29)
- 6 Zoom ring (28)
- 7 Iris ring (30)
- 8 GAIN button (32)
- 9 WHT BAL button* (33)
- 10 SHUTTER SPEED button (30)
- 11  OPEN/EJECT lever (22)
- 12  SEL/PUSH EXEC dial (20)
- 13  (One push) button (34)
- 14 White balance memory switch (33)
- 15 Gain switch (32)
- 16  IRIS/EXPOSURE button (30)

* WHT BAL button has a raised tactile dot for your convenience in locating the button.

To attach the shoulder strap

Attach the shoulder strap (optional) to the hooks for the shoulder strap.

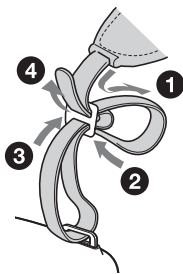

Identifying parts and controls (Continued)

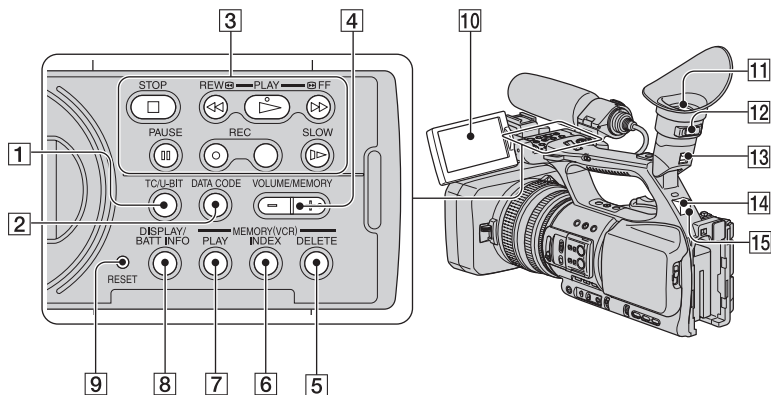

1 TC/U-BIT button
Switches between time code and user bit to display on the LCD screen.

2 DATA CODE button (54)

3 Video control buttons (STOP/REW/
PLAY*/FF/PAUSE/REC/SLOW) (51)

4 VOLUME/MEMORY button* (51)

5 MEMORY/DELETE button (51)

6 MEMORY/INDEX button* (51)

7 MEMORY/PLAY button (51)

8 DISPLAY/BATT INFO button (54)

9 RESET button

If you press the RESET button, all settings including the clock setting (except the Picture profile and Camera profile settings) return to the default.

10 LCD screen (18)

11 Viewfinder (18)

12 Viewfinder lens adjustment lever (18)

13 Viewfinder release lever (128)

14 Rear remote sensor (94)

15 Rear recording lamp (94)

The recording lamp flashes if the remaining tape or battery is low.

* PLAY button, VOLUME/MEMORY button, and MEMORY/INDEX button have raised tactile dots for your convenience in locating the buttons.

Remote Commander

Remove the insulation sheet before using the Remote Commander.

Insulation sheet

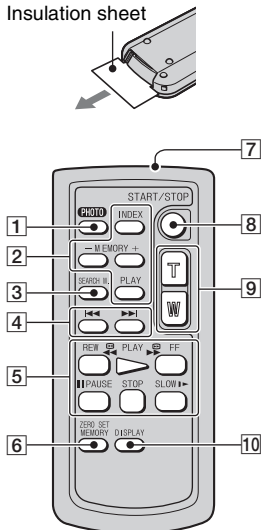

1 PHOTO (26)

The on-screen image when you press this button will be recorded onto the "Memory Stick Duo" as a still image.

2 Memory control buttons (Index, +/-, Memory/playback) (52)

3 SEARCH M. (56)

4 ◀▶▶▶

5 Video control buttons (Rewind, Playback, Fast-forward, Pause, Stop, Slow) (51)

6 ZERO SET MEMORY

This button is invalid with your camcorder.

7 Transmitter

8 START/STOP (24)

9 Power zoom (28)

10 DISPLAY (54)

Notes

- Aim the Remote Commander towards the remote sensor to operate your camcorder.
- Point the remote sensor away from strong light sources such as direct sunlight or overhead lighting. Otherwise, the Remote Commander may not function properly.
- When you are operating with the Remote Commander supplied with your camcorder, your VCR may also operate. In that case, select a commander mode other than VTR 2 for your VCR, or cover the sensor of your VCR with black paper.

To change the battery of the Remote Commander

- 1 While pressing on the tab, inset your fingernail into the slit to pull out the battery case.
- 2 Place a new battery with the + side facing up.
- 3 Insert the battery case back into the Remote Commander until it clicks.

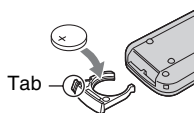

WARNING

Battery may explode if mistreated. Do not recharge, disassemble or dispose of in fire.

- When the lithium battery becomes weak, the operating distance of the Remote Commander may shorten, or the Remote Commander may not function properly. In this case, replace the battery with a Sony CR2025 lithium battery. Use of another battery may present a risk of fire or explosion.

Indicators for the LCD screen and viewfinder

The numbers in () are reference pages.

The indicators will not be recorded on the tape during recording.

Recording movies

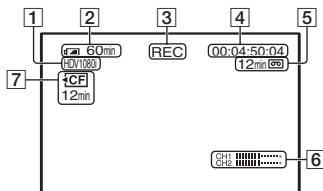

- 1** Recording format (HDV1080i or DVCAM, DV SP) (85)
- 2** Remaining battery (approx.)
- 3** Recording status ([STBY] (standby) or [REC] (recording))
- 4** During recording:
Tape counter (hour: minute: second: frame)
During playback:
Time code (hour: minute: second: frame)
- 5** Recording capacity of the tape (approx.)
- 6** Audio level display (82)
- 7** Remaining recording time of an external Memory Recording Unit (optional)

Recording still images

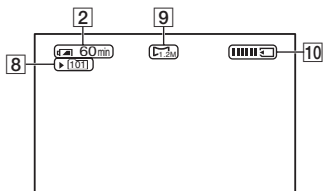



- 8** Recording folder (91)
- 9** Image size (26)
- 10** Recording indicator (26)

Data code during recording

The date/time during recording and the camera setting data will be recorded automatically. They do not appear on the screen during recording, but you can check them on the screen by pressing the DATA CODE button during playback (p. 54).

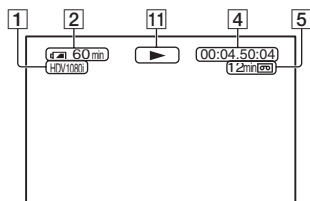

Viewing movies

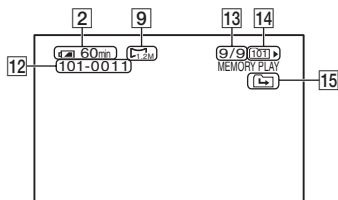

- 11** Tape transport indicator
Recording mode (DVCAM or DV SP) appears when a tape recorded in the DVCAM or DV SP format is played back.  

Viewing still images



- 12** Data file name
- 13** Picture number/Total number of recorded pictures in the current playback folder
- 14** Playback folder (92)
- 15** Previous/Next folder icon
The , , or  appears when the first or last picture of the current folder is displayed and when there are multiple folders on the same "Memory Stick Duo." You can move to Previous/Next folder with the VOLUME/MEMORY button.

Indicators for the LCD screen and viewfinder (Continued)

Indicators when you made changes

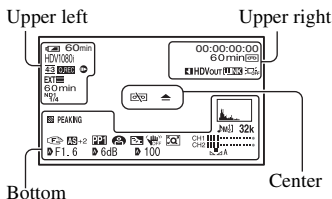

Upper left

Indicator	Meaning
HDV1080i	Recording format (85)
DVCAM DV SE	
4:3	DV WIDE REC (86)*
Q.REC	QUICK REC (94)**
FD	DV FRAME REC (75)*
ND OFF CLR ND1 1/4 ND2 1/16 ND3 1/64	ND filter (33)
Interval recording icon	INTERVAL REC (74)
EXT EXT CF	EXT REC CTRL (88)
EXT CF	
24pSCAN 24P	REC TYPE
24pSCAN 30P	SCAN TYPE (85)
30pSCAN	

Upper right

Indicator	Meaning
INDEX MARK	INDEX MARK (47)
HDV IN DV IN	HDV input/ DV input (100)
HDV OUT DV OUT	HDV output/ DV output (99)
i.LINK	i.LINK connection (58, 96)
LCD OFF	LCD backlight off (18)

Center

Indicator	Meaning
Warning icon	Warning (116)

Bottom

Indicator	Meaning
HISTOGRAM	HISTOGRAM (80)
32k 48k NS	DV AU.MODE (DV Audio mode) (77)*
Manual volume control icon	Manual volume control(44, 78)
Manual focus icon	Manual focus (29)
PP1 ~ PP6	Picture profile (35)
SPOTLIGHT icon	SPOTLIGHT (72)
BACK LIGHT icon	BACK LIGHT (72)
SteadyShot off icon	SteadyShot off (72)
PEAKING	PEAKING (81)
D.EXTENDER icon	D.EXTENDER (73)
AS	AE SHIFT (71)
ECS	Extended clear scan (32, 71)
E	EXPOSURE control (31)
R	Auto setting (82)
White balance icons	White balance (33)
FOCUS MACRO OFF	FOCUS MACRO (73)
HYPER	HYPER GAIN (70)
(COLOR)	x.v.Color (76)**
ZEBRA icon	ZEBRA (80)

* The settings can be made only for the pictures in the DVCAM (DV) format.

** The setting can be made only for the pictures in the HDV format.

Tips

- Indicators may look different or appear at different positions.

Index

A

Access lamp	23
Accessory shoe	134
Accessory shoe kit	9
Accessory shoe mount	134
Accessory shoe plate	134
ADVANCE	81
AE RESPONSE	71
AE SHIFT	71
AE SHIFT button	46
AF ASSIST	73
AGC LIMIT	70
ALL ERASE	91
ALL FILES	91
ALL OUTPUT	84
ASPECT	81
ASSIGN 7/PHOTO button	26, 46
ASSIGN BTN	93
ASSIGN buttons	46
AT IRIS LMT	71
ATW SENS	70, 71
AUDIO CH SEL	79
AUDIO LEVEL (CH1) dial	44
AUDIO LEVEL (CH1/CH2) dial	44
AUDIO LEVEL (CH2) dial	44
AUDIO LIMIT	77
AUDIO SET menu	77
AUTO/MAN (CH1/CH2) switch	44
AUTO/MANUAL switch	30
AU. MAN GAIN	78
AU.LVL DISP (Audio level display)	82
A/V connecting cable	63, 97
A/V connecting cable with S VIDEO	63, 96
A/V Remote Connector	58

B

BACK LIGHT	72, 109
BAR	82
BATT RELEASE (battery release) button	14
Battery	13
Battery Info	55
BEEP	94
BLACK FADER	73
BLACK GAMMA	37
BLACK LEVEL	37
Button-type lithium battery	139

C

Cable holder	10
CAM DATA DSP (Camera data display)	82, 109
CAMERA PROF. (Camera profile)	92
CAMERA SET menu	69
Cassette	
Insert/Eject	22
Tape	119
Cassette compartment	22
CENTER TRIG	73
CH1 (INT MIC/INPUT1) switch	10
CH2 (INT MIC/INPUT1/ INPUT2) switch	10
Charge lamp	13
Charging time	14
CLOCK SET	20, 93
CNTRST ENHCR	72, 109
COLOR BAR	76
COLOR CORRCT (Color Correct)	39
COLOR DEPTH	39
COLOR LEVEL	38
COLOR MODE	38
COLOR PHASE	38
Component A/V cable	59

Computer	105
Connect	
TV	58
VCR	96
Connecting cord	15
COPY	42
CURRENT FLDR	91

D

DATA CODE button	54
Date and time	21, 140
DATE REC	94, 110
Date search	56
DEGREE	83
Deleting camera profile settings	93
Deleting still images	53
DETAIL	41
DF	89
DISP OUTPUT	84
DISPLAY SET menu	80
DISPLAY/BATT INFO button	18, 54, 55
DOWN CONVERT	87
DRUM RUN	95
Dubbing	96
DV	85
DV AUDIO MIX	79
DV AU. MODE (DV Audio mode)	77
DV format	85
DV FRAME REC	75, 110
DV PROGRE	86
DV REC MODE (Recording mode)	86
DV SP	86
DV WIDE CONV	87
DV WIDE REC	86
DVCAM	86
D.EXTENDER (Digital Extender)	73, 109

E

ECS FREQ.	71, 110
ECS (Extended clear scan) ...	32
END SEARCH	48
End search	48
END TRIG	73
Expanded focus	30
EXPOSURE	69
EXP.FOCUS	30, 46
EXP.FOCUS TYPE	82
EXT ONLY	88
EXT REC CTRL	88, 110
Extended clear scan (ECS) ...	32

F

FADER	73, 109
FILE NO. (File number).....	91
FLCKR REDUCE	72
Focus	29
FOCUS DISP	83
FOCUS MACRO	73
Focus ring	29
FOCUS switch	29

Folder

NEW FOLDER	91
PB FOLDER (Playback folder).....	92
REC FOLDER (Recording folder).....	91

FORMAT	91
FREE RUN	90
FS32K	77
FS48K	77

G

Gain	32
GAIN button	32
GAIN SETUP	69
Gain switch	32
GAMMA	37
Grip belt	17

GUIDEFAME	81
-----------	----

H

HANDLE ZOOM	73
Handle zoom	28
Handle zoom lever	28
Handle zoom switch	28
HDMI cable	59
HDMI OUT jack	59
HDV	85
HDV format	118
HDV PROGRE	85
HDV 1080i	85
HDV/DV format	85
HDV/DV jack	60

Headphones jack	136
High definition TV	58
HISTOGRAM	80, 109
Hook for shoulder strap	137
HOURS METER	94
HYPER GAIN	70

I

INDEX MARK	47
Index screen	52
Index search	56
Index signal	47
Indicators	142
INDOOR	34
Indoor	34
INPUT1	10, 44
INPUT1 jack	10, 44
INPUT1 MIC NR	78
INPUT1 switch	44
INPUT1 TRIM	79
INPUT1 WIND	79
INPUT2	10, 44
INPUT2 jack	44
INPUT2 MIC NR	79
INPUT2 switch	44
INPUT2 TRIM	79

INPUT2 WIND	79
Insulation sheet	139
INTELLIGENT	70, 71
INTERLACE	85
Internal microphone	10
INTERVAL	74
INTERVAL REC	74, 110
IN/OUT REC menu	85
IRIS	30, 69
Iris ring	30
IRIS/EXPOSURE	69
IRIS/EXPOSURE button	30
i.LINK	124
i.LINK cable	60, 100, 102
i.LINK SET	87

J

JPEG	122
------	-----

K

KNEE	38
------	----

L

LANC jack	134, 136
LANGUAGE	93
Large eyecup	19
Last scene review	48
LAST SCN RVW	48
LCD	18
LCD backlight	18
LCD BL LEVEL	83, 109
LCD BRIGHT	83
LCD COLOR	83
LCD PANEL	84
Lens	128
Lens cover lever	12
Lens hood with lens cover	12
LETTER SIZE	84
LINKED	78

M

Macintosh	105
MANU WB TEMP.....	34, 70
MARKER	81, 109
Memory A.....	34
Memory B.....	34
Memory Recording Unit jack	44
MEMORY SET menu	91
“Memory Stick”.....	2, 122
“Memory Stick Duo”	22, 122
Insert/Eject.....	22
Number of recordable pictures	26
Write-protect tab.....	122
“Memory Stick Duo” slot cover	22
MEMORY/DELETE button	53
MEMORY/INDEX button	51
MEMORY/PLAY button	51
Menu	
AUDIO SET menu	77
CAMERA SET menu	69
DISPLAY SET menu	80
IN/OUT REC menu.....	85
MEMORY SET menu	91
OTHERS menu.....	92
TC/UB SET menu	89
Using the menu.....	64
MENU button	20
Menu items	66
Microphone.....	10
Microphone fixing clamper	10
Microphone holder.....	10
MIC+48V.....	44
MINUS AGC	70
MIX	79
Moisture condensation.....	126
MPEG2	104

N

ND filter	33
NDF.....	89
NEW FOLDER.....	91
NORMAL	81
NTSC	112, 118
NUMBER.....	82

O

One push button	34
OPEN/EJECT lever.....	22
OPERATION.....	95
OTHERS menu	92
OUTDOOR	34
Outdoor	34
Outside power source.....	15

P

PAL	118
PB FOLDER (Playback folder).....	92
PB ZOOM (Playback zoom)	93
PEAKING	81, 109
PHOTO	46
PHOTO button	26
Picture profile.....	35
PICTURE PROFILE button	35
Picture Search	52
PLAY button	51
Playing time	14
POWER switch	17
Pre-installed rechargeable battery.....	128
PRESET	89
PROFILE NAME.....	42
PROGRESSIVE.....	85
PUSH AT IRIS.....	46
PUSH AUTO button	30
PUSH (lens hood release) button	12

Q

QUICK REC.....	94
----------------	----

R

REC CH SELECT switch	10
REC CTL MODE	88
REC FOLDER (Recording folder)	91
REC FORMAT.....	85
REC LAMP[F]	94
REC LAMP[R].....	94
REC LINK.....	76
REC PAUSE.....	88
REC REVIEW	48
Rec review	48
REC REVIEW button.....	48
REC RUN.....	90
REC START/STOP button	24
REC TIME.....	73, 74
REC TIMING	73
REC TYPE	85
Recording	24
Recording lamp	24
Recording time	14
REGENERATE.....	90
RELAY	88
REMAINING	84
Remaining battery	55
Remote Commander.....	139
REMOTE CTRL (Remote control)	94
Remote sensor	94
RESET.....	42, 89
RESET button.....	138
RING ASSIGN	69
RING ROTATE.....	69

S

S VIDEO jack.....	61, 63, 96
-------------------	------------

Index (Continued)

- SAFETY ZONE 81
SCAN TYPE 86
SEARCH M.....56
Self-diagnosis display..... 116
SEL/PUSH EXEC dial20
SEPARATE.....78
SHOT TRANSITION.....75
Shot transition.....48
Shoulder strap..... 137
SHUTTER DISP83
Shutter speed32
SHUTTER SPEED button
.....32
SKINTONE DTL (Skintone
detail).....42
Skip Scan.....52
Slot.....23
SMOOTH GAIN70
SMOOTH WB.....71
SMTH SLW REC
(Smooth slow recording)
.....73, 109
Specifications 129
SPEED ZOOM73
SPOTLIGHT72, 109
START TIMER.....76
START TRIG.....73
Status check.....55
STATUS CHECK button.....55
STBY COMMAND88
STEADYSHOT72
STOP88
Supplied items 8
SYNCHRONOUS 88
- T**
Tape counter..... 140
TAPE RUN.....95
Tape.....See Cassette
TC COUNTUP.....89, 109
TC FORMAT89
TC LINK90, 109
TC MAKE..... 90
TC PRESET 89
TC RUN..... 90
TC/UB SET menu..... 89
TC/U-BIT button 138
Telephoto 28
THREADING 95
Time code 140
TONE..... 77
Trademark 133
TRANS TIME..... 75
Transmitter 139
TRIG 73
TRIG LEVEL 73
Troubleshooting 106
TV 58
TV color systems 118
- U**
UB PRESET 89
UB TIME REC 90
UB-DATE/TC-TIME.. 90, 109
Using the menu items 64
Using your camcorder abroad
..... 118
- V**
VCR HDV/DV 85
VF B.LIGHT..... 83, 109
VF COLOR..... 84
VF POWERMODE..... 84
Video control buttons..... 139
Video head 127
VIDEO OUT..... 87
Viewfinder 18
Viewfinder lens adjustment
lever 128
Viewfinder release lever 128
Volume..... 44, 52
VOLUME/MEMORY button
..... 51
V-OUT/PANEL 84
- W**
Warning indicators 116
Warning messages..... 117
WB OUTDR LVL..... 70
WB PRESET 70
WB SHIFT41
WB TEMP SET70
White balance 33
White balance memory switch
..... 34
WHITE FADER..... 73
WHT BAL button.....33
Wide angle.....28
Wind screen..... 10
Windows.....105
WORLD TIME93, 110
Write-protect tab 120, 122
- X**
XLR SET.....78, 99
x.v.Color.....76, 110
- Z**
ZEBRA 80, 109
ZEBRA button.....46
Zoom28
ZOOM DISPLAY 82
Zoom lever28
Zoom ring.....28
“Memory Stick Duo”22

Free Manuals Download Website

<http://myh66.com>

<http://usermanuals.us>

<http://www.somanuals.com>

<http://www.4manuals.cc>

<http://www.manual-lib.com>

<http://www.404manual.com>

<http://www.luxmanual.com>

<http://aubethermostatmanual.com>

Golf course search by state

<http://golfingnear.com>

Email search by domain

<http://emailbydomain.com>

Auto manuals search

<http://auto.somanuals.com>

TV manuals search

<http://tv.somanuals.com>