

**Still Video Camera****MVC-A10****Operating Instructions**

Before operating the unit, please read this manual thoroughly and retain it for future reference.

To record and play back with this unit,  
the MAP-T2 playback controller is necessary.  
The MAP-T1 playback adaptor cannot be used with this unit.

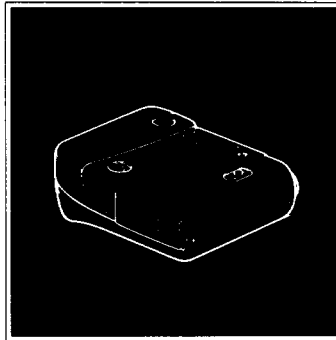

Hi-Band  
**Mavica**  
**Hi V** )))

© 1989 by Sony Corporation

# IMPORTANT SAFETY INSTRUCTIONS

When using your electronic flash, basic safety precautions should always be followed, including the following:

1. Read and understand all instructions before using.
2. Close supervision is necessary when any appliance is used by or near children. Do not leave appliance unattended while in use.
3. Care must be taken as burns can occur from touching hot parts.
4. Do not operate appliance if it has been examined by a qualified serviceman and it has been determined that it has not been repaired properly.
5. Position the cord so that it will not be tripped over, pulled, or contact hot parts.
6. Always unplug appliance from electrical outlet when not in use. Never yank cord to pull plug from outlet. Grasp plug and pull to disconnect.
7. Loop cord loosely around appliance when storing.
8. To reduce the risk of electric shock, do not immerse this appliance in water or other liquids.
9. To reduce the risk of electric shock, do not disassemble this appliance, but take it to a qualified serviceman when service or repair work is required.
10. Incorrect reassembly can cause electric shock when the appliance is used.
11. The use of an accessory attachment not recommended by the manufacturer may cause a risk of fire, electric shock, or injury to persons.

## Owner's Record

The model and serial numbers are located on the bottom of the unit.  
Record the serial number in the space provided below. Refer to these numbers whenever you call upon your Sony dealer regarding this product.

Model No. MVC-A10 Serial No. \_\_\_\_\_

## WARNING

To prevent fire or shock hazard, do not expose the unit to rain or moisture.  
To avoid electrical shock, do not open the cabinet. Refer servicing to qualified personnel only.

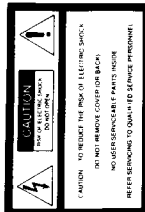

This symbol is intended to alert the user to the presence of uninsulated "dangerous voltage" within the product's enclosure that may be of sufficient magnitude to constitute a risk of electric shock persons.

This symbol is intended to alert the user to the presence of important operating and maintenance (servicing) instructions in the literature accompanying the appliance.

## INFORMATION

This equipment generates and uses radio frequency energy and if not installed and used properly, that is, in strict accordance with the instructions, may cause interference to radio and television reception. It has been type tested and found to comply with the limits for a Class B Subcategory of Part 15 of FCC Rules, which specifies that reasonable protection against such interference may be required. This equipment has been specifically designed to provide reasonable protection against such interference. However, some changes to the installation may cause interference to radio or television reception, which can be determined by the following test procedure. If you find that you are unable to correct the interference by one or more of the following measures, please contact your dealer.

Relocate the receiving antenna.  
Relocate the equipment with respect to the receiver.  
Move the equipment away from the receiver.  
If the equipment and receiver are on different branch circuits, the equipment and receiver are on different branch circuits. If necessary, the user should consult the dealer or an authorized service center for more information and suggestions. The user may find the following booklet prepared by the Federal Communications Commission helpful: "How to Identify and Resolve Radio-TV Interference Problems." This booklet is available from the U.S. Government Printing Office, Washington, DC 20540. Stock No. 004-000-00345-4.

## Table of Contents

- Check Your Unit First
- Outline
- Precautions
- Quick Reference
- Location and Function of Parts
- Power Source
- Inserting the Maxipak
- Recording
- Radio Shooting
- Shooting with Limiter
- Shooting with Backlit Situations
- To Record onto a Recorded Track
- Specifications
- Troubleshooting

## Outline

The MVC-A10 "Maxivox™" is a still video camera that records pictures and sounds magnificently without the use of film.

### Automatic adjustments

It is compact and light in weight. It is easy to operate because focus and exposure adjustments are not necessary.

### Audio recording

Sound can be recorded through the built-in microphone or an external microphone. Audio recording is automatically done for approximately 10 seconds following a video recording. This is convenient for recording a comment on the video recording, etc.

### Display window

The number of the recorded tracks and the various indicators appear on the display.

## Precautions

- The Maxivox MVC-A10 is a still video camera based on the HVC-A10 format. To play back the Maxivox recorded with the MVC-A10, a playback controller, MAP-TZ, or a still video player with the HVC-A10 mark is necessary. When an unit without the HVC-A10 mark is used, proper precautions must be taken. When using a still video camera, avoid using in a strong electric field. Pictures may be distorted or otherwise spoiled when used near the antenna of a TV or radio station. When using a still video camera, avoid using in a strong electric field. When it is extremely dirty, use a mild soap on the cloth before wiping.

## Check your unit first

There are the following differences, depending upon the country where MVC-A10 is purchased.

- **Cables:** The MAP-TZ playback controller and an external microphone are packed with the unit.
- **USA and other countries:** Neither playback controller nor external microphone is packed with the unit.

### Searching for unrecorded tracks

Pictures and sounds can be recorded automatically by the blank search function.

### Backlight compensation

You can shoot a too dark subject against a bright background.

### Sequential shooting

You can shoot in sequence onto 4 tracks or on 10 tracks per second.

### Close-ups (MACRO)

The subject can be shot as close as approximately 50 cm (20 in.) from the lens surface.

- Do not leave the unit in a location near heat sources, or in a place subject to direct sunlight, excessive dust, or mechanical shock.
- When the casing becomes soiled, clean it with a soft cloth dampened with mild detergent solution. Never use benzene, thinner or chemical solvents, as they may harm the casing.

If you have any question or problem concerning your unit that is not covered in this manual, please consult the nearest Sony dealer. If you have a still video camera and the playback controller to the Sony dealer when requesting repair.

# Quick Reference

## The following items are necessary for recording.

To use this unit, the MAP-T2 playback controller is necessary. The MAP-T1 playback adaptor cannot be used with this unit.

Navipak MVC-A10

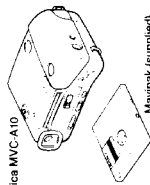

Navipak (supplied)

Playback controller MAP-T2

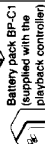
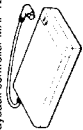

Battery pack BP-C1 (supplied with the playback controller)

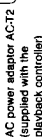

AC power adaptor ACT-2 (supplied with the playback controller)

Be sure to charge the battery pack before using the unit.

## How to attach the supplied grip belt

1

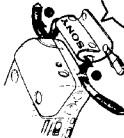

2 Adjust the length.



3

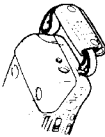

## Recording

For details, refer to page ●

1 Insert the fully-charged battery pack.



2 Insert the Navipak.



3 Set the shooting mode selector to S.

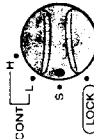

4 Set the AUDIO recording mode selector to AUTO.

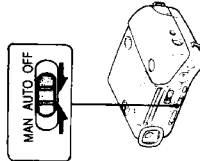

5 Look into the viewfinder and frame the subject.

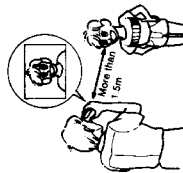

6 Press the shutter button halfway. When the green LED glows in the viewfinder, press the button all the way down to take a picture. After shooting, sound can be recorded automatically for 10 seconds.



# Location and Function of Parts

## Front view

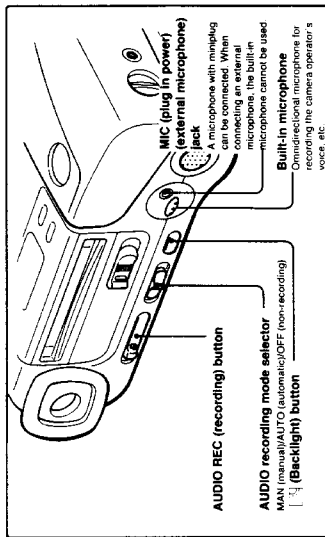
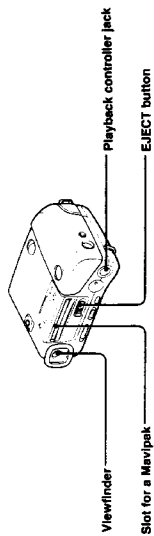

## Top view/Rear view

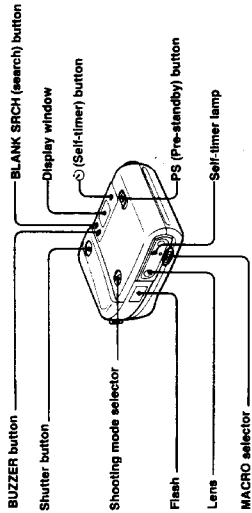

## Display window

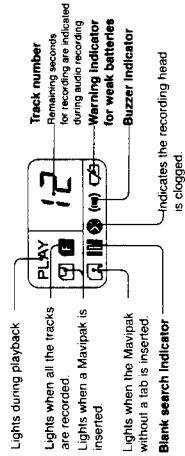

# Power Source

Before operating the unit, be sure to charge the battery pack fully with the playback controller.

- 1** Connect the AC power adaptor as illustrated.

To a wall outlet  
AC power adaptor (supplied with the playback controller)  
To DC IN 9V
- 2** Install the battery pack into the playback controller.

Charging starts.

With correct polarity  
Battery pack inserted with the playback controller (controller) side up  
With the "Mavica" side up

Playback controller  
When charging starts, the CHARGE CONTROLLER lamp lights up, and goes off in about one hour.
- 3** Install the battery pack into the camera.

With the "Mavica" side up  
With correct polarity

Loosen the screw to remove the cover.

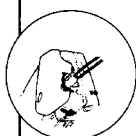

Number of tracks that can be recorded with one fully charged battery

Video recording only  
Audio/Video recordings can be recorded when the battery is charged for one hour (according to the specification by Sony)

Audio/Video recordings  
About 125 pairs of picture and sound can be recorded when the battery is charged for one hour (according to the test specified by Sony)

When the battery gets weak,  $\swarrow$  appears on the display window.

- $\swarrow$  (blinking) The battery pack is starting to lose power.
- $\swarrow$  Replace or charge the battery pack as soon as possible.
- $\swarrow$  (fl) The battery pack has consumed all of its power. No recording can be done. Replace or charge the battery pack.

To charge the battery pack in the camera

When charging the battery pack for the first time or after the battery pack has been fully charged, charge the battery pack with the playback controller.

If the battery pack is installed in the camera during the charging, the CHARGE CAMERA lamp may go off when the charging is not completed.

Mavica  
Have the battery pack installed

Camera connecting cable

Playback controller

To DC IN 9V

AC power adaptor

To a wall outlet

When charging starts, the CHARGE CAMERA lamp lights up, and goes off in about one hour when charging is completed.

**CAUTION**

When the camera is not in use for a long time, remove the battery pack. If the battery is installed, even if the shooting mode selector is set to LOCK, a negligible amount of electric current flows.

**When the battery pack is installed in both the camera and the playback controller**

Continuous charging can be carried out — from camera to playback controller.

### Life of the battery pack

- Replace the battery pack with a new one (BP-C1, optional) if you can only take about half the number of pictures under average temperatures, even when it is fully charged.
- Precautions on the battery pack**
- When charging the battery pack, always use the MAR-T2 playback controller.
  - Do not short the terminals of the playback controller or the battery pack by screwdrivers, pins, etc.
  - Do not get the battery pack, or the battery, may be impaired.

# Inserting the Mavipak

**Insert until it stops — in the direction of the arrow.**

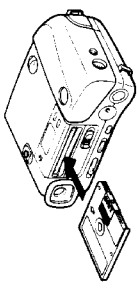

**To take out the Mavipak**

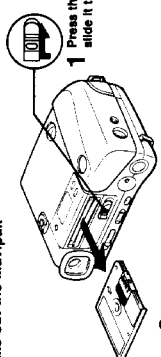

- 1 Press the blue lock button and slide it to the right.
- 2 The Mavipak comes out.

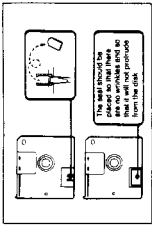

### To prevent accidental erasure

- Take off the tab on the back of the Mavipak.
- When the hole from which the tab was taken is covered by a seal supplied with the Mavipak, it can be recorded again.

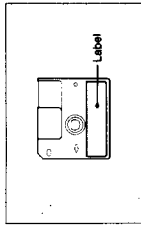

### To make a memorandum of recorded contents

- Place the label at the position indicated on the picture at right. When the label is not placed at the position shown, it can cause malfunction and damage.

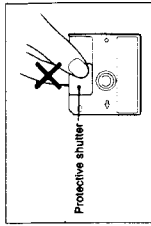

### Precautions

- Never open the protective shutter.
- Do not place the Mavipak where there is magnetism (on top of a speaker box, etc.). This can cause the Mavipak to malfunction.
- Do not leave the Mavipak in the camera for a long period of time when not in use.
- Do not leave the Mavipak where there is direct sunlight, near heaters, or in a dusty place.
- When changing the Mavipak, avoid doing it in rain or snow, or in dusty places. When water or dust gets inside in the camera, it causes damage.

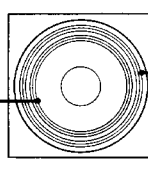

Track No. 50

Track No. 1

### Mavipak

The Mavipak is a 2-inch video floppydisk. It conforms to the unified standard designated by the Still Video Camera Committee. It is equivalent to the film in a traditional camera. A magnetic disk in the Mavipak to be recorded is called a track. A total of 50 pictures and sounds can be recorded magnetically on tracks numbered from 1 to 50. Therefore, a recorded track can be erased, or recorded again. Use a Mavipak or a floppydisk with a  mark.

# Recording

Install the fully-charged battery pack and the Mavipak into the camera before recording. (Refer to pages 1 through 10.)

## 1 Select the shooting mode.

**To shoot a single picture**  
**S:** A single picture is shot each time the shutter button is pressed.

**To shoot continuous pictures**  
**CONT L** (continuous low) is set and while the shutter button is pressed. Useful in active sports.  
**CONT H** (continuous high):  
 10 pictures per second are shot while the shutter button is pressed. Useful in sports, in tennis, golf, etc. by stopping the picture.

When using flash in the CONT L and H modes, continuous shooting of one picture per approximately 1/200 second can be done (when using a fully-charged battery pack).

## 2 Select the AUDIO recording mode.

When the selector is set to **AUTO**

**AUTO (automatic recording):**  
 Sound is automatically recorded for about 10 seconds immediately after shooting.

When the selector is set to **MAN**

**MAN (manual recording):**  
 Sound can be recorded for about 10 seconds (extended time to 60 sec. within 2 minutes after shooting).

**When not recording sound**  
 Set the selector to OFF.

### Sound playback for continuous shooting mode

The sound is played back, corresponding to the first picture.

### CAUTION

Do not slide the AUDIO recording mode selector during shooting. Otherwise, recording cannot be completed.

## How are pictures and sounds recorded on the Mavipak?

### Video recording

A video recording requires one track for each picture. When recording pictures only, a Mavipak can hold 50 pictures.

### Audio recording

A pair of picture and sound can be recorded. (Sound by itself cannot be recorded.) As an audio recording requires one track, a recording of the pair of picture and sound requires two tracks. (Track number on the display advances one track for each picture.) When the shutter button is pressed, the audio recording starts after the shutter button is pressed.

### When playing back the Mavipak on which sound is recorded

Ex: In the case of a Mavipak on which sound is recorded with the AUDIO recording mode selector set to AUTO.

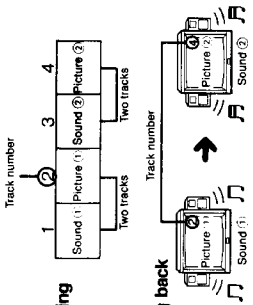

### When recording

### When playing back

Even if only pictures are recorded, sound can be recorded afterward as narration for the recorded pictures. For details, refer to the operating instructions for the MAP-T2 (page 10).

**3**

**Look into the viewfinder to frame the subject.**

Stand more than 1.5 m (5 ft.) from the subject to be shot.

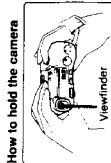
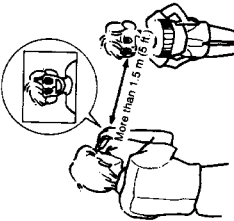

How to hold the camera  
Viewfinder

**4**

**Shoot.**

**1** Lightly press the shutter button.  
(Or the PS button\*)



Shutter button

**2** When the green lamp is lit in the viewfinder.



**3** Press the shutter button all the way down.



**A buzzer sounds when shooting.**

The flash activates in a dark place. For continuous shooting, press the shutter button all the way down and the buzzer continued while the shutter button is pressed.

**5**

**Record sound.**

**AUTO: automatic recording**  
(When the AUDIO recording mode selector is set to AUTO)



When the buzzer sounds after pressing the shutter button, "A", "10", "9", "8", "7", "6", "5", "4", "3", "2", or "1" appears on the display window. When countdown sound can be recorded until the buzzer sounds again.

**MAN: manual recording**  
(When the AUDIO recording mode selector is set to MAN)



Slide the AUDIO REC button to the left while keeping the red button pressed. Then, speak into the microphone. (Once the lever is slid to the left, you can tilt your hand to shoot.) "A", "10", "9", "8", "7", "6", "5", "4", "3", "2", or "1" appears on the display window.



When countdown sound can be recorded until the buzzer sounds again. Record the sound for the picture you shot last within 5 minutes after shooting.

**When a red lamp blinks in the viewfinder, and the buzzer sounds**

No recording can be made. Look at the display window to find the cause.

Indicator	Cause and remedy
	The Mavipak is not inserted. Insert the Mavipak.
	The tab on the Mavipak has been removed. Replace with a new Mavipak or put the supplied seal on.
	All tracks on the Mavipak have been recorded. Replace with a new Mavipak or erase the tracks. (Refer to the operating instructions of the MAP-TE.)
	The last track (No. 50) has been recorded but erased tracks) cannot be recorded. Record on the erased track(s).
	The battery pack is weak. Replace with a new one or charge the battery.
	The recording head is clogged in the tape. Clean the head with the VHS-260. (The head is not available in the U.S.A. only) or contact the nearest Sony dealer.
	The picture or the sound left recorded may not remain the track.

**When no recording is made for 5 minutes**  
To prevent battery consumption, the indicator on the display window goes off, and the power will go off automatically. To start recording again, press the shutter button lightly.

**Buzzer**  
The buzzer sounds in the following cases:

- When shooting (beeps once)
- When audio recording starts and ends (sounds once each)
- When it is impossible to record a picture or a sound (beeps continuously)
- Self-timer shooting sounds for 10 seconds)

To turn the buzzer off, press the BUZZER button. (4) on the display window will go off.

To turn the buzzer on, press the button again. (4) on the display window will appear. The buzzer will go on when the shooting mode selector is set to the LOCK or after changing the battery pack.

**\*PS button**  
When the PS button is pressed, it is the same as pressing the shutter button lightly, which starts measuring the lighting condition and charges the flash. By using the button, the camera is in stand-by position, and will respond to the shutter. However, when the PS button is pressed, it consumes the battery quickly.

**Flash**

Flash light reaches up to about 4 m (13 ft.). Shoot so that the subject is within 1.5 m (5 ft.) or 1.2 m (12 ft.).

**When not using the camera**  
Set the shooting mode selector to the LOCK position. The power turns off and the shutter button is locked.

**To interrupt an audio recording**  
Press the PS button. The sound recorded before pressing the button remains on the track(s).

**Display window (in recording sound)**  
Track number on the display window advances by 2 because a recording of the pair of picture and sound require 2 tracks.

**To erase the sound just recorded**

- 1 Press the recording mode selector to MAN.
- 2 Slide the AUDIO REC button to the left, within 5 minutes after the sound is recorded.
- 3 Slide the AUDIO REC button to the left again while "A", "10", "9", "8", "7", "6", "5", "4", "3", "2", or "1" appears on the display window. (The sound cannot be erased when more than 5 minutes have passed after it was recorded.)

**To record a new sound over the sound just recorded**

- 1 Press the AUDIO recording mode selector to MAN.
- 2 Slide the AUDIO REC button to the left and record a new sound within 5 minutes after the first sound was recorded. The previous sound recorded is erased and the new sound is recorded. (The new sound cannot be recorded when more than 5 minutes have passed after it was recorded.)



# Recording

## Macro (Close-up) Shooting

You can shoot as close as about 50 cm (20 in.) from the subject.

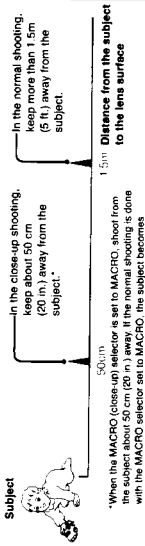

**1 Set the MACRO (close-up) selector to MACRO while keeping the center button pressed.**  
The green lamp blinks in the viewfinder.

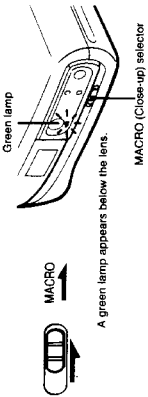

**2 Lightly press the shutter button.**  
The green lamp is lit in the viewfinder.

**3 Press the shutter button all the way down.**

**CAUTION**  
The edge of picture may be clipped when playing back, depending on the lens. To avoid the above, some space around the subject in the close-up shooting.

### To use an external microphone

The built-in microphone is an omnidirectional monaural microphone that picks up sounds naturally. To pick up specific sounds (e.g. the voice of the person to be shot), use an external microphone equipped with a minijack. An external microphone (plug-in power type) can be connected to the MIC jack, and it is powered by the camera. However, it does not operate when the external microphone is connected.

Use the self-timer when taking a group picture, etc.

## Shooting with Self-timer

**1 Place the camera horizontally or attach a tripod.**

When not attaching a tripod, set the camera horizontally. If you use the self-timer for a Mavica, set the Mavica to horizontal to the ground.

**2 While keeping the self-timer button pressed, press the shutter button.\***

Be sure that the self-timer lamp blinks. The camera takes a picture about 10 seconds after the shutter button is pressed. A buzzer will continue to sound until the picture is taken. (The blinking becomes rapid for the last 2 seconds.)

### How to attach a tripod

Attach a tripod as shown in the diagram. When attaching a light, connect it to the tripod. The tripod does not collapse because of the weight of the Mavica. For details, refer to the operating instructions of the tripod.

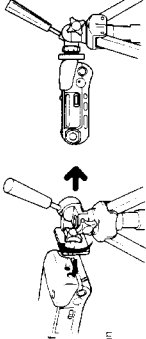

## Shooting in Backlit Situations

When shooting in the backlight, the subject becomes dark, because the background is too bright. In this case, press the backlight button before shooting. The exposure for the subject is compensated to the proper degree.

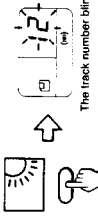

Press the backlight button each time you press the shutter button.

### To release the self-timer

Set the shooting mode selector to the LOCK position.

### To record sound in the self-timer shooting

Set the AUDIO recording mode selector to MAN. You can record sound any time within 5 minutes after the self-timer shooting.

\*Lightly press the shutter button, and after the green lamp is lit in the viewfinder, press the button all the way down.

### To use the backlight button in shooting

Continuous pictures are requested for all the tracks while the shutter button is continuously pressed (continuous shooting). Once the shutter button is halfway released or completely released, the backlight adjustment does not operate. To continue shooting, press the backlight button again before pressing the shutter button.

## To Record onto a Recorded Track

Since the Navica records pictures and sounds magnetically, it can erase unnecessary track(s) and can record again.

### Erase unnecessary track(s)

The MAP-72 playback controller is needed for erasing. For details, refer to the operating instructions of the playback controller.

### To record onto erased track(s)

A Mavipak on which all the tracks are erased from the Mavipak.

You can record from track No. 1, the same as a new Mavipak.

1 Take the Mavipak out of the camera.

2 Press the BLANK SRCH button. **III** will appear on the display window.

3 Insert the Mavipak and shoot.

The camera searches for erased (unrecorded) tracks, and start recording from the track with the smallest number.

#### Precaution

The blank search mode cannot be set while the Mavipak is in the camera.

#### To release the blank search mode

Press the BLANK SRCH button again. **III** will disappear from the display window. The blank search mode will also be released when the Mavipak is taken out, or when the battery pack is exchanged.

#### A track is blank in the following cases.

- When the recorded picture or sound is erased with a playback controller.
- When no sound is recorded within 5 minutes after the picture is shot with the AUDIO recording mode selector set to MAN.
- When the AUDIO recording mode selector is set to REC and the AUDIO REC button is held to the left while recording pictures and sounds with the AUDIO recording mode selector to MAN.

## When the blank search function is used or not

Ex: In the case of a Mavipak on which recordings from No. 1 to No. 5 were made, and tracks No. 2 and No. 4 were erased.

### Without using the blank search function

#### Using the blank search function

A total of 47 tracks can be recorded. For No. 2, No. 4 and No. 5, continuous shooting for 2 to 4 to 6 to 50 can be done.

A total of 45 tracks can be recorded from No. 6 to No. 50.

**Audio recording when using the blank search function**  
A pair of picture and sound, or only a picture can be recorded. A pair of picture and sound can be recorded as long as there are 2 erased (blank) tracks, even if they are not adjacent to each other (ex. No. 2 and No. 4).

#### Blank search function



Cannot record on No. 2 and No. 4.

# Specifications

**Type:** Still video camera with high band format

**Recording:** Unified standard based on Still Video Camera Committee

**Recording capacity:** 20 minutes with sounds (field recording)

**Audio recording:** 9.6 seconds max /25 recordings

**Audio recording mode:** Automatic recording  
Manual recording

**Lens:** 15mm /f2.8  
fixed focus  
(1.5m to infinity, 50 cent, 6 ft. at infinity)

**Image sensor:** 2/3 inch MOS image sensor (280,000 pixels), sensitivity equivalent to ISO 80 film

**Exposure control:** Programmed autoexposure

**Shutter:** Electronic shutter built in the image sensor  
Flash fires automatically below EV 9

**Metering system:** Electronic shutter built in the image sensor  
Shutter speed range: 1/60 - 1/500 sec.  
Shutter speed selected direct reading by the image sensor

**Flash:** Automatic activation  
Single picture strobing  
CONT. mode

**Shooting mode:** 4 pictures per sec.  
CONT. H - Continuous shooting at 10 pictures per sec

**Self timer:** Electronic type, 10-second delay

**Operating temperature:** 41°F - 104°F (5°C - 40°C)

**Power requirements:** 6V DC with BP-C1 battery pack  
Approx. 270 mAh (1.2 Ah)  
Approx. 270 x 4.5 (in) (6.8 in)

**Weight:** Approx. 620g (1 lb 6 oz) including battery pack

**Microphone:** Built in electret condenser microphone

**MIC input jack:** Minijack - 80 dBs low impedance  
With 2.5 - 3V DC output, impedance 6 k ohms

**Supplied accessories:** Battery pack (1)  
Salt case (1)  
Grip belt (1)

**Optional accessories:** Still video system case LCH-A10  
Battery pack BP-C1  
Cleaning disk VED-25CL (available in the U.S.A. only)  
Electret condenser microphone ECM-144

Design and specifications subject to change without notice

# Troubleshooting

Before going through the check list below, first refer back to the connections and operating procedures. Should any problem present after you have made these checks, consult your nearest Sony service facility. The number in black is the page number to refer to.

Shooting	
<b>Symptom</b> Will not shoot when shutter button is pressed.	<b>Remedy</b> Insert a fully-charged battery pack. See page 6. The battery is consumed. Set to S, CONT L or H. See page 6. A red lamp lights up in the viewfinder and the buzzer sounds.
<b>Cause</b> The battery is not installed. The battery is consumed. The shooting mode selector is set to the LOCK position. Refer to "When the red lamp blinks in the viewfinder and the buzzer sounds" on page 6.	<b>Remedy</b> Insert the Macropak again. If it does not connect, insert the Macropak with a new one. Put in a fully-charged battery pack. See page 6.
<b>Symptom</b> The Macropak is ejected when inserted into the camera.	<b>Remedy</b> The Macropak is not inserted correctly.
<b>Symptom</b> Takes time for the green lamp to light up in the viewfinder.	<b>Remedy</b> The battery pack has been consumed.

Playing back picture	
<b>Symptom</b> The picture is blurred.	<b>Remedy</b> Be more than 1.5m (5 ft.) away from the subject. Hold the camera still when shooting. Set the selector to the left when not shooting in macro.
<b>Symptom</b> The picture is reddish or greenish.	<b>Remedy</b> When the picture is not taken with flash, it becomes reddish under an incandescent light, and greenish under a fluorescent light.
<b>Symptom</b> Many reddish circles appear on the playback picture.	<b>Remedy</b> Flare occurs on the lens caused by strong light like the sun. Put in a fully-charged battery pack.
<b>Symptom</b> Tricky, black lines appear when shooting a subject with a strong light. Or, the picture has a zig-zagging sound.	<b>Remedy</b> Shoot the picture so that strong light will not go into the lens. E.g. The reflection of water caused by the sunlight.
<b>Symptom</b> The picture is dark even when the flash is used.	<b>Remedy</b> This occurs because of the characteristic of the image sensor. The subject is too far.
<b>Symptom</b> The eyes of the person are reproduced reddish when the flash is used.	<b>Remedy</b> This occurs when the flash light goes into a person's eyes and lights the blood vessels of the retina. The person look somewhere other than directly into the camera lens.
<b>Symptom</b> The picture is whitish.	<b>Remedy</b> The backlight button was pressed in shooting, while the light came from the front of the subject.

Playing back sound	
<b>Symptom</b> No sound is heard.	<b>Remedy</b> Set the AUDIO recording mode selector to AUTO or MAN when recording. Re-record sound by using the MAR-TZ.
<b>Symptom</b> Sound is weak.	<b>Remedy</b> Turn back the sound with the AUDIO recording mode selector set to AUTO or MAN. Speak into the microphone or use an external microphone.
<b>Symptom</b> AUDIO recording mode selector was set to OFF in recording.	<b>Remedy</b> Set the AUDIO recording mode selector to ON in recording.
<b>Symptom</b> AUDIO REC button was slid to the left several times while recording with the AUDIO recording mode selector set in MAN.	<b>Remedy</b> Set the AUDIO recording mode selector to OFF in recording.
<b>Symptom</b> Sound was not far away from the microphone in recording.	<b>Remedy</b> Speak into the microphone or use an external microphone.

Display window, etc.	
<b>Symptom</b> The indicators on the display window disappear, and the power turns off.	<b>Remedy</b> No recording was done for more than 5 min. The same track was played back for more than 5 min.
<b>Symptom</b> The camera does not operate.	<b>Remedy</b> Internal circuit is troubled by static electricity, etc.
<b>Symptom</b> Consumption of the battery pack is rapid.	<b>Remedy</b> Install a fully-charged battery pack. Replace with a new battery pack.
<b>Symptom</b> The indicators on the display window disappear, and the power turns off.	<b>Remedy</b> The battery pack becomes weak. Replace with a new battery pack.
<b>Symptom</b> The camera does not operate.	<b>Remedy</b> The power of the battery pack is extremely low because of extremely low temperature. Use it after warming the camera, for example, putting it into your pocket.

## Free Manuals Download Website

<http://myh66.com>

<http://usermanuals.us>

<http://www.somanuals.com>

<http://www.4manuals.cc>

<http://www.manual-lib.com>

<http://www.404manual.com>

<http://www.luxmanual.com>

<http://aubethermostatmanual.com>

Golf course search by state

<http://golfingnear.com>

Email search by domain

<http://emailbydomain.com>

Auto manuals search

<http://auto.somanuals.com>

TV manuals search

<http://tv.somanuals.com>