

Lens for Digital Single Lens Reflex Camera

Operating Instructions

16mm F2.8 Fisheye

SAL16F28

©2006 Sony Corporation Printed in Japan



<http://www.sony.net/>

16mm F2.8 Fisheye is a fisheye lens with a wide angle-of-view. You can enjoy unique image-expression, owing to its unique deformation-effects. This lens is designed for Sony α cameras.

WARNING

To reduce fire or shock hazard, do not expose the unit to rain or moisture. Do not directly look at the sun through this lens. Doing so might harm your eyes or cause loss of eyesight. Keep the lens out of reach of small children. There is danger of accident or injury.



Disposal of Old Electrical & Electronic Equipment (Applicable in the European Union and other European countries with separate collection systems)

This symbol on the product or on its packaging indicates that this product shall not be treated as household waste. Instead it shall be handed over to the applicable collection point for the recycling of electrical and electronic equipment. By ensuring this product is disposed of correctly, you will help prevent potential negative consequences for the environment and human health, which could otherwise be caused by inappropriate waste handling of this product. The recycling of materials will help to conserve natural resources. For more detailed information about recycling of this product, please contact your local Civic Office, your household waste disposal service or the shop where you purchased the product.

For the customers in the U.S.A.

THIS DEVICE COMPLIES WITH PART 15 OF THE FCC RULES. OPERATION IS SUBJECT TO THE FOLLOWING TWO CONDITIONS: (1) THIS DEVICE MAY NOT CAUSE HARMFUL INTERFERENCE, AND (2) THIS DEVICE MUST ACCEPT ANY INTERFERENCE RECEIVED, INCLUDING INTERFERENCE THAT MAY CAUSE UNDESIRE OPERATION.

CAUTION

You are cautioned that any changes or modifications not expressly approved in this manual could void your authority to operate this equipment.

NOTE:

This equipment has been tested and found to comply with the limits for a Class B digital device, pursuant to Part 15 of the FCC Rules. These limits are designed to provide reasonable protection against harmful interference in a residential installation. This equipment generates, uses, and can radiate radio frequency energy and, if not installed and used in accordance with the instructions, may cause harmful interference to radio communications. However, there is no guarantee that interference will not occur in a particular installation. If this equipment does cause harmful interference to radio or television reception, which can be determined by turning the equipment off and on, the user is encouraged to try to correct the interference by one or more of the following measures:

- Reorient or relocate the receiving antenna.
- Increase the separation between the equipment and receiver.
- Connect the equipment into an outlet on a circuit different from that to which the receiver is connected.
- Consult the dealer or an experienced radio/TV technician for help.

For the customers in Canada

This Class B digital apparatus complies with Canadian ICES-003.

Notes on use

- Do not leave the lens in direct sunlight. If sunlight is focused onto a nearby object, it may cause a fire. If circumstances necessitate leaving the lens in direct sunlight, be sure to attach the lens cap.
- Be careful not to subject the lens to mechanical shock while attaching it.
- Always place the lens caps on the lens when storing.
- Do not keep the lens in a very humid place for a long period of time to prevent mold.
- Do not hold the camera by the lens part extended for focusing, etc.
- Do not touch the lens contacts. If dirt, etc., gets on the lens contacts, it may interfere or prevent the sending and receiving of signals between the lens and the camera, resulting in operational malfunction.

Precautions for flash use

Due to the lens' wide angle of view, edges of pictures will tend to be dark in combination with a flash. Countermeasures, such as using bounce flash with an external flash is recommended.

Vignetting

When you use lens, the corners of the screen become darker than the center. To reduce this phenomena (called vignetting), close the aperture by 1 to 2 stops.

Condensation

If your lens is brought directly from a cold place to a warm place, condensation may appear on the lens. To avoid this, place the lens in a plastic bag or something similar. When the air temperature inside the bag reaches the surrounding temperature, take the lens out.

Cleaning the lens

- Do not touch the surface of the lens directly.
- If the lens gets dirty, brush off dust with a lens blower and wipe with a soft, clean cloth (Cleaning Cloth KK-CA (optional) is recommended).
- Do not use any organic solvent, such as thinner or benzine, to clean the lens or the camera cone.

A Names of parts

- 1...Filter index
- 2...Filter-changing ring
- 3...Lens contacts
- 4...Mounting index
- 5...Depth-of-field scale
- 6...Distance scale
- 7...Distance index
- 8...Focusing ring
- 9...Lens hood

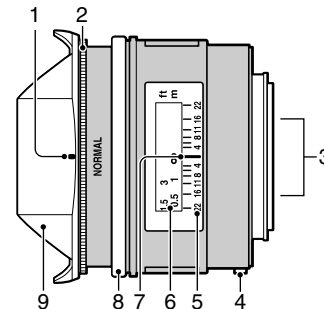

B Attaching/detaching the lens

To attach the lens

- 1 Remove the rear and front lens caps and the camera body cap.

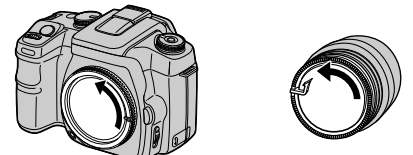

- 2 Align the orange index on the lens barrel with the orange index on the camera (mounting index), then insert the lens into the camera mount and rotate it clockwise until it locks.

- Do not press the lens release button on the camera when mounting the lens.
- Do not mount the lens at an angle.

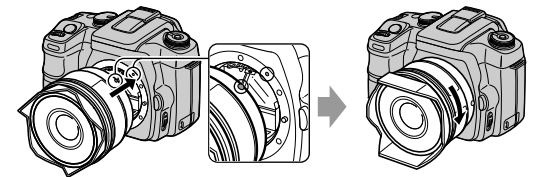

To remove the lens

While pressing and holding the lens release button on the camera, rotate the lens counterclockwise until it stops, then detach the lens.

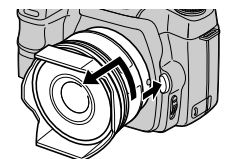

To attach the front lens cap

Attach the front lens cap fully, and pull the string.

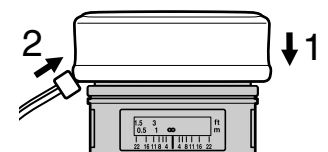

C Focusing

When using the auto focus, the camera focuses the lens automatically.

When focusing manually, set your camera to the manual focus and rotate the focusing ring while looking through the viewfinder. The focus signal in the viewfinder indicates the current condition of the focus.

Note

This lens is a wide angle type. Make sure the shoulder-strap, your fingers, etc., are not in the frame when a picture is taken.

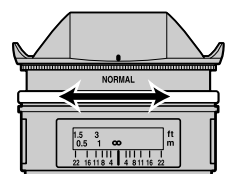

Depth-of-field scale

When focus is set on a subject, anything at that same distance will appear sharp, and anything within a certain range before and beyond the subject will also appear in focus; this is called depth of field. Depth of field depends on the subject distance and aperture you choose and is indicated by the lines on the depth-of-field scale corresponding to the aperture.

- The depth-of-field scale and depth-of-field table are for 35mm-format cameras. The depth-of-field is shallower when you use Digital Single Lens Reflex Cameras equipped with an APS-C sized image sensor.

Depth-of-field table (in meters)

	f/2.8	f/4	f/5.6	f/8	f/11	f/16	f/22
∞	∞ 2.87	∞ 2.05	∞ 1.47	∞ 1.06	∞ 0.77	∞ 0.57	∞ 0.42
1m	1.44 0.77	1.78 0.71	2.72 0.64	11.5 0.56	∞ 0.48	∞ 0.40	∞ 0.33
0.5m	0.57 0.45	0.61 0.43	0.67 0.40	0.80 0.38	1.10 0.34	2.55 0.31	∞ 0.27
0.3m	0.31 0.28	0.32 0.28	0.34 0.27	0.36 0.26	0.39 0.25	0.46 0.23	0.63 0.22
0.25m	0.26 0.24	0.26 0.24	0.27 0.23	0.28 0.23	0.30 0.22	0.33 0.21	0.39 0.20
0.2m	0.20 0.20	0.20 0.19	0.21 0.19	0.21 0.19	0.22 0.18	0.23 0.18	0.25 0.17

D Filter

This lens has four filters, which can be changed where appropriate. Make sure to have one of the filters set when shooting, since the filter is part of the optical system.

NORMAL: This is for general use. Use this filter, unless filter effects are desired.

O56: This is effective for use in shooting distant landscapes with enhanced contrast, when monochrome shooting or using a black and white film.

A12*: This is for use in shooting under the sunlight with a tungsten film. It prevents pictures from becoming blue, and maintains accurate color rendition.

B12*: This is for use in shooting under tungsten lighting with a daylight-color film. It prevents pictures from becoming red, and maintains accurate color rendition.

* No setting required when using a digital single lens reflex camera. Adjust white balance on the camera, when color temperature needs adjusting.

To change filters

Pull the filter-changing ring towards the camera, rotate it, and set the desired filter setting on the filter index.

Note

Rotate the filter-changing ring until it clicks into place. If it is not set properly, a red line appears between the lens hood and filter-changing ring as a warning.

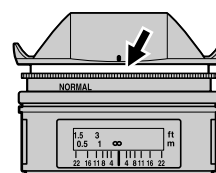

E Exposure compensation

When using a filter other than NORMAL, the amount of light reaching the image sensor (or the film) decreases. This is automatically compensated for in all auto-exposure modes, or in the manual exposure mode, providing that the exposure is adjusted according to the camera's meter index. When shooting in manual mode using a hand-held exposure meter, increase exposure.

Specifications

Name (Model name)	Equivalent 35mm-format focal length* ¹ (mm)	Lens groups- elements	Angle of view 1* ²	Angle of view 2* ²	Minimum focus* ³ (m (feet))	Maximum magnification (×)	Minimum f-stop	Filter	Dimensions (maximum diameter × height) (mm (in.))	Mass (g (oz.))
16mm F2.8 Fisheye (SAL16F28)	24	8-11	180°	110°	0.2 (0.7)	0.15	f/22	Four kinds, integral (NORMAL, O56, A12, B12)	Approx. 75×66.5 (2 15/16×2 5/8)	Approx. 400 (14 1/8)

*¹ The value for equivalent 35mm-format focal length is based on Digital Single Lens Reflex Cameras equipped with an APS-C sized image sensor.

*² The value of angle of view 1 is based on 35mm-format cameras, and that of angle of view 2 is based on Digital Single Lens Reflex Cameras equipped with an APS-C sized image sensor.

*³ Minimum focus is the shortest distance from the image sensor to the subject.

Depending on the lens mechanism, the focal length may change with any change of the shooting distance. The focal length assumes the lens is focused at infinity.

Included items: Lens (1), Front lens cap (1), Rear lens cap (1), Set of printed documentation

Designs and specifications are subject to change without notice.

α is a trademark of Sony Corporation.

Free Manuals Download Website

<http://myh66.com>

<http://usermanuals.us>

<http://www.somanuals.com>

<http://www.4manuals.cc>

<http://www.manual-lib.com>

<http://www.404manual.com>

<http://www.luxmanual.com>

<http://aubethermostatmanual.com>

Golf course search by state

<http://golfingnear.com>

Email search by domain

<http://emailbydomain.com>

Auto manuals search

<http://auto.somanuals.com>

TV manuals search

<http://tv.somanuals.com>