

# XP-SR321/XP-SR320

COMPACT DISC PLAYER

## OPERATING INSTRUCTIONS

**AIWA CO.,LTD.**

 <http://www.aiwa.co.jp>

**8B-HCD-901-01**

010205AYG-O9

Printed in Indonesia

### OWNER'S RECORD

For your convenience, record the model number and the serial number (you will find it on the bottom of your set) in the space provided below. Please refer to them when you contact your Aiwa dealer in case of difficulty.

Model No.
Serial No.

### NOTE

#### FOR USE IN THE U.S.A.

This equipment has been tested and found to comply with the limits for a Class B digital device, pursuant to Part 15 of the FCC Rules. These limits are designed to provide reasonable protection against harmful interference in a residential installation.

This equipment generates, uses, and can radiate radio frequency energy and, if not installed and used in accordance with the instructions, may cause harmful interference to radio communications. However, there is no guarantee that interference will not occur in a particular installation. If this equipment does cause harmful interference to radio or television reception, which can be determined by turning the equipment off and on, the user is encouraged to try to correct the interference by one or more of the following measures:

- Reorient or relocate the receiving antenna.
- Increase the separation between the equipment and receiver.
- Connect the equipment into an outlet on circuit different from that to which the receiver is connected.
- Consult the dealer or an experienced radio/TV technician for help.

### CAUTION

Modifications or adjustments to this product, which are not expressly approved by the manufacturer, may void the user's right or authority to operate this product.

Highlighted letters in the text of this manual correspond to the illustrations.

## PRECAUTIONS

### To maintain good performance

- Do not use the unit in places which are extremely hot, cold, dusty or humid. In particular, do not use or keep the unit in following places.
  - in a high humidity area such as a bathroom
  - near a heater
  - in an area exposed to direct sunlight (e.g., inside a parked car, where it can become extremely hot)
  - near sources of strong magnetism, such as televisions, speakers, or magnets
  - where there is a lot of movement or vibration, such as on a car dashboard or an unstable shelf
- Do not open the battery compartment with wet hands.
- Wipe the unit thoroughly before inserting batteries and after use.
- Do not soak the unit in water.

### For safety

- Do not attempt to disassemble the unit. Laser rays from the optical pickup are dangerous to the eyes.
- Make sure that pins or other foreign object do not get inside the player.
- Take care not to drop the unit or subject it to strong shocks.
- To keep dust from the pickup lens, keep the disc compartment lid closed after use. Never touch the lens.
- If you hear no sound when playing a disc, DO NOT turn the volume up high because music could suddenly start at high volume. Turn the volume control to the lowest level before starting playback and slowly turn it up to the desired level.

### Note on listening with the headphones

- Listen at moderate volumes to avoid hearing damage.
- Do not wear the headphones while driving or cycling. It may create a traffic hazard.
- You should use extreme caution or temporarily discontinue use in potentially hazardous situations, such as walking, jogging, etc.
- Wear them properly; L is left, R is right.

### Note on condensation

If the unit is suddenly moved from a cold place to a warm one, it may result in condensation on the pickup lens and malfunction or playback difficulties. Should this occur, leave the unit for a few hours, then try to playback again.

## MAINTENANCE

### To clean the lens → **A**

If the lens becomes dirty, the player will skip or not play. If this occurs, clean the lens in the following manner.

To remove dust or dry particles, first use a camera lens blower/brush **A** to blow a few times to loosen particles, then gently brush the lens **B** clean. Finish by blowing the lens again.

To remove fingerprints, use a cotton swab dipped in lens cleaning solution. Wipe gently from the center to the edge. Lens cleaning solution is commercially available.

### Note

Take care not to get too much solution on the swab, which could flow into the unit and cause damage.

Pressing too strongly with the swab could scratch or break the lens.

### To clean the discs → **B**

Before playing, wipe the disc from the center outward with a cleaning cloth. After playing, store the disc in its case.

## SPECIFICATIONS

<b>Tracking system</b>	3-beam laser
<b>Laser pickup</b>	Semiconductor laser
<b>D/A conversion</b>	4-times oversampling digital filter + 1-bit DAC
<b>Frequency response</b>	20 – 20,000 Hz
<b>Output</b>	PHONES/LINE OUT jack (stereo mini-jack)
<b>Frequency range</b>	AM: 530/531 kHz – 1,710/1,602 kHz (10 kHz/9 kHz steps) FM: 87.5 – 108 MHz
<b>Maximum output</b>	12 mW + 12 mW (16 ohms at 1 kHz) 500 mV (47 k ohms at 1 kHz)
<b>Power supply</b>	DC 3 V using two size AA (LR6) alkaline batteries DC 2.4 V using two commercially available (Ni-Cd 1.2 V 700 mAh) rechargeable batteries AC house current using the supplied AC adaptor
<b>Maximum outside dimensions</b>	134 (W) × 32.5 (H) × 141 (D) mm (excluding projecting parts and controls) (5 3/8 × 1 5/16 × 5 5/8 in.)
<b>Weight</b>	Approx. 294 g (10.3 oz.) excluding batteries
<b>Accessories</b>	AC adaptor AC-D603 (1) Stereo headphones (1) Carrying case (XP-SR321 only) (1)
<b>AC adaptor AC-D603U</b>	Rated input: AC 120 V, 60 Hz

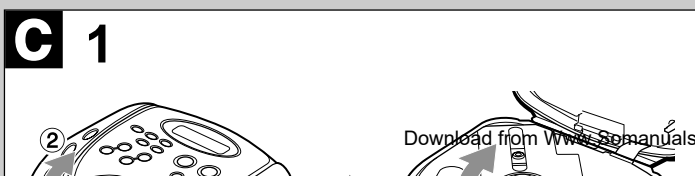
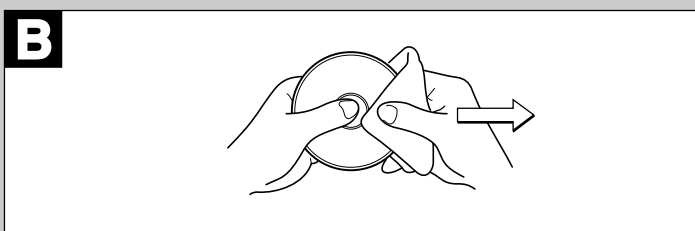
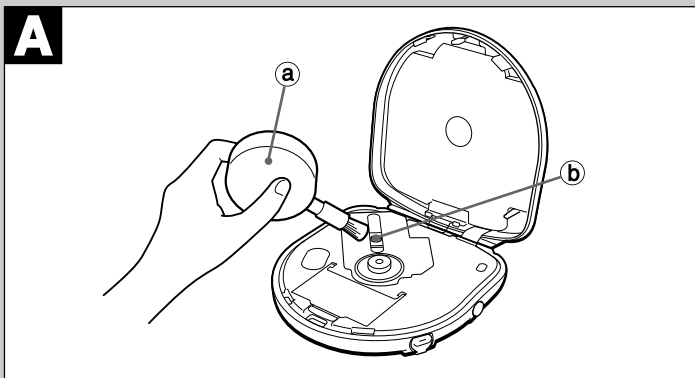

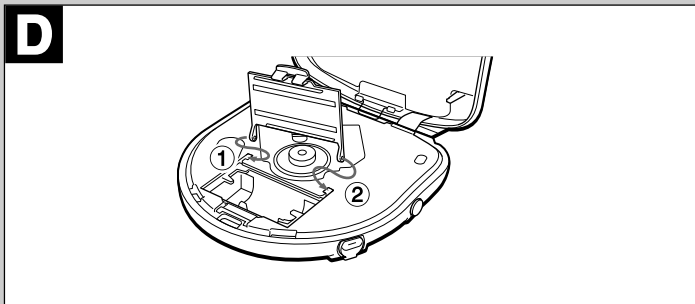
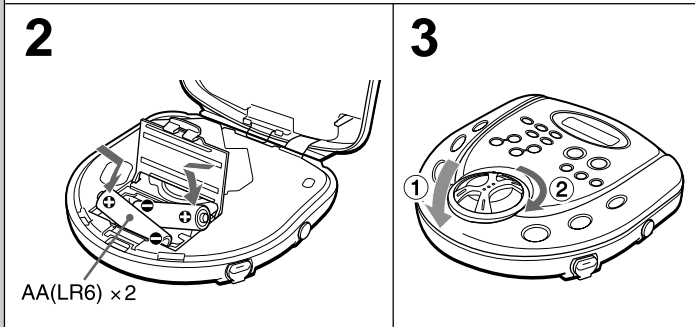
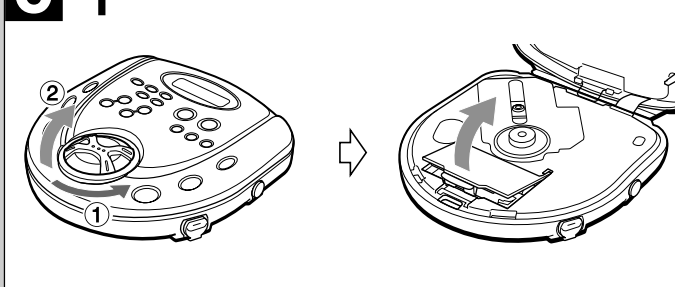

Stereo headphones (1)  
 Carrying case (XP-SR321 only) (1)  
 Rated input: AC 120 V, 60 Hz

**AC adaptor AC-D603U**

The specifications and external appearance of this unit are subject to change without notice.

**USING ON DRY CELL BATTERIES → C**

- 1 Set the dial to the OPEN position to open the disc compartment, then open the battery compartment.
- 2 Insert two size AA (LR6) alkaline batteries with the ⊕ and ⊖ marks correctly aligned. After batteries insertion, close the battery compartment firmly.
- 3 Close the disc compartment tightly and set the dial to the LOCK position.

**Battery replacement**

The battery indicator in the display changes from to to according to the remaining power of the batteries. Replace the batteries when lights. If the unit remains in use after lights, "Lo-bAtt" appears and operation stops.

**To maintain preset data**

When replacing the batteries, the unit will retain the preset station frequencies for about 1 minute. To prevent the erasure of the memories, replace the batteries within 1 minute.

- Before replacing the batteries, turn off the power by pressing .
- DO NOT press any keys while replacing the batteries, otherwise it will not retain preset data for 1 minute.

**Battery life (using alkaline batteries LR6)**

The setting of the E•A•S•S switch	Battery life
48	Approx. 27 hours
12 or OFF	Approx. 19 hours

Battery life may vary depending on conditions of use.

**If the cover of the battery compartment comes off → D**

**Note**  
 Close the battery compartment firmly, or the compact disc may be damaged.

**Note on dry cell batteries**

- Make sure that the ⊕ and ⊖ marks are correctly aligned.
- Do not mix the different types of batteries, or an old battery with a new one.
- To prevent the risk of electrolyte leakage or explosions, never recharge the batteries, apply heat to them, or take them apart.
- When not using the batteries, remove them to prevent needless battery wear.
- If liquid leaks from the batteries, wipe thoroughly to remove.

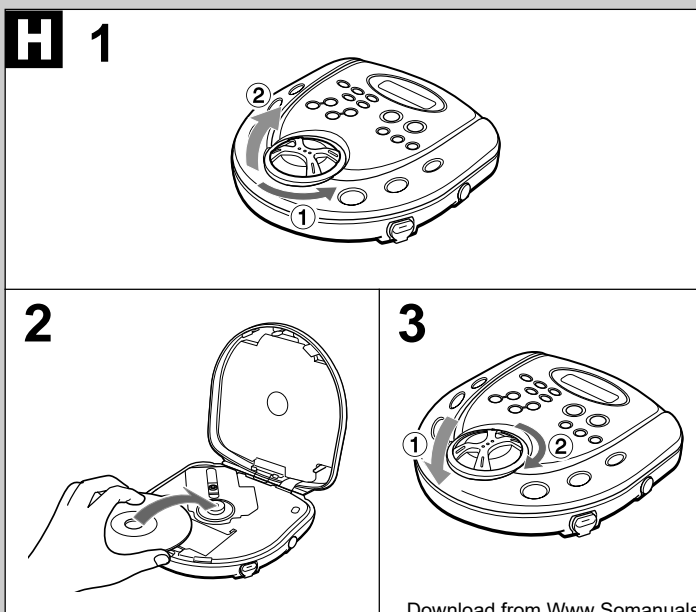
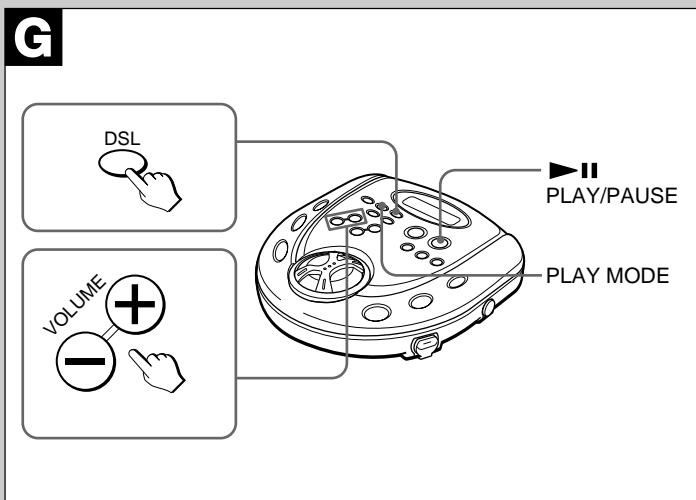
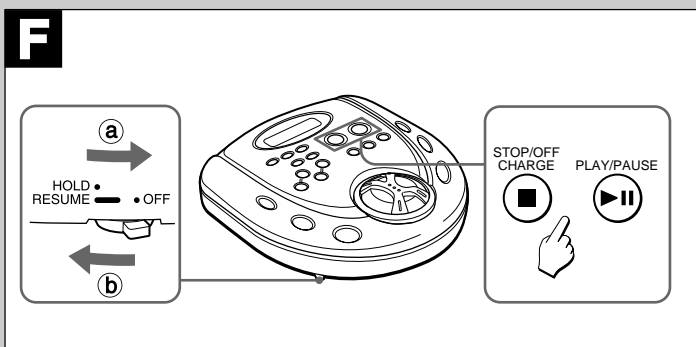
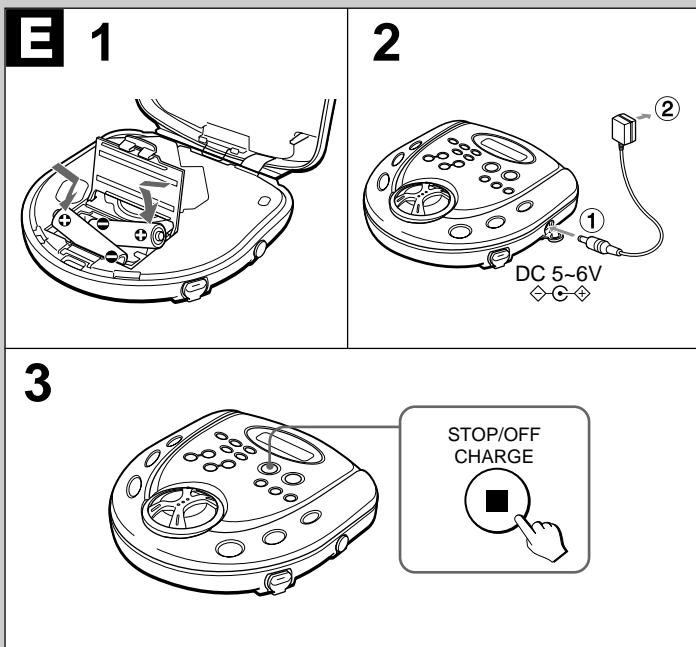

## USING ON RECHARGEABLE BATTERIES → E

- Be sure to use size AA Ni-Cd 1.2V 700 mAh rechargeable batteries, which are commercially available.
- Be sure to read the instructions of the purchased rechargeable batteries before use.
- When using on rechargeable batteries for the first time, charge them until the battery indicator goes out.
- Before charging the batteries, close the disc compartment. You cannot charge the batteries while it is opened.

**1 Insert the rechargeable batteries with the ⊕ and ⊖ marks correctly aligned.**

**2 Connect the AC adaptor.**

Pull out the rubber cap before connecting the adaptor.

① to DC 5 ~ 6 V jack

② to a wall outlet

**3 Keep ■STOP/OFF/CHARGE pressed for about 1 second to start charging.**

"C-On" appears, and the battery indicator blinks.

When charging is completed, "C-OFF" flashes a few times, and the battery indicator goes out.

After charging, disconnect the AC adaptor.

### Time to recharge the batteries

Recharge the batteries when ( ) lights. If the unit remains in use after ( ) lights, "Lo-bAtt" appears and the current operation stops.

### To stop charging

Press ■STOP/OFF/CHARGE during charging.

### Force charging

When the recharging stops after only few minutes or the batteries cannot be fully recharged, press ■STOP/OFF/CHARGE while pressing PLAY MODE to start force charging.

### ATTENTION:

The product you have purchased can be powered by nickel cadmium batteries which are recyclable. At the end of their useful life, under various state and local laws, it is illegal to dispose of these batteries into your municipal waste stream.

Please call 1-800-289-2492 for information on how to recycle these batteries.

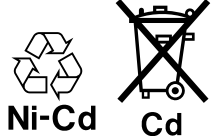

## USING ON AC HOUSE CURRENT

Connect the supplied AC adaptor in the same way as when recharging the batteries.

During operation on AC house current, all of the battery indicator disappears.

## BEFORE PLAYBACK

### HOLD switch → E

Release the HOLD switch before playback. → a

When not using the unit, set the HOLD switch to the HOLD position. → b

Accidentally pressed button will not function.

If buttons are pressed when the HOLD switch is set to the HOLD position, "HOLD" flashes in the display.

### Turning on and off → F

#### Turning the power on

Press ►||PLAY/PAUSE. Power is turned on and playback starts.

#### Note

"Err" appears on the display in the following cases:

– When you try to play the unit without a disc in the disc compartment.

– When you play a disc placed upside-down or a defective disc.

#### Turning the power off

If no new operations are done within 30 seconds from the end of last operation, the power is turned off automatically. (Auto power off function)

- You can turn off the power by pressing ■STOP/OFF/CHARGE before it is automatically turned off.

### Standby mode → E

When an operation finishes, the unit goes into standby mode until the auto power off function automatically turns off the power.

To enter standby mode, press ►||PLAY/PAUSE to start playback, then press ■STOP/OFF/CHARGE.

### Adjusting the sound → G

#### Volume

Press + to increase the volume.

Press – to decrease the volume.

#### DSL

Press DSL repeatedly for more powerful sound and deeper bass.

Manual Search and Download

DSL : Deep bass is strongly emphasized.

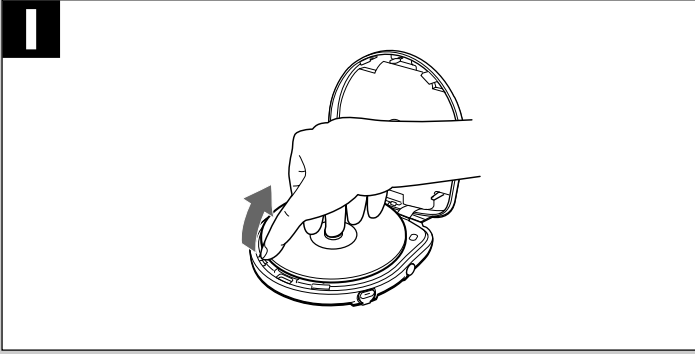

### DSL

Press DSL repeatedly for more powerful sound and deeper bass.

DSL  : Deep bass is emphasized.

DSL  : Deep bass is strongly emphasized.

DSL  : Normal sound

### Signal sound function

You can check the operation by beep sound when you press an operation button.

The signal sound function is activated when you purchase this unit.

To cancel the signal sound function, press  PLAY/PAUSE while pressing PLAY MODE to display "b - F F" while the power is off.

To resume the beep sound, repeat this procedure.

### Inserting a disc →

- 1 Set the dial to the OPEN position to open the disc compartment.
- 2 Place a disc in the center with the label side facing up.
- 3 Close the disc compartment tightly and set the dial to the LOCK position.

### To remove the disc →

Pick up the disc, holding its edge, while pressing the pivot gently.

### Note

- The unit may not play a CD-R/RW disc that is recorded on personal computers or some kinds of CD-R/RW recorders because of differences in recording platforms.
- Do not attach any seal or label to either side (the recordable side or the labeled side) of a CD-R/RW disc. It may cause malfunction.

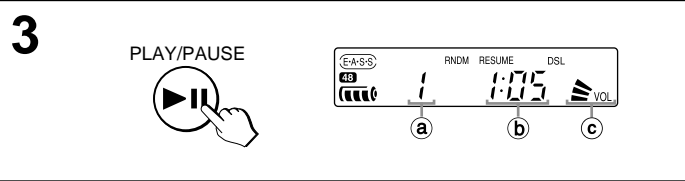
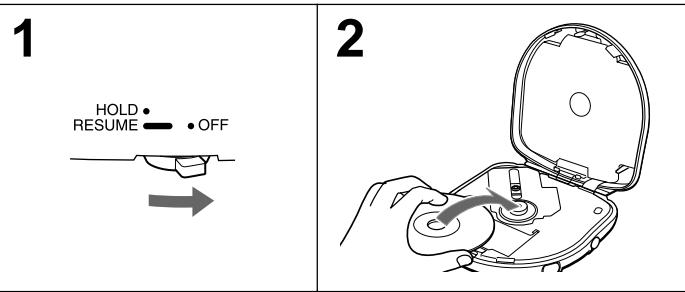
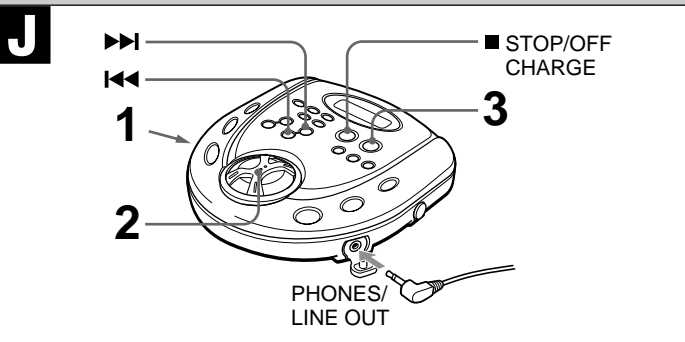

## PLAYBACK → J

Pull out the rubber cap and connect the supplied headphones to the PHONES/ LINE OUT jack.  
The amplified speaker system can be connected instead to enjoy the CD sound.

- 1 Release **HOLD**.
- 2 Place a disc.
- 3 Press **▶||** **PLAY/PAUSE**.  
Playback starts from the first track.
  - a track number
  - b elapsed playing time
  - c volume indicator

### Basic operation

To stop	Press <b>■</b> <b>STOP/OFF/CHARGE</b> .
To pause	Press <b>▶  </b> <b>PLAY/PAUSE</b> . To resume, press it again.
To search for the beginning of a track	Press <b>◀◀</b> or <b>▶▶</b> .
To locate a desired passage	Keep <b>◀◀</b> or <b>▶▶</b> pressed. Release the button at the start of desired passage.

### Display during playback → K

Press **ENTER/DISP** during playback to change the display as follows.

- ① Track display and elapsed playing time (normal display)
- ↓
- ② Track display and remaining playing time of the track in play
- ↓
- ③ Remaining number of tracks and remaining playing time

The time is not displayed in following cases.

- When trying to program tracks beyond No.32.
- When the total remaining time of the programmed tracks is over 100 minutes.

### E•A•S•S 3× (Electronic Anti-Shock System) → L

The E•A•S•S 3× function reduces skipping or muting of the sound when the unit is subjected to shocks.

The player keeps about 48 seconds or 12 seconds of playback sound in its memory.

When you start playback, the unit keeps 48 seconds in memory.

**To keep 12 seconds in the memory**, press E•A•S•S repeatedly until **E•A•S•S** and **12** appear.

**To cancel the E•A•S•S 3× function**, press E•A•S•S repeatedly until E•A•S•S appears.

#### Note

- Before jogging with this unit, allow sufficient time for the memory buffer to fill up completely (ideally about 20 seconds).  
Continuous shock or vibration may cause the sound to be interrupted even if the E•A•S•S 3× function is activated. This is normal and not a malfunction. Should you experience an interruption in sound, stabilize the unit for a few seconds, then resume your activity.
- When the E•A•S•S 3× function is activated, motor noise is heard as the motor periodically rotates at high speed during playback. This is not a malfunction.
- When E•A•S•S is pressed, the unit will pause for about 2 seconds.
- When the unit is set to E•A•S•S-off or -12 second mode, the quality of the sound will be better than E•A•S•S-48 second mode.

### Resume function → M

Set the **HOLD** switch to **RESUME**.

**RESUME** appears, and you can start playback from the point where you stopped playback by pressing **■** **STOP/OFF/CHARGE**.

When the resume function is on, all-track repeat is selected automatically.

**To cancel resume play**, set the **HOLD** switch to **OFF**.

#### Note

- Resume play may start at a point about 30 seconds behind or ahead the stopped point. Resume play may not operate if you stopped at the last 30 seconds of the final track.
- Resume play will be canceled if you open the disc compartment. If the unit is turned off, resume play will not be canceled. In this case, be sure to set the **HOLD** switch to **OFF** before changing discs.

### Random play → N

Press **PLAY MODE** while in standby mode to display **RNDM**.

Tracks on the disc are played in random order.

**To cancel random play**, press **PLAY MODE** while in standby mode.

**RNDM** display changes to **RNDM**.

#### Note

- You cannot back to previous track by pressing **◀◀** during random play.
- You cannot select one-track repeat during random play.

### Repeat play → M

Press **PLAY MODE** during playback to select repeat play as follows.

◁ 1 : one-track repeat

◁ : all-track repeat

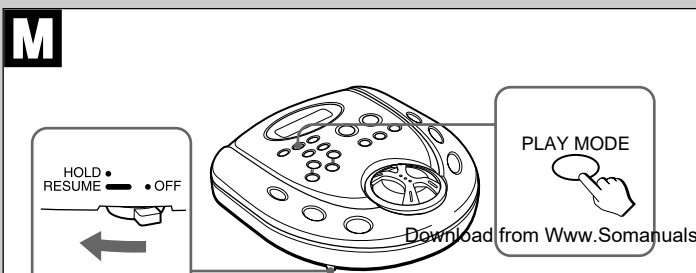
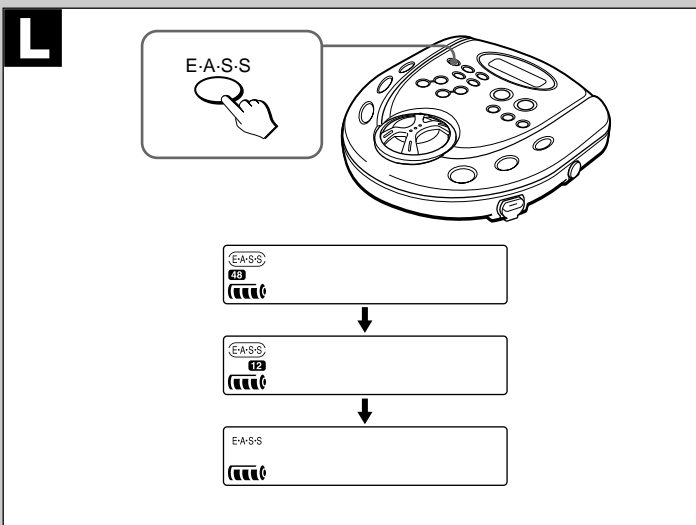
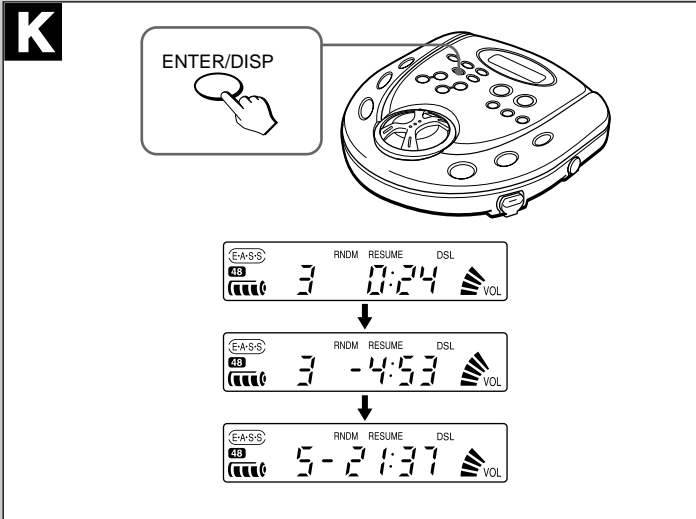

### Repeat play

Press PLAY MODE during playback to select repeat play as follows.

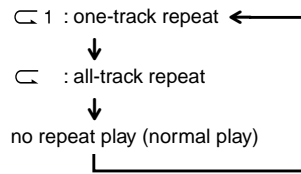

### Note

When the unit is set to E•A•S•S-12 or -48 second mode, if PLAY MODE is pressed at the end of the track to select the other play mode, the unit may not change to the other mode properly.

## PROGRAM PLAY → N

Up to 24 tracks can be chosen for program play.

**1 Press ENTER/DISP while in standby mode to display "P-01".**

**2 Select the desired track by pressing I◀◀ and ▶▶I.**

Ⓐ track number

Ⓑ program number

**3 Press ENTER/DISP within 8 seconds.**

If it is not pressed within 8 seconds, the track number changes to 00. Repeat the procedure from step 2 again.

**4 Repeat steps 2 and 3 to program more tracks.**

**5 Press ▶IIPLAY/PAUSE to start program play.**

### To stop program play

Press ■ STOP/OFF/CHARGE.

### To add tracks to the program

Repeat steps 2 and 3 before you proceed to step 5. You can add tracks to the end of the program.

### To erase the program

Press ■ STOP/OFF/CHARGE while in standby mode.

### To check the programmed tracks

Press ENTER/DISP repeatedly before you proceed to step 5.

The number of each programmed track will be displayed in order of playback.

### Note

- The program is also erased when the disc compartment is opened or the auto power off function turns the power off.
- When 24 tracks are programmed, "P-FULL" appears, and no more tracks may be added.
- You cannot back to the previous track by holding I◀◀ pressed during program play.
- Repeat play and random play can be performed during program play.

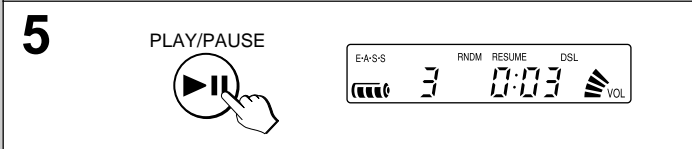
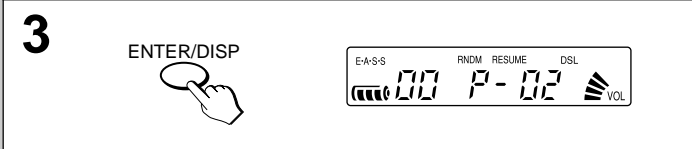
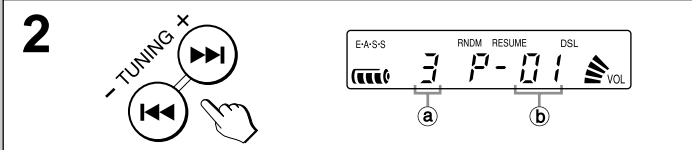
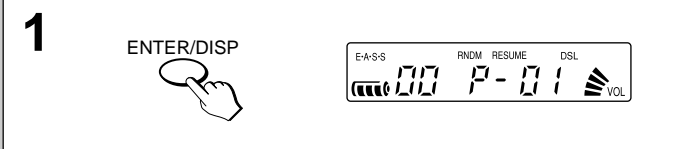
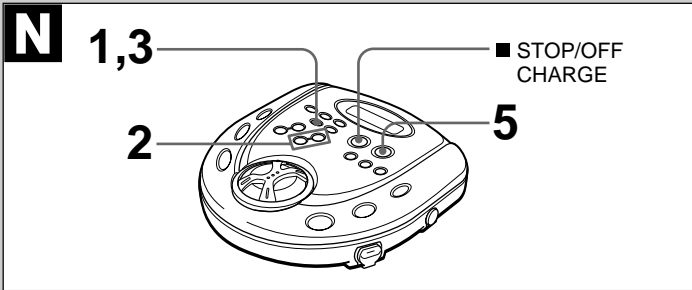
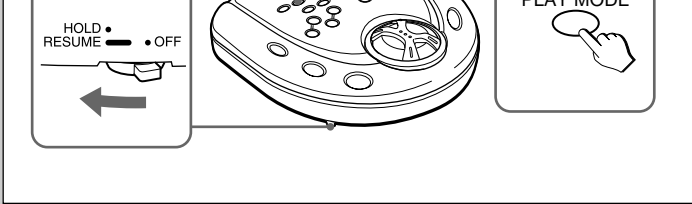

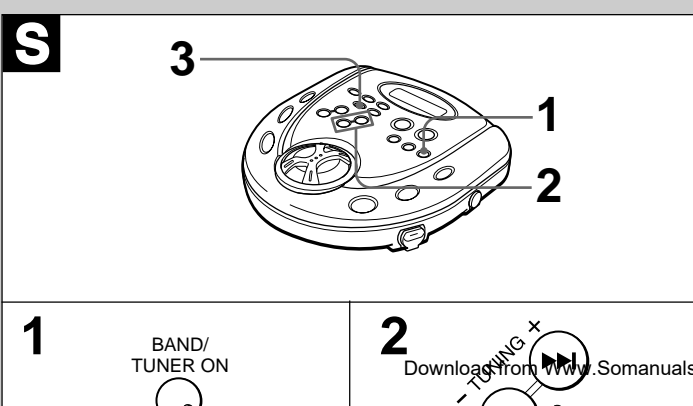
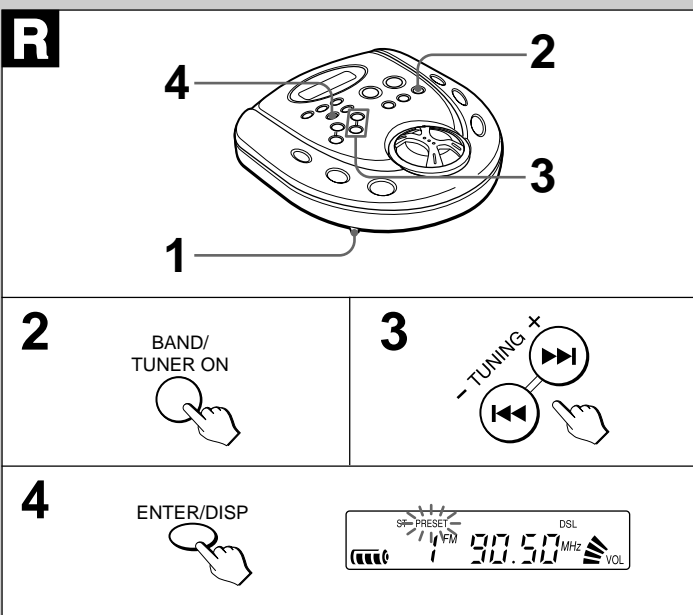
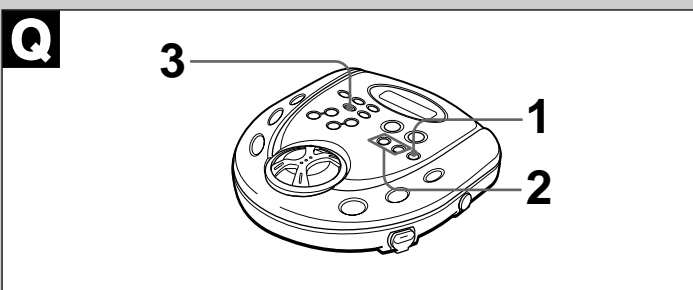
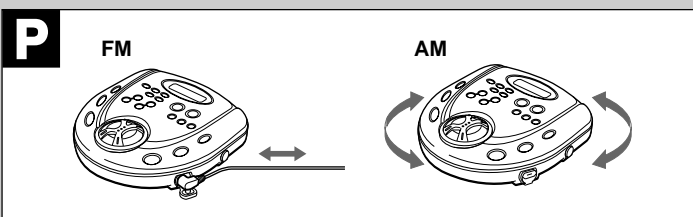
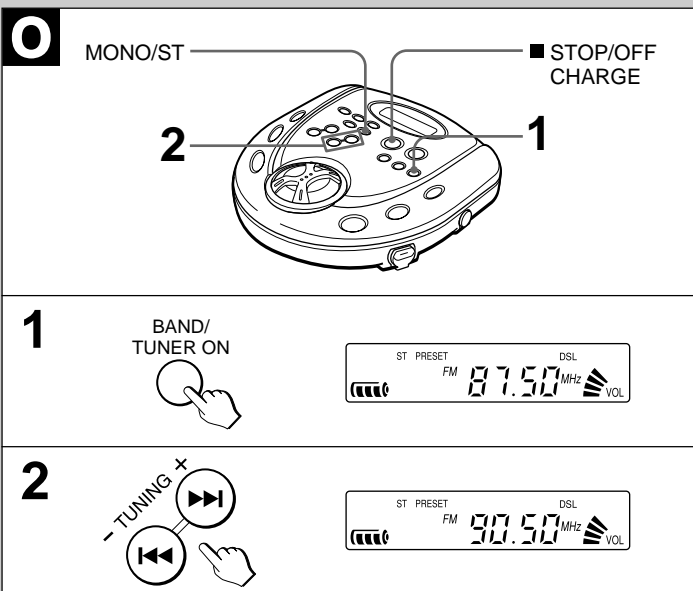

## RADIO RECEPTION

### Tuning in to a station → **O**

- 1 Press **BAND TUNER ON** repeatedly to select AM or FM.
- 2 Press **TUNING + (▶▶)** or **-(◀◀)** to tune in to a station.

After listening, press **■ STOP/OFF/CHARGE** to turn off the radio.

### For quick tuning

Keep either **TUNING + (▶▶)** or **-(◀◀)** pressed for about 1 second. When a station is tuned in to, the frequency stops automatically. However, it does not stop if the broadcast signal is weak.

### For better reception → **Q**

FM: The headphone cord functions as the FM antenna. Keep it extended.  
AM: Turn the unit to find the position which gives the best reception.

### To listen to an FM stereo broadcasting

When a tuned in station is in stereo, ST changes to **ST**.  
When the FM stereo signal is weak and distorted, press **MONO/ST**. ST goes out and the sound will be heard in monaural but distortion will be reduced.

### Note

- Do not open the disc compartment during radio reception. The buttons will be deactivated.
- The power is turned off automatically if no operation is made after 5 or 6 hours from the last operation during radio reception.

### Changing AM steps → **Q**

Radio broadcasts have different frequency ranges and changes in different steps in different countries.

This unit is factory-set to 10 kHz steps on AM. When using the unit where the AM step changes to 9 kHz, change it as follows.

- 1 When the power is off, keep **BAND TUNER ON** pressed for 8 seconds. "S-10" is displayed for 5 seconds.
- 2 While "S-10" is displayed, press **PRESET CALL UP/DOWN** to display "S-9".
- 3 Press **ENTER/DISP** within 5 seconds.

To resume to 10 kHz, change in the similar way.

### Note

When the AM step is changed, stations that you preset are erased.

## PRESETTING STATIONS

### Automatic presetting → **R**

You can preset up to total of 30 stations on AM and FM.

- 1 Release **HOLD**.
- 2 Press **BAND TUNER ON** to turn on the radio.
- 3 Press **TUNING + (▶▶)** or **-(◀◀)** to exit preset mode.
- 4 Keep **ENTER/DISP** pressed for more than 5 seconds.

The unit searches for and memorizes the receivable stations.  
Automatic presetting ends after 30 stations are preset.

To stop presetting before 30 stations are preset, press **■ STOP/OFF/CHARGE**.

After listening, press **■ STOP/OFF/CHARGE**.

### If there is a station you wish to skip during presetting

When a station is tuned in, scanning stops and the tuned station is heard for 5 seconds. Press **TUNING + (▶▶)** within these 5 seconds to skip this station.

### Note

When broadcast signals are very weak, stations cannot be preset automatically. Preset them manually.

### Manual presetting → **S**

You can preset up to total of 30 stations on AM and FM.

- 1 Press **BAND TUNER ON** repeatedly to select AM or FM.
  - 2 Press **TUNING + (▶▶)** or **-(◀◀)** to tune in to a station.
  - 3 Press **ENTER/DISP** to preset the station.
- ⓐ Preset number

To preset more stations, repeat steps 2 and 3.

### Listening to preset stations → **T**

- 1 Press **BAND TUNER ON** repeatedly to select AM or FM.
- 2 Press **PRESET CALL UP/DOWN** repeatedly to select the preset number.

After listening, press **■ STOP/OFF/CHARGE** to turn off the radio.

### Changing the presetting

- 1 Press **PRESET CALL UP/DOWN** repeatedly to select the preset number you wish to change.
- 2 Keep **ENTER/DISP** pressed for 1 or more seconds until the preset number and the frequency flash.
- 3 While the preset number is flashing, press **TUNING + (▶▶)** or **-(◀◀)** to tune in to a station.
- 4 Press **ENTER/DISP** to preset the station on the selected preset number.

If the flashing stops, repeat the procedure from step 2.

### Erasing the presettings one by one

Press **■ STOP/OFF/CHARGE** after step 2 in "Changing the presetting" above

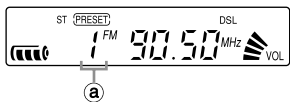
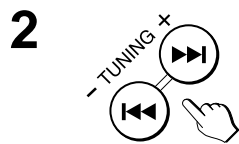
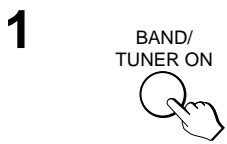

**T**

■ STOP/OFF  
CHARGE

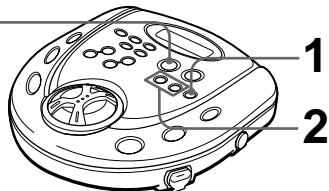

**U**

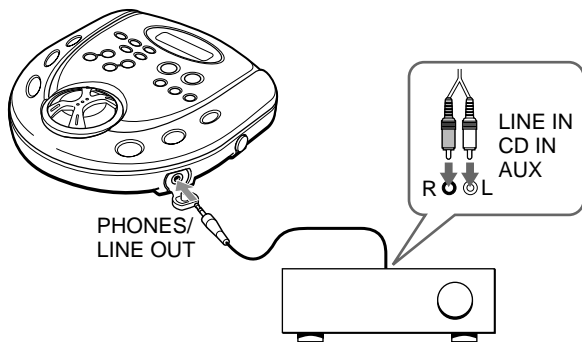

4 Press TUNING +/- to preset the station on the selected preset number.

If the flashing stops, repeat the procedure from step 2.

#### Erasing the presets one by one

Press ■ STOP/OFF/CHARGE after step 2 in "Changing the presetting" above. Each preset station is erased. All the settings move up by ones and the preset numbers are refreshed.

#### Erasing all of the presetting

Keep ENTER/DISP pressed, then press BAND TUNER ON when the frequency and preset number starts flashing.

### CONNECTING TO AN EXTERNAL UNIT → **U**

Use a commercially available connection cord which has a 3.5  $\varnothing$  stereo mini-plug at one end and two phono plugs at the other end.

Connect the stereo mini-plug to the PHONES/LINE OUT jack of the unit and connect the phono plugs to the analog input terminals of the external unit, such as the amplifier or the equipment with the built-in amplifier. The CD sound can be heard through the connected audio system.

#### Note

- Turn off the power of both units before connection.
- DO NOT connect to the PHONO inputs of an amplifier (with a built-in phonoequalizer-amplifier).
- Adjust the volume and DSL on this unit.



## Free Manuals Download Website

<http://myh66.com>

<http://usermanuals.us>

<http://www.somanuals.com>

<http://www.4manuals.cc>

<http://www.manual-lib.com>

<http://www.404manual.com>

<http://www.luxmanual.com>

<http://aubethermostatmanual.com>

Golf course search by state

<http://golfingnear.com>

Email search by domain

<http://emailbydomain.com>

Auto manuals search

<http://auto.somanuals.com>

TV manuals search

<http://tv.somanuals.com>