

KDL-V26A12U

Quick Start Guide

Follow steps **1** through **6** to quickly set up the TV for use.
For more information, see the Operating Instructions supplied with this manual.

© 2005 Sony Corporation Printed in Spain

1 Checking the accessories

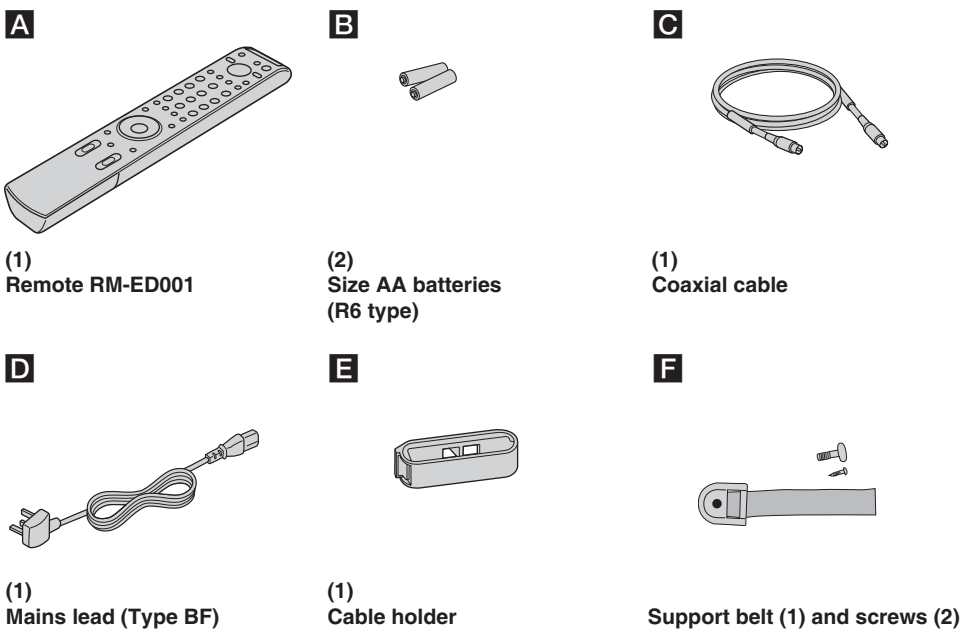

2 Inserting batteries into the remote

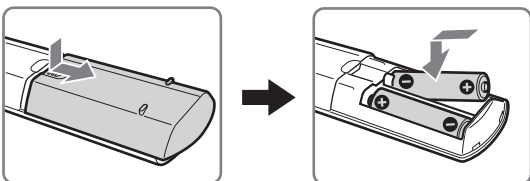

3 Connecting an aerial/VCR

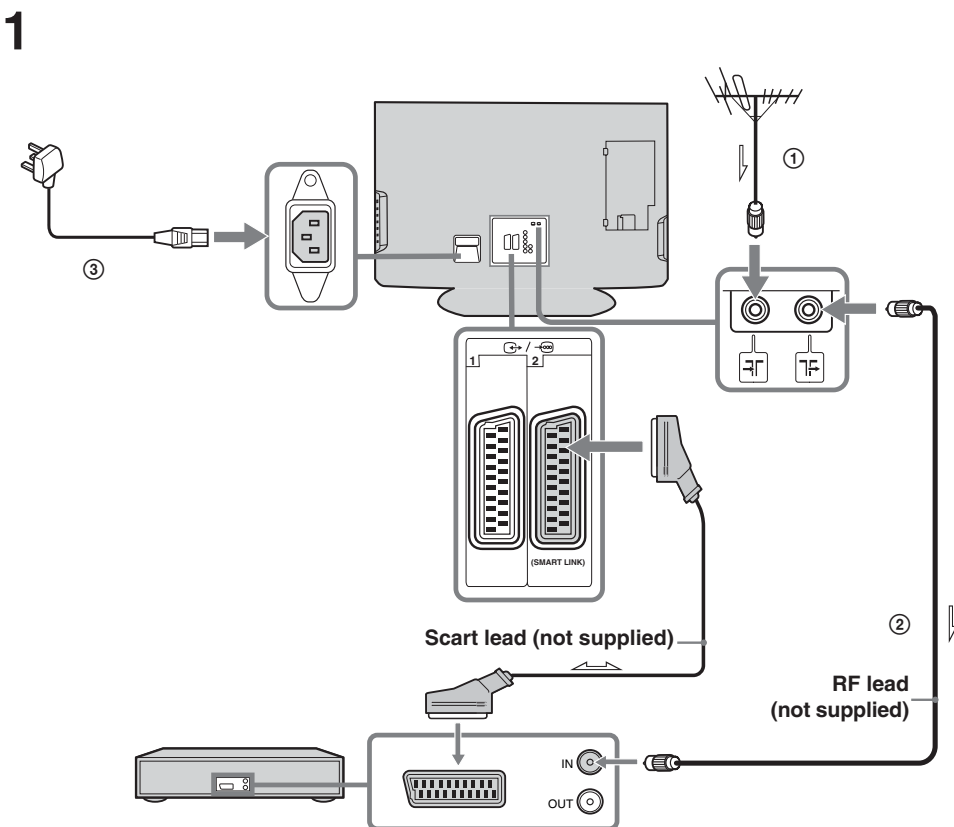

2

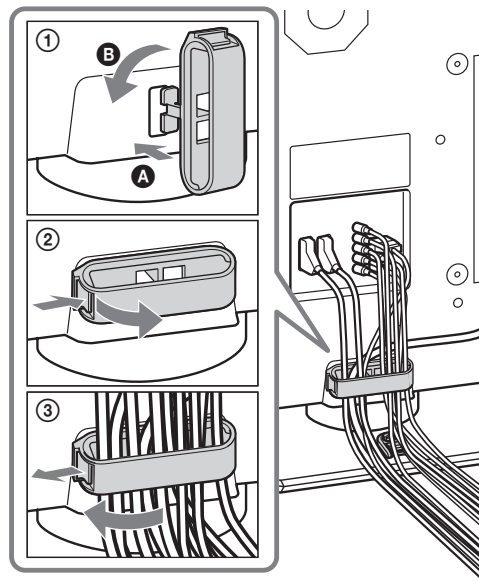

4

Preventing the TV from toppling over

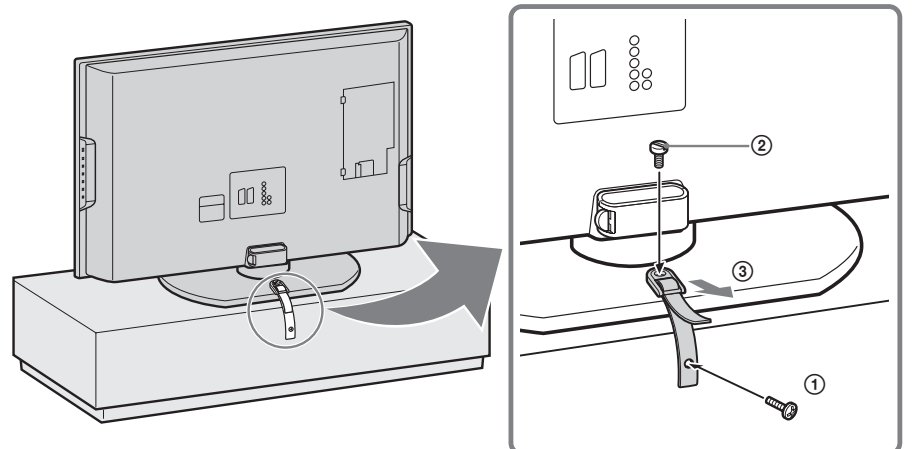

5

Switching on the TV

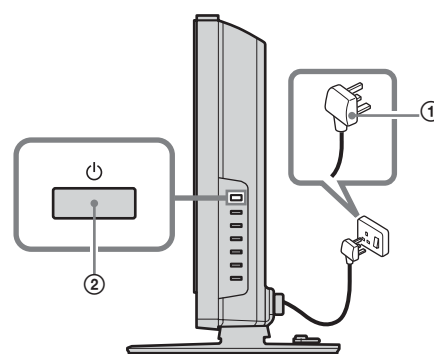

6

Auto-tuning the TV

1

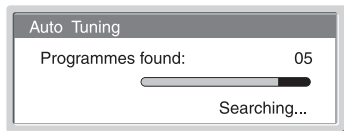
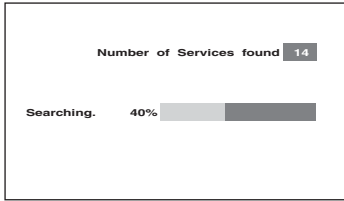
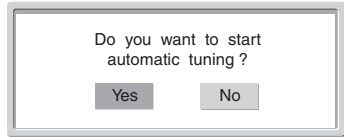

Select "Yes"

2

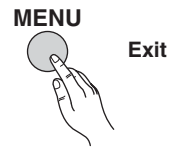
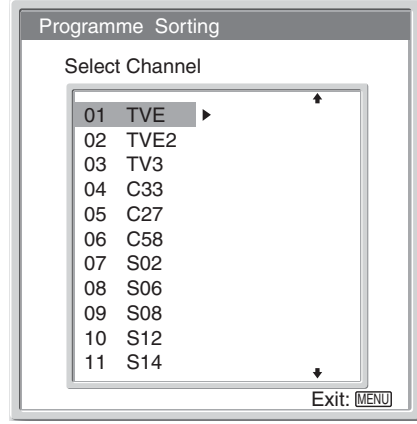

Exit

 **Your TV is now ready for use.**

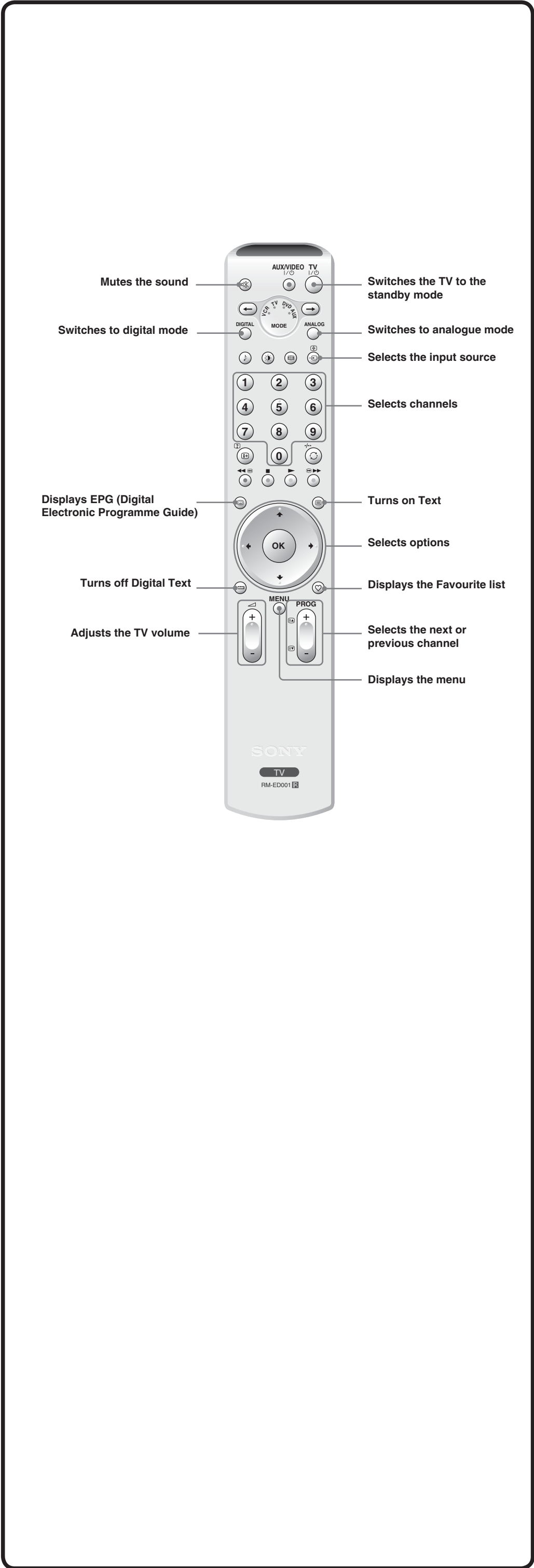

Free Manuals Download Website

<http://myh66.com>

<http://usermanuals.us>

<http://www.somanuals.com>

<http://www.4manuals.cc>

<http://www.manual-lib.com>

<http://www.404manual.com>

<http://www.luxmanual.com>

<http://aubethermostatmanual.com>

Golf course search by state

<http://golfingnear.com>

Email search by domain

<http://emailbydomain.com>

Auto manuals search

<http://auto.somanuals.com>

TV manuals search

<http://tv.somanuals.com>