

FD Trinitron
WEGA

KD-30XS955 | KD-32XS945 | KD-34XS955 | KD-36XS955

Operating Instructions



MEMORY STICK®

WARNING

To reduce the risk of fire or shock hazard, do not expose the TV to rain or moisture.

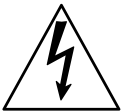

This symbol is intended to alert the user to the presence of uninsulated "dangerous voltage" within the product's enclosure that may be of sufficient magnitude to constitute a risk of electric shock to persons.



This symbol is intended to alert the user to the presence of important operating and maintenance (servicing) instructions in the literature accompanying the appliance.

CAUTION

TO PREVENT ELECTRIC SHOCK, MATCH WIDE BLADE OF PLUG TO WIDE SLOT, FULLY INSERT.

CAUTION

When using TV games, computers, and similar products with your TV, keep the brightness and contrast functions at low settings. If a fixed (non-moving) pattern is left on the screen for long periods of time at a high brightness or contrast setting, the image can be permanently imprinted onto the screen. Continuously watching the same program can cause the imprint of station logos onto the TV screen. These types of imprints are not covered by your warranty because they are the result of misuse.

Warning (KD-34XS955 only)

The CRT in this product employs a protective film on the face. This film must not be removed as it serves a safety function and removal will increase the risk of serious injury.

Note on Caption Vision

This television receiver provides display of television closed captioning in accordance with §15.119 of the FCC rules.

Note on Cleaning the TV

Clean the TV with a soft, dry cloth. Never use strong solvents such as thinner or benzene, which might damage the finish of the cabinet.

Note to CATV System Installer

This reminder is provided to call the CATV system installer's attention to Article 820-40 of the National Electrical Code (NEC) that provides guidelines for proper grounding and, in particular, specifies that the cable ground shall be connected to the grounding system of the building, as close to the point of cable entry as practical.

Use of this television receiver for other than private viewing of programs broadcast on UHF or VHF or transmitted by cable companies for the use of the general public may require authorization from the broadcaster/cable company and/or program owner.

NOTIFICATION

This equipment has been tested and found to comply with the limits for a Class B digital device pursuant to Part 15 of the FCC Rules. These limits are designed to provide reasonable protection against harmful interference in a residential installation. This equipment generates, uses, and can radiate radio frequency energy and, if not installed and used in accordance with the instructions, may cause harmful interference with radio communications. However, there is no guarantee that interference will not occur in a particular installation. If this equipment does cause harmful interference to radio or television reception, which can be determined by turning the equipment off and on, the user is encouraged to try to correct the interference by one or more of the following measures:

- Reorient or relocate the receiving antennas.
- Increase the separation between the equipment and receiver.
- Connect the equipment into an outlet on a circuit different from that to which the receiver is connected.
- Consult the dealer or an experienced radio/TV technician for help.

You are cautioned that any changes or modifications not expressly approved in this manual could void your authority to operate this equipment.

Installing

- To prevent internal heat buildup, do not block the ventilation openings.
- Do not install the TV in a hot or humid place, or in a place subject to excessive dust or mechanical vibration.
- The AC power cord is attached to the rear of the TV with hooks. Do not attempt to remove the cord from these hooks. Doing so could cause damage to the TV.

Owner's Record

The model and serial numbers are provided on the front of this instruction manual and at the rear of the TV. Refer to them whenever you call upon your Sony dealer regarding this product.

Note

This digital television is capable of receiving analog basic, digital basic and digital premium cable television programming by direct connection to a cable system providing such programming. A security card provided by your cable operator is required to view encrypted digital programming. Certain advanced and interactive digital cable services such as video-on-demand, a cable operator's enhanced program guide and data-enhanced television services may require the use of a set-top box. For more information call your local cable operator.

This television also includes a QAM demodulator which should allow you to receive unscrambled digital cable television programming via subscription service to a cable service provider. Availability of digital cable television programming in your area depends on the type of programming and signal provided by your cable service provider.

IMPORTANT SAFEGUARDS

For your protection, please read these instructions completely, and keep this manual for future reference.

Carefully observe and comply with all warnings, cautions and instructions placed on the set, or described in the operating instructions or service manual.

WARNING

To guard against injury, the following basic safety precautions should be observed in the installation, use, and servicing of the set.

Use

Power Sources

This set should be operated only from the type of power source indicated on the serial/model plate. If you are not sure of the type of electrical power supplied to your home, consult your dealer or local power company. For those sets designed to operate from battery power, refer to the operating instructions.



Grounding or Polarization

This set is equipped with a polarized AC power cord plug (a plug having one blade wider than the other), or with a three-wire grounding type plug (a plug having a third pin for grounding). Follow the instructions below:

For the set with a polarized AC power cord plug

This plug will fit into the power outlet only one way. This is a safety feature. If you are unable to insert the plug fully into the outlet, try reversing the plug. If the plug should still fail to fit, contact your electrician to have a suitable outlet installed. Do not defeat the safety purpose of the polarized plug by forcing it in.



Alternate Warning

For the set with a three-wire grounding type AC plug

This plug will only fit into a grounding-type power outlet. This is a safety feature. If you are unable to insert the plug into the outlet, contact your electrician to have a suitable outlet installed. Do not defeat the safety purpose of the grounding plug.

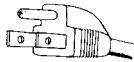

Overloading

Do not overload wall outlets, extension cords or convenience receptacles beyond their capacity, since this can result in fire or electric shock.

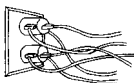

Always turn the set off when it is not to be used. When the set is left unattended and unused for long periods of time, unplug it from the wall outlet as a precaution against the possibility of an internal malfunction that could create a fire hazard.



Do not disconnect the antenna or the power cord during a heavy storm. Lightning may strike while you are holding the cable or cord, causing serious injury. Turn off your TV and wait for the weather to improve.

Memory Stick

To protect small children from injury from Memory Stick Media, remove all Memory Stick media from the TV's Memory Stick slot and store it in a safe location when it is not in use.

Object and Liquid Entry

Never push objects of any kind into the set through the cabinet slots as they may touch dangerous voltage points or short out parts that could result in a fire or electric shock. Never spill liquid of any kind on the set.

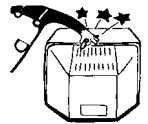

Attachments

Do not use attachments not recommended by the manufacturer, as they may cause hazards.

Do not place any objects, especially heavy objects, on top of the set. The object may fall from the set, causing injury.

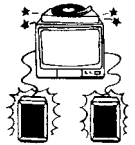

Cleaning

Unplug the set from the wall outlet before cleaning or polishing it. Do not use liquid cleaners or aerosol cleaners. Use a cloth lightly dampened with water for cleaning the exterior of the set.



If a snapping or popping sound from a TV set is continuous or frequent while the TV is operating, unplug the TV and consult your dealer or service technician. It is normal for some TV sets to make occasional snapping or popping sounds, particularly when being turned on or off.

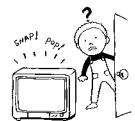

Installation

Always use two or more people to lift or move the set. The set is heavy and the bottom surface is flat. Serious injury can result from trying to move the set by yourself alone, or from unsteady handling. Install the set on a stable, level surface.

Water and Moisture

Do not use power-line operated sets near water — for example, near a bathtub, washbowl, kitchen sink, or laundry tub, in a wet basement, or near a swimming pool, etc.

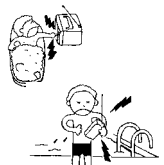

Accessories

Do not place the set on an unstable cart, stand, tripod, bracket, table or shelf. The set may fall, causing serious injury to a child or an adult, and serious damage to the set. Use only a cart or stand recommended by the manufacturer for the specific model of TV. Any mounting of the product should follow the manufacturer's instructions, and should use a mounting accessory recommended by the manufacturer. An appliance and cart combination should be moved with care. Quick stops, excessive force, and uneven surfaces may cause the appliance and cart combination to overturn.



Disconnect all cables and cords from the set before attempting to move the set.

Do not allow children or pets to climb up onto, or push against, the set. The set may fall, causing serious injury.

Ventilation

The slots and openings in the cabinet and in the back or bottom are provided for necessary ventilation. To ensure reliable operation of the set, and to protect it from overheating, these slots and openings must never be blocked or covered.

- ❑ Never cover the slots and openings with a cloth or other materials.
- ❑ Never block the slots and openings by placing the set on a bed, sofa, rug or other similar surface.
- ❑ Never place the set in a confined space, such as a bookcase, or built-in cabinet, unless proper ventilation is provided.
- ❑ Do not place the set near or over a radiator or heat register, or where it is exposed to direct sunlight.

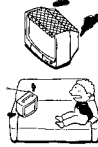

Power Cord Protection

Do not allow anything to rest on or roll over the power cord, and do not place the set where the power cord is subject to wear or abuse.



Antennas

Outdoor Antenna Grounding

If an outdoor antenna is installed, follow the precautions below. An outdoor antenna system should not be located in the vicinity of overhead power lines or other electric light or power circuits, or where it can come in contact with such power lines or circuits.

WHEN INSTALLING AN OUTDOOR ANTENNA SYSTEM, EXTREME CARE SHOULD BE TAKEN TO KEEP FROM CONTACTING SUCH POWER LINES OR CIRCUITS AS CONTACT WITH THEM IS ALMOST INVARIABLY FATAL.

Be sure the antenna system is grounded so as to provide some protection against voltage surges and built-up static charges. Section 810 of the National Electrical Code (NEC) in USA and Section 54 of the Canadian Electrical Code in Canada provide information with respect to proper grounding of the mast and supporting structure, grounding of the lead-in wire to an antenna discharge unit, size of grounding conductors, location of antenna discharge unit, connection to grounding electrodes, and requirements for the grounding electrode.

Antenna Grounding According to the National Electrical Code, ANSI/NFPA 70

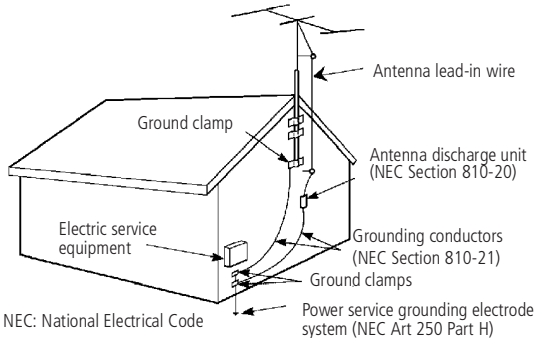

NEC: National Electrical Code

Lightning

For added protection for this television receiver during a lightning storm, or when it is left unattended and unused for long periods of time, unplug it from the wall outlet and disconnect the antenna. This will prevent damage to the receiver due to lightning and power line surges.

Service

Damage Requiring Service

Unplug the set from the wall outlet and refer servicing to qualified service personnel under the following conditions:

- ❑ When the power cord or plug is damaged or frayed.
- ❑ If liquid has been spilled into the set or objects have fallen into the product.
- ❑ If the set has been exposed to rain or water.
- ❑ If the set has been subject to excessive shock by being dropped, or the cabinet has been damaged.
- ❑ If the set does not operate normally when following the operating instructions. Adjust only those controls that are specified in the operating instructions. Improper adjustment of other controls may result in damage and will often require extensive work by a qualified technician to restore the set to normal operation.
- ❑ When the set exhibits a distinct change in performance, it indicates a need for service.

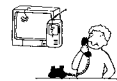
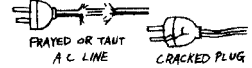

Servicing

Do not attempt to service the set yourself since opening the cabinet may expose you to dangerous voltage or other hazards. Refer all servicing to qualified service personnel.



Replacement Parts

When replacement parts are required, be sure the service technician certifies in writing that he has used replacement parts specified by the manufacturer that have the same characteristics as the original parts.

Unauthorized substitutions may result in fire, electric shock or other hazards.

Safety Check

Upon completion of any service or repairs to the set, ask the service technician to perform routine safety checks (as specified by the manufacturer) to determine that the set is in safe operating condition, and to so certify. When the set reaches the end of its useful life, improper disposal could result in a picture tube implosion. Ask a qualified service technician to dispose of the set.



Trademark Information

WOW, TruSurround and the  symbol are trademarks of SRS Labs, Inc. WOW and TruSurround technology are incorporated under license from SRS Labs, Inc.



Manufactured under license from Dolby Laboratories. Dolby and the double-D symbol are trademarks of Dolby Laboratories.

Manufactured under license from BBE Sound, Inc. Licensed by BBE Sound, Inc. under USP4638258, 5510752 and 5736897. BBE and BBE symbol are registered trademarks of BBE Sound, Inc.



This TV incorporates High-Definition Multimedia Interface (HDMI™) technology. HDMI, the HDMI logo and High-Definition Multimedia Interface are trademarks or registered trademarks of HDMI Licensing LLC.

CableCARD™ is a trademark of Cable Television Laboratories, Inc.

Wega, FD Trinitron, Steady Sound, Digital Reality Creation, CineMotion, Memory Stick, Memory Stick Duo, Memory Stick PRO, Memory Stick PRO Duo, MagicGate, Super Fine Pitch, MID, Clear Edge, ClearEdge VM and HD Detailer are trademarks of Sony Corporation.

Contents

Introducing the FD Trinitron Wega

Overview	9
Presenting the FD Trinitron Wega	9
Package Contents	9
Features	9

Setting Up the TV

Overview	11
About the AC Power Cord	11
TV Controls and Connectors	12
XS955 Front Panel	12
XS945 Front Panel	13
Rear Panel	14
Basic Connections: Connecting a Cable or Antenna	16
About Using CableCARD	16
Cable or Antenna Only	17
Cable and Antenna Only	18
Cable Box and Cable Only	19
Cable Box Only	20
Connecting Optional Equipment	21
Making Video Connections	22
About Using S VIDEO	22
VCR and Cable	23
VCR and Cable Box	24
Two VCRs for Tape Editing	26
Satellite Receiver	28
Satellite Receiver and VCR	30
DVD Player with Component Video Connectors	32
DVD Player with S VIDEO and Audio Connectors	34
Camcorder	35
Audio Receiver	36
DVI-Equipped Device	37
HDMI-Equipped Device	38
Connecting a Device with an Optical IN Connector	39
Using the CONTROL S Feature	40
Using CableCARD	41
About Using CableCARD	41
Activating CableCARD Service	41
Removing the CableCARD	42
Setting Up the Channel List	43
Using Initial Setup	43

Using the Remote Control

Overview	45
Inserting Batteries	45
Button Descriptions	46
Programming the Remote Control	49

Using the Features

Overview	51
Watching TV	52
Using the Program Guide	53
Using Additional Program Guide Options	54
Using Screen Mode (30/34 models only)	55
Using Screen Mode (32/36 models only)	57
Using Favorite Channels	58
Using the Channel Menu	58
Using the Favorite Channels Guide	58
Using Other Equipment with Your TV Remote Control	59
All Equipment	59
Operating a VCR	59
Operating a Satellite Receiver	59
Operating a Cable Box	60
Operating a DVD Player	60
Operating a DVD/VCR Combination Unit	60

Using the Memory Stick Viewer

About Memory Stick	61
Features	61
Memory Stick Compatibility	62
Memory Stick Functionality	62
File Compatibility	63
Trademark Information	63
Inserting and Removing a Memory Stick	64
Inserting a Memory Stick	64
Removing a Memory Stick	65
Using the Memory Stick Index	66
Using the Memory Stick Index	67
Viewing Photos	68
Photo Controls	68
Photo Menu Bar Options	69
Using Zoom and Pan	70
Using Rotate	70
Playing Movies	71
Movie Controls	71
Movie Menu Bar Options	72
Memory Stick Index Menu Bar Options	73
Slide Show Menu Options	73
Contents Menu Options	74
Memory Stick Menu	74
Notes on Using Memory Stick Media	75
About DCF File Names	75
Memory Stick Precautions	76

Using the Menus

Overview	77
Navigating Through Menus	77
Using the Video Menu	78
Using the Audio Menu	80
Using the Screen Menu (30/34 models only)	82
Using the Screen Menu (32/36 models only)	83
Using the Channel Menu	84
Using the Parent Menu	86
Selecting Parent Menu Options.....	86
US Models:Selecting Custom Rating Options	87
Viewing Blocked Programs	87
Canadian Models: Selecting Custom Rating Options	88
Viewing Blocked Programs	88
Using the Setup Menu	89
Using the Applications Menu	92

Other Information

Overview	95
Glossary	96
Contacting Sony	97
Troubleshooting	97
Remote Control	97
Channels	98
CableCARD	98
Memory Stick	99
Audio	100
Video	101
General	101
Specifications	103
Optional Accessories	104
Index	105

Introducing the FD Trinitron Wega

Overview

This chapter describes the contents of the package in which the TV is shipped and provides an overview of the features of your Wega TV.

Presenting the FD Trinitron Wega

The FD Trinitron Wega (pronounced VAY-GAH) is characterized by outstanding contrast, uncompromising accuracy, and corner-to-corner detail.

You will recognize the superiority of Wega technology almost immediately. The first thing you will probably notice is minimal glare from the flat picture tube. This flat-screen technology improves picture detail without distortion, unlike conventional curved screens. The FD Trinitron delivers outstanding image detail not only at the screen center, but also at the corners — so you can enjoy a bright, clear picture from any location in a room.

Package Contents

Along with your new Trinitron TV, the packing box contains a remote control and two AA (R6) batteries. These items are all you need to set up and use the TV.

Features

Some of the features that you will enjoy with your new TV include:

- ❑ **Built-in Digital Television Receiver:** You can watch digital television programs and enjoy the improved audio/video quality offered by these programs. With high-definition signal reception, you can watch TV signals broadcast in HDTV for the clearest possible broadcast picture.
- ❑ **CableCARD slot:** Provides cable subscribers with access to digitally encrypted cable channels — without the need for a set-top box — that will enable you to receive not only standard definition but also high definition television. The CableCARD, which is provided by your cable TV company, is inserted into the TV's rear panel CableCARD slot. After the service is activated with your cable TV company, the card replaces the need for a separate set-top box. (Check with your cable TV company about CableCARD service details, limitations, pricing, and availability. For more information about CableCARD in this manual, see pages 16 and 41.)

- ❑ **Screen Mode:** Enables you to resize the picture.
- ❑ **Super Fine Pitch CRT:** **XS955 models only** Created especially for displaying high resolution pictures, the new Super Fine Pitch CRT — along with a new electron gun and high intensity luminescent phosphor — improves image resolution, providing the highest picture quality reproduction from corner to corner.
- ❑ **DRC[®] (Digital Reality Creation) Multifunction:** Unlike conventional line doublers, the DRC Multifunction feature replaces the signal's NTSC waveform with the near-HD equivalent, while doubling the number of vertical and horizontal lines. This results in four times the density for quality sources, such as DVD, satellite, and digital camcorders. The Video Menu allows you to select interlaced, progressive, or CineMotion[™] output.
- ❑ **Favorite Channels:** Allows you to select from 16 of your favorite channels.
- ❑ **ClearEdge VM[™] Velocity Modulation:** Sharpens picture definition by enhancing vertical lines.
- ❑ **Steady Sound[®]:** Equalizes volume levels so there is consistent output between programs and commercials.
- ❑ **Memory Stick[®] Viewer:** Lets you watch digital photo (JPEG) and movie (MPEG1) files that are stored on Memory Stick media.
- ❑ **Component Video Inputs:** Offers the best video quality for DVD (480p, 480i), and digital set-top box (HD1080i, 720p) connections.
- ❑ **HD Detailer[™]:** Wideband video amplifier has a high bandwidth frequency rating, which allows it to send more video information to the screen, resulting in finer picture quality, especially for HD sources.
- ❑ **CineMotion[™]:** Reverse 3-2 pulldown processing provides optimal picture quality for film-based sources (media originally shot in 24 frames-per-second format).
- ❑ **Parental Control:** V-Chip technology allows parents to block unsuitable programming from younger viewers.
- ❑ **HDMI (High-Definition Multimedia Interface):** Provides an uncompressed, all-digital audio/video interface between this TV and any HDMI-equipped audio/video component, such as a set-top box, DVD player, and A/V receiver. HDMI supports enhanced, or high-definition video, plus two-channel digital audio.

Setting Up the TV

Overview

This chapter includes illustrated instructions for setting up your TV.

Topic	Page(s)
TV Controls and Connectors	12-15
Basic Connections: Connecting a Cable or Antenna	16-20
Connecting Optional Equipment	
VCR and Cable	23
VCR and Cable Box	24
Two VCRs for Tape Editing	26
Satellite Receiver	28
Satellite Receiver and VCR	30
DVD Player with Component Video Connectors	32
DVD Player with S VIDEO and Audio Connectors	34
Camcorder	35
Audio Receiver	36
DVI-Equipped Device	37
HDMI-Equipped Device	38
Connecting a Device with an Optical IN Connector	39
Using the CONTROL S Feature	40
Using CableCARD	41
Setting Up the Channel List	43

About the AC Power Cord

The AC power cord is attached to the rear of the TV with a hook. Use caution when removing the AC plug from its holder. Gently slide the plug upward to remove it from the hook. Once removed, the AC power plug should automatically disengage from its stored location.

 Do not plug in the AC power cord until you have made all other connections.

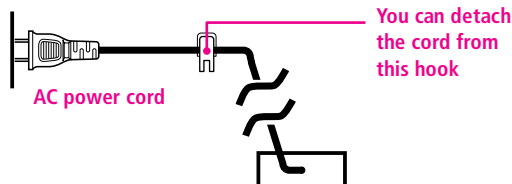

TV Controls and Connectors

XS955 Front Panel

The following description applies to models KD-30/34/36XS955 only.

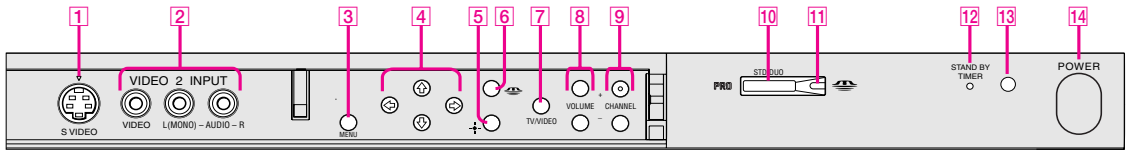

Item	Description
1 S VIDEO VIDEO 2 INPUT	Connects to the S VIDEO OUT jack on your camcorder or other video equipment that has S VIDEO. Provides better picture quality than composite video (2).
2 VIDEO/L(MONO)-AUDIO-R VIDEO 2 INPUT	Connects to the composite A/V output jacks on your camcorder or other video equipment.
3 MENU	Press to display the Menu. Press again to exit from the Menu. For details, see "Using the Menus" on page 77.
4 ↑ ↓ ← →	Press ↑ ↓ ← → to move the TV's on-screen cursor.
5 +	Press to select an item in the TV's Menu.
6	Press to display the Memory Stick Menu. For details, see "Using the Memory Stick Viewer" on page 61.
7 TV/VIDEO	Press repeatedly to cycle through the video equipment connected to the TV's video inputs.
8 -VOLUME +	Press to adjust the volume.
9 -CHANNEL+	Press to scan through channels. To scan quickly through channels, press and hold down either CHANNEL button.
10 PRO STD/DUO	Memory Stick insertion slot. For details, see "Inserting and Removing a Memory Stick" on page 64.
11 Memory Stick LED	When lit, indicates that the Memory Stick is being read. (Do not remove the Memory Stick when the indicator is lit.)
12 TIMER/STAND BY LED	Blinks when the TV is turned on, then shuts off when the picture is displayed. If the LED blinks continuously, this may indicate the TV needs service (see "Contacting Sony" on page 97). When lit, indicates one of the timers is set. When the timer is set, this LED will remain lit even if the TV is turned off. For details, see page 92.
13 Infrared Receiver (IR)	Receives IR signals from the TV's remote control.
14 POWER	Press to turn on and off the TV.

XS945 Front Panel

The following description applies to model KD-32XS945 only.

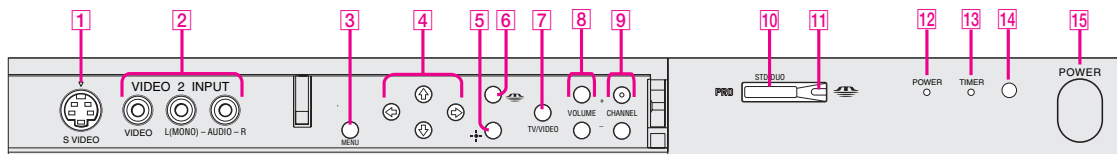

Item	Description
1 S VIDEO VIDEO 2 INPUT	Connects to the S VIDEO OUT jack on your camcorder or other video equipment that has S VIDEO. Provides better picture quality than composite video (2).
2 VIDEO/L(MONO)-AUDIO-R VIDEO 2 INPUT	Connects to the composite A/V output jacks on your camcorder or other video equipment.
3 MENU	Press to display the Menu. Press again to exit from the Menu. For details, see "Using the Menus" on page 77.
4 ↑ ↓ ← →	Press ↑ ↓ ← → to move the TV's on-screen cursor.
5 +	Press to select an item in the TV's Menu.
6	Press to display the Memory Stick Menu. For details, see "Using the Memory Stick Viewer" on page 61.
7 TV/VIDEO	Press repeatedly to cycle through the video equipment connected to the TV's video inputs.
8 -VOLUME +	Press to adjust the volume.
9 -CHANNEL+	Press to scan through channels. To scan quickly through channels, press and hold down either CHANNEL button.
10 PRO STD/DUO	Memory Stick insertion slot. For details, see "Inserting and Removing a Memory Stick" on page 64.
11 Memory Stick LED	When lit, indicates that the Memory Stick is being read. (Do not remove the Memory Stick when the indicator is lit.)
12 POWER LED	Lights when the TV is turned on.
13 TIMER LED	When lit, indicates one of the timers is set. When the timer is set, this LED will remain lit even if the TV is turned off. For details, see page 92. If the LED blinks continuously, this may indicate the TV needs service (see "Contacting Sony" on page 97).
14 Infrared Receiver (IR)	Receives IR signals from the TV's remote control.
15 POWER	Press to turn on and off the TV.

Rear Panel

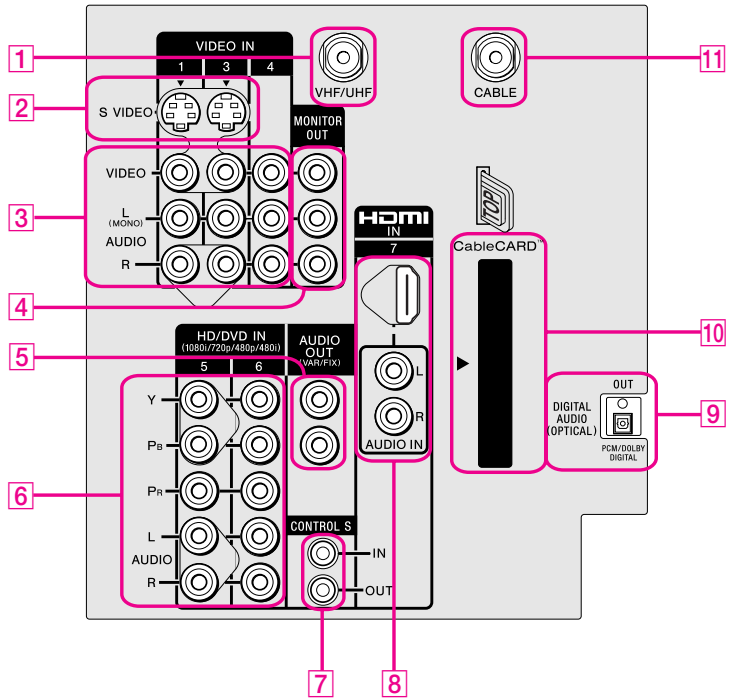

Jack	Description
1 VHF/UHF	RF input that connects to your VHF/UHF antenna or cable box.
2 S VIDEO IN 1/3	Connects to the S VIDEO OUT jack of your VCR or other video equipment that has S VIDEO. S VIDEO provides better picture quality than either composite video (3) or VHF/UHF (1) connections.
3 VIDEO IN 1/3/4 VIDEO/L(MONO) -AUDIO-R	Connect to the composite A/V output jacks on your VCR or other video component. A fourth component A/V input jack (VIDEO 2) is located on the front panel of the TV. This video connection provides better picture quality than the VHF/UHF (1) connection.
4 MONITOR OUT	Lets you record the program you are watching to a VCR. When two VCRs are connected, you can use the TV as a monitor for tape-to-tape editing (not available with digital channels or with 480i, 480p, 720p, or 1080i when the input is set to VIDEO 5, 6, or 7).
5 AUDIO OUT (VAR/FIX)	Connects to the left and right audio input jacks of your audio or video equipment. You can use these outputs to listen to your TV's audio through your stereo system.
6 HD/DVD IN 5/6 (1080i/720p/480p/480i)	Connect to your DVD player's or digital set-top box's component video (Y, PB, PR) and audio (L/R) jacks. Component video provides better picture quality than 1 , 2 , or 3).
7 CONTROL S IN/OUT	Allows the TV to receive (IN) and send (OUT) remote control signals to other Sony infrared-controlled audio or video equipment that has the CONTROL S function.
8 HDMI (VIDEO 7 IN)	HDMI (High-Definition Multimedia Interface) provides an uncompressed, all-digital audio/video interface between this TV and any HDMI-equipped audio/video component, such as a set-top box, DVD player, and A/V receiver. HDMI supports enhanced, or high-definition video, plus two-channel digital audio.
9 DIGITAL AUDIO OPTICAL OUTPUT (DOLBY DIGITAL PCM)	Connect to the optical audio input of an audio component that is Dolby* Digital and PCM compatible.
10 CableCARD Slot	Provides cable subscribers with access to digitally encrypted cable channels — without the need for a set-top box — that will enable you to receive not only standard definition but also high definition television. The CableCARD, which is provided by your cable TV company, is inserted into this slot. After the service is activated with your cable TV company, the card replaces the need for a separate set-top box. Check with your cable TV company about CableCARD service details, limitations, pricing, and availability. For more information, see page 41.
11 Cable	RF input that connects to your cable signal.

* Dolby and the double-D symbol are trademarks of Dolby Laboratories.

Basic Connections: Connecting a Cable or Antenna

The way in which you will connect your TV varies, depending on how your home receives a signal (cable, cable box, antenna) and whether or not you plan to connect a VCR.

<i>If You Are Connecting</i>	<i>See Page</i>
Cable or Antenna Only <input type="checkbox"/> No cable box or VCR	17
Cable and Antenna Only <input type="checkbox"/> No cable box or VCR	18
Cable Box and Cable Only <input type="checkbox"/> Cable box unscrambles only some channels (usually premium channels) <input type="checkbox"/> No VCR	19
Cable Box Only <input type="checkbox"/> Cable box unscrambles all channels <input type="checkbox"/> No VCR	20

If you are connecting a VCR

- See the connections described on pages 23 and 24.

About Using CableCARD

If you are planning to use a separate cable box for digital cable TV services, you may be able to receive programming using this TV with the CableCARD instead — except in the following circumstances:

- Your cable TV company does not provide CableCARD service in your viewing area.
- You want to access your cable company's interactive or advanced features (such as video-on-demand or, in some cases, pay-per-view). At this time, these services require a bidirectional link, which are only available through the use of a separate set-top box. CableCARD is currently a unidirectional device only, and cannot provide these advanced services.

Check with your cable TV company for CableCARD service details, limitations, pricing, and availability, all of which are determined by your cable TV company — not Sony. For information on installing and activating CableCARD, see "Using CableCARD" on page 41.

Cable or Antenna Only

For best results, use one of the following connections if you are connecting a cable or an antenna and you:

- ❑ Do not need a cable box to unscramble channels. (If you have a cable box, see pages 19-20.)
- ❑ Do not intend to connect a VCR. (If you have a VCR, see pages 23 and 24.)

The connection you choose depends on the cable type you have in your home, as described below.

75-ohm coaxial cable (usually found in newer homes)

Cable Type	Connect As Shown
VHF Only or combined VHF/UHF	<p>75-ohm coaxial cable</p> <p>TV</p> <p>VHF/UHF</p>
Cable	<p>75-ohm coaxial cable</p> <p>TV</p> <p>CABLE</p>

300-ohm twin lead cable (usually found in older homes)

Cable Type	Connect As Shown
VHF Only or UHF Only or combined VHF/UHF	<p>300-ohm twin lead cable</p> <p>TV</p> <p>VHF/UHF</p> <p>Antenna connector (not supplied)</p>

75-ohm coaxial and 300-ohm twin lead cable (found in some homes)

Cable Type	Connect As Shown
VHF and UHF	<p>75-ohm coaxial cable</p> <p>TV</p> <p>VHF/UHF</p> <p>U/V mixer (not supplied)</p> <p>300-ohm twin lead cable</p>

Cable and Antenna Only

For best results, use this connection if you:

- ❑ Have a cable and an antenna.

(This is convenient if you are using a separate rooftop antenna to receive additional channels that are not provided by your cable company.)

- ❑ Do not have a cable box or VCR. (If you have a cable box, see pages 19 to 20. If you have a VCR, see pages 23 and 24.)

Cable Type	Connect As Shown
------------	------------------

Cable TV (CATV) and Antenna

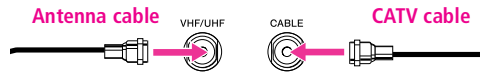

Notes on Using This Connection

To Do This ...	Do This ...
----------------	-------------

Switch the TV's input between the cable and antenna

Press **ANT** to switch back and forth between the TV's VHF/UHF and CABLE inputs.

Cable Box and Cable Only

Before connecting a cable box, see "About Using CableCARD" on page 16.

For best results, use this connection if:

- ❑ Your cable company scrambles some channels, such as premium channels (which requires you to use a cable box), but does not scramble all channels.
- ❑ You do not have a VCR. (If you have a VCR, see pages 23 and 24.)

With this connection you can:

- ❑ Use the TV remote control to change channels coming through the cable box to the TV's VHF/UHF input jack. (You must first program the remote control for your specific cable box; see "Programming the Remote Control" on page 49.)
- ❑ Use the TV remote control to change channels coming directly into the TV's CABLE input. (The TV's tuner provides a better signal than the cable box.)

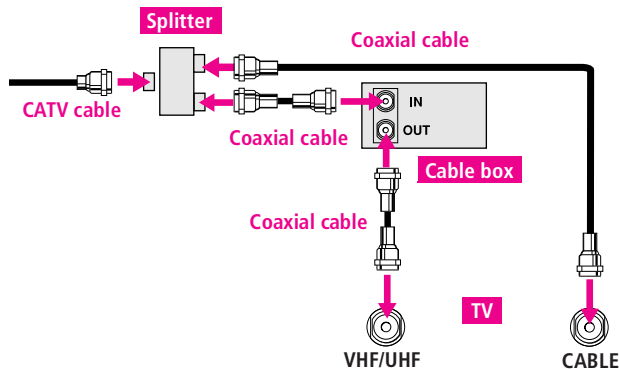

Notes on Using This Connection

To Do This ...	Do This ...
Use the cable box	Tune the TV to the channel the cable box is set to (usually channel 3 or 4) and then use the cable box to switch channels.
Set up the TV remote control to operate the cable box	Program the remote control. See "Programming the Remote Control" on pages 49-50.
Activate the remote control to operate the cable box	Press SAT/CABLE FUNCTION .
Switch the TV's input between the cable box and cable	Press ANT to switch back and forth between the TV's VHF/UHF (scrambled channels) and CABLE (unscrambled) inputs.

Cable Box Only

Before connecting a cable box, see "About Using CableCARD" on page 16.

For best results, use this connection if:

- ❑ Your cable company scrambles all channels, which requires you to use a cable box.
- ❑ You do not have a VCR. (If you have a VCR, see pages 23 and 24.)

With this connection you can:

- ❑ Use the TV remote control to change channels coming through the cable box to the TV's VHF/UHF jack. (You must first program the remote control for your specific cable box.)

To connect the cable box

- 1 Connect the CATV cable to the cable box's input jack.
- 2 Use a coaxial cable to connect the cable box's output jack to the TV's VHF/UHF jack.

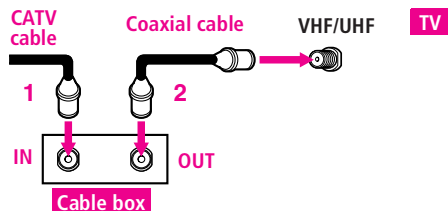

- 3 Run Auto Program, as described in "Setting Up the Channel List" on page 43.

Notes on Using This Connection

To Do This ...	Do This ...
Use the cable box	Tune the TV to the channel the cable box is set to (usually channel 3 or 4) and then use the cable box to switch channels.
Set up the TV remote control to operate the cable box	Program the remote control. See "Programming the Remote Control" on pages 49.
Activate the remote control to operate the cable box	Press SAT/CABLE FUNCTION .





Connecting Optional Equipment

Use the directions in this section to connect the following optional equipment:

<i>If You Are Connecting</i>	<i>See Page</i>
VCR and Cable	23
VCR and Cable Box	24
Two VCRs for Tape Editing	26
Satellite Receiver	28
Satellite Receiver and VCR	30
DVD Player with Component Video Connectors	32
DVD Player with S VIDEO and Audio Connectors	34
Camcorder	35
Audio Receiver	36
DVI-Equipped Device	37
HDMI-Equipped Device	38

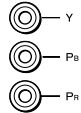
Making Video Connections

Your TV includes several types of video inputs. When connecting your TV, use the outputs that are available on your components that provide the best video performance, as described below.

Best Video Performance	
	HDMI (High-Definition Multimedia Interface)
	Component video
	S VIDEO
	Composite video
	RF/Coaxial
Good Video Performance	

About Using S VIDEO



If the optional equipment you are connecting has an S VIDEO jack (shown at left), you can use an S VIDEO cable for improved picture quality (compared to an A/V cable). Because S VIDEO carries only the video signal, you also need to connect audio cables for sound, as shown below.

Example of an S VIDEO Connection

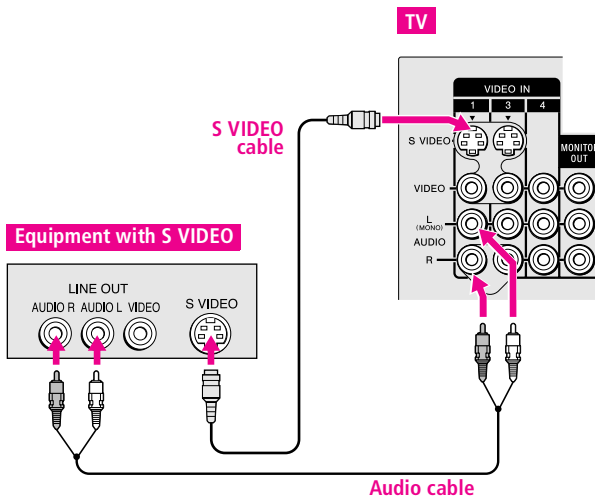

Cables are often color-coded to connectors. Connect red to red, white to white, etc.

VCR and Cable



Using
S VIDEO jacks?
See page 22.

For best results, use this connection if:

- ❑ Your cable company does not require you to use a cable box.

To connect the VCR and cable

- 1 Connect the CATV cable to the VCR's VHF/UHF input jack.
- 2 Use a coaxial cable to connect the VCR's VHF/UHF output jack to the TV's CABLE jack.
- 3 Use an A/V cable to connect the VCR's A/V output jacks to the TV's A/V input jacks.
- 4 Run Auto Program, as described in "Setting Up the Channel List" on page 43.

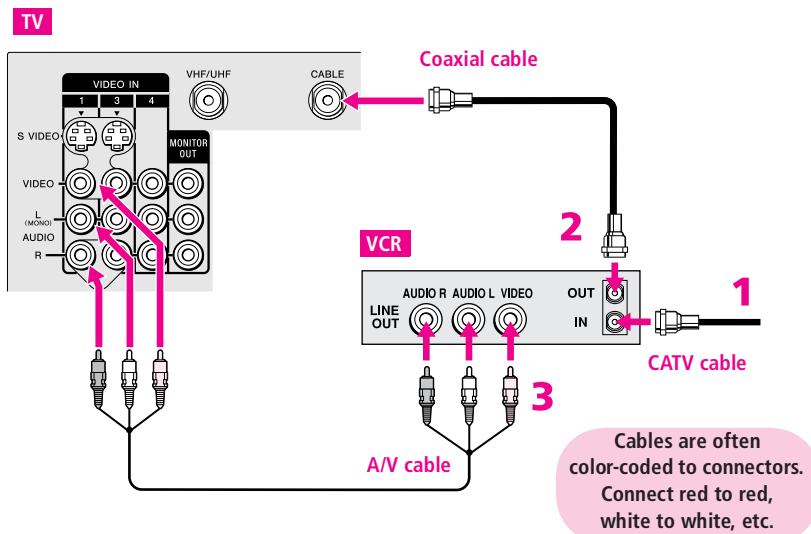

Notes on Using This Connection

To Do This ...	Do This ...
Watch the VCR	Press TV/VIDEO repeatedly to select the VCR input (VIDEO 1 in the illustration).
Watch cable channels	Press TV/VIDEO repeatedly to select the cable input (CABLE in the illustration).
Set up the TV remote control to operate the VCR	If you have a non-Sony VCR, you must program the remote control. See "Programming the Remote Control" on pages 49-50.
Activate the TV remote control to operate the VCR	Press VCR/DVD FUNCTION .
Control VCR functions with the TV remote control	See "Operating a VCR" on page 59.
Label video inputs to easily identify equipment connected to the TV	See the instructions for setting up Video Labels on page 90.

VCR and Cable Box

Before connecting a cable box, see "About Using CableCARD" on page 16.

For best results, use this connection if:

- ❑ Your cable company scrambles some channels, such as premium channels (which requires you to use a cable box), but does not scramble all channels.

With this connection you can:

- ❑ Use the TV remote control to change channels coming through the cable box. (You must first program the remote control for your specific cable box; see "Programming the Remote Control" on page 49.)
- ❑ Use the TV remote control to change channels coming directly into the TV's CABLE jack. (The TV's tuner provides a better signal than the cable box.)
- ❑ Record channels coming through the cable box and channels coming directly into the TV.

To connect a VCR and cable box, you need:

- ❑ A splitter, which is a small, inexpensive device that you can purchase at your local electronics store.
- ❑ Four coaxial cables.
- ❑ Two A/V cables or two S VIDEO cable with audio cables.

To connect the VCR and cable box

- 1 Connect the CATV cable to the single (input) jack of the splitter.
- 2 Use a coaxial cable to connect one of the splitter's two output jacks to the TV's CABLE jack.
- 3 Use a coaxial cable to connect the splitter's other output jack to the cable box's input jack.
- 4 Use a coaxial cable to connect the cable box's output jack to the VCR's RF input jack.
- 5 Use an A/V cable to connect the cable box's A/V output jacks to the TV's A/V input jacks.
- 6 Use an A/V cable to connect the VCR's A/V output jacks to the TV's A/V input jacks.
- 7 Run Auto Program, as described in "Setting Up the Channel List" on page 43.



Using
S VIDEO jacks?
See page 22.

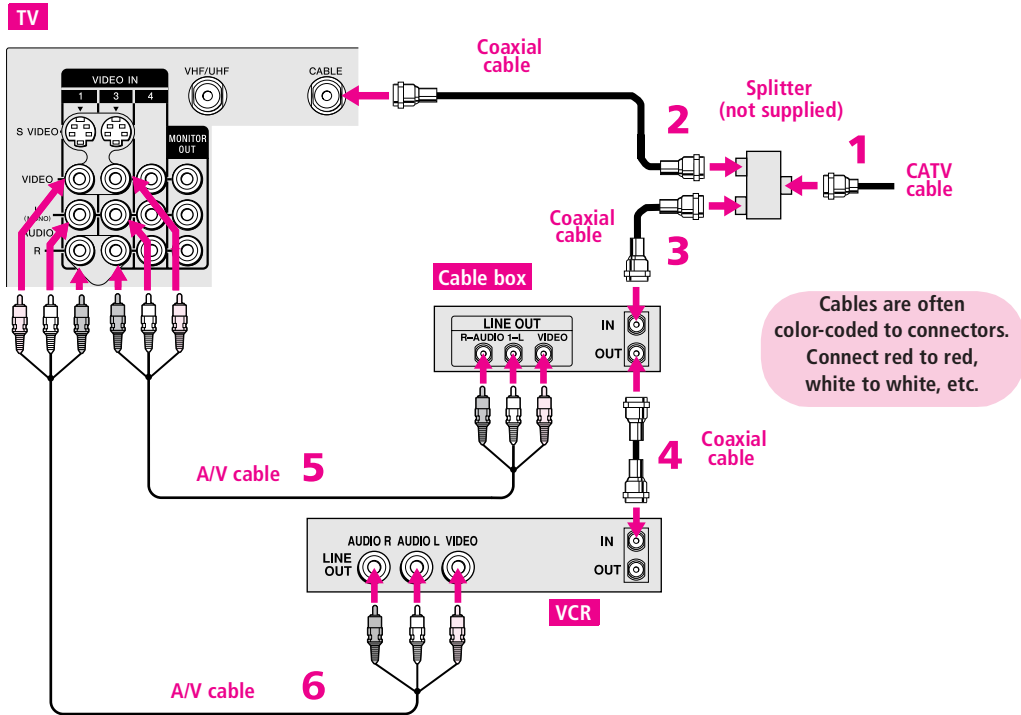

Notes on Using This Connection

To Do This ...	Do This ...
Watch cable (unscrambled) channels	Press TV/VIDEO repeatedly to select the cable input (CABLE in the illustration).
Watch cable box (scrambled) channels	Press TV/VIDEO repeatedly to select the cable box input (VIDEO 3 in the illustration). Use the cable box to change channels.
Watch the VCR	Press TV/VIDEO repeatedly to select the VCR input (VIDEO 1 in the illustration).
Set up the TV remote control to operate the cable box or VCR	If you have a non-Sony VCR, you must program the remote control. See "Programming the Remote Control" on pages 49-50.
Activate the remote control to operate the cable box or VCR	For the cable box, press SAT/CABLE FUNCTION . For the VCR, press VCR/DVD FUNCTION .
Control specific cable box and VCR functions with the TV remote control	See "Operating a Cable Box" on page 60 and "Operating a VCR" on page 59.
Label video inputs to easily identify equipment connected to the TV	See the instructions for setting up Video Labels on page 90.

Two VCRs for Tape Editing



Using
S VIDEO jacks?
See page 22.

Connecting two VCRs lets you record from one VCR to the other. By connecting them as shown below, you can view (monitor) what is being recorded.

To connect two VCRs for tape editing

- 1 Use an A/V cable to connect the playback VCR's A/V output jacks to the TV's A/V input jacks.
- 2 Use an A/V cable to connect the recording VCR's A/V input jacks to the TV's MONITOR OUT jacks.

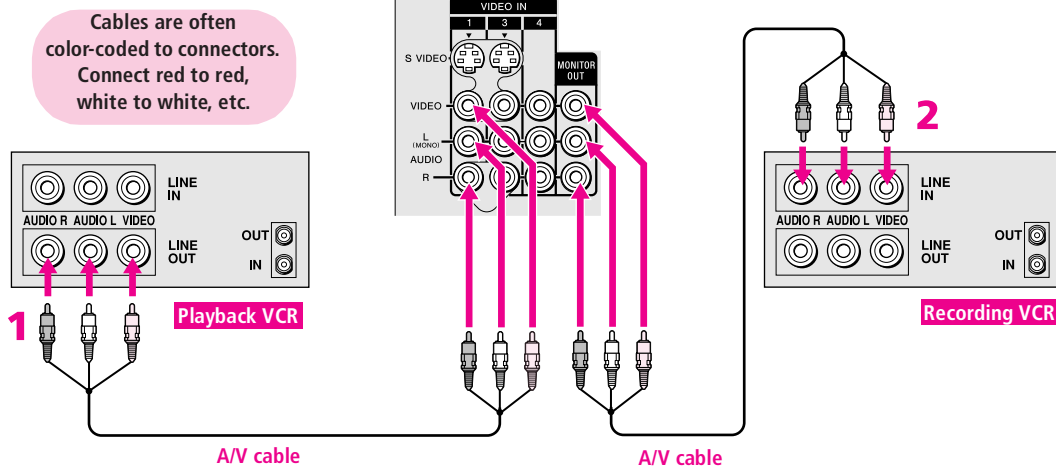

Notes on Using This Connection

To Do This ...	Do This ...
View (monitor) what is being recorded	Press TV/VIDEO repeatedly to select the VCR input (VIDEO 1 in the illustration above).
Set up the TV remote control to operate the VCR(s)	If you have a non-Sony VCR, you must program the remote control. See "Programming the Remote Control" on pages 49-50.
Activate the TV remote control to operate the VCR(s)	Press VCR/DVD FUNCTION .
Control VCR functions with the TV remote control	See "Operating a VCR" on page 59.
Label video inputs to easily identify equipment connected to the TV	See the instructions for setting up Video Labels on page 90.

Satellite Receiver



Using
S VIDEO jacks?
See page 22.

To connect a satellite receiver

- 1 Connect the satellite antenna cable to the satellite receiver's satellite input jack.
- 2 Use an A/V cable to connect the satellite receiver's A/V output jacks to the TV's A/V input jacks.
- 3 Connect a CATV cable from your cable or antenna to the TV's CABLE jack.
- 4 Run Auto Program, as described in "Setting Up the Channel List" on page 43.

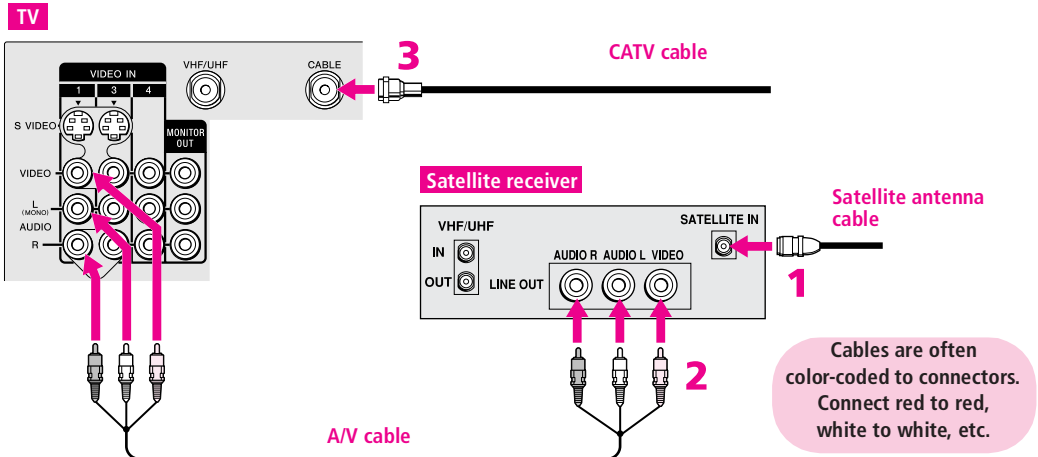

Notes on Using This Connection

<i>To Do This ...</i>	<i>Do This ...</i>
Watch the satellite receiver	Press TV/VIDEO repeatedly to select the satellite receiver input (VIDEO 1 in the illustration).
Set up the TV remote control to operate the satellite receiver	If you have a non-Sony satellite receiver, you must program the remote control. See "Programming the Remote Control" on pages 49-50.
Activate the TV remote control to operate the satellite receiver	Press SAT/CABLE FUNCTION .
Control satellite receiver functions with the TV remote control	See "Operating a Satellite Receiver" on page 59.
Label video inputs to easily identify equipment connected to the TV	See the instructions for setting up Video Labels on page 90.

Satellite Receiver and VCR



Using
S VIDEO jacks?
See page 22.

To connect a satellite receiver and VCR

- 1 Connect the CATV cable to the single (input) jack of the splitter.
- 2 Use a coaxial cable to connect one of the splitter's two output jacks to the TV's CABLE jack.
- 3 Use a coaxial cable to connect the splitter's other output jack to the satellite receiver's VHF/UHF input jack.
- 4 Connect the satellite antenna cable to the satellite receiver's satellite input jack.
- 5 Use a coaxial cable to connect the satellite receiver's VHF/UHF output jack to the VCR's VHF/UHF input jack.
- 6 Use an A/V cable to connect the satellite receiver's A/V output jacks to the TV's A/V input jacks.
- 7 Use an A/V cable to connect the VCR's A/V output jacks to the TV's A/V input jacks.
- 8 Run Auto Program, as described in "Setting Up the Channel List" on page 43.

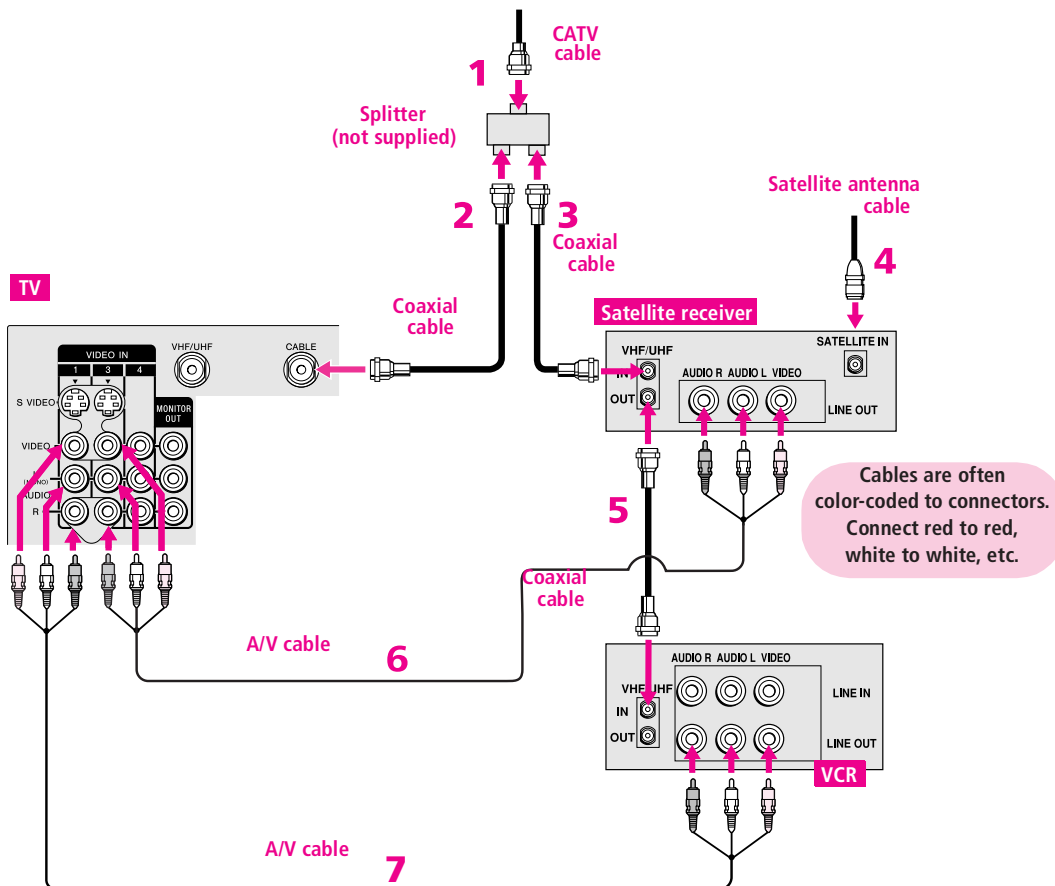

Notes on Using This Connection

To Do This ...	Do This ...
Watch the satellite receiver	Press TV/VIDEO repeatedly to select the VCR input (VIDEO 3 in the illustration).
Watch the VCR	Press TV/VIDEO repeatedly to select the input to which the VCR is connected (VIDEO 1 in the illustration).
Set up the TV remote control to operate the satellite receiver or VCR	If you have a non-Sony VCR or satellite receiver, you must program the remote control. See "Programming the Remote Control" on pages 49-50.
Activate the TV remote control to operate the satellite receiver or VCR	For the satellite receiver, press SAT/CABLE FUNCTION . For the VCR, press VCR/DVD FUNCTION .
Control satellite receiver and VCR functions with the TV remote control	See "Operating a Satellite Receiver" on page 59 and "Operating a VCR" on page 59.
Label video inputs to easily identify equipment connected to the TV	See the instructions for setting up Video Labels on page 90.

DVD Player with Component Video Connectors

For best results, use this connection if your DVD player has component video (Y, PB, PR) jacks.

To connect a DVD player with component video connectors

- 1 Use three separate component video cables to connect the DVD player's Y, PB and PR jacks to the Y, PB and PR jacks (VIDEO 5) on the TV.

 The Y, PB and PR jacks on your DVD player are sometimes labeled Y, CB and CR, or Y, B-Y and R-Y. If so, connect the cables to like colors.

- 2 Use an audio cable to connect the DVD player's audio output jacks to the TV's VIDEO 5 audio input jacks.

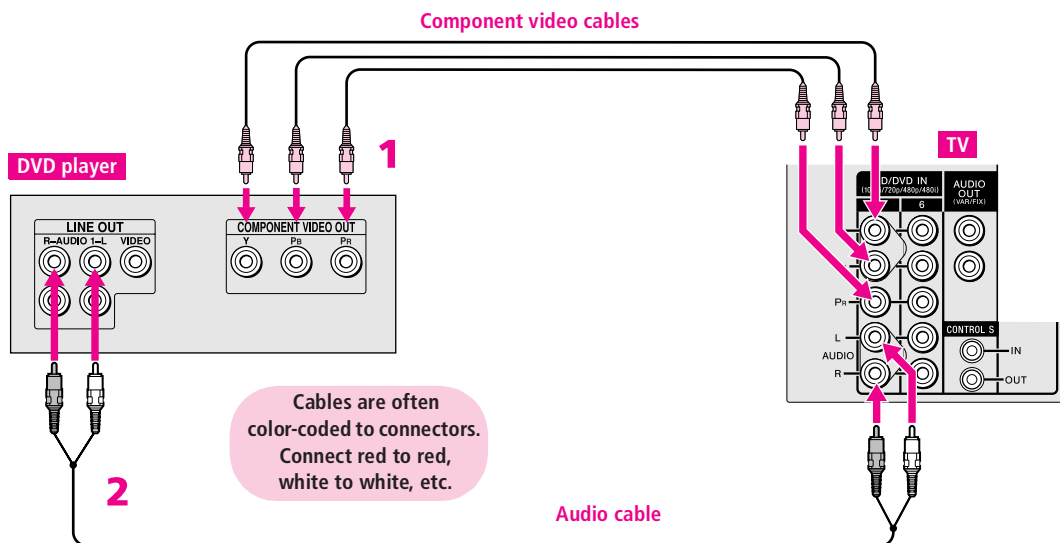

Notes on Using This Connection

To Do This ...	Do This ...
Watch the DVD player	Press TV/VIDEO repeatedly to select the DVD input (VIDEO 5 in the illustration).
Set up the TV remote control to operate the DVD player	If you have a non-Sony DVD player, you must program the remote control. See "Programming the Remote Control" on pages 49-50.
Activate the TV remote control to operate the DVD player	Press VCR/DVD FUNCTION .
Control DVD functions with the TV remote control	See "Operating a DVD Player" on page 60.
Label video inputs to easily identify equipment connected to the TV	See the instructions for setting up Video Labels on page 90.



You cannot record the signal from any equipment connected into the Y, PB, PR jacks.

DVD Player with S VIDEO and Audio Connectors

Use this connection if your DVD player does not have component video (Y, PB, PR) jacks.

To connect a DVD player with A/V connectors

- 1 Use an audio cable to connect the DVD player's audio output jacks to the TV's audio input jacks.
- 2 Use an S VIDEO cable to connect the DVD player's S VIDEO jack to the TV's S VIDEO jack.

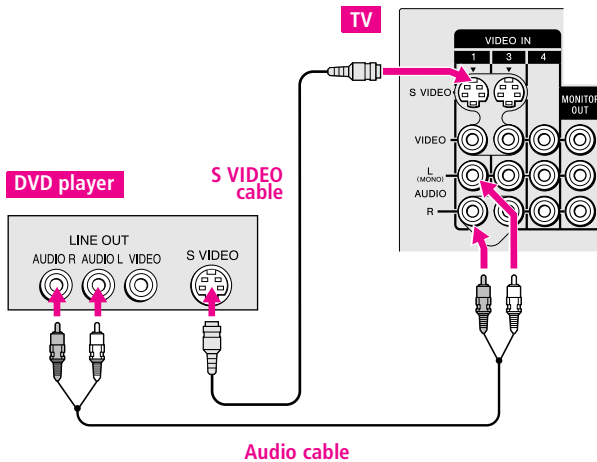

Cables are often color-coded to connectors. Connect red to red, white to white, etc.

Notes on Using This Connection

To Do This ...	Do This ...
Watch the DVD player	Press TV/VIDEO repeatedly to select the DVD input (VIDEO 1 in the illustration).
Set up the TV remote control to operate the DVD player	If you have a non-Sony DVD player, you must program the remote control. See "Programming the Remote Control" on pages 49-50.
Activate the TV remote control to operate the DVD player	Press VCR/DVD FUNCTION .
Control DVD functions with the TV remote control	See "Operating a DVD Player" on page 60.
Label video inputs to easily identify equipment connected to the TV	See the instructions for setting up Video Labels on page 90.

Camcorder



Using
S VIDEO jacks?
See page 22.

For easy connection of a camcorder, the TV has front A/V input jacks. If you prefer, however, you can connect the camcorder to the TV's rear A/V input jacks.

To connect a camcorder

- 1 Use A/V cables to connect the camcorder's A/V output jacks to the TV's A/V input jacks.

TV

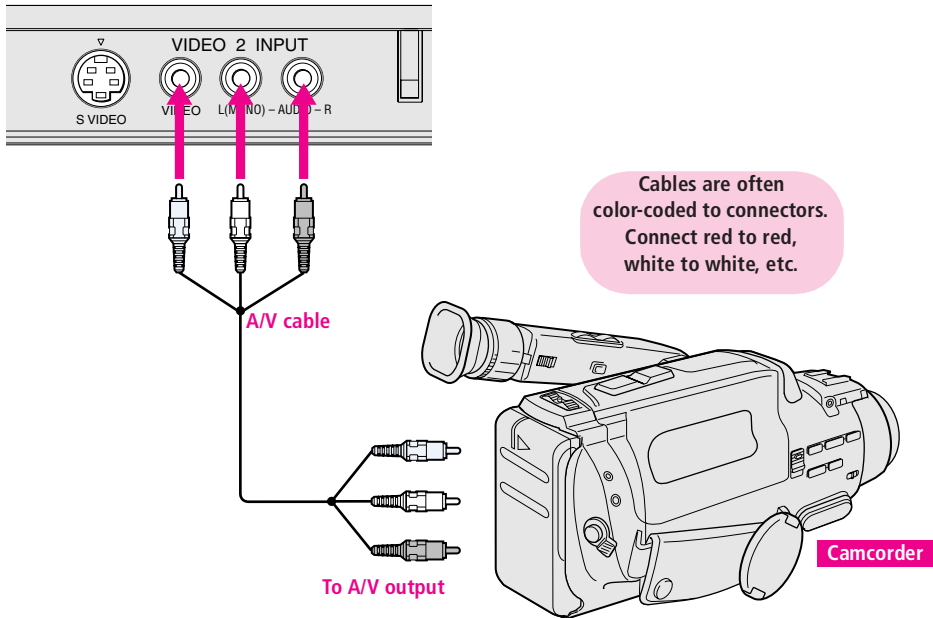

If you have a mono camcorder, connect its audio output jack to the TV's L MONO audio jack.

Notes on Using This Connection

To Do This ...

Watch the camcorder

Label video inputs to easily identify equipment connected to the TV

Do This ...

Press **TV/VIDEO** repeatedly to select the camcorder input (VIDEO 2 in the illustration).

See the instructions for setting up Video Labels on page 90.

Audio Receiver

For improved sound quality, you may want to play the TV's audio through your stereo system.

To connect an audio system

- 1 Use an audio cable to connect the TV's audio output jacks to the audio receiver's line input jacks.

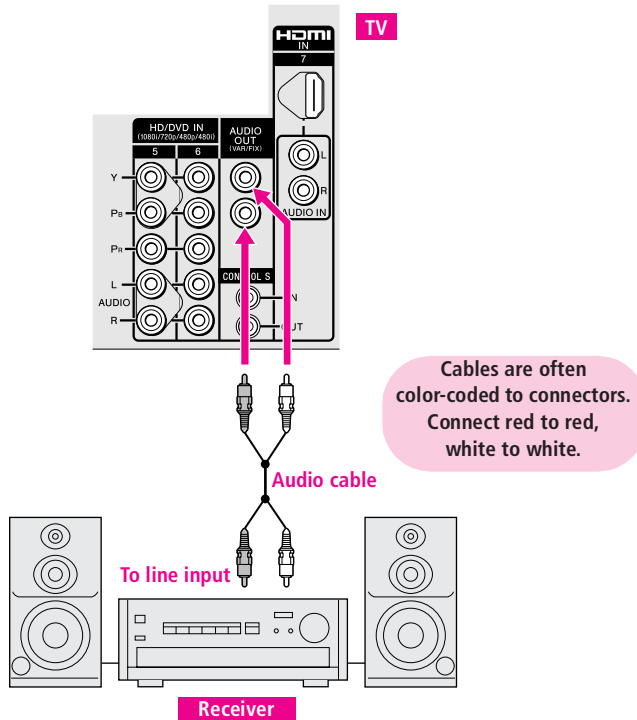

- 2 Using the TV's Audio Menu, set the **Speaker** option to **Off**. Then set the **Audio Out** option to **Fixed** or **Variable**, depending on how you want to control the volume. For details, see "Using the Audio Menu" on page 80.
- 3 Turn on the audio receiver, and then set the receiver's line input to the jack into which you connected the TV.

DVI-Equipped Device

If you have a device, such as an HDTV receiver, that has DVI (Digital Video Interface) output, use the following connection.

To connect a device that has DVI OUT:

- 1 Use an HDMI-to-DVI cable to connect the device's DVI OUT jack to the TV's HDMI IN jack.

 You can purchase HDMI cables (or cable adapters) at your local electronics store.

- 2 Use an audio cable to connect the device's audio output jacks to the TV's HDMI analog audio input jacks.

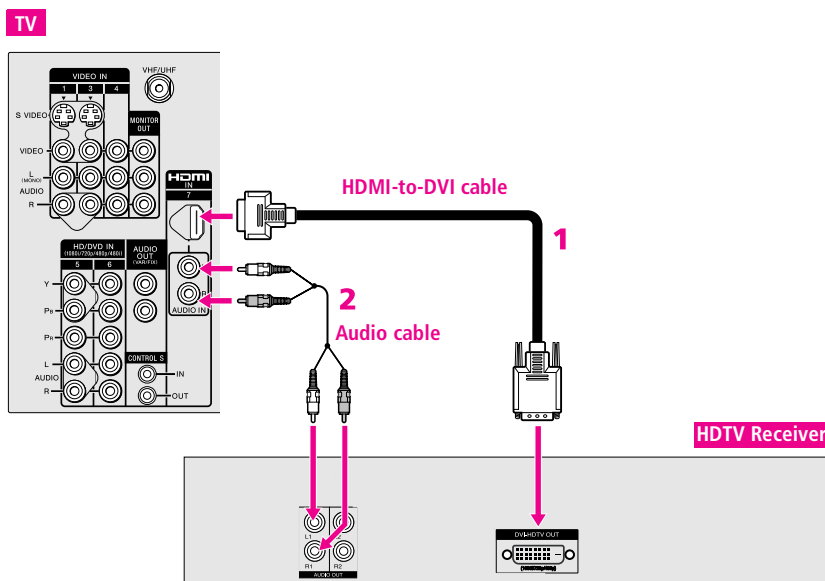

Note on Using This Connection

To Do This ...

Watch the DVI device
Label video inputs to easily
identify equipment connected
to the TV

Do This ...

Press **TV/VIDEO** repeatedly to select the VIDEO 7 input.
See the instructions for setting up Video Labels on page 90.

HDMI-Equipped Device

If you have a device, such as an HDTV receiver, that has a High-Definition Multimedia Interface (HDMI), use the following connection.

To connect a device that has HDMI OUT:

- 1 Use the HDMI cable that came with your device to connect the device's HDMI OUT jack to the TV's HDMI IN jack.

 HDMI cables transmit both audio and video signals. (Separate audio cables are not necessary.) You can purchase HDMI cables at your local electronics store.

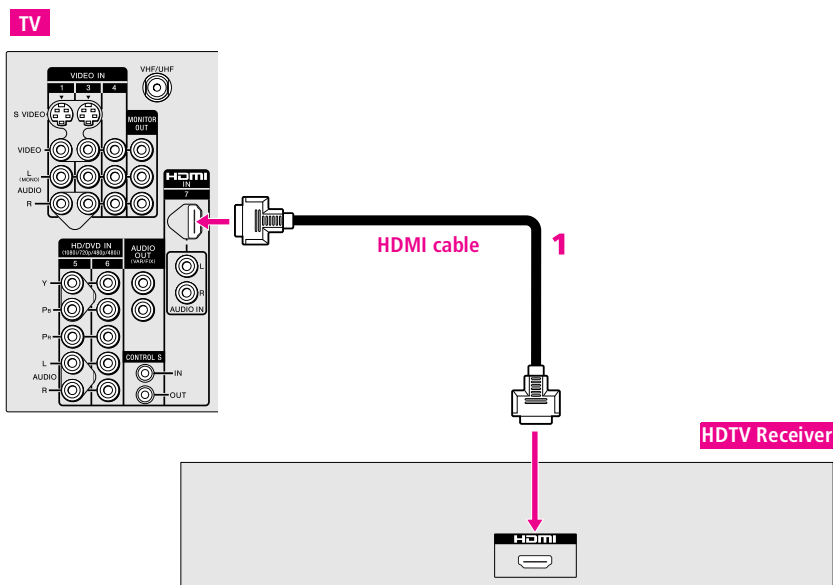

Note on Using This Connection

To Do This ...

Watch the HDMI device
Label video inputs to easily identify equipment connected to the TV

Do This ...

Press **TV/VIDEO** repeatedly to select the VIDEO 7 input.
See the instructions for setting up Video Labels on page 90.

Connecting a Device with an Optical IN Connector

You can use the TV's DIGITAL AUDIO OPTICAL output jack to connect an audio device that is Dolby Digital and PCM compatible, such as an audio amplifier.

- Using an optical cable, connect the TV's DIGITAL AUDIO OPTICAL output jack to the device's audio optical input jack.

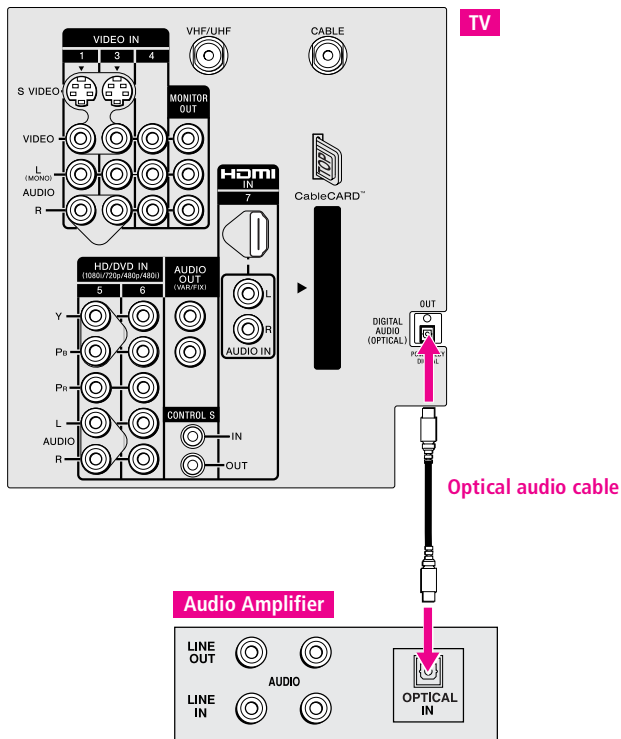

 Because all equipment does not output digital audio, you should also connect the TV's analog audio output jacks to the amplifier's analog audio input jacks, as described on page 36.

Using the CONTROL S Feature

CONTROL S allows you to control your system and other Sony equipment with one remote control. In addition to allowing you to control multiple devices with one remote control, the CONTROL S feature allows you to always point your remote control at your TV, instead of having to point it at the other equipment, which might be hidden or out of direct line of sight.

Use CONTROL S IN to send signals to the TV.

Use CONTROL S OUT to send signals to connected equipment.

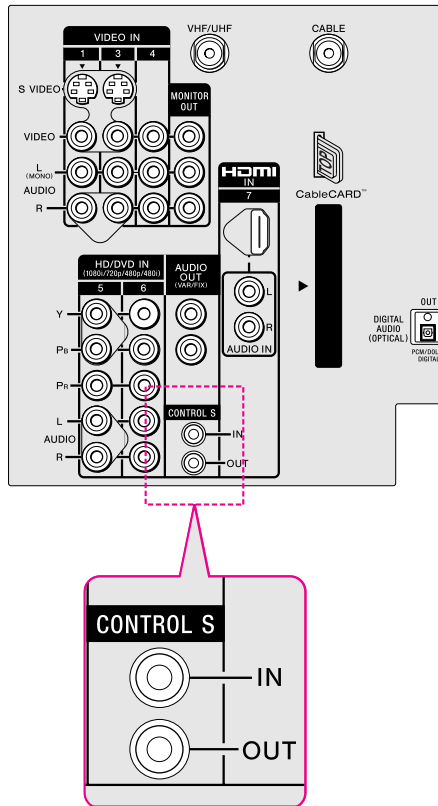

Using CableCARD

CableCARD provides cable subscribers with access to digitally encrypted cable channels — without the need for a set-top box — that will enable you to receive not only standard definition but also high definition television. The CableCARD, which is provided by your cable TV company, is inserted into the TV's rear panel CableCARD slot. After the service is activated with your cable TV company, the card replaces the need for a separate set-top box.

About Using CableCARD

If you are planning to use a separate cable box for digital cable TV services, you may be able to receive programming using this TV with the CableCARD instead — except in the following circumstances:

- ❑ Your cable TV company does not provide CableCARD service in your viewing area.
- ❑ You want to access your cable company's interactive or advanced features (such as video-on-demand or, in some cases, pay-per-view). At this time, these services require a bidirectional link, which are only available through the use of a separate set-top box. CableCARD is currently a unidirectional device only, and cannot provide these advanced services.

Check with your cable TV company for CableCARD service details, limitations, pricing, and availability, all of which are determined by your cable TV company — not Sony.

Activating CableCARD Service

Before you can use CableCARD service, you need to insert the CableCARD (supplied by your cable TV company) and activate the service, as described below:

- 1 Insert the CableCARD into the TV's CableCARD slot.

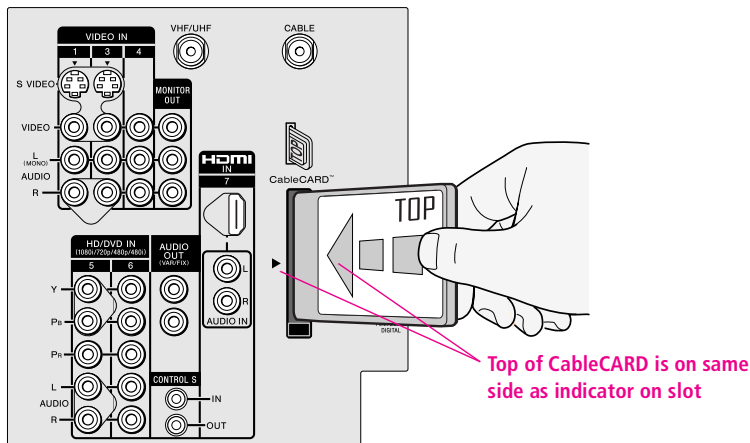

! CAUTION: Inserting the CableCARD incorrectly may result in permanent damage to the card and the TV.

 You can also access information about your CableCARD in the Applications Menu (see page 93).

- 2 Gently push the card into the slot until it locks into place.
- 3 Turn on the TV. After 1-2 minutes, the CableCARD setup screen is displayed. This screen includes information your cable TV company will request before they can activate your service.
- 4 Follow the displayed instructions: Phone your cable company. A representative will guide you through the activation process.
- 5 After your CableCARD is activated, your cable TV company will download the service information, including the channel list, to the CableCARD.

After the CableCARD has acquired channels from your cable TV company, the TV tunes to the lowest available channel.

Removing the CableCARD

In the event you want to cancel your service, contact your cable TV company.

 **Once the CableCARD is removed, your TV will no longer decrypt digital cable TV programming services that require CableCARD.**

- 1 Push the eject button on the TV's CableCARD slot to release the card.

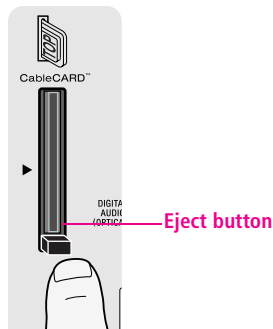



- 2 Pull the CableCARD straight out of the slot to remove it. To install a different CableCARD, follow the instructions in "Activating CableCARD Service" on page 41.

Setting Up the Channel List

After you finish connecting the TV, you need to run the Initial Setup feature, which automatically creates a list of available analog and digital channels and lets you correct tilt and vertical correction settings. The Initial Setup screens appear when you turn on your TV for the first time after hooking it up.

Using Initial Setup

 For more details on using Tilt Correction and Vertical Correction, see pages 89-90.

 To exit the Tilt Correction and Vertical Correction screens, press the **MENU** button.



 If you are using a CableCARD, Auto Program is disabled for the CABLE input.

To run Initial Setup

- 1 Press **POWER** to turn on the TV.

The Initial Setup screen appears.

Using the remote control, move the highlight to the desired language, then press  to select that language. The Tilt Correction screen appears.

- 2 Press **←→** to correct any tilt of the picture. You can choose a correction between +7 and -7. When finished, press .
- 3 The Vertical Correction screen appears. Press **↑↓** to make a vertical correction to the picture. You can choose a correction between +5 and -5. When finished, press .
- 4 The next screen instructs you to connect your cable/antenna. Check that you've connected your signal source correctly. To start Auto Program, highlight **Yes** and then press .

Auto Program automatically creates a list of receivable analog and digital channels. Auto Program may take 50 minutes or more to complete. A progress bar is displayed while the channel list is being created.

When Auto Program is finished, the lowest numbered channel is displayed.

To run Auto Program again at a later time

- Use the Auto Program feature as described on page 84.

To add individual digital channels

Use the Digital Channel feature as described on page 84.

To reset the TV to factory settings

- 1 Press **POWER** to turn on the TV.
- 2 Hold down **RESET** on the remote control.
- 3 Press **TV POWER** on the TV. (The TV will turn itself off, then back on.)
- 4 Release **RESET**.

Using the Remote Control

Overview

This chapter describes how to set up, program, and use the TV's remote control.

Topic	Page
Inserting Batteries	45
Button Descriptions	46
Programming the Remote Control	49

Inserting Batteries

- 1 Remove the battery cover from the remote control.
- 2 Insert two size AA (R6) batteries (supplied) by matching the \oplus and \ominus terminals on the batteries to the diagram inside the battery compartment.
- 3 Replace the battery cover.

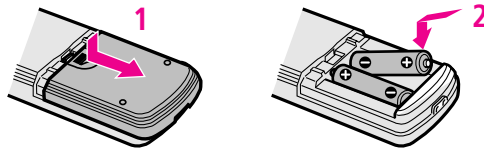

 Remove the batteries to avoid damage from possible battery leakage whenever you anticipate that the remote control will not be used for an extended period.

Handle the remote control with care.







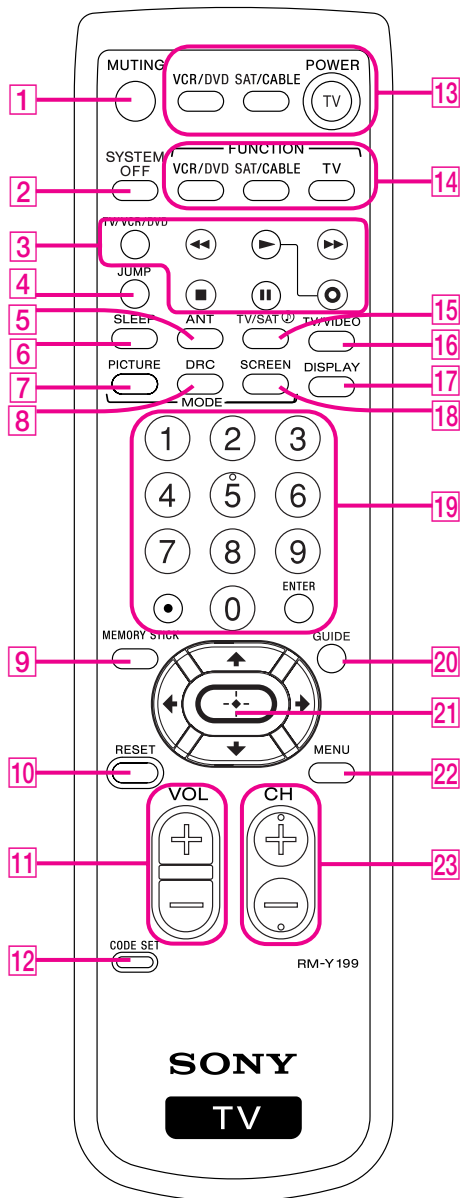

Avoid dropping it, getting it wet, placing it in direct sunlight, near a heater, or where the humidity is high.

Button Descriptions

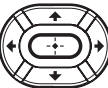
Remote Control



Button	Description
1 MUTING	Press to mute the sound. Press again or press VOL+ to restore the sound.
2 SYSTEM OFF	Press to turn off all Sony brand audio/video equipment at once. (May not function with older Sony equipment. Does not function with DVD/VCR combination unit.)
3 TV/VCR/DVD Transport Buttons	<p>Press to change the VHF/UHF output of the VCR (or DVD/VCR combination unit).</p> <p>◀◀ Rewind</p> <p>▶ Play</p> <p>● Record (press together with ▶)</p> <p>■ Stop</p> <p>▶▶ Fast forward</p> <p> Pause</p>
4 JUMP	Press to jump back and forth between two channels. The TV alternates between the current channel and the last channel that was selected.
5 ANT	Press to switch between the sources connected to the TV's VHF/UHF and CABLE inputs.
6 SLEEP	Press repeatedly until the TV displays the time in minutes (15, 30, 45, 60, or 90) that you want the TV to remain on before shutting off automatically. To cancel press until Sleep Off appears. While the Sleep feature is set, press once to display the remaining time.
7 PICTURE MODE	Press repeatedly to cycle through the available video picture modes: Vivid, Standard, Movie, Pro . Also available in the Video Menu. For details, see "Selecting Video Options" on page 78.
8 DRC MODE	Press repeatedly to cycle through the available Digital Reality Creation modes: Interlaced, Progressive, CineMotion . Also available in the Video Menu. For details, see "Selecting Video Options" on pages 78-79.
9 MEMORY STICK	Press to display the Memory Stick Menu. For details, see "Using the Memory Stick Viewer" on page 61. Also available in the Applications Menu (page 92).
10 RESET	Press to reset the settings to the factory defaults. See pages 43, 79, and 81. Also used to clear Favorite Channels (see page 58).
11 VOL +/-	Press to adjust the volume.
12 CODE SET	Press to program the remote control to operate non-Sony video equipment. For details, see "Programming the Remote Control" on page 49.
13 POWER Buttons	<p>VCR/DVD: Press to turn on and off the VCR or DVD player.</p> <p>SAT/CABLE: Press to turn on and off the satellite receiver or cable box.</p> <p>TV: Press to turn on and off the TV.</p>
14 FUNCTION Buttons	<p>The indicator lights up momentarily when pressed to show which equipment the remote control is operating:</p> <p>VCR/DVD: Press to have the remote control operate the VCR or DVD player.</p> <p>SAT/CABLE: Press to have the remote control operate the satellite receiver or cable box.</p> <p>TV: Press to have the remote control operate the TV.</p>
15 TV/SAT	<p>When the remote control is set to operate the satellite receiver, press to switch between the satellite receiver's TV and SAT (satellite) inputs.</p> <p>Ⓜ When the remote control is set to operate the TV, press repeatedly to step through the Audio Effect options. Also available in the Audio Menu. For details, see page 80.</p>

Button	Description
16 TV/VIDEO	Press repeatedly to cycle through the TV's video inputs.
17 DISPLAY	Press once to display the current channel number, current time, and channel label (if set) and other information. Press again to turn Display off.
18 SCREEN MODE	Press to toggle between the Screen Mode options. For details on using Screen Mode, see pages 55-57. Also available in the Screen Menu (pages 82-83).
19 0 - 9 ENTER 	Press 0 - 9 to select a channel; the channel changes after 3 seconds. Press ENTER to change channels immediately. Use the  button with 0-9 and ENTER buttons to select digital channels (for example, 2.1). For details on selecting digital channels, see page 52.
20 GUIDE	Press to display the program guide of your satellite program provider.
21 	Press     to move the on-screen cursor. To select an item, press  . When no menus are displayed, pressing  displays the Favorite Channels screen. (For more information about Favorite Channels, see page 58.)
22 MENU	Press to display the Menu. Press again to exit from the Menu. For details, see "Using the Menus" on page 77.
23 CH +/-	Press to scan through channels. To scan quickly through channels, press and hold down either CH button.

Programming the Remote Control

If you have video equipment other than Sony brand (or if you have a Sony DVD/VCR combination unit) that you want to control with the TV's remote control, use the following procedure to program the remote control.

 **The equipment must have infrared (IR) remote capability in order to be used with the remote control.**

- 1** Turn to the list of "Manufacturer's Codes" on page 50, and find the three-digit code number for the manufacturer of your equipment. (If more than one code number is listed, use the number listed first.)
- 2** Press **CODE SET**.
- 3** Press the **VCR/DVD FUNCTION** or **SAT/CABLE FUNCTION** button.
- 4** Using the **0-9** buttons, enter the three-digit manufacturer's code number.
- 5** Press the **ENTER** button.

 **You must do step 5 within 10 seconds of step 4, or you must redo steps 2 through 5.**

- 6** To check if the code number works, aim the TV's remote control at the equipment and press the **POWER** button that corresponds with that equipment. If it responds, you are done. If not, try using another code listed for that manufacturer.

Notes

- If more than one code number is listed, try entering them one by one until you come to the correct code for your equipment.
- If you enter a new code number, the code number you previously entered at that setting is erased.
- In some cases, you may not be able to operate your equipment with the supplied remote control. In such cases, use the equipment's own remote control.
- Whenever you remove the batteries to replace them, the code numbers may revert to the factory setting and must be reprogrammed.

Manufacturer's Codes

VCRs

<i>Manufacturer</i>	<i>Code</i>
Sony	301, 302, 303
Admiral (M. Ward)	327
Aiwa	338, 344
Audio Dynamic	314, 337
Broksonic	319, 317
Canon	309, 308
Citizen	332
Craig	302, 332
Criterion	315
Curtis Mathes	304, 338, 309
Daewoo	341, 312, 309
DBX	314, 336, 337
Dimensia	304
Emerson	319, 320, 316, 317, 318, 341
Fisher	330, 335
Funai	338
General Electric	329, 304, 309
Go Video	322, 339, 340
Goldstar	332
Hitachi	306, 304, 305, 338
Instant Replay	309, 308
JC Penney	309, 305, 304, 330, 314, 336, 337
JVC	314, 336, 337, 345, 346, 347
Kenwood	314, 336, 332, 337
LXI (Sears)	332, 305, 330, 335, 338
Magnavox	308, 309, 310
Marantz	314, 336, 337
Marta	332
Memorex	309, 335
Minolta	305, 304
Mitsubishi/ MGA	323, 324, 325, 326
Multitech	325, 338, 321
NEC	314, 336, 337
Olympic	309, 308
Optimus	327
Orion	317
Panasonic	308, 309, 306, 307
Pentax	305, 304
Philco	308, 309
Philips	308, 309, 310
Pioneer	308
Quasar	308, 309, 306
RCA/ PROSCAN	304, 305, 308, 309, 311, 312, 313, 310, 329

<i>Manufacturer</i>	<i>Code</i>
Realistic	309, 330, 328, 335, 324, 338
Sansui	314
Samsung	322, 313, 321
Sanyo	330, 335
Scott	312, 313, 321, 335, 323, 324, 325, 326
Sharp	327, 328
Signature 2000 (M. Ward)	338, 327
SV2000	338
Sylvania	308, 309, 338, 310
Symphonic	338
Tashiro	332
Tatung	314, 336, 337
Teac	314, 336, 338, 337
Technics	309, 308
Toshiba	312, 311
Wards	327, 328, 335, 331, 332
Yamaha	314, 330, 336, 337
Zenith	331

Laserdisc Players

<i>Manufacturer</i>	<i>Code</i>
Sony	701
Panasonic	704, 710
Pioneer	702

DVD/VCR Combination Units

<i>Manufacturer</i>	<i>Code</i>
Sony	601
Broksonic	605
JVC	604
Panasonic	609
Samsung	603
Toshiba	602

DVD Players

<i>Manufacturer</i>	<i>Code</i>
Sony	751
Apex	762
General Electric	755
Hitachi	758
JVC	756
Magnavox	757
Mitsubishi	761
Oritron	759
Panasonic	753
Philips	757
Pioneer	752
RCA/Proscan	755
Samsung	758
Toshiba	754
Zenith	760

Cable Boxes

<i>Manufacturer</i>	<i>Code</i>
Sony	230
Hamlin/Regal	222, 223, 224, 225, 226
Jerrold/G. I./ Motorola	201, 202, 203, 204, 205, 206, 207, 208, 218
Oak	227, 228, 229
Panasonic	219, 220, 221
Pioneer	214, 215
Scientific Atlanta	209, 210, 211
Tocom	216, 217
Zenith	212, 213

Satellite Receivers

<i>Manufacturer</i>	<i>Code</i>
Sony	801
Dish Network	810
Echostar	810
General Electric	802
Hitachi	805
Hughes	804
Mitsubishi	809
Panasonic	803
RCA/ PROSCAN	802, 808
Toshiba	806, 807

Using the Features

Overview

This chapter describes how to use the features of your TV.

<i>Topic</i>	<i>Page</i>
Watching TV	52
Using the Program Guide	53
Using Screen Mode (30/34 models only)	55
Using Screen Mode (32/36 models only)	57
Using Favorite Channels	58
Using Other Equipment with Your TV Remote Control	59

Watching TV

 For a complete list of all the functions of the remote control, see pages 45-50.

To Do This ...	Do This ...
Activate the remote control to operate the TV	Press TV FUNCTION
Turn on/off the TV	Press TV POWER
Tune directly to a channel	To tune to analog channels, press 0-9 and then ENTER . For digital subchannels, press 0-9 , ⊖ , press 0-9 again, and then ENTER . For example, to select subchannel 21.13, press 2+1+⊖+1+3 , and then press ENTER .
	 You can also select channels using the program guide. See pages 53 for details.
Adjust the volume	Press VOL +/-
Mute the sound	Press MUTING (press again to unmute)
Alternate back and forth between two channels	Press JUMP The TV alternates between the current channel and the last channel tuned.
Display the current channel number (and other information)	Press DISPLAY once to display the channel number, current time, and channel label (if set). Press DISPLAY again to turn Display off.
Switch the TV's input to the VCR, DVD player, or other connected equipment	Press TV/VIDEO repeatedly to cycle through the video equipment connected to the TV's video inputs.
Change video and audio options, customize the TV's setup, set parental controls, and more	Press MENU to display the Menu. For details, see "Using the Menus" on page 77.
Switch the TV's input between sources connected to the TV's VHF/UHF and CABLE inputs	Press ANT to alternate between sources connected to the TV's VHF/UHF and CABLE inputs.

Using the Program Guide

The program guide lets you review program information and select both analog and digital channels.

 **The Program Guide cannot be displayed when the TV is tuned to one of the video inputs or if the Channel Fix option is set to anything other than Off (see page 84).**



To display the program guide:

Press **GUIDE** on the TV's remote control. The program guide appears, with the currently selected program showing in the background.

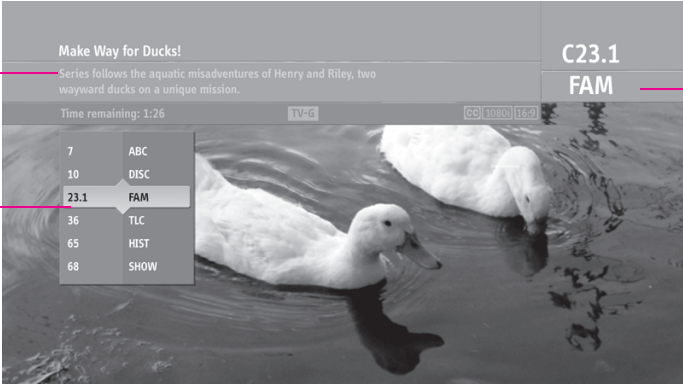

Program title and description, time remaining, rating information, closed-caption availability, format, resolution (if digital), aspect ratio

Selectable channel list

Channel number, call letters, Auto SAP (if available)

 **Program information in the guide is provided by the broadcasters. As a result, it may sometimes include only the channel number, without a program title or description.**

To Do This ...	Do This ...
Scroll through the channel list	Press ▲ ▼
Select the currently displayed channel and exit the guide	Press ⏏ .
Display additional options	Press ▶ . See "Using Additional Program Guide Options" on page 54.
Exit the Guide (without changing channels)	Press GUIDE

Using Additional Program Guide Options

Press **➤** while in the program guide's channel list to display the following options, which allow you to customize the settings of the program on the currently tuned channel.

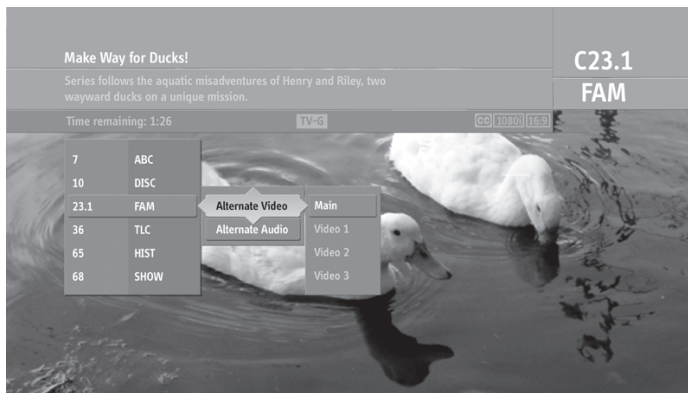

Option	Description
Alternate Video (when available)	Each program has a main video stream (the video that you see when the channel is first tuned), and may have alternate video streams. This option allows you to switch among these alternate video streams.
Alternate Audio (when available)	Each program has a main audio stream (the audio that you hear when the channel is first tuned). This option allows you to switch among these alternate audio streams (e.g., for different languages).









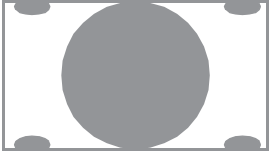

Using Screen Mode (30/34 models only)

The Screen Mode feature lets you change the picture size for both standard-definition (480i/480p) and high-definition (720p/1080i) sources.

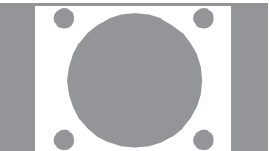
 You can also access the Screen Mode settings in the Screen Menu. For details, see page 82.

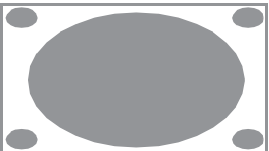











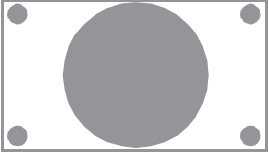

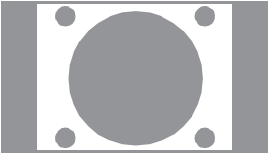
- Press **SCREEN MODE** repeatedly to toggle through the following Screen Mode settings.

Using Screen Mode with Standard Definition (480i/480p) Sources

Example	Description	
  Wide Zoom	Wide Zoom enlarges the center portion of the picture proportionately. The left and right edges of the picture are stretched to fill the 16:9 screen.	
  Normal	Normal displays the 4:3 picture in its original size. Bars are shown to fill the 16:9 screen.	
  Full	Full stretches the 4:3 picture horizontally, to fill the 16:9 screen.	
  Zoom	Zoom enlarges the 4:3 picture proportionately to fill the 16:9 screen. Some clipping may occur. Zoom is useful for watching Letterbox movies.	

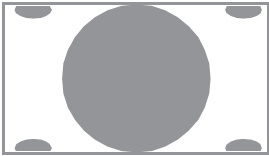
When you change channels or inputs, the Screen Mode settings revert to the **4:3 Default** setting in the Screen Menu. To retain the current Screen Mode setting as channels and inputs are changed, set **4:3 Default** to **Off**. For details, see page 82.

Using Screen Mode with High-Definition (720p/1080i) Sources











Example	Description
  Full (native 16:9)	Full displays the picture at its original size. If the source is a 16:9 high-definition (720p/1080i) signal, the picture fills the screen. 
 Full (upconverted 4:3)	If the source is a 4:3 standard-definition signal that has been upconverted, bars are shown to fill the 16:9 screen. 
  Zoom	Zoom enlarges the picture proportionately, both vertically and horizontally. Some clipping may occur. 
  Horizontal Expand	Horizontal Expand stretches the picture horizontally. Some clipping may occur. 
  Vertical Expand	Vertical Expand stretches the picture vertically. Some clipping may occur. 

Features

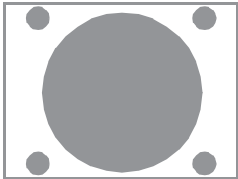
Using Screen Mode (32/36 models only)

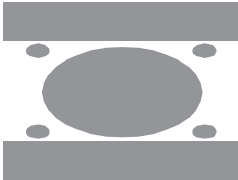
The Screen Mode feature is useful when a 480i signal has been upconverted to a 720p or 1080i signal, which results in undesirable “black bars” appearing on all four sides of the picture. Using the Screen Mode feature, you can enlarge these pictures, minimizing the size of the black bars.

Using Screen Mode with High Definition (720p/1080i) Sources

Example	Description	
  Full ↓	Full displays a 480i signal that has been upconverted to 720p or 1080i with black bars visible at left, right, top, and bottom sides.	
  Zoom ↓	Zoom enlarges the picture, minimizing the size of the black bars.	
  Horizontal Expand ↓	Horizontal Expand stretches the picture horizontally. Some clipping may occur.	
  Vertical Expand	Vertical Expand stretches the picture vertically. Some clipping may occur.	



Using Favorite Channels



The Favorite Channels feature lets you select programs from a list of up to 16 favorite channels that you specify. You can create a list using the Favorite Channel option in the Channel Menu, or by using the Add to Favorites feature in the Favorite Channels guide.

Using the Channel Menu







 For details on using the Channel Menu, see page 84.

- 1 Press **MENU** to display the Menu.
- 2 Press **▲** or **▼** to highlight the Channel icon and press .
- 3 Press  to select **Favorite Channels**.
- 4 Use the **0-9** and **ENTER** buttons to enter the channel number that you want to assign to the Favorite Channel number. Press  to select that channel as a Favorite Channel.

 **To enter digital channel numbers in step 4, use the 0-9, , and ENTER buttons.**

- 5 To add more channels to your favorites list, repeat step 4.
To clear a Favorite Channel, press **▲** or **▼** to highlight the channel you want to clear. Press  and then press **RESET**.
- 6 Press **MENU** to exit the Menu.

Using the Favorite Channels Guide

- 1 During normal viewing (with no menus on screen), press . The Favorite Channels list appears.
- 2 Press **▲** or **▼** to highlight the channel you want to watch.
To add the current channel to the list of Favorite Channels, highlight **Add to Favorites** and press .
To change your Favorite Channels list, highlight **Edit Favorites** and press .
- 3 Press  to select the channel you want to watch.

Using Other Equipment with Your TV Remote Control

All Equipment

To Do This ...	Do This ...
Switch the TV's input to the VCR, DVD player, or other connected equipment	Press TV/VIDEO repeatedly to cycle through the video equipment connected to the TV's video inputs.
Set up the TV remote control to operate non-Sony equipment (and Sony DVD/VCR combination unit)	You must program the remote control the first time you use it. See "Programming the Remote Control" on page 49.

Operating a VCR

To Do This ...	Press
Activate the remote control to operate the VCR	VCR/DVD FUNCTION
Turn on/off	VCR/DVD POWER
Change channels	CH +/- (using tuner)
Adjust tracking	CH +/- (during tape playback)
Record	▶ and ● simultaneously
Play	▶
Stop	■
Fast forward	▶▶
Rewind the tape	◀◀
Pause	
Search the picture forward or backward	▶▶ or ◀◀ during playback (release to resume normal playback)

Operating a Satellite Receiver

To Do This ...	Press
Activate the remote control to operate the satellite receiver	SAT/CABLE FUNCTION
Turn on/off	SAT/CABLE POWER
Select a channel	0-9, ENTER
Change channels	CH +/-
Back to previous channel	JUMP
Display channel number	DISPLAY
Display SAT Guide	GUIDE
Display SAT Menu	MENU
Move highlight (cursor)	↑ ↓ ← →
Select item	⊕

Operating a Cable Box

To Do This ...	Press
Activate the remote control to operate the cable box	SAT/CABLE FUNCTION
Turn on/off	SAT/CABLE POWER
Select a channel	0-9, ENTER
Change channels	CH +/-
Back to previous channel	JUMP

Operating a DVD Player

To Do This ...	Press
Activate the remote control to operate the DVD	VCR/DVD FUNCTION
Turn on/off	VCR/DVD POWER
Play	▶
Stop	■
Pause	⏸
Step through different tracks of the disc	▶▶ to step forward or ◀◀ to step backward
Step through different chapters of a video disc	CH+ to step forward or CH- to step backward
Select tracks directly	0-9, ◀ ▶ (to move cursor), ENTER
Display the DVD menu	MENU
Move highlight (cursor)	↑ ↓ ◀ ▶
Select item	SELECT

Operating a DVD/VCR Combination Unit

 When the VCR is not playing, TV/VCR/DVD switches between the DVD player and the VCR's tuner.

To Do This ...	Press
Activate the remote control to operate the DVD/VCR	VCR/DVD FUNCTION
Turn on/off	VCR/DVD POWER
Switch between the DVD player and VCR	TV/VCR/DVD
Display the DVD menu	MENU
Play	▶
Stop	■
Pause	⏸
Search the picture forward or backward	▶▶ or ◀◀ during playback
Move highlight (cursor) and select (DVD)	↑ ↓ ◀ ▶ ⊕
Record (VCR)	▶ and ● simultaneously
Change channels (VCR)	CH +/- or 0-9, ENTER (using tuner)
Adjust tracking (VCR)	CH +/- (during tape playback)

Using the Memory Stick Viewer

About Memory Stick

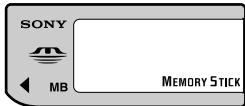

Memory Stick (sold separately) is a compact, portable, and versatile Integrated Circuit recording medium with a data capacity that makes it perfect for portable applications, such as digital photography. Memory Stick is specially designed for sharing digital data among Memory Stick compatible products such as digital cameras and digital video cameras. Because it is removable, Memory Stick can also be used for external data storage.

The Memory Stick Viewer on your TV allows you to view files that are stored on Memory Stick media. You can view:

- ❑ Digital photos (JPEG files)
- ❑ Movies (MPEG1 files)

You can also play slide show background music using MP3 files (or m3u playlists) stored on your Memory Stick.

For more information about handling Memory Stick media, see “Notes on Using Memory Stick Media” on page 75.

Features

With the Memory Stick Viewer, you can:

- ❑ View photo (JPEG) and movie (MPEG1) files in a thumbnail index or Slide Show
- ❑ Set customized Slide Show options, including transitions and background audio
- ❑ Pan, zoom, and rotate photos
- ❑ Mark photos and set quantities of prints to be output when the Memory Stick is inserted into your photo printer (not supplied)
- ❑ Lock (protect) or delete files on the Memory Stick

Memory Stick Compatibility

This television is compatible with the following Sony brand Memory Stick media types:

- ❑ Memory Stick Media
- ❑ Memory Stick Duo and PRO Duo Media (without the Memory Stick adaptor)

 The Memory Stick slot on your TV has been designed to accommodate standard and compact versions of Memory Stick. It is not necessary to use an adaptor for Memory Stick Duo and Memory Stick PRO Duo. If you use an adaptor it may damage the adaptor and Memory Stick slot.

- ❑ Memory Stick Media with Memory Select Function
- ❑ Memory Stick PRO Media

About Memory Stick PRO Media

Memory Stick PRO media features vary by and are dependent upon the design of host hardware devices. Memory Stick PRO in this television has been tested to support up to 1 GB media capacity and does not support high-speed transfer, MagicGate copyright protection technology, or access control security features.

Memory Stick Functionality

Sony cannot guarantee or assure the Memory Stick functionality on this television in the following cases:

- ❑ You are using non-Sony brand Memory Stick media.
- ❑ You are using video or audio clips that have been processed on a computer.
- ❑ You are using files that were obtained from the Internet or from a printed film processing center.
- ❑ The Memory Stick has been formatted on a personal computer.

Sony recommends that you back up all data stored on Memory Stick media to avoid potential data loss. In the above two cases, in order to avoid potential data corruption that may occur, be sure to back up data prior to use with the TV's Memory Stick Viewer. Sony cannot accept responsibility in the event that data recorded to Memory Stick media is lost or damaged. For certain non-Sony brand Memory Stick media, you can view images, but you cannot rotate, delete or protect/unprotect images on the television. An error message will occur if you attempt any of these operations. This is a result of the unique file directory structure on these particular flash memory media and is not a malfunction of the television.

File Compatibility

The Memory Stick Viewer is compatible with JPEG images taken with Sony digital still cameras and MPEG1* movies taken with Sony digital cameras and camcorders. In order to be viewable in the Memory Stick Viewer, the files must have the following file name extensions:

<i>File Type</i>	<i>Supported File Name Extensions</i>
JPEG	.jpg .jpeg
MPEG1	.mpg .mpeg

Trademark Information

Memory Stick, Memory Stick Duo, Memory Stick PRO, Memory Stick PRO Duo, and MagicGate are trademarks of Sony Corporation.

*Some variations of MPEG1 movies may not play back correctly.

Inserting and Removing a Memory Stick

Inserting a Memory Stick

 The Memory Stick slot on your TV has been designed to accommodate standard and compact versions of Memory Stick. It is not necessary to use an adapter for Memory Stick Duo and Memory Stick PRO Duo. If you use an adapter it may damage the adapter and Memory Stick slot.

- 1 Locate the Memory Stick slot (see page 12) and insert the Memory Stick into the Memory Stick slot as illustrated below. When inserted properly, it should slide in with little resistance and click into place.

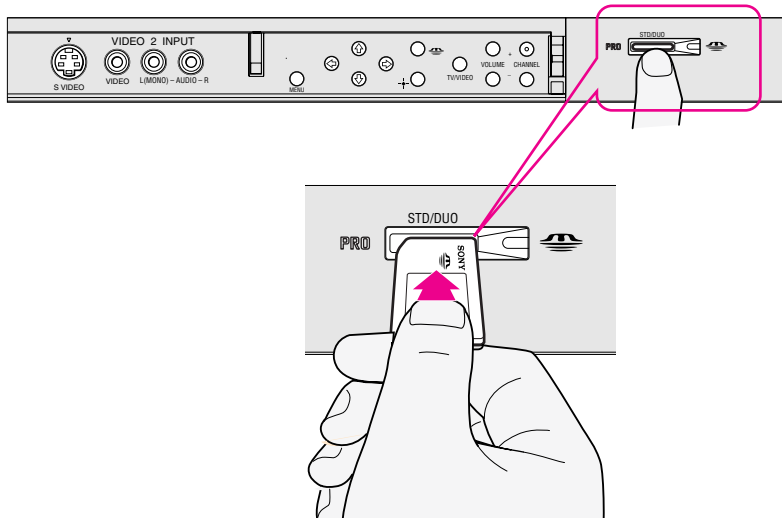

 Be sure to insert the Memory Stick in the correct direction. If the Memory Stick is forced in the wrong way, it may become damaged.

Insert only Memory Stick media into the Memory Stick slot. Attempting to insert other objects into the slot may damage the TV.

To remove the Memory Stick, see "Removing a Memory Stick" on page 65.

Removing a Memory Stick

To remove a Memory Stick

- 1 Check that the Memory Stick indicator is off. (When the light is on, this indicates that the TV is reading data from the Memory Stick.)

 Removing the Memory Stick while a file is being accessed (when the Memory Stick LED on the TV's front panel is lit) may damage the Memory Stick or its contents.

- 2 Push the Memory Stick gently into the slot, and then release it. The Memory Stick media is ejected.

 Do not pull out the Memory Stick without first pushing it in; otherwise, the TV's locking mechanism may become damaged.

- 3 Pull the Memory Stick completely out of the slot.

 To protect small children from injury from Memory Stick Media, remove all Memory Stick media from the TV's Memory Stick slot and store it in a safe location when it is not in use.

Using the Memory Stick Index

Turn on the TV and insert a Memory Stick that contains the photo or movie files you want to view. For details, see page 64.



If the Memory Stick Index does not appear, press the MEMORY STICK button on the remote control.

The Memory Stick Index appears, which displays thumbnail images of the files stored on the Memory Stick.

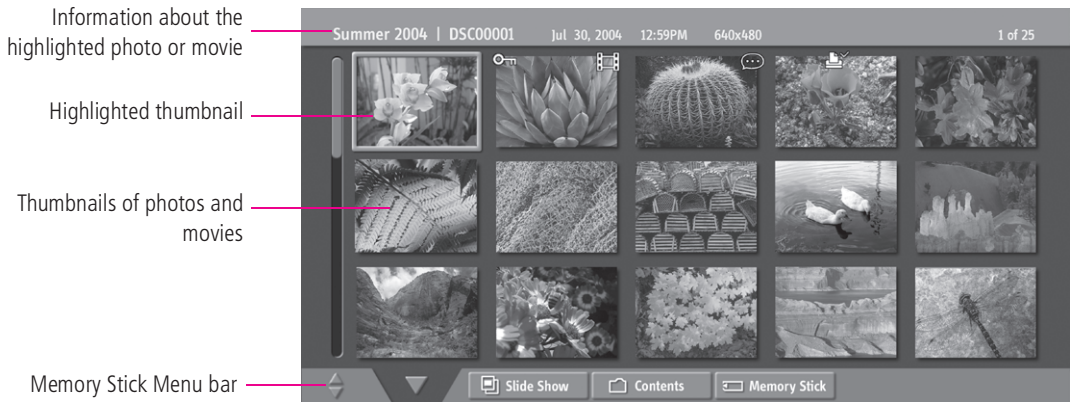

About the Icons on the Thumbnail Images

- Indicates the thumbnail is a movie (MPEG1) file instead of a photo (JPEG) file.
- Indicates the thumbnail is locked. Locked files cannot be changed or deleted. For details, see "Protect" on page 69.
- Indicates that the photo is marked to be printed.
- Indicates that the photo has an associated voice memo.

Using the Memory Stick Index

The following describes how to use the Memory Stick Index.

To Do This ...	Do This ...
Move the highlight to a photo, voice memo (🗣️), or movie (🎬) thumbnail	Press ▲ ▼ ◀ ▶ .
Display the highlighted photo, voice memo, or movie file full screen	Press (◀▶) . For details, see "Viewing Photos" on page 68 and "Playing Movies" on page 71.
Display the next page of thumbnails	<ol style="list-style-type: none"> 1 Press ▼ to select ▼. 2 Press ▼ to display the next page of thumbnails.
Display the previous or next page of thumbnails	<ol style="list-style-type: none"> 1 Press ▼ to select ▼. 2 Press ◀ to select ◀. 3 To go to the previous page, press ▲. To go to the next page, press ▼.
Use the Memory Stick Menu bar to access additional options	<ol style="list-style-type: none"> 1 Press ▼ to select ▼. 2 Press ◀ or ▶ to select Slide Show, Contents, or Memory Stick. 3 Press ▲ or ▼ to select the option you want to change. <p>For details on these options, see "Memory Stick Index Menu Bar Options" on page 73.</p>
Move the highlight from the Memory Stick Menu bar back to the thumbnails	<ol style="list-style-type: none"> 1 Press ◀ or ▶ to select ▼. 2 Press ▲ to return to the currently displayed thumbnails, or ▼ to display the next page of thumbnails.
Exit Memory Stick Viewer	Press the MEMORY STICK button on the remote control.

Viewing Photos

When you select a photo from the Memory Stick Index (described on page 66), it displays as shown below, with the following controls.



JPEGs captured using a digital video camera may appear to display motion in full screen. This is a result of the way digital video cameras record still images, and is not a result of a malfunction with the TV.

Photo Controls

When the Menu is hidden, press ◀ or ▶ to go to the previous or next photo.

To Do This ...	Do This ...
Display the next or previous file on the Memory Stick	Highlight the ◀ ▶ (Previous/Next) button. Then press ◀ to go to the previous file, or ▶ to go to the next file.
Hide the Photo Menu bar, displaying only the photo	With the highlight in the Photo Menu bar, press ↓.
Display the hidden Photo Menu bar	Press ↑.
Play the JPEG voice memo (🗣️ files only)	Highlight ▶ (Play) and then press (⏮). To pause the voice memo, highlight (Pause) and then press (⏮).
Display the Memory Stick Index again	Highlight Index in the Photo Menu bar and press (⏮). For details on the Memory Stick Index, see page 67.
Access additional options in the Photo Menu bar	See "Photo Menu Bar Options" on page 69.
Exit Memory Stick Viewer	Press the MEMORY STICK button on the remote control.



Photo Menu Bar Options

The Photo Menu bar lets you access additional photo viewing options.

To access the Photo Menu bar

- 1 Press ◀ or ▶ to select **Index**, **Slide Show**, **View**, or **File**.
- 2 Press ▲ or ▼ to select the desired option.

Option	Description
Index	Displays the Memory Stick Index, with the highlight on the thumbnail of the currently displayed photo. For details, see “Using the Memory Stick Index” on page 66.
Slide Show	Displays the Slide Show Menu. For details, see “Slide Show Menu Options” on page 73.
View	Rotate Allows you to rotate the photo in 90 degree increments clockwise or counterclockwise. For details, see “Using Rotate” on page 70.
	Zoom/Pan Allows you to magnify and pan across the photo. For details, see “Using Zoom and Pan” on page 70.
File	Protect Allows you to protect the JPEG file from any changes. When a JPEG file is protected, it cannot be rotated or deleted. Select On or Off .
	Print Quantity Allows you to indicate the number of prints to make of the specific photo when the Memory Stick is inserted into a compatible photo printer (not supplied).
	Delete Deletes the JPEG file from the Memory Stick. You cannot delete a JPEG file that has been protected (or if the Memory Stick is locked).

 JPEG files that are protected are indicated by the Lock  icon.

 The **Print Quantity** feature is also known as DPOF (Digital Print Order Format).

Using Zoom and Pan

To Zoom and Pan a photo

- 1 In the Photo Menu bar, highlight **View**.
- 2 Highlight **Zoom/Pan** and press **(+/-)**.
- 3 Specify the zoom center point by pressing **← → ↑ ↓**; then press **(+/-)** to set the center.

The Zoom and Pan controls are displayed.

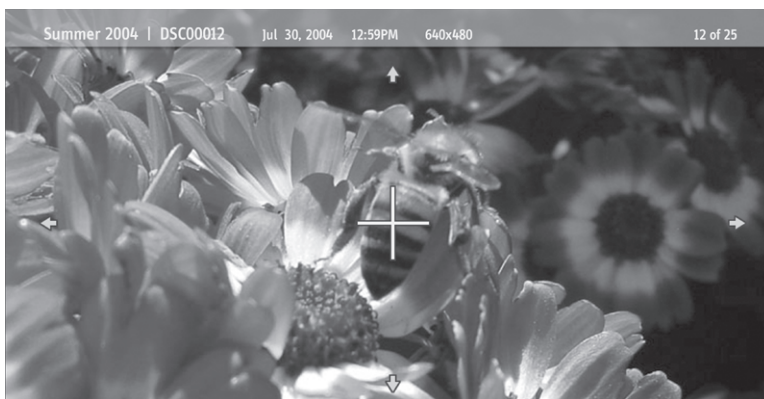

To Do This ...

Zoom in (increase magnification) or out (decrease magnification)

Pan (move the photo left, right, up, down)

Exit the Zoom/Pan controls

Exit Memory Stick Viewer

Do This ...

Highlight **Zoom** and press **↑** to zoom in or **↓** to zoom out. For help on using Zoom, press **(+/-)**.

(You can use Pan only when the photo is magnified using Zoom.)

Highlight **Pan** and press **(+/-)**. Then press **← → ↑ ↓** to pan around the photo.

To stop using Pan, press **(+/-)**.

Highlight **Exit** and press **(+/-)**.

Press the **MEMORY STICK** button on the remote control.

Using Rotate

To Rotate a photo

- 1 In the Photo Menu bar, highlight **View**.
- 2 Highlight **Rotate**.
- 3 To rotate clockwise, highlight **Clockwise** and press **(+/-)**. To rotate counterclockwise, highlight **Counterclockwise** and press **(+/-)**.

The photo is rotated 90 degrees each time you press **(+/-)**.

Playing Movies

When you select a movie from the Memory Stick Index (described on page 66), it displays as shown below, with the following controls.

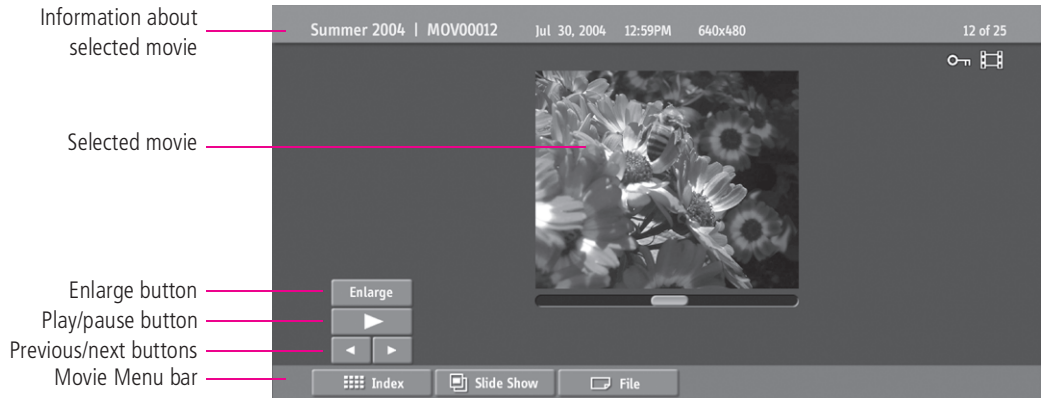



MPEG movies recorded in VX Fine mode with Sony digital cameras cannot be played back with the Memory Stick Viewer.

Movie Controls

The quality of the movie when enlarged depends on the resolution of the MPEG1 file. See your camera's instruction manual for details.

To Do This ...	Do This ...
Enlarge the movie window	Highlight Enlarge , and then press . To display the movie controls again, press . When the movie ends, the movie controls are displayed again.
Play the movie with the movie controls displayed	Highlight (Play) and then press .
Pause the movie	Highlight (Pause) and then press .
Display the previous or next file on the Memory Stick	Highlight the (Previous/Next) button. Then press to go to the previous file, or to go to the next file.
Hide the Movie Menu bar, displaying only the movie	With the highlight in the Movie Menu bar, press .
Display the hidden Movie Menu bar	Press .
Access additional options in the Movie Menu bar	See "Movie Menu Bar Options" on page 72.
Exit Memory Stick Viewer	Press the MEMORY STICK button on the remote control.

Movie Menu Bar Options

 MPEG1 files that are protected are indicated by the Lock  icon.

To access the Movie Menu bar

- 1 Highlight **Index** in the Movie Menu bar.
- 2 Press **◀** or **▶** to select **Index**, **Slide Show**, or **File**.

Option	Description	
Index	Displays the Memory Stick Index, with the highlight on the thumbnail of the currently displayed movie.	
Slide Show	Displays the Slide Show Menu. For details, see “Slide Show Menu Options” on page 73.	
File	Protect	Allows you to the protect the MPEG1 file from any changes. When an MPEG1 file is protected, it cannot be deleted. Select On or Off .
	Delete	Deletes the MPEG1 file from the Memory Stick. You cannot delete an MPEG1 file that has been protected (or if the Memory Stick is locked).

Memory Stick Index Menu Bar Options

Slide Show Menu Options

 The Slide Show Menu is the same whether you select it from the Memory Stick Index (page 66), Photo (page 68), or Movie (page 71) Menus.

 When you select **Complete List**, it may take a moment to display the list of all MP3 files.

 Some JPEG files may take longer to display than others, which may make it seem longer than the interval you selected for **Slide Advance**.

 You can also display file information using the **DISPLAY** button on the remote control.

The Slide Show Menu includes the following options:

Option	Description
Start	Starts the Slide Show.
Music	Allows you to select background audio to play during the Slide Show.
Off	No additional background audio is played during the Slide Show. Audio that is associated with the JPEG or MPEG1 files will play.
Play Memory Stick	Plays all MP3 files on the Memory Stick. The Piano MP3 file and any MP3 file playlists are not played.
Piano (built-in)	Plays the MP3 file stored in the TV's internal memory.
(List of MP3 Files and Playlists)	Displays a list of all MP3 files and MP3 file playlists found at the top level (root) of the Memory Stick. To show additional MP3 files stored in other folders on the Memory Stick, select Complete List .
Complete List	Displays a list of all available MP3 files.
Transition Effect	Allows you to select an effect to be used when advancing to the next file in the Slide Show.
Slide Advance	Allows you to specify when to advance to the next slide.
Fast	Slide advances after about 3 seconds.
Medium	Slide advances after about 6 seconds.
Slow	Slide advances after about 12 seconds.
Manual	Slide advances only after you press ◀ or ▶ .
File Information	Determines whether file information is shown when the file is displayed full screen. Select On or Off .
Repeat	On Slide Show continuously loops. Off Slide Show plays once through all files and ends.

Contents Menu Options

 The Rotate function does not change the file's modification date.

The Contents Menu includes the following options:

Option	Description
Select Folder	Allows you to select different folders to view in the Memory Stick Viewer.
Digital Camera Folders	Selects all folders within the directories defined by the DCF rules used by Sony digital cameras (see page 75). JPEG and MPEG1 files in those directories are recognized even if they do not conform to the DCF file naming rules.
Select a Folder	Allows you to access individual folders on the Memory Stick.
File Order	Allows you to change the order in which the Memory Stick files are displayed.
Date Order	Displays files in chronological order by modification date.
Date Order Reverse	Displays files in reverse chronological order by modification date.
Alphabetical	Displays files in alphabetical order by filename.
Filter	Allows you to selectively display specific file types within the selected folder.
Show Photos and Movies	Displays all readable files.
Show Photos Only	Displays only photo (JPEG) files.
Show Movies Only	Displays only movie (MPEG1) files.
Show All Print Marks	Displays all files that are marked for printing. For details, see "Print Quantity" on page 69.

Memory Stick Menu

The Memory Stick Menu displays the current status of the Memory Stick, including total capacity, used capacity, and free capacity.

Notes on Using Memory Stick Media

About DCF File Names

Most Sony brand digital still and video cameras automatically record still photo and movie files using DCF compliant directory and file names.

If you selected the **Digital Camera Folders** option, as described on page 74, you might want to have your digital camera's instruction manual handy in order to check how files and directories are organized for your specific model of digital camera.

DCF stands for "Design Rules for Camera File Systems," which are specifications established by the Japan Electronic Industry Development Association (JEIDA).

Memory Stick Precautions

When using Memory Stick media, follow these precautions:

- ❑ To avoid permanent damage to still image data, do not turn off the TV or remove Memory Stick media from the insertion slot while data is being read (as indicated by the Memory Stick indicator light being on).
- ❑ Avoid touching the terminal of Memory Stick media or bringing it into contact with a metal object.
- ❑ Do not drop, bend, or submit Memory Stick media to external shock.
- ❑ Do not disassemble or modify Memory Stick media.
- ❑ Avoid getting liquid on Memory Stick media.
- ❑ Apply labels only within the designated label area.

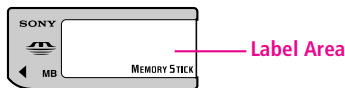









- ❑ To avoid permanent damage to still image data, do not use or store Memory Stick media in a location subject to:
 - ❑ High temperature (such as near a heater or inside a hot car)
 - ❑ High humidity
 - ❑ Direct sunlight
 - ❑ Corrosive substances
 - ❑ Magnetic fields
 - ❑ Excessive dust
 - ❑ Static electricity or electric noise
 - ❑ Electric surges
- ❑ Store and carry Memory Stick media in its original case to ensure protection of stored data.
- ❑ Save a backup of stored data.

Using the Menus



Overview

The Menu gives you access to the following features:

Menu	Description	Page
	The Video Menu allows you to make adjustments to your picture settings. It also allows you to customize the Picture Mode based on the type of program you are viewing, select Advanced Video options, and more.	78
	The Audio Menu Offers enhanced audio options such as listening to second audio programming (SAP) or customizing the Effect of the sound on your TV.	80
	30/34 models only The Screen Menu allows you to make Screen Mode adjustments and make changes to the screen's vertical center and size.	82
	32/36 models only The Screen Menu allows you to make Screen Mode adjustments and select options from the Analog 16:9 and Digital 16:9 features.	83
	The Channel Menu allows you to set up a Favorite Channel list, run the Auto Program function, label channels, and more.	84
	The Parental Lock Menu lets you control the viewing of programs based on their ratings.	86
	The Setup Menu provides options for setting up your system, including selecting closed caption modes, labeling video inputs, selecting the language and color of the on-screen Menus, and more.	89
	The Applications Menu lets you display the Memory Stick Viewer, set on/off Timers, access CableCARD and diagnostics information, and more.	92

 Press **MENU** to enter and exit Menus.

Navigating Through Menus

To Do This ...	Press
Display the Menu	MENU
Move through the Menus	↑ ↓ ← →
Select an option to change	
Select (confirm) changed setting	 or ↵
Exit the Menu	MENU

Using the Video Menu



To access the Video Menu, follow these steps:

1. Display Menu



2. Highlight



3. Press to select





To change settings, press **↑ ↓ ← →**.
Press **↵** to confirm the selection.

To exit the Menu, press **MENU**.



Selecting Video Options

 You can also change the Mode setting using the **PICTURE MODE** button on the remote control.

 You can alter the Video Menu settings (**Picture**, **Brightness**, **Color**, etc.) for each Mode.

The Video Menu includes the following options:

Option	Description
Mode <i>Customized picture viewing</i>	<p>Vivid Select for enhanced picture contrast and sharpness.</p> <p>Standard Select for standard picture settings.</p> <p>Movie Select to display a softer picture.</p> <p>Pro Select to display a picture with minimum enhancements.</p> <p>To control how the Mode settings (Vivid, Standard, Movie, Pro) are applied to each video input, see Mode Memory on page 79.</p>
Picture	Adjust to increase picture contrast and deepen the color, or decrease picture contrast and soften the color.
Brightness	Adjust to brighten or darken the picture.
Color	Adjust to increase or decrease color intensity.
Hue	Adjust to increase or decrease the green tones.
Sharpness	Adjust to sharpen or soften the picture.
Color Temp. <i>White intensity adjustment</i>	<p>Cool Select to give the white colors a blue tint.</p> <p>Neutral Select to give the white colors a neutral tint.</p> <p>Warm Select to give the white colors a red tint (NTSC-Standard).</p>



You can also change the DRC Mode using the **DRC MODE** button on the remote control.

Option	Description
ClearEdge VM Velocity Modulation	Sharpens picture definition to give every object a sharp, clean edge. Select from High, Medium, Low, Off .
Advanced Video	Select Program to choose among the Advanced Video options.
DRC Mode	Creates a high-resolution picture with 4x density, for high quality sources (i.e., DVD player, satellite receiver).
Interlaced	Recommended for moving pictures.
Progressive	Recommended for still images and text.
CineMotion	Provides an optimized display by automatically detecting film content and applying a reverse 3/2 pulldown process. Moving pictures will appear clearer and more natural-looking.
Color Axis	Allows you to control the emphasis of red tones.
Default	Emphasizes red tones.
Monitor	De-emphasizes red tones.
Mode Memory	Allows you to control how the Mode settings (Vivid, Standard, Movie, Pro) are applied to TV viewing, Memory Stick viewing, and each video input. For details about Mode settings, see page 78.
On	Set to On to customize Mode settings for each video input. Changing inputs might change the Mode setting.
Off	Set to Off to apply the same Mode settings to all video inputs. Changing inputs does not change the Mode setting.

To restore the factory default settings for Video settings:

- ❑ Press **RESET** on the remote control when in the Video Menu.

Using the Audio Menu



To access the Audio Menu, follow these steps:

1. Display Menu



2. Highlight

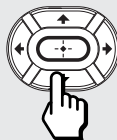

3. Press to select



To change settings, press **↑ ↓ ← →**.
Press **↵** to confirm the selection.

To exit the Menu, press **MENU**.



Selecting Audio Options

You can also change the Effect using the **⏸** button on the remote control.

The Audio Menu includes the following options:

Option	Description
Treble	Adjust to decrease or increase higher-pitched sounds.
Bass	Adjust to decrease or increase lower-pitched sounds.
Balance	Adjust to emphasize left or right speaker balance.
Steady Sound	Auto Select to stabilize the volume.
	Off Select to turn off Steady Sound.
 The Steady Sound option is not available (it is grayed out) if the Effect option is set to TruSurround or Simulated. To use Steady Sound, set Effect to Off.	
Effect	TruSurround Select for surround sound (for stereo programs only).
	Simulated Adds a surround-like effect to mono programs.
	Off Normal stereo or mono reception.
MTS <i>Enjoy stereo, bilingual and mono programs</i>	Stereo Select for stereo reception when viewing a program broadcast in stereo.
	Auto SAP Select to automatically switch the TV to second audio programs when a signal is received. (If no SAP signal is present, the TV remains in Stereo mode.)
	Mono Select for mono reception. (Use to reduce noise during weak stereo broadcasts.)
 MTS is available only with analog programs.	

<i>Option</i>	<i>Description</i>
Audio Out <i>Easy control of volume adjustments</i>	This option can be set only when the Speaker option is set to Off .
	Variable The TV's speakers are turned off, but the volume output from your audio system can still be controlled by the TV's remote control.
	Fixed The TV's speakers are turned off and the volume output of the TV is fixed. Use your audio receiver's remote control to adjust the volume through your audio system.
Speaker	On Select to turn on the TV speakers.
	Off Select to turn off the TV speakers and listen to the TV's sound only through your external audio system speakers.

To restore the factory default settings for Treble, Bass, and Balance

- ❑ Press **RESET** on the remote control when in the Audio Menu.

Using the Screen Menu (30/34 models only)



To access the Screen Menu, follow these steps:

1. Display Menu



2. Highlight

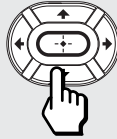

3. Press to select



To change settings, press **↑ ↓ ← →**.
Press **↵** to confirm the selection.

To exit the Menu, press **MENU**.

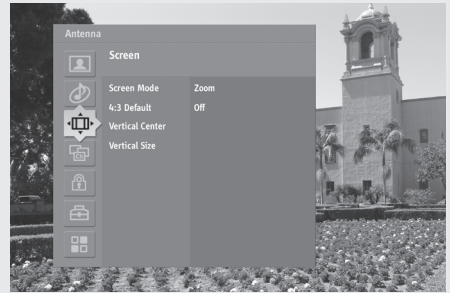

Selecting Screen Mode Options



You can also change the Screen Mode using the **SCREEN MODE** button on the remote control.

The Screen Menu includes the following options:

Option	Description
Screen Mode	<p>Enables you to change the picture size for both standard-definition (480i/480p) and high-definition (720p/1080i) sources.</p> <p>For 480i/480p sources Select from: Wide Zoom, Normal, Full, Zoom. For details, see page 55.</p> <p>For 720p/1080i sources Select from: Full, Zoom, Horizontal Expand, Vertical Expand. For details, see page 56.</p> <p>In some cases, wide-screen programs will be shown in aspect ratios that require the display of bars at the top and bottom of your 16:9 screen. For more details, see page 101.</p>
4:3 Default	<p>Select the default Screen Mode to use for 4:3 sources.</p> <p>To select a Screen Mode to use when channels or inputs are changed, select from: Wide Zoom, Normal, Full, Zoom. For details, see page 55.</p> <p>To continue using the current Screen Mode setting when the channel or input is changed, select Off.</p>
Vertical Center	<p>Allows you to move the position of the picture up and down in the window. (Available only in Wide Zoom and Zoom modes.)</p> <p>Press ↑ or ↓ and press ↵ to choose a correction between +15 and -15 (Zoom mode), and +5 and -5 (Wide Zoom mode).</p>
Vertical Size	<p>Allows you to adjust the vertical size of the picture. (Available only in Wide Zoom and Zoom modes.)</p> <p>Press ↑ or ↓ and press ↵ to choose a correction between +7 and -7.</p>

Using the Screen Menu (32/36 models only)



To access the Screen Menu, follow these steps:

1. Display Menu



2. Highlight

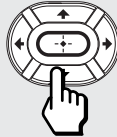

3. Press to select



To change settings, press **↑ ↓ ← →**.
Press **↵** to confirm the selection.

To exit the Menu, press **MENU**.

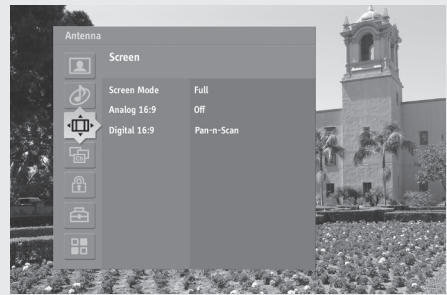

Selecting Screen Mode Options



You can also change the Screen Mode using the **SCREEN MODE** button on the remote control.



To use **Analog 16:9** with widescreen DVDs, set your DVD player to 16:9 aspect ratio. (Aspect ratio is the ratio of width to height of the screen. 16:9 is also referred to as widescreen format.)



Digital 16:9 is available only for digital broadcast sources (antenna or cable).

The Screen Menu includes the following options:

Option	Description
Screen Mode	<p>Enables you to change the picture size for both standard-definition (480i/480p) and high-definition (720p/1080i) sources.</p> <p>Select from: Full, Normal, Horizontal Expand, Vertical Expand. For details, see page 57.</p> <p>In some cases, wide-screen programs will be shown in aspect ratios that require the display of bars at the top and bottom of your 16:9 screen. For more details, see page 101.</p>
Analog 16:9	<p>Provides enhanced picture resolution for widescreen (anamorphic) sources, such as selected DVD titles. This option is available only when the TV is set to VIDEO 1-7.</p> <p>On To activate manually. Returns to Auto when you switch to another video input or change channels.</p> <p>Auto To activate automatically when a 16:9 signal is received.</p> <p>If the Auto setting does not automatically detect the 16:9 signal from your DVD player, select On to manually turn on the 16:9 Enhanced feature.</p>
Digital 16:9	<p>Allows you to determine the formatting for digital 16:9 pictures.</p>
Pan-n-Scan	<p>The picture is clipped to fit the 4:3 screen. This setting is temporary and will be reset when you change channels or video inputs, or turn off your TV.</p>
Letterbox	<p>The picture is made smaller so that the left and right edges fit the 4:3 screen. No clipping results, but bars appear at the top and bottom of the picture.</p>

Using the Channel Menu



To access the Channel Menu, follow these steps:

1. Display Menu



2. Highlight

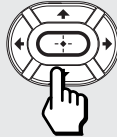

3. Press to select



To change settings, press **↑ ↓ ← →**.
Press **↵** to confirm the selection.

To exit the Menu, press **MENU**.

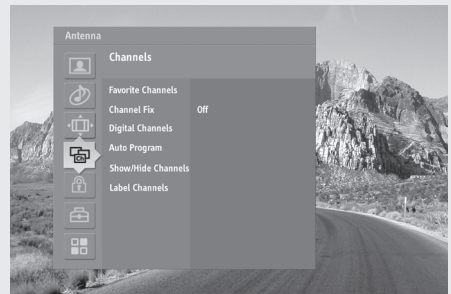

Selecting Channel Options

The Channel Menu includes the following options:

Option	Description
Favorite Channels	Lets you set up a list of your favorite channels. For details, see "Using Favorite Channels" on page 58.
Channel Fix	<p>Off Turns off Channel Fix.</p> <p>2-6 "Fix" your TV's channel setting to 2-6 (VHF/UHF input) and use the cable box or satellite receiver to change channels.</p> <p>C2-C6 "Fix" your TV's channel setting to C2-C6 (CABLE input) and use the cable box or satellite receiver to change channels.</p> <p>Video 1 Use this setting if you have connected the equipment to the A/V input jacks.</p>
Digital Channels	Add Select to add digital channels.
Auto Program	Automatically sets up the channel list on the TV for all receivable channels.

Auto Program may take 50 minutes or more to complete. A progress bar will display the approximate progress of the Auto Program and Digital Channels/Add sequences.

⚠ If you are using a CableCARD, Auto Program is disabled for the CABLE input. However, you can run Auto Program for the VHF/UHF input.

 Channels that you set to **Hidden** can be accessed only with the **0-9** buttons.

<i>Option</i>	<i>Description</i>
Show/Hide Channels	<p>Allows you to show or hide channels that appear in the Program Guide (page 53) and when you use the CH+/- buttons to channel surf. Channels that are set to Hidden do not appear in the Program Guide or when you use the CH+/- buttons.</p> <ol style="list-style-type: none">1 Press ▲ or ▼ to highlight the channel that you want to show or hide. To move between the Major and Digital subchannel lists, press ◀ or ▶.2 To change a channel's setting to Shown or Hidden, press ⏪.3 To show or hide more channels, repeat steps 1 and 2.
Label Channels	<p>Allows you to assign labels (such as station call letters) to channel numbers.</p> <ol style="list-style-type: none">1 Press ▲ ▼ to scroll through the channel numbers. Then press ⏪ to select the channel number that you want to assign a label.2 Press ▲ ▼ to scroll through the label characters (A-Z, 0-9, etc.). Then press ⏪ to select the highlighted character. Repeat to add characters to the label.3 To assign labels to more channels, repeat steps 1-2.4 Press ◀ to return to the Channel Menu, or press MENU to exit the Menus.

Using the Parent Menu



The Parent Menu allows you to set up the TV to block programs according to their content and rating levels.

To access the Parent Menu, follow these steps:

1. Display Menu
2. Highlight 
3. Press to select

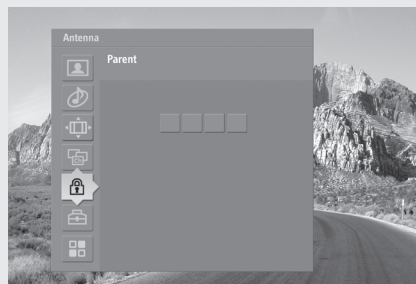
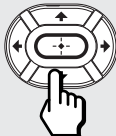

Use the **0-9** buttons on the remote control to enter a four-digit password.

If this is the first time you are creating this password, confirm the password by entering it again. (The Parent Menu options appear.)

To change settings, press **▲ ▼ ◀ ▶**. Press **⏏** to confirm the selection.

To exit the Menu, press **MENU**.

 **You need your password for any future access into the Parent Menu. If you lose your password, see "Lost password" on page 101.**

Selecting Parent Menu Options

 If you are not familiar with the Parental Guideline rating system, you should select **Child**, **Youth**, or **Y. Adult** to help simplify the rating selection. To set more specific ratings, select **Custom**.

 For descriptions of **Child**, **Youth**, and **Y. Adult** ratings, see page 87.

The Parent Menu includes the following options:

Option	Description
Parental Lock	Off Parental lock is off. No programs are blocked from viewing.
<i>Turn ratings on/off and select a rating system</i>	<p>Child Maximum ratings permitted are:</p> <ul style="list-style-type: none"> <input type="checkbox"/> US: TV-Y, TV-G, G <input type="checkbox"/> Canada: C, G, TV-Y <p>Youth Maximum ratings permitted are:</p> <ul style="list-style-type: none"> <input type="checkbox"/> US: TV-PG, PG <input type="checkbox"/> Canada: C8+, PG, 8 ans+, TV-PG <p>Y. Adult (Young Adult) Maximum ratings permitted are:</p> <ul style="list-style-type: none"> <input type="checkbox"/> US: TV-14, PG-13 <input type="checkbox"/> Canada: 14+, 13 ans+, TV-14 <p>Custom Select to set ratings manually.</p> <ul style="list-style-type: none"> <input type="checkbox"/> US: See page 87 for details. <input type="checkbox"/> Canada: See page 88 for details.
Change Password	For changing your password.
Select Country	<p>U.S.A. Select to use USA ratings (see page 87).</p> <p>Canada Select to use Canadian ratings (see page 88).</p>

US Models: Selecting Custom Rating Options

 The Content-Based Ratings are linked to the level of the Age-Based Rating. For example, a program with an Age-Based Rating of TV-PG V (Violence) rating may contain moderate violence, while a TV-14 V (Violence) rating may contain more intense violence.

 To ensure maximum blocking capability, set the Age-Based Ratings.

 If you block unrated TV programs, be aware that the following types of programs may be blocked: emergency broadcasts, political programs, sports, news, public service announcements, religious programs and weather.

For US models, the Custom Rating Menu includes the following options. (For Canadian models, see page 88.)

Option	Description
Movie Rating	G All children and General Audience.
	PG Parental Guidance suggested.
	PG-13 Parental Guidance for children under 13.
	R Restricted viewing, parental guidance is suggested for children under 17.
	NC-17 and X No one 17 or under allowed.
TV Rating <i>Block programs by their rating, content or both</i>	Age-Based Ratings
	TV-Y All children.
	TV-Y7 Directed to children age 7 and older.
	TV-G General Audience.
	TV-PG Parental Guidance suggested.
	TV-14 Parents Strongly cautioned.
	TV-MA Mature Audience only.
	Content-Based Ratings
	FV Fantasy Violence.
	D Suggestive Dialogue.
L Strong Language.	
S Sexual situations.	
V Violence.	
Unrated <i>Block programs or movies that are broadcast without a rating</i>	Allow Allows programs and movies that are broadcast without a rating.
	Block Blocks all programs and movies that are broadcast without a rating.

Viewing Blocked Programs

You can view blocked programs by entering the password. Press the **ENTER** button when tuned to a blocked program, then enter the password. This temporarily switches off the Parental Lock. To reactivate the Parental Lock settings, turn off the TV. When the TV is turned on again, your Parental Lock settings are reactivated.

Canadian Models: Selecting Custom Rating Options

For Canadian models, the Custom Rating Menu includes the following options. (For US models, see page 87.)

Option	Description
English Rating	C All children.
	C8+ Children 8 years and older.
	G General programming.
	PG Parental Guidance.
	14+ Viewers 14 and older.
	18+ Adult programming.
French Rating	G General programming.
	8 ans+ Not recommended for young children.
	13 ans+ Not recommended for ages under 13.
	16 ans+ Not recommended for ages under 16.
	18 ans+ Programming restricted to adults.
U.S.A. Rating	See "US Models" on page 87 for details.

Viewing Blocked Programs

You can view blocked programs by entering the password. Press the **ENTER** button when tuned to a blocked program, then enter the password. This temporarily switches off the Parental Lock. To reactivate the Parental Lock settings, turn off the TV. When the TV is turned on again, your Parental Lock settings are reactivated.

Using the Setup Menu



To access the Setup Menu, follow these steps:

1. Display Menu



2. Highlight

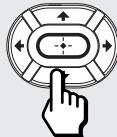

3. Press to select



To change settings, press **↑ ↓ ← →**.
Press **↵** to confirm the selection.

To exit the Menu, press **MENU**.

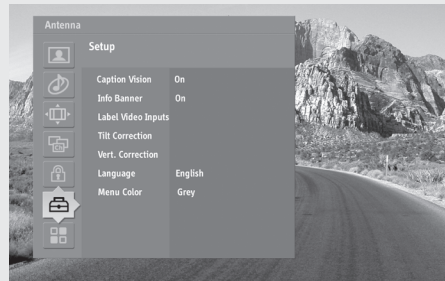



Selecting Setup Options

The Setup Menu includes the following options:

Option	Description
Caption Vision	Allows you to select from several closed caption modes (for programs that are broadcast with closed caption). On Caption Vision is turned on. Off Caption Vision is turned off.
Program	Allows you to set basic and advanced Caption Vision options. See “Programming Caption Vision” on page 91.
Info Banner	Set to On or Off . When on, displays the program name, time remaining and other information (if the broadcaster offers this service). Displays when the channel is changed or the DISPLAY button is pressed.

Option	Description
Label Video Inputs	<p>Allows you to identify A/V equipment you connected to the TV, such as a VCR, DVD, etc. For example, if you have a DVD player connected to the VIDEO 5 jack, you can select the label DVD for the VIDEO 5 input. Then when you press the TV/VIDEO button to change inputs, the Video Label you assigned to that input appears on screen.</p> <ol style="list-style-type: none"> 1 Press ▲ or ▼ to highlight the video input (VIDEO 1-7) to which you want to assign a label. Then press ⏏ to select the input. 2 Press ▲ or ▼ to highlight one of the displayed labels. Then press ⏏ to select the label. <p>You can select from the following labels for each input:</p> <p>Video 1-7 VHS, DVD, Receiver, Satellite, Cable Box, 8mm, DTV, Game, LD, Web, Beta, HD, PVR, Skip</p> <p> If you select Skip, your TV skips this input when you press the TV/VIDEO button.</p>
Tilt Correction	<p>Allows you to correct any tilt of the picture.</p> <p>Press ◀ or ▶ to choose a correction between +7 and -7 and press ⏏.</p>
Vertical Correction	<p>Allows you to make a vertical correction to the picture.</p> <p>Press ▲ or ▼ to choose a correction between +5 and -5 and press ⏏.</p>
Language	<p>Select to display all on-screen Menus in your language of choice.</p>
Menu Color	<p>Enables you to select a specific color for the on-screen menus.</p>

 The **Skip** label is useful for inputs that do not have equipment connected to them.

 Normally, **Tilt Correction** and **Vertical Correction** only need to be adjusted the first time you turn on the unit and after the unit is moved to a new location.

Programming Caption Vision

If you selected the **Program** option under **Caption Vision** (see page 89), you can change the following settings:

Basic	Allows you to select basic analog (EIA-608) closed caption options.
CC1, CC2, CC3, CC4	Displays a printed version of the dialog or sound effects of a program. (Should be set to CC1 for most programs.)
Text1, Text2, Text3, Text4	Displays network/station information presented using either half or the whole screen (if available). For closed captioning, set to CC1 .
Advanced	Allows you to select advanced digital (EIA-708) closed caption options. Select from the available options.
Digital CC	Allows you to set digital closed captioning to Basic (digital EIA-608) or Advanced (digital EIA-708).
Advanced Settings	Allows you to make additional settings for digital (EIA-708) closed caption options.
As Broadcast	
Small Text	
Large Text	
Custom ...	Allows you to customize the following settings:
Character Size	Small, Standard, Large
Character Style	Style 1-7
Character Color	Color 1-8
Edge Color	Color 1-8
Edge Type	None, Raised, Depressed, Outline, Left shadow, Right shadow
Background Color	None, Color 1-8
Window Color	None, Color 1-8
 Color options can also be set to Solid or Translucent.	

Using the Applications Menu



To access the Applications Menu, follow these steps:

1. Display Menu



2. Highlight

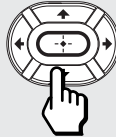

3. Press to select





To change settings, press **↑ ↓ ← →**.
Press **○** to confirm the selection.

To exit the Menu, press **MENU**.





Selecting Applications Options



 You can also use the **MEMORY STICK** buttons on the remote control or front panel.



 You can also change the **SLEEP** options using the **SLEEP** button on the remote control.

















The Applications Menu includes the following options:

Option	Description
Memory Stick	Displays the Memory Stick Viewer. For details, see page 61.
Clock/Timers	Select to set the clock, set the Sleep timer, and to program your TV to turn on and off at two scheduled viewing times.
Sleep	Set the time in minutes (15min, 30min, 45min, 60min, 90min, or Off) that you want the TV to remain on before shutting off automatically.
Timer 1 Timer 2	You can use the Timers to program the TV to turn on and off and tune to a specific channel at two scheduled viewing times.

 To go directly to programming Timer 1 or 2, press  instead of pressing .

 To return to the Timer Menu after programming one of the Timers, press  when the highlight is in the channel number field.

 To return to the Timer Menu after setting the **Current Time**, press  when the highlight is in the minute field.

Option	Description
	Timer 1 and Timer 2 are not available to be set until you set the Current Time .
1	Press  or  to highlight Timer 1 or Timer 2 . To set the timer, press  .
2	Press  or  to highlight one of the following options, then press  .
Program	Select to set the Timer by day, time, duration, and channel.
Off	Select to turn off the Timer. (Your previous settings are saved.)
3	If you selected Program in step 2, Press  and  to set the day(s), hour, minute, duration, and channel number. Press  or  to confirm each setting and move to the next setting. Press  to go back to the previous setting.
4	Press MENU to exit the Menu. An LED on the front panel will light, indicating the timer has been set.
<hr/>	
	Current Time
1	Press  to select Current Time .
2	Press  and  to set the current time (day, hour, and minute). Press  or  to confirm each setting and move to the next setting. Press  to go back to the previous setting.
3	Press MENU to exit the Menu.
<hr/>	
Diagnostics	Displays the strength of the terrestrial digital broadcast signal, to help you adjust your antenna to optimize signal reception.
<hr/>	
CableCARD	This list of selectable CableCARD options will vary, depending on your cable service provider.

Other Information

Overview

This chapter includes the following topics:

<i>Topic</i>	<i>Page</i>
Glossary	96
Contacting Sony	97
Troubleshooting	97
Specifications	103
Optional Accessories	104
Index	105

Glossary

analog signal

A signaling method that uses continuous changes in the amplitude or frequency of an electronic transmission to convey information.

aspect ratio

Refers to the ratio between the width and height of the screen. 32/36 models have a 4:3 aspect ratio; 30/34 models have a 16:9 (widescreen) aspect ratio.

4:3 aspect ratio



16:9 aspect ratio



component video



Component video is sent through three cables: two color shade (chrominance) signals and one brightness (luminance) signal. Component video achieves greater color accuracy than composite video or S VIDEO by splitting chrominance into two separate portions.

composite video



Composite video is sent through a single cable. Composite video combines the color shade (chrominance) and brightness (luminance) information into one video signal.

degauss

A process that demagnetizes the metal components in the TV monitor, which eliminates image distortion that can result from magnetic charges acquired by the TV's components. Your TV degausses automatically when it is turned on.

digital television (DTV)

A new technology for transmitting and receiving broadcast television signals. DTV provides clearer resolution and improved sound quality over analog television.

HDMI (High-Definition Multimedia Interface)

Provides an uncompressed, all-digital audio/video interface between this TV and any HDMI-equipped audio/video component, such as a set-top box, DVD player, and A/V receiver. HDMI supports enhanced, or high-definition video, plus two-channel digital audio.

National Television System Committee (NTSC)

A unit of the Federal Communications Commission, Washington, DC, that establishes television standards in the United States, such as NTSC Color, the standard used in this TV.

RF

Radio Frequency. That part of the frequency spectrum that is used to transmit TV and radio signals.

S VIDEO



S VIDEO requires a single cable, which carries the brightness (luminance) and color (chrominance) signals of the picture separately. S VIDEO provides better resolution than composite video, which carries the signals together.

VHF/UHF

VHF (Very High Frequency) is the part of the frequency spectrum from 30 to 300 megahertz. UHF (Ultra High Frequency) is the part of the frequency spectrum from 300 to 3,000 megahertz.

480i (SD)

Provides 480 lines of resolution. Displays images using interlaced scanning, which first transmits all the odd lines on the TV screen and then the even lines.

480p (SD)

Provides 480 lines of resolution. Displays images using progressive scanning, which transmits each line from top to bottom.

720p (HD)

Provides 720 lines of resolution. Displays images using progressive scanning, which transmits each line from top to bottom.

1080i (HD)

Provides 1080 lines of resolution. Displays images using interlaced scanning, which first transmits all the odd lines on the TV screen and then the even lines. 1080i is one of the formats used by HDTV (High Definition TV).

Contacting Sony

If, after reading these operating instructions, you have additional questions related to the use of your Sony television, please call our Customer Information Services Center at 1-800-222-SONY (7669) (US residents only) or (416) 499-SONY (7669) (Canadian residents only).

Before calling Sony customer support, please write down the model and serial numbers of your TV. You'll find this information on the front cover of this manual.

Troubleshooting

Remote Control

Problem	Possible Remedies
Remote control does not operate	<ul style="list-style-type: none"> ❑ The batteries could be weak. Replace the batteries. ❑ Check the orientation of the batteries. ❑ Press the TV FUNCTION button. You may have inadvertently pressed the SAT/CABLE FUNCTION button, which changes the remote control to SAT or CABLE mode. ❑ Make sure the TV's power cord is connected securely to the wall outlet. ❑ Locate the TV at least 3-4 feet away from fluorescent lights.
Cannot change channels with the remote control	<ul style="list-style-type: none"> ❑ If you are using the TV to change channels, first press the TV FUNCTION button. ❑ If you are using another device to change channels, be sure you have not inadvertently switched your TV from the channel 3 or 4 setting. Use the Channel Fix option to "fix" the channel based on the hookup you used (see page 84). ❑ If you are using another device to change channels, be sure to press the FUNCTION button for that device. For example, if you are using your cable box to change channels, be sure to press the SAT/CABLE FUNCTION button.
Remote control does not operate non-Sony video equipment	<ul style="list-style-type: none"> ❑ If you replaced the batteries to the remote recently, the code numbers for the video equipment may need to be reset. ❑ There may be more than one code for the equipment that you are attempting to operate. ❑ There is a possibility that some non-Sony equipment cannot be operated by your Sony TV remote. You may need to use the equipment's original remote control.

Channels





<i>Problem</i>	<i>Possible Remedies</i>
Cannot receive upper channels (UHF) when using an antenna	<ul style="list-style-type: none"> ❑ Use Auto Program in the Channel Menu to add receivable channels that are not presently in the TV's memory (see page 84).
TV is fixed to one channel	<ul style="list-style-type: none"> ❑ Use Auto Program in the Channel Menu to add receivable channels that are not presently in the TV's memory (see page 84). ❑ Check your Channel Fix settings (see page 84).
Cannot receive any channels when using cable TV	<ul style="list-style-type: none"> ❑ Use Auto Program in the Channel Menu to add receivable channels that are not presently in the TV's memory (see page 84).
Cannot receive or select channels	<ul style="list-style-type: none"> ❑ Use Auto Program in the Channel Menu to add receivable TV channels that are not presently in TV memory (see page 84).
Some digital cable channels are not being displayed	<ul style="list-style-type: none"> ❑ Certain cable TV companies have limitations on the broadcast of digital cable channels. Check with your cable TV company for more information. ❑ Check with your cable TV company if the channels are scrambled or encrypted. You will need a CableCARD or a separate set-top box to view those channels. ❑ Some optional digital cable broadcast formats may not be supported. If your cable TV company is broadcasting digital signals in unsupported broadcast formats, you will need a separate set-top box provided by your cable TV company to view those channels. ❑ The digital cable channel may be set to Hide in the Channel Menu (see page 85). ❑ Use the Digital Channels feature to search for new digital channels (see page 84).

CableCARD

<i>Problem</i>	<i>Possible Remedies</i>
Problems using CableCARD or CableCARD services	<ul style="list-style-type: none"> ❑ Check that the CableCARD is inserted properly (see pages 41-42). ❑ The CableCARD must be activated by your local cable TV provider before you can receive digital cable TV services. See the activation instructions on pages 41-42. ❑ Check the Diagnostics and CableCARD menu options (see page 93). (This can be useful in providing information to an authorized technician or repair person.) ❑ Contact your cable TV company.
Cannot record CableCARD signals	<ul style="list-style-type: none"> ❑ Digital cable is a new technology and its signals cannot be recorded in traditional ways (for example, by using a VCR). If you are interested in recording these signals, you will need a digital cable ready recording device. Consult your retailer for more information.

Memory Stick

Problem	Possible Remedies
Image does not display/ Cannot see all files	<ul style="list-style-type: none"> <input type="checkbox"/> Make sure the image file is a JPEG (.jpg, .jpeg) file or an MPEG1 (.mpg, .mpeg) file. <input type="checkbox"/> Make sure the Memory Stick is inserted properly (see page 64). <input type="checkbox"/> Check the Filter option setting (see page 74). <input type="checkbox"/> Check the Select Contents setting (see page 74) and ensure that files are either in DCF directories if Digital Camera Folders is selected (see page 74), or in the currently selected folder if Select a Folder is selected (see page 74). <input type="checkbox"/> The maximum number of files the Memory Stick Viewer can display is 2,000 files total, including all JPEG, MPEG1, and MP3 files. <input type="checkbox"/> If you are using a Memory Stick with the Memory Select function, try changing the position of the A/B select switch.
JPEG image displays undesirable motion or flicker in full screen	<ul style="list-style-type: none"> <input type="checkbox"/> JPEGs captured using a digital video camera may appear to display motion in full screen. This is a result of the way digital video cameras record still images, and is not a result of a malfunction with the TV.
Rotation not saved after Memory Stick is ejected or Memory Stick Viewer is closed	<ul style="list-style-type: none"> <input type="checkbox"/> The Memory Stick might be locked. Unlock the Memory Stick and try rotating the image again. <input type="checkbox"/> The file might not have information (EXIF data) that is usually generated when a digital camera records a photo. In this case, it is not possible to save the rotation. <input type="checkbox"/> There might be insufficient space on the Memory Stick to save the rotated file. Try deleting one or more files and rotating the image again.
Cannot Rotate, Zoom, Pan or Print Mark MPEG files	<ul style="list-style-type: none"> <input type="checkbox"/> These functions are available only for JPEG files.
Cannot show (or hide) file information in full screen or Slide Show	<ul style="list-style-type: none"> <input type="checkbox"/> Set the File/Information option to On or Off (see page 73).
Cannot set print quantity	<ul style="list-style-type: none"> <input type="checkbox"/> The Memory Stick might be locked. Unlock the Memory Stick and try setting the print quantity again.
Cannot see Menu	<ul style="list-style-type: none"> <input type="checkbox"/> Press ▲ to display the Menu again.
Cannot hear audio while using Memory Stick	<ul style="list-style-type: none"> <input type="checkbox"/> Check the TV's volume or Speaker (page 81) settings. <input type="checkbox"/> To hear JPEG voice memo in full screen view, select the Digital Camera Folders option and set the Filter option to Show All. <input type="checkbox"/> Check that the Music option is not set to Off (see page 73).
Not all MP3 files on Memory Stick are included when the Music /Complete List option is selected (page 73)	<ul style="list-style-type: none"> <input type="checkbox"/> The Memory Stick Viewer can display a maximum of 2,000 files total, including all JPEG, MPEG1, and MP3 files. <input type="checkbox"/> Make sure that the file is named with the file extension (.mp3).
Cannot see MP3 list to play music	<ul style="list-style-type: none"> <input type="checkbox"/> MP3 files on your Memory Stick only can be played as background music during a Slide Show (see page 73).
MP3 file does not play back correctly	<ul style="list-style-type: none"> <input type="checkbox"/> The Memory Stick Viewer supports only MP3 files with a fixed data rate of 128 kbps (kilobits per second).
MP3 files on the Memory Stick are not listed	<ul style="list-style-type: none"> <input type="checkbox"/> Only MP3 files that are named with the file extension (.mp3) are displayed in the list.
Music files are playing in wrong order	<ul style="list-style-type: none"> <input type="checkbox"/> MP3 files are played in alphabetical order, according to the folder in which they are stored. If you want to change the playing order, rename your files alphabetically in the order in which you want them to play or create an MP3 playlist (.m3u file) on a PC.

Problem	Possible Remedies
Print Marks (DPOF) set by the Memory Stick Viewer are not recognized by the DPOF-compatible photo printer.	<ul style="list-style-type: none"> ❑ The DPOF Print Mark feature works only on photos containing EXIF data (data stored by the camera) that are located within the digital camera (DCF) folders (see “About DCF File Names” on page 75 for a description).
MPEG1 movie does not play back correctly	<ul style="list-style-type: none"> ❑ Some variations of MPEG1 movies may not be compatible with the Memory Stick Viewer. ❑ MPEG movies recorded in VX Fine mode with Sony digital cameras cannot be played back with the Memory Stick Viewer.
MPEG1 quality is poor when enlarged (page 71)	<ul style="list-style-type: none"> ❑ The quality of the movie when enlarged depends on the resolution of the MPEG1 file. See your camera’s instruction manual for details.
Error message is displayed	<ul style="list-style-type: none"> ❑ No Memory Stick There is no Memory Stick in the slot. ❑ Memory Stick Locked The lock mechanism on the Memory Stick is engaged. ❑ Memory Stick Error The Memory Stick in the slot might be damaged; try a different Memory Stick. ❑ Format Error The Memory Stick may have been formatted using a PC or other device that is not compatible with cameras.
Error icon is displayed	<ul style="list-style-type: none">  The file is not a valid MPEG1 or JPEG format, or it is a progressive JPEG (which is not supported).  The thumbnail is not DCF-compatible.  The file is a JPEG or an MPEG1, but the thumbnail is unreadable.  The file is unreadable.

Audio

Problem	Possible Remedies
Good picture, no sound	<ul style="list-style-type: none"> ❑ Press MUTING so that the word Muting disappears from the screen (see page 47). ❑ Make sure the Speaker option is set to On in the Audio Menu (see page 81). ❑ Make sure the MTS option is set to Stereo or Mono (see page 80).
Cannot gain enough volume when using a cable box	<ul style="list-style-type: none"> ❑ Increase the volume of the cable box using the cable box’s remote control. Then press TV FUNCTION and adjust the TV’s volume.
Sound seems weak or insufficient	<ul style="list-style-type: none"> ❑ The TV’s audio might be set to Auto SAP or Mono, when it might be better set to Stereo. In the Audio Menu (see page 80), set the MTS setting to Stereo. If already set to Stereo, switch to Mono (which may reduce background noise during weak stereo broadcasts).
Cannot raise the volume on external audio speakers	<ul style="list-style-type: none"> ❑ If the Speaker option is set to Off and the Audio Out option is set to Fixed (in order to output the sound to your audio system) use your audio receiver to adjust the sound (see page 80). Or, to use the TV remote control, set the Audio Out option to Variable. ❑ To turn on the TV speakers, set the Speaker option to On (see page 80).

Video

Problem	Possible Remedies
No picture (screen not lit), no sound	<ul style="list-style-type: none"> ❑ If your TV does not turn on, and a red light keeps flashing, your TV may need service. Call your local Sony Service Center. ❑ Make sure the power cord is plugged in. ❑ Press the POWER button on the front of the TV. ❑ Press the TV/VIDEO button to cycle through the connected video sources. ❑ Try another channel; it could be station trouble.
Dark, poor or no picture (screen lit), good sound	<ul style="list-style-type: none"> ❑ Adjust the Picture option in the Video Menu (see page 78). ❑ Adjust the Brightness option in the Video Menu (see page 78). ❑ Check the antenna/cable connections.
No color	<ul style="list-style-type: none"> ❑ Adjust the Color option in the Video Menu (see page 78).
Only snow and noise appear on the screen	<ul style="list-style-type: none"> ❑ Check the antenna/cable connections. ❑ Try another channel; it could be station trouble. ❑ Press ANT to change the input mode (see page 47).
Dotted lines or stripes	<ul style="list-style-type: none"> ❑ Adjust the antenna. ❑ Move the TV away from noise sources such as cars, neon signs, or hair-dryers.
Double images or ghosts	<ul style="list-style-type: none"> ❑ Using a highly directional outdoor antenna or a cable may solve the problem.
“Black box” on screen	<ul style="list-style-type: none"> ❑ You have selected a text option in the Setup Menu and no text is available. (See page 89 to reset Setup selections.) To turn off this feature, set the Caption Vision option to Off. If you were trying to select closed captioning, select CC1 instead of TEXT 1-4.
Bars appear at the top and bottom of the screen	<ul style="list-style-type: none"> ❑ Some wide-screen programs are filmed in aspect ratios that are greater than 16:9, such as 2.35:1. (This is especially common with theatrical releases). Your TV will show these programs with bars at the top and bottom of the screen. For more details, check the documentation that came with your DVD (or contact your program provider).

General

Problem	Possible Remedies
How to reset TV to factory settings	<ul style="list-style-type: none"> ❑ Turn on the TV. While holding down the RESET button on the remote control, press the POWER button on the TV. (The TV will turn itself off, then back on again.) Release the RESET button.
How to restore Video settings to factory settings	<ul style="list-style-type: none"> ❑ Press the RESET button on the remote control while in the Video Menu (see page 78).
How to restore Audio settings to factory settings	<ul style="list-style-type: none"> ❑ Press the RESET button on the remote control while in the Audio Menu (see page 80).
Cannot cycle through the other video equipment connected to the TV	<ul style="list-style-type: none"> ❑ Be sure the Video Label option is not set to Skip (see page 90).
Cannot operate Menu	<ul style="list-style-type: none"> ❑ If a Menu option appears in gray, this indicates that the TV is in a state in which the Menu option is not available.
Lost password	<ul style="list-style-type: none"> ❑ In the password screen (see page 86), enter the following master password: 4357. The master password clears your previous password; it cannot be used to temporarily unblock channels.

<i>Problem</i>	<i>Possible Remedies</i>
TV makes "popping" sound when turned on	❑ This is a normal sound that results from the TV automatically degaussing each time it is turned on.
TIMER/STAND BY LED on front panel is lit (XS955 models only)	❑ This LED blinks when the TV is turned on, then shuts off when the picture is displayed. If the LED blinks for more than a minute, this may indicate the TV needs service.
POWER LED on front panel is lit (XS945 models only)	
Digital cable box does not work	❑ If you are connecting a VCR and digital cable box using a splitter, as described on page 24, you must use a special bi-directional splitter that is designed to work with your digital cable box. Contact your cable TV company for details.
Cannot record digital channels to VCR	❑ Only analog channels can be recorded to your VCR.

Specifications

Picture Tube	FD Trinitron® tube	
Antenna	75 ohm external terminal for VHF/UHF	
Television System	NTSC	American TV Standard
	ATSC (8VSB terrestrial)	ATSC compliant 8VSB
	QAM on cable	ANSI/SCTE 07 2000
Channel Coverage	Terrestrial (analog)	2-69
	Cable TV (analog)	1-125
	Terrestrial (digital)	2-69
	Cable TV (digital)	1-135
Power Requirements	120V, 60 Hz	
Inputs/Outputs		
HDMI IN	Video	1080i, 720p, 480p, 480i
	Audio	Two channel linear PCM 32, 44.1 and 48 kHz, 16, 20 and 24 bit
Video (IN)	4 total (1 on front panel)	1 Vp-p, 75 ohms unbalanced, sync negative
S Video (IN)	3 total (1 on front panel)	Y: 1 Vp-p, 75 ohms unbalanced, sync negative C: 0.286 Vp-p (Burst signal), 75 ohms
Audio (IN)	7 total (1 on front panel)	500 mVrms (100% modulation) Impedance: 47 kilohm
Component Video Input	2 (Y, P _B , P _R)	Y: 1.0 Vp-p, 75 ohms unbalanced, sync negative; P _B : 0.7 Vp-p, 75 ohms P _R : 0.7 Vp-p, 75 ohms
CONTROL S (IN/OUT)	1	
Variable/Fixed Audio (OUT)	1	More than 408 mVrms at the maximum volume setting (Variable)
		More than 408 mVrms (Fixed) Impedance (output): 2 kilohms
Digital Audio Optical Output PCM/Dolby Digital	1	Optical Rectangular
CableCARD Slot	PCMCIA Type I/II	
Supplied Accessories	Remote Control	RM-Y199
	AA (R6) Batteries	2 supplied for remote control
Visible Screen Size (picture measured diagonally)	KD-30XS955	30 in (762 mm)
	KD-32XS945	32 in (812.8 mm)
	KD-34XS955	34 in (863.6 mm)
	KD-36XS955	36 in (914.4 mm)
Actual CRT Size (picture measured diagonally)	KD-30XS955	32 in (812.8 mm)
	KD-32XS945	34 in (863.6 mm)
	KD-34XS955	36 in (914.4 mm)
	KD-36XS955	38 in (965.2 mm)
Speaker Output	7.5 W x 2 + 15 W subwoofer	
Dimensions (W x H x D)	KD-30XS955	898 x 604 x 564.5 mm (35 3/8 x 23 3/4 x 22 1/4 in)
	KD-32XS945	898 x 698 x 598 mm (35 3/8 x 27 1/2 x 23 1/2 in)
	KD-34XS955	994 x 654 x 604 mm (39 1/8 x 25 3/4 x 23 3/4 in)
	KD-36XS955	994 x 776.5 x 634 mm (39 1/8 x 30 5/8 x 25 in)
Mass	KD-30XS955	67 Kg (148 lbs)
	KD-32XS945	81 Kg (178.5 lbs)
	KD-34XS955	93 Kg (205 lbs)
	KD-36XS955	108.2 Kg (238.5 lbs)

Power Consumption	KD-30XS955	In Use: 220 W In Standby: 3 W In CableCARD Standby: 20 W
	KD-32XS945	In Use: 240 W In Standby: 3 W In CableCARD Standby: 20 W
	KD-34XS955	In Use: 250 W In Standby: 3 W In CableCARD Standby: 20 W
	KD-36XS955	In Use: 270 W In Standby: 3 W In CableCARD Standby: 20 W

Design and specifications are subject to change without notice.

Optional Accessories

<i>Accessory</i>	<i>Description</i>	<i>Model Number</i>
Cables	Audio/Video	VMC-810/820/830 HG
	Audio	RKC-515HG
	Component Video	VMC-10/30 HG
TV Stands	KD-30XS955	SU-30HX1
	KD-32XS945	SU-32HX1
	KD-34XS955	SU-34HX1
	KD-36XS955	SU-36HX1

Index

0-9 buttons 48, 52
4:3 Default settings 82, 83

A

Advanced Video 79
Alternate Audio 54
Alternate Video 54
ANT button 52
antenna, connecting 17
aspect ratio 83
Audio Menu 77
Audio Out 81
AUDIO OUT jack 15
audio receiver, connecting 36
Auto Program (channel setup)
43, 84
Auto SAP, MTS setting 80

B

balance, adjusting 80
bass, adjusting 80
batteries, inserting in remote 45
bilingual audio 80
blocking programs. *See ratings.*
brightness, adjusting 78
Built 9

C

cable
connecting 17
with VCR, connecting 23
cable box
connecting with VCR 24
using with TV remote
control 60
CABLE jack, described 15
CableCARD 9, 15, 16, 41
CableCARD slot 15, 41, 42
CableCARD, activating 41
CableCARD, inserting card 41
CableCARD, removing card 42
Caption Vision 89
CATV. *See cable*
CH buttons 12, 13, 48
Channel Fix 84

channel list, setting up 43
Channel Menu 77
Channel Skip/Add 85
CineMotion 10, 47, 79
ClearEdge VM 79
ClearEdge VM Velocity
Modulation 10
clearing, Favorite Channels 58
closed caption modes 77, 89
CODE SET button 47
color, adjusting 78
Component Video Inputs 10
CONTROL S 40
CONTROL S IN/OUT jacks,
described 15
Cool, Color Temperature 78

D

degauss 102
DIGITAL AUDIO OPTICAL jack
15
digital channels, adding 84
Digital Reality Creation 10
DISPLAY button 52
DRC Mode 79
DRC MODE button 47
DRC. *See Digital Reality Creation.*
DVD player
using with TV remote
control 60
with A/V connectors,
connecting 34

E

Effect button 47
ENTER button 48, 52
error messages, Memory Stick
100

F

Fast-forward button 47
Favorite Channels 10
clearing 58
in Channel Menu 84
using 58

features 9
Fixed audio setting 81
Full 56
Full (Screen Mode) 55, 56

G

GUIDE button 48, 53

H

HD Detailer 10
HD/DVD IN
(1080i/720p/480p/480i)
jacks, described 15
High-Definition Multimedia
Interface (HDMI) 10, 37, 38,
96
Horizontal Expand (Screen
Mode) 56, 57
hue, adjusting 78

I

Info Banner 89
Initial Setup 43
interlaced 10, 47, 79, 96

J

JUMP button 47, 52

L

Language, setting 90

M

Memory Stick
button 47
features 61
Index 66
indicator (LED) 12, 13
inserting 64
insertion slot 12, 13
panning photos 70
photo options 69
playing movies 71
precautions 76
removing 65

- rotating photos 70
- slide show options 73
- troubleshooting 99
- viewing photos 68
- zooming photos 70
- Memory Stick button 12, 13
- Memory Stick Viewer 10
- MENU button 12, 13, 48, 52, 58, 77
- Menus
 - Audio 77
 - Channel 77
 - Parent 77, 86
 - Setup 89
 - Video 77
- MONITOR OUT 15
- Mono, MTS setting 80
- Movie mode 78
- movies
 - viewing thumbnails 66
- MTS 80
- MUTING button 47, 52

N

- Neutral, Color Temperature 78
- Normal (Screen Mode) 55

O

- off, turning off the TV 12, 13
- on, turning on the TV 12, 13

P

- Parent Menu 77, 86
- parental control, described 10
- password, changing 86
- Pause button 47
- photos
 - viewing thumbnails 66
- PIC MODE button 47
- picture contrast, adjusting 78
- Play button 47
- POWER button 12, 13
- power cord, removing from holder 11
- powering on/off, the TV 12, 13
- presetting channels 84
- Pro (Video) mode 78
- Program Guide 53
- program guide 53
- progressive 10, 47, 79, 96

R

- ratings, setting 86–88
- ratings, viewing blocked programs 87, 88
- Record buttons 47
- remote control
 - inserting batteries 45
 - programming 49–50
- removing, Favorite Channels 58
- RESET button 47, 58
- resetting
 - Audio options 81
 - Video options 79
- Rewind button 47

S

- S VIDEO jack, described 12, 13, 15
- SAT/CABLE FUNCTION button 47
- SAT/CABLE POWER button 47
- satellite receiver, using with TV remote control 59
- Screen Mode 55, 57, 82, 83
- SCREEN MODE button 55
- Setup Menu 89
- sharpness, adjusting 78
- Simulated, Effect 80
- SLEEP button 47
- speakers
 - turning on/off 81
 - using external speakers 81
- specifications 104
- Standard mode 78
- Steady Sound, described 10
- Steady Sound, setting 80
- Stereo, MTS setting 80
- Stop button 47
- Super Fine Pitch 10
- surround sound 80
- SYSTEM OFF button 47

T

- Tilt Correction 43, 90
- tilt, correcting 43, 90
- transport buttons 47
- treble, adjusting 80
- troubleshooting 97–102
- TruSurround 80
- TruSurround, Effect 80
- turning on/off the TV 12, 13
- TV FUNCTION button 47, 52

- TV POWER button 47, 52
- TV/VIDEO button 48, 52

V

- Variable audio setting 81
- VCR
 - using with TV remote control 59
 - with cable box, connecting 24
 - with cable, connecting 23
 - with satellite receiver, connecting 30
- Vertical Center 82
- Vertical Correction 43, 90
- Vertical Expand (Screen Mode) 56, 57
- Vertical Size, adjusting 82
- VHF/UHF jack, described 15
- VIDEO (L/R)/AUDIO jacks, described 15
- Video Menu 77
- Video modes, selecting 78
- Vivid mode 78
- VOL buttons 12, 13, 47, 52

W

- Warm, Color Temperature 78
- Wega, described 9
- Wide Zoom 55
- widescreen 83

Z

- Zoom (Screen Mode) 55, 56

Free Manuals Download Website

<http://myh66.com>

<http://usermanuals.us>

<http://www.somanuals.com>

<http://www.4manuals.cc>

<http://www.manual-lib.com>

<http://www.404manual.com>

<http://www.luxmanual.com>

<http://aubethermostatmanual.com>

Golf course search by state

<http://golfingnear.com>

Email search by domain

<http://emailbydomain.com>

Auto manuals search

<http://auto.somanuals.com>

TV manuals search

<http://tv.somanuals.com>