

Trinitron[®] ***Color TV***

Operating Instructions

KV-13M42
KV-20M42
KV-20S90

L

WARNING

To reduce the risk of fire or electric shock, do not expose the TV to rain or moisture.



This symbol is intended to alert the user to the presence of uninsulated “dangerous voltage” within the product’s enclosure that may be of sufficient magnitude to constitute a risk of electric shock to persons.



This symbol is intended to alert the user to the presence of important operating and maintenance (servicing) instructions in the literature accompanying the appliance.

Note to the CATV Installer

This reminder is provided to call the CATV system installer’s attention to Article 820-40 of the NEC that provides guidelines for proper grounding and, in particular, specifies that the cable ground shall be connected to the grounding system of the building as close to the point of cable entry as practical.

SAFETY PRECAUTIONS

- Operate the TV only on 120 V AC.
- One blade of the power plug is wider than the other for safety purposes and will fit into the power outlet only one way. If you are unable to insert the plug fully into the outlet, contact your dealer.
- If any liquid or solid object falls into the TV, unplug it and have it checked by qualified personnel before operating it further.

CAUTION

When using TV games, computers, and similar products with your TV, keep the brightness and contrast functions at low settings. If a fixed (non-moving) pattern is left on the screen for long periods of time at a high brightness or contrast setting, the image can be permanently imprinted onto the screen. Continuously watching the same channel can cause the imprint of station logos onto the TV screen. These types of imprints are not covered by your warranty because they are the results of misuse.



To reduce the risk of electric shock, do not use this polarized plug with an extension cord, receptacle, or other outlet unless the blades can be fully inserted to prevent blade exposure.



You are cautioned that any changes or modifications not expressly approved in this manual could void your authority to operate this equipment.

NOTIFICATION

This equipment has been tested and found to comply with the limits for a Class B digital device pursuant to Part 15 of the FCC Rules. These limits are designed to provide reasonable protection against harmful interference in a residential installation. This equipment generates, uses, and can radiate radio frequency energy and, if not installed and used in accordance with the instructions, may cause harmful interference with radio communications. However, there is no guarantee that interference will not occur in a particular installation. If this equipment does cause harmful interference to radio or television reception, which can be determined by turning the equipment off and on, the user is encouraged to try to correct the interference by one or more of the following measures:

- Reorient or relocate the receiving antennas.
- Increase the separation between the equipment and receiver.
- Connect the equipment into an outlet on a circuit different from that to which the receiver is connected.
- Consult the dealer or an experienced radio/TV technician for help.

Protecting the TV

- To prevent internal heat build-up, do not block the ventilation openings.
- Do not install the TV in a hot or humid place, or in a place subject to excessive dust or mechanical vibration.

Note on Caption Vision

This television receiver provides display of television closed captioning in accordance with § 15.119 of the FCC rules.

Use of this television for other than private viewing of programs broadcast on UHF or VHF or transmitted by cable companies for the use of the general public may require authorization from the broadcaster-cable company and/or program owner.

Owner's Record

The model and serial numbers are located on the front cover of this manual and the rear of your TV.

Trademarks and Copyrights

ENERGY STAR® is a registered mark.



As an ENERGY STAR® Partner, Sony has determined that this product or product model meets the ENERGY STAR® guidelines for energy efficiency.

Important Safeguards

For your protection, please read these instructions completely, and keep this manual for future reference. Carefully observe and comply with all warnings, cautions and instructions placed on the set, or described in the operating instructions or service manual.

WARNING

To guard against injury, the following basic safety precautions should be observed in the installation, use, and servicing of the set.

Use

Power Sources

This set should be operated only from the type of power source indicated on the serial/model plate. If you are not sure of the type of electrical power supplied to your home, consult your dealer or local power company. For those sets designed to operate from battery power, refer to the operating instructions.



Grounding or Polarization

This set is equipped with a polarized AC power cord plug (a plug having one blade wider than the other), or with a three-wire grounding type plug (a plug having a third pin for grounding).

Follow the instructions below:

For the set with a polarized AC power cord plug

This plug will fit into the power outlet only one way. This is a safety feature. If you are unable to insert the plug fully into the outlet, try reversing the plug. If the plug should still fail to fit, contact your electrician to have a suitable outlet installed. Do not defeat the safety purpose of the polarized plug by forcing it in.

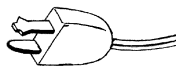

Alternate Warning For the set with a three-wire grounding type AC plug

This plug will only fit into a grounding-type power outlet. This is a safety feature. If you are unable to insert the plug into the outlet, contact your electrician to have a suitable outlet installed. Do not defeat the safety purpose of the grounding plug.

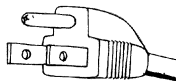

Overloading

Do not overload wall outlets, extension cords or convenience receptacles beyond their capacity, since this can result in fire or electric shock. Always turn the set off when it is not to be used. When the set is left unattended and unused for long periods of time, unplug it from the wall outlet as a precaution against the possibility of an internal malfunction that could create a fire hazard.

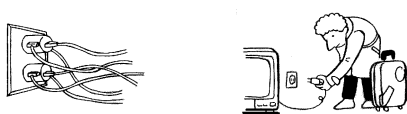

Object and Liquid Entry

Never push objects of any kind into the set through the cabinet slots as they may touch dangerous voltage points or short out parts that could result in a fire or electric shock. Never spill liquid of any kind on the set.



Attachments

Do not use attachments not recommended by the manufacturer, as they may cause hazards.

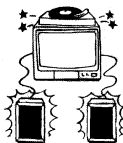

Cleaning

Unplug the set from the wall outlet before cleaning or polishing it. Do not use liquid cleaners or aerosol cleaners. Use a cloth lightly dampened with water for cleaning the exterior of the set.



If a snapping or popping sound from a TV set is continuous or frequent while the TV is operating, unplug the TV and consult your dealer or service technician. It is normal for some TV sets to make occasional snapping or popping sounds, particularly when being turned on or off.



Installation

Water and Moisture

Do not use power-line operated sets near water — for example, near a bathtub, washbowl, kitchen sink, or laundry tub, in a wet basement, or near a swimming pool, etc.



Accessories

Do not place the set on an unstable cart, stand, tripod, bracket, table, or shelf. The set may fall, causing serious injury to a child or an adult, and serious damage to the set. Use only a cart or stand recommended by the manufacturer for the specific model of TV. Any mounting of the product should follow the manufacturer's instructions, and should use a mounting accessory recommended by the manufacturer. An appliance and cart combination should be moved with care. Quick stops, excessive force, and uneven surfaces may cause the appliance and cart combination to overturn.



Ventilation

The slots and openings in the cabinet and in the back or bottom are provided for necessary ventilation. To ensure reliable operation of the set, and to protect it from overheating, these slots and openings must never be blocked or covered.

- **Never cover the slots and openings with a cloth or other materials.**



- **Never block the slots and openings by placing the set on a bed, sofa, rug or other similar surface.**

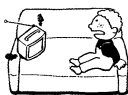

- **Never place the set in a confined space, such as a bookcase, or built-in cabinet, unless proper ventilation is provided.**



- **Do not place the set near or over a radiator or heat register, or where it is exposed to direct sunlight.**



Power-Cord Protection

Do not allow anything to rest on or roll over the power cord, and do not place the set where the power cord is subject to wear or abuse.



Grounding or Polarization

This set may be equipped with a polarized alternating current line plug (a plug having one blade wider than other). This plug will fit into the power outlet only one way. This is a safety feature. If you are unable to insert the plug fully into the outlet, try reversing the plug. If the plug should still fail to fit, contact your electrician to replace your obsolete outlet. Do not defeat the safety purpose of the polarized plug.

Antennas

Outdoor Antenna Grounding

If an outdoor antenna is installed, follow the precautions below. An outdoor antenna system should not be located in the vicinity of overhead power lines or other electric light or power circuits, or where it can come in contact with such power lines or circuits.

WHEN INSTALLING AN OUTDOOR ANTENNA SYSTEM, EXTREME CARE SHOULD BE TAKEN TO KEEP FROM CONTACTING SUCH POWER LINES OR CIRCUITS AS CONTACT WITH THEM IS ALMOST INVARIABLY FATAL.

Be sure the antenna system is grounded so as to provide some protection against voltage surges and built-up static charges. Section 810 of the National Electrical Code (NEC) in USA and Section 54 of the Canadian Electrical Code in Canada provides information with respect to proper grounding of the mast and supporting structure, grounding of the lead-in wire to an antenna discharge unit, size of grounding conductors, location of antenna discharge unit, connection to grounding electrodes, and requirements for the grounding electrode.

Antenna Grounding According to the NEC

Refer to section 54-300 of Canadian Electrical Code for Antenna Grounding.

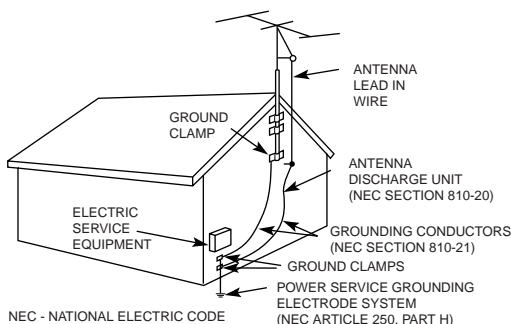

Lightning

For added protection for this television receiver during a lightning storm, or when it is left unattended and unused for long periods of time, unplug it from the wall outlet and disconnect the antenna. This will prevent damage to the receiver due to lightning and power-line surges.

Service

Damage Requiring Service

Unplug the set from the wall outlet and refer servicing to qualified service personnel under the following conditions:

- When the power cord or plug is damaged or frayed.

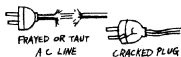

- If liquid has been spilled into the set or objects have fallen into the product.



- If the set has been exposed to rain or water.



- If the set has been subject to excessive shock by being dropped, or the cabinet has been damaged.



- If the set does not operate normally when following the operating instructions. Adjust only those controls that are specified in the operating instructions. Improper adjustment of other controls may result in damage and will often require extensive work by a qualified technician to restore the set to normal operation.



- When the set exhibits a distinct change in performance — this indicates a need for service.

Servicing

Do not attempt to service the set yourself since opening the cabinet may expose you to dangerous voltage or other hazards. Refer all servicing to qualified service personnel.



Replacement Parts

When replacement parts are required, be sure the service technician certifies in writing that he has used replacement parts specified by the manufacturer that have the same characteristics as the original parts. Unauthorized substitutions may result in fire, electric shock, or other hazards.



Safety Check

Upon completion of any service or repairs to the set, ask the service technician to perform routine safety checks (as specified by the manufacturer) to determine that the set is in safe operating condition, and to so certify. When the set reaches the end of its useful life, improper disposal could result in a picture tube implosion. Ask a qualified service technician to dispose of the set.



Contents

Introduction

Trinitron® Color TV Features	1
Batteries for the Remote Control.....	2
About this Manual	2





Connecting Your TV

Basic Connections.....	3
Connecting Additional Equipment	4

Using the Remote Control and Basic Functions

Using the Remote Control.....	9
Setting Up the TV Automatically.....	11
Quick Start to the Menus.....	12

Using the Menus

Using the VIDEO  menu	13
Using the AUDIO  menu	14
Using the TIMER  menu	15
Using the SET UP  menu.....	16
CHANNEL SET UP menu	17
Using PARENTAL CONTROL	18

Other Information

Troubleshooting	25
Specifications.....	27

Index	29
--------------------	----

Introduction

Congratulations on your purchase of the Sony Trinitron® Color TV. Before you begin using this manual, please check the model number located on the rear of your TV or on the front cover of this manual.

The menu and illustrations used in these instructions are for KV-20S90 to show the maximum number of features available. Differences in operation or features will be indicated in the text, for example, "KV-20S90 only."

Trinitron® Color TV Features

Depending on your TV, some of the features you will enjoy include:

- ❑ **PARENTAL CONTROL** — A tool for parents to help monitor what their children watch on TV by establishing rating limits.
- ❑ **FAVORITE CHANNEL** — Instant access to your favorite channels with the touch of a button.
- ❑ **Energy Star** — A recognized symbol of energy efficiency.
- ❑ **Direct MTS** — Allows direct access to changing your Multi-Channel TV Sound: STEREO, SAP (Second Audio Programming), or MONO, with the touch of a button (KV-20S90 only).
- ❑ **ON/OFF TIMER** — Program your TV for scheduled viewing, (except KV-13M42).
- ❑ **Trilingual Menus** — Choose between English, French, or Spanish menus (KV-20S90 only).
- ❑ **Front Panel Controls** — Allows access to the on-screen menus without the use of a remote control.
- ❑ **Front A/V inputs** — A quick connection for video games, camcorders, or stereo/mono equipment (except KV-13M42).

Batteries for the Remote Control

Insert two AA (R6) batteries (supplied) into the remote control using the following illustration as a guide.

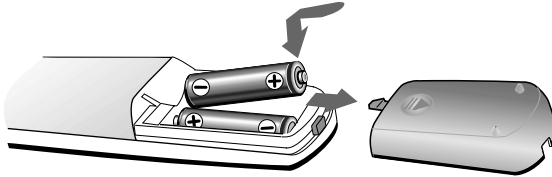

 Under normal conditions, batteries will last up to six months. If the remote control does not operate properly, the batteries might be worn out.

 Remove the batteries to avoid possible damage from battery leakage if you will not be using the remote control for an extended period of time.

About this Manual

This manual provides instructions to help you enjoy your new TV. It shows you how to connect to an antenna or cable, cable box, VCR or camcorder. Once you're connected, follow the instructions to learn how to use the remote control to access the on-screen menus.

Connecting Your TV

Read this chapter before setting up your TV for the first time. This section covers basic connections in addition to any optional equipment you may be connecting.

Basic Connections

TV with indoor or outdoor antenna, or CATV cable

Depending on the cable available in your home, choose one of the connections below:

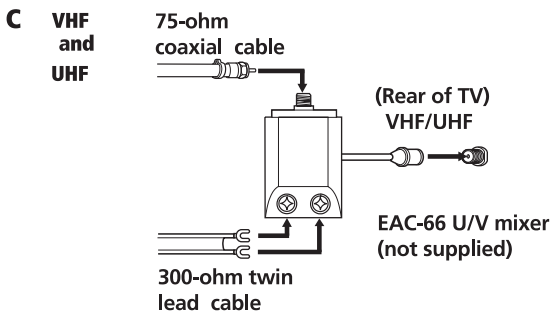
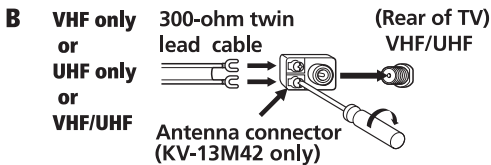
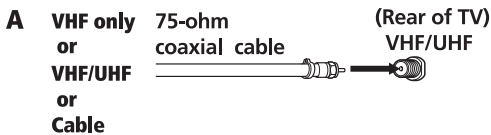

 If you are connecting to an indoor or outdoor antenna, it will be necessary to adjust the orientation of the antenna for best reception.

Connecting Additional Equipment

TV and VCR

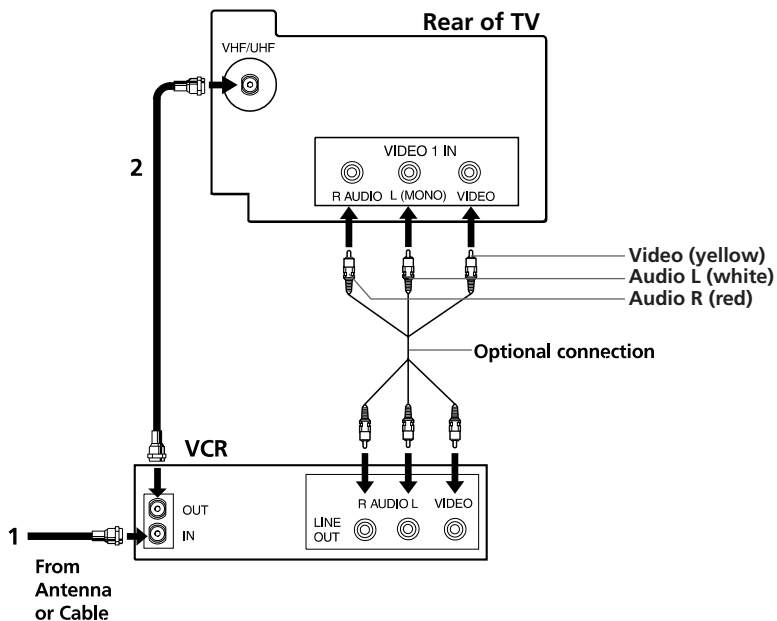

- 1** Connect the coaxial cable from your TV antenna or cable service to the IN jack on your VCR.
- 2** Connect a coaxial cable (not supplied) from the OUT jack on your VCR to the VHF/UHF IN jack on the TV.

To watch video programs from your VCR, tune your TV to channel 3 or 4 (as set on the rear of your VCR).

Optional Connection

If your VCR is equipped with video outputs, you can get better picture quality by connecting Audio/Video cables (not supplied) from AUDIO and VIDEO OUT on your VCR to AUDIO/VIDEO IN on your TV.

You can use the button to switch between the VHF/UHF and VIDEO inputs.

TV and Cable Box

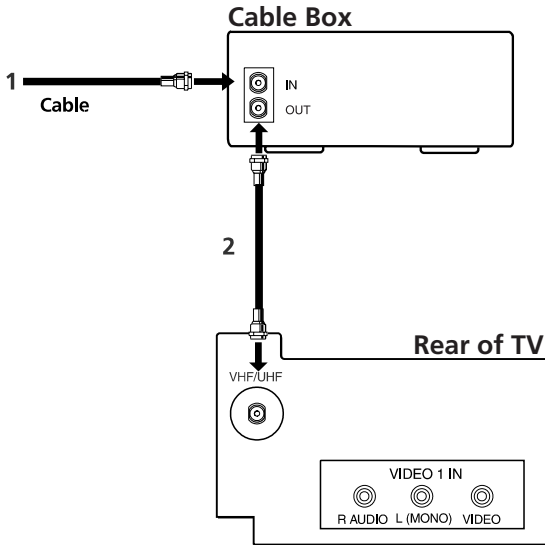

- 1** Connect the coaxial cable from your cable service to the IN jack on your cable box.
- 2** Connect a coaxial cable (not supplied) from the OUT jack on your cable box to the VHF/UHF IN jack on the TV.

 To view channels from your cable box, tune your TV to channel 3 or 4 (as set on the rear panel of your cable box) and use the cable box's remote control to change channels.

 If you will be controlling all channel selection through your cable box, you should consider using the CHANNEL FIX feature by setting your TV to channel 3 or 4, (see page 17).

TV, VCR, and Cable box

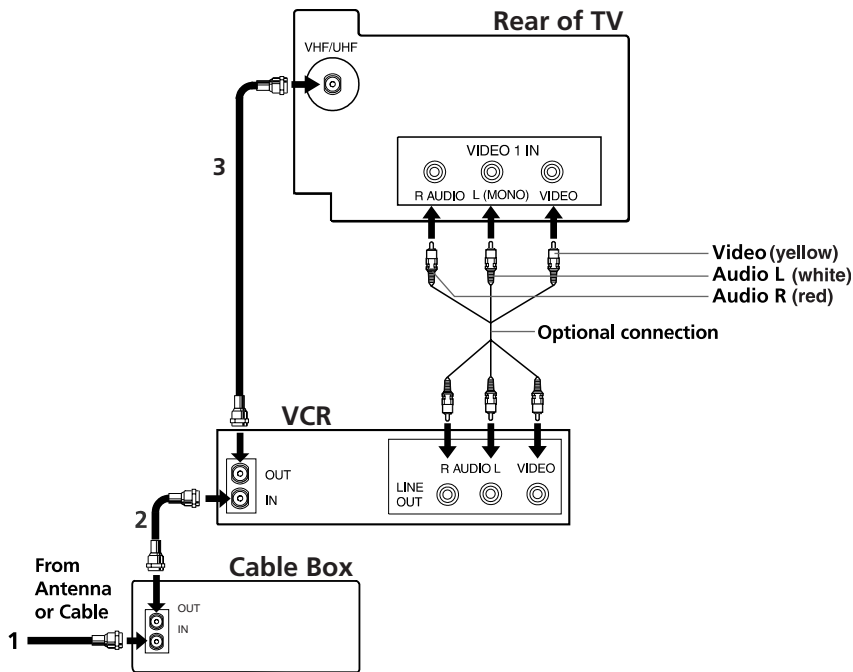



- 1** Connect the coaxial cable from your cable service to the IN jack on your cable box.
- 2** Connect a coaxial cable (not supplied) from the OUT jack on your cable box to the IN jack on your VCR.
- 3** Connect a coaxial cable (not supplied) from OUT on your VCR to VHF/UHF jack on your TV.

 If you will be controlling all channel selection through your cable box, you should consider using the CHANNEL FIX feature by setting your TV to channel 3 or 4, (see page 17).

Optional Connection

If your VCR is equipped with video outputs, you can get better picture quality by connecting Audio/Video cables (not supplied) from AUDIO and VIDEO OUT on your VCR to AUDIO/VIDEO IN on your TV.

 You can use the  button to switch between the VHF/UHF and VIDEO inputs.

Connecting a Camcorder

Using Audio/Video cables (not supplied), connect AUDIO and VIDEO OUT on your camcorder to AUDIO and VIDEO IN on your TV.

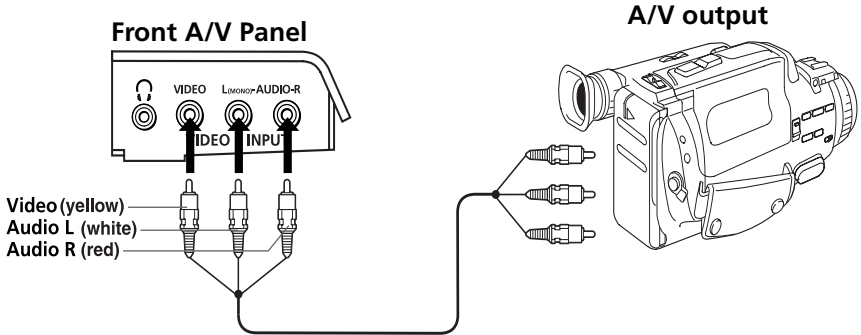

 For model KV-13M42, this connection can be made to the Audio/Video input located on the rear of the TV.

Connecting Headphones



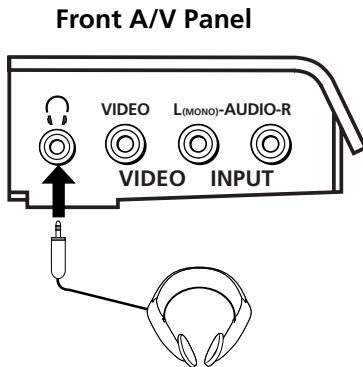





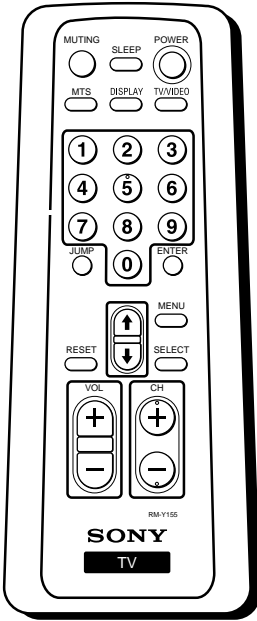



Connect your headphones to the  jack on the front of your TV.



Using the Remote Control and Basic Functions

This section shows you how to use more advanced buttons on the remote control and how to use the on-screen menus..



Button	Description
POWER 	Press when you want to turn the TV on and off.
SLEEP 	Turns the TV off automatically in approximately 30, 60 or 90 minutes. Cancel by pressing until SLEEP OFF appears.
MUTING 	Instantly turns off the sound. Press again or press  to restore sound.
TV/VIDEO 	Cycles through the available video inputs.
DISPLAY 	Press once to show current time, (if set) and channel number. Press again to activate CAPTION VISION settings, if available. To cancel, press again until DISPLAY OFF appears.
MTS 	Cycles through the Multi-Channel TV Sound (MTS) options: STEREO, SAP (Second Audio Programming) and MONO, (KV-20S90 only).
0-9 	Press for channel selection, the channel will change after 2 seconds.
ENTER 	Press after selecting a channel using the 0-9 buttons to immediately activate selection.
JUMP 	Alternates back and forth between the last two channels selected with the 0-9 buttons.
MENU 	Displays the on-screen menu. Press again to exit the menu at any time.
SELECT 	Activates highlighted selections in the on-screen menu.



The remote control shown (RM-Y155) is for KV-20S90. For KV-13M42 and KV-20M42 models, your remote control does not have the MTS button.



Moves the cursor in the on-screen menu.



Press to restore factory settings while in the on-screen menu.



Press when you want to change channels.



Press when you want to adjust the volume.



If you lost your remote control, see page 26

Setting Up the TV Automatically

After you have finished connecting your TV, you will want to run AUTO PROGRAM to set up your channels, (KV-13M42, see page 17 for information on AUTO PROGRAM).

For models KV-20M42, KV-20S90 only

- 1 Press  to turn on the TV, the Initial setup screen appears.

(U.S. models only)

ENGLISH:	[CH+]
ESPAÑOL:	[CH-]
AUTO SET UP:	[VOL+]
DEMO:	[VOL-]
MENU:	[TV/VIDEO]

First please connect
cable/antenna
Press [SET UP] to exit

(Canadian models only)

ENGLISH:	[CH+]
ESPAÑOL:	[CH-]
FRANÇAIS:	[VOL+]
AUTO SET UP:	[VOL-]
DEMO:	[TV/VIDEO]



First please connect
cable/antenna
Press [SET UP] to exit



- 2 Make your language selection, the on-screen menus will change to reflect your choice.
- 3 Follow the on-screen instructions to continue AUTO SET UP or for a DEMO of the menus.

For U.S. models only

- 4 Press  to operate the on-screen menus without the remote control. Follow the on-screen instructions to make adjustments to your TV settings.

To perform Auto Setup again

- Press the  and  buttons on the front panel of the TV and follow steps 2-4.

 To reset your TV to factory settings, turn the TV on. Then, while pressing the  button on the remote control, press POWER on the TV. The TV will turn itself off, then back on, the original settings will be restored.

Quick Start to the Menus

The following settings are available in your on-screen menus:

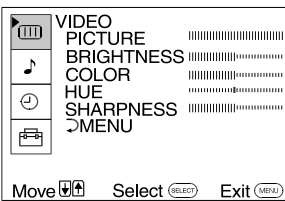
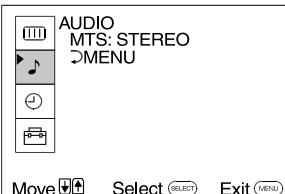
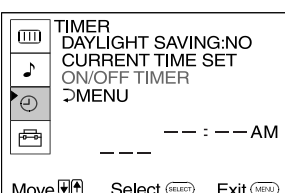
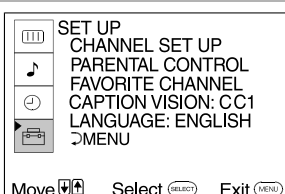
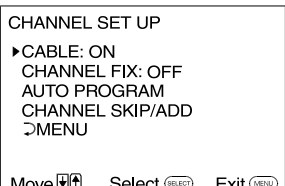



Menu	Allows you to
	<p>Make adjustments to your picture settings.</p>
	<p>Choose from available audio features, such as Multi-Channel Sound, (KV-20S90 only).</p>
	<p>Set the clock on your TV (CURRENT TIME SET) and program scheduled viewing (ON/OFF TIMER) (Except KV-13M42).</p>
	
<p>Program your channels, set TV rating, or select menu language.</p>	<p>The CHANNEL SET UP menu is a sub-menu that provides further options for setting up your channels.</p>

 The menus shown are for KV-20S90. Your menus may not look like those illustrated.

Using the Menus



This chapter shows the options available for setting up and adjusting your TV.

To access a menu

- 1 Press .
- 2 Use the  or  buttons to highlight a menu.
- 3 Press  to access the menu.

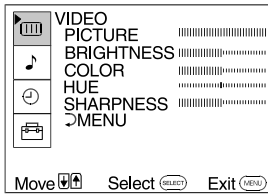
Using the VIDEO menu



Item	Press  to	Press  to
PICTURE	Decrease picture contrast	Increase picture contrast
BRIGHTNESS	Darken the picture	Brighten the picture
COLOR	Decrease color intensity	Increase color saturation
HUE	Increase the red tones	Increase the green tones
SHARPNESS	Soften the picture	Sharpen the picture

Using the AUDIO menu

KV-20S90 only

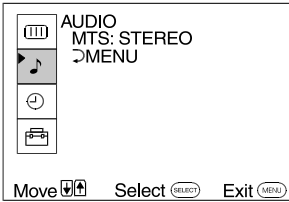

MTS



*Multi-Channel
TV Sound*

STEREO: Select when viewing a broadcast in stereo.

SAP: Listen to bilingual or other Second Audio Programs (SAP).

MONO: Select to reduce noise in areas with poor reception.

 If your TV is set to SAP, all non-SAP programs will be muted. If your TV does not have sound, check your AUDIO settings.

 For direct MTS settings, press the  button on your remote control.



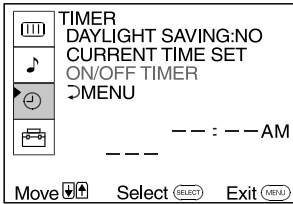

Using the **TIMER** menu

Except KV-13M42







DAYLIGHT SAVING **YES:** Select in spring to compensate for Daylight Savings.
NO: Select in fall at the end of Daylight Savings.

CURRENT TIME SET With the menu open:

- 1 Press .
- 2 Press \uparrow or \downarrow to cycle through the days, then press .
- 3 Press \uparrow or \downarrow until the current hour is displayed, then press .
- 4 Press \uparrow or \downarrow until the current minute is displayed, then press .

ON/OFF TIMER **CURRENT TIME SET** must be programmed before the
Scheduled viewing **ON/OFF TIMER** is available.

With the menu open:

- 1 Press .
- 2 Press \uparrow or \downarrow until the desired day or range of days is displayed, then press .
- 3 Indicate the time that you want the TV to turn on by pressing \uparrow or \downarrow and the , (for hour and minutes).
- 4 Press \uparrow or \downarrow to set the duration, up to 6 hours, then press .
- 5 Press \uparrow or \downarrow to set the channel and press .

 When you perform AUTO PROGRAM, all ON/OFF TIMER settings will be cleared.

 Any loss of power will cause the ON/OFF TIMER settings to be cleared.

 When the ON/OFF TIMER is programmed, the light on the front of your TV will be turned on.

Using the SET UP menu

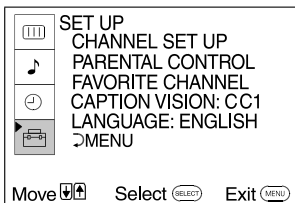









PARENTAL CONTROL



The PARENTAL CONTROL feature provides parents several options for programming the TV to block shows based on their rating, (see page 18).

FAVORITE CHANNEL

Quick access to favorite channels

With the FAVORITE CHANNEL menu open:

- 1 Press .
- 2 Use the  or  buttons to select AUTO or MANUAL, (selecting AUTO will display the last five channels accessed by the .
- 3 Select the position (1-5) where you want to program a channel. Then press .
- 4 Using the  or  buttons, select the desired channel.
- 5 Press , the TV will change to the channel entered.

 To use FAVORITE CHANNEL, exit all menus and press . A window picture will display your favorite channel numbers. Move the cursor to a channel number and press  to view.



CAPTION VISION

Closed-captioning

CC1, 2, 3, 4: Displays printed dialogue and sound effects of a program.





TEXT1, 2, 3, 4: Displays network/station information.

XDS (Extended Data Services): Displays information about the network and current program, if available.

 Press the  button to activate your CAPTION VISION setting.

LANGUAGE

Display all menus in your language of choice.

- 1 Point cursor at LANGUAGE and press .
- 2 Using the  or  buttons, highlight the desired language and press .

CHANNEL SET UP menu

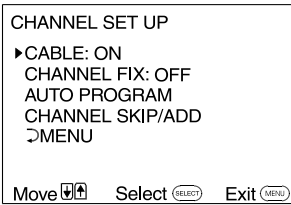

CABLE **ON:** Select if you are receiving cable channels with a CATV cable.
OFF: Select if you are using an antenna.

After changing your CABLE settings, you will need to run AUTO PROGRAM.

CHANNEL FIX **2-6:** Select when you want to control all channel selection through a cable box. Select the appropriate channel (usually 3 or 4) and use the cable box's remote control for channel selection.
VIDEO: Select from available inputs when you have connected video equipment (e.g. satellite receiver) and you want your TV fixed to it.

FAVORITE CHANNEL cannot be used when CHANNEL FIX is set.

AUTO PROGRAM Run AUTO PROGRAM whenever setting up your TV. It will cycle through all available channels and program any receivable channels.

CHANNEL SKIP/ADD Use this feature after you run AUTO PROGRAM to skip unwanted channels or add new ones.

- 1 Use the (0)-(9) or CH +/- buttons to access the desired channel.
- 2 Press to SKIP or ADD (only one option will be available).

Using PARENTAL CONTROL

The PARENTAL CONTROL feature is designed to help parents monitor what their children watch on television. This section shows you the different rating systems available and how to set your TV's rating.

Overview of the Ratings

Once you have become familiar with these rating systems, you should be ready to set your TV's rating.

TV RATINGS

The TV ratings are divided into two groups: age-based and content-based.

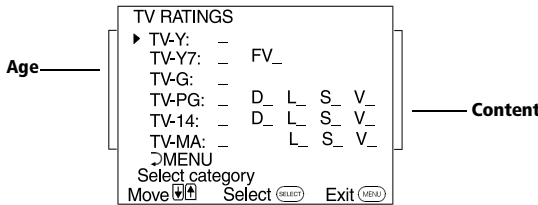

Age	Defined as
TV-Y	All children
TV-Y7	Directed to older children
TV-G	General audience
TV-PG	Parental Guidance suggested
TV-14	Parents Strongly cautioned
TV-MA	Mature Audience only

Contents	Defined as
FV	Fantasy Violence
D	Suggestive dialogue
L	Strong language
S	Sexual situations
V	Violence

 The content ratings will increase depending on the level of the age-based rating. For example, a program with a TV-PG V (Violence) rating may contain moderate violence, while a TV-14 V (Violence) rating may contain more intense violence.

MOVIE RATINGS

(U.S. models only)

This system defines the rating levels of movies shown on the big screen and those on prime cable channels.

Rating	Defined as
G	General audience
PG	Parental Guidance suggested
PG-13	Parents Strongly cautioned
R	Restricted
NC-17	No one 17 and under admitted
X	Adult audience only

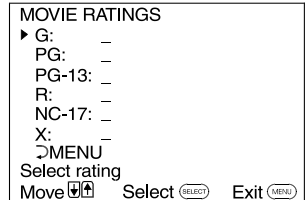

UNRATED

(U.S. models only)

You have the option of blocking TV programs or movies that are not rated.

Rating	Defined as
VIEW ALL	No block
BLOCK TV	Block all unrated TV programs
BLOCK MOVIE	Block all unrated movies
BLOCK ALL	Block all unrated programming

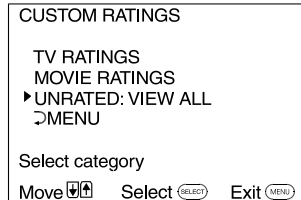

If you choose to block unrated TV programs, please be aware the following programs may be blocked: emergency broadcasts, political programs, sports, news, public service announcements, religious programs and weather.

ENGLISH RATINGS

(Canadian models only)

These ratings are for Canadian programs that are broadcast in English.

Rating	Defined as
C	Children
C8+	Children 8 years and older
G	General programming
PG	Parental Guidance
14+	Viewers 14 and older
18+	Adult programming

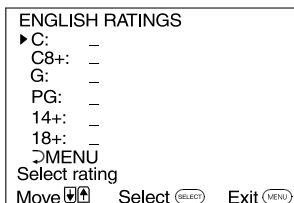

FRENCH RATINGS

(Canadian models only)

These ratings are for Canadian programs that are broadcast in French.

Rating	Defined as
G	General
8 ans+	Not recommended for younger children
13 ans+	Not recommended for children under age 13
16 ans+	Not recommended for ages under 16
18 ans+	This program is restricted to adults

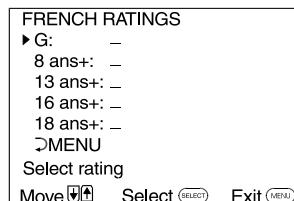





U.S.A. RATINGS

(Canadian models only)

For programs from the United States. Please see, "TV RATINGS" on page 18 for information on U.S.A. RATINGS.

Initial access into PARENTAL CONTROL

- 1 In the SET UP  menu, point the cursor to PARENTAL CONTROL and press , (you will be asked to set 4-digit password for any future access into PARENTAL CONTROL).
- 2 Press , then use the  buttons to enter a 4-digit password.

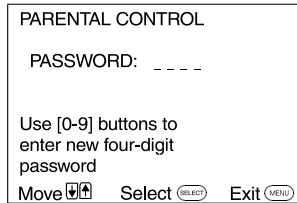

 Keep this instruction manual in a safe place. In the event that you forget your password, please see page 26.





- 3 Confirm your password by entering it again.

Once your password is set correctly, you will be taken into the PARENTAL CONTROL menu.

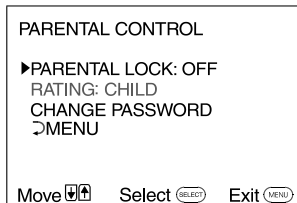
Activating PARENTAL LOCK





In order to change the RATING, you will need to set PARENTAL LOCK to ON.



- 1 Point the cursor to PARENTAL LOCK and press .
- 2 Using the  or  buttons, highlight ON and press  to activate.

Setting the RATING

If you are not familiar with the Parental Guidelines rating system, you should use one of the following preselected categories: CHILD, YOUTH or YOUNG ADULT.















- 1 Point the cursor to RATING and press .
- 2 Using the  or  buttons, select the desired rating and press .



Rating	TV will allow a maximum rating of:
CHILD	TV-Y, TV-G, G (U.S. models only), G (Canadian models only)
YOUTH	TV-PG, PG (U.S. models only), PG (Canadian models only)
YOUNG ADULT	TV-14, PG-13 (U.S. models only), 14+ (Canadian models only)
CUSTOM	Select to set more restrictive ratings, (see next section).

Using the CUSTOM menu

You should be familiar with the rating systems before attempting to set CUSTOM ratings. Refer to pages 18-20, "Overview of the Ratings," for a description of the available rating systems.

- 1 In the RATING option, use  or  to highlight CUSTOM and press .
- 2 Using the  or  buttons, select the desired rating category and press .
- 3 Use  or  to select the maximum rating or content and press .
- 4 Press  or  to block () or unblock () the rating or content and press .

 Once you have blocked a rating or content, all higher ratings or contents will be automatically blocked.

Resetting your password

- 1 Use the \uparrow or \downarrow buttons to move the cursor to CHANGE PASSWORD and press .
- 2 Follow the directions for, "Initial Access into Parental Control," on page 21, for information on changing your password.

Information for Parents

To view a program that exceeds the TV rating

- Press  on the remote control, then use the $\text{\textcircled{0}}$ - $\text{\textcircled{9}}$ buttons to enter your password.

 Entering your password to view a blocked program will temporarily turn PARENTAL LOCK to OFF. To reactivate your PARENTAL LOCK settings, turn the TV off then back on; the TV will return to the settings that you have selected.

Other Information

Troubleshooting

If you are having a problem with your TV, try the suggestions below. If the problem persists, contact your nearest Sony dealer.

No picture, no sound	<ul style="list-style-type: none"><input type="checkbox"/> Make sure the power cord is plugged in.<input type="checkbox"/> If a red light is flashing on the front of your TV for more than a few minutes, disconnect and reconnect the power cord to restore the TV. If the problem continues, call your local service center.<input type="checkbox"/> Check the TV/VIDEO settings: when watching TV, set to TV; when watching video equipment, set to VIDEO (page 9).<input type="checkbox"/> Check your PARENTAL CONTROL settings, (see pages 21-23).<input type="checkbox"/> Make sure the batteries have been inserted correctly into the remote control.<input type="checkbox"/> Try another channel, it could be station trouble.
Poor or no picture, good sound	<ul style="list-style-type: none"><input type="checkbox"/> Adjust PICTURE in the VIDEO menu (page 13).<input type="checkbox"/> Adjust BRIGHTNESS in the VIDEO menu (page 13).<input type="checkbox"/> Check the antenna and/or cable connections (page 3).
Good picture, no sound	<ul style="list-style-type: none"><input type="checkbox"/> Press  so that MUTING disappears from the screen (page 9).<input type="checkbox"/> Check your AUDIO settings. Your TV may be set to SAP (page 14).
No color	<ul style="list-style-type: none"><input type="checkbox"/> Adjust COLOR in the VIDEO menu (page 13).
Only snow appears on the screen	<ul style="list-style-type: none"><input type="checkbox"/> Check the CABLE setting in the CHANNEL SET UP menu (page 17).<input type="checkbox"/> Check the antenna and/or cable connections (page 3).<input type="checkbox"/> Make sure the channel selected is currently broadcasting.
Dotted lines or stripes	<ul style="list-style-type: none"><input type="checkbox"/> Adjust the antenna.<input type="checkbox"/> Move the TV away from other electronic equipment. Some electronic equipment can create electrical noise, which can interfere with TV reception.
Double images or ghosts	<ul style="list-style-type: none"><input type="checkbox"/> Check your outdoor antenna or call your cable service.

Cannot receive higher number channels (UHF) when using an antenna	<ul style="list-style-type: none"><input type="checkbox"/> Make sure CABLE is set to OFF in the CHANNEL SET UP menu (page 17).<input type="checkbox"/> Use AUTO PROGRAM to add channels that are not presently in the memory (page 17).
Cable stations don't seem to work	<ul style="list-style-type: none"><input type="checkbox"/> Make sure CABLE is set to ON in the CHANNEL SET UP menu (page 17).<input type="checkbox"/> Use AUTO PROGRAM to add channels that are not presently in the memory (page 17).
Remote control does not operate	<ul style="list-style-type: none"><input type="checkbox"/> Batteries could be weak. Replace them (page 2).<input type="checkbox"/> Move the TV 3-4 feet away from fluorescent lights.
The TV needs to be cleaned	<ul style="list-style-type: none"><input type="checkbox"/> Clean the TV with a soft dry cloth. Never use strong solvents such as thinner or benzine, which might damage the finish of the cabinet.
Lost password for PARENTAL CONTROL	<ul style="list-style-type: none"><input type="checkbox"/> In the password screen, enter the following master password: 4357. After using the master password, you must create a new password, it cannot be used to unlock currently blocked programs.
You lost your remote control	<ul style="list-style-type: none"><input type="checkbox"/> You can use the control buttons on the front panel of your TV. Follow the instructions on the screen. Contact your nearest Sony dealer to order a replacement.

If, after reading these operating instructions, you have additional questions related to the use of your Sony television, please call our Direct Response Center at 1-800-222-SONY (7669) (U.S. customers only) or (416) 499-SONY (7669) (Canadian customers only).

Specifications

For all models (except as noted)

Television system	American TV standard/NTSC
Channel coverage	VHF: 2-13/UHF: 14-69/CATV: 1-125
Antenna	75-ohm external antenna terminal for VHF/UHF
Picture tube	Trinitron® tube
Power requirements	120 V, 60 Hz
Supplied Accessories	Size AA (R6) batteries (2) Antenna connector (KV-13M42 only) Remote Control RM-Y156 (1) (KV-13M42, KV-20M42) RM-Y155 (1) (KV-20S90) Antenna dipole (KV-13M42 only)

KV-13M42

Screen size	Visible screen size: 13 inches (341 mm) measured diagonally Actual screen size: 14 inches (356 mm) measured diagonally
Inputs/outputs	1 video, 1 audio 1 headphone jack
Speaker output	3 W
Power Consumption	75 W when in use 1 W in standby
Dimensions (W/H/D)	358 x 355 x 401.4 mm (14 ¹ / ₈ x 14 x 15 ⁷ / ₈ in.)
Mass	10 kg (22 lbs.)

KV-20M42, KV-20S90

Screen size	Visible screen size: 20 inches (507 mm) measured diagonally Actual screen size: 21 inches (533 mm) measured diagonally
Inputs/outputs	2 video, 2 audio 1 headphone jack
Speaker output	3 W (KV-20M42) 3W x 2 (KV-20S90)
Power Consumption	80 W when in use (KV-20M42) 90 W when in use (KV-20S90) 1 W in standby
Dimensions (W/H/D)	522 x 477 x 479 mm (KV-20M42) (20 ⁵ / ₈ x 18 ¹³ / ₁₆ x 18 ⁷ / ₈ inch) 609.2 x 464.5 x 469.5 mm (KV-20S90) (24 x 18 ³ / ₈ x 18 ¹ / ₂ inch)
Mass	21.6 kg (48 lbs.) (KV-20M42) 21 kg (46.2 lbs.) (KV-20S90)

Design and specifications are subject to change without notice.

Index

A

AUDIO 🎵 menu 14
AUTO PROGRAM 17

B

Battery Installation 2
BRIGHTNESS 13

C

CAPTION VISION 16
CHANNEL FIX 17
CHANGE PASSWORD 23
CHANNEL SET UP 17
COLOR 13
Connections
 Antenna/Cable 3
 TV and Cable Box 5
 TV and VCR 4
 TV, VCR, and Cable box 6
 Connecting a Camcorder 7
 Connecting Headphones 7
CURRENT TIME SET 15

D

DAYLIGHT SAVING 15
DISPLAY 9

E

ENGLISH RATINGS 20

F

FAVORITE CHANNEL 1, 16
FRENCH RATINGS 20

H

HUE 13

L

LANGUAGE 16

M

Menus
 AUDIO 🎵 14
 CHANNEL SET UP 17
 SET UP 📺 16
 TIMER ⌚ 15
 VIDEO 📺 13
MOVIE RATING 19
MTS 14
 MONO 14
 SAP 14
 STEREO 14

O

ON/OFF TIMER 1, 15

P

PARENTAL CONTROL 1, 18
Password 21
 Entering 21
 Lost 26
PICTURE 13

R

RATINGS 18
 ENGLISH 20
 FRENCH 20
 MOVIE 19
 TV 18
 UNRATED 19
Remote Control 9

S

SET UP 📺 menu 16
SHARPNESS 13
SLEEP 9
Specifications 27

T

TIMER ⌚ menu 15
Troubleshooting 25
TV Features 1
TV RATING 18

U

U.S.A. RATINGS 20
UNRATED 19

V

VIDEO 📺 menu 13

Free Manuals Download Website

<http://myh66.com>

<http://usermanuals.us>

<http://www.somanuals.com>

<http://www.4manuals.cc>

<http://www.manual-lib.com>

<http://www.404manual.com>

<http://www.luxmanual.com>

<http://aubethermostatmanual.com>

Golf course search by state

<http://golfingnear.com>

Email search by domain

<http://emailbydomain.com>

Auto manuals search

<http://auto.somanuals.com>

TV manuals search

<http://tv.somanuals.com>