

FD Trinitron
WEGA®

Operating Instructions

WARNING

To reduce the risk of fire or shock hazard, do not expose the TV to rain or moisture.

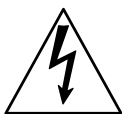
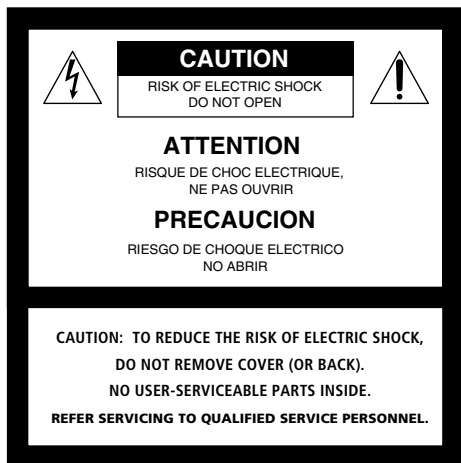

This symbol is intended to alert the user to the presence of uninsulated "dangerous voltage" within the product's enclosure that may be of sufficient magnitude to constitute a risk of electric shock to persons.



This symbol is intended to alert the user to the presence of important operating and maintenance (servicing) instructions in the literature accompanying the appliance.

CAUTION

TO PREVENT ELECTRIC SHOCK, MATCH WIDE BLADE OF PLUG TO WIDE SLOT, FULLY INSERT.

CAUTION

When using TV games, computers, and similar products with your TV, keep the brightness and contrast functions at low settings. If a fixed (non-moving) pattern is left on the screen for long periods of time at a high brightness or contrast setting, the image can be permanently imprinted onto the screen. Continuously watching the same program can cause the imprint of station logos onto the TV screen. These types of imprints are not covered by your warranty because they are the result of misuse.

Note on Caption Vision

This television receiver provides display of television closed captioning in accordance with §15.119 of the FCC rules.

Note on Cleaning the TV

Clean the TV with a soft, dry cloth. Never use strong solvents such as thinner or benzene, which might damage the finish of the cabinet.

Note to CATV System Installer

This reminder is provided to call the CATV system installer's attention to Article 820-40 of the National Electrical Code (NEC) that provides guidelines for proper grounding and, in particular, specifies that the cable ground shall be connected to the grounding system of the building, as close to the point of cable entry as practical.

Use of this television receiver for other than private viewing of programs broadcast on UHF or VHF or transmitted by cable companies for the use of the general public may require authorization from the broadcaster/cable company and/or program owner.

NOTIFICATION

This equipment has been tested and found to comply with the limits for a Class B digital device pursuant to Part 15 of the FCC Rules. These limits are designed to provide reasonable protection against harmful interference in a residential installation. This equipment generates, uses, and can radiate radio frequency energy and, if not installed and used in accordance with the instructions, may cause harmful interference with radio communications. However, there is no guarantee that interference will not occur in a particular installation. If this equipment does cause harmful interference to radio or television reception, which can be determined by turning the equipment off and on, the user is encouraged to try to correct the interference by one or more of the following measures:

- Reorient or relocate the receiving antennas.
 - Increase the separation between the equipment and receiver.
 - Connect the equipment into an outlet on a circuit different from that to which the receiver is connected.
 - Consult the dealer or an experienced radio/TV technician for help.
- You are cautioned that any changes or modifications not expressly approved in this manual could void your authority to operate this equipment.

Installing

- To prevent internal heat buildup, do not block the ventilation openings.
- Do not install the TV in a hot or humid place, or in a place subject to excessive dust or mechanical vibration.
- The AC power cord is attached to the rear of the TV with hooks. Do not attempt to remove the cord from these hooks. Doing so could cause damage to the TV.

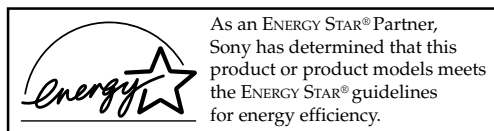

ENERGY STAR® is a U.S. registered mark.

Owner's Record

The model and serial numbers are provided on the front of this instruction manual and at the rear of the TV. Refer to them whenever you call upon your Sony dealer regarding this product.

Trademark Information

TruSurround and the  symbol are trademarks of SRS Labs, Inc. TruSurround technology is incorporated under license from SRS Labs, Inc.

BBE and BBE Symbol are trademarks of BBE Sound, Inc. and are registered by BBE Sound, Inc. under U.S. Patent No. 4,638,258 and 4,482,866.

Wega, FD Trinitron, Steady Sound, Digital Reality Creation, Caption Vision, CineMotion, Memory Stick, and Twin View are registered trademarks of Sony Corporation. ClearEdge VM and HD Detailer are trademarks of Sony Corporation.

IMPORTANT SAFEGUARDS

For your protection, please read these instructions completely, and keep this manual for future reference.

Carefully observe and comply with all warnings, cautions and instructions placed on the set, or described in the operating instructions or service manual.

WARNING

To guard against injury, the following basic safety precautions should be observed in the installation, use, and servicing of the set.

Use

Power Sources

This set should be operated only from the type of power source indicated on the serial/model plate. If you are not sure of the type of electrical power supplied to your home, consult your dealer or local power company. For those sets designed to operate from battery power, refer to the operating instructions.



Grounding or Polarization

This set is equipped with a polarized AC power cord plug (a plug having one blade wider than the other), or with a three-wire grounding type plug (a plug having a third pin for grounding). Follow the instructions below:

For the set with a polarized AC power cord plug

This plug will fit into the power outlet only one way. This is a safety feature. If you are unable to insert the plug fully into the outlet, try reversing the plug. If the plug should still fail to fit, contact your electrician to have a suitable outlet installed. Do not defeat the safety purpose of the polarized plug by forcing it in.



Alternate Warning

For the set with a three-wire grounding type AC plug

This plug will only fit into a grounding-type power outlet. This is a safety feature. If you are unable to insert the plug into the outlet, contact your electrician to have a suitable outlet installed. Do not defeat the safety purpose of the grounding plug.



Overloading

Do not overload wall outlets, extension cords or convenience receptacles beyond their capacity, since this can result in fire or electric shock.



Always turn the set off when it is not to be used. When the set is left unattended and unused for long periods of time, unplug it from the wall outlet as a precaution against the possibility of an internal malfunction that could create a fire hazard.



Do not disconnect the antenna or the power cord during a heavy storm. Lightning may strike while you are holding the cable or cord, causing serious injury. Turn off your TV and wait for the weather to improve.

Memory Stick

To protect small children from injury from Memory Stick Media, remove all Memory Stick media from the TV's Memory Stick slot and store it in a safe location when it is not in use.

Object and Liquid Entry

Never push objects of any kind into the set through the cabinet slots as they may touch dangerous voltage points or short out parts that could result in a fire or electric shock. Never spill liquid of any kind on the set.

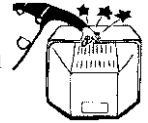

Attachments

Do not use attachments not recommended by the manufacturer, as they may cause hazards.

Do not place any objects, especially heavy objects, on top of the set. The object may fall from the set, causing injury.

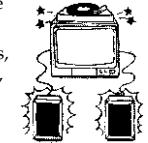

Cleaning

Unplug the set from the wall outlet before cleaning or polishing it. Do not use liquid cleaners or aerosol cleaners. Use a cloth lightly dampened with water for cleaning the exterior of the set.



If a snapping or popping sound from a TV set is continuous or frequent while the TV is operating, unplug the TV and consult your dealer or service technician. It is normal for some TV sets to make occasional snapping or popping sounds, particularly when being turned on or off.

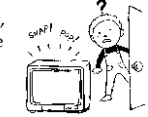

Installation

Always use two or more people to lift or move the set. The set is heavy and the bottom surface is flat. Serious injury can result from trying to move the set by yourself alone, or from unsteady handling. Install the set on a stable, level surface.

Water and Moisture

Do not use power-line operated sets near water — for example, near a bathtub, washbowl, kitchen sink, or laundry tub, in a wet basement, or near a swimming pool, etc.

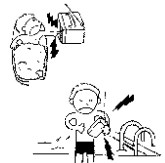

Accessories

Do not place the set on an unstable cart, stand, tripod, bracket, table or shelf. The set may fall, causing serious injury to a child or an adult, and serious damage to the set. Use only a cart or stand recommended by the manufacturer for the specific model of TV. Any mounting of the product should follow the manufacturer's instructions, and should use a mounting accessory recommended by the manufacturer. An appliance and cart combination should be moved with care. Quick stops, excessive force, and uneven surfaces may cause the appliance and cart combination to overturn.



Disconnect all cables and cords from the set before attempting to move the set.

Do not allow children or pets to climb up onto, or push against, the set. The set may fall, causing serious injury.

Ventilation

The slots and openings in the cabinet and in the back or bottom are provided for necessary ventilation. To ensure reliable operation of the set, and to protect it from overheating, these slots and openings must never be blocked or covered.

- Never cover the slots and openings with a cloth or other materials.
- Never block the slots and openings by placing the set on a bed, sofa, rug or other similar surface.
- Never place the set in a confined space, such as a bookcase, or built-in cabinet, unless proper ventilation is provided.
- Do not place the set near or over a radiator or heat register, or where it is exposed to direct sunlight.

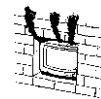
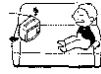

Power Cord Protection

Do not allow anything to rest on or roll over the power cord, and do not place the set where the power cord is subject to wear or abuse.

Antennas

Outdoor Antenna Grounding

If an outdoor antenna is installed, follow the precautions below. An outdoor antenna system should not be located in the vicinity of overhead power lines or other electric light or power circuits, or where it can come in contact with such power lines or circuits.

WHEN INSTALLING AN OUTDOOR ANTENNA SYSTEM, EXTREME CARE SHOULD BE TAKEN TO KEEP FROM CONTACTING SUCH POWER LINES OR CIRCUITS AS CONTACT WITH THEM IS ALMOST INVARIABLY FATAL.

Be sure the antenna system is grounded so as to provide some protection against voltage surges and built-up static charges. Section 810 of the National Electrical Code (NEC) in USA and Section 54 of the Canadian Electrical Code in Canada provide information with respect to proper grounding of the mast and supporting structure, grounding of the lead-in wire to an antenna discharge unit, size of grounding conductors, location of antenna discharge unit, connection to grounding electrodes, and requirements for the grounding electrode.

Antenna Grounding According to the National Electrical Code, ANSI/NFPA 70

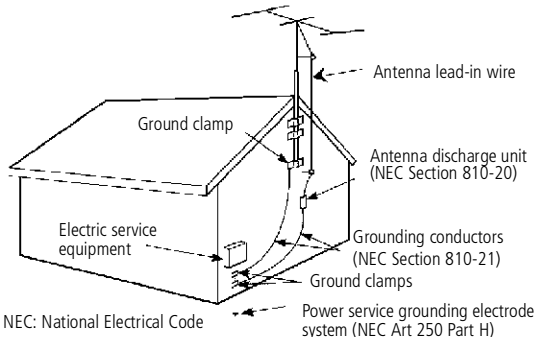







Lightning

For added protection for this television receiver during a lightning storm, or when it is left unattended and unused for long periods of time, unplug it from the wall outlet and disconnect the antenna. This will prevent damage to the receiver due to lightning and power line surges.

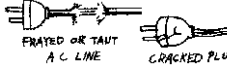
Service

Damage Requiring Service

Unplug the set from the wall outlet and refer servicing to qualified service personnel under the following conditions:

- When the power cord or plug is damaged or frayed. 
- If liquid has been spilled into the set or objects have fallen into the product. 
- If the set has been exposed to rain or water. 
- If the set has been subject to excessive shock by being dropped, or the cabinet has been damaged. 
- If the set does not operate normally when following the operating instructions. Adjust only those controls that are specified in the operating instructions. Improper adjustment of other controls may result in damage and will often require extensive work by a qualified technician to restore the set to normal operation. 
- When the set exhibits a distinct change in performance, it indicates a need for service. 

Servicing

Do not attempt to service the set yourself since opening the cabinet may expose you to dangerous voltage or other hazards. Refer all servicing to qualified service personnel.

Replacement Parts

When replacement parts are required, be sure the service technician certifies in writing that he has used replacement parts specified by the manufacturer that have the same characteristics as the original parts.

Unauthorized substitutions may result in fire, electric shock or other hazards.

Safety Check

Upon completion of any service or repairs to the set, ask the service technician to perform routine safety checks (as specified by the manufacturer) to determine that the set is in safe operating condition, and to so certify. When the set reaches the end of its useful life, improper disposal could result in a picture tube implosion. Ask a qualified service technician to dispose of the set.



Contents

Introducing the FD Trinitron Wega

Overview	7
Presenting the FD Trinitron Wega	7
Package Contents.....	7
Features	7

Setting Up the TV

Overview	9
About the AC Power Cord.....	9
TV Controls and Connectors	10
Front Panel	10
Rear Panel	12
Basic Connections: Connecting a Cable or Antenna	14
Cable or Antenna Only	15
Cable and Antenna Only	16
Cable Box and Cable Only	18
Cable Box Only.....	20
Connecting Optional Equipment	21
About Using S VIDEO	21
VCR and Cable	22
VCR and Cable Box	24
Two VCRs for Tape Editing	26
Satellite Receiver.....	28
Satellite Receiver and VCR	30
DVD Player with Component Video Connectors.....	32
DVD Player with S VIDEO and Audio Connectors	34
Camcorder	35
Audio Receiver	36
Using the CONTROL S Feature	37
Setting Up the Channel List	38
Using Auto Setup	38

Using the Remote Control

Overview	39
Inserting Batteries	39
Button Descriptions	40
Outside Panel	40
Inside Panel	42
Programming the Remote Control	43

Using the Features

Overview	45
Watching TV	45
Using the Scrolling Index	46
Factors Affecting Scrolling Index	46
Using Twin View	47
Displaying Twin Pictures	47
Factors Affecting Twin View	47
Activating the Picture	48
Changing the Picture Size	49
Using Favorite Channels	50
Creating a List of Favorite Channels	50
Displaying a List of Favorite Channels	50
Using the Freeze Function	51
Using the Memory Stick Picture Viewer	52
About Memory Stick	52
Supported Image Types	52
Unsupported Image Types	54
Inserting and Removing a Memory Stick	55
Displaying the Memory Stick Menu	56
Using the Memory Stick Index	57
Using the Memory Stick Slideshow	58
Changing the Memory Stick Setup Options	58
Using the Rotate Picture Screen	59
Using Other Equipment with Your TV Remote Control	60
All Equipment	60
Operating a VCR	60
Operating a Satellite Receiver	60
Operating a Cable Box	61
Operating a DVD Player	61
Operating an MDP (Laserdisc Player)	61

Using the Menus

Overview	63
Navigating Through Menus	63
Using the Video Menu	64
Using the Audio Menu	66
Using the Channel Menu	68
Using the Parent Menu	70
Using the Timer Menu	73
Using the Setup Menu	74

Other Information

Overview	77
Glossary	78
Notes on Using Memory Stick Media	79
Contacting Sony	80
Troubleshooting	80
Specifications	85
Optional Accessories	86
Index	87

Introducing the FD Trinitron Wega

Overview

This chapter describes the contents of the package in which the TV is shipped and provides an overview of the features of your Wega TV.

Presenting the FD Trinitron Wega

The FD Trinitron Wega (pronounced VAY-GAH) is characterized by outstanding contrast, uncompromising accuracy, and corner-to-corner detail.

You will recognize the superiority of Wega technology almost immediately. The first thing you will probably notice is minimal glare from the flat picture tube. This flat-screen technology improves picture detail without distortion, unlike conventional curved screens. The FD Trinitron delivers outstanding image detail not only at the screen center, but also at the corners — so you can enjoy a bright, clear picture from any location in a room.

Package Contents

Along with your new Trinitron TV, the packing box contains a remote control and two AA (R6) batteries. These items are all you need to set up and use the TV.

Features

Some of the features that you will enjoy with your new TV include:

- ❑ **DRC® (Digital Reality Creation) Multifunction:** Unlike conventional line doublers, the DRC Multifunction feature replaces the signal's NTSC waveform with the HD equivalent, while doubling the number of vertical and horizontal lines. This results in four times the density for quality sources, such as DVD, satellite, and digital camcorders. The Video Menu allows you to select interlaced, progressive, or CineMotion™ output.
- ❑ **Scrolling Index:** Lets you select programs from a series of preview windows that scroll along the right side of the screen.

- ❑ **Twin View™**: Using the Multi-Image Driver (MIDX), Twin View allows you to watch two programs side by side, with the ability to zoom in one picture. You can watch pictures from two different sources (1080i, 720p, 480p, and 480i) simultaneously. (Only the left Twin View window can display 1080i, 720p, and 480p sources.)
- ❑ **Favorite Channels**: Allows you to preview and select from eight of your favorite channels.
- ❑ **ClearEdge VM™ Velocity Modulation**: Sharpens picture definition by enhancing vertical lines.
- ❑ **Steady Sound®**: Equalizes volume levels so there is consistent output between programs and commercials.
- ❑ **Memory Stick® Picture Viewer**: Allows you to view on your TV screen digital images that are stored on Memory Stick media.
- ❑ **Component Video Inputs**: Offers the best video quality for DVD (480p, 480i), and digital set-top box (HD1080i, 720p) connections.
- ❑ **CineMotion™**: Reverse 3-2 pulldown processing provides optimal picture quality for film-based sources (media originally shot in 24 frames-per-second format).
- ❑ **HD Detailer™**: Wideband video amplifier has a high bandwidth frequency rating, which allows it to send more video information to the screen, resulting in finer picture quality, especially for HD sources.
- ❑ **16:9 Enhancement**: Vertical Compression technology that maximizes picture resolution when playing “anamorphic” or “enhanced for widescreen” sources, including many DVDs.
- ❑ **Parental Control**: V-Chip technology allows parents to block unsuitable programming from younger viewers.
- ❑ **Digital Visual Interface (DVI)**: Can accommodate a copy-protected digital connection (HDCP*) to other devices (such as digital set-top boxes) that have compatible interfaces. The DVI-HDTV input terminal is compliant with the EIA-861 standard and is not intended for use with personal computers.

 16:9 is also referred to as widescreen format.

*High-bandwidth Digital Content Protection

Setting Up the TV

Overview

This chapter includes illustrated instructions for setting up your TV.

Topic	Page(s)
TV Controls and Connectors	10-13
Basic Connections: Connecting a Cable or Antenna	14-20
Connecting Optional Equipment	
VCR and Cable	22
VCR and Cable Box	24
Two VCRs for Tape Editing	26
Satellite Receiver	28
Satellite Receiver and VCR	30
DVD Player with Component Video Connectors	32
DVD Player with S VIDEO and Audio Connectors	34
Camcorder	35
Audio Receiver	36
Using the CONTROL S Feature	37
Setting Up the Channel List	38

About the AC Power Cord

The AC power cord is attached to the rear of the TV with a hook. Use caution when removing the AC plug from its holder. Gently slide the plug upward to remove it from the hook. Once removed, the AC power plug should automatically disengage from its stored location.

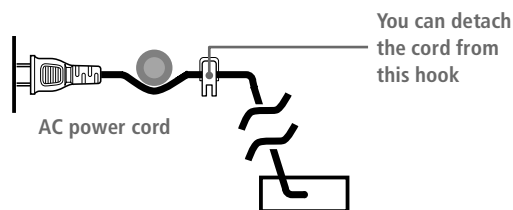

 **Do not plug in the AC power cord until you have made all other connections.**

TV Controls and Connectors

Front Panel

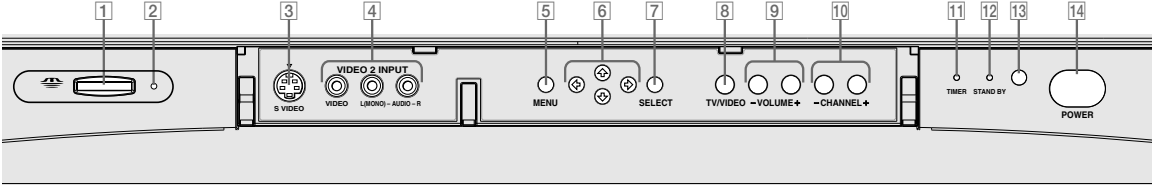

Setup

<i>Item</i>	<i>Description</i>
1	MEMORY STICK Memory Stick insertion slot. For details, see “Using the Memory Stick Picture Viewer” on page 52.
2	MEMORY STICK LED When lit, indicates that the Memory Stick is being read. (Do not remove the Memory Stick when the indicator is lit.)
3	S VIDEO VIDEO 2 INPUT Connects to the S VIDEO OUT jack on your camcorder or other video equipment that has S VIDEO. Provides better picture quality than composite video ([4]).
4	VIDEO/L(MONO)-AUDIO-R VIDEO 2 INPUT Connects to the composite A/V output jacks on your camcorder or other video equipment.
5	MENU Press to display the Menu. Press again to exit from the Menu. For details, see “Using the Menus” on page 63.
6	↑ ↓ ← → Press ↑ ↓ ← → to move the on-screen cursor.
7	+ SELECT Press to select the on-screen highlighted item.
8	TV/VIDEO Press repeatedly to cycle through the video equipment connected to the TV’s video inputs.
9	-VOLUME + Press to adjust the volume.
10	-CHANNEL+ Press to scan through channels. To scan quickly through channels, press and hold down either CHANNEL button.
11	TIMER LED When lit, indicates one of the timers is set. When the timer is set, this LED will remain lit even if the TV is turned off. For details, see page 73.
12	STAND BY LED Blinks when the TV is turned on, then shuts off when the picture is displayed. If the LED blinks continuously, this may indicate the TV needs service (see “Contacting Sony” on page 80).
13	Infrared Receiver (IR) Receives IR signals from the TV’s remote control.
14	POWER Press to turn on and off the TV.

Rear Panel

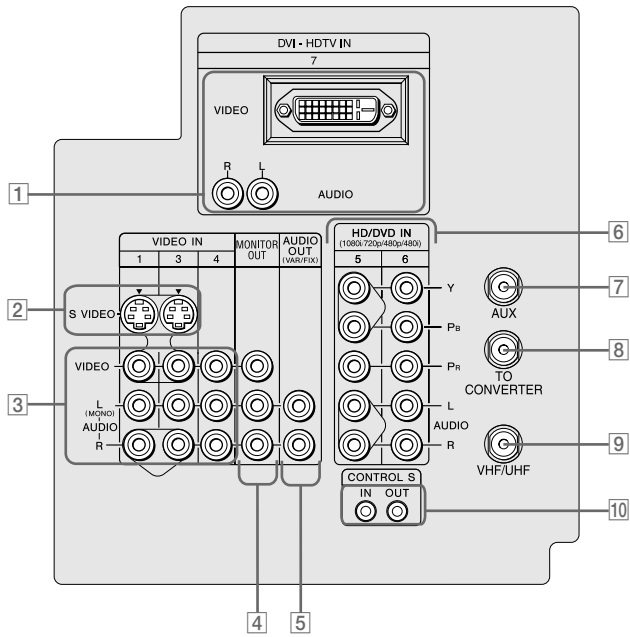

Jack	Description
1 DVI-HDTV VIDEO AUDIO R/L (VIDEO 7 IN)	Can accommodate a copy-protected digital connection (HDCP*) to other devices (such as digital set-top boxes) that have compatible interfaces. The DVI-HDTV input terminal is compliant with the EIA-861 standard and is not intended for use with personal computers. See the instruction manual that came with your equipment for details about connecting and using it with the TV.
2 S VIDEO IN 1/3	Connects to the S VIDEO OUT jack of your VCR or other video equipment that has S VIDEO. S VIDEO provides better picture quality than either composite video (3) or VHF/UHF (9) connections.
3 VIDEO IN 1/3/4 VIDEO/L(MONO) -AUDIO-R	Connect to the composite A/V output jacks on your VCR or other video component. A fourth component A/V input jack (VIDEO 2) is located on the front panel of the TV. This video connection provides better picture quality than the VHF/UHF (9) connection.
4 MONITOR OUT	Lets you record the program you are watching to a VCR. When two VCRs are connected, you can use the TV as a monitor for tape-to-tape editing (not available with 480p, 720p, or 1080i when the input is set to VIDEO 5-7).
5 AUDIO OUT (VAR/FIX) L (MONO)/R	Connects to the left and right audio input jacks of your audio or video equipment. You can use these outputs to listen to your TV's audio through your stereo system.
6 HD/DVD IN 5/6 (1080i/720p/480p/480i)	Connect to your DVD player's or digital set-top box's component video (Y, PB, PR) and audio (L/R) jacks. Component video provides the best picture quality (better than 2, 3, or 9).
7 AUX	Auxiliary RF input that connects to your antenna, CATV cable, or cable box output jack. This is convenient if you are using two VHF/UHF sources (antenna, CATV cable, or cable box). For details, see pages 16 to 19.
8 TO CONVERTER	Connects to your cable box input jack. This VHF/UHF output jack lets you set up your TV to switch between scrambled channels (coming through a cable box) and unscrambled cable channels. Use this jack instead of a splitter to get better picture quality when you need to switch between scrambled and unscrambled cable channels. For details, see pages 18 to 19.
9 VHF/UHF	Primary RF input that connects to your VHF/UHF antenna or cable.
10 CONTROL S IN/OUT	Allows the TV to receive (IN) and send (OUT) remote control signals to other Sony infrared-controlled audio or video equipment that has the CONTROL S function.

* High-bandwidth Digital Content Protection

Basic Connections: Connecting a Cable or Antenna

The way in which you will connect your TV varies, depending on how your home receives a signal (cable, cable box, antenna) and whether or not you plan to connect a VCR.

<i>If You Are Connecting</i>	<i>See Page</i>
Cable or Antenna Only	15
<input type="checkbox"/> No cable box or VCR	
Cable and Antenna Only	16
<input type="checkbox"/> No cable box or VCR	
Cable Box and Cable Only	18
<input type="checkbox"/> Cable box unscrambles only some channels (usually premium channels)	
<input type="checkbox"/> No VCR	
Cable Box Only	20
<input type="checkbox"/> Cable box unscrambles all channels	
<input type="checkbox"/> No VCR	

If you are connecting a VCR

- See the connections described on pages 22 and 24.

Cable or Antenna Only

For best results, use one of the following connections if you are connecting a cable or an antenna and you:

- ❑ Do not need a cable box to unscramble channels. (If you have a cable box, see pages 18-20.)
- ❑ Do not intend to connect a VCR. (If you have a VCR, see pages 22 and 24.)

The connection you choose depends on the cable type you have in your home, as described below.

75-ohm coaxial cable (usually found in newer homes)

Cable Type

Connect As Shown

VHF Only or combined VHF/UHF or Cable

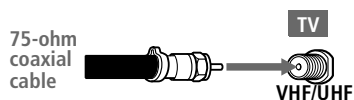

300-ohm twin lead cable (usually found in older homes)

Cable Type

Connect As Shown

VHF Only or UHF Only or combined VHF/UHF

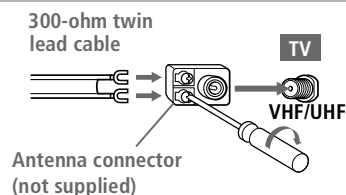

75-ohm coaxial and 300-ohm twin lead cable (found in some homes)

Cable Type

Connect As Shown

VHF and UHF

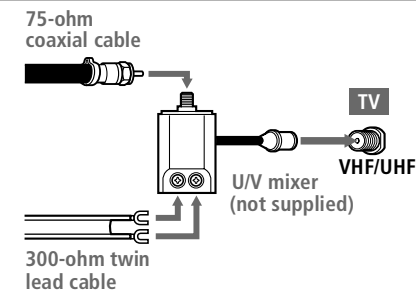

Cable and Antenna Only

For best results, use this connection if you:

- ❑ Have a cable and an antenna.
(This is convenient if you are using a separate rooftop antenna to receive additional channels that are not provided by your cable company.)
- ❑ Do not have a cable box or VCR. (If you have a cable box, see pages 18 to 20. If you have a VCR, see pages 22 and 24.)

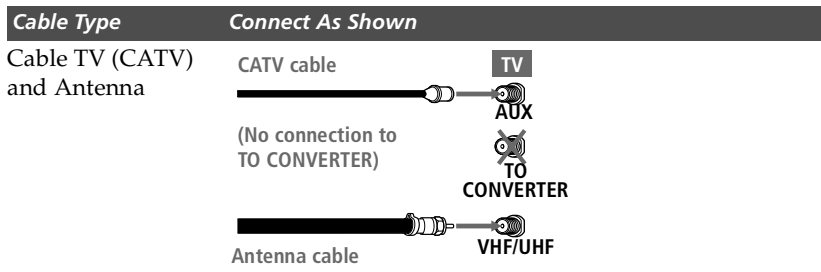

About Using Twin View with This Connection

With this connection, you cannot view CATV channels in the right Twin View window. For details about Twin View, see page 46.

Notes on Using This Connection

<i>To Do This ...</i>	<i>Do This ...</i>
Switch the TV's input between the cable and antenna	Press ANT to switch back and forth between the TV's VHF/UHF and AUX inputs.
Receive channels using an antenna, instead of the cable	<ol style="list-style-type: none">1 Press ANT to switch to the AUX input.2 Set the Cable option to Off. For details, see "Selecting Channel Options" on page 68.3 Run the Auto Setup program, as described in "Using Auto Setup" on page 38.

 **DIGITAL CABLE BOX USERS:** Do not use this connection. The TO CONVERTER jack is not compatible with digital cable boxes.

For best results, use this connection if:

- Your cable company scrambles some channels, such as premium channels (which requires you to use a cable box), but does not scramble all channels.
- You do not have a VCR. (If you have a VCR, see pages 22 and 24.)

With this connection you can:

- Use the TV remote control to change channels coming through the cable box to the TV's AUX input jack. (You must first program the remote control for your specific cable box; see "Programming the Remote Control" on page 43.)
- Use the TV remote control to change channels coming directly into the TV's VHF/UHF input. (The TV's tuner provides a better signal than the cable box.)

About Using Twin View with This Connection

With this connection, you can use all the Twin View features for unscrambled channels coming directly into the TV's VHF/UHF input jack.

However, you can use only some of the Twin View features for channels coming through the cable box to the TV's AUX input jack. For example, when you switch the TV's input to AUX — to select the cable box input — the picture displays only in the left window. If you turn on Twin View, you can watch cable channels coming into the VHF/UHF jack in the right window, but you cannot SWAP the pictures between the left and right windows.

For details about Twin View, see page 46.

To connect the cable box and cable

- 1 Connect the cable from your cable company to the TV's VHF/UHF jack.
- 2 Use a coaxial cable to connect the TV's TO CONVERTER jack to the cable box's input jack. (The TV's internal converter lets you switch between unscrambled signals coming straight into the TV and scrambled signals coming in through the cable box, eliminating the need for an external splitter.)
- 3 Use a coaxial cable to connect the cable box's output jack to the TV's AUX jack.
- 4 Run the Auto Setup program, as described in "Setting Up the Channel List" on page 38.

If you have a digital cable box, you cannot use this connection because the TO CONVERTER jack is not compatible with digital cable boxes.

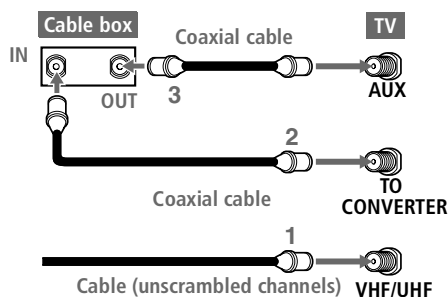

Notes on Using This Connection

To Do This ...	Do This ...
Use the cable box	Tune the TV to the channel the cable box is set to (usually channel 3 or 4) and then use the cable box to switch channels.
Set up the TV remote control to operate the cable box	Program the remote control. See "Programming the Remote Control" on pages 43-44.
Activate the remote control to operate the cable box	Press SAT/CABLE FUNCTION.
Prevent the accidental switching of TV channels	When using the cable box, you need the TV to stay on the channel the cable box is set to (usually channel 3 or 4). You can use the TV's Channel Fix feature to lock in a specific channel. For details, see "Using the Channel Menu" on page 68.
Switch the TV's input between the cable box and cable	Press ANT to switch back and forth between the TV's VHF/UHF (unscrambled channels) and AUX (scrambled) inputs.

Cable Box Only

For best results, use this connection if:

- Your cable company scrambles all channels, which requires you to use a cable box.
- You do not have a VCR. (If you have a VCR, see pages 22 and 24.)

With this connection you can:

- Use the TV remote control to change channels coming through the cable box to the TV's VHF/UHF jack. (You must first program the remote control for your specific cable box.)

About Using Twin View with This Connection

With this connection, all channels come into the TV through your cable box and only one unscrambled signal is sent to the TV, so you cannot use the Twin View feature. If some of your channels are scrambled, but others are not, consider using the "Cable Box and Cable" connection on page 18 instead. For details about Twin View, see page 46.

To connect the cable box

- 1 Connect the CATV cable to the cable box's input jack.
- 2 Use a coaxial cable to connect the cable box's output jack to the TV's VHF/UHF jack.
- 3 Run the Auto Setup program, as described in "Setting Up the Channel List" on page 38.

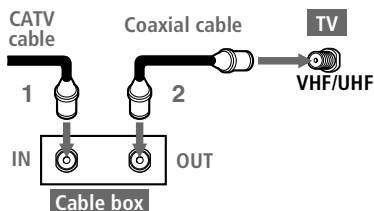

Notes on Using This Connection

To Do This ...	Do This ...
Use the cable box	Tune the TV to the channel the cable box is set to (usually channel 3 or 4) and then use the cable box to switch channels.
Set up the TV remote control to operate the cable box	Program the remote control. See "Programming the Remote Control" on pages 43-44.
Activate the remote control to operate the cable box	Press SAT/CABLE FUNCTION.
Prevent the accidental switching of TV channels	When using the cable box, you need the TV to stay on the channel the cable box is set to (usually channel 3 or 4). You can use the TV's Channel Fix feature to lock in a specific channel. For details, see "Using the Channel Menu" on page 68.

Connecting Optional Equipment

Use the directions in this section to connect the following optional equipment:

If You Are Connecting	See Page
VCR and Cable	22
VCR and Cable Box	24
Two VCRs for Tape Editing	26
Satellite Receiver	28
Satellite Receiver and VCR	30
DVD Player with Component Video Connectors	32
DVD Player with S VIDEO and Audio Connectors	34
Camcorder	35
Audio Receiver	36

About Using S VIDEO



If the optional equipment you are connecting has an S VIDEO jack (shown at left), you can use an S VIDEO cable for improved picture quality (compared to an A/V cable). Because S VIDEO carries only the video signal, you also need to connect audio cables for sound, as shown below.

Example of an S VIDEO Connection

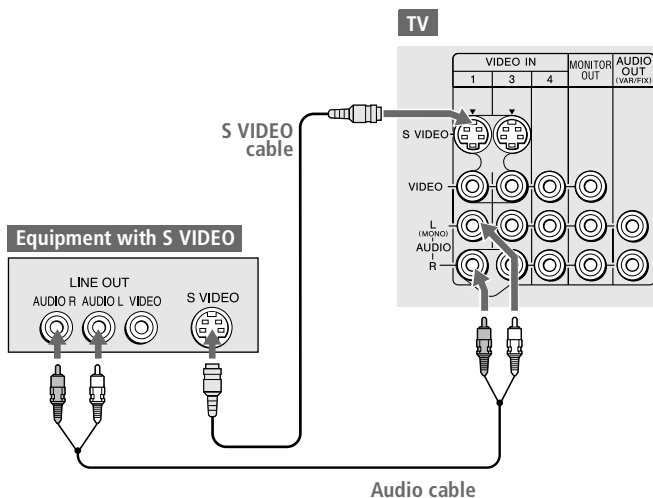

Cables are often color-coded to connectors. Connect red to red, white to white, etc.

VCR and Cable

For best results, use this connection if:

- ❑ Your cable company does not require you to use a cable box.

About Using Twin View with This Connection

With this connection, you can use all the features of Twin View. For details about Twin View, see page 46.

To connect the VCR and cable

- 1 Connect the CATV cable to the VCR's VHF/UHF input jack.
- 2 Use a coaxial cable to connect the VCR's VHF/UHF output jack to the TV's VHF/UHF jack.
- 3 Use an A/V cable to connect the VCR's A/V output jacks to the TV's A/V input jacks.
- 4 Run the Auto Setup program, as described in "Setting Up the Channel List" on page 38.



Using
S VIDEO jacks?
See page 21.

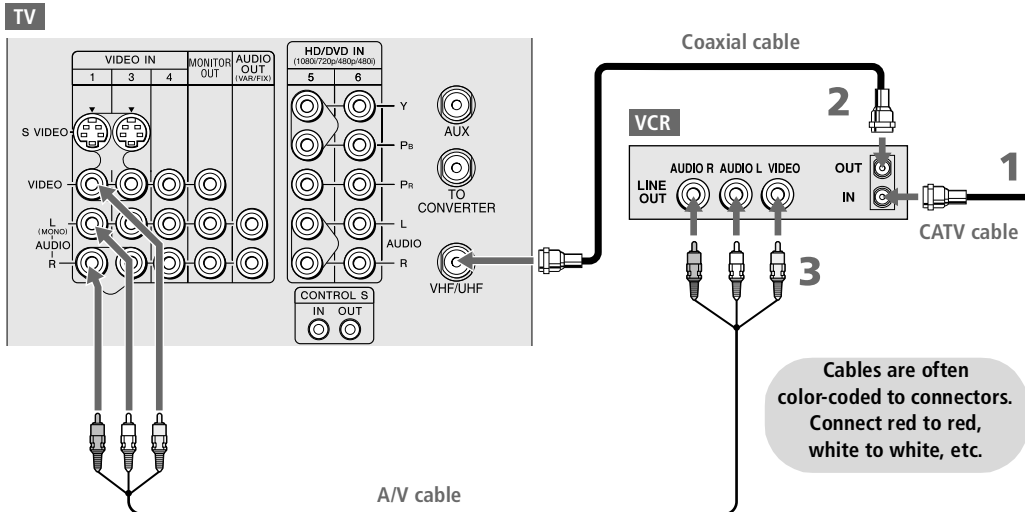

Notes on Using This Connection

<i>To Do This ...</i>	<i>Do This ...</i>
Watch the VCR	Press TV/VIDEO repeatedly to select the VCR input (VIDEO 1 in the illustration).
Watch cable channels	Press TV/VIDEO repeatedly to select the cable input (VHF/UHF in the illustration).
Set up the TV remote control to operate the VCR	If you have a non-Sony VCR, you must program the remote control. See "Programming the Remote Control" on pages 43-44.
Activate the TV remote control to operate the VCR	Set the A/V slide switch to the position you programmed for the VCR. Then press VCR/DVD FUNCTION.
Control VCR functions with the TV remote control	See "Operating a VCR" on page 60.
Label video inputs to easily identify equipment connected to the TV	See the instructions for setting up Video Labels on pages 74-75.

VCR and Cable Box

For best results, use this connection if:

- ❑ Your cable company scrambles some channels, such as premium channels (which requires you to use a cable box), but does not scramble all channels.

About Using Twin View with This Connection

With this connection, you can use all the features of Twin View. For details about Twin View, see page 46.

With this connection you can:

- ❑ Use the TV remote control to change channels coming through the cable box. (You must first program the remote control for your specific cable box; see “Programming the Remote Control” on page 43.)
- ❑ Use the TV remote control to change channels coming directly into the TV’s VHF/UHF jack. (The TV’s tuner provides a better signal than the cable box.)
- ❑ Record channels coming through the cable box and channels coming directly into the TV.

To connect a VCR and cable box, you need:

- ❑ A splitter, which is a small, inexpensive device that you can purchase at your local electronics store.

 **DIGITAL CABLE BOX USERS: If you are connecting a digital cable box, you will need a special bi-directional splitter that is designed to work with your digital cable box. Contact your cable provider for details.**

- ❑ Three coaxial cables.
- ❑ One A/V cable or one S VIDEO cable with audio cables.

To connect the VCR and cable box

- 1 Connect the CATV cable to the single (input) jack of the splitter.
- 2 Use a coaxial cable to connect one of the splitter’s two output jacks to the TV’s VHF/UHF jack.
- 3 Use a coaxial cable to connect the splitter’s other output jack to the cable box’s input jack.
- 4 Use a coaxial cable to connect the cable box’s output jack to the VCR’s RF input jack.
- 5 Use an A/V cable to connect the VCR’s A/V output jacks to the TV’s A/V input jacks.
- 6 Run the Auto Setup program, as described in “Setting Up the Channel List” on page 38.



Using
S VIDEO jacks?
See page 21.

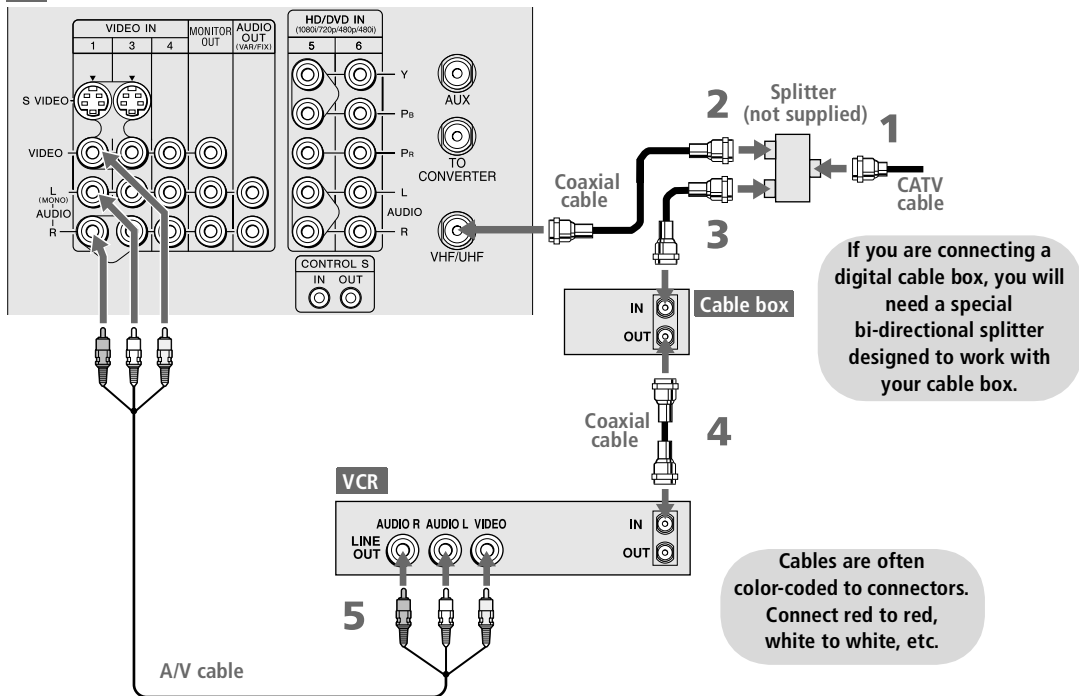

Notes on Using This Connection

To Do This ...	Do This ...
Watch cable (unscrambled) channels	Press TV/VIDEO repeatedly to select the cable input (UHF/VHF in the illustration).
Watch cable box (scrambled) channels	Turn on the VCR and tune it to the channel the cable box is set to (usually channel 3 or 4). Press TV/VIDEO repeatedly to select the VCR input (VIDEO 1 in the illustration). Use the cable box to change channels.
Watch the VCR	Press TV/VIDEO repeatedly to select the VCR input (VIDEO 1 in the illustration).
Set up the TV remote control to operate the cable box or VCR	If you have a non-Sony VCR, you must program the remote control. See "Programming the Remote Control" on pages 43-44.
Activate the remote control to operate the cable box or VCR	For the cable box, press SAT/CABLE FUNCTION. For the VCR, set the A/V slide switch to the position you programmed for the VCR. Then press VCR/DVD FUNCTION.
Control specific cable box and VCR functions with the TV remote control	See "Operating a Cable Box" on page 61 and "Operating a VCR" on page 60.
Label video inputs to easily identify equipment connected to the TV	See the instructions for setting up Video Labels on pages 74-75.

Two VCRs for Tape Editing



Using
S VIDEO jacks?
See page 21.

Connecting two VCRs lets you record from one VCR to the other. By connecting them as shown below, you can view (monitor) what is being recorded.

To connect two VCRs for tape editing

- 1 Use an A/V cable to connect the playback VCR's A/V output jacks to the TV's A/V input jacks.
- 2 Use an A/V cable to connect the recording VCR's A/V input jacks to the TV's MONITOR OUT jacks.

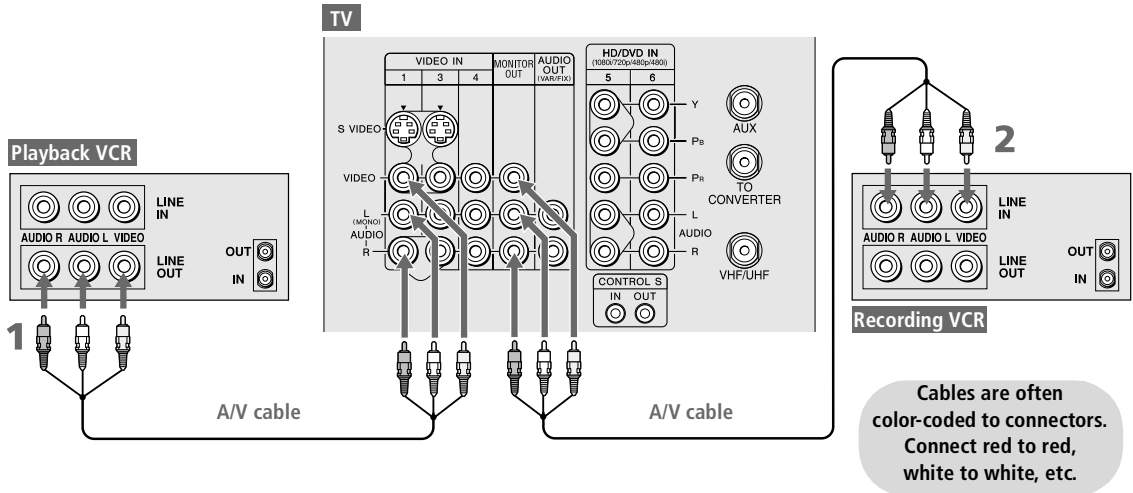

Notes on Using This Connection

<i>To Do This ...</i>	<i>Do This ...</i>
View (monitor) what is being recorded	Press TV/VIDEO repeatedly to select the VCR input (VIDEO 1 in the illustration above).
Set up the TV remote control to operate the VCR(s)	If you have a non-Sony VCR, you must program the remote control. See "Programming the Remote Control" on pages 43-44.
Activate the TV remote control to operate the VCR(s)	Set the A/V slide switch to the position you programmed for the VCR. Then press VCR/DVD FUNCTION.
Control VCR functions with the TV remote control	See "Operating a VCR" on page 60.
Label video inputs to easily identify equipment connected to the TV	See the instructions for setting up Video Labels on pages 74-75.

Satellite Receiver



Using
S VIDEO jacks?
See page 21.

To connect a satellite receiver

- 1 Connect the satellite antenna cable to the satellite receiver's satellite input jack.
- 2 Use an A/V cable to connect the satellite receiver's A/V output jacks to the TV's A/V input jacks.
- 3 Connect a CATV cable from your cable or antenna to the TV's VHF/UHF jack.
- 4 Run the Auto Setup program, as described in "Setting Up the Channel List" on page 38.

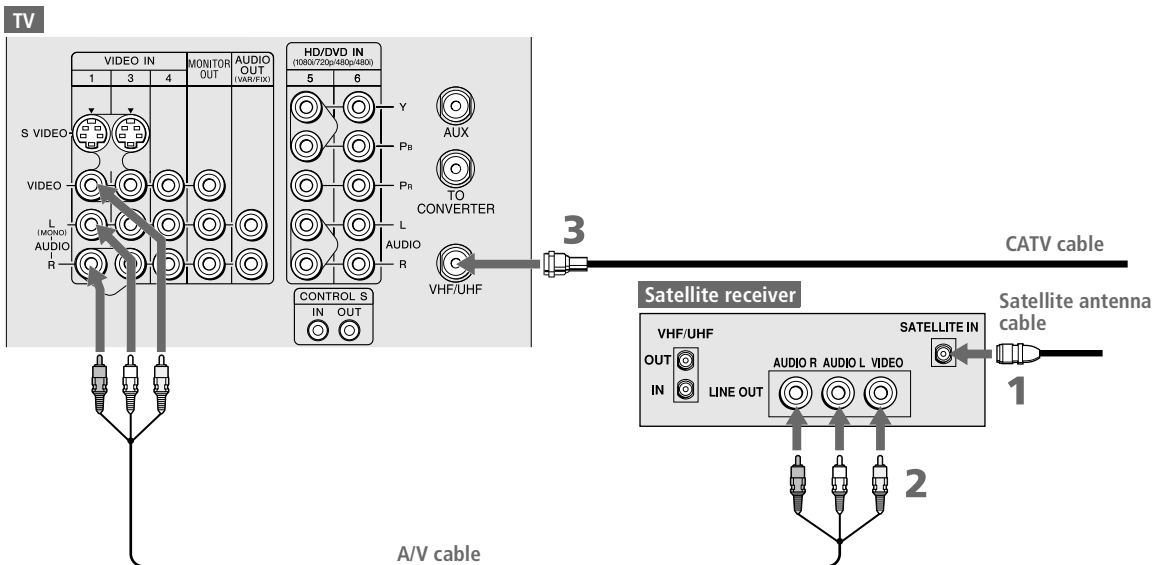

Cables are often color-coded to connectors. Connect red to red, white to white, etc.

Notes on Using This Connection

<i>To Do This ...</i>	<i>Do This ...</i>
Watch the satellite receiver	Press TV/VIDEO repeatedly to select the satellite receiver input (VIDEO 1 in the illustration).
Set up the TV remote control to operate the satellite receiver	If you have a non-Sony satellite receiver, you must program the remote control. See "Programming the Remote Control" on pages 43-44.
Activate the TV remote control to operate the satellite receiver	Press SAT/CABLE FUNCTION.
Control satellite receiver functions with the TV remote control	See "Operating a Satellite Receiver" on page 60.
Label video inputs to easily identify equipment connected to the TV	See the instructions for setting up Video Labels on pages 74-75.

Satellite Receiver and VCR



Using
S VIDEO jacks?
See page 21.

To connect a satellite receiver and VCR

- 1 Connect the satellite antenna cable to the satellite receiver's satellite input jack.
- 2 Connect the CATV cable to the VCR's VHF/UHF input jack.
- 3 Use a coaxial cable to connect the VCR's VHF/UHF output jack to the TV's VHF/UHF jack.
- 4 Use an A/V cable to connect the satellite receiver's A/V output jacks to the VCR's A/V input jacks.
- 5 Use an A/V cable to connect the VCR's A/V output jacks to the TV's A/V input jacks.
- 6 Run the Auto Setup program, as described in "Setting Up the Channel List" on page 38.

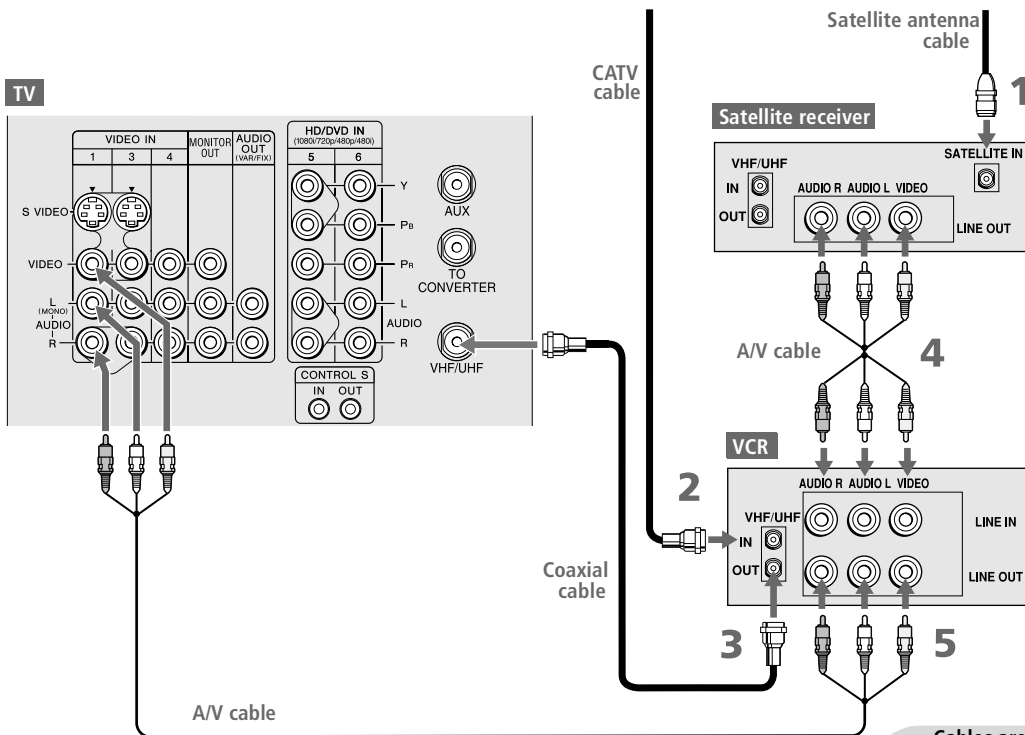

Cables are often color-coded to connectors. Connect red to red, white to white, etc.

Notes on Using This Connection

<i>To Do This ...</i>	<i>Do This ...</i>
Watch the satellite receiver	Press TV/VIDEO repeatedly to select the VCR input (VIDEO 1 in the illustration). The VCR may need to be turned on and set to the satellite receiver input.
Watch the VCR	Press TV/VIDEO repeatedly to select the input to which the VCR is connected (VIDEO 1 in the illustration).
Set up the TV remote control to operate the satellite receiver or VCR	If you have a non-Sony VCR or satellite receiver, you must program the remote control. See "Programming the Remote Control" on pages 43-44.
Activate the TV remote control to operate the satellite receiver or VCR	For the satellite receiver, press SAT/CABLE FUNCTION. For the VCR, set the A/V slide switch to the position you programmed for the VCR. Then press VCR/DVD FUNCTION.
Control satellite receiver and VCR functions with the TV remote control	See "Operating a Satellite Receiver" on page 60 and "Operating a VCR" on page 60.
Label video inputs to easily identify equipment connected to the TV	See the instructions for setting up Video Labels on pages 74-75.

DVD Player with Component Video Connectors

For best results, use this connection if your DVD player has component video (Y, PB, PR) jacks.

To connect a DVD player with component video connectors

- 1 Use three separate component video cables to connect the DVD player's Y, PB and PR jacks to the Y, PB and PR jacks (VIDEO 5) on the TV.

 The Y, PB and PR jacks on your DVD player are sometimes labeled Y, CB and CR, or Y, B-Y and R-Y. If so, connect the cables to like colors.

- 2 Use an audio cable to connect the DVD player's audio output jacks to the TV's VIDEO 5 audio input jacks.

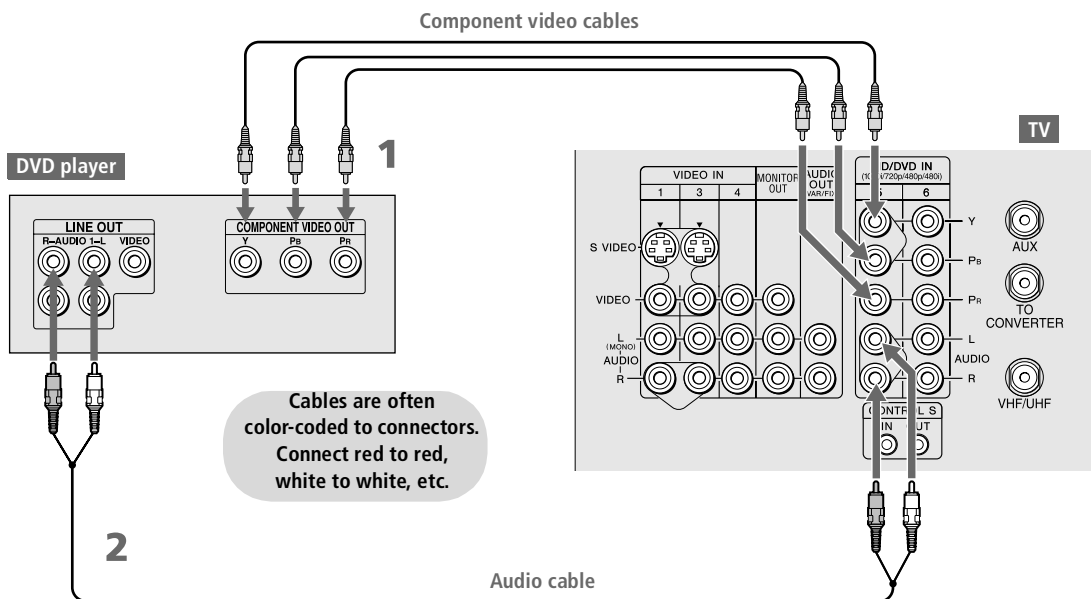

Notes on Using This Connection

To Do This ...	Do This ...
Watch the DVD player	Press TV/VIDEO repeatedly to select the DVD input (VIDEO 5 in the illustration).
Set up the TV remote control to operate the DVD player	If you have a non-Sony DVD player, you must program the remote control. See "Programming the Remote Control" on pages 43-44.
Activate the TV remote control to operate the DVD player	Set the A/V slide switch to the position you programmed for the DVD player. Then press VCR/DVD FUNCTION.
Control DVD functions with the TV remote control	See "Operating a DVD Player" on page 61.
Label video inputs to easily identify equipment connected to the TV	See the instructions for setting up Video Labels on pages 74-75.

 **You cannot record the signal from any equipment connected into the Y, PB, PR jacks.**

DVD Player with S VIDEO and Audio Connectors

Use this connection if your DVD player does not have component video (Y, Pb, Pr) jacks.

To connect a DVD player with A/V connectors

- 1 Use an audio cable to connect the DVD player's audio output jacks to the TV's audio input jacks.
- 2 Use an S VIDEO cable to connect the DVD player's S VIDEO jack to the TV's S VIDEO jack.

Cables are often color-coded to connectors. Connect red to red, white to white, etc.

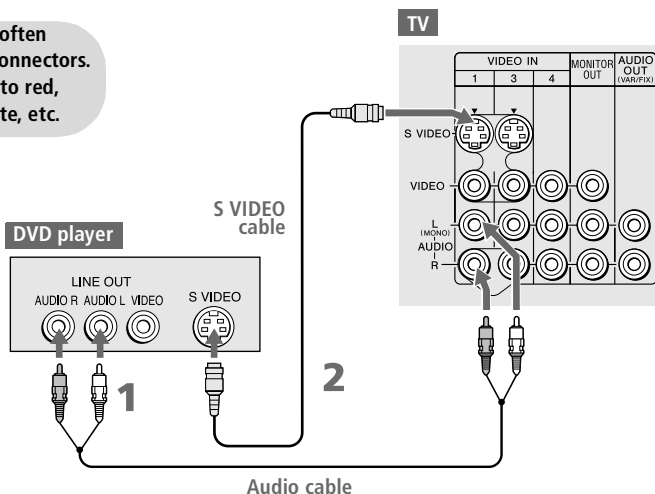

Notes on Using This Connection

To Do This ...	Do This ...
Watch the DVD player	Press TV/VIDEO repeatedly to select the DVD input (VIDEO 1 in the illustration).
Set up the TV remote control to operate the DVD player	If you have a non-Sony DVD player, you must program the remote control. See "Programming the Remote Control" on pages 43-44.
Activate the TV remote control to operate the DVD player	Set the A/V slide switch to the position you programmed for the DVD player. Then press VCR/DVD FUNCTION.
Control DVD functions with the TV remote control	See "Operating a DVD Player" on page 61.
Label video inputs to easily identify equipment connected to the TV	See the instructions for setting up Video Labels on pages 74-75.

Camcorder



Using
S VIDEO jacks?
See page 21.

For easy connection of a camcorder, the TV has front A/V input jacks. If you prefer, however, you can connect the camcorder to the TV's rear A/V input jacks.

To connect a camcorder

- 1 Use A/V cables to connect the camcorder's A/V output jacks to the TV's A/V input jacks.

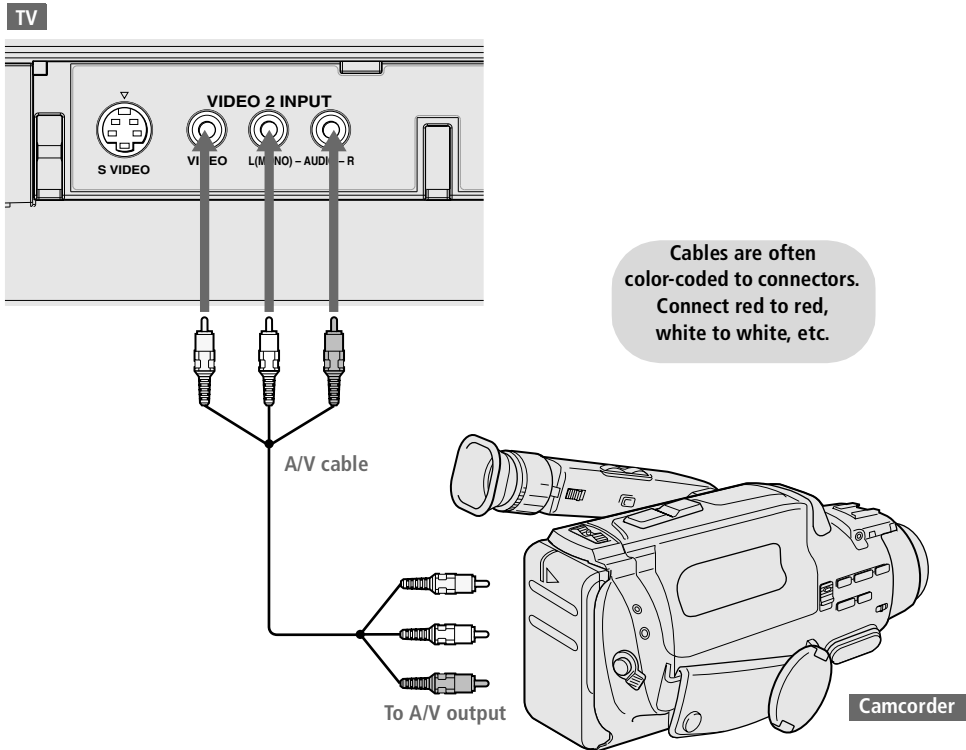

If you have a mono camcorder, connect its audio output jack to the TV's L MONO audio jack.

Note on Using This Connection

To Do This ...

Watch the camcorder

Label video inputs to easily identify equipment connected to the TV

Do This ...

Press TV/VIDEO repeatedly to select the camcorder input (VIDEO 2 in the illustration).

See the instructions for setting up Video Labels on pages 74-75.

Audio Receiver

For improved sound quality, you may want to play the TV's audio through your stereo system.

To connect an audio system

- 1 Use an audio cable to connect the TV's audio output jacks to the audio receiver's line input jacks.

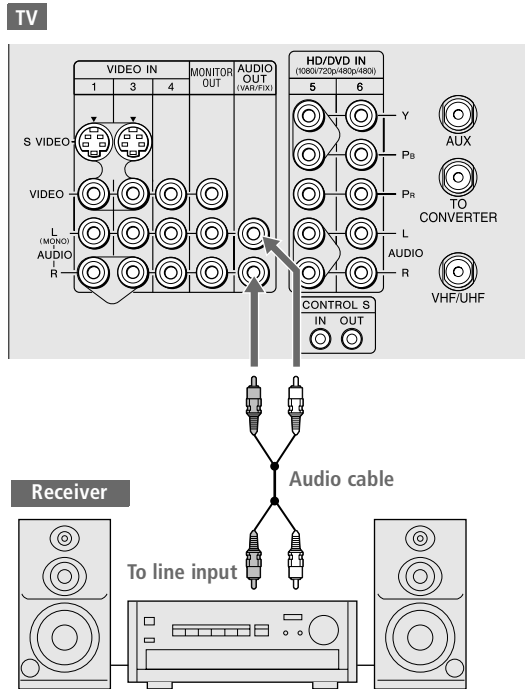

- 2 Using the TV's Audio Menu, set the Speaker option to Off. Then set the Audio Out option to Fixed or Variable, depending on how you want to control the volume. For details, see "Using the Audio Menu" on page 66.
- 3 Turn on the audio receiver, and then set the receiver's line input to the jack into which you connected the TV.

Using the CONTROL S Feature

CONTROL S allows you to control your system and other Sony equipment with one remote control. In addition to allowing you to control multiple devices with one remote control, the CONTROL S feature allows you to always point your remote control at your TV, instead of having to point it at the other equipment, which might be hidden or out of direct line of sight.

Use CONTROL S IN to send signals to the TV.

Use CONTROL S OUT to send signals to connected equipment.

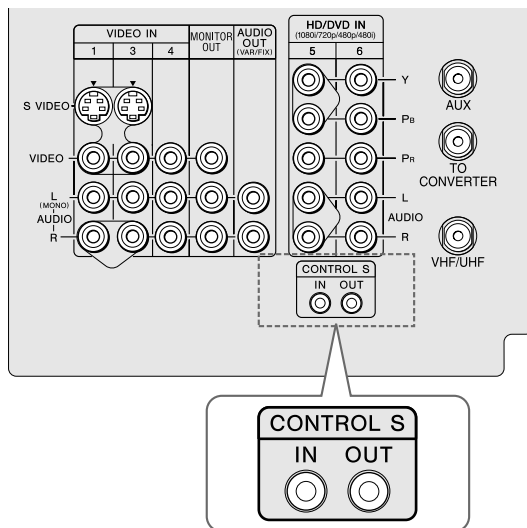

Setting Up the Channel List

After you finish connecting your TV, you need to run Auto Setup to set up your channels. The Auto Setup screen appears when you turn on your TV for the first time after hooking it up. If you do not want to set up the channels at this time, you can do it later by selecting the Auto Program option in the Channel Menu (see page 68).

 **The Auto Setup feature does not apply for installations that use a cable box for all channel selection.**

Using Auto Setup

- 1 Press **POWER** to turn on the TV.
- 2 Press **TV FUNCTION** on the remote control.
- 3 To continue running Auto Setup, press **CH+**. To exit Auto Setup, press **CH-**.

Auto Setup automatically creates a list of receivable channels. When finished, the lowest numbered channel is displayed.

To reset the TV to factory settings

- 1 Press **POWER** to turn on the TV.
- 2 Hold down **RESET** on the remote control.
- 3 Press **TV POWER** on the TV. (The TV will turn itself off, then back on.)
- 4 Release **RESET**.

Using the Remote Control

Overview

This chapter describes how to set up, program, and use the TV's remote control.

Topic	Page
Inserting Batteries	39
Button Descriptions	
Outside Panel	40
Inside Panel	42
Programming the Remote Control	43

Inserting Batteries

- 1 Remove the battery cover from the remote control.
- 2 Insert two size AA (R6) batteries (supplied) by matching the **+** and **-** terminals on the batteries to the diagram inside the battery compartment.
- 3 Replace the battery cover.

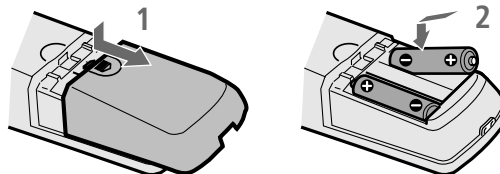



 Remove the batteries to avoid damage from possible battery leakage whenever you anticipate that the remote control will not be used for an extended period. Handle the remote control with care. Avoid dropping it, getting it wet, placing it in direct sunlight, near a heater, or where the humidity is high.

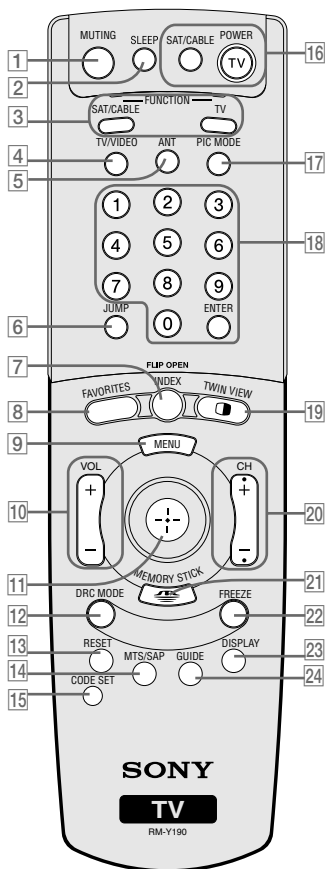

Button Descriptions

Outside Panel

Remote Control



Button	Description
1 MUTING	Press to mute the sound. Press again or press VOL+ to restore the sound.
2 SLEEP	Press repeatedly until the TV displays the time in minutes (15, 30, 45, 60, or 90) that you want the TV to remain on before shutting off automatically. To cancel press until Sleep Off appears. While the Sleep feature is set, press once to display the remaining time.
3 FUNCTION Buttons	The indicator lights up momentarily when pressed to show which equipment the remote control is operating: SAT/CABLE: Press to have the remote control operate the satellite receiver or cable box. TV: Press to have the remote control operate the TV.
4 TV/VIDEO	Press repeatedly to cycle through the video equipment connected to the TV's video inputs.
5 ANT	Press to switch between the sources connected to the TV's VHF/UHF and AUX inputs.
6 JUMP	Press to jump back and forth between two channels. The TV alternates between the current channel and the last channel that was selected.
7 INDEX	Press to display the Scrolling Index. For details, see page 46.
8 FAVORITES	Press to display the Favorite Channels list. For details, see page 50.
9 MENU	Press to display the Menu. Press again to exit from the Menu. For details, see "Using the Menus" on page 63.
10 VOL +/-	Press to adjust the volume.
11 	Move the joystick $\uparrow \downarrow \leftarrow \rightarrow$ to move the on-screen cursor. To select an item, press the center of the joystick (\oplus).
12 DRC MODE	Press repeatedly to cycle through the available high-resolution picture modes: Interlaced, Progressive, CineMotion. Also available in the Video Menu. For details, see "Selecting Video Options" on pages 64-65.
13 RESET	Press to reset the settings to the factory defaults. See pages 64, 66, and 73. Also used to clear Favorite Channels (see page 50).
14 MTS/SAP	Press repeatedly to cycle through the Multi-channel TV Sound (MTS) options: Stereo, Auto SAP (Second Audio Program), and Mono. Also available in the Audio Menu. For details, see "Using the Audio Menu" on page 66.

Button	Description
15 CODE SET	Press to program the remote control to operate non-Sony video equipment. For details, see "Programming the Remote Control" on page 43.
16 POWER Buttons	SAT/CABLE: Press to turn on and off the satellite receiver or cable box. TV: Press to turn on and off the TV.
17 PIC MODE	Press repeatedly to cycle through the available video picture modes: Vivid, Standard, Movie, Pro. Also available in the Video Menu. For details, see "Selecting Video Options" on pages 64-65.
18 0 - 9 ENTER	Press 0 - 9 to select a channel; the channel changes after 3 seconds. Press ENTER to change channels immediately.
19 TWIN VIEW 	Press to turn on and off Twin View. For details, see pages 47-49.
20 CH +/-	Press to scan through channels. To scan quickly through channels, press and hold down either CH button.
21 MEMORY STICK 	Press to display the Memory Stick Menu. For details, see "Using the Memory Stick Picture Viewer" on page 52.
22 FREEZE	Press to freeze the picture. Press again to restore the picture. For details, see page 51.
23 DISPLAY	Press once to display the current channel number, current time, and channel label (if set). Press again to turn Display off.
24 GUIDE	Press to display the program guide of your satellite program provider.

Inside Panel

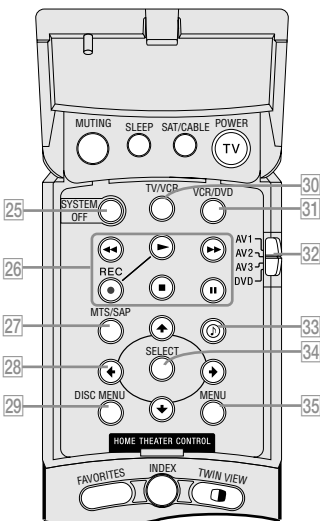
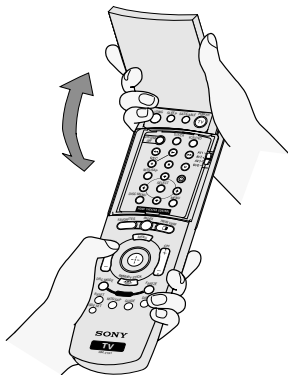

To access the inside panel, open the outside cover as shown.

Button	Description
25 SYSTEM OFF	Press to turn off all Sony brand audio/video equipment at once. (May not function with older Sony equipment.)
26 Transport Buttons	◀◀ Rewind ▶▶ Play ● Record (press together with ▶) ■ Stop ▶▶ Fast forward Pause
27 MTS/SAP	Press repeatedly to cycle through the Multi-channel TV Sound (MTS) options: Stereo, Auto SAP (Second Audio Program), and Mono. Also available in the Audio Menu. For details, see "Using the Audio Menu" on page 66.
28 ⬆ ⬇ ⬅ ➡	Press ⬆ ⬇ ⬅ ➡ to move the VCR or DVD player's on-screen cursor.
29 DISC MENU	Press to display the DVD Menu.
30 TV/VCR	Press to change to the VHF/UHF output of the VCR.
31 VCR/DVD	Press to turn on and off the VCR or DVD player.
32 AV1/2/3/DVD Slide Switch	Use the A/V slide switch to control connected video equipment. You can program one video source for each switch position. For details, see "Programming the Remote Control" on page 43.
33 Ⓜ	Press repeatedly to step through the Audio Effect options. Also available in the Audio Menu. For details, see page 66.
34 SELECT	Press to select an item in the VCR or DVD player's menu.
35 MENU	Press to display the DVD player setup menu.

Programming the Remote Control

The remote control is preset to operate Sony brand video equipment.

Sony Equipment	Switch Position on Remote Control	Programmable Code Number
Beta, ED Beta VCRs	AV1	303
8 mm VCR	AV2	302
VHS VCR	AV3	301
DVD player	DVD	751

If you have video equipment other than Sony brand that you want to control with the TV's remote control, use the following procedure to program the remote control.

 **The equipment must have infrared (IR) remote capability in order to be used with the remote control.**



- If more than one code number is listed, try entering them one by one until you come to the correct code for your equipment.
- If you enter a new code number, the code number you previously entered at that setting is erased.
- In some cases, you may not be able to operate your equipment with the supplied remote control. In such cases, use the equipment's own remote control unit.
- Whenever you remove the batteries to replace them, the code numbers may revert to the factory setting and must be reset.

- 1 Turn to the list of "Manufacturer's Codes" on page 44, and find the three-digit code number for the manufacturer of your equipment. (If more than one code number is listed, use the number listed first.)
- 2 Set the A/V slide switch to 1, 2, 3, or DVD.
- 3 Press CODE SET.
- 4 Enter the three-digit manufacturer's code number.
- 5 Press ENTER.

 **You must do step 5 within 10 seconds of step 4, or you must redo steps 3 through 5.**

- 6 To check if the code number works, aim the TV's remote control at the equipment and press the POWER button that corresponds with that equipment. If it responds, you are done. If not, try using another code listed for that manufacturer.

Manufacturer's Codes

VCRs

<i>Manufacturer</i>	<i>Code</i>
Sony	301, 302, 303
Admiral (M. Ward)	327
Aiwa	338, 344
Audio	314, 337
Dynamic	
Broksonic	319, 317
Canon	309, 308
Citizen	332
Craig	302, 332
Criterion	315
Curtis Mathes	304, 338, 309
Daewoo	341, 312, 309
DBX	314, 336, 337
Dimensia	304
Emerson	319, 320, 316, 317, 318, 341
Fisher	330, 335
Funai	338
General Electric	329, 304, 309
Go Video	322, 339, 340
Goldstar	332
Hitachi	306, 304, 305, 338
Instant Replay	309, 308
JC Penney	309, 305, 304, 330, 314, 336, 337
JVC	314, 336, 337, 345, 346, 347
Kenwood	314, 336, 332, 337
LXI (Sears)	332, 305, 330, 335, 338
Magnavox	308, 309, 310
Marantz	314, 336, 337
Marta	332
Memorex	309, 335
Minolta	305, 304
Mitsubishi/ MGA	323, 324, 325, 326
Multitech	325, 338, 321
NEC	314, 336, 337
Olympic	309, 308
Optimus	327

<i>Manufacturer</i>	<i>Code</i>
Orion	317
Panasonic	308, 309, 306, 307
Pentax	305, 304
Philco	308, 309
Philips	308, 309, 310
Pioneer	308
Quasar	308, 309, 306
RCA/ PROSCAN	304, 305, 308, 309, 311, 312, 313, 310, 329
Realistic	309, 330, 328, 335, 324, 338
Sansui	314
Samsung	322, 313, 321
Sanyo	330, 335
Scott	312, 313, 321, 335, 323, 324, 325, 326
Sharp	327, 328
Signature 2000 (M. Ward)	338, 327
SV2000	338
Sylvania	308, 309, 338, 310
Symphonic	338
Tashiro	332
Tatung	314, 336, 337
Teac	314, 336, 338, 337
Technics	309, 308
Toshiba	312, 311
Wards	327, 328, 335, 331, 332
Yamaha	314, 330, 336, 337
Zenith	331

Laserdisc Players

<i>Manufacturer</i>	<i>Code</i>
Sony	701
Panasonic	704, 710
Pioneer	702

DVD Players

<i>Manufacturer</i>	<i>Code</i>
Sony	751
General Electric	755
Hitachi	758
JVC	756
Magnavox	757
Mitsubishi	761
Oritron	759
Panasonic	753
Philips	757
Pioneer	752
RCA/Proscan	755
Samsung	758
Toshiba	754
Zenith	760

Cable Boxes

<i>Manufacturer</i>	<i>Code</i>
Sony	230
Hamlin/Regal	222, 223, 224, 225, 226
Jerrold/G.I./ Motorola	201, 202, 203, 204, 205, 206, 207, 208, 218
Oak	227, 228, 229
Panasonic	219, 220, 221
Pioneer	214, 215
Scientific	209, 210, 211
Atlanta	
Tocom	216, 217
Zenith	212, 213

Satellite Receivers

<i>Manufacturer</i>	<i>Code</i>
Sony	801
Dish Network	810
Echostar	810
General Electric	802
Hitachi	805
Hughes	804
Mitsubishi	809
Panasonic	803
RCA/ PROSCAN	802, 808
Toshiba	806, 807

Using the Features

Overview

This chapter describes how to use the features of your TV.

<i>Topic</i>	<i>Page</i>
Watching TV	45
Using the Scrolling Index	46
Using Twin View	47
Using Favorite Channels	50
Using the Freeze Function	51
Using the Memory Stick Picture Viewer	52
Using Other Equipment with Your TV Remote Control	60

Watching TV

 For a complete list of all the functions of the remote control, see pages 39-44.

<i>To Do This ...</i>	<i>Do This ...</i>
Activate the remote control to operate the TV	Press TV FUNCTION
Turn on/off the TV	Press TV POWER
Tune directly to a channel	Press 0-9 and then ENTER (or wait 3 seconds) or Press CH+/-
Adjust the volume	Press VOL +/-
Mute the sound	Press MUTING (press again to unmute)
Alternate back and forth between two channels	Press JUMP The TV alternates between the current channel and the last channel tuned.
Display the current channel number (and other information)	Press DISPLAY once to display the channel number and current time and channel label (if set). Press DISPLAY again to turn Display off.
Switch the TV's input to the VCR, DVD player, or other connected equipment	Press TV/VIDEO repeatedly to cycle through the video equipment connected to the TV's video inputs.
Change video and audio options, customize the TV's setup, set parental controls, and more	Press MENU to display the Menu. For details, see "Using the Menus" on page 63.
Switch the TV's input between sources connected to the TV's VHF/UHF and AUX inputs	Press ANT to alternate between sources connected to the TV's VHF/UHF and AUX inputs.

Using the Scrolling Index

The Scrolling Index lets you select programs from a series of preview windows that scroll along the right side of the screen.

- 1 Press INDEX.

The Scrolling Index appears, with the currently selected program in the main (left) window, and four scrolling video pictures in the right.



As each picture on the right scrolls to the live preview window, it changes briefly from a frozen video picture to a live video. The right side continues to scroll through the entire channel list.

- 2 To change the direction of the scrolling, move the joystick \uparrow or \downarrow .
- 3 To change the speed of the scrolling, move and hold the joystick \uparrow or \downarrow .
- 4 To change a frozen video picture to a live video, move the joystick \uparrow or \downarrow to highlight the picture, then press \odot .
- 5 To move the live video (from step 4) from the right to the main (left) window of the Scrolling Index, press \oplus again.

To exit the Scrolling Index

- Press INDEX.

Factors Affecting Scrolling Index

- Scrolling Index does not function if you use a cable box to view all channels.
- Sources connected to the AUX, VIDEO 5, VIDEO 6, and VIDEO 7 inputs display in the left window, but not the right windows.
- Scrolling Index does not function if parental controls are set (see page 70).

Using Twin View

Twin View lets you see two pictures from two sources — from an antenna, VCR, DVD, etc., — on the screen at the same time. You hear the sound from only one of the sources at a time, but you can choose which source's sound is selected. You can also change the relative size of each of the pictures.



Displaying Twin Pictures

- 1 Tune the TV to a working channel.
- 2 Press .

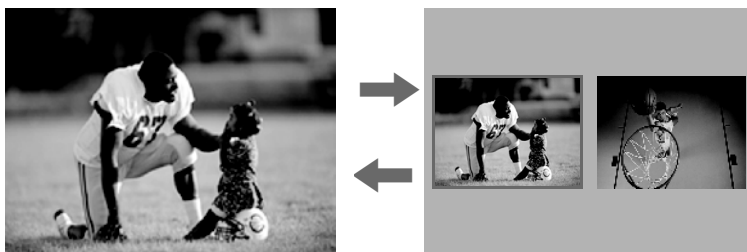
A second picture appears. The active picture is highlighted in blue.



To cancel Twin View and watch the active picture

- Press  or .

Factors Affecting Twin View

- If you use a cable box to view all channels, the same channel appears in both windows of Twin View because the cable box unscrambles only one channel at a time.
- If you use a cable box, you can view the cable box output in one Twin View window and view a different source (such as a VCR or DVD player) in the second window by using the TV/VIDEO button. For details, see “Connecting Optional Equipment” on page 21.
- Sources connected to the AUX, VIDEO 5, VIDEO 6, and VIDEO 7 inputs display in the left Twin View window, but not the right.
- If you are viewing a 4:3 source and a 16:9 enhanced source (such as a DVD) side by side in Twin View, the 4:3 source appears larger.

Activating the Picture

To activate the picture in the right window

☐ Move the joystick ➡.



To activate the picture in the left window

☐ Move the joystick ←.



Functions Available in the Active (Highlighted) Window

To Do This ...	Do This ...
Tune to a channel	Press 0-9 and then ENTER (or wait 3 seconds) or Press CH+/-
Adjust the volume	Press VOL +/-
Mute the sound	Press MUTING (press again to unmute)
Switch the TV's input between sources connected to the TV's VHF/UHF and AUX inputs	Press ANT (left window only)
Switch the TV's input between sources connected to the TV's A/V inputs	Press TV/VIDEO
Change the picture size	Move the joystick ▲ or ▼. (For details, see "Changing the Picture Size" on page 49).

Changing the Picture Size

The zoom feature lets you vary the relative size of the left and right pictures.

- 1 Move the joystick ◀ or ▶ to activate the picture that you want to resize.
- 2 Move the joystick ▲ to enlarge the picture.
- 3 Move the joystick ▼ to make the picture smaller.



When you adjust the picture sizes, the TV memorizes the change. The next time you use the Twin View function, the memorized sizes appear.

Using Favorite Channels

The Favorite Channels feature lets you select programs from a list of up to eight favorite channels that you specify.

Creating a List of Favorite Channels

 For details on using the Channel Menu, see page 68.

- 1 Press **MENU** to display the Menu.
- 2 Move the joystick **←** or **→** to highlight the Channel icon and press **⊕**.
- 3 Move the joystick **↓** to highlight Favorite Channels and press **⊕**.
- 4 Move the joystick **↑** or **↓** to highlight a Favorite Channel number (1-8) and press **⊕**.
- 5 Move the joystick **↑** or **↓** to highlight a channel you want to assign to the Favorite Channel number. A preview of the highlighted channel appears in the upper right of the screen. Press **⊕** to select that channel as a Favorite Channel.
- 6 To add more channels to your favorites list, repeat steps 4-5.
To clear a Favorite Channel, move the joystick **↑** or **↓** to highlight the channel you want to clear. Press **⊕** and then press **RESET**.
- 7 Press **MENU** to exit the Menu.

Displaying a List of Favorite Channels

 To assign Channel Labels (eg., ABC, HBO, MTV, etc.) to channel numbers, as shown at right, use the Channel Label feature in the Channel Menu (see page 69).

- 1 Press **FAVORITES**. The Favorite Channels list appears.

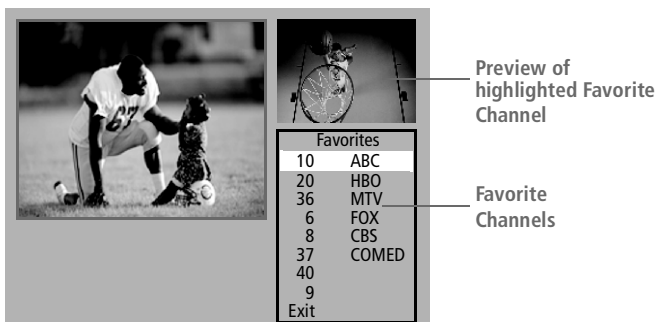

- 2 Move the joystick **↑** or **↓** to highlight the channel you want to watch.
A preview of the highlighted Favorite Channel appears.
- 3 Press **⊕** to select the channel you want to watch.

Using the Freeze Function

The FREEZE button allows you to temporarily capture a program's picture. You can use this feature to write down information such as phone numbers, recipes, etc.

 **The Freeze feature is not available while using Twin View.**

- 1 When the program information you want to capture is displayed, press FREEZE.
- 2 The TV switches to Twin View mode and displays the "frozen" picture on the right, while the current program continues on the left.



- 3 To cancel and return to normal viewing, press FREEZE (or just tune to another channel).

Using the Memory Stick Picture Viewer

About Memory Stick

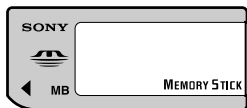

Memory Stick (sold separately) is a new, compact, portable, and versatile Integrated Circuit recording medium with a data capacity that exceeds that of a floppy disk. Memory Stick is specially designed for exchanging and sharing digital data among Memory Stick compatible products such as digital cameras and digital video cameras. Because it is removable, Memory Stick can also be used for external data storage.

 You cannot write to Memory Stick media using the TV.

Memory Stick technology allows you to view on your TV screen digital (JPEG) images that are stored on Memory Stick media. You can choose from an index of the images stored on the Memory Stick, or you can run a slideshow of those images. You can also customize the features of the slideshow by selecting the length of time that each image is displayed, toggling the display of file information, and rotating each image.

For more information about the using Memory Stick media, see “Notes on Using Memory Stick Media” on page 79.

Supported Image Types

This TV’s Memory Stick viewer can display only still images that have been recorded on Memory Stick media by Sony brand digital still and video cameras.

Recorded images must also meet the following specifications:

- Compression format: JPEG
- File name format: DCF compliant

 JPEG stands for “Joint Photographic Experts Group,” which is the organization that implemented this format. DCF stands for “Design Rules for Camera File Systems,” which are specifications established by the Japan Electronic Industry Development Association (JEIDA).

 The TV’s Memory Stick viewer is compatible with Memory Sticks up to and including 128MB. It is not compatible with Memory Sticks that exceed 128MB.

About DCF File Names

Most Sony brand digital still and video cameras automatically record still images using DCF compliant directory and file names, as shown in the following example:

 To ensure that the existing/imported JPEG files are viewable on your TV, be sure to store and maintain them in the DCF compliant file structure shown at right, with the JPEG files inside the 100MSDCF directory, and this directory inside the DCIM main folder.

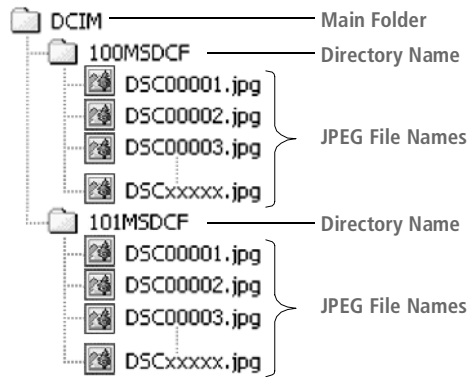

DCF Compliant File Structure Example

Cyber-shot Cameras or Sony Brand Digital Camcorders

If you are using a Sony Cyber-shot camera (except models DSC-D700 and DSC-D770) or a Sony digital camcorder with Digital Still capability (except models DCR-TRV-900 and DSR-PD100A), the pictures on your Memory Stick are ready to be viewed on your TV.

Mavica Cameras

If you are using a Sony Mavica camera, you can view those pictures by first using a PC to transfer the image files to a Memory Stick, and then setting up the files in a DCF compliant file structure as shown above. (Thumbnails, however, will not be available because Mavica does not create them. This also means that the Index and Rotate Picture functions will not work.)

 **Important:** If the source of images is not a Sony digital camera, or the directory/filenames are modified with a computer using non-DCF compliant software, the images may not be viewable on your TV. If you wish to view a DCF compliant image imported to your Memory Stick, be sure to use the same file structure used by Sony cameras (shown above).

Unsupported Image Types

This TV's Memory Stick viewer cannot display any of the following:

- ❑ Images recorded on digital still cameras and digital video cameras that are not Sony brand
- ❑ Images recorded using products that are not DCF compliant, including the following Sony products:

Digital still cameras	DSC-D700, DSC-D770
-----------------------	--------------------

Digital video cameras	DCR-TRV900/DSR-PD100A
-----------------------	-----------------------

- ❑ Images stored in TIFF or any other non-JPEG compression format
- ❑ Images in directories that were renamed on computer
- ❑ Images with a size of less than 16 x 16 or greater than 4096 x 4096
- ❑ Images stored on a Memory Stick that has a capacity that exceeds 128MB

Inserting and Removing a Memory Stick

To insert a Memory Stick

- 1 Locate the Memory Stick slot (see page 10) and insert the Memory Stick into the Memory Stick slot as illustrated below. When inserted properly, it should slide in with little resistance and click into place.

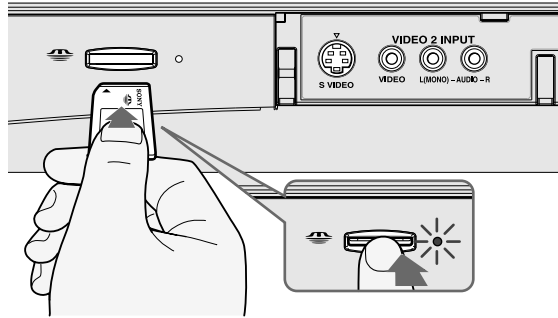

-  **Be sure to insert the Memory Stick in the correct direction. If the Memory Stick is forced in the wrong way, it may become damaged. Do not insert anything other than a Memory Stick into the slot.**

To remove a Memory Stick

- 1 Check that the Memory Stick indicator is off. (When the light is on, this indicates that the TV is reading data from the Memory Stick.)

-  **Removing the Memory Stick while a file is being accessed (when the Memory Stick LED on the TV's front panel is lit) may damage the Memory Stick or its contents.**

- 2 Push the Memory Stick gently into the slot, and then release it. The Memory Stick media is ejected.

-  **Do not pull out the Memory Stick without first pushing it in; otherwise, the TV's locking mechanism may become damaged.**

- 3 Pull the Memory Stick completely out of the slot.

-  **To protect small children from injury from Memory Stick media, remove all Memory Stick media from the TV's Memory Stick slot and store it in a safe location when it is not in use.**

Displaying the Memory Stick Menu

- 1 Insert a Memory Stick that contains the images you want to view. For details, see page 55.
- 2 Press the MEMORY STICK button on the remote control. The Memory Stick Menu appears.

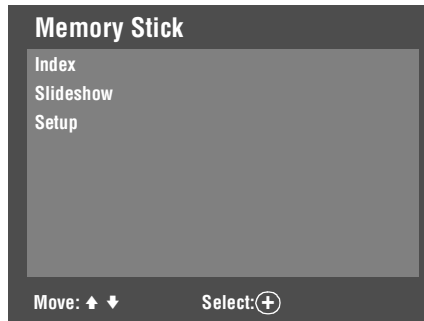

- 3 To select an option, move the joystick to highlight the option and press ⊕.

Option	Description
Index	Displays an index of thumbnail images that are on the Memory Stick. For details, see “Using the Memory Stick Index” on page 57.
Slideshow	Displays a slideshow of images that are on the Memory Stick. For details, see “Using the Memory Stick Slideshow” on page 58.
Setup	Allows you to change slideshow options and rotate images. For details, see “Changing the Memory Stick Setup Options” on page 58.

- 4 To exit the Memory Stick Menu, press CH +/-, TV/VIDEO, ANT, or use the 0-9 buttons and ENTER (or wait 3 seconds) to select a channel.



 **Memory Stick functions are not available while using Twin View, Freeze or Favorite Channel functions.**

Using the Memory Stick Index

The Memory Stick Index lets you view images that are on the Memory Stick in an index of thumbnail images.

 There is no audio signal available while viewing images on Memory Stick.

- 1 Insert a Memory Stick that contains the images you want to view. For details, see page 55.
- 2 Press the MEMORY STICK button on the remote control. The Memory Stick Menu appears.
- 3 Move the joystick to highlight Index and press . The Memory Stick Index appears.





 The Page and folder  buttons are available only if the Memory Stick contains more images or folders than can be displayed on one screen.



The selected image is highlighted in yellow

Information about the selected image

- 4 Move the joystick     to highlight an image and press  to select the image. Selecting an image displays that image at full size. While an image is displayed full size, you can do any of the following:

To Do This ...	Do This ...
Display the previous image	Move the joystick  .
Display the next image	Move the joystick  . If you move the joystick  while viewing the last image, the first image is displayed. If you move the joystick  while viewing the first image, the last image is displayed.
Display the Memory Stick Index	Press  .

- 5 To return to the Memory Stick Menu, move the joystick to Menu \rightarrow and press .

 If a blank square appears instead of a thumbnail image, this indicates that the image does not support a thumbnail view. Selecting the icon, however, displays the full-size image on the screen. It could also indicate that both the thumbnail and full-size images are corrupted or not supported.

Using the Memory Stick Slideshow

The Memory Stick Slideshow lets you watch a slideshow of the images that are on the Memory Stick.

- 1 Insert a Memory Stick that contains the images you want to view. For details, see page 55.
- 2 Press MEMORY STICK. The Memory Stick Menu appears.
- 3 Move the joystick to highlight Slideshow and press \oplus . The slideshow starts.
- 4 To end the slideshow, press \oplus . The Memory Stick Menu is displayed.

Changing the Memory Stick Setup Options

- 1 Press the MEMORY STICK button on the remote control. The Memory Stick Menu appears.
- 2 Move the joystick to highlight Setup and press \oplus . The Memory Stick Setup Menu appears.

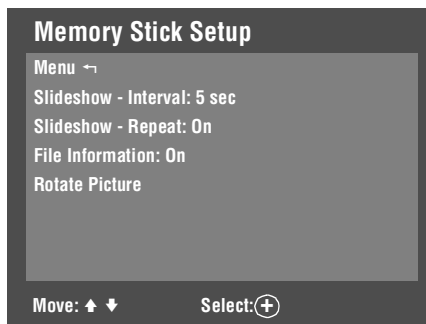

- 3 Move the joystick to highlight an option and press \oplus .

Option	Description
Menu	Returns to the Memory Stick Menu.
Slideshow – Interval	Decrease or increase the length of time that each image is displayed: 5 seconds, 10 seconds, 1 minute, 5 minutes, or 15 minutes.
Slideshow – Repeat	Select On to set the slideshow to repeat after displaying all the images recorded on the Memory Stick. Select Off to not repeat the slideshow.
File Information	Select On to show file information of each image while that image is being displayed.
Rotate Picture	Displays the Rotate Picture screen. For details, see “Using the Rotate Picture Screen” on page 59.



- 4 Move the joystick \rightarrow (or press \oplus) to change settings. Move the joystick \leftarrow (or press \oplus) to select the changed setting.
- 5 To exit the Memory Stick Setup Menu, move the joystick to Menu \leftarrow and press \oplus .

Using the Rotate Picture Screen





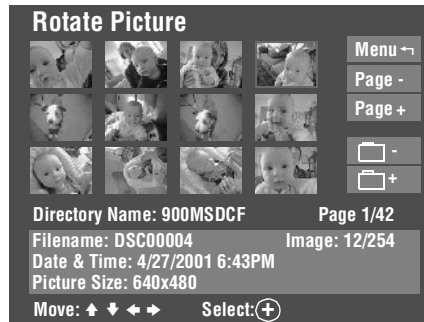

The Rotate Picture Screen lets you rotate an image from an index of thumbnails.

 You cannot rotate images if the LOCK switch on the Memory Stick is on. To rotate the images, first set the LOCK switch to off.

- 1 In the Memory Stick Setup Menu, move the joystick to highlight Rotate Picture and press . The Rotate Picture screen appears.

 The Page and folder  buttons are available only if the Memory Stick contains more images or folders than can be displayed on one screen.



- 2 Move the joystick     to highlight an image that you want to rotate.
- 3 Press  to rotate an image 90 degrees in a clockwise direction.
- 4 To return to the Memory Stick Setup Menu, move the joystick to highlight Menu and press .

 If a blank square appears instead of the thumbnail image, this indicates that the image does not support a thumbnail view and cannot be rotated.

Using Other Equipment with Your TV Remote Control

All Equipment

To Do This ...	Do This ...
Switch the TV's input to the VCR, DVD player, or other connected equipment	Press TV/VIDEO repeatedly to cycle through the video equipment connected to the TV's video inputs.
Set up the TV remote control to operate non-Sony equipment	You must program the remote control the first time you use it. See "Programming the Remote Control" on pages 43 to 44.

Operating a VCR

To Do This ...	Press
Activate the remote control to operate the VCR	Open the outside cover, as shown on page 42. Then set the A/V slide switch to the position you programmed for the VCR.
Turn on/off	VCR/DVD POWER
Change channels	CH +/-
Record	▶ and ● simultaneously
Play	▶
Stop	■
Fast forward	▶▶
Rewind the tape	◀◀
Pause	
Search the picture forward or backward	▶▶ or ◀◀ during playback (release to resume normal playback)
Change input mode	TV/VCR

Operating a Satellite Receiver

To Do This ...	Press
Activate the remote control to operate the satellite receiver	SAT/CABLE FUNCTION
Turn on/off	SAT/CABLE POWER
Select a channel	0-9, ENTER
Change channels	CH +/-
Back to previous channel	JUMP
Display channel number	DISPLAY
Display SAT Guide	GUIDE
Display SAT Menu	MENU
Move highlight (cursor)	↑ ↓ ← →
Select item	⊕

Operating a Cable Box

To Do This ...	Press
Activate the remote control to operate the cable box	SAT/CABLE FUNCTION
Turn on/off	SAT/CABLE POWER
Select a channel	0-9, ENTER
Change channels	CH +/-
Back to previous channel	JUMP

Operating a DVD Player

To Do This ...	Press
Activate the remote control to operate the DVD	Open the outside cover, as shown on page 42. Then set the A/V slide switch to the position you programmed for the DVD player.
Turn on/off	VCR/DVD POWER
Play	▶
Stop	■
Pause	
Step through different tracks of the disc	▶▶ to step forward or ◀◀ to step backward
Step through different chapters of a video disc	CH+ to step forward or CH- to step backward
Select tracks directly	0-9, ENTER
Display the DVD player Menu (Setup)	MENU (inside panel)
Display the DVD Menu	DISC MENU
Move highlight (cursor)	↑ ↓ ◀ ▶
Select item	SELECT

Operating an MDP (Laserdisc Player)







To Do This ...	Press
Activate the remote control to operate the MDP	Open the outside cover, as shown on page 42. Then set the A/V slide switch to the position you programmed for the MDP player.
Turn on/off	VCR/DVD POWER
Play	▶
Stop	■
Pause	
Search the picture forward or backward	▶▶ or ◀◀ during playback (release to resume normal playback)
Search a chapter forward or backward	CH +/-

Using the Menus

Overview

 Press MENU to enter and exit Menus.

The Menu gives you access to the following features:

Menu Icon	Description	Page
	Allows you to make adjustments to your picture settings. It also allows you to customize the Picture Mode based on the type of program you are viewing, select DCR Mode options, and more.	64
	Offers enhanced audio options such as listening to second audio programming (SAP) or customizing the Effect of the sound on your TV.	66
	Allows you to set up a Favorite Channel list, run the Auto Program function, and more.	68
	Lets you control the viewing of programs based on their ratings.	70
	Lets you set the clock on your TV and allows you to program your TV for scheduled viewing using the Timers.	73
	Provides several options for setting up your channels, labeling your video inputs, and selecting the language of the on-screen Menus.	74

Navigating Through Menus

 Menus include navigation help text that appears at the bottom of each Menu.

To Do This ...	Press
Display the Menu	MENU
Move through the Menus	← →
Move through the Menu options	↑ ↓
Select an option to change	⊕
Change an option's settings	↑ ↓ ← →
Select (confirm) changed setting	⊕ or ←
Exit the Menu	MENU



Using the Video Menu

To select the Video Menu

- 1 Press MENU.
- 2 Move the joystick ← or → to highlight the Video icon and press ⊕.
- 3 Move the joystick to highlight an option. Press ⊕ to select an option.
- 4 Move the joystick ↑ ↓ ← → to change settings. Press ⊕ to select the changed setting.
- 5 Press MENU to exit the Menu.

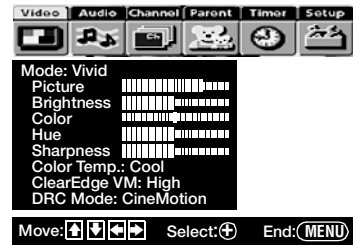

To restore the factory default settings for Picture, Brightness, Color, Hue, Sharpness, Color Temp and VM.

- Press RESET on the remote control when in the Video Menu.

Selecting Video Options

To change from one Mode to another, use the PIC MODE button on the remote control.

You can alter the Video Menu settings (Picture, Brightness, Color, etc.) for each Mode.

The Video Menu includes the following options:

Option	Description
Mode	Vivid Select for enhanced picture contrast and sharpness.
Customized picture viewing	Standard Select for standard picture settings.
	Movie Select to display a softer picture.
	Pro Select to display a picture with minimum enhancements.
Picture	Adjust to increase picture contrast and deepen the color, or decrease picture contrast and soften the color.
Brightness	Adjust to brighten or darken the picture.
Color	Adjust to increase or decrease color intensity.
Hue	Adjust to increase or decrease the green tones.
Sharpness	Adjust to sharpen or soften the picture.
Color Temp. White intensity adjustment	Cool Select to give the white colors a blue tint.
	Neutral Select to give the white colors a neutral tint.
	Warm Select to give the white colors a red tint (NTSC-Standard).



To change quickly from one DRC Mode to another, use the DRC MODE button on the remote control.

<i>Option</i>	<i>Description</i>
ClearEdge VM <i>Velocity Modulation</i>	Sharpens picture definition to give every object a sharp, clean edge. Select from High, Medium, Low, Off.
DRC Mode <i>Digital Reality Creation</i>	Creates a high-resolution picture with 4x density, for high quality sources (i.e., DVD player, satellite receiver).
	Interlaced Recommended for moving pictures.
	Progressive Recommended for still images and text.
	CineMotion Provides an optimized display by automatically detecting film content and applying a reverse 3/2 pulldown process. Moving pictures will appear clearer and more natural-looking.



Using the Audio Menu

To select the Audio Menu

- 1 Press MENU.
- 2 Move the joystick ← or → to highlight the Audio icon and press ⊕.
- 3 Move the joystick to highlight an option. Press ⊕ to select an option.
- 4 Move the joystick ↑ ↓ ← → to change settings. Press ⊕ to select the changed setting.
- 5 Press MENU to exit the Menu.



To restore the factory default settings for Treble, Bass, and Balance

- Press RESET on the remote control when in the Audio Menu.

Selecting Audio Options

 To change quickly from one Effect to another, use the ⊕ button on the remote control.

 To change quickly from one MTS mode to another, use the MTS/SAP button on the remote control.

The Audio Menu includes the following options:

Option	Description
Treble	Adjust to decrease or increase higher-pitched sounds.
Bass	Adjust to decrease or increase lower-pitched sounds.
Balance	Adjust to emphasize left or right speaker balance.
Steady Sound	Auto Select to stabilize the volume.
	Off Select to turn off Steady Sound.
Effect	TruSurround Select for surround sound (for stereo programs only).
	Simulated Adds a surround-like effect to mono programs.
	Off Normal stereo or mono reception.
MTS <i>Enjoy stereo, bilingual and mono programs</i>	Stereo Select for stereo reception when viewing a program broadcast in stereo.
	Auto SAP Select to automatically switch the TV to second audio programs when a signal is received. (If no SAP signal is present, the TV remains in Stereo mode.)
	Mono Select for mono reception. (Use to reduce noise during weak stereo broadcasts.)

<i>Option</i>	<i>Description</i>	
Speaker	On	Select to turn on the TV speakers.
	Off	Select to turn off the TV speakers and listen to the TV's sound only through your external audio system speakers.
Audio Out <i>Easy control of volume adjustments</i>	This option can be set only when the Speaker option is set to Off.	
	Variable	The TV's speakers are turned off, but the volume output from your audio system can still be controlled by the TV's remote control.
	Fixed	The TV's speakers are turned off and the volume output of the TV is fixed. Use your audio receiver's remote control to adjust the volume through your audio system.



Using the Channel Menu

To select the Channel Menu

- 1 Press MENU.
- 2 Move the joystick ← or → to highlight the Channel icon and press ⊕.
- 3 Move the joystick to highlight an option. Press ⊕ to select an option.
- 4 Move the joystick ↑ ↓ ← → to change settings. Press ⊕ to select the changed setting.
- 5 Press MENU to exit the Menu.



Selecting Channel Options

The Channel Menu includes the following options:

Option	Description	
Favorite Channels	Lets you set up a list of your favorite channels. For details, see "Using Favorite Channels" on page 50.	
Cable	On	Select if you are receiving cable channels with a CATV cable.
	Off	Select if you are using an antenna.
 You should run Auto Program after changing this option.		
Channel Fix <i>Useful when you have a cable box or satellite receiver connected</i>	Off	Turns off Channel Fix.
	2-6	"Fix" your TV's channel setting to 2-6 and use the cable box or satellite receiver to change channels. Select one of these settings if you connected the equipment to the VHF/UHF jack.
	AUX 2-6	Same as 2-6, except you select one of these settings if you connected the equipment to the AUX jack (see page 13).
	Video 1	Use this setting if you have connected the equipment to the A/V input jacks.
Auto Program	Automatically sets up the channel list on the TV for all receivable channels.	



Channels that you set to be skipped can be accessed only with the 0-9 buttons.

<i>Option</i>	<i>Description</i>
Channel Skip/Add	<p>Allows you to customize the channel list that appears when you use the CH+/- buttons.</p> <ol style="list-style-type: none">1 Move the joystick \uparrow or \downarrow to scroll through the channels until you find the channel you want to skip or add. Then press \oplus to select it.2 Move the joystick \uparrow or \downarrow to toggle between Add or Skip. Then press \oplus to select.3 To add or skip more channels, repeat steps 1 and 2.4 Move the joystick \leftarrow to return to the Channel Setup Menu, or press MENU to exit the Menus.
Channel Label	<p>Allows you to assign labels (such as station call letters) to channel numbers. You can label up to 20 channels.</p> <ol style="list-style-type: none">1 Move the joystick to highlight Channel and press \oplus.2 Move the joystick \uparrow \downarrow to scroll through the channel numbers (1-125). Then press \oplus to select the channel number that you want to assign a label.3 Move the joystick to highlight Label and press \oplus.4 Move the joystick \uparrow \downarrow to scroll through the label characters (A-Z, 0-9, etc). Then press \oplus to select the highlighted character. Repeat to add up to 5 characters to the label.5 To assign labels to more channels, repeat steps 1-4.6 Move the joystick \leftarrow to return to the Channel Setup Menu, or press MENU to exit the Menus.



Using the Parent Menu

The Parent Menu allows you to set up the TV to block programs according to their content and rating levels.



To select the Parent Menu

- 1 Press MENU.
- 2 Move the joystick ← or → to highlight the Parent icon and press ⊕.
- 3 Use the 0-9 buttons on the remote control to enter a four-digit password.
- 4 If this is the first time you are creating this password, confirm the password by entering it again. (The Parent Menu options appear.)
- 5 Move the joystick ↑ ↓ ← → to change settings. Press ⊕ to select the changed setting.
- 6 Press MENU to exit the Menu.

You need your password for any future access into the Parent Menu. If you lose your password, see "Lost password" on page 84.

Using the Parent Menu

If you are not familiar with the Parental Guideline rating system, you should select Child, Youth, or Young Adult to help simplify the rating selection. To set more specific ratings, select Custom.

For descriptions of Child, Youth, and Young Adult ratings, see page 71.

The Parent Menu includes the following options:

Option	Description
Parental Lock	Off Parental lock is off. No programs are blocked from viewing.
Turn ratings on/off and select a rating system	Child Maximum ratings permitted are: <input type="checkbox"/> US: TV-Y, TV-G, G <input type="checkbox"/> Canada: C, G, TV-Y
	Youth Maximum ratings permitted are: <input type="checkbox"/> US: TV-PG, PG <input type="checkbox"/> Canada: C8+, PG, 8 ans+, TV-PG
	Y. Adult Maximum ratings permitted are: <input type="checkbox"/> US: TV-14, PG-13 <input type="checkbox"/> Canada: 14+, 13 ans+, TV-14
	Custom Select to set ratings manually. <input type="checkbox"/> US: See page 71 for details. <input type="checkbox"/> Canada: See page 72 for details.
Change Password	For changing your password.
Select Country	U.S.A. Select to use USA ratings (see page 71).
	Canada Select to use Canadian ratings (see page 72).

US Models: Selecting Custom Rating Options

 The Content-Based Ratings are linked to the level of the Age-Based Rating. For example, a program with an Age-Based Rating of TV-PG V (Violence) rating may contain moderate violence, while a TV-14 V (Violence) rating may contain more intense violence.

 To ensure maximum blocking capability, set the Age-Based Ratings.

 If you block unrated TV programs, be aware that the following types of programs may be blocked: emergency broadcasts, political programs, sports, news, public service announcements, religious programs and weather.

Viewing Blocked Programs

For US models, the Custom Rating Menu includes the following options. (For Canadian models, see page 72.)

Option	Description
Movie Rating	G All children and General Audience.
	PG Parental Guidance suggested.
	PG-13 Parental Guidance for children under 13.
	R Restricted viewing, parental guidance is suggested for children under 17.
	NC-17 and X No one 17 or under allowed.
TV Rating	Age-Based Ratings
<i>Block programs by their rating, content or both</i>	TV-Y All children.
	TV-Y7 Directed to children age 7 and older.
	TV-G General Audience.
	TV-PG Parental Guidance suggested.
	TV-14 Parents Strongly cautioned.
	TV-MA Mature Audience only.
	Content-Based Ratings
	FV Fantasy Violence.
	D Suggestive Dialogue.
	L Strong Language.
	S Sexual situations.
	V Violence.
Unrated	Block Blocks all programs and movies that are broadcast without a rating.
	Allow Allows programs and movies that are broadcast without a rating.
<i>Block programs or movies that are broadcast without a rating</i>	

You can view blocked programs by entering the password. Press the ENTER button when tuned to a blocked program, then enter the password. This temporarily switches off the Parental Lock. To reactivate the Parental Lock settings, turn off the TV. When the TV is turned on again, your Parental Lock settings are reactivated.

Canadian Models: Selecting Custom Rating Options

For Canadian models, the Custom Rating Menu includes the following options. (For US models, see page 71.)

<i>Option</i>	<i>Description</i>	
English Rating	C	All children.
	C8+	Children 8 years and older.
	G	General programming.
	PG	Parental Guidance.
	14+	Viewers 14 and older.
	18+	Adult programming.
French Rating	G	General programming.
	8 ans+	Not recommended for young children.
	13 ans+	Not recommended for ages under 13.
	16 ans+	Not recommended for ages under 16.
	18 ans+	Programming restricted to adults.
U.S.A. Rating	See "US Models" on page 71 for details.	

Viewing Blocked Programs

You can view blocked programs by entering the password. Press the ENTER button when tuned to a blocked program, then enter the password. This temporarily switches off the Parental Lock. To reactivate the Parental Lock settings, turn off the TV. When the TV is turned on again, your Parental Lock settings are reactivated.



Using the Timer Menu

To select the Timer Menu

- 1 Press MENU.
- 2 Move the joystick \leftarrow or \rightarrow to highlight the Timer icon and press \oplus .



To reset the Clock or Timers

- Press RESET on the remote control, when in the Timer Menu, to reset to the factory defaults.

Selecting Timer Options

To go directly to programming Timer 1 or 2 in step 1, press \oplus instead of moving the joystick \rightarrow .

To return to the Timer Menu after programming one of the Timers, press \oplus when the highlight is in the channel number field.

The Timer Menu includes the following options:

Option	Description
Timer 1 Timer 2	<p>You can use the Timer to program the TV to turn on and off and tune to a specific channel at two scheduled viewing times.</p> <p>Timer 1 and Timer 2 are not available to be set until you set the Current Time.</p> <ol style="list-style-type: none"> 1 Move the joystick \uparrow or \downarrow to highlight Timer 1 or Timer 2. To set the time, move the joystick \rightarrow. 2 Move the joystick \uparrow or \downarrow to highlight one of the following options, then press \oplus. <ul style="list-style-type: none"> Program Select to set the Timer by day, time, duration, and channel. Off Select to turn off the Timer. (Your previous settings are saved.) 3 Move the joystick \uparrow and \downarrow to set the day(s), hour, minute, duration, and channel number. Press \oplus or \rightarrow to confirm each setting and move to the next setting. Move the joystick \leftarrow to go back to the previous setting. 4 Press MENU to exit the Menu. An LED on the front panel will light, indicating the timer has been set.
Current Time	<ol style="list-style-type: none"> 1 Move the joystick \uparrow and \downarrow to set the current time (day, hour, and minute). Press \oplus (or move the joystick \rightarrow) to confirm each setting and move to the next setting. Move the joystick \leftarrow to go back to the previous setting. 2 Press MENU to exit the Menu.



Using the Setup Menu

To select the Setup Menu



- 1 Press MENU.
- 2 Move the joystick ← or → to highlight the Setup icon and press ⊕.
- 3 Move the joystick to highlight an option. Press ⊕ to select an option.
- 4 Move the joystick ↑ ↓ ← → to change settings. Press ⊕ to select the changed setting.
- 5 Press MENU to exit the Menu.





Selecting Setup Options

The Setup Menu includes the following options:

Option	Description
Caption Vision	Allows you to select from three closed caption modes (for programs that are broadcast with closed caption).
CC1, CC2, CC3, CC4	Displays a printed version of the dialog or sound effects of a program. (Should be set to CC1 for most programs.)
Text1, Text2, Text3, Text4	Displays network/station information presented using either half or the whole screen (if available). For closed captioning, set to CC1.
Info	Displays the program name and the time remaining in the program (if the broadcaster offers this service). Displays when the channel is changed or the DISPLAY button is pressed.
Off	Turns off Caption Vision.

Option	Description				
Video Label	<p>Allows you to identify A/V equipment you connected to the TV, such as a VCR, DVD, etc. For example, if you have a DVD player connected to the VIDEO 5 jack, you can select the label DVD for the VIDEO 5 input. Then when you press the TV/VIDEO button to change inputs, the Video Label you assigned to that input appears on screen.</p> <ol style="list-style-type: none"> 1 Move the joystick \uparrow or \downarrow to highlight the video input (VIDEO 1-7) to which you want to assign a label. Then press \oplus to select the input. 2 Move the joystick \uparrow or \downarrow to highlight one of the displayed labels. Then press \oplus to select the label. <p>You can select from the following labels for each input:</p> <table border="1"> <tr> <td>Video 1/2/3/4</td> <td>VHS, DVD, Receiver, Satellite, Cable Box, 8mm, DTV, Game, LD, Web, Beta, Skip</td> </tr> <tr> <td>Video 5/6/7</td> <td>DVD, Satellite, Cable Box, DTV, HD, Skip</td> </tr> </table> <p> If you select Skip, your TV skips this input when you press the TV/VIDEO button.</p>	Video 1/2/3/4	VHS, DVD, Receiver, Satellite, Cable Box, 8mm, DTV, Game, LD, Web, Beta, Skip	Video 5/6/7	DVD, Satellite, Cable Box, DTV, HD, Skip
Video 1/2/3/4	VHS, DVD, Receiver, Satellite, Cable Box, 8mm, DTV, Game, LD, Web, Beta, Skip				
Video 5/6/7	DVD, Satellite, Cable Box, DTV, HD, Skip				
Tilt Correction	<p>Allows you to correct any tilt of the picture.</p> <p>Move the joystick \leftarrow or \rightarrow to choose a correction between +7 and -7 and press \oplus.</p> <p>Normally, tilt correction only needs to be adjusted the first time you turn on the unit and after the unit is moved to a new location.</p>				
Language	Select to display all on-screen Menus in your language of choice.				
16:9 Enhanced	<p>Provides enhanced picture resolution for widescreen (anamorphic) sources, such as selected DVD titles. This option is available only when the TV is set to VIDEO 1-7, which you can do by pressing the TV/VIDEO button.</p> <table border="1"> <tr> <td>On</td> <td>To activate manually. Returns to Auto when you switch to another video input or change channels.</td> </tr> <tr> <td>Auto</td> <td>To activate automatically when a 16:9 signal is received.</td> </tr> </table> <p> If the AUTO setting does not automatically detect the 16:9 signal from your DVD player, select On to manually turn on the 16:9 Enhanced feature.</p>	On	To activate manually. Returns to Auto when you switch to another video input or change channels.	Auto	To activate automatically when a 16:9 signal is received.
On	To activate manually. Returns to Auto when you switch to another video input or change channels.				
Auto	To activate automatically when a 16:9 signal is received.				
Demo	Runs a demonstration of on-screen Menus.				

 The Skip label is useful for inputs that do not have equipment connected to them.

 To use 16:9 Enhanced with widescreen DVDs, set your DVD player to 16:9 aspect ratio. (Aspect ratio is the ratio of width to height of the screen. 16:9 is also referred to as widescreen format.)

Other Information

Overview

This chapter includes the following topics:

<i>Topic</i>	<i>Page</i>
Glossary	78
Notes on Using Memory Stick Media	79
Contacting Sony	80
Troubleshooting	80
Specifications	85
Optional Accessories	86
Index	87

Glossary

analog signal A signaling method that uses continuous changes in the amplitude or frequency of an electronic transmission to convey information.

aspect ratio Refers to the ratio between the width and height of the screen. This TV has a 4:3 aspect ratio, as opposed to a 16:9 (widescreen) aspect ratio.

4:3 aspect ratio



16:9 aspect ratio



component video



Component video is sent through three cables: two color shade (chrominance) signals and one brightness (luminance) signal. Component video achieves greater color accuracy than composite video or S VIDEO by splitting chrominance into two separate portions.

composite video



Composite video is sent through a single cable. Composite video combines the color shade (chrominance) and brightness (luminance) information into one video signal.

degauss

A process that demagnetizes the metal components in the TV monitor, which eliminates image distortion that can result from magnetic charges acquired by the TV's components. Your TV degausses automatically when it is turned on.

digital television (DTV)

A new technology for transmitting and receiving broadcast television signals. DTV provides clearer resolution and improved sound quality over analog television.

National Television System Committee (NTSC)

A unit of the Federal Communications Commission, Washington, DC, that establishes television standards in the United States, such as NTSC Color, the standard used in this TV.

RF

Radio Frequency. That part of the frequency spectrum that is used to transmit TV and radio signals.

S VIDEO



S VIDEO requires a single cable, which carries the brightness (luminance) and color (chrominance) signals of the picture separately. S VIDEO provides better resolution than composite video, which carries the signals together.

VHF/UHF

VHF (Very High Frequency) is the part of the frequency spectrum from 30 to 300 megahertz. UHF (Ultra High Frequency) is the part of the frequency spectrum from 300 to 3,000 megahertz.

480i

Provides 480 lines of resolution. Displays images using interlaced scanning, which first transmits all the odd lines on the TV screen and then the even lines.

480p

Provides 480 lines of resolution. Displays images using progressive scanning, which transmits each line from top to bottom.

720p

Provides 720 lines of resolution. Displays images using progressive scanning, which transmits each line from top to bottom.

1080i

Provides 1080 lines of resolution. Displays images using interlaced scanning, which first transmits all the odd lines on the TV screen and then the even lines. 1080i is one of the formats used by HDTV (High Definition TV).

Notes on Using Memory Stick Media

Memory Stick Precautions

When using Memory Stick media, follow these precautions:

- To avoid permanent damage to still image data, do not turn off the TV or remove Memory Stick media from the insertion slot while data is being read (as indicated by the Memory Stick indicator light being on).
- Avoid touching the terminal of Memory Stick media or bringing it into contact with a metal object.
- Do not drop, bend, or submit Memory Stick media to external shock.
- Do not disassemble or modify Memory Stick media.
- Avoid getting liquid on Memory Stick media.
- Apply labels only within the designated label area.

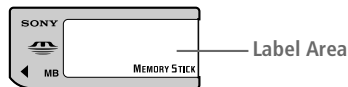

- To avoid permanent damage to still image data, do not use or store Memory Stick media in a location subject to:
 - High temperature (such as near a heater or inside a hot car)
 - High humidity
 - Direct sunlight
 - Corrosive substances
 - Magnetic fields
 - Excessive dust
 - Static electricity or electric noise
 - Electric surges
- Store and carry Memory Stick media in its original case to ensure protection of stored data.
- Save a backup of stored data.

Contacting Sony

If, after reading these operating instructions, you have additional questions related to the use of your Sony television, please call our Customer Information Services Center at 1-800-222-SONY (7669) (US residents only) or (416) 499-SONY (7669) (Canadian residents only).

Before calling Sony customer support, please write down the model and serial numbers of your TV. You'll find this information on the front cover of this manual.

Troubleshooting

Twin View

Problem	Possible Remedies
I cannot get Twin View to work	<ul style="list-style-type: none"><input type="checkbox"/> If you are using a cable box to unscramble all channels (as shown on page 20), you cannot use the Twin View feature. This is because the cable box can unscramble only one channel at a time. But if you need the cable box to unscramble only some (usually premium) channels, you can use Twin View for unscrambled channels if you connect both a cable and cable box, as shown on page 18.<input type="checkbox"/> You can use Twin View to view a signal from a different source that is connected to the TV's A/V jacks (such as a VCR or DVD player) in the second window by pressing the TV/VIDEO button while in Twin View.<input type="checkbox"/> Sources connected to the AUX, VIDEO 5, VIDEO 6, and VIDEO 7 inputs display in the left Twin View window, but not the right.
There is no Twin View window, or it is just static	<ul style="list-style-type: none"><input type="checkbox"/> Be sure the Twin View window is set to a video input or channel that has a signal airing.<input type="checkbox"/> You might be tuned to a video input with nothing connected to it. Try cycling through the video inputs by pressing the TV/VIDEO button.<input type="checkbox"/> If you connected equipment to the TV's AUX jack, it will display in the left Twin View window, but not the right.
Twin View cannot display anything but TV channels	<ul style="list-style-type: none"><input type="checkbox"/> Try cycling through the video inputs by pressing the TV/VIDEO button. Check that the Video Label option is not set to Skip. (See the Setup Menu on page 75.)
Twin View displays the same program in both windows	<ul style="list-style-type: none"><input type="checkbox"/> Both Twin View windows might be set to the same channel. Try changing channels in either window.

Remote Control

Problem	Possible Remedies
Remote control does not operate	<ul style="list-style-type: none"><input type="checkbox"/> The batteries could be weak. Replace the batteries.<input type="checkbox"/> Check the orientation of the batteries.<input type="checkbox"/> Press the TV FUNCTION button. You may have inadvertently pressed the SAT/CABLE FUNCTION button, which changes the remote control to SAT or CABLE mode.<input type="checkbox"/> Make sure the TV's power cord is connected securely to the wall outlet.<input type="checkbox"/> Locate the TV at least 3-4 feet away from fluorescent lights.
Cannot change channels with the remote control	<ul style="list-style-type: none"><input type="checkbox"/> If you are using the TV to change channels, first press the TV FUNCTION button.<input type="checkbox"/> If you are using another device to change channels, be sure you have not inadvertently switched your TV from the channel 3 or 4 setting. Use the Channel Fix option to "fix" the channel based on the hookup you used (see page 68).<input type="checkbox"/> If you are using another device to change channels, be sure to press the FUNCTION button for that device. For example, if you are using your cable box to change channels, be sure to press the SAT/CABLE FUNCTION button.
Remote control does not operate non-Sony video equipment	<ul style="list-style-type: none"><input type="checkbox"/> If you replaced the batteries to the remote recently, the code numbers for the video equipment may need to be reset.<input type="checkbox"/> There may be more than one code for the equipment that you are attempting to operate.<input type="checkbox"/> There is a possibility that some non-Sony equipment cannot be operated by your Sony TV remote. You may need to use the equipment's original remote control.

Channels

Problem	Possible Remedies
Cannot receive upper channels (UHF) when using an antenna	<ul style="list-style-type: none"><input type="checkbox"/> Change the Cable option to Off (see page 68).<input type="checkbox"/> Use Auto Program in the Channel Menu to add receivable channels that are not presently in the TV's memory (see page 68).
TV is fixed to one channel	<ul style="list-style-type: none"><input type="checkbox"/> Use Auto Program in the Channel Menu to add receivable channels that are not presently in the TV's memory (see page 68).<input type="checkbox"/> Check your Channel Fix settings (see page 68).
Cannot receive any channels when using cable TV	<ul style="list-style-type: none"><input type="checkbox"/> Use Auto Program in the Channel Menu to add receivable channels that are not presently in the TV's memory (see page 68).<input type="checkbox"/> Make sure the Cable option is set to On in the Channel Menu (see page 68).
Cannot receive or select channels	<ul style="list-style-type: none"><input type="checkbox"/> Use Auto Program in the Channel Menu to add receivable TV channels that are not presently in TV memory (see page 68).

Memory Stick

<i>Problem</i>	<i>Possible Remedies</i>
Image does not display	<ul style="list-style-type: none"> <input type="checkbox"/> Make sure the image is supported by the TV (see pages 52-54). <input type="checkbox"/> Make sure the Memory Stick is inserted properly (see page 55). <input type="checkbox"/> Memory Stick functions are not available while using Twin View, Freeze or Favorite Channel functions.
Blank square appears instead of a thumbnail image	<ul style="list-style-type: none"> <input type="checkbox"/> This indicates that the image does not support a thumbnail view. Selecting the icon, however, displays the full-size image on the screen. It could also indicate that both the thumbnail and full-size images are corrupted or not supported.
Cannot rotate image, no thumbnail appears	<ul style="list-style-type: none"> <input type="checkbox"/> Be sure the LOCK switch on the Memory Stick is set to off. <input type="checkbox"/> If a blank square appears instead of the thumbnail image, this indicates that the image does not support a thumbnail view and cannot be rotated.
Cannot hear audio while using Memory Stick	<ul style="list-style-type: none"> <input type="checkbox"/> There is no audio available while using Memory Stick.
Image file name does not appear; instead, dashes (---) appear	<ul style="list-style-type: none"> <input type="checkbox"/> Dashes appear instead of the file name if the image was recorded using equipment that is not DCF-compliant.
Error message is displayed	<ul style="list-style-type: none"> <input type="checkbox"/> No Memory Stick There is no Memory Stick in the slot. <input type="checkbox"/> Memory Stick Locked The lock mechanism on the Memory Stick is engaged; files cannot be rotated until the Memory Stick is unlocked. <input type="checkbox"/> Memory Stick Error The Memory Stick in the slot might be damaged; try a different Memory Stick. <input type="checkbox"/> File Error File is not compatible with the viewer, see the manual for file compatibility requirements.

Video

Problem	Possible Remedies
No picture (screen not lit), no sound	<ul style="list-style-type: none"><input type="checkbox"/> If your TV does not turn on, and a red light keeps flashing, your TV may need service. Call your local Sony Service Center.<input type="checkbox"/> Make sure the power cord is plugged in.<input type="checkbox"/> Press the POWER button on the front of the TV.<input type="checkbox"/> Press the TV/VIDEO button to cycle through the connected video sources.<input type="checkbox"/> Try another channel; it could be station trouble.
Dark, poor or no picture (screen lit), good sound	<ul style="list-style-type: none"><input type="checkbox"/> Adjust the Picture option in the Video Menu (see page 64).<input type="checkbox"/> Adjust the Brightness option in the Video Menu (see page 64).<input type="checkbox"/> Check the antenna/cable connections.
No color	<ul style="list-style-type: none"><input type="checkbox"/> Adjust the Color option in the Video Menu (see page 64).
Only snow and noise appear on the screen	<ul style="list-style-type: none"><input type="checkbox"/> Check the antenna/cable connections.<input type="checkbox"/> Try another channel; it could be station trouble.<input type="checkbox"/> Press ANT to change the input mode (see page 40).
Dotted lines or stripes	<ul style="list-style-type: none"><input type="checkbox"/> Adjust the antenna.<input type="checkbox"/> Move the TV away from noise sources such as cars, neon signs, or hair-dryers.
Double images or ghosts	<ul style="list-style-type: none"><input type="checkbox"/> Using a highly directional outdoor antenna or a cable may solve the problem.
"Black box" on screen	<ul style="list-style-type: none"><input type="checkbox"/> You have selected a text option in the Setup Menu and no text is available. (See page 74 to reset Setup selections.) To turn off this feature, set the Caption Vision option to Off. If you were trying to select closed captioning, select CC1 instead of TEXT 1-4.
16:9 Enhanced feature	<ul style="list-style-type: none"><input type="checkbox"/> If the Auto setting does not automatically detect the 16:9 signal from your DVD player, select On to manually turn on the 16:9 Enhanced feature. For details, see page 75.

Audio

Problem	Possible Remedies
Good picture, no sound	<ul style="list-style-type: none"><input type="checkbox"/> Press MUTING so that the word Muting disappears from the screen (see page 40).<input type="checkbox"/> Make sure the Speaker option is set to On in the Audio Menu (see page 67).
Cannot gain enough volume when using a cable box	<ul style="list-style-type: none"><input type="checkbox"/> Increase the volume of the cable box using the cable box's remote control. Then press TV FUNCTION and adjust the TV's volume.
Sound seems weak or insufficient	<ul style="list-style-type: none"><input type="checkbox"/> The TV's audio might be set to Auto SAP or Mono, when it might be better set to Stereo. In the Audio Menu (see page 66), set the MTS setting to Stereo. If already set to Stereo, switch to Mono (which may reduce background noise during weak stereo broadcasts).
Cannot raise the volume on external audio speakers	<ul style="list-style-type: none"><input type="checkbox"/> If the Speaker option is set to Off and the Audio Out option is set to Fixed (in order to output the sound to your audio system) use your audio receiver to adjust the sound (see page 66). Or, to use the TV remote control, set the Audio Out option to Variable.<input type="checkbox"/> To turn on the TV speakers, set the Speaker option to On (see page 66).

General

<i>Problem</i>	<i>Possible Remedies</i>
How to reset TV to factory settings	<input type="checkbox"/> Turn on the TV. While holding down the RESET button on the remote control, press the POWER button on the TV. (The TV will turn itself off, then back on again.) Release the RESET button.
How to restore Video settings to factory settings	<input type="checkbox"/> Press the RESET button on the remote control while in the Video Menu (see page 64).
How to restore Audio settings to factory settings	<input type="checkbox"/> Press the RESET button on the remote control while in the Audio Menu (see page 66).
Cannot cycle through the other video equipment connected to the TV	<input type="checkbox"/> Be sure the Video Label option is not set to Skip (see page 75).
Cannot operate Menu	<input type="checkbox"/> If a menu option appears in gray, this indicates that the TV is in a state in which the menu option is not available.
Lost password	<input type="checkbox"/> In the password screen (see page 70), enter the following master password: 4357. The master password clears your previous password; it cannot be used to temporarily unblock channels.
TV makes "popping" sound when turned on	<input type="checkbox"/> This is a normal sound that results from the TV automatically degaussing each time it is turned on.
LED on front panel is lit	<input type="checkbox"/> The STAND BY LED (see page 11) blinks when the TV is turned on, then shuts off when the picture is displayed. If the LED blinks continuously, this may indicate the TV needs service. <input type="checkbox"/> The TIMER LED (see page 11) indicates that the timer is set (page 73). When the timer is set, this LED will remain lit even when the TV is turned off.
Digital cable box does not work	<input type="checkbox"/> Be sure that you have not connected the digital cable box to the TV's TO CONVERTER jack. This jack is not compatible with digital cable boxes. <input type="checkbox"/> If you are connecting a VCR and digital cable box using a splitter, as described on pages 24-25, you must use a special bi-directional splitter that is designed to work with your digital cable box. Contact your cable provider for details.

Specifications

Picture Tube	FD Trinitron® tube	
Antenna	75 ohm external terminal for VHF/UHF	
Television System	NTSC, American TV Standard	
Channel Coverage	VHF	2-13
	UHF	14-69
	CATV	1-125
Power Requirements	120V, 60 Hz	
Inputs/Outputs		
DVI-HDTV	1 terminal, 3.3V T.M.D.S., 50 ohms The DVI-HDTV input terminal is compliant with the EIA-861 standard and is not intended for use with personal computers.	
Video (IN)	4 total (1 on front panel)	1 Vp-p, 75 ohms unbalanced, sync negative
S Video (IN)	3 total (1 on front panel)	Y: 1 Vp-p, 75 ohms unbalanced, sync negative C: 0.286 Vp-p (Burst signal), 75 ohms
Audio (IN)	7 total (1 on front panel)	500 mVrms (100% modulation) Impedance: 47 kilohm
Component Video Input	2 (Y, P _B , P _R)	Y: 1.0 Vp-p, 75 ohms unbalanced, sync negative; P _B : 0.7 Vp-p, 75 ohms P _R : 0.7 Vp-p, 75 ohms
CONTROLS (IN/OUT)	1	
Variable/Fixed Audio (OUT)	1	More than 408 mVrms at the maximum volume setting (Variable) More than 408 mVrms (Fixed) Impedance (output): 2 kilohms
Supplied Accessories	Remote Control	RM-Y190
	AA (R6) Batteries	2 supplied for remote control
Visible Screen Size	KV-32HS510	32 in (812.8 mm) picture measured diagonally
	KV-36HS510	36 in (914.4 mm) picture measured diagonally
Actual CRT Size	KV-32HS510	34 in (863.6 mm) picture measured diagonally
	KV-36HS510	38 in (965.2 mm) picture measured diagonally
Speaker Output	7.5 W x 2 + 15 W subwoofer	
Dimensions (W x H x D)	KV-32HS510	898 x 689 x 608 mm (35 3/8 x 27 1/8 x 24 in)
	KV-36HS510	1017 x 760 x 643 mm (40 x 30 x 25 3/8 in)
Mass	KV-32HS510	80 kg (176.5 lbs)
	KV-36HS510	104.3 kg (230 lbs)
Power Consumption	In Use	280 W
	In Standby	1 W

Design and specifications are subject to change without notice.

Optional Accessories

- ❑ A/V Cable (VMC-810/820/830 HG)
- ❑ Audio Cable (RKC-515HG)
- ❑ Component Video Cable (VMC-10/30 HG)
- ❑ TV Stand, for KV-32HS510: SU-32HS1
TV Stand, for KV-36HS510: SU-36HS1
- ❑ Memory Stick media: 8 MB (MSA-8A); 16 MB (MSA-16A); 32 MB (MSA-32A); 64 MB (MSA-64A); 128 MB (MSA-128A)

Index

0-9 buttons 41, 45
16:9 (widescreen) 8, 75

A

ANT button 40, 45
antenna, connecting 15
aspect ratio 75
Audio Menu 63, 66
Audio Out 67
audio receiver, connecting 36
Auto Program (channel setup)
38, 68
Auto SAP, MTS setting 66
AUX jack, described 13
AV1-3/DVD slide switch 42

B

balance, adjusting 66
bass, adjusting 66
batteries, inserting in remote 39
bilingual audio 66
blocking programs. *See ratings.*
brightness, adjusting 64

C

cable
connecting 15
setting On/Off 68
with VCR, connecting 22
cable box
connecting with VCR 24
Twin View issues 47
using with TV remote
control 61
camcorder, connecting 35
Caption Vision 74
CATV. *See cable*
CH buttons 11, 41, 45
changing picture size, in Twin
View 49
Channel Menu 63, 68
Channel Skip/Add 69
channels
creating labels 69
setting up 38

CineMotion 8, 40, 65
ClearEdge VM 8, 65
clearing, Favorite Channels 50
closed caption modes 74
CODE SET button 41
color, adjusting 64
CONTROL S 37
CONTROL S IN/OUT jacks,
described 13
Cool, Color Temperature 64
cursor movement buttons 11

D

degauss 84
Demo, Menus 75
Digital Reality Creation 7, 65
Digital Visual Interface (DVI) 8
DISC MENU button 42, 61
DISPLAY button 41, 45
DRC MODE button 40
DVD player
using with TV remote
control 61
with A/V connectors,
connecting 34
DVI. *See Digital Visual Interface.*
DVI-HDTV 85

E

Effect button 42
ENTER button 41, 45
error messages, Memory Stick 82

F

Fast-forward button 42
Favorite Channels
clearing 50
in Channel Menu 68
using 50
FAVORITES button 40
features 7
Fixed audio setting 67
FREEZE button 41, 51
Freeze, using 51

G

GUIDE button 41

H

HD Detailer 8
HD/DVD IN
(1080i/720p/480p/480i)
jacks, described 13
hue, adjusting 64

I

INDEX button 40, 46
interlaced 7, 40, 65, 78

J

joystick 40
JUMP button 40, 45

L

label
channels 69
Language, setting 75
LOCK switch, Memory Stick 59

M

MDP, using with TV remote
control 61
Memory Stick
error messages 82
Index 57
indicator (LED) 11
inserting 55
insertion slot 11
Menu 56
precautions 79
Rotate Picture 59
Setup options 58
Slideshow 58
supported and unsupported
images 52
troubleshooting 82
using 52–59
Memory Stick button 41
MENU button 11, 40, 42, 45, 63

Menus

- Audio 63, 66
- Channel 63, 68
- Parent 63, 70
- Setup 63, 74
- Timer 63, 73
- Video 63, 64

Mono, MTS setting 66

Movie mode 64

MTS 66

MTS/SAP button 40, 42

MUTING button 40, 45

N

Neutral, Color Temperature 64

O

off, turning off the TV 11

on, turning on the TV 11

P

Parent Menu 63, 70

parental control, described 8

password, changing 70

Pause button 42

PIC MODE button 41

picture contrast, adjusting 64

Picture in Picture. *See Twin View.*

Play button 42

POWER button 11

power cord, removing from holder 9

powering on/off, the TV 11

presetting channels 68

Pro (Video) mode 64

problems, troubleshooting 80–84

progressive 7, 40, 65, 78

R

ratings, setting 70–72

ratings, viewing blocked

programs 71, 72

Record buttons 42

remote control

inserting batteries 39

programming 43–44

removing, Favorite Channels 50

RESET button 40

resetting

Audio options 66

Timer options 73

Video options 64

Rewind button 42

rotate picture, Memory Stick 59

S

S VIDEO jack, described 11, 13, 21

SAT/CABLE FUNCTION button 40

SAT/CABLE POWER button 41

satellite receiver, using with TV remote control 60

Scrolling Index 7

Scrolling Index, using 46

SELECT button 11, 42

setting up channels 38

Setup Menu 63, 74

sharpness, adjusting 64

Simulated, Effect 66

sizing, picture in Twin View 49

SLEEP button 40

slideshow 58

speakers

turning on/off 67

using external speakers 67

specifications 85

STAND BY indicator 11, 84

Standard mode 64

Steady Sound, described 8

Steady Sound, setting 66

Stereo, MTS setting 66

Stop button 42

surround sound 66

SYSTEM OFF button 42

T

tilt, correcting 75

Timer 73

TIMER indicator 11, 84

Timer Menu 63, 73

timers, setting 73

transport buttons 42

treble, adjusting 66

troubleshooting 80–84

TruSurround 66

TruSurround, Effect 66

turning on/off the TV 11

TV FUNCTION button 40, 45

TV POWER button 41, 45

TV/VCR button 42

TV/VIDEO button 40, 45

Twin View

described 7

factors affecting 47

using 47–49

Twin View button 41

V

Variable audio setting 67

VCR

using with TV remote

control 60

with cable box, connecting 24

with cable, connecting 22

with satellite receiver, connecting 30

VCR/DVD button 42

VHF/UHF jack, described 13

VIDEO (L/R)/AUDIO jacks, described 13

Video Menu 63, 64

Video modes, selecting 64

Vivid mode 64

VOL buttons 11, 40, 45

W

Warm, Color Temperature 64

Wega, described 7

widescreen 8, 75

widescreen, described 8

Z

zoom feature, with Twin View 49

Free Manuals Download Website

<http://myh66.com>

<http://usermanuals.us>

<http://www.somanuals.com>

<http://www.4manuals.cc>

<http://www.manual-lib.com>

<http://www.404manual.com>

<http://www.luxmanual.com>

<http://aubethermostatmanual.com>

Golf course search by state

<http://golfingnear.com>

Email search by domain

<http://emailbydomain.com>

Auto manuals search

<http://auto.somanuals.com>

TV manuals search

<http://tv.somanuals.com>