

Trinitron Color TV

Operating Instructions

GB

- Before operating the unit, please read this manual thoroughly and retain it for future reference.

FD Trinitron
WEGA

KV-TG21
KV-PG14

M90
M72

A Getting Started

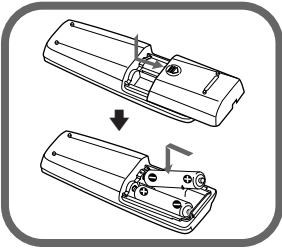

Step 1

Insert the batteries (supplied) into the remote.

Note

- Do not use old batteries nor use different types of batteries together.

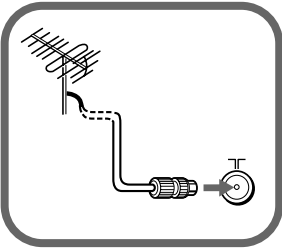

Step 2

Connect the antenna cable (not supplied) to Υ (antenna input) at the rear of the TV.

Tip

- You can also connect your TV to other optional components. (See **E**)

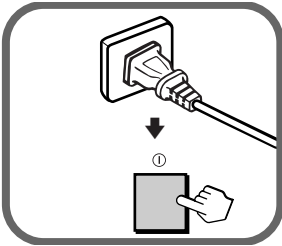

Step 3

Plug in the power cord, then press $\text{\textcircled{I}}$ on the TV to turn it on.

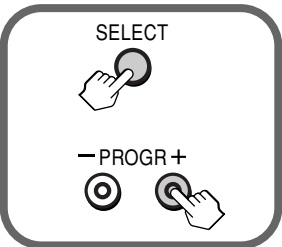

Step 4

Press SELECT and PROGR + on the TV at the same time for one to two seconds to preset the channels automatically. (See **J**)

Tip

- To stop the automatic channel presetting, press SELECT.

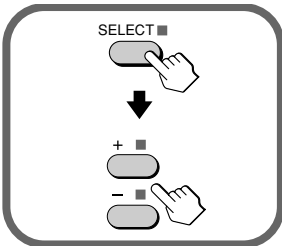

Step 5

Press SELECT on the remote until "LANGUAGE/语言:" ENGLISH" appears on the screen, then press + or - to change the on-screen display language.

B WARNING

- Dangerously high voltages are present inside the TV.
- TV operating voltage: 220 – 240 V AC.
- Do not plug in the power cord until you have completed making all other connections; otherwise a minimum leakage current might flow through the antenna and other terminals to ground.
- To avoid battery leakage and damage to the remote, remove the batteries from the remote if you are not going to use it for several days. If any liquid that leaks from the batteries touches you, immediately wash it away with water.

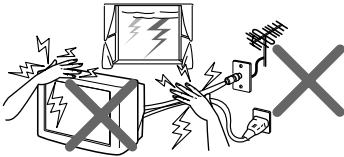

For your own safety, do not touch any part of the TV, the power cord and the antenna cable during lightning storms.

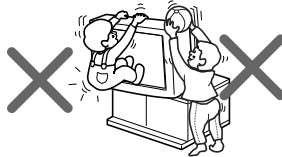

For children's safety, do not leave children alone with the TV. Do not allow children to climb onto it.

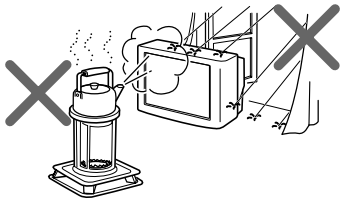

To prevent fire or shock hazard, do not expose the TV to rain or moisture.

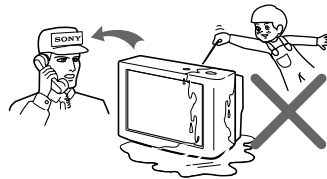

Do not operate the TV if any liquid or solid object falls into it. Have it checked immediately by qualified personnel only.

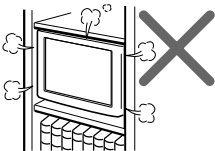

Do not block the ventilation openings of the TV. Do not install the TV in a confined space, such as a bookcase or built-in cabinet.

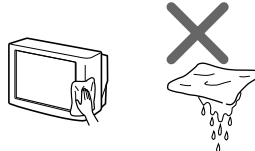

Clean the TV with a dry and soft cloth. Do not use benzine, thinner, or any other chemicals to clean the TV. Do not scratch the picture tube.

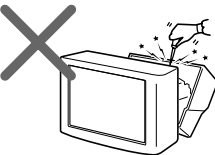

Do not open the cabinet and the rear cover of the TV as high voltages and other hazards are present inside the TV. Refer servicing and disposal of the TV to qualified personnel.

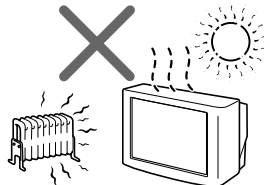

Your TV is recommended for home use only. Do not use the TV in any vehicle or where it may be subject to excessive dust, heat, moisture or vibrations.

WARNING (continued)

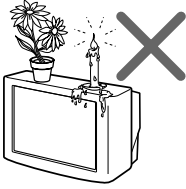

Do not place any objects on the TV.

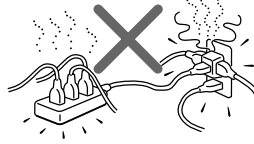

Do not plug in too many appliances to the same power socket. Do not damage the power cord.

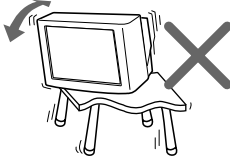

Install the TV on a stable TV stand and floor which can support the TV set weight. Ensure that the TV stand surface is flat and its area is larger than the bottom area of the TV.

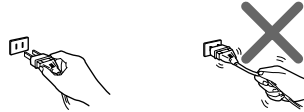

Pull the power cord out by the plug. Do not pull the power cord itself. Even if your TV is turned off, it is still connected to the AC power source (mains) as long as the power cord is plugged in. Unplug the TV before moving it or if you are not going to use it for several days.

C Securing the TV

► KV-TG21 only

To prevent the TV from falling, use the supplied screws, clamps and band to secure the TV.

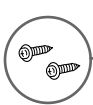

screws

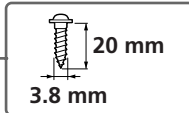

clamps

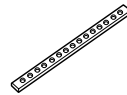

band

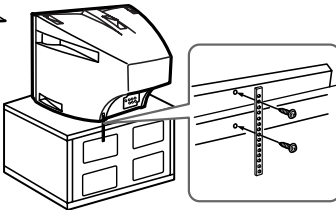

Screw the band to the TV stand and to the provided hole at the rear of your TV.

or

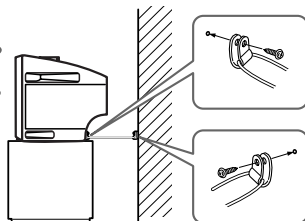

- (1) Put a cord or chain through the clamps.
- (2) Screw one clamp to a wall or pillar and the other clamp to the provided hole at the rear of your TV.

Note

- Use only the supplied screws. Use of other screws may damage the TV.

D TV front and rear panels

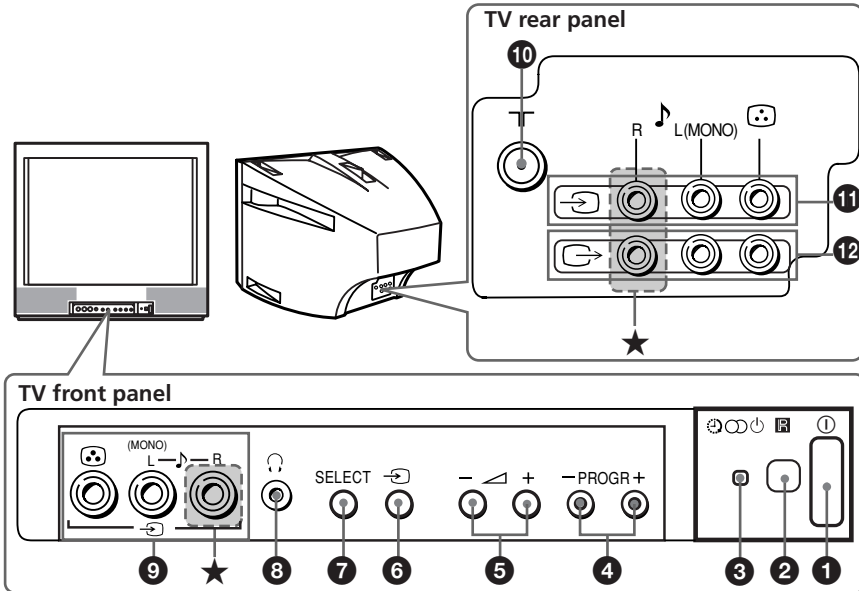

Button	Function
① ①	Turn off or turn on the TV.
②	Remote control sensor.
③	Standby indicator.
③	Stereo/bilingual indicator. (KV-TG21M90 only)
③	Bilingual indicator. (KV-PG14M72 only)
③	Wake Up indicator.
④ PROGR +/-	Select program number.
⑤	Adjust volume.
⑥	Select TV or video input.
⑦ SELECT	Select the desired item.
⑧	Headphone terminal. (KV-TG21 only)
⑧	Earphone terminal. (KV-PG14 only)
⑨, ⑪	Video input terminal.
⑩	Antenna input terminal.
⑫	Monitor output terminal.

* You can also use the +/- buttons on the TV to work as the +/- buttons on the remote.

★ The R (audio input) jacks are available for KV-TG21 only.

E Connecting optional components

Connecting to the video input terminal (↷)

TV front panel

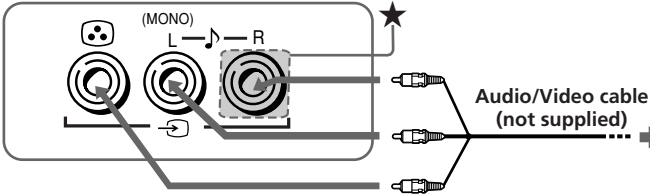

TV rear panel

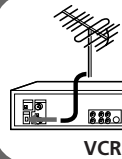
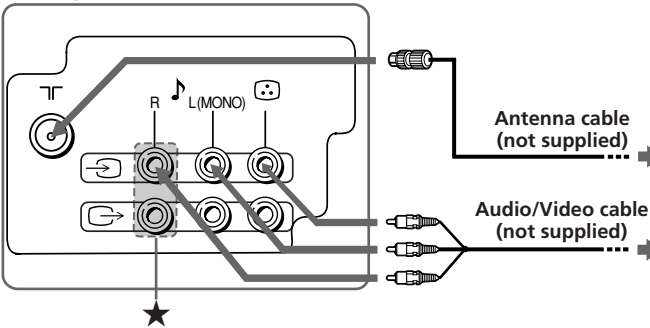

Note

- Do not connect video equipment to ↷ (video input) at the front and the rear of your TV at the same time; otherwise the picture will not be displayed properly on the screen.

Connecting to the monitor output terminal (↶)

TV rear panel

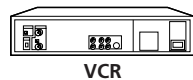
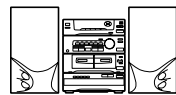
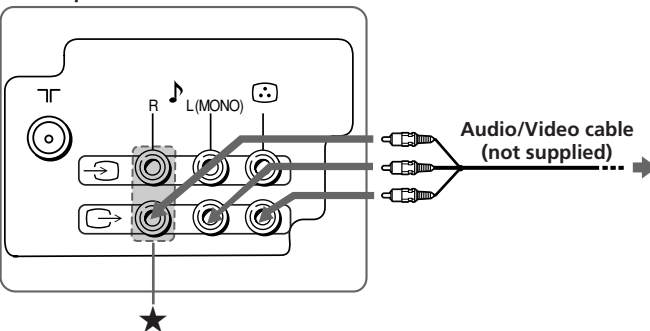

★ The R (audio input) jacks are available for KV-TG21 only.

F Troubleshooting

If you find any problem while viewing your TV, please check the following guide. If any problem persists, contact your Sony dealer.

Symptom	Solutions
Snowy picture, noisy sound	<ul style="list-style-type: none"> • Check the antenna cable and connection on the TV, VCR and on the wall. • Preset the channel manually again. (See J) • Check the antenna setup. Contact a Sony dealer for advice.
Good picture, noisy sound	<ul style="list-style-type: none"> • Select the appropriate TV system. (See J) • Press A/B until the sound is optimal. (KV-TG21M90 only)
No picture, no sound	<ul style="list-style-type: none"> • Check the power cord, antenna and the VCR connections. • Press I/⏻ (power) or ⏻ (main power) to turn on the TV.
Good picture, no sound	<ul style="list-style-type: none"> • Press \triangle + to increase the volume level. • Press \otimes to cancel the muting.
Dotted lines or stripes	<ul style="list-style-type: none"> • Do not use a hair dryer or other equipment near the TV. • Check the antenna setup. Contact a Sony dealer for advice.
Double images or "ghosts"	<ul style="list-style-type: none"> • Use the fine tuning ("FINE") function. (See J) • Turn off or disconnect the booster if it is in use. • Check the antenna setup. Contact a Sony dealer for advice.
No color	<ul style="list-style-type: none"> • Select the appropriate color system. (See J) • Adjust the color level. (See K) • Check the antenna setup. Contact a Sony dealer for advice.
Abnormal color patches	<ul style="list-style-type: none"> • Keep external speakers or other electrical equipment away from the TV. Press ⏻ (main power) to turn off the TV for about 15 minutes, then turn it on again to demagnetize the TV.
The ⏻ (standby) indicator on your TV flashes red several times after every three seconds.	<ul style="list-style-type: none"> • Count the number of times the ⏻ (standby) indicator flashes. Press ⏻ (main power) to turn off your TV. Contact your nearest Sony service center.
TV cabinet creaks.	<ul style="list-style-type: none"> • Changes in room temperature sometimes make the TV cabinet expand or contract, making a noise. This does not indicate a malfunction.
A "boom" sound is heard when the TV is turned on.	<ul style="list-style-type: none"> • The TV's demagnetizing function is working. This does not indicate a malfunction.

G Specifications

	KV-TG21M90	KV-PG14M72	Note
Power requirements	220-240 V AC, 50/60 Hz		
Power consumption (W)	Indicated on the rear of the TV		
Television system	B/G, I, D/K, M		
Color system	PAL, PAL 60, SECAM, NTSC3.58, NTSC4.43		
Stereo/Bilingual system	NICAM Stereo/Bilingual B/G, I, D/K; A2 Stereo/ Bilingual B/G	NICAM Bilingual B/G, I, D/K	
Channel coverage			
B/G	VHF : E2 to E12 UHF: E21 to E69 CATV : S01 to S03, S1 to S41		
I	UHF : B21 to B68 CATV : S01 to S03, S1 to S41		
D/K	VHF: C1 to C12, R1 to R12 UHF : C13 to C57, R21 to R60 CATV : S01 to S03, S1 to S41, Z1 to Z39		
M	VHF : A2 to A13 UHF: A14 to A79 CATV : A-8 to A-2, A to W+4, W+6 to W+84		
⌚ (Antenna)	75-ohm external terminal		
Audio output (Speaker)	3W + 3W	3W	
Number of terminal			
📺 (Video)	Input: 2* Output: 1	Phono jacks; 1 Vp-p, 75 ohms	* One input line available
🎵 (Audio)	Input: 2* Output: 1	Phono jacks; 500 m Vrms	* One input line available
🎧 (Headphone)	Output: 1	Stereo minijack	KV-TG21M90 only
📻 (Earphone)	Output: 1	Monaural minijack	KV-PG14M72 only
Picture tube	21 in.	14 in.	
Tube size (cm)	54	37	Measured diagonally
Screen size (cm)	51	34	Measured diagonally
Dimensions (w/h/d, mm)	497 x 458 x 487	375 x 346 x 411	
Mass (kg)	25	12	

Design and specifications are subject to change without notice.

<http://www.sony.net/>

H Remote control

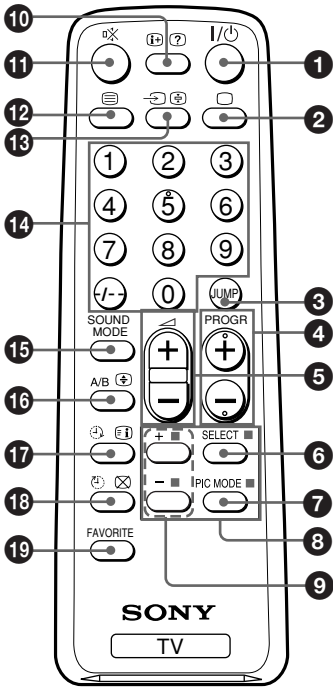

Button	Function	See
1 I/⏻	Turn off temporarily or turn on the TV.	-
2 □	Display the TV program.	-
3 JUMP	Jump to previous program number.	-
4 PROGR +/-	Select program number.	-
5 ∟ +/-	Adjust volume.	-
6 SELECT	Select the desired item.	-
7 PIC MODE	Select picture mode.	K
9 +/-	Adjust items.	-
10 ⓘ	Display on-screen information.	-
11 ⏻	Mute the sound.	-
13 ↺	Select TV or video input.	-
14 0 - 9, -/--	Input numbers.	-
Timer operations		
17 ⏰	Set TV to turn on automatically.	I
18 ⏰	Set TV to turn off automatically.	I
Sound mode operations (KV-TG21M90 only)		
15 SOUND MODE	Select sound mode.	K
Stereo/bilingual operations		
16 A/B	Select stereo/bilingual mode.	M
Teletext operations (green label)		
8 ■ (red, green, yellow, blue)	Not function for your TV.	-
10 ?		
12 ☰		
13 Ⓢ		
16 Ⓢ		
17 ⓘ		
18 ☒		
19 FAVORITE	Not function for your TV.	-

I Setting the timers

You can turn on and off your TV by using the  and  buttons respectively.

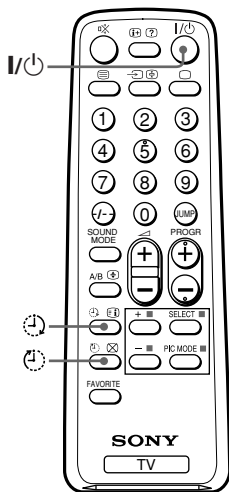

Setting the Wake Up timer

- 1 Press  until the desired period of time appears on the screen.

WAKE UP TIMER:0H10M
(After 10 minutes)

WAKE UP TIMER:OFF
(No Wake Up timer)

WAKE UP TIMER:12H00M
(After 12 hours)

The Wake Up timer starts immediately after you have set it.

- 2 Select the program number or video input you want to wake up to.

- 3 Press , or set the Sleep timer if you want the TV to turn off automatically.

The  indicator on the TV lights up orange when the TV goes into standby mode.

Setting the Sleep timer

Press  until the desired period of time appears on the screen.

SLEEP TIMER:30M
(After 30 minutes)

SLEEP TIMER:60M
(After 60 minutes)

SLEEP TIMER:OFF
(No Sleep timer)

SLEEP TIMER:90M
(After 90 minutes)

The Sleep timer starts immediately after you have set it.

Notes

- You can also cancel the Wake Up and Sleep timers by turning off the TV's main power.
- If no buttons or controls are pressed for more than two hours after the TV is turned on using the Wake Up timer, the TV automatically goes into standby mode.

J Presetting channels

You can automatically preset up to 100 TV channels in numerical sequence from program number 1, or manually preset desired channels and channels that cannot be preset automatically.

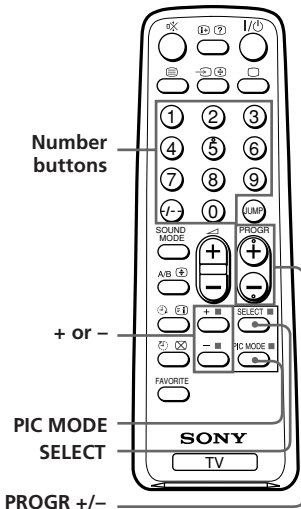

Presetting channels automatically from a specified program number

- 1** Press SELECT until "AUTO PROGRAM" appears on the screen.
- 2** Press + or - once to enter the "AUTO PROGRAM" mode.
The on-screen display will start flashing.
- 3** Press PROGR +/- or the number buttons until the desired program number appears on the screen.
- 4** Press + or - to start presetting channels automatically.

Presetting channels manually

- 1** Press SELECT until "MANUAL PROGRAM" appears on the screen.
- 2** Press + or - once to enter the "MANUAL PROGRAM" mode.
- 3** Press PROGR +/- or the number buttons until the desired program number appears on the screen.
- 4** Press + or - until the desired channel picture appears on the screen.
- 5** To preset other channels manually, repeat steps 3 to 4.

Presetting channels (continued)

To change the TV system setting

If the picture or sound is abnormal when receiving programs through the ㄗ (antenna input) terminal

- (1) Press SELECT until "TV SYS" appears on the screen.
- (2) Press + or - to select the appropriate TV system until the picture or sound quality is optimal.

B/G → I → D/K → M

To change the color system setting

If the color is abnormal when receiving programs through the ㄗ (antenna input) terminal or the ㄗ (video input) terminal

- (1) Press SELECT until "COLOR SYS" appears on the screen.
- (2) Press + or - to select the appropriate color system until the color is optimal.

AUTO → PAL → SECAM → NTSC3.58 → NTSC4.43

To skip program numbers

- (1) Press PROGR +/- or the number buttons until the unused or unwanted program number appears on the screen.
- (2) Press SELECT until "MANUAL PROGRAM" appears on the screen.
- (3) Press + or - once to enter the "MANUAL PROGRAM" mode.
- (4) Press PIC MODE to skip the unused or unwanted program number.
- (5) Press SELECT to exit the "MANUAL PROGRAM" mode.

Note

- To restore the skipped program number again, preset the channel automatically or manually.

To use the fine tuning function

The fine tuning (FINE) function may help to reduce the following problems: double images and lines moving across the TV screen.

You can use the fine tuning function as below:

- (1) Select the program number you want to adjust.
- (2) Press SELECT until "MANUAL PROGRAM" appears on the screen.
- (3) Press + or - once to enter the "MANUAL PROGRAM" mode.
- (4) Press **i** to display "FINE" on the screen.
- (5) Press + or - continuously until the above problems are minimized.
The + or - icon on the screen flashes while tuning.
- (6) Press SELECT to exit the "MANUAL PROGRAM" mode.

K Customizing the picture and sound

You can customize the picture and sound by selecting the picture and sound modes or by adjusting its settings.

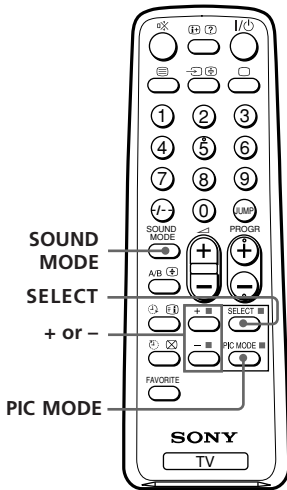

Selecting the picture mode

Press PIC MODE to select the desired picture mode.

Select	To
"DYNAMIC"	view high contrast pictures.
"STANDARD"	view normal contrast pictures.
"SOFT"	view mild pictures.

Selecting the sound mode

► KV-TG21M90 only

Press SOUND MODE to select the desired sound mode.

Select	To
"♪ DYNAMIC"	listen to dynamic and clear sound that emphasizes the low and high sound.
"♪ DRAMA"	listen to sound that emphasizes vocals and background music.
"♪ SOFT"	listen to soft sound.

Adjusting the picture and sound settings

1 Press SELECT until the desired setting appears.

Each time you press SELECT, the setting item will change as follows:



2 Press + or - to adjust the item.

3 To adjust other items, repeat steps 1 to 2.

Notes

- "BASS", "TREBLE" and "BALANCE" can be adjusted for KV-TG21M90 only.
- "HUE" can be adjusted for the NTSC color system only.
- Reducing "SHARP" can also reduce picture noise.

L Adjusting the picture position

► KV-TG21M90 only

If the picture is slanting, you can adjust the picture position using the "PIC ROTATION" function until it is optimal.

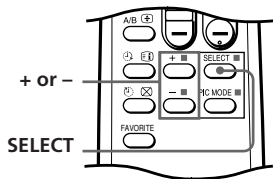
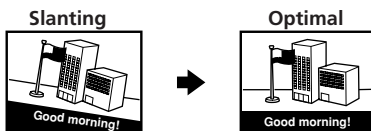

1 Press SELECT repeatedly until "PIC ROTATION" appears on the screen.

2 Press + or - to adjust the picture position.
The ↶ or ↷ icon on the screen flashes while adjusting.

Note

- To reduce the slanting picture, keep external speakers or other electrical equipment away from the TV.

M Enjoying stereo or bilingual programs

You can enjoy stereo sound or bilingual programs of NICAM and A2 stereo systems by using the A/B button.

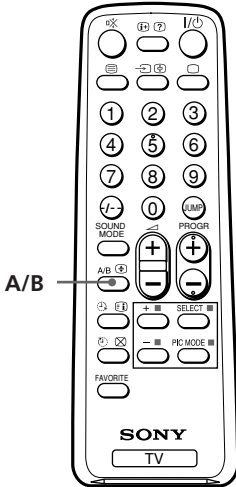

When receiving a NICAM program

Broadcasting	On-screen display (Selected sound)
NICAM stereo (KV-TG21M90 only)	NICAM (Stereo sound) → MONO (Regular sound)
NICAM bilingual	NICAM MAIN (Main sound) → NICAM SUB (Sub sound) → MONO (Regular sound)
NICAM monaural	NICAM MAIN (Main sound) → MONO (Regular sound)

When receiving an A2 program

► KV-TG21M90 only

Broadcasting	On-screen display (Selected sound)
A2 stereo	MONO (Regular sound) → STEREO (Stereo sound)
A2 bilingual	MAIN (Main sound) → SUB (Sub sound)

Notes

- If the sound is distorted when receiving a monaural program through the ㄗ (antenna) terminal, press A/B repeatedly until "MONO" appears on the screen. To cancel the monaural sound setting, press A/B again until "AUTO" appears on the screen.

KV-TG21M90 only

- If the stereo sound is noisy when receiving a stereo program, select "MONO". The sound becomes monaural, but the noise is reduced.
- Before receiving a NICAM stereo program in China, please check the NICAM broadcast condition in your area. When receiving a NICAM stereo program, the receiving conditions might vary depending on area. In addition, different strength of the NICAM broadcast signal might affect the receiving quality.

Free Manuals Download Website

<http://myh66.com>

<http://usermanuals.us>

<http://www.somanuals.com>

<http://www.4manuals.cc>

<http://www.manual-lib.com>

<http://www.404manual.com>

<http://www.luxmanual.com>

<http://aubethermostatmanual.com>

Golf course search by state

<http://golfingnear.com>

Email search by domain

<http://emailbydomain.com>

Auto manuals search

<http://auto.somanuals.com>

TV manuals search

<http://tv.somanuals.com>