

SERVICE MANUAL

BG-1S CHASSIS

MODEL COMMANDER DEST. CHASSIS NO.
KV-T29SN81 *RM-870* *New Zealand* *SCC-K37E-A*

MODEL COMMANDER DEST. CHASSIS NO.

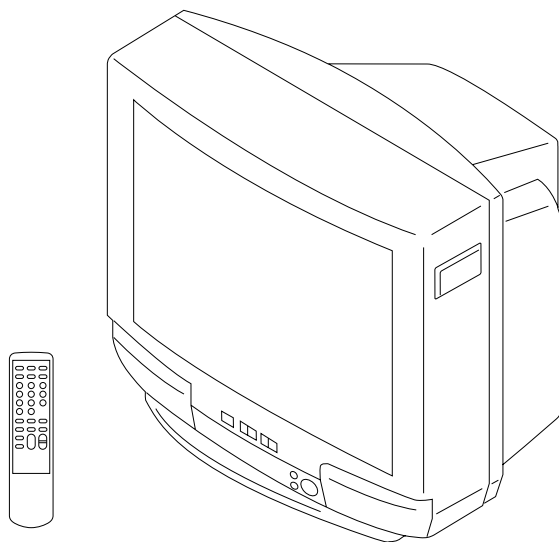

TRINITRON[®] COLOR TV
SONY[®]

SPECIFICATIONS

		Note
Power requirements	110-240 V AC, 50/60 Hz	
Power consumption (W)	Indicated on the rear of the TV	
Television system	B/G	
Color system	PAL, PAL 60, NTSC4.43, NTSC3.58 (AV IN)	
Stereo/Bilingual system	NICAM Stereo/Bilingual B/G, A2 Stereo/Bilingual (German) B/G	
Teletext language	English, German, Swedish, Italian, French, Spanish	
Channel coverage	VHF: 1 to 11/UHF: E21 to E69/CATV: S01 to S03, S1 to S41	
Audio output (speaker)	5W × 2	
Inputs	Antenna: 75 ohms	
	VIDEO IN jacks: phono jacks Video: 1 Vp-p, 75 ohms Audio: 500 mVrms, high impedance	
Outputs	Headphone jack: minijack	
	MONITOR OUT jacks: phono jacks Video: 1 Vp-p, 75 ohms Audio: 500 mVrms	
Picture tube	29 in.	
Tube size (cm)	72	Measured diagonally
Screen size (cm)	68	Measured diagonally
Dimensions (w/h/d, mm)	686 × 617 × 537	
Mass (kg)	43	

Design and specifications are subject to change without notice.

CAUTION

SHORT CIRCUIT THE ANODE OF THE PICTURE TUBE AND THE ANODE CAP TO THE METAL CHASSIS, CRT SHIELD, OR CARBON PAINTED ON THE CRT, AFTER REMOVING THE ANODE.

SAFETY-RELATED COMPONENT WARNING!!

COMPONENTS IDENTIFIED BY SHADING AND MARK \triangle ON THE SCHEMATIC DIAGRAMS, EXPLODED VIEWS AND IN THE PARTS LIST ARE CRITICAL TO SAFE OPERATION. REPLACE THESE COMPONENTS WITH SONY PARTS WHOSE PART NUMBERS APPEAR AS SHOWN IN THIS MANUAL OR IN SUPPLEMENTS PUBLISHED BY SONY. CIRCUIT ADJUSTMENTS THAT ARE CRITICAL TO SAFE OPERATION ARE IDENTIFIED IN THIS MANUAL. FOLLOW THESE PROCEDURES WHENEVER CRITICAL COMPONENTS ARE REPLACED OR IMPROPER OPERATION IS SUSPECTED.

TABLE OF CONTENTS

<u>Section</u>	<u>Title</u>	<u>Page</u>	<u>Section</u>	<u>Title</u>	<u>Page</u>
	SELF DIAGNOSIS REMOVAL	4	5. DIAGRAMS		
1. GENERAL		5	5-1. Block Diagram		25
2. DISASSEMBLY			5-2. Circuit Boards Location		29
2-1. Rear Cover Removal		11	5-3. Schematic Diagrams and Printed Wiring Boards		
2-2. A Board Removal		11	(1) Schematic Diagram of A Board		33
2-3. F1 Board Removal		11	(2) Schematic Diagrams of A3, F and V1 Boards		38
2-4. Service Position		11	(3) Schematic Diagrams of C and VM Boards		45
2-5. Replacement of Parts		12	5-4. Semiconductors		49
2-6. Demagnetization Coil Removal		12	6. EXPLODED VIEW		
2-7. Picture Tube Removal		13	6-1. Chassis		53
3. SET-UP ADJUSTMENTS			7. ELECTRICAL PARTS LIST		55
3-1. Beam Landing		14			
3-2. Convergence		15			
3-3. Focus Adjustment		18			
3-4. G2 (Screen) and White Balance Adjustments		18			
4. CIRCUIT ADJUSTMENTS					
4-1. Adjustments with Commander		19			
4-2. Adjustment Method		20			
4-3. A Board Adjustment after IC003 (Memory) Replacement		23			
4-4. Picture Distortion Adjustment		23			

SELF DIAGNOSIS FUNCTION

If no acknowledgement is returned from a device which is turned "ON", the device has a problem.
In this case, one of the LED's responding to the problem device will flicker a defined number of times.

Flickering is operated by lighting the LED's for 60ss each time.

The flickering frequency responding to each failed device is shown below.

Device	NONVOLATILE MEMORY	—	Y/C JUNGLE	—	—	AUDIO PROCESSOR (TDA8424)
Flickering Frequency	1	—	3	—	—	6

All the devices are checked one after another from the left of the table.
If an error is found, the responding LED will start flickering.
So, if more than 1 device have failed, only the one on the left side will flicker.

SECTION 1 GENERAL

The operating instructions mentioned here are partial abstracts from the Operating Instructions Manual. The page numbers of the Operating Instruction Manual remain as in this manual.

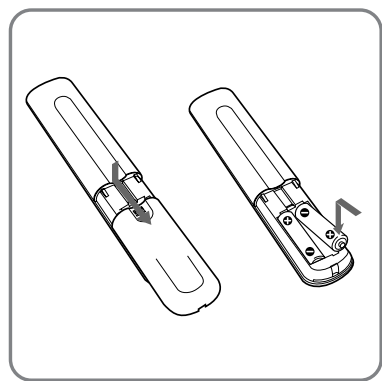
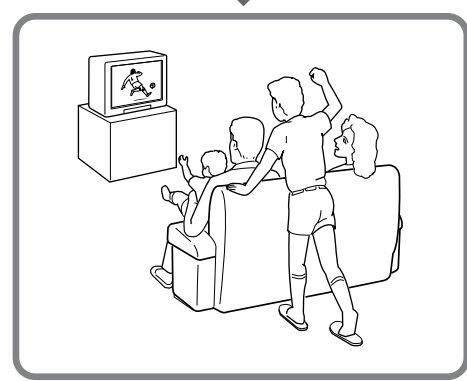
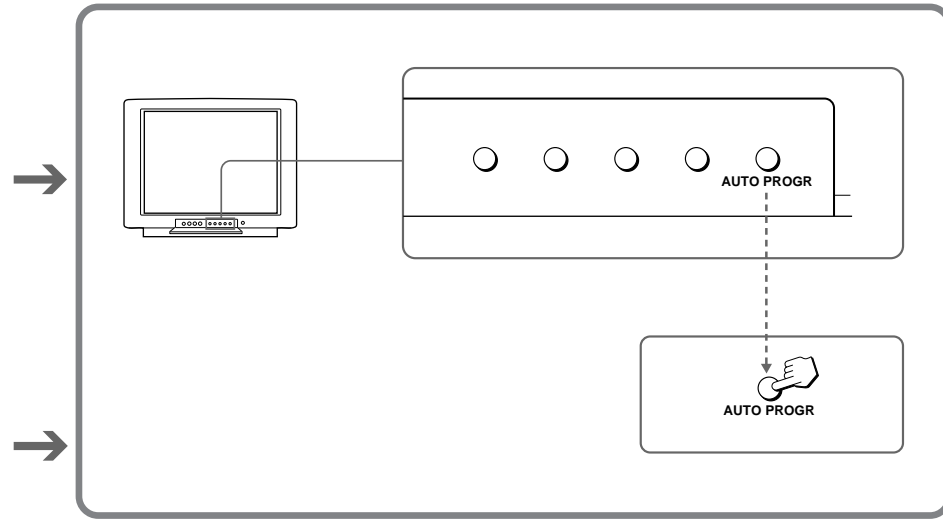
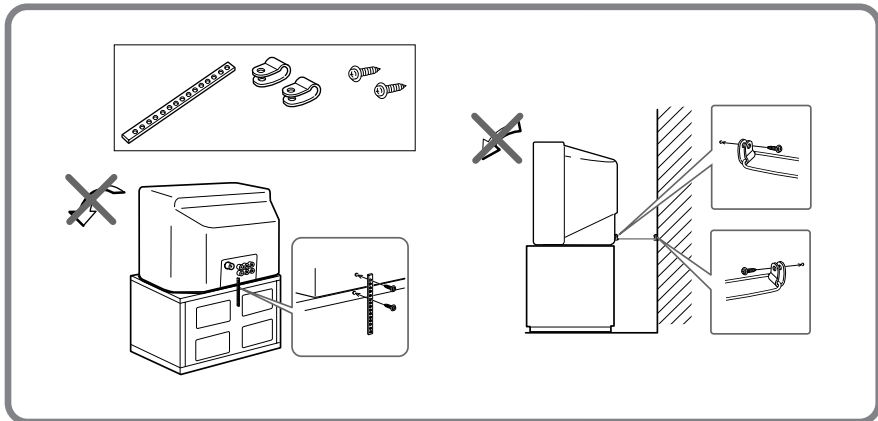
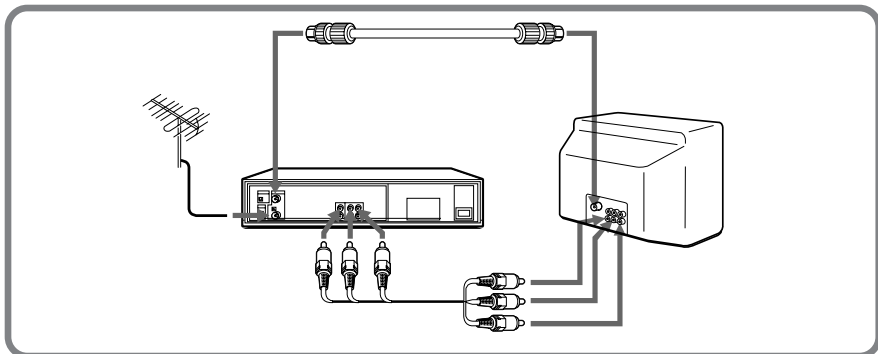
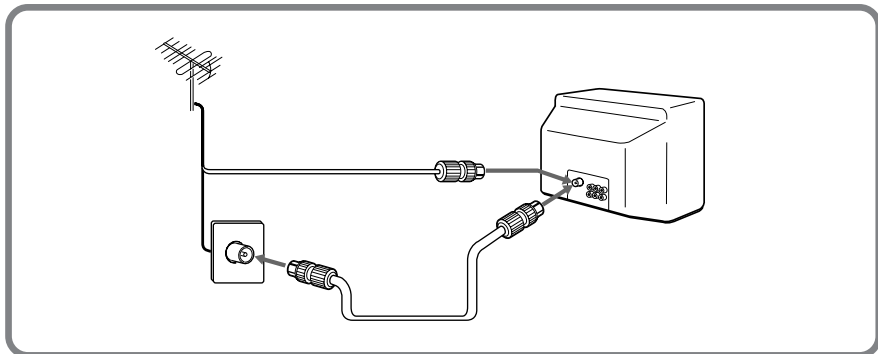

Connections

Connecting a VHF antenna or a combination VHF/UHF antenna — 75-ohm coaxial cable (round)

Attach an optional IEC antenna connector to the 75-ohm coaxial cable. Plug the connector into the Π (antenna) socket at the rear of the TV.

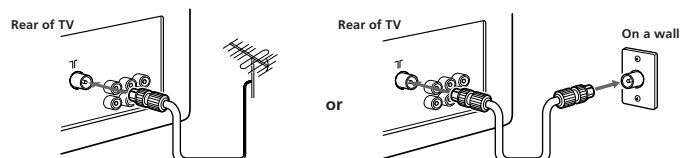

Connecting optional equipment

You can connect optional audio/video equipment to your TV such as a VCR, multi disc player, camcorder, video game or stereo system.

Connecting video equipment using video input jacks

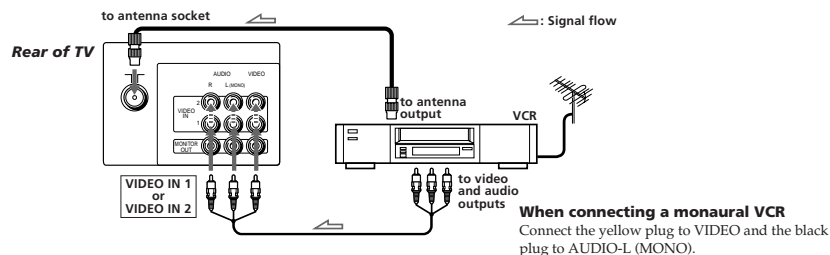

Front of TV

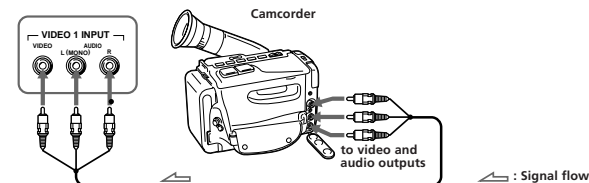

When using the video input jacks

Do not connect video equipment to the video input jacks at the front and the rear (VIDEO IN 1 for this model) of your TV simultaneously; otherwise the picture will not be displayed properly on the screen.

Connecting audio/video equipment using MONITOR OUT jacks

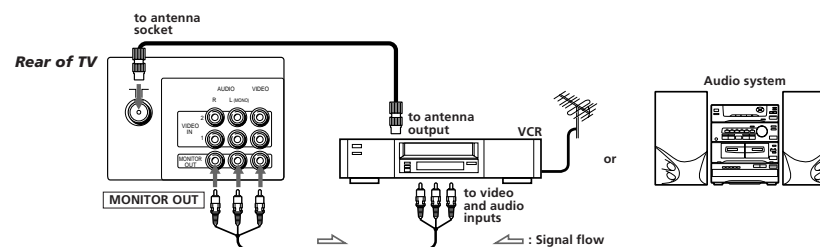

When recording through the MONITOR OUT jacks

If you change the channel or video input while recording with a VCR, the channel or video input you are recording also will be changed.

CAUTION

Do not connect the power cord until you have completed making all other connections; otherwise a minimum leakage current might flow through the antenna and other terminals to ground.

Presetting channels

Presetting channels automatically

You can preset up to 80 TV channels in numerical sequence from program position 1.

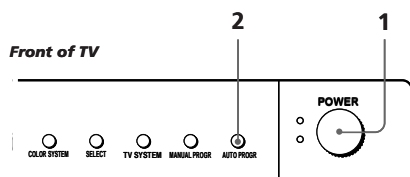

1 Press POWER.



When the TV is in standby mode after pressing POWER, press POWER on the remote commander.

2 Press AUTO PROGR.

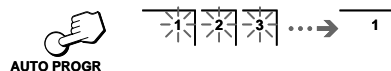

To start presetting channels automatically from the specified program position

- 1 Press MANUAL PROGR.
- 2 Press PROGR +/- to select the program position.
- 3 Press AUTO PROGR.

Presetting channels manually

To change the channel for a particular program position or to receive a channel with a weak signal, preset the channel manually.

- 1 Press **MANUAL PROGR.**
- 2 Press **PROGR +/-** until the required program position appears on the screen.
- 3 Press **VOLUME +/-** on the TV until the required channel picture appears on the screen.
- 4 Press **MANUAL PROGR.**

Disabling program positions

By disabling unused or unwanted program positions, you can skip those positions when you press PROGR +/-.

- 1 Press **PROGR +/-** until the unused or unwanted program position appears on the screen.
- 2 Press **MANUAL PROGR.**
- 3 Press **PIC MODE** on the remote commander.
- 4 Press **MANUAL PROGR.**

To cancel the skip setting

Preset the channel manually or automatically again.

Operations

Watching the TV

1 Press POWER to turn the TV on.



When the TV is in standby mode after pressing POWER, press POWER on the remote commander.

2 Select the TV channel you want to watch.

To select a channel directly

Press a number button.

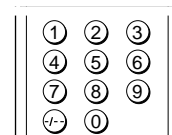

To select a two-digit channel, press "-/-" before the number buttons.

For example: to select channel 25, press "-/-," and then "2" and "5."

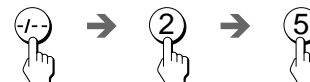

To scan through channels

Press PROGR +/- until the channel you want appears.



3 Press VOL +/- to adjust the volume.



Switching off the TV

To switch off the TV temporarily, press POWER on the remote commander.

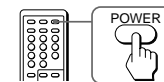

To switch off the TV completely, press POWER on the TV.

If the power on the TV is turned off in standby mode, the STANDBY indicator may remain alight for a while.



Watching the video input

Press VIDEO/HOLD.

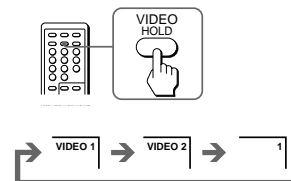

To watch TV, press TV.

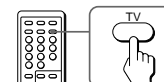

Muting the sound

Press MUTING.

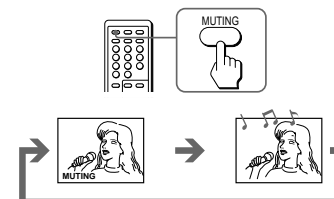

Displaying on-screen information

Press DISPLAY/REVEAL.

The program position, local system, and TV settings are displayed on the screen.

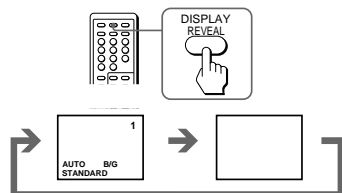

Setting the Wake Up Timer

You can set the TV to turn on automatically after the period of time you want.

1 Press WAKE UP/INDEX repeatedly to set the timer.

The on-screen display appears and the WAKE UP indicator lights up.

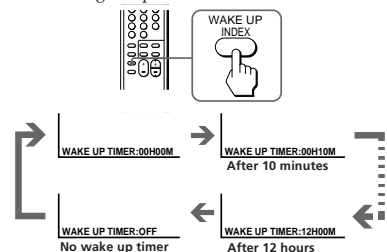

2 If you want a particular TV program or video input to be displayed using the Wake Up Timer, select the TV program or video mode.

3 Press POWER on the remote commander or set the Sleep Timer to turn off the TV in standby mode.

To cancel the Wake Up Timer, press WAKE UP/INDEX repeatedly until "WAKE UP TIMER: OFF" appears, or turn off the main power of the TV.

Notes

- The Wake Up Timer starts immediately after the on-screen display disappears.

8 Operations

- The last TV program position or video mode just before the TV turns into Standby mode will appear when the TV turns on using the Wake Up Timer.
- If no buttons or controls are pressed for more than two hours after the TV is turned on using the Wake Up Timer, the TV automatically turns into standby mode. When you want to continue watching the TV, press any button or control on the TV or remote commander.

Setting the Sleep Timer

You can set the TV to turn off automatically after the period of time you want.

Press SLEEP.

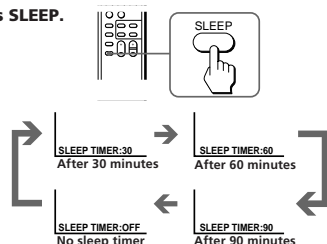

To cancel the Sleep Timer, press SLEEP repeatedly until "SLEEP TIMER: OFF" appears, or turn the TV off.

Changing the on-screen display language

If you prefer Chinese to English, you can change the on-screen display language. You can use buttons on both the remote commander and the TV.

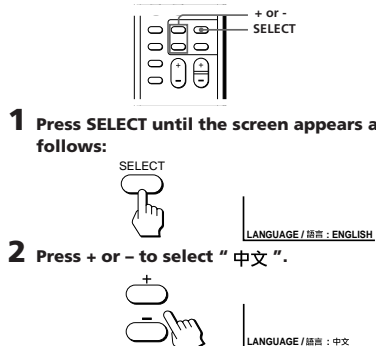

Note

- You can also use VOLUME +/- on the TV to select the on-screen display language.

Adjusting the picture and sound

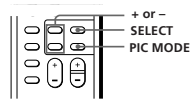

Selecting the picture mode

Press PIC MODE until the mode you want appears.



Each time you press PIC MODE, the screen changes as follows:



Note

- If you change the picture mode after the following adjustments, the adjustment changes in accordance with the picture mode.

Adjusting the picture and sound settings

1 Press SELECT until the item you want to adjust appears.



Each time you press SELECT, the screen changes as follows:

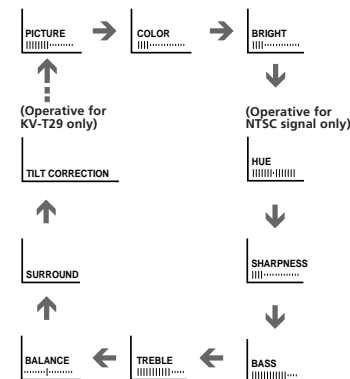

Note on TILT CORRECTION (KV-T29 only)

- The earth's magnetic field may affect the tilt of the TV picture. You can adjust the picture tilt using TILT CORRECTION.

2 Press + or - to adjust the item.



3 To adjust other items, repeat steps 1 and 2.

Note

- You can also use VOLUME +/- on the TV to adjust the picture and sound settings.

If the color of the picture is abnormal

Press COLOR SYSTEM or adjust the color setting until the color becomes normal.

Note

- Normally set COLOR SYSTEM to AUTO.

Front of TV

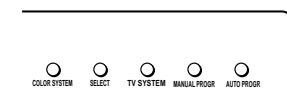

Selecting a stereo or bilingual program

Press **A/B/ENLARGE** repeatedly until you receive the sound you want.

The on-screen display changes corresponding to the selected sound and the WAKE UP/STEREO indicator also lights up.

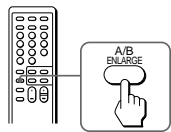

When receiving a NICAM program

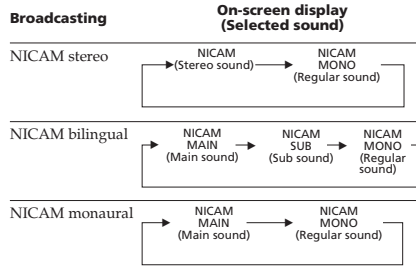

When receiving a A2 (German) program

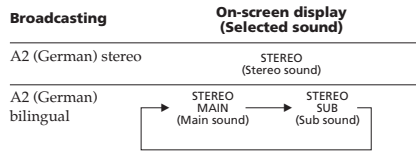

Receiving area for NICAM and A2 (German) programs

System	Receiving area
NICAM	Hong Kong, Singapore, New Zealand, etc.
A2 (German)	Australia, Malaysia, Thailand, etc.

Notes

- If the signal is very weak, the sound becomes monaural automatically.
- If the stereo sound is noisy, select "regular sound." The sound becomes monaural, however, the noise will be reduced.

Viewing Teletext

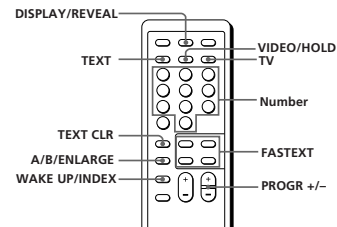

Displaying Teletext

- 1 Select a TV channel which carries the Teletext broadcast you want to watch.
- 2 Press **TEXT** to display the Teletext. A Teletext page is displayed (normally the index page). If there is no Teletext broadcast, 100 is displayed at the top left corner of the screen.

To cancel the Teletext display, press **TV**.

Superimposing a Teletext page on the TV picture

Press **TEXT**.

Each time you press **TEXT**, the screen changes as follows:



Checking the contents of a Teletext service (INDEX)

Press **WAKE UP/INDEX** to display an overview of the Teletext contents and page numbers.

Using FASTEXT

This feature allows you to quickly access a Teletext page that uses FASTEXT. When a FASTEXT page is broadcasted, a color-coded menu appears at the bottom of the screen. The colors of the menu correspond to the RED, GREEN, YELLOW, and CYAN buttons on the remote commander.

Press the color button which corresponds to the color-coded menu.

The page is displayed after a few seconds.

Selecting a Teletext page

To input the three-digit number of the Teletext page, press the number buttons. If you make a mistake, key in the correct page number again.

To access the next or previous page, press **PROGR +/-**.

Holding a Teletext page (subpage)

Press **VIDEO/HOLD**.

The HOLD symbol "Ⓜ" is displayed at the top left corner of the screen.

To resume normal Teletext operation, press **VIDEO/HOLD** again or **TEXT**.

Revealing concealed information

Press **DISPLAY/REVEAL**.

To conceal the information, press **DISPLAY/REVEAL** again.

Enlarging the Teletext display

Press **A/B/ENLARGE**.

Each time you press **A/B/ENLARGE**, the Teletext display changes as follows:



Waiting for a Teletext page while watching a TV program (TEXT CLEAR)

- 1 Key in the page number of the Teletext that you want to refer, then press **TEXT CLR**.
- 2 When the page number is displayed on the screen, press **TEXT** to switch the Teletext on.

Additional Information

Troubleshooting

If you have any problems, read this manual again and check the countermeasure for each of the symptoms listed below.

If the problem persists, contact your nearest authorized service center or dealer.

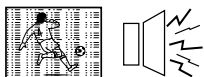
Snowy picture
Noisy sound

- ➔ Check the antenna.
- ➔ Check the antenna connection on the TV and on the wall.

Dotted lines or stripes

- ➔ This may be caused by local interference (e.g. cars, neon signs and hair dryers). Adjust the antenna for minimum interference.

Double images or "ghosts"



- ➔ This may be caused by reflections from nearby mountains or buildings. A highly directional antenna may improve the picture.

Notes

- When you switch on the TV, you may hear the "boon" sound that is caused by the demagnetization of the TV. This does not indicate a malfunction.
- The picture color may become abnormal if you change the direction of your TV. To obtain the normal picture color, press POWER on the TV to switch off the TV for five minutes and then switch it on again.

No picture
No sound

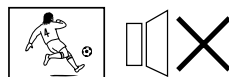
- ➔ Press POWER.
- ➔ Check the antenna connection.
- ➔ Check the VCR connections.
- ➔ Check the power cord connection.
- ➔ Check the standby mode.

Good picture
No sound

- ➔ Press VOLUME +.
- ➔ Press MUTING.
- ➔ Press A/B/ENLARGE

No color

- ➔ Adjust the COLOR level in the on-screen display.
- ➔ Check the COLOR SYSTEM setting.

TV cabinet creaks

- ➔ Even if the picture or the sound is normal, changes in the room temperature sometimes make the TV cabinet expand or contract, making a noise. This does not indicate a malfunction.

Note on the remote commander

- The supplied remote commander is used on several models of the TV. If you do not find instructions for some controls that are on the remote commander, that means your TV does not employ the features of those controls, e.g. TEXT.

Note on the TV SYSTEM button

- The TV SYSTEM button is not used on your TV.

WARNING

Do not install the appliance in a confined space, such as a bookcase or built-in cabinet.

SECTION 2 DISASSEMBLY

2-1. REAR COVER REMOVAL

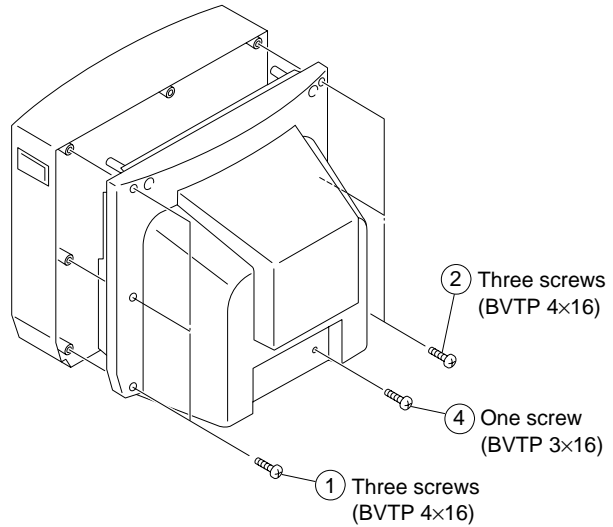

2-3. F1 BOARD REMOVAL

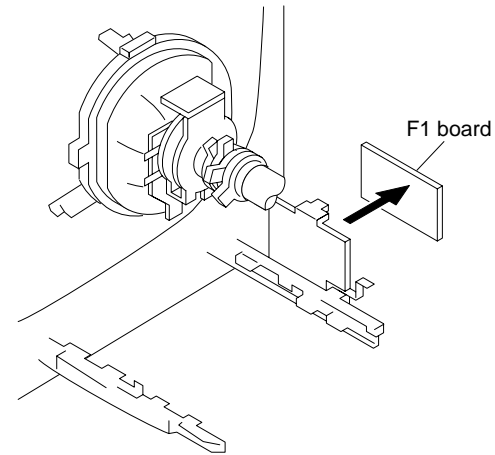

2-2. A BOARD REMOVAL

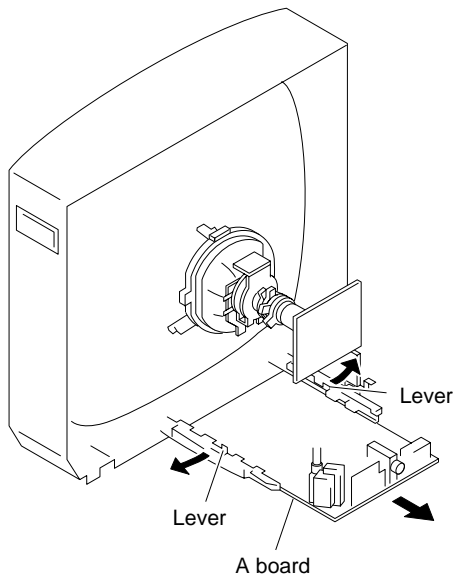

2-4. SERVICE POSITION

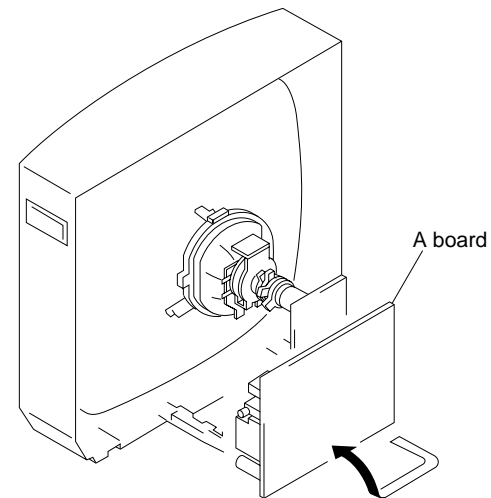

2-5. REPLACEMENT OF PARTS

For replacement of the Multi Button, Power Button and Light Guide, cut the welded portions from them, exchange with the new parts, and fix them with screws (+BVTP) respectively.

2-5-1. REPLACEMENT OF MULTI BUTTON

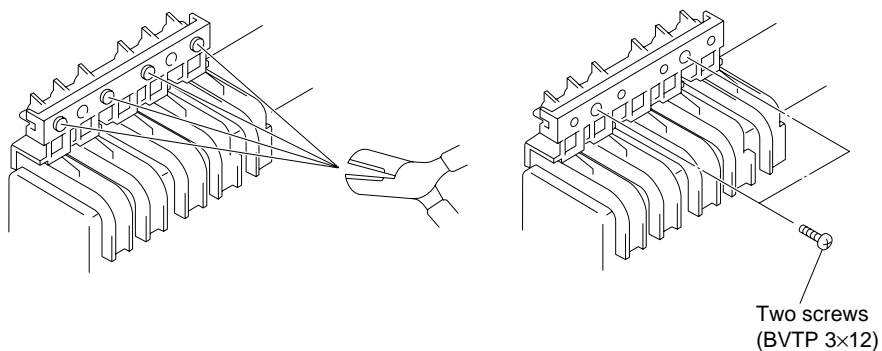

2-5-2. REPLACEMENT OF LIGHT GUIDE POWER BUTTON

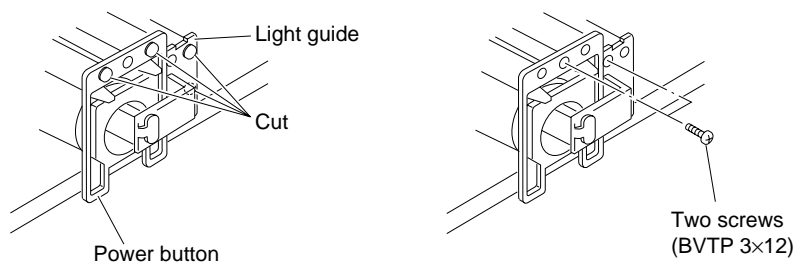

2-6. DEMAGNETIZATION COIL REMOVAL

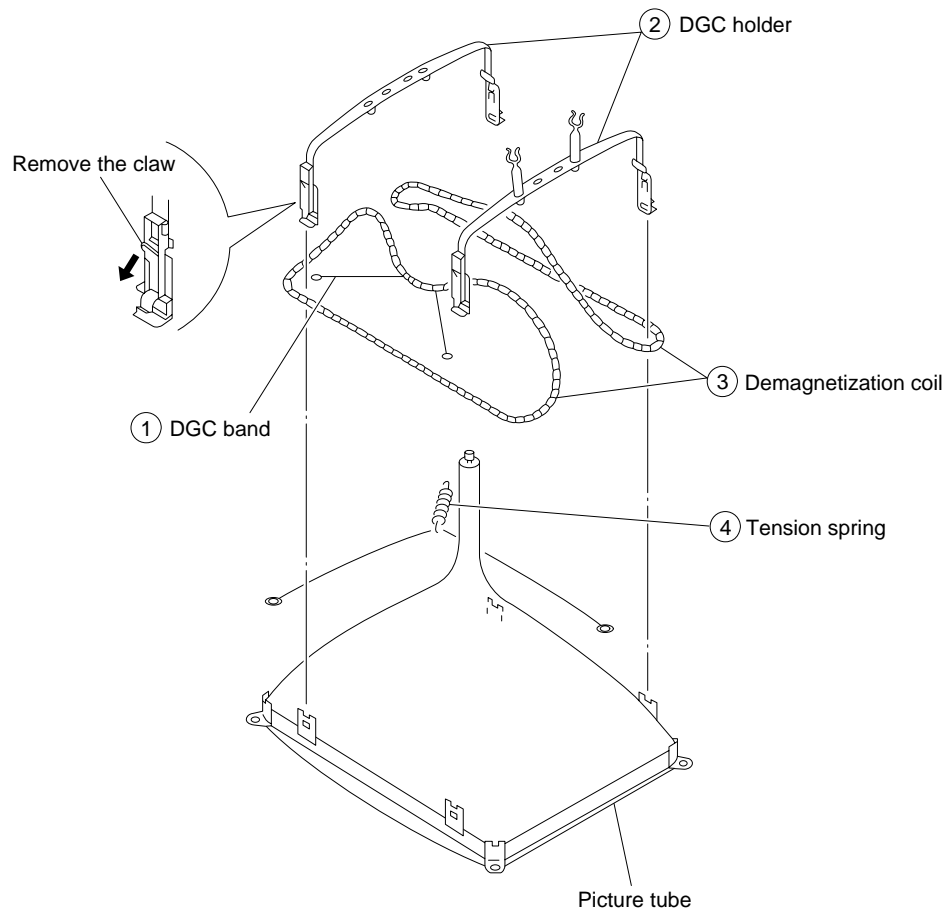

2-7. PICTURE TUBE REMOVAL

NOTE : The picture tube for this model is upside-down and the position for the anode-cap and tension spring is changed accordingly

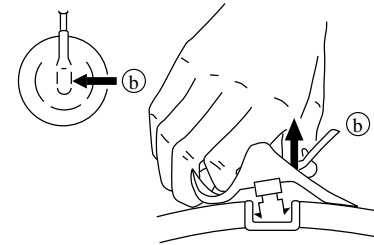
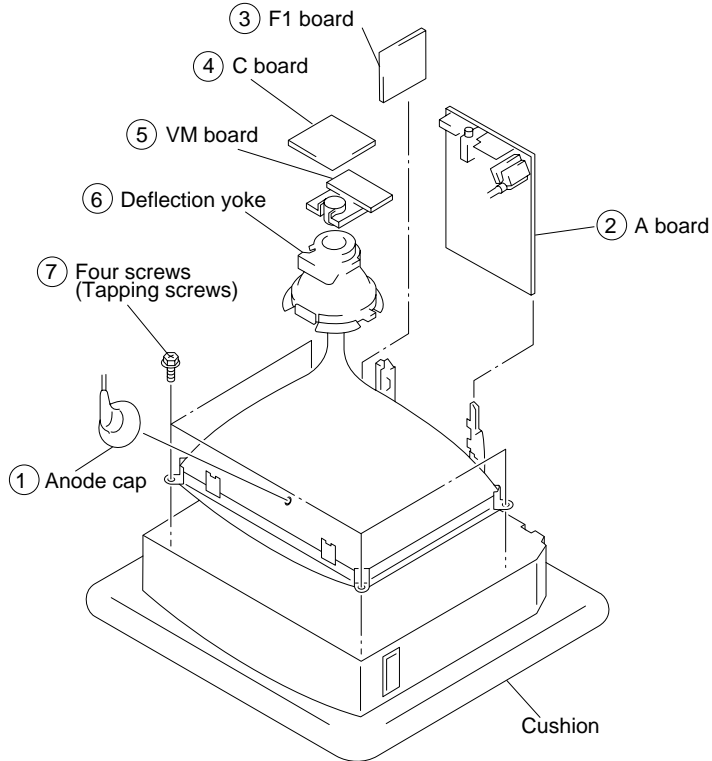

- ② Using a thumb press down then pull up the rubber cap firmly in the direction indicated by the arrow ②.

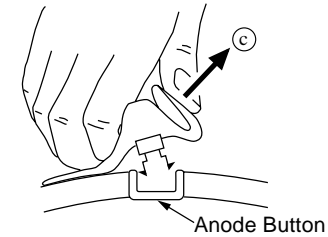

- ③ When one side of the rubber cap is separated from the anode button, the anode-cap can be removed by turning up the rubber cap and pulling it up in the direction of the arrow ③.

• HOW TO HANDLE AN ANODE-CAP

- ① Do not damage the surface of anode-caps with sharp shaped objects.
- ② Do not press the rubber too hard so as not to damage the inside of anode-caps. A metal fitting called the shatter-hook terminal is built into the rubber.
- ③ Do not turn the foot of rubber over too hard. The shatter-hook terminal will stick out or damage the rubber.

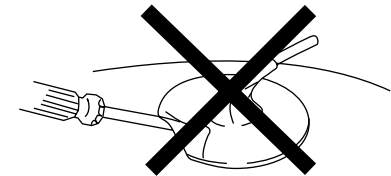
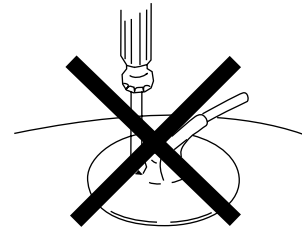

- ① Turn up one side of the rubber cap in the direction indicated by the arrow ①.

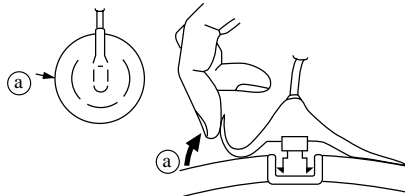

SECTION 3 SET-UP ADJUSTMENTS

- The following adjustments should be made when a complete realignment is required or a new picture tube is installed.
- These adjustments should be performed with rated power supply voltage unless otherwise noted.

Controls and switch should be set as follows unless otherwise noted:
 PICTURE control normal
 BRIGHTNESS control normal

Perform the adjustments in order as follows :

1. Beam Landing
2. Convergence
3. Focus
4. White Balance

Note : Test Equipment Required.

1. Color-bar/Pattern Generator
2. Degausser
3. Oscilloscope

Preparation :

- In order to reduce the influence of geomagnetism on the set's picture tube face it east or west.
- Switch on the set's power and degauss with the degausser.

3-1. BEAM LANDING

1. Input a white signal with the pattern generator.
 Contrast } normal
 Brightness }
2. Position neck assy as shown in Figure 3-1.
3. Set the pattern generator raster signal to green.
4. Move the deflection yoke to the rear and adjust with the purity control so that the green is at the center and the blue and the red take up equally sized areas on each side.
 (See Figures 3-1 through 3-3.)
5. Move the deflection yoke forward and adjust so that entire screen is green. (See Figure 3-1.)
6. Switch the raster signal to blue, then to red and verify the condition.
7. When the position of the deflection yoke has been decided, fasten the deflection yoke with the screws.
8. If the beam does not land correctly in all the corners, use a magnet to adjust it. (See Figure 3-4.)

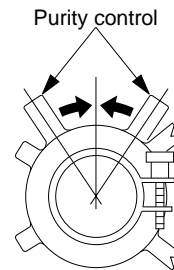

Fig. 3-2

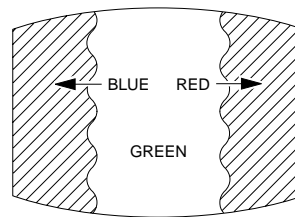

Fig. 3-3

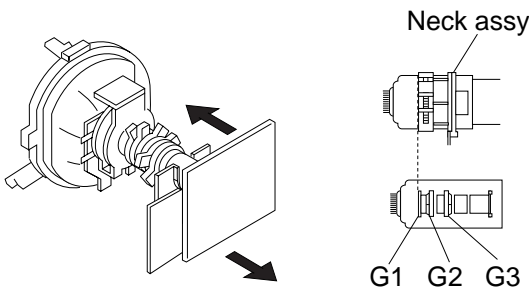

Fig. 3-1

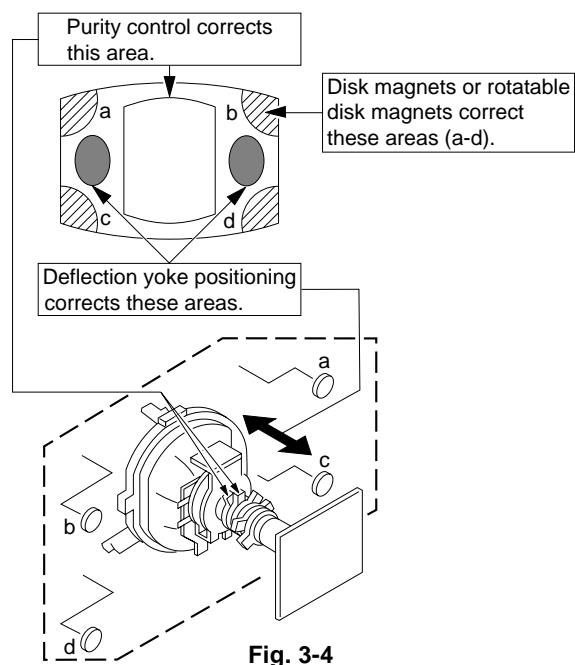

Fig. 3-4

3-2. CONVERGENCE

Preparation :

- Before starting this adjustment, adjust the focus, horizontal size, and vertical size.
- Minimize the brightness setting.
- Provide dot pattern.

(1) Horizontal and Vertical Static Convergence

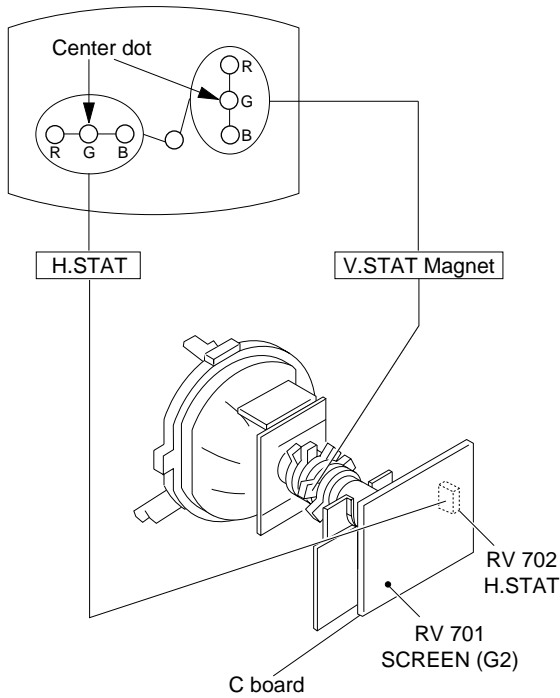

1. (Moving vertically), adjust the V.STAT magnet so that the red, green, and blue points are on top of each other at the center of the screen.
2. (Moving horizontally), adjust the H.STAT VR magnet so that the red, green, and blue points are on top of each other at the center of the screen.

- If the V.STAT magnet is moved in the direction of the (a) and (b) arrows, the red, green, and blue points move as shown below.

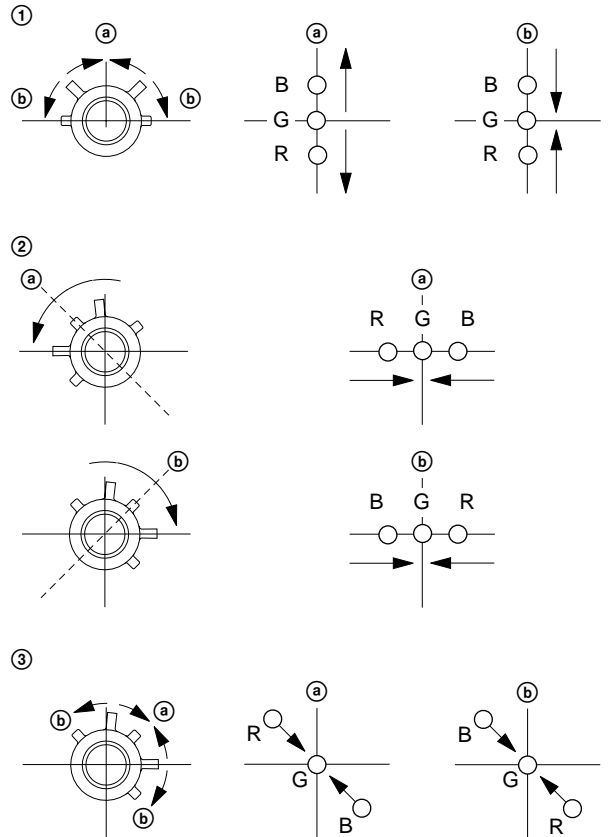

- Operation of BMC (Hexapole) Magnet

If the red, green and blue dots are not balanced or aligned, then use the BMC magnet to adjust in the manner described below.

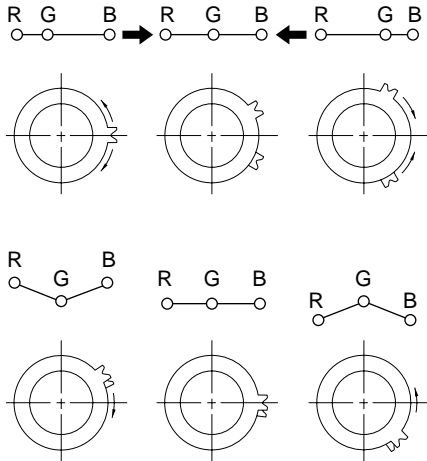

- Then use the H.STAT VR to adjust the red, green, and blue dots so that they coincide at the center of screen.

The respective dot position resulting from moving each magnet interact, so be sure to perform adjustment while tracking.

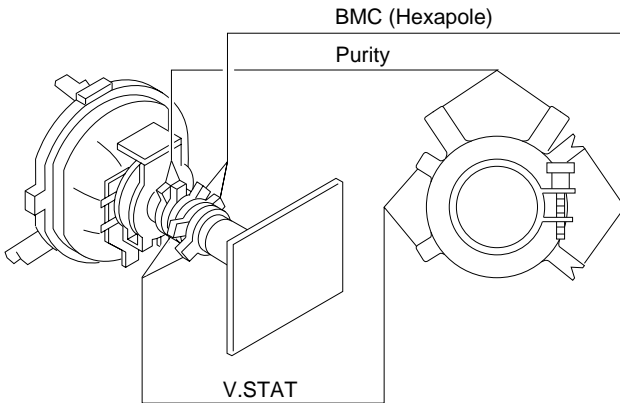

- Y separation axis correction magnet adjustment.

1. Receive the cross-hatch signal and adjust [PICTURE] to "MIN" and [BRIGHTNESS] to "STANDARD".
2. Adjust the Y separation axis correction magnet on the neck assembly so that the horizontal lines at the top and bottom of the screen are straight.

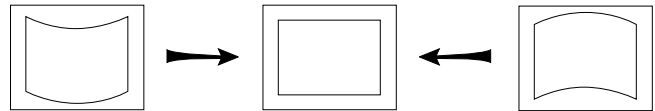
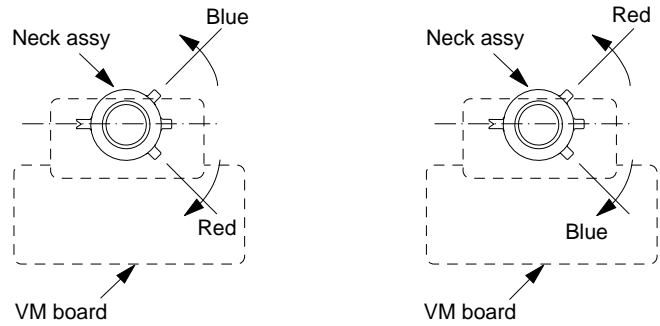

- Note:**
- 1) The Red and Blue magnets should be equally far from the horizontal center line.
 - 2) Do not separate the Red and Blue magnets too far. (Less than 8 mm)

(2) Dynamic Convergence Adjustment

Preparation :

- Before starting this adjustment, adjust the horizontal static convergence and the vertical static convergence.
1. Slightly loosen the deflection yoke screws.
 2. Remove the deflection yoke spacer.
 3. Move the deflection yoke as shown in the figure below and optimize the convergence.
 4. Tighten the deflection yoke screws.
 5. Install the deflection yoke spacer.

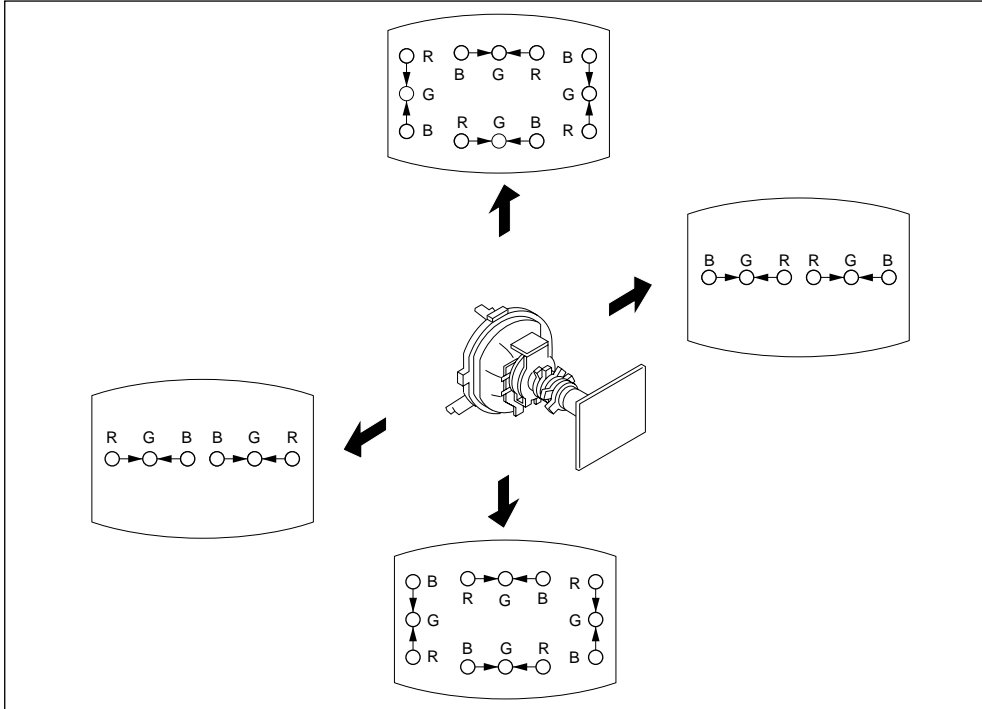

(3) Screen-corner Convergence

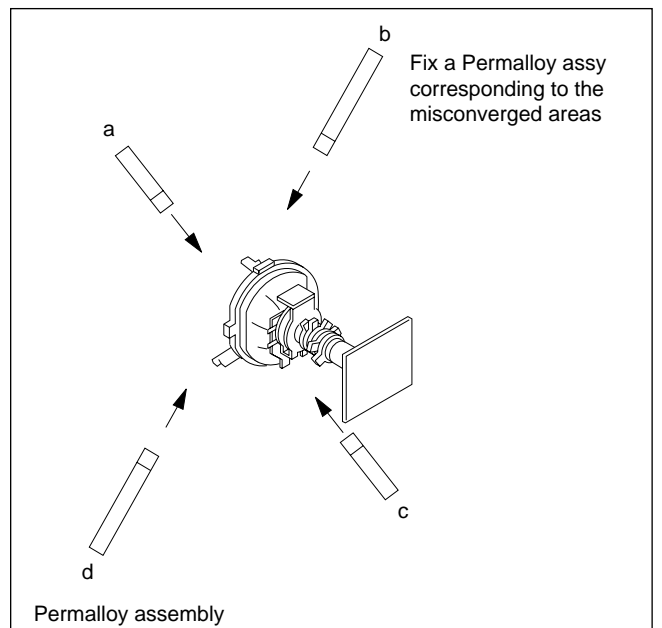
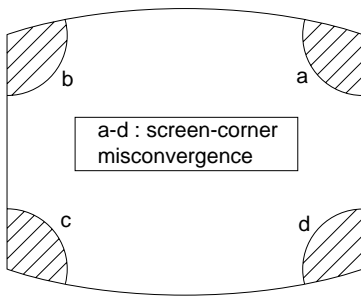

3-3. FOCUS ADJUSTMENT

Adjust FOCUS control on the flyback transformer for the best focus.

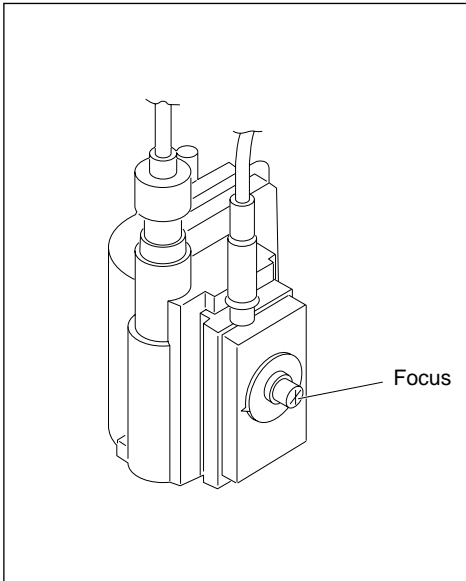

Note: Screen VR is not use.

a. AN ITEM OF ADJUSTMENT

Item number	Adjustment item	Initial DATA	Note
09	RDR	25	WHITE POINT R
0A	GDR	20	WHITE POINT G
0B	BDR	20	WHITE POINT B

b. METHOD OF CANCELLATION FROM SERVICE MODE

Set the standby condition (Press **POWER** button on the commander) and then press **POWER** button again, hereupon it becomes TV mode.

c. METHOD OF WRITE FOR MEMORY

- 1) Set to Service Mode.
- 2) Press **1** (UP) and **4** (DOWN) to select an item of adjustments.
- 3) Press **MUTING** button and it will indicate WRITE on screen.
- 4) Press **0** button to write into memory.

d. MEMORY WRITE CONFIRMATION METHOD

- 1) After adjustment, pull out the plug from AC outlet, and then plug into AC outlet again.
- 2) Turn the power switch ON and set to Service Mode.
- 3) Call the adjusted items again, confirm they were adjusted.

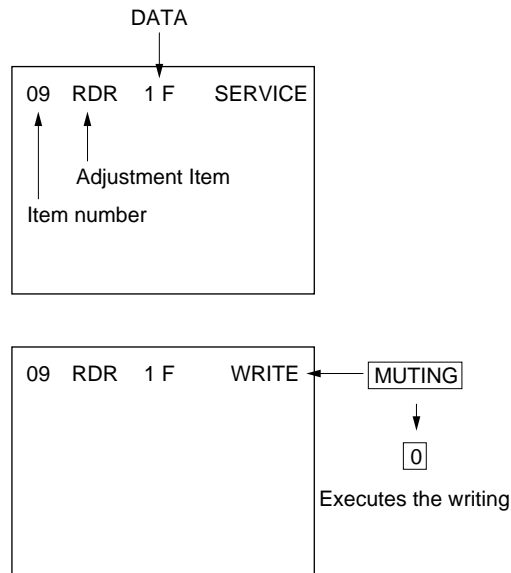

3-4. G2 (SCREEN) AND WHITE BALANCE ADJUSTMENTS

1. G2 (SCREEN) ADJUSTMENT (RV701)

- 1) Set the PICTURE and BRIGHTNESS to normal.
- 2) Put to VIDEO input mode without signals.
- 3) Connect R, G, and B of the C board cathode to the oscilloscope.
- 4) Adjust G2 (RV701) volume to the value below.

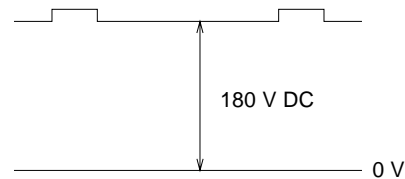

2. WHITE BALANCE ADJUSTMENTS

- 1) Set the Service Mode.
- 2) Input an entire white signal.
- 3) Set the PICTURE to maximum.
- 4) Select RDR(09) with **1** and **4**, and then set the level to 25 with **3** and **6**.
- 5) Select GDR(0A) and BDR(0B) with **1** and **4** and adjust the level with **3** and **6** for the best white balance.
- 6) Write into the memory by pressing **MUTING** → then **0**.

SECTION 4 CIRCUIT ADJUSTMENTS

4-1. ADJUSTMENTS WITH COMMANDER

Service adjustments are made with the RM-870 that comes with this unit.

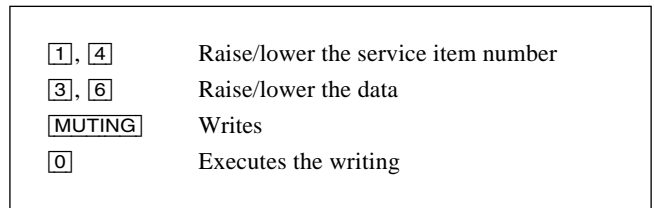
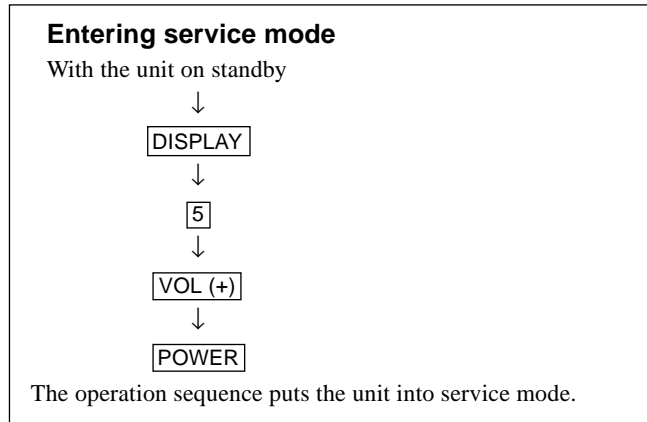

- [7], [0] The data all becomes the values in memory
- [8], [0] User control all goes to the standard state
- [5], [0] Service data initialization (Be sure not to use usually.)
- [2], [0] Write 50Hz adjustment data to 60Hz, or viceversa.

The screen display is :

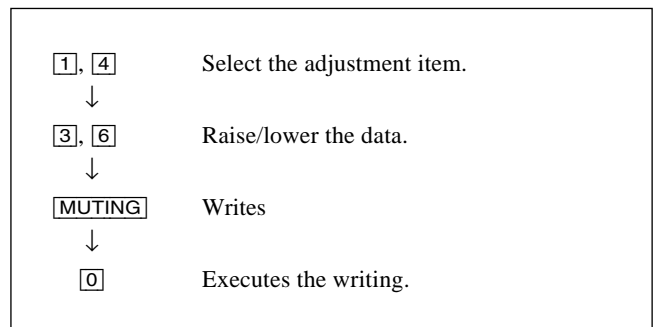
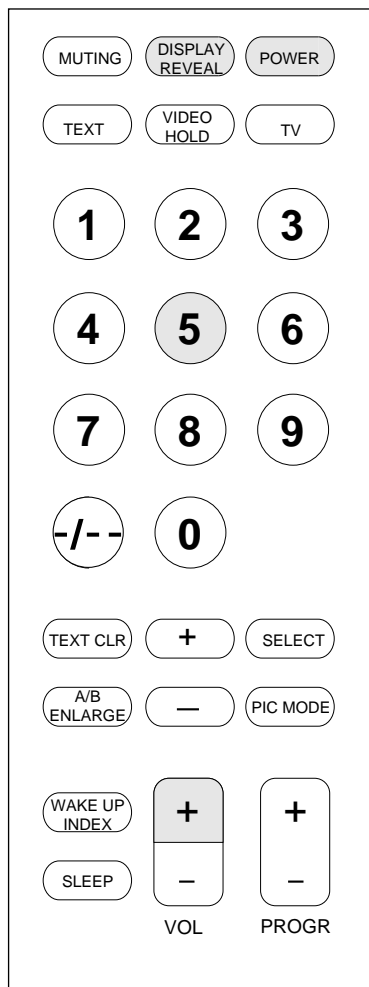
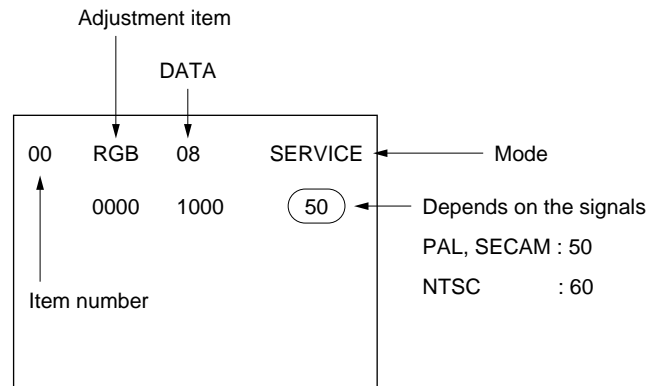

RM-870

4-2. ADJUSTMENT METHOD

Item Number 08

This explanation uses V-SHIFT as an example.

1. Select 08 V-SHIFT with the [1] and [4] buttons.
2. Raise/lower the data with the [3] and [6] buttons.
3. Select the optimum state. (The standard is 0F for PAL reception.)
4. Write with the [MUTING] button.
5. Execute the writing with the [0] button. (The WRITE display returns to green SERVICE.)

Use the same method for Items Number 00-4B. Use [1] and [4] to select the adjustment item, use [3] and [6] to adjust, write with [MUTING], then execute the write with [0].

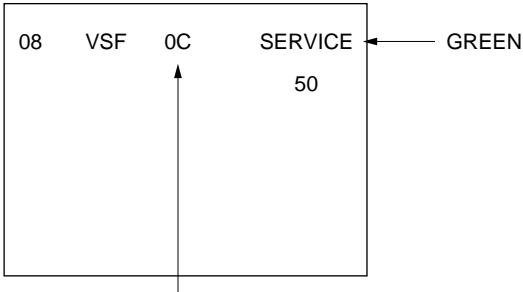

Adjust with the [3] and [6] buttons.

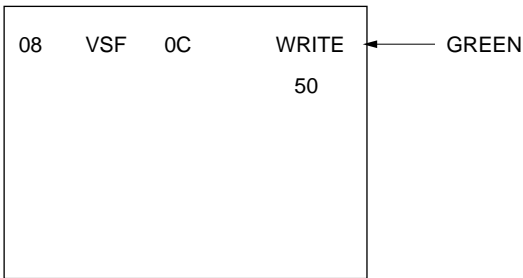

Written with the [MUTING].

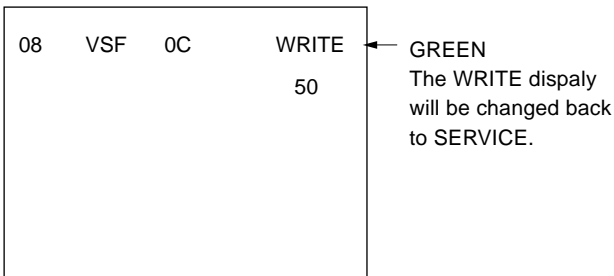

Write executed with [0].

Adjustment Item Table

Item number	Adjustment Item	Data range	Initial data	Standard data	Note	Device
00	HSF	00-3F	2		H SHIFT	TDA8375A
01	HSZ	00-3F	23		H SIZE	TDA8375A
02	PAP	00-3F	21		PIN AMPLITUDE	TDA8375A
03	CNP	00-3F	29		CORNER PIN	TDA8375A
04	TLT	00-3F	20		TILT	TDA8375A
05	VSL	00-3F	20		V SLOPE	TDA8375A
06	VAP	00-3F	1D		V AMPLITUDE	TDA8375A
07	SCR	00-3F	20		S CORRECTION	TDA8375A
08	VSF	00-3F	20		V SHIFT	TDA8375A
09	RDR	00-3F	25		WHITE POINT R	TDA8375A
0A	GDR	00-3F	20		WHITE POINT G	TDA8375A
0B	BDR	00-3F	20		WHITE POINT B	TDA8375A
0C	FO	00-03	00		PHI-1 TIME CONSTANT	TDA8375A
0D	AGC	00-3F	30		AGC TAKE OVER	TDA8375A
0E	VSW	00-01	00		VIDEO MUTE	TDA8375A
0F	FOR	00-03	00		FORCED FIELD FREQ.	TDA8375A
10	DL	00-01	00		INTERLACE	TDA8375A
11	POC	00-01	00		SYNCHRO MODE FIX	TDA8375A
12	VID	00-01	00		VIDEO IDENT MODE	TDA8375A
13	HCO	00-01	00		EHT TRACKING MODE	TDA8375A
14	EVG	00-01	00		ENABLE V GUARD	TDA8375A
15	SBL	00-01	00		SERVICE BLANKING	TDA8375A
16	PRD	00-01	00		OVER-VOLTAGE INPUT	TDA8375A
17	COR	00-01	00		NOISE CORING PEAK	TDA8375A
18	PMX	00-3F	27		PICTURE MAX DATA	TDA8375A
19	PMI	00-3F	05		PICTURE MIN DATA	TDA8375A
1A	SBR	00-7F	4B		SUB-BRIGHTNESS	TDA8375A
1B	SHU	00-0F	07		SUB-HUE	TDA8375A
1C	SSH	00-03	01		SUB-SHARPNESS	TDA8375A
1D	SC1	00-3F	1F		SUB-COLOR LOWER	TDA8375A
1E	SC2	00-3F	0B		SUB-COLOR HIGHER	TDA8375A
1F	AIP	00-7F	3F		ADJUSTMENT IF PLL	TDA8375A
20	VZM	00-3F	19		VERTICAL ZOOM	TDA8375A
21	FAW	00-FF	08		NICAM FAW THRESH	MSP3410
22	CTM	00-FF	08		NICAM ERROR BIT (MONO)	MSP3410
23	CTN	00-FF	50		NICAM ERROR BIT (NICAM)	MSP3410
24	WCD	00-FF	0A		W. G. CHANGE DATA	MSP3410
25	WST	00-FF	15		W. G. STEREO CUT POINT	MSP3410
26	WTM	00-FF	50		W. G. TIMER CHANGE	MSP3410
27	WBT	00-FF	EA		W. G. BILINGUAL	MSP3410
28	ACG	00-01	01		AGC AUTO/CONST.	MSP3410
29	CDB	00-3F	28		AGC GAIN CONST.	MSP3410
2A	FGP	00-7F	24		FM (BG, I, DK) PRESCALE	MSP3410
2B	FMP	00-7F	40		FM (M) PRESCALE	MSP3410
2C	WGP	00-7F	3C		W. G. PRESCALE	MSP3410
2D	NIP	00-7F	7F		NICAM PLESCALE	MSP3410
2E	CRM	00-01	00		CARRIER MUTE	MSP3410
2F	CML	00-03	00		CARRIER MUTE LEVEL	MSP3410
30	ACO	00-01	01		AUDIO CLOCK OUT	MSP3410
31	WAC	00-01	01		W. G. AGREEMENT COUNT	MSP3410
32	DLY	00-FF	30		STEREO SEARCH DELAY	MSP3410
33	DLG	00-FF	10		INTERVAL OF ID CHECK	MSP3410
34	TXP	00-0F	09		TEXT PICTURE CONT.	SAA5281
35	MXP	00-0F	0D		TEXT MIX MODE PICTURE	SAA5281

Adjustment Item Table

Item number	Adjustment Item	Data range	Initial data	Standard data	Note	Device
36	BKP	00-3F	00		BLK OFF PICTURE	u.CON
37	HBL	00-3F	25		H BLK LEFT WIDTH	u.CON
38	HBR	00-3F	20		H BLK RIGHT WIDTH	u.CON
39	VBH	00-7F	00		V BLK HIGHT WIDTH	u.CON
3A	VBL	00-FF	FF		V BLK LOW WIDTH	u.CON
3B	ODL	00-FF	10		POWER ON DELAY	u.CON
3C	OFR	00-0F	00		STBY → ON RGB OUT	u.CON
3D	OFM	00-0F	00		MAIN POWER RGB OUT	u.CON
3E	OSH	00-3F	0A		OSD POSITION H	u.CON
3F	DKS	00-01	00		D/K NICAM	u.CON
40	MUT	00-01	01		NO SYNC. MUTE	u.CON
41	DWZ	00-01	00		DISABLE WIDEZOOM	u.CON
42	ABL	00-01	01		BRIGHT ABL	u.CON
43	DTV	00-01	00		DISABLE TV SYSTEM KEY	u.CON
44	SCM	00-01	00		SECAM TRAP ACTIVE	u.CON
45	ROC	00-0F	07		ROTATION CENTER	u.CON
46	ROS	00-07	03		ROTATION STEP WIDTH	u.CON
47	DVM	00-01	00		DISABLE VM MUTE	u.CON
48	FBT	00-01	00		C/M FOR FBT LAYER SHORT	u.CON
49	OP0	00-FF	40		OPTION 0	u.CON
4A	OP1	00-FF	07		OPTION 1	u.CON
4B	OP2	00-FF	00		OPTION 2	u.CON

NOTE

- Standard Data: Those are the standard data values written on the microprocessor. Therefore, the data values of the modes are stored respectively in the memory.
In case of a device replacement, adjustment by rewriting the data value is necessary for some items.
- 50 50 Hz data
- 60 60 Hz data
- Standard data listed on the adjustment item table are reference values, therefore it is different for every model.

ITEM INFORMATION

- 10. DL: TV/MIX Mode 0=Interlace 1=interlace, TEXT Mode 0=interlace 1=Interlace
- 42. ABL: Bright ABL ON/OFF ON=1 OFF=0
- 49. OP0 • 4A. OP1 • 4B. OP2
Input data are different according to models.
AV INPUT : 00 → NO MODEL, 01 → MONO, CXA1315, 10/11 → STEREO, TDA8424
TV System : 00 → Multi model, 01 → B/G, 10 → D/K.I, 11 → B/G D/K
NTSC, SECAM, Chin
Shrp : Dynamic Mode @ 1 → Sharpness 50%, 0 → Sharpness 70%.
VM Operation : 0 → OFF, 1 → ON

No. 49 OP0 * Input data are different according to models

Item	-	AV Input		Shrp 50%	Remote preset	Auto program	Video Text	Reserved
KV-T29SN81	0	1	1	1	0	0	0	0

No. 4A OP1

Item	-	Tilt	-	TV System		NTSC 3.58	SECAM	Chinese
KV-T29SN81	0	1	0	0	1	1	0	1

No. 4B OP2

Item	-	Sound Mode	Child Lock	Sound Effect	High Dev.	100 Prg.	4:3 Wide	S Video
KV-T29SN81	0	0	0	0	0	0	0	0

4-3. A BOARD ADJUSTMENT AFTER IC003 (MEMORY) REPLACEMENT

1. Enter to Service Mode.
2. Press commander buttons **[5]** and **[0]** (Data Initialize), and **[2]** and **[0]** (Data Copy) to initialize the data.
3. Call each item number, and check if the respective screen shows the normal picture.
In case some items are not well-adjusted, give them fine adjustment.
Write the data per each item number (**[MUTING]** + **[0]**).
4. Select item numbers "49" (OP0), "4A" (OP1) and "4B" (OP2) respectively set the bit per model with command buttons **[3]** and **[6]**.
5. Press commander buttons **[8]** and **[0]** (Test Normal) to return to the data that was set on the shipment from the factory.
(= Cancel Service Mode.)

4-4. PICTURE DISTORTION ADJUSTMENT

Item Number 00 – 08

00 HSF (H SHIFT)

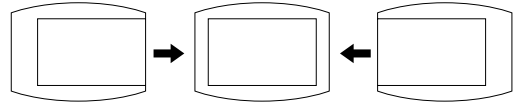

01 HSZ (H SIZE)

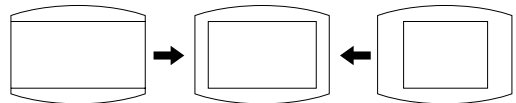

02 PAP (PIN AMPLITUDE)

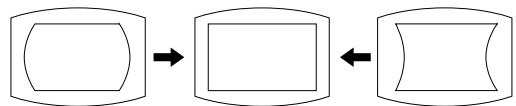

03 CNP (CORNER PIN)

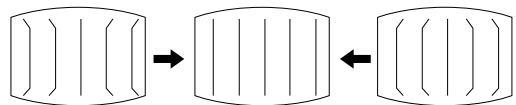

04 TLT (TILT)

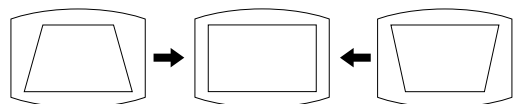

05 VSL (V SLOPE)

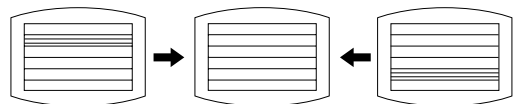

06 VAP (V AMPLITUDE)



07 SCR (S CORRECTION)

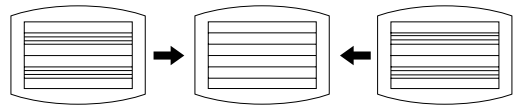

08 VSF (V SHIFT)

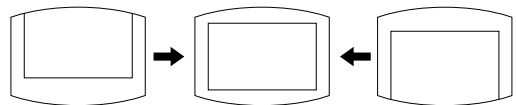

5-5. SEMICONDUCTORS

DIODE

D1NL20
EL1Z
GP08D
HZT33-02TE
RGP02-17EL-6433

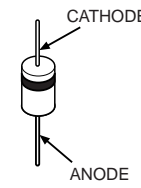

ERC06-15S
S3L20UF4

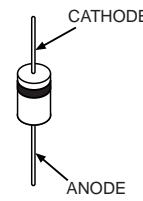

ERD29-08J
RU4DS

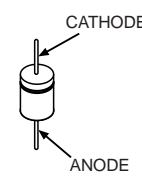

LN4SB60

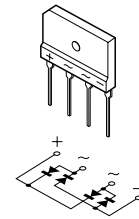

RD3.6M-B2
RD5.6M-B2

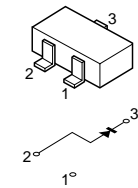

LNK0220022G

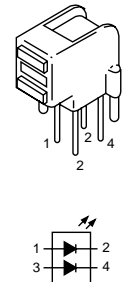

DA204K

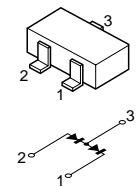

DTZ9.1
MA113-TX
RD13ES-B2
RD2.2ES-B2
RD3.6ES-B1
RD39ES-B2
RD4.7ES-B2
RD5.1ES-B1
1SS119-25

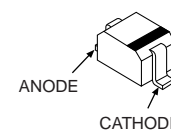

DAN202K

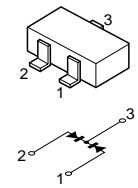

DAP202K

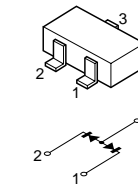

RD9.1ES-L2

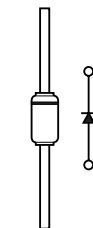

TRANSISTOR

DTA114EKA-T146
DTC114EKA-T146
DTC143TKA-T146
DTC144EK
TR DTC144EKA
2SA1037K-T-146-QR
2SA1162-G
2SC1623-L5L6
2SC2712-YG

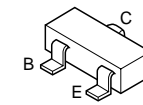

2SA1091-0
2SC2551-0

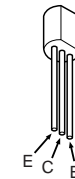

2SA1175-HFE
2SC2410SN
2SC2785-HFE

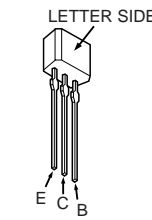

2SC2958
2SC3209LK
2SC3733
2SD774-34

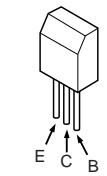

2SC2611

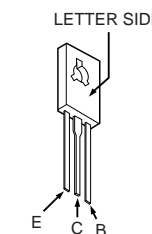

2SC2669-0



2SC4793



2SC4927-01

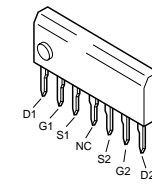

2SA1837
2SD2394-EF
2SD2394-F

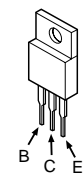

IC

ST24C08FB (8PIN)
CXA1110BS (30PIN)
CXA1315P (16PIN)
CXP85224A-072S (64PIN)
NJM2903D (8PIN)
NJM2904D (8PIN)
P83C654FBP/540 (40PIN)
SAA5281ZP/E (52PIN)
TDA4665T/V5-118 (16PIN)
TDA8366/N3D (56PIN)
TDA8375A (56PIN)
TDA8424 (20PIN)
TDA9821 (16PIN)



Dual In-line Package
Pin 6-98

L78LR05D-MA

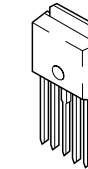

PC123F2

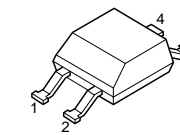

SBX1981-11

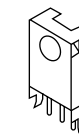

SE135N

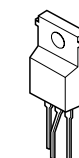

STR-S6708N

MARKING SIDE VIEW

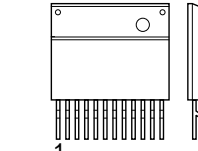

Zig-zag In-line Package
Pin 6-99

UPC4558G2 (8PIN)

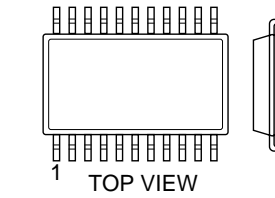

Single In-line Package
Pin 6-98

NJM78L12A

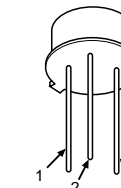

LA7845

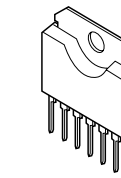

TA8223K

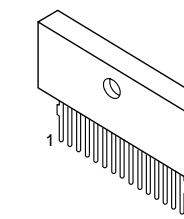

UPC574J

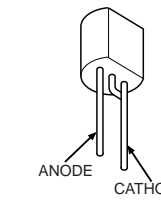

PQ09RA1

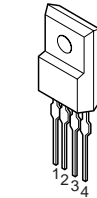

NJM2234L

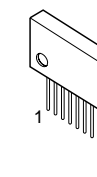

MSP3410D-PP-B4

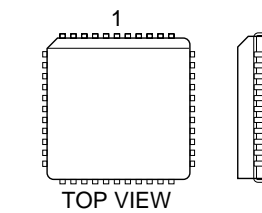

Quad Flat J-leaded Package
Pin 20-996

TA7805S

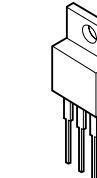

SECTION 6 EXPLODED VIEW

NOTE:

- Items with no part number and no description are not stocked because they are seldom required for routine service.
- The construction parts of an assembled part are indicated with a collation number in the remark column.
- Items marked " * " are not stocked since they are seldom required for routine service. Some delay should be anticipated when ordering these items.

The components identified by shading and mark Δ are critical for safety. Replace only with part number specified.

6-1. CHASSIS

- : BVTP3 x 12 7-685-648-79
- : BVTP4 x 16 7-685-663-71
- ▲: BVTP3 x 16 7-685-650-79

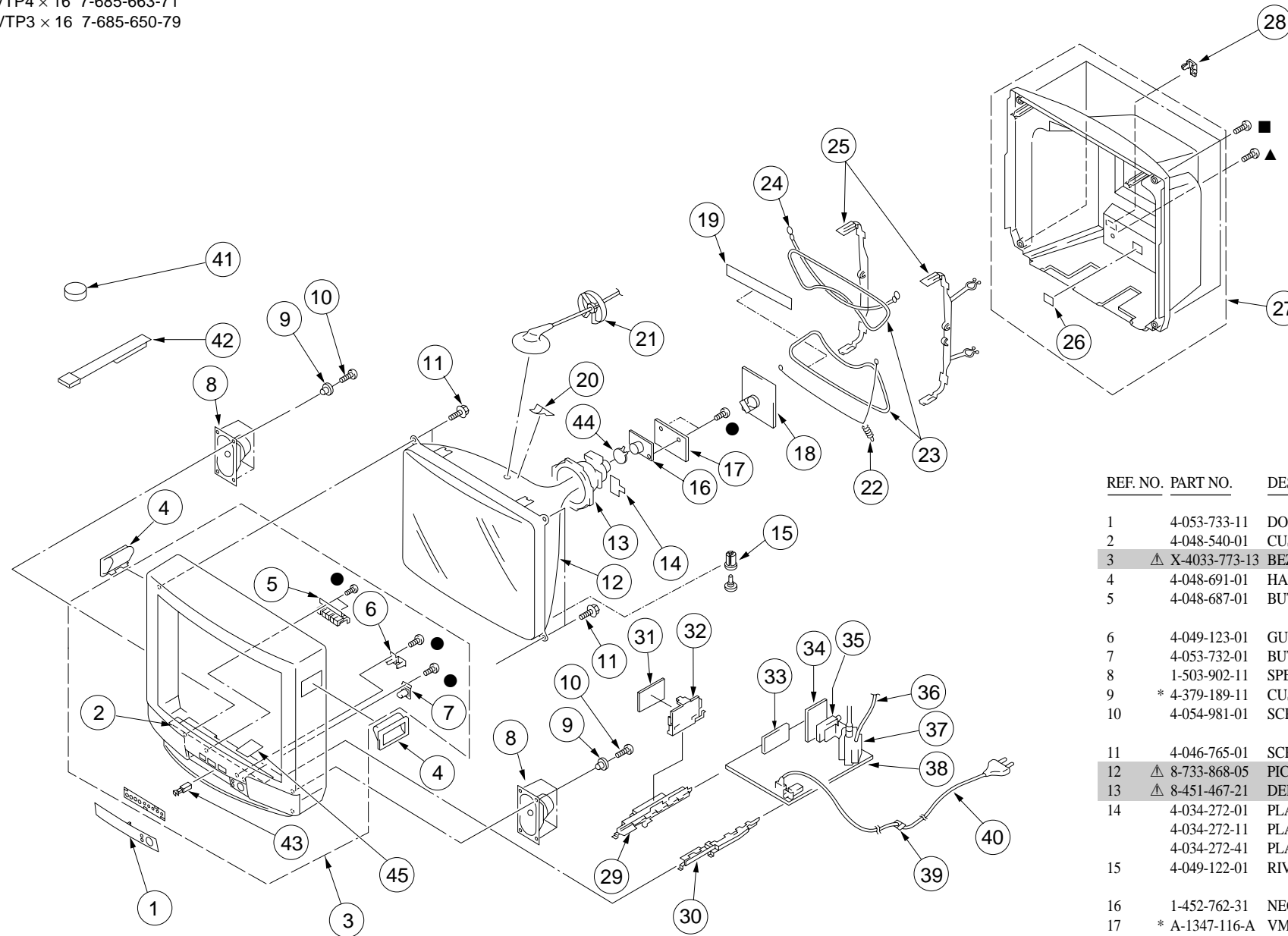

REF. NO.	PART NO.	DESCRIPTION	REMARK	REF. NO.	PART NO.	DESCRIPTION	REMARK
1	4-053-733-11	DOOR, CONTROL		26	4-049-416-01	SHEET, BLIND	
2	4-048-540-01	CUSHION, CRT		27	Δ X-4033-774-1	REAR COVER ASSY	26
3	Δ X-4033-773-13	BEZNET ASSY	2, 5-7, 43	28	4-049-130-01	CLAMPER, CORD	
4	4-048-691-01	HANDLE		29	* 4-048-690-01	RAIL (L), GUIDE	
5	4-048-687-01	BUTTON, MULTI		30	* 4-048-689-01	RAIL (R), GUIDE	
6	4-049-123-01	GUIDE, LIGHT		31	* A-1241-269-A	F1 BOARD, MOUNTED	
7	4-053-732-01	BUTTON, POWER		32	* 4-049-158-01	BRACKET, F1 PC BOARD	
8	1-503-902-11	SPEAKER (15X6.5 CM)		33	* A-1347-103-A	V1 BOARD, COMPLETE	
9	* 4-379-189-11	CUSHION, SPEAKER		34	* A-1297-523-A	A3 BOARD, COMPLETE	
10	4-054-981-01	SCREW, STEP TAPPING		35	Δ 8-598-323-50	TUNER, VSS BT-AG401	
11	4-046-765-01	SCREW, TAPPING 7+CROWN WASHER		36	Δ 1-900-700-27	LEAD ASSY, FOCUS	
12	Δ 8-733-868-05	PICTURE TUBE (M68KZT71X)		37	Δ 1-453-219-11	TRANSFORMER ASSY, FLYBACK (NX-4002/M3J4)	
13	Δ 8-451-467-21	DEFLECTION YOKE (Y29GXA2-S)		38	* A-1298-958-A	A BOARD, COMPLETE	
14	4-034-272-01	PLATE, CORRECTION, TLV		39	Δ 4-389-778-11	HOLDER, AC CORD	
	4-034-272-11	PLATE, CORRECTION, TLV		40	Δ 1-574-358-51	CORD, POWER (WITH CONNECTOR) 7.5A/250V	
	4-034-272-41	PLATE, CORRECTION, TLV					
15	4-049-122-01	RIVET		41	1-452-032-00	MAGNET, DISC	
16	1-452-762-31	NECK ASSEMBLY NA294		42	X-4387-214-3	PERMALOY ASSY, CORRECTION	
17	* A-1347-116-A	VM BOARD, COMPLETE		43	4-047-464-01	CATCHER, PUSH	
18	* A-1331-740-A	C BOARD, MOUNTED		44	1-452-278-22	MAGNET, PURITY	
19	* 4-045-290-11	CUSHION (50X290), DGC			1-452-278-32	MAGNET, PURITY	
20	4-046-600-11	SPACER, DY		45	* 4-053-736-01	LABEL, PROTECTION	
21	* 3-704-372-11	HOLDER, HV CABLE					
22	4-369-318-61	SPRING, TENSION					
23	Δ 1-403-672-12	COIL, DEMAGNETIZATION					
24	1-900-700-10	DGC BAND					
25	* 4-043-036-01	HOLDER, DGC					

SECTION 7

ELECTRICAL PARTS LIST

KV-T29SN81
RM-870

A

KV-T29SN81
RM-870

A

The components identified by shading and mark Δ are critical for safety. Replace only with part number specified.

NOTE:

The components identified by shading and mark Δ are critical for safety. Replace only with part number specified.

When indicating parts by reference number, please include the board name.

• Items marked " * " are not stocked since they are seldom required for routine service. Some delay should be anticipated when ordering these items.

• All variable and adjustable resistors have characteristic curve B, unless otherwise noted.

• All resistors are in ohms
• F : nonflammable

CAPACITORS
• MF : μ F, PF : μ F

COILS
• MMH : mH, UH : μ H

REF.NO.	PART NO.	DESCRIPTION	REMARK
* A-1298-958-A	A BOARD, COMPLETE	*****	
* 1-580-798-11	CONNECTOR PIN (DY) 6P		
* 4-049-131-01	CASE (A), SHIELD		
4-352-844-01	PIN, LEAD, COATING		
4-382-854-11	SCREW (M3X10), P, SW (+)		
7-682-950-01	SCREW +PSW 3X12		
	<CAPACITOR>		
C001	1-163-011-11	CERAMIC CHIP 0.0015MF	10% 50V
C002	1-126-965-11	ELECT 22MF	20% 50V
C004	1-126-961-11	ELECT 2.2MF	20% 50V
C007	1-126-959-11	ELECT 0.47MF	20% 50V
C008	1-163-117-00	CERAMIC CHIP 100PF	5% 50V
C009	1-163-133-00	CERAMIC CHIP 470PF	5% 50V
C010	1-163-037-11	CERAMIC CHIP 0.022MF	10% 50V
C011	1-104-664-11	ELECT 47MF	20% 16V
C013	1-163-009-11	CERAMIC CHIP 0.001MF	10% 50V
C014	1-163-009-11	CERAMIC CHIP 0.001MF	10% 50V
C015	1-101-884-00	CERAMIC 56PF	5% 50V
C016	1-101-884-00	CERAMIC 56PF	5% 50V
C017	1-163-117-00	CERAMIC CHIP 100PF	5% 50V
C018	1-163-117-00	CERAMIC CHIP 100PF	5% 50V
C019	1-163-009-11	CERAMIC CHIP 0.001MF	10% 50V
C020	1-163-009-11	CERAMIC CHIP 0.001MF	10% 50V
C021	1-163-009-11	CERAMIC CHIP 0.001MF	10% 50V
C022	1-163-009-11	CERAMIC CHIP 0.001MF	10% 50V
C023	1-163-009-11	CERAMIC CHIP 0.001MF	10% 50V
C024	1-163-009-11	CERAMIC CHIP 0.001MF	10% 50V
C025	1-163-009-11	CERAMIC CHIP 0.001MF	10% 50V
C026	1-163-009-11	CERAMIC CHIP 0.001MF	10% 50V
C027	1-163-009-11	CERAMIC CHIP 0.001MF	10% 50V
C028	1-163-009-11	CERAMIC CHIP 0.001MF	10% 50V
C029	1-163-009-11	CERAMIC CHIP 0.001MF	10% 50V
C034	1-164-004-11	CERAMIC CHIP 0.1MF	10% 25V
C035	1-163-009-11	CERAMIC CHIP 0.001MF	10% 50V
C036	1-163-009-11	CERAMIC CHIP 0.001MF	10% 50V
C037	1-163-117-00	CERAMIC CHIP 100PF	5% 50V
C038	1-163-117-00	CERAMIC CHIP 100PF	5% 50V
C040	1-163-117-00	CERAMIC CHIP 100PF	5% 50V
C042	1-163-117-00	CERAMIC CHIP 100PF	5% 50V
C044	1-163-117-00	CERAMIC CHIP 100PF	5% 50V
C045	1-163-117-00	CERAMIC CHIP 100PF	5% 50V
C046	1-163-117-00	CERAMIC CHIP 100PF	5% 50V
C047	1-163-117-00	CERAMIC CHIP 100PF	5% 50V
C048	1-164-004-11	CERAMIC CHIP 0.1MF	10% 25V

REF.NO.	PART NO.	DESCRIPTION	REMARK
C049	1-164-004-11	CERAMIC CHIP 0.1MF	10% 25V
C050	1-126-960-11	ELECT 1MF	20% 50V
C051	1-163-117-00	CERAMIC CHIP 100PF	5% 50V
C052	1-164-004-11	CERAMIC CHIP 0.1MF	10% 25V
C053	1-163-009-11	CERAMIC CHIP 0.001MF	10% 50V
C055	1-126-941-11	ELECT 470MF	20% 16V
C056	1-163-009-11	CERAMIC CHIP 0.001MF	10% 50V
C057	1-163-243-11	CERAMIC CHIP 47PF	5% 50V
C058	1-163-117-00	CERAMIC CHIP 100PF	5% 50V
C059	1-163-117-00	CERAMIC CHIP 100PF	5% 50V
C060	1-163-009-11	CERAMIC CHIP 0.001MF	10% 50V
C061	1-164-505-11	CERAMIC CHIP 2.2MF	16V
C072	1-126-941-11	ELECT 470MF	20% 16V
C074	1-163-001-11	CERAMIC CHIP 220PF	10% 50V
C101	1-163-029-11	CERAMIC CHIP 0.0047MF	50V
C105	1-126-933-11	ELECT 100MF	20% 16V
C106	1-126-964-11	ELECT 10MF	20% 50V
C108	1-126-767-11	ELECT 1000MF	20% 16V
C109	1-163-017-00	CERAMIC CHIP 0.0047MF	10% 50V
C110	1-136-165-00	FILM 0.1MF	5% 50V
C111	1-163-009-11	CERAMIC CHIP 0.001MF	10% 50V
C114	1-163-117-00	CERAMIC CHIP 100PF	5% 50V
C115	1-163-093-00	CERAMIC CHIP 10PF	5% 50V
C116	1-136-165-00	FILM 0.1MF	5% 50V
C117	1-163-117-00	CERAMIC CHIP 100PF	5% 50V
C118	1-126-965-11	ELECT 22MF	20% 50V
C119	1-163-059-00	CERAMIC CHIP 0.01MF	50V
C120	1-130-493-00	MYLAR 0.068MF	5% 50V
C121	1-130-493-00	MYLAR 0.068MF	5% 50V
C122	1-126-933-11	ELECT 100MF	20% 16V
C124	1-164-004-11	CERAMIC CHIP 0.1MF	10% 25V
C125	1-164-004-11	CERAMIC CHIP 0.1MF	10% 25V
C127	1-163-077-00	CERAMIC CHIP 0.1MF	10% 25V
C128	1-163-077-00	CERAMIC CHIP 0.1MF	10% 25V
C131	1-163-117-00	CERAMIC CHIP 100PF	5% 50V
C132	1-163-117-00	CERAMIC CHIP 100PF	5% 50V
C201	1-126-960-11	ELECT 1MF	20% 50V
C202	1-126-933-11	ELECT 100MF	20% 16V
C203	1-126-960-11	ELECT 1MF	20% 50V
C204	1-126-933-11	ELECT 100MF	20% 16V
C205	1-163-989-11	CERAMIC CHIP 0.033MF	10% 25V
C206	1-163-018-00	CERAMIC CHIP 0.0056MF	10% 50V
C207	1-126-961-11	ELECT 2.2MF	20% 50V
C208	1-126-961-11	ELECT 2.2MF	20% 50V
C209	1-163-018-00	CERAMIC CHIP 0.0056MF	10% 50V
C210	1-163-989-11	CERAMIC CHIP 0.033MF	10% 25V
C211	1-164-004-11	CERAMIC CHIP 0.1MF	10% 25V
C233	1-104-664-11	ELECT 47MF	20% 16V

REF.NO.	PART NO.	DESCRIPTION	REMARK
C234	1-104-664-11	ELECT 47MF	20% 16V
C235	1-104-664-11	ELECT 47MF	20% 16V
C236	1-126-948-11	ELECT 100MF	20% 35V
C237	1-126-933-11	ELECT 100MF	20% 16V
C238	1-136-167-00	FILM 0.15MF	5% 50V
C239	1-126-933-11	ELECT 100MF	20% 16V
C240	1-136-167-00	FILM 0.15MF	5% 50V
C241	1-126-942-61	ELECT 1000MF	20% 25V
C242	1-163-021-91	CERAMIC CHIP 0.01MF	10% 50V
C243	1-128-551-11	ELECT 22MF	20% 25V
C244	1-126-942-61	ELECT 1000MF	20% 25V
C246	1-128-551-11	ELECT 22MF	20% 25V
C247	1-126-942-61	ELECT 1000MF	20% 25V
C253	1-126-933-11	ELECT 100MF	20% 16V
C254	1-163-017-00	CERAMIC CHIP 0.0047MF	10% 50V
C255	1-163-017-00	CERAMIC CHIP 0.0047MF	10% 50V
C257	1-130-494-11	MYLAR 0.082MF	5% 50V
C258	1-130-494-11	MYLAR 0.082MF	5% 50V
C300	1-104-664-11	ELECT 47MF	20% 16V
C304	1-164-004-11	CERAMIC CHIP 0.1MF	10% 25V
C305	1-164-004-11	CERAMIC CHIP 0.1MF	10% 25V
C306	1-216-295-91	SHORT 0	
C307	1-164-004-11	CERAMIC CHIP 0.1MF	10% 25V
C308	1-164-004-11	CERAMIC CHIP 0.1MF	10% 25V
C309	1-164-004-11	CERAMIC CHIP 0.1MF	10% 25V
C310	1-164-004-11	CERAMIC CHIP 0.1MF	10% 25V
C311	1-163-231-11	CERAMIC CHIP 15PF	5% 50V
C312	1-163-231-11	CERAMIC CHIP 15PF	5% 50V
C313	1-126-933-11	ELECT 100MF	20% 16V
C314	1-164-161-11	CERAMIC CHIP 0.0022MF	10% 50V
C315	1-165-320-11	CERAMIC CHIP 0.47MF	10% 16V
C316	1-102-125-00	CERAMIC 0.0047MF	10% 50V
C319	1-164-004-11	CERAMIC CHIP 0.1MF	10% 25V
C320	1-164-004-11	CERAMIC CHIP 0.1MF	10% 25V
C321	1-164-004-11	CERAMIC CHIP 0.1MF	10% 25V
C322	1-216-295-91	SHORT 0	
C323	1-163-235-11	CERAMIC CHIP 22PF	5% 50V
C324	1-115-565-11	CERAMIC CHIP 2.2MF	10% 10V
C326	1-163-095-00	CERAMIC CHIP 12PF	5% 50V
C328	1-164-004-11	CERAMIC CHIP 0.1MF	10% 25V
C329	1-163-016-00	CERAMIC CHIP 0.0039MF	10% 50V
C330	1-164-004-11	CERAMIC CHIP 0.1MF	10% 25V
C331	1-126-964-11	ELECT 10MF	20% 50V
C332	1-136-165-00	FILM 0.1MF	5% 50V
C333	1-164-004-11	CERAMIC CHIP 0.1MF	10% 25V
C335	1-102-973-00	CERAMIC 100PF	5% 50V
C337	1-126-933-11	ELECT 100MF	20% 16V
C338	1-165-320-11	CERAMIC CHIP 0.47MF	10% 16V
C339	1-163-121-00	CERAMIC CHIP 150PF	5% 50V
C340	1-163-009-11	CERAMIC CHIP 0.001MF	10% 50V
C341	1-163-117-00	CERAMIC CHIP 100PF	5% 50V
C342	1-164-004-11	CERAMIC CHIP 0.1MF	10% 25V
C344	1-126-964-11	ELECT 10MF	20% 50V
C349	1-126-963-11	ELECT 4.7MF	20% 50V
C359	1-126-933-11	ELECT 100MF	20% 16V
C361	1-163-009-11	CERAMIC CHIP 0.001MF	10% 50V
C367	1-164-004-11	CERAMIC CHIP 0.1MF	10% 25V
C802	1-107-364-11	MYLAR 0.01MF	10% 200V

REF.NO.	PART NO.	DESCRIPTION	REMARK
C368	1-164-004-11	CERAMIC CHIP 0.1MF	10% 25V
C369	1-164-004-11	CERAMIC CHIP 0.1MF	10% 25V
C370	1-164-004-11	CERAMIC CHIP 0.1MF	10% 25V
C374	1-126-967-11	ELECT 47MF	20% 50V
C375	1-126-967-11	ELECT 47MF	20% 50V
C376	1-164-005-11	CERAMIC CHIP 0.47MF	25V
C401	1-163-021-91	CERAMIC CHIP 0.01MF	10% 50V
C402	1-163-021-91	CERAMIC CHIP 0.01MF	10% 50V
C403	1-126-965-11	ELECT 22MF	20% 50V
C404	1-163-021-91	CERAMIC CHIP 0.01MF	10% 50V
C405	1-163-017-00	CERAMIC CHIP 0.0047MF	10% 50V
C406	1-163-017-00	CERAMIC CHIP 0.0047MF	10% 50V
C407	1-163-017-00	CERAMIC CHIP 0.0047MF	10% 50V
C408	1-163-017-00	CERAMIC CHIP 0.0047MF	10% 50V
C410	1-163-103-00	CERAMIC CHIP 27PF	5% 50V
C411	1-163-113-00	CERAMIC CHIP 68PF	5% 50V
C413	1-126-933-11	ELECT 100MF	20% 16V
C415	1-163-017-00	CERAMIC CHIP 0.0047MF	10% 50V
C420	1-104-664-11	ELECT 47MF	20% 16V
C423	1-163-129-00	CERAMIC CHIP 330PF	5% 50V
C425	1-163-021-91	CERAMIC CHIP 0.01MF	10% 50V
C501	1-102-228-00	CERAMIC 470PF	10% 500V
C523	1-126-933-11	ELECT 100MF	20% 16V
C548	1-106-220-00	MYLAR 0.1MF	10% 100V
C551	1-126-948-11	ELECT 100MF	20% 35V
C552	1-126-948-11	ELECT 100MF	20% 35V
C554	1-162-815-11	CERAMIC 47PF	5% 500V
C555	1-102-230-00	CERAMIC 4PF	0.25PF 500V
C562	1-126-933-11	ELECT 100MF	20% 16V
C572	1-163-021-91	CERAMIC CHIP 0.01MF	10% 50V
C601	1-162-318-11	CERAMIC 0.001MF	10% 500V
C602	1-161-830-00	CERAMIC 0.0047MF	99% 500V
C603	1-161-830-00	CERAMIC 0.0047MF	99% 500V
C604	1-113-608-11	ELECT(BLOCK) 470MF	20% 400V
C605	1-161-830-00	CERAMIC 0.0047MF	99% 500V
C606	1-161-830-00	CERAMIC 0.0047MF	99% 500V
C607	1-161-830-00	CERAMIC 0.0047MF	99% 500V
C608	1-104-332-11	CERAMIC 470PF	10% 2KV
C609	1-124-347-00	ELECT 100MF	20% 160V
C610	1-126-943-11	ELECT 2200MF	20% 25V
C612	1-102-228-00	CERAMIC 470PF	10% 500V
C613	1-102-824-00	CERAMIC 470PF	5% 50V
C614	1-126-943-11	ELECT 2200MF	20% 25V
C615	Δ 1-113-900-51	CERAMIC 470PF	10% 250V
C616	1-102-228-00	CERAMIC 470PF	10% 500V
C618	1-163-005-11	CERAMIC CHIP 470PF	10% 50V
C619	1-162-116-00	CERAMIC 680PF	10% 2KV
C621	Δ 1-104-705-51	FILM 0.1MF	20% 250V
C622	1-106-383-00	MYLAR 0.047MF	10% 200V
C623	1-126-969-11	ELECT 220MF	20% 50V
C624	1-126-767-11	ELECT 1000MF	20% 16V
C625	1-102-074-00	CERAMIC 0.001MF	10% 50V
C627	1-162-116-00	CERAMIC 680PF	

The components identified by shading and mark Δ are critical for safety. Replace only with part number specified.

A

REF. NO.	PART NO.	DESCRIPTION			REMARK	REF. NO.	PART NO.	DESCRIPTION			REMARK
C802	1-107-364-11	MYLAR	0.01MF	10%	200V	C1230	1-164-004-11	CERAMIC CHIP	0.1MF	10%	25V
C804	1-163-009-11	CERAMIC CHIP	0.001MF	10%	50V	C1513	1-126-968-11	ELECT	100MF	20%	50V
C805	1-102-244-00	CERAMIC	220PF	10%	500V						
C806	1-126-960-11	ELECT	1MF	20%	50V						
C807	1-136-597-11	FILM	0.89MF	5%	200V			<CONNECTOR>			
C808	1-129-723-00	FILM	0.068MF	5%	400V	CN101	* 1-508-797-00	PIN, CONNECTOR 4P			
C809	1-162-115-00	CERAMIC	330PF	10%	2KV	CN102	* 1-564-508-11	PLUG, CONNECTOR 5P			
C810	1-106-365-00	MYLAR	0.0082MF	99%	200V	CN103	* 1-564-509-11	PLUG, CONNECTOR 6P			
C811	1-162-318-11	CERAMIC	0.001MF	10%	500V	CN106	* 1-770-747-11	CONNECTOR, BOARD TO BOARD 12P			
C812	1-136-085-00	FILM	0.016MF	3%	2KV	CN110	* 1-564-505-11	PLUG, CONNECTOR 2P			
C816	1-107-636-11	ELECT	10MF	20%	160V	CN111	* 1-564-505-11	PLUG, CONNECTOR 2P			
C820	1-162-116-00	CERAMIC	680PF	10%	2KV	CN112	* 1-508-784-00	PIN, CONNECTOR (5MM PITCH) 1P			
C821	1-104-999-11	MYLAR	0.1MF	10%	200V	CN251	* 1-564-507-11	PLUG, CONNECTOR 4P			
C822	1-136-111-00	FILM	1MF	5%	200V	CN601*	Δ 1-580-843-11	PIN, CONNECTOR (POWER)			
C823	1-163-017-00	CERAMIC CHIP	0.0047MF	10%	50V	CN602	* 1-508-765-00	PIN, CONNECTOR (5MM PITCH) 3P			
C825	1-107-364-11	MYLAR	0.01MF	10%	200V	CN603	* 1-508-786-00	PIN, CONNECTOR (5MM PITCH) 2P			
C850	1-126-941-11	ELECT	470MF	20%	25V	CN604	1-695-915-11	TAB (CONTACT)			
C852	1-104-574-11	CERAMIC	0.0047MF	10%	2KV	CN607	1-695-915-11	TAB (CONTACT)			
C853	1-162-318-11	CERAMIC	0.001MF	10%	500V	CN609	* 1-564-506-11	PLUG, CONNECTOR 3P			
C854	1-126-941-11	ELECT	470MF	20%	25V	CN811	1-695-915-11	TAB (CONTACT)			
C855	4-352-844-01	PIN, LEAD, COATING				CN812	1-695-915-11	TAB (CONTACT)			
C856	1-162-318-11	CERAMIC	0.001MF	10%	500V	CN813	1-695-915-11	TAB (CONTACT)			
C857	1-136-495-11	FILM	0.068MF	5%	50V	CN814	1-695-915-11	TAB (CONTACT)			
C860	1-102-228-00	CERAMIC	470PF	10%	500V	CN815	1-695-915-11	TAB (CONTACT)			
C861	1-107-654-11	ELECT	33MF	20%	250V	CN816	1-695-915-11	TAB (CONTACT)			
C875	1-128-562-11	ELECT	47MF	20%	100V	CN817	1-695-915-11	TAB (CONTACT)			
C876	1-107-369-11	MYLAR	0.068MF	10%	100V	CN818	1-695-915-11	TAB (CONTACT)			
C891	1-163-007-11	CERAMIC CHIP	680PF	10%	50V	CN851	* 1-508-766-00	PIN, CONNECTOR (5MM PITCH) 4P			
C898	1-136-169-00	FILM	0.22MF	5%	50V	CN852	* 1-508-784-00	PIN, CONNECTOR (5MM PITCH) 1P			
C901	1-163-133-00	CERAMIC CHIP	470PF	5%	50V	CN853	* 1-564-506-11	PLUG, CONNECTOR 3P			
C902	1-163-133-00	CERAMIC CHIP	470PF	5%	50V						
C1201	1-126-933-11	ELECT	100MF	20%	16V			<TRIMMER>			
C1202	1-164-004-11	CERAMIC CHIP	0.1MF	10%	25V						
C1203	1-164-004-11	CERAMIC CHIP	0.1MF	10%	25V	CT55	1-404-801-11	TRAP, CERAMIC			
C1204	1-126-933-11	ELECT	100MF	20%	16V						
C1205	1-164-004-11	CERAMIC CHIP	0.1MF	10%	25V			<DIODE>			
C1206	1-164-004-11	CERAMIC CHIP	0.1MF	10%	25V	D001	8-719-109-81	DIODE RD4.7ESB2			
C1207	1-126-933-11	ELECT	100MF	20%	16V	D002	8-719-911-19	DIODE 1SS119-25			
C1208	1-164-005-11	CERAMIC CHIP	0.47MF		25V	D003	8-719-041-97	DIODE MA113-(TX)			
C1209	1-164-005-11	CERAMIC CHIP	0.47MF		25V	D004	8-719-109-84	DIODE RD5.1ESB1			
C1210	1-126-933-11	ELECT	100MF	20%	16V	D005	8-719-109-84	DIODE RD5.1ESB1			
C1212	1-126-960-11	ELECT	1MF	20%	50V	D008	8-719-109-89	DIODE RD5.6ESB2			
C1213	1-126-960-11	ELECT	1MF	20%	50V	D103	8-719-914-42	DIODE DA204K			
C1214	1-126-964-11	ELECT	10MF	20%	50V	D251	8-719-911-19	DIODE 1SS119-25			
C1215	1-163-021-91	CERAMIC CHIP	0.01MF	10%	50V	D252	8-719-914-42	DIODE DA204K			
C1216	1-164-005-11	CERAMIC CHIP	0.47MF		25V	D301	8-719-041-97	DIODE MA113-(TX)			
C1217	1-126-933-11	ELECT	100MF	20%	16V	D305	8-719-041-97	DIODE MA113-(TX)			
C1218	1-163-123-00	CERAMIC CHIP	180PF	5%	50V	D306	8-719-911-19	DIODE 1SS119-25			
C1219	1-126-933-11	ELECT	100MF	20%	16V	D307	8-719-911-19	DIODE 1SS119-25			
C1221	1-164-005-11	CERAMIC CHIP	0.47MF		25V	D308	8-719-109-54	DIODE RD2.2ESB2			
C1222	1-164-005-11	CERAMIC CHIP	0.47MF		25V	D310	8-719-041-97	DIODE MA113-(TX)			
C1223	1-164-346-11	CERAMIC CHIP	1MF		16V	D311	8-719-109-68	DIODE RD3.6ESB1			
C1224	1-216-295-91	SHORT	0			D312	8-719-070-15	DIODE NNCD8.2A-T1			
C1225	1-164-005-11	CERAMIC CHIP	0.47MF		25V	D315	8-719-070-16	DIODE NNCD9.1A-T1			
C1226	1-126-934-11	ELECT	220MF	20%	16V	D351	8-719-908-03	DIODE GP08D			
C1227	1-164-004-11	CERAMIC CHIP	0.1MF	10%	25V	D399	8-719-977-22	DIODE DTZ9.1			
C1228	1-164-346-11	CERAMIC CHIP	1MF		16V						

A

The components identified by shading and mark Δ are critical for safety. Replace only with part number specified.

REF. NO.	PART NO.	DESCRIPTION	REMARK	REF. NO.	PART NO.	DESCRIPTION	REMARK
D403	8-719-911-19	DIODE 1SS119-25		IC202	8-759-708-12	IC NJM78L12A	
D513	8-719-109-84	DIODE RD5.1ESB1		IC203	8-759-336-30	IC TA8223K	
D551	8-719-908-03	DIODE GP08D		IC300	8-759-365-26	IC TDA8375A	
D561	8-719-911-19	DIODE 1SS119-25		IC351	8-759-565-20	IC TDA4665T/V5-118	
D591	8-719-911-19	DIODE 1SS119-25		IC521	8-759-054-12	IC PQ09RA1	
D601	8-719-052-84	DIODE LN4SB60		IC551	8-759-280-35	IC LA7845	
D602	8-719-108-18	THYRISTOR 5P6M		IC601	8-749-014-01	IC STR-S6708N	
D603	8-719-110-36	DIODE RD13ESB2		IC602	8-749-920-61	IC SE-135N	
D604	8-719-301-64	DIODE RU4DS		IC603 Δ	8-749-010-64	PHOTO COUPLER PC123F2	
D605	8-719-510-73	DIODE S3L20UF4		IC801	8-759-100-96	IC UPC4558G2	
D606	8-719-510-73	DIODE S3L20UF4		IC1201	8-759-157-40	IC UPC574J	
D607	8-719-510-26	DIODE D1NL20-TA		IC1203	8-759-701-75	IC NJM7805FA	
D609	8-719-510-26	DIODE D1NL20-TA		IC1210	8-759-100-96	IC UPC4558G2	
D610	8-719-510-26	DIODE D1NL20-TA		IC1211	8-759-711-23	IC NJM2234L	
D611	8-719-510-26	DIODE D1NL20-TA		IC1212	8-759-711-23	IC NJM2234L	
D612	8-719-301-64	DIODE RU4DS					
D801	8-719-945-80	DIODE ERC06-15S				<JACK>	
D802	8-719-900-26	DIODE ERD29-08J		J251	1-770-786-11	JACK	
D851	8-719-302-43	DIODE EL1Z		J1201	1-770-659-11	JACK BLOCK, PIN 9P	
D852	8-719-028-72	DIODE RGP02-17EL-6433		J1202	1-695-585-11	JACK BLOCK, PIN (L TYPE) 3P	
D853	8-719-302-43	DIODE EL1Z					
D855	8-719-302-43	DIODE EL1Z				<CHIP CONDUCTOR>	
D857	8-719-908-03	DIODE GP08D		JR051	1-216-295-91	SHORT	0
D858	8-719-908-03	DIODE GP08D		JR101	1-216-295-91	SHORT	0
D860	8-719-911-19	DIODE 1SS119-25		JR103	1-216-295-91	SHORT	0
D891	8-719-945-80	DIODE ERC06-15S		JR107	1-216-295-91	SHORT	0
D901	8-719-054-60	DIODE LNK0220022G		JR108	1-216-295-91	SHORT	0
D1201	8-719-070-16	DIODE NNCD9.1A-T1		JR112	1-216-295-91	SHORT	0
D1202	8-719-070-16	DIODE NNCD9.1A-T1		JR114	1-163-121-00	CERAMIC CHIP	150PF 5% 50V
D1203	8-719-070-16	DIODE NNCD9.1A-T1		JR115	1-216-295-91	SHORT	0
D1204	8-719-070-16	DIODE NNCD9.1A-T1		JR116	1-216-295-91	SHORT	0
D1205	8-719-070-16	DIODE NNCD9.1A-T1		JR117	1-216-295-91	SHORT	0
D1206	8-719-070-16	DIODE NNCD9.1A-T1				<COIL>	
D1207	8-719-070-16	DIODE NNCD9.1A-T1		L001	1-408-397-00	INDUCTOR	1UH
D1208	8-719-070-16	DIODE NNCD9.1A-T1		L002	1-410-509-11	INDUCTOR	10UH
D1209	8-719-070-16	DIODE NNCD9.1A-T1		L003	1-408-605-31	INDUCTOR	15UH
D1504	8-719-911-19	DIODE 1SS119-25		L101	1-410-470-11	INDUCTOR	10UH
D1505	8-719-109-81	DIODE RD4.7ESB2		L301	1-408-602-31	INDUCTOR	8.2UH
		<FERRITE BEAD>		L401	1-410-498-11	INDUCTOR	1.2UH
FB101	1-410-397-21	FERRITE	1.1UH	L402	1-410-510-11	INDUCTOR	12UH
FB102	1-410-397-21	FERRITE	1.1UH	L406	1-410-507-11	INDUCTOR	6.8UH
FB251	1-410-397-21	FERRITE	1.1UH	L410	1-410-501-11	INDUCTOR	2.2UH
FB601	1-410-397-21	FERRITE	1.1UH	L802	1-412-527-11	INDUCTOR	15UH
FB603	1-410-397-21	FERRITE	1.1UH	L804	1-459-075-00	COIL,DYNAMIC CONVERSION CHOKE	
FB610	1-410-396-41	FERRITE	0UH	L805	1-411-955-12	COIL, HORIZONTAL LINEARITY	
FB612	1-410-397-21	FERRITE	1.1UH	L807	1-459-390-00	INDUCTOR	390UH
FB801	1-410-397-21	FERRITE	1.1UH	L808	1-412-553-11	INDUCTOR	3.3MMH
		<IC>		L821	1-459-111-00	INDUCTOR	10MMH
IC001	8-752-886-04	IC CXP85224A-072S		L850	1-408-947-00	INDUCTOR	2.2MMH
IC002	8-759-805-37	IC L78LR05D-MA				<TRANSISTOR>	
IC003	8-759-370-34	IC ST24C08FB6		Q030	8-729-120-28	TRANSISTOR 2SC1623-L5L6	
IC004	8-742-041-12	HYB IC SBX1981-11		Q108	8-729-120-28	TRANSISTOR 2SC1623-L5L6	
IC201	8-759-090-21	IC TDA8424					



REF. NO.	PART NO.	DESCRIPTION	REMARK	REF. NO.	PART NO.	DESCRIPTION	REMARK
Q109	8-729-120-28	TRANSISTOR 2SC1623-L5L6		R031	1-216-049-91	RES,CHIP 1K 5%	1/10W
Q110	8-729-120-28	TRANSISTOR 2SC1623-L5L6		R032	1-216-057-00	RES,CHIP 2.2K 5%	1/10W
Q202	8-729-920-72	TRANSISTOR 2SA1037K-T-146-QR		R033	1-216-049-91	RES,CHIP 1K 5%	1/10W
Q207	8-729-920-72	TRANSISTOR 2SA1037K-T-146-QR		R035	1-216-049-91	RES,CHIP 1K 5%	1/10W
Q208	1-801-806-11	TRANSISTOR DTC144EK-T146		R036	1-216-049-91	RES,CHIP 1K 5%	1/10W
Q209	8-729-027-56	TRANSISTOR DTC143TKA-T146		R037	1-216-049-91	RES,CHIP 1K 5%	1/10W
Q210	8-729-027-56	TRANSISTOR DTC143TKA-T146		R039	1-216-049-91	RES,CHIP 1K 5%	1/10W
Q301	8-729-027-43	TRANSISTOR DTC114EKA-T146		R041	1-216-025-91	RES,CHIP 100 5%	1/10W
Q302	8-729-120-28	TRANSISTOR 2SC1623-L5L6		R042	1-216-039-00	RES,CHIP 390 5%	1/10W
Q303	8-729-120-28	TRANSISTOR 2SC1623-L5L6		R045	1-216-057-00	RES,CHIP 2.2K 5%	1/10W
Q401	8-729-120-28	TRANSISTOR 2SC1623-L5L6		R047	1-216-025-91	RES,CHIP 100 5%	1/10W
Q402	8-729-922-66	TRANSISTOR 2SC2410SN		R048	1-216-025-91	RES,CHIP 100 5%	1/10W
Q406	8-729-920-72	TRANSISTOR 2SA1037K-T-146-QR		R051	1-216-085-00	RES,CHIP 33K 5%	1/10W
Q408	8-729-120-28	TRANSISTOR 2SC1623-L5L6		R052	1-216-089-91	RES,CHIP 47K 5%	1/10W
Q409	8-729-920-72	TRANSISTOR 2SA1037K-T-146-QR		R053	1-216-057-00	RES,CHIP 2.2K 5%	1/10W
Q414	8-729-120-28	TRANSISTOR 2SC1623-L5L6		R054	1-216-073-00	RES,CHIP 10K 5%	1/10W
Q561	8-729-200-17	TRANSISTOR 2SA1091-O		R056	1-216-065-91	RES,CHIP 4.7K 5%	1/10W
Q601	8-729-120-28	TRANSISTOR 2SC1623-L5L6		R057	1-216-049-91	RES,CHIP 1K 5%	1/10W
Q801	8-729-140-50	TRANSISTOR 2SC3209LK		R058	1-216-065-91	RES,CHIP 4.7K 5%	1/10W
Q802	8-729-016-32	TRANSISTOR 2SC4927-01		R060	1-216-037-00	RES,CHIP 330 5%	1/10W
Q821	8-729-018-99	TRANSISTOR 2SD2394-F		R061	1-216-057-00	RES,CHIP 2.2K 5%	1/10W
Q902	1-801-806-11	TRANSISTOR DTC144EK-T146		R062	1-216-057-00	RES,CHIP 2.2K 5%	1/10W
Q903	1-801-806-11	TRANSISTOR DTC144EK-T146		R063	1-216-057-00	RES,CHIP 2.2K 5%	1/10W
Q1201	8-729-120-28	TRANSISTOR 2SC1623-L5L6		R065	1-216-033-00	RES,CHIP 220 5%	1/10W
Q1202	8-729-120-28	TRANSISTOR 2SC1623-L5L6		R066	1-216-033-00	RES,CHIP 220 5%	1/10W
Q1203	8-729-120-28	TRANSISTOR 2SC1623-L5L6		R067	1-216-033-00	RES,CHIP 220 5%	1/10W
Q1204	8-729-920-72	TRANSISTOR 2SA1037K-T-146-QR		R068	1-216-025-91	RES,CHIP 100 5%	1/10W
Q1205	8-729-920-72	TRANSISTOR 2SA1037K-T-146-QR		R071	1-216-037-00	RES,CHIP 330 5%	1/10W
Q1206	8-729-120-28	TRANSISTOR 2SC1623-L5L6		R076	1-216-025-91	RES,CHIP 100 5%	1/10W
Q1207	8-729-120-28	TRANSISTOR 2SC1623-L5L6		R077	1-216-025-91	RES,CHIP 100 5%	1/10W
Q1208	8-729-120-28	TRANSISTOR 2SC1623-L5L6		R090	1-216-073-00	RES,CHIP 10K 5%	1/10W
Q1264	8-729-027-56	TRANSISTOR DTC143TKA-T146		R101	1-216-065-91	RES,CHIP 4.7K 5%	1/10W
Q1265	8-729-027-56	TRANSISTOR DTC143TKA-T146		R102	1-216-049-91	RES,CHIP 1K 5%	1/10W
Q1513	8-729-120-28	TRANSISTOR 2SC1623-L5L6		R113	1-216-081-00	RES,CHIP 22K 5%	1/10W
		<RESISTOR>		R114	1-216-041-00	RES,CHIP 470 5%	1/10W
R001	1-216-065-91	RES,CHIP 4.7K 5%	1/10W	R115	1-216-081-00	RES,CHIP 22K 5%	1/10W
R002	1-216-065-91	RES,CHIP 4.7K 5%	1/10W	R116	1-216-081-00	RES,CHIP 22K 5%	1/10W
R003	1-216-065-91	RES,CHIP 4.7K 5%	1/10W	R117	1-216-081-00	RES,CHIP 22K 5%	1/10W
R004	1-216-065-91	RES,CHIP 4.7K 5%	1/10W	R118	1-216-081-00	RES,CHIP 22K 5%	1/10W
R007	1-216-073-00	RES,CHIP 10K 5%	1/10W	R119	1-216-055-00	RES,CHIP 1.8K 5%	1/10W
R008	1-216-049-91	RES,CHIP 1K 5%	1/10W	R120	1-216-109-00	RES,CHIP 330K 5%	1/10W
R010	1-216-049-91	RES,CHIP 1K 5%	1/10W	R131	1-216-464-11	METAL OXIDE 18K 5%	2W F
R012	1-216-017-91	RES,CHIP 47 5%	1/10W	R180	1-216-033-00	RES,CHIP 220 5%	1/10W
R013	1-216-049-91	RES,CHIP 1K 5%	1/10W	R181	1-216-033-00	RES,CHIP 220 5%	1/10W
R015	1-216-043-91	RES,CHIP 560 5%	1/10W	R182	1-216-033-00	RES,CHIP 220 5%	1/10W
R016	1-216-049-91	RES,CHIP 1K 5%	1/10W	R203	1-216-033-00	RES,CHIP 220 5%	1/10W
R017	1-216-057-00	RES,CHIP 2.2K 5%	1/10W	R204	1-216-033-00	RES,CHIP 220 5%	1/10W
R018	1-216-033-00	RES,CHIP 220 5%	1/10W	R241	1-216-031-00	RES,CHIP 180 5%	1/10W
R019	1-216-101-00	RES,CHIP 150K 5%	1/10W	R242	1-216-031-00	RES,CHIP 180 5%	1/10W
R020	1-216-025-91	RES,CHIP 100 5%	1/10W	R243	1-216-073-00	RES,CHIP 10K 5%	1/10W
R021	1-216-065-91	RES,CHIP 4.7K 5%	1/10W	R244	1-216-073-00	RES,CHIP 10K 5%	1/10W
R025	1-216-057-00	RES,CHIP 2.2K 5%	1/10W	R245	1-216-069-00	RES,CHIP 6.8K 5%	1/10W
R027	1-216-065-91	RES,CHIP 4.7K 5%	1/10W	R246	1-216-069-00	RES,CHIP 6.8K 5%	1/10W
R028	1-216-025-91	RES,CHIP 100 5%	1/10W	R247	1-216-053-00	RES,CHIP 1.5K 5%	1/10W
R029	1-216-065-91	RES,CHIP 4.7K 5%	1/10W	R248	1-216-053-00	RES,CHIP 1.5K 5%	1/10W
				R249	1-216-049-91	RES,CHIP 1K 5%	1/10W
				R250	1-216-049-91	RES,CHIP 1K 5%	1/10W

A

The components identified by shading and mark Δ are critical for safety. Replace only with part number specified.

REF. NO.	PART NO.	DESCRIPTION	REMARK	REF. NO.	PART NO.	DESCRIPTION	REMARK
R251	1-216-295-91	SHORT	0	R406	1-216-065-91	RES,CHIP	4.7K 5% 1/10W
R252	1-249-411-11	CARBON	330 5% 1/4W	R407	1-216-063-91	RES,CHIP	3.9K 5% 1/10W
R253	1-216-073-00	RES,CHIP	10K 5% 1/10W	R408	1-216-055-00	RES,CHIP	1.8K 5% 1/10W
R254	1-249-389-11	CARBON	4.7 5% 1/4W	R409	1-216-025-91	RES,CHIP	100 5% 1/10W
R255	1-249-389-11	CARBON	4.7 5% 1/4W	R414	1-216-041-00	RES,CHIP	470 5% 1/10W
R256	1-249-411-11	CARBON	330 5% 1/4W	R416	1-216-033-00	RES,CHIP	220 5% 1/10W
R257	1-216-295-91	SHORT	0	R419	1-216-049-91	RES,CHIP	1K 5% 1/10W
R264	1-216-061-00	RES,CHIP	3.3K 5% 1/10W	R420	1-216-039-00	RES,CHIP	390 5% 1/10W
R265	1-216-061-00	RES,CHIP	3.3K 5% 1/10W	R421	1-216-033-00	RES,CHIP	220 5% 1/10W
R266	1-216-089-91	RES,CHIP	47K 5% 1/10W	R424	1-216-057-00	RES,CHIP	2.2K 5% 1/10W
R300	1-249-441-11	CARBON	100K 5% 1/4W	R425	1-216-039-00	RES,CHIP	390 5% 1/10W
R302	1-216-295-91	SHORT	0	R426	1-216-029-00	RES,CHIP	150 5% 1/10W
R303	1-216-025-91	RES,CHIP	100 5% 1/10W	R429	1-216-031-00	RES,CHIP	180 5% 1/10W
R304	1-216-025-91	RES,CHIP	100 5% 1/10W	R433	1-216-081-00	RES,CHIP	22K 5% 1/10W
R305	1-216-025-91	RES,CHIP	100 5% 1/10W	R434	1-216-041-00	RES,CHIP	470 5% 1/10W
R306	1-216-025-91	RES,CHIP	100 5% 1/10W	R440	1-216-029-00	RES,CHIP	150 5% 1/10W
R307	1-216-025-91	RES,CHIP	100 5% 1/10W	R441	1-216-021-00	RES,CHIP	68 5% 1/10W
R308	1-216-033-00	RES,CHIP	220 5% 1/10W	R521	1-216-049-91	RES,CHIP	1K 5% 1/10W
R309	1-216-033-00	RES,CHIP	220 5% 1/10W	R550	1-216-049-91	RES,CHIP	1K 5% 1/10W
R310	1-216-097-91	RES,CHIP	100K 5% 1/10W	R552	1-216-109-00	RES,CHIP	330K 5% 1/10W
R311	1-216-075-00	RES,CHIP	12K 5% 1/10W	R553	1-216-295-91	SHORT	0
R312	1-216-025-91	RES,CHIP	100 5% 1/10W	R554	1-216-113-00	RES,CHIP	470K 5% 1/10W
R313	1-216-089-91	RES,CHIP	47K 5% 1/10W	R555	1-249-429-11	CARBON	10K 5% 1/4W
R314	1-216-025-91	RES,CHIP	100 5% 1/10W	R558	1-216-061-00	RES,CHIP	3.3K 5% 1/10W
R315	1-216-295-91	SHORT	0	R559	1-216-073-00	RES,CHIP	10K 5% 1/10W
R316	1-216-065-91	RES,CHIP	4.7K 5% 1/10W	R560	1-216-073-00	RES,CHIP	10K 5% 1/10W
R317	1-216-049-91	RES,CHIP	1K 5% 1/10W	R561	1-249-421-11	CARBON	2.2K 5% 1/4W
R318	1-216-099-00	RES,CHIP	120K 5% 1/10W	R562	1-249-420-11	CARBON	1.8K 5% 1/4W F
R319	1-216-113-00	RES,CHIP	470K 5% 1/10W	R563	1-247-885-00	CARBON	180K 5% 1/4W
R320	1-216-083-00	RES,CHIP	27K 5% 1/10W	R564	1-216-091-00	RES,CHIP	56K 5% 1/10W
R321	1-216-689-11	METAL CHIP	39K 0.50% 1/10W	R565	1-216-091-00	RES,CHIP	56K 5% 1/10W
R322	1-216-083-00	RES,CHIP	27K 5% 1/10W	R566	1-216-065-91	RES,CHIP	4.7K 5% 1/10W
R324	1-208-291-11	RES,CHIP	4.7M 5% 1/10W	R569	1-247-883-00	CARBON	150K 5% 1/4W
R325	1-216-295-91	SHORT	0	R570	1-216-295-91	SHORT	0
R326	1-216-039-00	RES,CHIP	390 5% 1/10W	R571	1-216-295-91	SHORT	0
R327	1-216-025-91	RES,CHIP	100 5% 1/10W	R603	1-249-416-11	CARBON	820 5% 1/4W F
R328	1-216-025-91	RES,CHIP	100 5% 1/10W	R604	1-249-416-11	CARBON	820 5% 1/4W F
R329	1-216-025-91	RES,CHIP	100 5% 1/10W	R606	1-215-915-11	METAL OXIDE	470 5% 3W F
R330	1-216-043-91	RES,CHIP	560 5% 1/10W	R609	1-249-381-11	CARBON	1 5% 1/4W
R331	1-216-117-00	RES,CHIP	680K 5% 1/10W	R610	1-215-924-00	METAL OXIDE	15K 5% 3W F
R332	1-216-033-00	RES,CHIP	220 5% 1/10W	R611	1-202-933-61	FUSIBLE	0.1 10% 1/2W F
R334	1-216-041-00	RES,CHIP	470 5% 1/10W	R613	1-219-134-11	FUSIBLE	0.1 10% 1/4W
R335	1-216-073-00	RES,CHIP	10K 5% 1/10W	R614	1-215-877-11	METAL OXIDE	22K 5% 1W F
R336	1-216-057-00	RES,CHIP	2.2K 5% 1/10W	R615	1-249-389-11	CARBON	4.7 5% 1/4W
R338	1-216-295-91	SHORT	0	R616 Δ	1-218-265-91	METAL	8.2M 5% 1W
R341	1-216-049-91	RES,CHIP	1K 5% 1/10W	R617	1-215-924-00	METAL OXIDE	15K 5% 3W F
R342	1-216-036-00	RES,CHIP	300 5% 1/10W	R618	1-532-845-21	LINK, IC	
R343	1-216-035-00	RES,CHIP	270 5% 1/10W	R619	1-219-134-11	FUSIBLE	0.1 10% 1/4W
R345	1-259-880-11	CARBON	2.2M 5% 1/4W	R620	1-202-962-11	CEMENTED	3.3 5% 10W
R351	1-216-001-00	RES,CHIP	10 5% 1/10W	R622	1-217-191-21	WIREWOUND	0.18 10% 2W F
R355	1-216-001-00	RES,CHIP	10 5% 1/10W	R623	1-247-807-31	CARBON	100 5% 1/4W
R356	1-216-049-91	RES,CHIP	1K 5% 1/10W	R624	1-215-881-11	METAL OXIDE	15 5% 2W F
R357	1-216-107-00	RES,CHIP	270K 5% 1/10W	R625	1-249-424-11	CARBON	3.9K 5% 1/4W
R360	1-208-291-11	RES,CHIP	4.7M 5% 1/10W	R626	1-249-420-11	CARBON	1.8K 5% 1/4W
R401	1-216-085-00	RES,CHIP	33K 5% 1/10W	R627	1-249-417-11	CARBON	1K 5% 1/4W
R402	1-216-081-00	RES,CHIP	22K 5% 1/10W	R628	1-249-417-11	CARBON	1K 5% 1/4W
R403	1-216-021-00	RES,CHIP	68 5% 1/10W	R629	1-249-399-11	CARBON	33 5% 1/4W
R404	1-216-035-00	RES,CHIP	270 5% 1/10W	R635	1-215-882-00	METAL OXIDE	22 5% 2W F

The components identified by shading
and mark Δ are critical for safety.
Replace only with part number specified.

A

REF. NO.	PART NO.	DESCRIPTION	REMARK	REF. NO.	PART NO.	DESCRIPTION	REMARK
R636	1-215-924-00	METAL OXIDE 15K	5% 3W F	R1211	1-216-021-00	RES,CHIP 68	5% 1/10W
R801	1-215-945-11	METAL OXIDE 3.3K	5% 5W F	R1212	1-216-049-91	RES,CHIP 1K	5% 1/10W
R802	1-249-381-11	CARBON 1	5% 1/4W F	R1213	1-216-049-91	RES,CHIP 1K	5% 1/10W
R803	1-216-057-00	RES,CHIP 2.2K	5% 1/10W	R1214	1-216-113-00	RES,CHIP 470K	5% 1/10W
R804	1-216-049-91	RES,CHIP 1K	5% 1/10W	R1215	1-216-113-00	RES,CHIP 470K	5% 1/10W
R805	1-216-081-00	RES,CHIP 22K	5% 1/10W	R1216	1-216-113-00	RES,CHIP 470K	5% 1/10W
R809	1-247-756-11	CARBON 2.2K	5% 1/2W F	R1218	1-216-041-00	RES,CHIP 470	5% 1/10W
R811	1-216-347-11	METAL OXIDE 0.68	5% 1W F	R1219	1-216-073-00	RES,CHIP 10K	5% 1/10W
R812	1-216-067-00	RES,CHIP 5.6K	5% 1/10W	R1220	1-216-049-91	RES,CHIP 1K	5% 1/10W
R816	1-249-435-11	CARBON 33K	5% 1/4W	R1221	1-216-073-00	RES,CHIP 10K	5% 1/10W
R821	1-215-910-00	METAL OXIDE 68	5% 3W F	R1222	1-216-049-91	RES,CHIP 1K	5% 1/10W
R822	1-216-429-00	METAL OXIDE 270	5% 1W F	R1223	1-216-073-00	RES,CHIP 10K	5% 1/10W
R823	1-249-931-11	CARBON 2.2K	5% 1/4W F	R1224	1-216-073-00	RES,CHIP 10K	5% 1/10W
R825	1-249-392-11	CARBON 8.2	5% 1/4W F	R1225	1-216-025-91	RES,CHIP 100	5% 1/10W
R826	1-216-059-00	RES,CHIP 2.7K	5% 1/10W	R1226	1-216-689-11	RES,CHIP 39K	5% 1/10W
R827	1-216-097-91	RES,CHIP 100K	5% 1/10W	R1227	1-216-689-11	RES,CHIP 39K	5% 1/10W
R828	1-216-063-91	RES,CHIP 3.9K	5% 1/10W	R1228	1-216-049-91	RES,CHIP 1K	5% 1/10W
R829	1-216-067-00	RES,CHIP 5.6K	5% 1/10W	R1229	1-216-041-00	RES,CHIP 470	5% 1/10W
R831	1-215-861-00	METAL OXIDE 47	5% 1W F	R1230	1-216-073-00	RES,CHIP 10K	5% 1/10W
R832	1-216-057-00	RES,CHIP 2.2K	5% 1/10W	R1231	1-216-049-91	RES,CHIP 1K	5% 1/10W
R834	1-216-073-00	RES,CHIP 10K	5% 1/10W	R1232	1-216-063-91	RES,CHIP 3.9K	5% 1/10W
R851	1-249-448-11	CARBON 1.2	5% 1/4W F	R1233	1-216-057-00	RES,CHIP 2.2K	5% 1/10W
R852	1-217-778-11	FUSIBLE 1K	5% 1W F	R1234	1-216-689-11	RES,CHIP 39K	5% 1/10W
R853	1-249-377-11	CARBON 0.47	5% 1/4W F	R1235	1-216-689-11	RES,CHIP 39K	5% 1/10W
R854	1-249-377-11	CARBON 0.47	5% 1/4W F	R1236	1-216-073-00	RES,CHIP 10K	5% 1/10W
R855	1-202-818-00	SOLID 1K	20% 1/2W	R1237	1-216-073-00	RES,CHIP 10K	5% 1/10W
R856	1-249-431-11	CARBON 15K	5% 1/4W	R1238	1-216-041-00	RES,CHIP 470	5% 1/10W
R857	1-249-439-11	CARBON 68K	5% 1/4W	R1239	1-249-389-11	CARBON 4.7	5% 1/4W F
R858	1-216-370-11	METAL OXIDE 1.2	5% 2W F	R1240	1-216-025-91	RES,CHIP 100	5% 1/10W
R860	1-247-887-00	CARBON 220K	5% 1/4W	R1241	1-216-049-91	RES,CHIP 1K	5% 1/10W
R881	1-216-041-00	RES,CHIP 470	5% 1/10W	R1242	1-216-049-91	RES,CHIP 1K	5% 1/10W
R882	1-216-059-00	RES,CHIP 2.7K	5% 1/10W	R1243	1-216-025-91	RES,CHIP 100	5% 1/10W
R895	1-216-349-00	METAL OXIDE 1	5% 1W F	R1244	1-216-025-91	RES,CHIP 100	5% 1/10W
R896	1-216-001-00	RES,CHIP 10	5% 1/10W	R1245	1-216-037-00	RES,CHIP 330	5% 1/10W
R898	1-249-421-11	CARBON 2.2K	5% 1/4W	R1246	1-216-037-00	RES,CHIP 330	5% 1/10W
R902	1-216-065-91	RES,CHIP 4.7K	5% 1/10W	R1247	1-216-041-00	RES,CHIP 470	5% 1/10W
R904	1-216-065-91	RES,CHIP 4.7K	5% 1/10W	R1248	1-216-051-00	RES,CHIP 1.2K	5% 1/10W
R905	1-216-049-91	RES,CHIP 1K	5% 1/10W	R1249	1-216-041-00	RES,CHIP 470	5% 1/10W
R906	1-216-049-91	RES,CHIP 1K	5% 1/10W	R1513	1-216-073-00	RES,CHIP 10K	5% 1/10W
R907	1-216-055-00	RES,CHIP 1.8K	5% 1/10W	R1514	1-216-065-91	RES,CHIP 4.7K	5% 1/10W
R908	1-216-055-00	RES,CHIP 1.8K	5% 1/10W	R1515	1-216-025-91	RES,CHIP 100	5% 1/10W
R909	1-216-061-00	RES,CHIP 3.3K	5% 1/10W			<VARIABLE RESISTOR>	
R910	1-216-061-00	RES,CHIP 3.3K	5% 1/10W				
R911	1-216-071-00	RES,CHIP 8.2K	5% 1/10W	RV301	1-241-769-11	RES, ADJ, CARBON 470K	
R913	1-216-041-00	RES,CHIP 470	5% 1/10W	RV302	1-237-525-21	RES, ADJ, CARBON 2.2M	
R914	1-216-041-00	RES,CHIP 470	5% 1/10W			<SWITCH>	
R915	1-216-071-00	RES,CHIP 8.2K	5% 1/10W	S601	Δ 1-571-433-31	SWITCH, PUSH (AC POWER)	
R1201	1-216-023-00	RES,CHIP 82	5% 1/10W	S801	1-572-707-11	SWITCH, LEVER	
R1202	1-216-049-91	RES,CHIP 1K	5% 1/10W	S901	1-570-577-11	SWITCH, PUSH	
R1203	1-216-089-91	RES,CHIP 47K	5% 1/10W	S902	1-570-577-11	SWITCH, PUSH	
R1204	1-216-089-91	RES,CHIP 47K	5% 1/10W	S903	1-570-577-11	SWITCH, PUSH	
R1205	1-216-023-00	RES,CHIP 82	5% 1/10W	S904	1-570-577-11	SWITCH, PUSH	
R1206	1-216-089-91	RES,CHIP 47K	5% 1/10W	S905	1-570-577-11	SWITCH, PUSH	
R1207	1-216-089-91	RES,CHIP 47K	5% 1/10W				
R1208	1-216-023-00	RES,CHIP 82	5% 1/10W				
R1209	1-216-061-00	RES,CHIP 3.3K	5% 1/10W				
R1210	1-216-061-00	RES,CHIP 3.3K	5% 1/10W				



The components identified by shading and mark Δ are critical for safety. Replace only with part number specified.

REF. NO.	PART NO.	DESCRIPTION	REMARK
		<SPARK GAP>	
SG801	1-519-422-11	GAP, SPARK	
		<SURFACE WAVE FILTER>	
SWF401	1-577-169-12	SAWF	
		<TRANSFORMER>	
T601	Δ 1-429-139-21	TRANSFORMER, CONVERTER (SRT)	
T605	Δ 1-424-461-11	TRANSFORMER, LINE FILTER	
T801	1-437-195-11	TRANSFORMER, HORIZONTAL DRIVE	
T851	Δ 1-453-219-11	TRANSFORMER ASSY, FLYBACK(NX-4002/M3J4)	
		<THERMISTOR>	
THP601	Δ 1-810-961-11	THERMISTOR, POSITIVE	
		<TUNER>	
TU101	Δ 8-598-323-50	VSS TUNER BT-AG401	
		<CRYSTAL>	
X101	1-577-082-11	VIBRATOR, CERAMIC	
X300	1-411-752-11	COIL	
X358	1-567-505-11	OSCILLATOR, CRYSTAL	
X443	1-567-504-11	OSCILLATOR, CRYSTAL	

	* A-1297-523-A	A3 BOARD, COMPLETE	*****
		<CAPACITOR>	
C1201	1-163-021-91	CERAMIC CHIP 0.01MF	10% 50V
C1202	1-164-004-11	CERAMIC CHIP 0.1MF	10% 25V
C1205	1-163-017-00	CERAMIC CHIP 0.0047MF	10% 50V
C1206	1-163-017-00	CERAMIC CHIP 0.0047MF	10% 50V
C1207	1-163-021-91	CERAMIC CHIP 0.01MF	10% 50V
C1208	1-163-083-00	CERAMIC CHIP 1PF	0.25PF 50V
C1209	1-163-109-00	CERAMIC CHIP 47PF	5% 50V
C1210	1-163-017-00	CERAMIC CHIP 0.0047MF	10% 50V
C1211	1-124-584-00	ELECT 100MF	20% 10V
C1212	1-163-017-00	CERAMIC CHIP 0.0047MF	10% 50V
C1213	1-126-151-11	ELECT 4.7MF	20% 16V
C1214	1-163-017-00	CERAMIC CHIP 0.0047MF	10% 50V
C1215	1-163-123-00	CERAMIC CHIP 180PF	5% 50V
C1216	1-124-465-00	ELECT 0.47MF	20% 50V
C1217	1-163-033-91	CERAMIC CHIP 0.022MF	50V
C1218	1-163-021-91	CERAMIC CHIP 0.01MF	10% 50V
C1219	1-124-584-00	ELECT 100MF	20% 10V
C1221	1-164-004-11	CERAMIC CHIP 0.1MF	10% 25V

REF. NO.	PART NO.	DESCRIPTION	REMARK
C1222	1-164-004-11	CERAMIC CHIP 0.1MF	10% 25V
C1223	1-164-004-11	CERAMIC CHIP 0.1MF	10% 25V
C1224	1-164-004-11	CERAMIC CHIP 0.1MF	10% 25V
C1225	1-163-093-00	CERAMIC CHIP 10PF	5% 50V
C1226	1-163-009-11	CERAMIC CHIP 0.001MF	10% 50V
C1227	1-163-131-00	CERAMIC CHIP 390PF	5% 50V
C1228	1-163-131-00	CERAMIC CHIP 390PF	5% 50V
C1229	1-126-157-11	ELECT 10MF	20% 16V
C1231	1-126-157-11	ELECT 10MF	20% 16V
C1232	1-124-234-00	ELECT 22MF	20% 16V
C1233	1-126-162-11	ELECT 3.3MF	20% 50V
C1234	1-164-004-11	CERAMIC CHIP 0.1MF	10% 25V
C1235	1-163-005-11	CERAMIC CHIP 470PF	10% 50V
C1236	1-163-005-11	CERAMIC CHIP 470PF	10% 50V
C1237	1-163-009-11	CERAMIC CHIP 0.001MF	10% 50V
C1238	1-164-004-11	CERAMIC CHIP 0.1MF	10% 25V
C1239	1-126-157-11	ELECT 10MF	20% 16V
C1240	1-164-222-11	CERAMIC CHIP 0.22MF	25V
C1241	1-124-589-11	ELECT 47MF	20% 16V
C1242	1-104-760-11	CERAMIC CHIP 0.047MF	10% 50V
C1243	1-163-021-91	CERAMIC CHIP 0.01MF	10% 50V
C1244	1-163-021-91	CERAMIC CHIP 0.01MF	10% 50V
C1245	1-163-021-91	CERAMIC CHIP 0.01MF	10% 50V
C1246	1-163-231-11	CERAMIC CHIP 15PF	5% 50V
C1247	1-163-229-11	CERAMIC CHIP 12PF	5% 50V
C1248	1-163-009-11	CERAMIC CHIP 0.001MF	10% 50V
C1250	1-163-009-11	CERAMIC CHIP 0.001MF	10% 50V
C1252	1-216-295-91	SHORT 0	
C1253	1-216-295-91	SHORT 0	
C1254	1-124-234-00	ELECT 22MF	20% 16V
C1255	1-124-584-00	ELECT 100MF	20% 10V
C1256	1-164-005-11	CERAMIC CHIP 0.47MF	25V
C1257	1-164-222-11	CERAMIC CHIP 0.22MF	25V
C1258	1-163-033-91	CERAMIC CHIP 0.022MF	50V
C1260	1-163-251-11	CERAMIC CHIP 100PF	5% 50V
C1262	1-163-251-11	CERAMIC CHIP 100PF	5% 50V
C1263	1-163-137-00	CERAMIC CHIP 680PF	5% 50V
C1264	1-163-251-11	CERAMIC CHIP 100PF	5% 50V
C1265	1-124-234-00	ELECT 22MF	20% 16V
C1266	1-124-589-11	ELECT 47MF	20% 16V
C1267	1-164-004-11	CERAMIC CHIP 0.1MF	10% 25V
C1268	1-124-584-00	ELECT 100MF	20% 10V
		<CONNECTOR>	
CN1201	1-691-109-11	PLUG (L TYPE) 12P	
		<DIODE>	
D1201	8-719-908-03	DIODE GP08D	
		<FERRITE BEAD>	
FB1201	1-412-911-11	FERRITE 0UH	
FB1202	1-412-911-11	FERRITE 0UH	
FB1203	1-412-911-11	FERRITE 0UH	
FB1204	1-412-911-11	FERRITE 0UH	

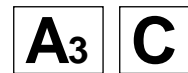

REF. NO.	PART NO.	DESCRIPTION	REMARK	REF. NO.	PART NO.	DESCRIPTION	REMARK
FB1205	1-412-911-11	FERRITE	0UH	R1211	1-216-015-00	RES,CHIP	39 5% 1/10W
FB1206	1-412-911-11	FERRITE	0UH	R1212	1-216-097-91	RES,CHIP	100K 5% 1/10W
		<FILTER>		R1213	1-216-097-91	RES,CHIP	100K 5% 1/10W
FL1201	1-239-803-11	ENCAPSULATED COMPONENT		R1214	1-216-033-00	RES,CHIP	220 5% 1/10W
		<IC>		R1217	1-216-073-00	RES,CHIP	10K 5% 1/10W
IC1201	8-752-059-57	IC CXA1110BS		R1218	1-216-049-91	RES,CHIP	1K 5% 1/10W
IC1202	8-759-493-49	IC MSP3410D-PP-B4		R1219	1-216-047-91	RES,CHIP	820 5% 1/10W
IC1203	8-759-231-53	IC TA7805S		R1220	1-216-049-91	RES,CHIP	1K 5% 1/10W
		<CHIP CONDUCTOR>		R1223	1-216-051-00	RES,CHIP	1.2K 5% 1/10W
JR1	1-216-295-91	SHORT	0	R1224	1-216-059-00	RES,CHIP	2.7K 5% 1/10W
JR2	1-216-295-91	SHORT	0	R1225	1-216-059-00	RES,CHIP	2.7K 5% 1/10W
JR3	1-216-295-91	SHORT	0	R1226	1-216-295-91	SHORT	0
JR4	1-216-295-91	SHORT	0	R1227	1-216-295-91	SHORT	0
JR5	1-216-295-91	SHORT	0	R1228	1-216-049-91	RES,CHIP	1K 5% 1/10W
JR6	1-216-295-91	SHORT	0	R1229	1-216-069-00	RES,CHIP	6.8K 5% 1/10W
JR7	1-216-295-91	SHORT	0	R1230	1-216-069-00	RES,CHIP	6.8K 5% 1/10W
JR8	1-216-295-91	SHORT	0	R1231	1-216-049-91	RES,CHIP	1K 5% 1/10W
JR9	1-216-295-91	SHORT	0	R1232	1-216-027-00	RES,CHIP	120 5% 1/10W
JR10	1-216-295-91	SHORT	0	R1233	1-216-045-00	RES,CHIP	680 5% 1/10W
JR11	1-216-295-91	SHORT	0	R1234	1-216-045-00	RES,CHIP	680 5% 1/10W
		<COIL>		R1240	1-216-041-00	RES,CHIP	470 5% 1/10W
L1201	1-408-593-31	INDUCTOR	1.5UH	R1241	1-216-075-00	RES,CHIP	12K 5% 1/10W
L1202	1-412-010-41	INDUCTOR CHIP	22UH	R1242	1-216-027-00	RES,CHIP	120 5% 1/10W
L1203	1-408-602-31	INDUCTOR	8.2UH	R1243	1-216-037-00	RES,CHIP	330 5% 1/10W
L1204	1-408-591-11	INDUCTOR	1UH	R1244	1-216-059-00	RES,CHIP	2.7K 5% 1/10W
L1205	1-408-602-31	INDUCTOR	8.2UH	R1245	1-216-057-00	RES,CHIP	2.2K 5% 1/10W
L1206	1-412-951-11	INDUCTOR	10UH	R1246	1-260-306-51	CARBON	15 5% 1/2W
L1207	1-412-951-11	INDUCTOR	10UH			<SWITCH>	
		<TRANSISTOR>		SW1201	1-579-560-11	FILTER, SAWTOOTH WAVE	
Q1201	8-729-230-49	TRANSISTOR 2SC2712-YG		SW1202	1-579-559-11	FILTER, SAWTOOTH WAVE	
Q1203	8-729-266-92	TRANSISTOR 2SC2669-O				<TRANSFORMER>	
Q1205	8-729-216-22	TRANSISTOR 2SA1162-G		T1202	1-416-000-11	COIL	
Q1206	8-729-216-22	TRANSISTOR 2SA1162-G				<CRYSTAL>	
Q1207	8-729-230-49	TRANSISTOR 2SC2712-YG		X1201	1-760-094-11	VIBRATOR, CRYSTAL	
Q1211	8-729-230-49	TRANSISTOR 2SC2712-YG				*****	
Q1212	8-729-230-49	TRANSISTOR 2SC2712-YG				* A-1331-740-A C BOARD, MOUNTED	
		<RESISTOR>				*****	
R1201	1-216-022-00	RES,CHIP	75 5% 1/10W			<CAPACITOR>	
R1202	1-216-085-00	RES,CHIP	33K 5% 1/10W	C701	1-162-114-00	CERAMIC	0.0047MF 2KV
R1203	1-216-081-00	RES,CHIP	22K 5% 1/10W	C702	1-102-074-00	CERAMIC	0.001MF 10% 50V
R1204	1-216-035-00	RES,CHIP	270 5% 1/10W	C704	1-130-202-00	FILM	0.022MF 5% 400V
R1205	1-216-027-00	RES,CHIP	120 5% 1/10W	C708	1-102-114-00	CERAMIC	470PF 10% 50V
R1207	1-216-053-00	RES,CHIP	1.5K 5% 1/10W	C709	1-102-114-00	CERAMIC	470PF 10% 50V
R1209	1-216-035-00	RES,CHIP	270 5% 1/10W				
R1210	1-216-041-00	RES,CHIP	470 5% 1/10W				

C

The components identified by shading and mark Δ are critical for safety. Replace only with part number specified.

REF. NO.	PART NO.	DESCRIPTION	REMARK	REF. NO.	PART NO.	DESCRIPTION	REMARK
C710	1-102-114-00	CERAMIC 470PF	10% 50V	<RESISTOR>			
C712	1-102-107-00	CERAMIC 120PF	10% 50V	R701	1-244-941-00	CARBON 680K	5% 1/2W
C713	1-102-107-00	CERAMIC 120PF	10% 50V	R702	1-249-496-11	CARBON 100K	5% 1/2W
C714	1-102-107-00	CERAMIC 120PF	10% 50V	R703	1-249-496-11	CARBON 100K	5% 1/2W
C716	1-126-968-11	ELECT 100MF	20% 50V	R705	1-216-345-11	METAL OXIDE 0.47	5% 1W F
<CONNECTOR>				R710	1-215-899-11	METAL OXIDE 15K	5% 2W F
CN701	1-508-766-00	PIN, CONNECTOR (5MM PITCH) 4P		R711	1-247-760-11	CARBON 4.7K	5% 1/2W
CN703 *	1-564-509-11	PLUG, CONNECTOR 6P		R712	1-215-899-11	METAL OXIDE 15K	5% 2W F
CN704	1-695-915-11	TAB (CONTACT)		R713	1-247-760-11	CARBON 4.7K	5% 1/2W
<DIODE>				R714	1-215-899-11	METAL OXIDE 15K	5% 2W F
D701	8-719-911-19	DIODE 1SS119-25		R715	1-247-760-11	CARBON 4.7K	5% 1/2W
D702	8-719-911-19	DIODE 1SS119-25		R716	1-249-405-11	CARBON 100	5% 1/4W F
D703	8-719-911-19	DIODE 1SS119-25		R717	1-249-405-11	CARBON 100	5% 1/4W F
D704	8-719-911-19	DIODE 1SS119-25		R718	1-249-405-11	CARBON 100	5% 1/4W F
D705	8-719-911-19	DIODE 1SS119-25		R719	1-215-485-00	METAL 470K	1% 1/4W
D706	8-719-911-19	DIODE 1SS119-25		R720	1-249-417-11	CARBON 1K	5% 1/4W F
D707	8-719-911-19	DIODE 1SS119-25		R721	1-215-491-00	METAL 820K	1% 1/4W
D708	8-719-911-19	DIODE 1SS119-25		R722	1-249-923-11	CARBON 1K	5% 1/4W F
D709	8-719-911-19	DIODE 1SS119-25		R723	1-215-479-00	METAL 270K	1% 1/4W
D710	8-719-911-19	DIODE 1SS119-25		R724	1-249-417-11	CARBON 1K	5% 1/4W F
D711	8-719-911-19	DIODE 1SS119-25		R725	1-249-422-11	CARBON 2.7K	5% 1/4W
D712	8-719-911-19	DIODE 1SS119-25		R726	1-249-422-11	CARBON 2.7K	5% 1/4W
D716	8-719-911-19	DIODE 1SS119-25		R727	1-249-422-11	CARBON 2.7K	5% 1/4W
D717	8-719-121-26	DIODE RD9.1ESL2		R728	1-249-412-11	CARBON 390	5% 1/4W
<JACK>				R729	1-249-412-11	CARBON 390	5% 1/4W
J701 Δ	1-251-595-11	SOCKET, CRT		R730	1-249-412-11	CARBON 390	5% 1/4W
<COIL>				R731	1-247-807-31	CARBON 100	5% 1/4W
L701	1-410-667-31	INDUCTOR 22UH		R732	1-247-807-31	CARBON 100	5% 1/4W
L703	1-408-615-31	INDUCTOR 100UH		R733	1-247-807-31	CARBON 100	5% 1/4W
L705	1-408-615-31	INDUCTOR 100UH		R734	1-247-739-11	CARBON 100	5% 1/2W
L707	1-408-615-31	INDUCTOR 100UH		R738	1-247-807-31	CARBON 100	5% 1/4W
<TRANSISTOR>				R739	1-247-807-31	CARBON 100	5% 1/4W
Q701	8-729-326-11	TRANSISTOR 2SC2611		R740	1-247-807-31	CARBON 100	5% 1/4W
Q702	8-729-326-11	TRANSISTOR 2SC2611		R747	1-216-489-11	METAL OXIDE 27K	5% 3W F
Q703	8-729-326-11	TRANSISTOR 2SC2611		R749	1-216-490-11	METAL OXIDE 39K	5% 3W F
Q704	8-729-326-11	TRANSISTOR 2SC2611		R751	1-215-926-00	METAL OXIDE 33K	5% 3W F
Q705	8-729-326-11	TRANSISTOR 2SC2611		R753	1-249-429-11	CARBON 10K	5% 1/4W
Q706	8-729-326-11	TRANSISTOR 2SC2611		R755	1-249-427-11	CARBON 6.8K	5% 1/4W
Q707	8-729-200-17	TRANSISTOR 2SA1091-O		R756	1-249-427-11	CARBON 6.8K	5% 1/4W
Q708	8-729-200-17	TRANSISTOR 2SA1091-O		R757	1-249-427-11	CARBON 6.8K	5% 1/4W
Q709	8-729-200-17	TRANSISTOR 2SA1091-O		R758	1-249-419-11	CARBON 1.5K	5% 1/4W
Q710	8-729-119-78	TRANSISTOR 2SC2785-HFE		R759	1-249-419-11	CARBON 1.5K	5% 1/4W
Q711	8-729-119-78	TRANSISTOR 2SC2785-HFE		R760	1-249-419-11	CARBON 1.5K	5% 1/4W F
Q712	8-729-119-78	TRANSISTOR 2SC2785-HFE		<VARIABLE RESISTOR>			
Q714	8-729-255-12	TRANSISTOR 2SC2551-O		RV701	1-230-641-11	RES, ADJ, METAL GLAZE 2.2M	
				RV702	1-241-656-21	RES, ADJ, METAL FILM 110M	

The components identified by shading and mark Δ are critical for safety. Replace only with part number specified.

F₁ **V₁**

REF. NO.	PART NO.	DESCRIPTION	REMARK
	* A-1241-269-A	F1 BOARD, MOUNTED *****	
	1-533-223-11	CLIP, FUSE <CAPACITOR>	
C1601	Δ 1-104-706-51	FILM 0.22MF 20% 250V	
		<CONNECTOR>	
CN1601 *	1-580-843-11	PIN, CONNECTOR (POWER)	
CN1602 *	1-580-843-11	PIN, CONNECTOR (POWER) <FUSE>	
F1601	Δ 1-532-350-11	FUSE, TIME-LAG 4A/250V <RESISTOR>	
R1601	Δ 1-202-916-91	SOLID 5.6M 20% 1/2W <TRANSFORMER>	
T1601	Δ 1-424-436-11	TRANSFORMER, LINE FILTER	
T1602	Δ 1-424-436-11	TRANSFORMER, LINE FILTER	

	* A-1347-103-A	V1 BOARD, COMPLETE *****	
	4-049-406-01	CASE (BOTTOM LID), SHIELD	
	4-049-407-01	CASE (UPPER LID), SHIELD <CAPACITOR>	
C01	1-163-037-11	CERAMIC CHIP 0.022MF 10% 50V	
C02	1-124-907-11	ELECT 10MF 20% 50V	
C03	1-163-037-11	CERAMIC CHIP 0.022MF 10% 50V	
C04	1-164-004-11	CERAMIC CHIP 0.1MF 10% 25V	
C05	1-124-907-11	ELECT 10MF 20% 50V	
C06	1-163-227-11	CERAMIC CHIP 10PF 0.5PF 50V	
C07	1-163-009-11	CERAMIC CHIP 0.001MF 10% 50V	
C08	1-163-231-11	CERAMIC CHIP 15PF 5% 50V	
C09	1-164-004-11	CERAMIC CHIP 0.1MF 10% 25V	
C10	1-164-004-11	CERAMIC CHIP 0.1MF 10% 25V	
C11	1-164-004-11	CERAMIC CHIP 0.1MF 10% 25V	
C12	1-164-004-11	CERAMIC CHIP 0.1MF 10% 25V	
C13	1-163-009-11	CERAMIC CHIP 0.001MF 10% 50V	
C14	1-216-295-91	SHORT 0	
C15	1-104-668-11	ELECT 33MF 20% 35V	
C16	1-126-963-11	ELECT 4.7MF 20% 50V	
C17	1-164-004-11	CERAMIC CHIP 0.1MF 10% 25V	
C19	1-164-004-11	CERAMIC CHIP 0.1MF 10% 25V	

REF. NO.	PART NO.	DESCRIPTION	REMARK
C20	1-163-117-00	CERAMIC CHIP 100PF 5% 50V	
C22	1-126-791-11	ELECT 10MF 20% 16V	
C23	1-163-038-91	CERAMIC CHIP 0.1MF 25V	
C24	1-163-117-00	CERAMIC CHIP 100PF 5% 50V	
C25	1-126-791-11	ELECT 10MF 20% 16V	
C26	1-104-665-11	ELECT 100MF 20% 10V	
C27	1-104-665-11	ELECT 100MF 20% 16V	
C28	1-163-099-00	CERAMIC CHIP 18PF 5% 50V	
C29	1-163-099-00	CERAMIC CHIP 18PF 5% 50V	
C30	1-163-099-00	CERAMIC CHIP 18PF 5% 50V	
C31	1-163-099-00	CERAMIC CHIP 18PF 5% 50V	
C32	1-104-665-11	ELECT 100MF 20% 10V <CONNECTOR>	
CN01	* 1-770-748-11	CONNECTOR, BOARD TO BOARD 12P <DIODE>	
D01	8-719-105-52	DIODE RD3.6M-B2	
D03	8-719-914-43	DIODE DAN202K	
D04	8-719-105-91	DIODE RD5.6M-B2	
D05	8-719-914-44	DIODE DAP202K	
D06	8-719-914-43	DIODE DAN202K <FERRITE BEAD>	
FB01	1-410-397-21	FERRITE 1.1UH	
		<IC>	
IC01	8-759-324-28	IC P83C654FBP/540	
IC02	8-759-298-63	IC SAA5281ZP/E	
		<CHIP CONDUCTOR>	
JR02	1-216-295-91	SHORT 0	
JR03	1-216-295-91	SHORT 0	
JR04	1-216-295-91	SHORT 0	
JR07	1-216-295-91	SHORT 0	
JR08	1-216-295-91	SHORT 0	
JR09	1-216-295-91	SHORT 0	
		<COIL>	
L01	1-410-464-11	INDUCTOR 3.3UH	
L03	1-410-464-11	INDUCTOR 3.3UH	
L04	1-410-464-11	INDUCTOR 3.3UH	
L05	1-410-464-11	INDUCTOR 3.3UH	
L06	1-410-464-11	INDUCTOR 3.3UH	
		<TRANSISTOR>	
Q01	8-729-120-28	TRANSISTOR 2SC1623-L5L6	
Q02	8-729-027-43	TRANSISTOR DTC114EKA-T146	
Q03	8-729-120-28	TRANSISTOR 2SC1623-L5L6	
Q04	8-729-120-28	TRANSISTOR 2SC1623-L5L6	
Q05	8-729-920-72	TRANSISTOR 2SA1037K-T-146-QR	



REF. NO.	PART NO.	DESCRIPTION	REMARK	REF. NO.	PART NO.	DESCRIPTION	REMARK
Q06	8-729-120-28	TRANSISTOR 2SC1623-L5L6		*****			
Q07	8-729-019-01	TRANSISTOR 2SD2394-EF					
Q08	8-729-140-96	TRANSISTOR 2SD774-34					
Q09	8-729-027-23	TRANSISTOR DTA114EKA-T146					
		<RESISTOR>					
R01	1-216-061-00	RES,CHIP	3.3K 5% 1/10W				
R02	1-216-057-00	RES,CHIP	2.2K 5% 1/10W				
R03	1-216-085-00	RES,CHIP	33K 5% 1/10W				
R04	1-216-025-91	RES,CHIP	100 5% 1/10W				
R05	1-216-057-00	RES,CHIP	2.2K 5% 1/10W				
		<CAPACITOR>					
R06	1-216-075-00	RES,CHIP	12K 5% 1/10W	C1721	1-126-964-11	ELECT 10MF 20% 50V	
R07	1-216-025-91	RES,CHIP	100 5% 1/10W	C1722	1-102-114-00	CERAMIC 470PF 10% 50V	
R08	1-216-025-91	RES,CHIP	100 5% 1/10W	C1723	1-102-951-00	CERAMIC 15PF 5% 50V	
R09	1-216-057-00	RES,CHIP	2.2K 5% 1/10W	C1724	1-101-888-00	CERAMIC 68PF 5% 50V	
R10	1-216-083-00	RES,CHIP	27K 5% 1/10W	C1751	1-136-153-00	FILM 0.01MF 5% 50V	
R11	1-216-069-00	RES,CHIP	6.8K 5% 1/10W	C1761	1-161-830-00	CERAMIC 0.0047MF 500V	
R12	1-216-057-00	RES,CHIP	2.2K 5% 1/10W	C1762	1-102-951-00	CERAMIC 15PF 5% 50V	
R13	1-216-061-00	RES,CHIP	3.3K 5% 1/10W	C1763	1-107-638-11	ELECT 33MF 20% 160V	
R14	1-164-004-11	CERAMIC CHIP	0.1MF 10% 25V	C1764	1-126-933-11	ELECT 100MF 20% 16V	
R16	1-216-073-00	RES,CHIP	10K 5% 1/10W	C1768	1-106-383-00	MYLAR 0.047MF 10% 200V	
R17	1-216-065-91	RES,CHIP	4.7K 5% 1/10W	C1769	1-107-667-11	ELECT 2.2MF 20% 160V	
R18	1-216-059-00	RES,CHIP	2.7K 5% 1/10W	C1770	1-104-999-11	MYLAR 0.1MF 10% 200V	
R19	1-216-049-91	RES,CHIP	1K 5% 1/10W	C1771	1-126-964-11	ELECT 10MF 20% 50V	
R20	1-216-049-91	RES,CHIP	1K 5% 1/10W	C1772	1-126-933-11	ELECT 100MF 20% 16V	
R21	1-216-065-91	RES,CHIP	4.7K 5% 1/10W	C1773	1-106-383-00	MYLAR 0.047MF 10% 200V	
R22	1-216-041-00	RES,CHIP	470 5% 1/10W	C1774	1-102-959-91	CERAMIC 22PF 5% 50V	
R24	1-216-025-91	RES,CHIP	100 5% 1/10W	C1775	1-126-933-11	ELECT 100MF 20% 16V	
R25	1-216-025-91	RES,CHIP	100 5% 1/10W	C1776	1-126-964-11	ELECT 10MF 20% 50V	
R26	1-216-049-91	RES,CHIP	1K 5% 1/10W	C1777	1-101-888-00	CERAMIC 68PF 5% 50V	
R27	1-216-071-00	RES,CHIP	8.2K 5% 1/10W	C1778	1-130-471-00	MYLAR 0.001MF 5% 50V	
R28	1-216-025-91	RES,CHIP	100 5% 1/10W	C1779	1-130-471-00	MYLAR 0.001MF 5% 50V	
R29	1-216-025-91	RES,CHIP	100 5% 1/10W	C1780	1-126-964-11	ELECT 10MF 20% 50V	
R30	1-216-071-00	RES,CHIP	8.2K 5% 1/10W	C1781	1-107-714-11	ELECT 10MF 20% 16V	
R31	1-216-025-91	RES,CHIP	100 5% 1/10W	C1782	1-136-153-00	FILM 0.01MF 5% 50V	
R32	1-216-071-00	RES,CHIP	8.2K 5% 1/10W	C1783	1-136-153-00	FILM 0.01MF 5% 50V	
R33	1-216-065-91	RES,CHIP	4.7K 5% 1/10W	C1784	1-102-244-00	CERAMIC 220PF 10% 500V	
R34	1-216-065-91	RES,CHIP	4.7K 5% 1/10W	C1788	1-136-153-00	FILM 0.01MF 5% 50V	
R35	1-216-065-91	RES,CHIP	4.7K 5% 1/10W	C1789	1-107-714-11	ELECT 10MF 20% 16V	
R36	1-216-025-91	RES,CHIP	100 5% 1/10W	C1790	1-126-964-11	ELECT 10MF 20% 50V	
R37	1-216-049-91	RES,CHIP	1K 5% 1/10W	C1791	1-126-964-11	ELECT 10MF 20% 50V	
R38	1-260-095-11	CARBON	470 5% 1/2W	C1841	1-136-155-00	FILM 0.015MF 5% 50V	
R41	1-216-063-91	RES,CHIP	3.9K 5% 1/10W	C1844	1-108-700-11	MYLAR 0.047MF 10% 200V	
R42	1-216-077-00	RES,CHIP	15K 5% 1/10W	C1845	1-137-194-81	FILM 0.47MF 5% 50V	
R43	1-216-295-91	SHORT	0	C1846	1-126-964-11	ELECT 10MF 20% 50V	
R44	1-216-083-00	RES,CHIP	27K 5% 1/10W	C1901	1-136-060-00	FILM 0.047MF 5% 400V	
		<CONNECTOR>					
R45	1-216-021-00	RES,CHIP	68 5% 1/10W	CN1701*	1-564-509-11	PLUG, CONNECTOR 6P	
R46	1-216-021-00	RES,CHIP	68 5% 1/10W	CN1702*	1-564-510-11	PLUG, CONNECTOR 7P	
R47	1-216-021-00	RES,CHIP	68 5% 1/10W	CN1703*	1-564-506-11	PLUG, CONNECTOR 3P	
R48	1-216-049-91	RES,CHIP	1K 5% 1/10W	CN1704*	1-564-506-11	PLUG, CONNECTOR 3P	
R49	1-216-049-91	RES,CHIP	1K 5% 1/10W	CN1705	4-352-844-01	PIN, LEAD, COATING	
R50	1-216-049-91	RES,CHIP	1K 5% 1/10W	CN1901*	1-508-784-00	PIN, CONNECTOR (5MM PITCH) 1P	
		<CRYSTAL>		CN1902*	1-564-506-11	PLUG, CONNECTOR 3P	
X01	1-579-266-31	CRYSTAL VIBRATOR					



REF. NO.	PART NO.	DESCRIPTION	REMARK	REF. NO.	PART NO.	DESCRIPTION	REMARK
		<DIODE>		R1726	1-247-815-91	CARBON 220 5%	1/4W
D1761	8-719-911-19	DIODE 1SS119-25		R1727	1-249-419-11	CARBON 1.5K 5%	1/4W
D1763	8-719-911-19	DIODE 1SS119-25		R1728	1-249-417-11	CARBON 1K 5%	1/4W
D1764	8-719-911-19	DIODE 1SS119-25		R1729	1-249-437-11	CARBON 47K 5%	1/4W
D1767	8-719-110-88	DIODE RD39ESB2		R1730	1-249-438-11	CARBON 56K 5%	1/4W
D1768	8-719-110-88	DIODE RD39ESB2		R1731	1-247-815-91	CARBON 220 5%	1/4W
D1769	8-719-911-19	DIODE 1SS119-25		R1732	1-249-419-11	CARBON 1.5K 5%	1/4W
D1770	8-719-911-19	DIODE 1SS119-25		R1736	1-249-419-11	CARBON 1.5K 5%	1/4W
D1774	8-719-109-84	DIODE RD5.1ESB1		R1753	1-249-425-11	CARBON 4.7K 5%	1/4W
D1775	8-719-109-84	DIODE RD5.1ESB1		R1762	1-247-815-91	CARBON 220 5%	1/4W
D1840	8-719-302-43	DIODE EL1Z		R1764	1-247-734-11	CARBON 39 5%	1/2W F
D1841	8-719-911-19	DIODE 1SS119-25		R1765	1-249-414-11	CARBON 560 5%	1/4W F
D1842	8-719-109-84	DIODE RD5.1ESB1		R1766	1-249-418-11	CARBON 1.2K 5%	1/4W
		<IC>		R1768	1-249-418-11	CARBON 1.2K 5%	1/4W
IC1701	8-759-729-03	IC NJM2903D		R1769	1-249-387-11	CARBON 3.3 5%	1/4W F
IC1702	8-759-700-42	IC NJM2904D		R1770	1-249-435-11	CARBON 33K 5%	1/4W
		<COIL>		R1772	1-249-432-11	CARBON 18K 5%	1/4W
L1721	1-408-617-31	INDUCTOR 150UH		R1774	1-215-912-11	METAL OXIDE 150 5%	3W F
L1722	1-408-617-31	INDUCTOR 180UH		R1775	1-249-417-11	CARBON 1K 5%	1/4W F
L1723	1-410-468-11	INDUCTOR 6.8UH		R1776	1-249-432-11	CARBON 18K 5%	1/4W
L1761	1-410-478-11	INDUCTOR 47UH		R1777	1-249-438-11	CARBON 56K 5%	1/4W
L1762	1-408-610-31	INDUCTOR 39UH		R1778	1-249-430-11	CARBON 12K 5%	1/4W
L1841	1-459-075-00	COIL,DYNAMIC CONVERSION CHOKE		R1779	1-249-414-11	CARBON 560 5%	1/4W
L1843	1-459-104-00	COIL, WITH CORE		R1780	1-249-420-11	CARBON 1.8K 5%	1/4W
L1901	1-459-104-00	COIL, WITH CORE		R1781	1-249-410-11	CARBON 270 5%	1/4W
		<TRANSISTOR>		R1782	1-249-387-11	CARBON 3.3 5%	1/4W F
Q1721	8-729-119-78	TRANSISTOR 2SC2785-HFE		R1784	1-247-807-31	CARBON 100 5%	1/4W
Q1722	8-729-119-78	TRANSISTOR 2SC2785-HFE		R1785	1-249-400-11	CARBON 39 5%	1/4W F
Q1723	8-729-119-78	TRANSISTOR 2SC2785-HFE		R1786	1-249-435-11	CARBON 33K 5%	1/4W
Q1756	8-729-119-78	TRANSISTOR 2SC2785-HFE		R1787	1-249-428-11	CARBON 8.2K 5%	1/4W
Q1761	8-729-119-78	TRANSISTOR 2SC2785-HFE		R1788	1-249-419-11	CARBON 1.5K 5%	1/4W
Q1762	8-729-119-76	TRANSISTOR 2SA1175-HFE		R1789	1-249-413-11	CARBON 470 5%	1/4W
Q1763	8-729-017-05	TRANSISTOR 2SA1837		R1790	1-216-451-11	METAL OXIDE 120 5%	2W F
Q1764	8-729-119-78	TRANSISTOR 2SC2785-HFE		R1791	1-249-411-11	CARBON 330 5%	1/4W
Q1765	8-729-017-06	TRANSISTOR 2SC4793		R1793	1-249-429-11	CARBON 10K 5%	1/4W
Q1766	8-729-119-78	TRANSISTOR 2SC2785-HFE		R1794	1-215-892-11	METAL OXIDE 1K 5%	2W F
Q1767	8-729-142-86	TRANSISTOR 2SC3733		R1795	1-249-389-11	CARBON 4.7 5%	1/4W F
Q1768	8-729-119-78	TRANSISTOR 2SC2785-HFE		R1796	1-249-377-11	CARBON 0.47 5%	1/4W F
Q1769	8-729-119-76	TRANSISTOR 2SA1175-HFE		R1797	1-215-862-11	METAL OXIDE 68 5%	1W F
Q1770	8-729-119-78	TRANSISTOR 2SC2785-HFE		R1800	1-249-429-11	CARBON 10K 5%	1/4W
Q1771	8-729-119-76	TRANSISTOR 2SA1175-HFE		R1801	1-249-437-11	CARBON 47K 5%	1/4W
Q1777	8-729-326-11	TRANSISTOR 2SC2611		R1805	1-249-429-11	CARBON 10K 5%	1/4W
Q1840	8-729-119-78	TRANSISTOR 2SC2785-HFE		R1806	1-249-429-11	CARBON 10K 5%	1/4W
Q1841	8-729-195-82	TRANSISTOR 2SC2958-L		R1812	1-249-425-11	CARBON 4.7K 5%	1/4W
		<RESISTOR>		R1816	1-249-415-11	CARBON 680 5%	1/4W
R1721	1-249-413-11	CARBON 470 5%	1/4W	R1817	1-249-429-11	CARBON 10K 5%	1/4W
R1722	1-249-411-11	CARBON 330 5%	1/4W	R1818	1-249-429-11	CARBON 10K 5%	1/4W
R1723	1-249-406-11	CARBON 120 5%	1/4W	R1819	1-249-403-11	CARBON 68 5%	1/4W
R1724	1-247-815-91	CARBON 220 5%	1/4W	R1820	1-249-417-11	CARBON 1K 5%	1/4W
R1725	1-249-408-11	CARBON 180 5%	1/4W	R1841	1-249-435-11	CARBON 33K 5%	1/4W
				R1842	1-260-111-11	CARBON 10K 5%	1/2W
				R1843	1-249-421-11	CARBON 2.2K 5%	1/4W
				R1844	1-249-421-11	CARBON 2.2K 5%	1/4W
				R1847	1-249-399-11	CARBON 33 5%	1/4W F
				R1848	1-216-434-11	METAL OXIDE 1.8K 5%	1W F
				R1849	1-260-111-11	CARBON 10K 5%	1/2W
				R1850	1-249-417-11	CARBON 1K 5%	1/4W



The components identified by shading and mark Δ are critical for safety. Replace only with part number specified.

REF. NO.	PART NO.	DESCRIPTION	REMARK
R1851	1-249-393-11	CARBON 10	5% 1/4W
R1901	1-249-399-11	CARBON 33	5% 1/4W F
		<VARIABLE RESISTOR>	
RV1814	1-241-764-11	RES, ADJ, CARBON 10K	
		<TRANSFORMER>	
T1901	1-413-059-00	TRANSFORMER, FERRITE (DFT)	

REF. NO.	PART NO.	DESCRIPTION	REMARK
		ACCESSORIES AND PACKING MATERIALS	

	3-701-910-00	SCREW, SPECIAL (DIA. 3.8X20)	
	3-861-432-62	MANUAL, INSTRUCTION	
*	4-029-168-01	BAG, PROTECTION	
*	4-053-737-01	CUSHION (UPPER)(ASSY)	
*	4-053-740-01	CUSHION (LOWER)(ASSY)	
*	4-053-743-01	INDIVIDUAL CARTON	
*	4-053-744-01	TRAY	
	4-065-210-01	JOINT	
	4-392-003-11	BAND, HOLD	
	4-392-004-11	CLIP	

MISCELLANEOUS

Δ 1-403-672-12	COIL, DEMAGNETIZATION
1-452-032-00	MAGNET, DISC
1-452-278-22	MAGNET, PURITY
1-452-278-32	MAGNET, PURITY
1-452-762-31	NECK ASSEMBLY NA294
1-503-902-11	SPEAKER (15X6.5 CM)
Δ 1-574-358-51	CORD, POWER (WITH CONNECTOR) 7.5A/250V
1-900-700-10	DGC BAND
Δ 1-900-700-27	LEAD ASSY, FOCUS
Δ 8-451-467-21	DEFLECTION YOKE (Y29GXA2-S)
Δ 8-733-868-05	PICTURE TUBE (M68KZT71X)

REMOTE COMMANDER

1-473-323-11	REMOTE COMMANDER (RM-870)
9-902-546-01	BATTERY COVER, REMOTE COMMANDER

Free Manuals Download Website

<http://myh66.com>

<http://usermanuals.us>

<http://www.somanuals.com>

<http://www.4manuals.cc>

<http://www.manual-lib.com>

<http://www.404manual.com>

<http://www.luxmanual.com>

<http://aubethermostatmanual.com>

Golf course search by state

<http://golfingnear.com>

Email search by domain

<http://emailbydomain.com>

Auto manuals search

<http://auto.somanuals.com>

TV manuals search

<http://tv.somanuals.com>