

"BRAVIA" TV Features

Watching TV

Using the Home Menu

Fun Features with
Connected Equipment

Parts Description

Troubleshooting

Index

[→ i-Manual online map](#)

BRAVIA

EX71x

[→ Trademark information](#)

"BRAVIA" TV Features

Watching TV

Using the Home Menu

Fun Features with
Connected Equipment

Parts Description

Troubleshooting

Index

[→ i-Manual online map](#)

"BRAVIA" TV Features

[Motionflow](#)

[Presence Sensor](#)

[Ambient Sensor](#)

["BRAVIA" Internet Video](#)

[Wireless LAN Ready](#)

[Playback via USB](#)

["BRAVIA" Sync with Control for HDMI](#)

[Favorites](#)

[▲ Return to Top](#)

"BRAVIA" TV Features

Watching TV

Using the Home Menu

Fun Features with
Connected Equipment

Parts Description

Troubleshooting

Index

[→ i-Manual online map](#)

Watching TV

[TV Guide On Screen®](#)

[Favorites](#)

[Wide Mode](#)

[Picture in Picture \(PIP\)](#)

[Angle Adjustment \(Swivel\)](#)

[▲ Return to Top](#)

"BRAVIA" TV Features

Watching TV

Using the Home Menu

Fun Features with
Connected Equipment

Parts Description

Troubleshooting

Index

[→ i-Manual online map](#)

Using the Home Menu

About the Home Menu

-  [Product Support](#)
-  [Preferences](#)
-  [Picture & Display](#)
-  [Sound](#)
-  [Channels & Inputs](#)
-  [Network](#)

[▲ Return to Top](#)

"BRAVIA" TV Features

Watching TV

Using the Home Menu

Fun Features with
Connected Equipment

Parts Description

Troubleshooting

Index

[→ i-Manual online map](#)

Fun Features with Connected Equipment

[VCR/DVD Player](#)

[Audio System](#)

[Digital Still Camera](#)

[HDMI Equipment](#)

[Internet](#)

[Settings](#)

["BRAVIA" Internet Video](#)

[Photomap](#)

[Home Network](#)

[PC](#)

[▲ Return to Top](#)

"BRAVIA" TV Features

Watching TV

Using the Home Menu

Fun Features with
Connected Equipment

Parts Description

Troubleshooting

Index

[→ i-Manual online map](#)

Parts Description

Remote Control

[Top](#)

[Upper](#)

[Middle](#)

[Lower](#)

[Bottom](#)

[Back](#)

TV Controls and Indicators

[Front](#)

[Right](#)

Terminals

[Back](#)

[Right](#)

[▲ Return to Top](#)

"BRAVIA" TV Features

Watching TV

Using the Home Menu

Fun Features with
Connected Equipment

Parts Description

Troubleshooting

Index

[➔ i-Manual online map](#)

Troubleshooting

[Picture](#)

[Sound](#)

[Channels](#)

[Home Network](#)

[Remote Control](#)

[General](#)

[▲ Return to Top](#)

A

- Add Digital Channels
- Adding/Removing Favorites
- Advanced Settings
- Age Restriction
- Ambient Sensor Settings
- Analog CC
- Analog Channel Tuning
- Angle Adjustment (Swivel)
- ARC
- Artifacts Reduction
- Audience Monitoring Function
- Audio system (Connected Equipment)
- Auto SAP

B

- Bilingual Settings
- Broadcaster
- "BRAVIA" Sync-Compatible Equipment

C

- Cable/Antenna Selection
- Camcorder (Connected Equipment)
- CC Display
- Channel Labels
- CineMotion
- Clock/Timers
- Component
- Composite
- Contact Information
- Control for HDMI
- Cursor Speed

D

- DIGITAL AUDIO OUT
- Digital Camera (Connected Equipment)
- Digital CC
- DLNA Certified Media Server

E

- Eco Settings
- External Equipment Display

F

- Favorite Items
- Fine Tuning

G

- GPS

H

- HDMI CEC
- HDMI Settings

- HDMI Device Selection
- HDMI Equipment

- High-Frame Rate
- HOME

I

- Info Banner
- Initial Settings
- Internet Settings

- Internet Video
- IP Address

K

- Key Tone

L

- Language Selection

- Lighting Environment

M

- Media Server Troubleshooting
- Motionflow Settings

- MTS
- My TV

N

- Network Diagnostics
- Network Settings

- Network Setup

O

- On Screen Manual

P

- Password
- PC connection
- Photo with Map
- Photo/Music/Video Playback
- Picture Adjustments Lock

- Picture Frame
- Picture Mode
- Picture Settings
- Power Saving
- Program Information Source

Q

- Quick Start

R

- Rating
- Recently Viewed Content
- Recommendation
- Recommendation Settings
- Region Selection
- Remote Control Buttons (Back Part)
- Remote Control Buttons (Bottom Part)

- Remote Control Buttons (Lower Part)
- Remote Control Buttons (Middle Part)
- Remote Control Buttons (Top Part)
- Remote Control Buttons (Upper Part)
- Renderer
- Renderer Settings
- Room Lighting Sensor

S

- Scene Selection
- Screen Off
- Screen Settings (for PC Input)
- Screen Settings (Other Than PC Input)
- Screen Types/Sizes
- Server List
- Settings Menu
- Show/Hide Channels
- Show/Hide Media Servers
- Signal Information
- Slideshow
- Software Update
- Sound Mode
- Sound Settings
- Speaker Settings
- SYNC MENU

T

- Terminals (Back)
- Terminals (Right)
- Thumbnail View
- Troubleshooting (Channel)
- Troubleshooting (General)
- Troubleshooting (Network Connection)
- Troubleshooting (Picture)
- Troubleshooting (Remote Control)
- Troubleshooting (Sound)
- TV Controls and Indicators (Front Part)
- TV Controls and Indicators (Right Part)
- TV Guide
- TV Guide On Screen®
- Two-Picture Display

U

- Update on Internet Content
- USB Auto Start
- USB Devices
- USB Wireless LAN Adapter

V

- VCR/DVD player (Connected Equipment)
- Video 1/Component 1
- Volume for Audio System

W

- Wireless LAN Connection (USB Adapter)
- Wireless LAN router (Internet Settings)
- WPS

X

- XMB (XrossMediaBar)

[▲ Return to Top](#)

"BRAVIA" TV Features

- [Motionflow](#)
- [Presence Sensor](#)
- [Ambient Sensor](#)
- ["BRAVIA" Internet Video](#)
- [Wireless LAN Ready](#)
- [Playback via USB](#)
- ["BRAVIA" Sync with Control for HDMI](#)
- [Favorites](#)

Watching TV

[▲ Return to Top](#)

- [TV Guide On Screen®](#)
- [Favorites](#)
- [Wide Mode](#)
- [Picture in Picture \(PIP\)](#)
- [Angle Adjustment \(Swivel\)](#)

Using the Home Menu

[▲ Return to Top](#)

About the Home Menu

-  [Product Support](#)
 - [i-Manual](#)
 - [Contact Sony](#)
 - [Signal Diagnostics](#)
 - [Automatic Software Update](#)

-  [Preferences](#)
 - [Scene Select](#)
 - [Eco](#)
 - [Clock/Timers](#)
 - [Language](#)
 - [Region](#)
 - [Closed Captions \(CC\)](#)
 - [Parental Lock](#)
 - [Info Banner](#)
 - [Home Menu Scrolling](#)
 - [Recommendation](#)
 - [Quick Start](#)
 - [Picture Adjustments Lock](#)
 - [Initial Setup](#)

-  [Picture & Display](#)

- Picture Adjustments
- Ambient Sensor
- Screen (for inputs other than a PC)
- Screen (for PC input)

 Sound

- Sound Adjustments
- MTS Audio
- Speakers
- Audio Out
- Key Tone

 Channels & Inputs

- Manage Inputs
- Cable/Antenna
- Auto Program
- Add Digital Channels
- Show/Hide Channels
- Edit Channel Labels
- Program Information Source
- Analog Fine Tune
- Video 1/Component 1 Selection
- HDMI Settings
- USB Auto Start

 Network

- Network Setup (Follow Wired Setup > Custom.)
- Refresh Internet Content
- Show/Hide Media Servers
- Media Server Troubleshooting
- Renderer

Fun Features with Connected Equipment

[▲ Return to Top](#)

- VCR/DVD Player
- Audio System
- Digital Still Camera
- HDMI Equipment
- Internet
 - Settings
 - “BRAVIA” Internet Video
 - Photomap
- Home Network
- PC

Parts Description

[▲ Return to Top](#)

- Remote Control
 - Top
 - Upper
 - Middle
 - Lower

[Bottom](#)

[Back](#)

TV Controls and Indicators

[Front](#)

[Right](#)

Terminals

[Back](#)

[Right](#)

Troubleshooting

[▲ Return to Top](#)

[Picture](#)

[Sound](#)

[Channels](#)

[Home Network](#)

[Remote Control](#)

[General](#)

[▲ Return to Top](#)

Copyright 2010 Sony Corporation

Trademark information

Macintosh is a trademark of Apple Inc., registered in the U.S. and other countries.

HDMI, the HDMI logo and High-Definition Multimedia Interface are trademarks or registered trademarks of HDMI Licensing, LLC.

Fergason Patent Properties, LLC:
U.S. Patent No. 5,717,422
U.S. Patent No. 6,816,141

Manufactured under license from Dolby Laboratories. Dolby and the double-D symbol are trademarks of Dolby Laboratories.

In the United States, TV Guide and TV Guide On Screen are registered trademarks of TV Guide Entertainment Group, Inc. and/or its subsidiaries or affiliates, and are used under a license by Gemstar-TV Guide International, Inc. and/or its subsidiaries. In Canada, TV Guide is a registered mark of Transcontinental Inc., and is used under a license by Gemstar-TV Guide International, Inc. and/or its subsidiaries.

The TV Guide On Screen system is manufactured under license from Gemstar-TV Guide International, Inc. and/or its subsidiaries.

The TV Guide On Screen system is protected by one or more of the following United States patents 6,498,895; 6,850,693; 6,396,546; 5,940,073; 6,239,794 to Gemstar-TV Guide International, Inc. and/or its subsidiaries.

Gemstar-TV Guide International, Inc. and/or its related affiliates are not in any way liable for the accuracy or availability of the program schedule information or other data in the TV Guide On Screen system and cannot guarantee service availability in your area. In no event shall Gemstar-TV Guide International, Inc. and/or its related affiliates be liable for any damages in connection with the accuracy or availability of the program schedule information or other data in the TV Guide On Screen system.

Blu-ray Disc is a trademark.

“BRAVIA” and **BRAVIA**, S-Force, Motionflow, BRAVIA Sync, and  are trademarks or registered marks of Sony Corporation.

“XMB™” and “xross media bar” are trademarks of Sony Corporation and Sony Computer Entertainment Inc.

“PlayStation” is a registered trademark and “PS3” is a trademark of Sony Computer Entertainment Inc.

DLNA®, the DLNA Logo and DLNA CERTIFIED® are trademarks, service marks, or certification marks of the Digital Living Network Alliance.

“FACE DETECTION” logo is trademark of Sony Corporation.



- Applicable trademark information depends on your TV model/region/country.

[▲ Return to Top](#)

Copyright 2010 Sony Corporation

"BRAVIA" TV Features

Watching TV

Using the Home Menu

Fun Features with
Connected Equipment

Parts Description

Troubleshooting

Index

[→ i-Manual online map](#)

Motionflow



Enhances the smoothness of picture movement and reduces blur.

"Motionflow" is a proprietary technology that displays TV broadcasts at outstandingly a high-frame rate. By displaying pictures at higher frame rate than standard, Motionflow reduces motion artifacts in high-speed sports footage for smooth, natural motion reproduction.

Press HOME, then select  > Picture & Display > Picture Adjustments > Motionflow > the desired option.

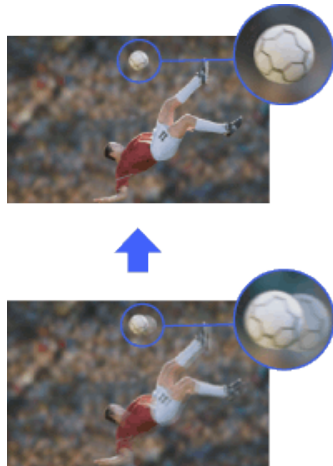

[▲ Return to Top](#)

"BRAVIA" TV Features

Watching TV

Using the Home Menu

Fun Features with
Connected Equipment

Parts Description

Troubleshooting

Index

→ i-Manual online map

Presence Sensor

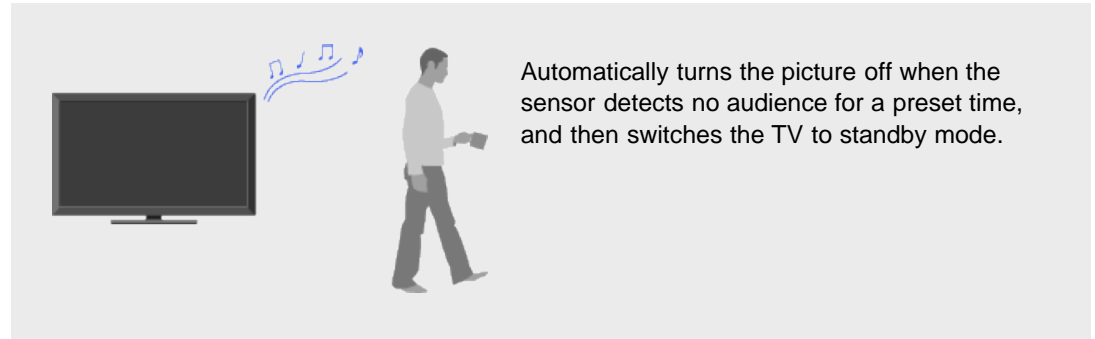

"Presence Sensor" is an audience monitoring function. When the sensor detects no audience in front of the TV for a certain period of time, it turns the picture off automatically, while leaving the TV sound on. Additionally, if no presence is detected after 30 minutes in picture off mode, the TV will switch to standby mode.

Press HOME, then select > Preferences > Eco > Presence Sensor > the desired option.

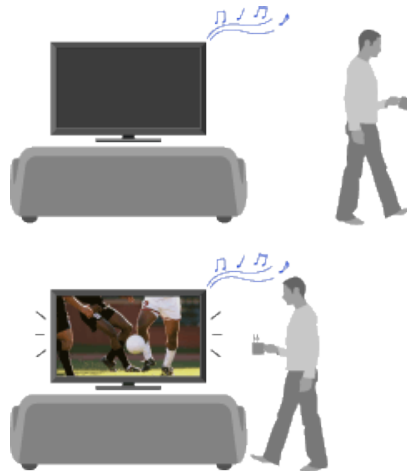

Presence Sensor Detection Range

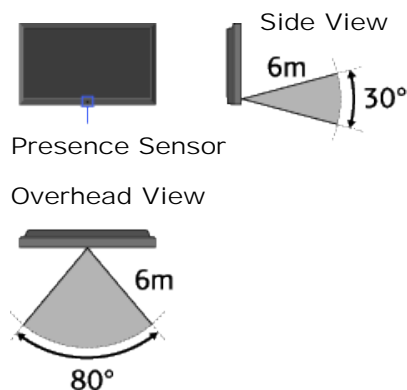



- Sensor detection range illustrated in the figure is based on normal room conditions.
- Even if a person is in front of the TV, the sensor may not detect anything if the person does not move.
- The sensor may not work when the ambient temperature changes due to air conditioning, etc.
- The sensor is sensitive to movement from side to side and up and down. Less sensitivity to the viewer's forward or backward movement may be apparent.
- Sensor detection range may vary depending on the TV's location, room temperature and lighting conditions.

[▲ Return to Top](#)

"BRAVIA" TV Features

Watching TV

Using the Home Menu

Fun Features with
Connected Equipment

Parts Description

Troubleshooting

Index

[→ i-Manual online map](#)

Ambient Sensor

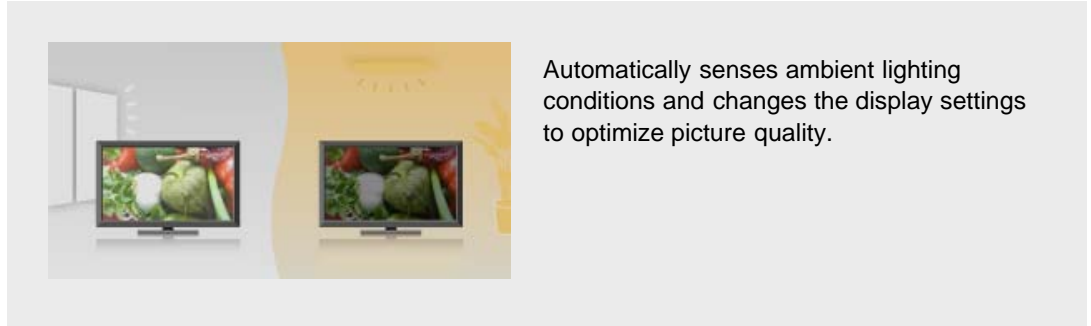

Automatically senses ambient lighting conditions and changes the display settings to optimize picture quality.

"Ambient Sensor" automatically optimizes the picture settings according to the ambient light in the room. The sensor detects ambient light levels to adjust the brightness and color temperature of the picture. With this feature you can have the best picture quality under your room's lighting conditions.

Press HOME, then select  > Picture & Display > Ambient Sensor > On.

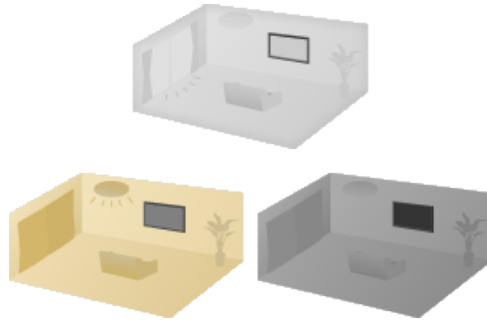

[▲ Return to Top](#)

"BRAVIA" TV Features

Watching TV

Using the Home Menu

Fun Features with
Connected Equipment

Parts Description

Troubleshooting

Index

→ i-Manual online map

"BRAVIA" Internet Video



Brings videos, movies and much more through the broadband Internet connection to your TV.

"BRAVIA" Internet Video serves as a gateway to Internet content, delivering a variety of on-demand entertainment straight to your TV. By making a broadband Internet connection, you can enjoy video content, including movies and cartoons.

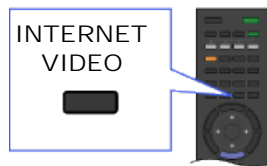

- Be sure to connect your TV to the broadband Internet and complete the initial setup and "Network Setup."

Selecting the "BRAVIA" Internet Video

Highlight the video icon you want to watch by using the remote control, then press \odot to make a selection.

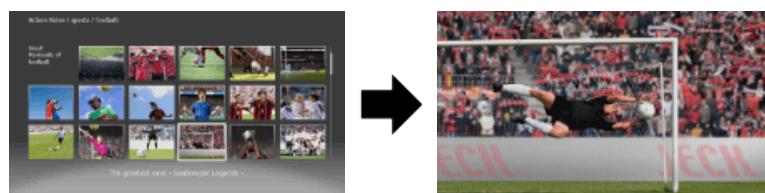

- Information about the highlighted icon appears in the information banner.



- The interface to Internet content depends on the Internet content providers.
- Services block video content based on the “Parental Lock” setting of the TV. Some service providers do not support this function.
- To update “BRAVIA” Internet Video content services, press HOME, then select  > Network > Refresh Internet Content.

Using the Internet Video

You can seek forward or seek backward in the video content. (This feature is available depending on Internet content services.)



Press the corresponding buttons on your remote control.

[▲ Return to Top](#)

| |
|---------------------------------------|
| "BRAVIA" TV Features |
| Watching TV |
| Using the Home Menu |
| Fun Features with Connected Equipment |
| Parts Description |
| Troubleshooting |
| Index |

[→ i-Manual online map](#)

Wireless LAN Ready



Wireless LAN Ready lets you easily access the Internet and your home network with the USB Wireless LAN Adapter UWA-BR100 (as of January 2010). By inserting the USB Wireless LAN Adapter into your TV's USB port, you can easily create a cable-free network.

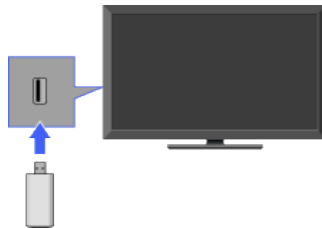

- Before setting up the wireless LAN function of the TV, be sure to set up a wireless LAN router.
- The USB Wireless LAN Adapter is supplied or available as an optional accessory, depending on your TV model. In some regions/countries, the USB Wireless LAN Adapter may not be available.

Connecting to Your Wireless LAN

Using the Wireless LAN Ready feature you can connect the TV to your wireless LAN. The setup procedure differs depending on the type of wireless LAN and wireless LAN router.

Before setting up a wireless LAN, check your wireless LAN environment using the following chart.

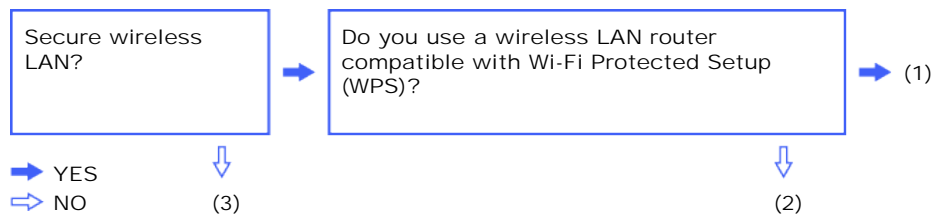

- (1) ➔ Follow the configuration for "Network Setup" and "Secured Network with Wi-Fi Protected Setup (WPS)."
- (2) ➔ Follow the configuration for "Network Setup" and "Secured Network without Wi-Fi Protected Setup (WPS)."
- (3) ➔ Follow the configuration for "Network Setup" and "Unsecured Network with Any Type of Wireless LAN Router."

Network Setup

"Network Setup" helps you configure network settings with the settings wizard. Follow the instructions on the screen.

Press HOME, then select  > Network > Network Setup.

The start-up screen allows you to select a setting procedure according to your network environment.

“View Network Status”: Select to confirm your network status.

“Wired Setup”: Use to connect to a wired network.

“Wireless Setup”: Use to connect to a wireless network.

Secured Network with Wi-Fi Protected Setup (WPS)

The WPS standard makes setup of a secure wireless home network as simple as pressing the WPS button on the wireless LAN router. Before setting up a wireless LAN, check the location of the WPS button on the router and verify how to use it.

1. Select “Wireless Setup” from the “Network Setup” start-up screen.
2. Select “WPS (Push Button)” for Push Button method or “WPS (PIN)” for PIN method.
3. Follow the instructions that appear on the setup screen.



- To connect to a wireless LAN with WPS, your wireless LAN router needs to support the WPS standard.

Secured Network without Wi-Fi Protected Setup (WPS)

For setting up a wireless LAN, SSID (wireless network name) and security key (WEP or WPA key) will be required. If you do not know them, consult the instruction manual of your router.

1. Select “Wireless Setup” from the “Network Setup” start-up screen.
2. Select “Scan,” then select a network from the list of scanned wireless networks.
3. Follow the instructions that appear on the setup screen.

Unsecured Network with Any Type of Wireless LAN Router

For setting up a wireless LAN, SSID (wireless network name) will be required. Security key (WEP or WPA key) will not be required because you need to select no security method in this procedure.

1. Select “Wireless Setup” from the “Network Setup” start-up screen.
2. Select “Scan,” then select a network from the list of scanned wireless networks.
3. Follow the instructions that appear on the setup screen.

[▲ Return to Top](#)

"BRAVIA" TV Features

Watching TV

Using the Home Menu

Fun Features with
Connected Equipment

Parts Description

Troubleshooting

Index

[→ i-Manual online map](#)

Playback via USB

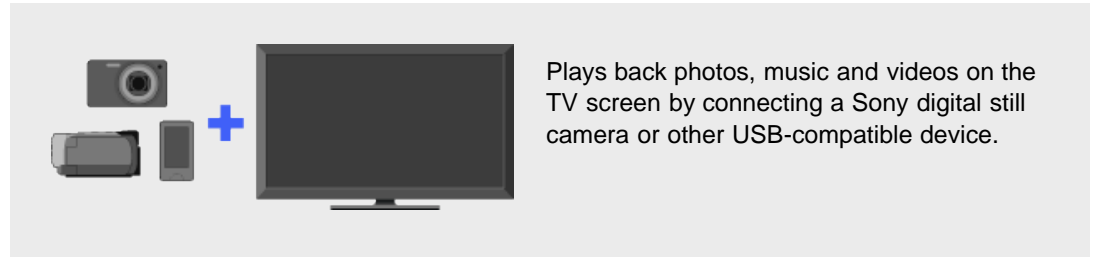

You can enjoy photo, music and video files stored in a Sony digital still camera, camcorder or USB storage device by connecting the device via a USB cable.

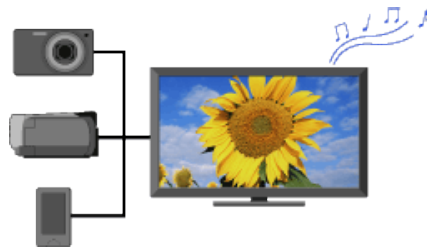

- Photo playback automatically starts when you connect a USB storage device after turning on the TV, and "Slideshow" or "Thumbnail View" is selected in the "USB Auto Start" settings.
- When connecting a Sony digital camera to the TV with a USB cable, USB connection settings on your camera need to be set to "Auto" or "Mass Storage" mode.
- Files from a USB device need to be compatible with the following file formats.
 - Still images: JPEG format or RAW format (preview only)
 - Music: MP3 format
 - Video: AVCHD, MP4 (AVC) or MPEG1 format (not playable in some cases)
- Video files are located in the following folder structure (hierarchical position):
 /AVCHD/BDMV/STREAM/00000.MTS/PRIVATE/AVCHD/BDMV/STREAM/00000.MTS
 /MP_ROOT/100ANV01/MAHA0001.MP4
- Avoid losing your files by backing up all your media files stored on a USB device. Sony cannot accept responsibility for lost or damaged data stored on a USB device.
- Check the website below for updated information about compatible USB devices.
<http://sony.com/tvsupport>
 For Canadian models
<http://sony.ca/support>

Picture Frame – Displaying a Photograph

"Picture Frame" displays a photo for a selected period of time. You can select a photo from the connected USB device or preset picture folder.

1. While the desired photo is displayed, press OPTIONS, then select File Actions > Picture Frame.
2. Press HOME, then select  > Picture Frame.

[▲ Return to Top](#)

"BRAVIA" TV Features

Watching TV

Using the Home Menu

Fun Features with
Connected Equipment

Parts Description

Troubleshooting

Index

[→ i-Manual online map](#)

"BRAVIA" Sync with Control for HDMI

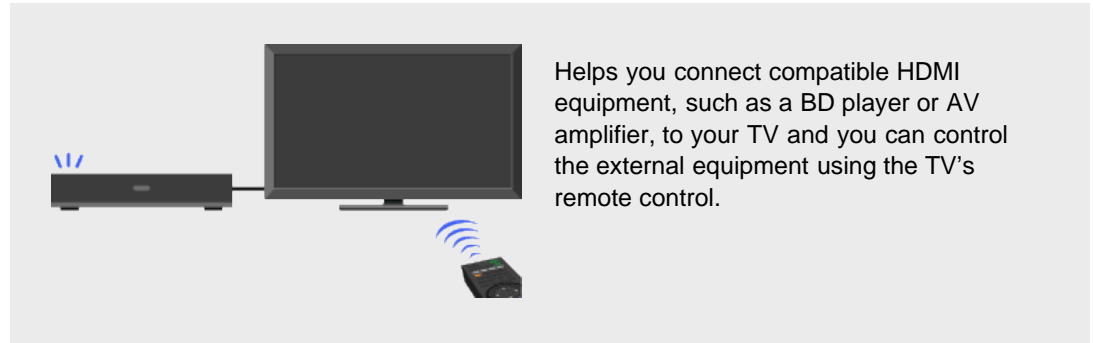

Helps you connect compatible HDMI equipment, such as a BD player or AV amplifier, to your TV and you can control the external equipment using the TV's remote control.

With the "Control for HDMI" function, "BRAVIA" Sync helps to communicate with "BRAVIA" Sync-compatible equipment using HDMI CEC (Consumer Electronics Control). Use the following settings and tips to help unify control of your connected equipment.

Press HOME, then select > Channels & Inputs > HDMI Settings > Control for HDMI > On.



- "Control for HDMI" ("BRAVIA" Sync) is only available for the connected Sony equipment that has the "BRAVIA" Sync logo or is compatible with "Control for HDMI."
- The "Control for HDMI" settings must be set on both the TV and connected equipment. For settings on the connected equipment, refer to their instruction manuals.
- When specific Sony equipment compatible with "Control for HDMI" ("BRAVIA" Sync) is connected, "BRAVIA" sync is automatically activated on the equipment.

Controlling "BRAVIA" Sync-Compatible Equipment

"BRAVIA" Sync-compatible equipment is listed as a new input source under (External Inputs) in the Home Menu. To control the equipment by using the remote control, press SYNC MENU and select the desired equipment from "HDMI Device Selection."

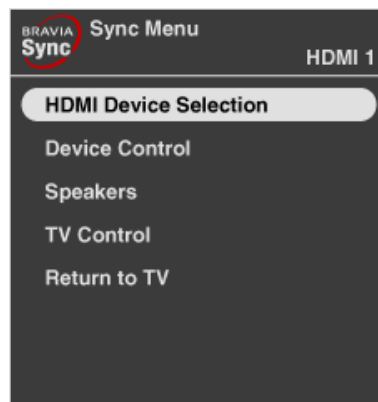

BD/DVD Player

- Automatically turns the "BRAVIA" Sync-compatible equipment on and switches the input to that equipment when you select it from the Home Menu or Sync Menu.
- Automatically turns the TV on and switches the input to the connected equipment when the equipment starts to play.
- Automatically turns the connected equipment off when you switch the TV to standby mode.

AV Amplifier

- Automatically turns the connected AV amplifier on and switches the sound output from the TV speaker to the audio system when you turn the TV on. This function is only available if you have previously used the AV amplifier to output TV sound.
- Automatically switches the sound output to the AV amplifier by turning the AV amplifier on when the TV is turned on.
- Automatically turns the connected AV amplifier off when you switch the TV to standby mode.
- Adjusts the volume (VOL +/-) and mutes the sound (MUTING) of the connected AV amplifier through the TV's remote control.



- When connecting a digital audio system that is compatible with Audio Return Channel (ARC) technology, connect to HDMI IN 1 with an HDMI cable. If connecting a system that is incompatible with "Control for HDMI" or Audio Return Channel, an additional audio connection via DIGITAL AUDIO OUT (OPTICAL) is necessary.

Video Camera

- Automatically turns the TV on and switches the input to the connected video camera when the connected video camera is turned on.
- Automatically turns the connected video camera off when you switch the TV to standby mode.

[▲ Return to Top](#)

"BRAVIA" TV Features

Watching TV

Using the Home Menu

Fun Features with
Connected Equipment

Parts Description

Troubleshooting

Index

→ i-Manual online map

Favorites



Manages your preferred TV channels, photos, music, video content and external inputs for quick and easy access.

The "Favorites" feature provides quick access to your frequently used items, such as preferred TV channels or external inputs (e.g. game console, DVD player). In addition, your favorite media files, Internet content and Widgets can be shown in the "Favorites" screen.

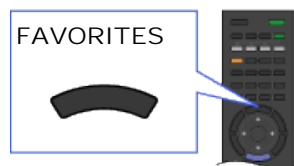

- Internet content (e.g. Internet Video, Internet Widgets) may not be available in some regions/countries.

Displaying Your Favorites

Select the desired icon listed at the bottom of the screen by using the remote control, and press to expand it into a full view.

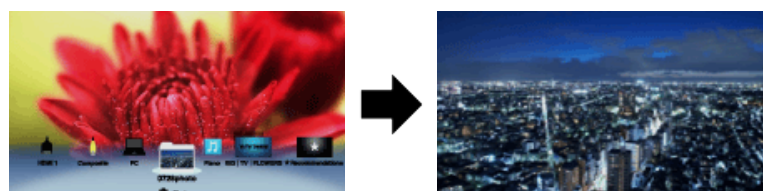

- Items in your "Favorites" are displayed as icons.



- A slideshow automatically starts when a folder of photos is selected.

Displaying Your Recently Viewed Items

By selecting the “Recently Viewed” stack of items in the “Favorites” screen, you can display a history of content you have recently viewed. The “Recently Viewed” list is erased whenever the TV is powered off.



- “Recently Viewed” items are displayed in a stack list. Press / to move between the items.

Recommendations

The “Recommendations” feature automatically analyzes your interests by referencing your viewing history to find programs and items you may like, and presents them in the “Favorites” menu.

Press HOME, then select > Preferences > Recommendation > On.



- The “Recommendations” feature may not be available depending on your region, country and broadcasting conditions.

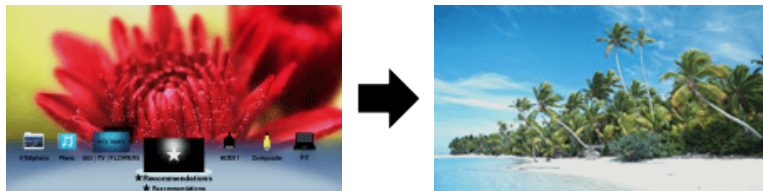

- Recommended programs that are currently being broadcast are displayed in a stack list of items. Press to expand the selected item into a full view.

Adding/Removing Favorites

You can add/remove your favorite items through the “XMB” or while you are displaying content on the screen.

1. Press OPTIONS after selecting the desired item on the “XMB.”
2. Select “Add to Favorites” or “Remove from Favorites.”

[▲ Return to Top](#)

"BRAVIA" TV Features

Watching TV

Using the Home Menu

Fun Features with
Connected Equipment

Parts Description

Troubleshooting

Index

→ i-Manual online map

TV Guide On Screen®



Provides program information for up to two days. With easy-to-use functions, you can personalize the program listings.

TV Guide On Screen provides up to two days of program information and customizes the program listings to your preference. With this feature, you can search for programs by categories and keywords as well as customize your favorite channels or favorite keywords.



- To change the information source for program information (to Broadcaster or to TV Guide), press HOME and select  > Channels & Inputs > Program Information Source > the desired setting.
- When "Broadcaster" is selected for the source of program information, the TV will not display a program guide, but each individual program will have program information shown onscreen when the channel is tuned.



- TV Guide is available with connection to your cable service or with over-the-air antenna signal.
- You must connect your signal directly to the TV's CABLE or ANTENNA input without using a cable box.
- Be sure to complete the initial setup to use this feature.
- DAM (Download Acquisition Mode) is used for software updates and/or collecting data for TV Guide. When DAM is activated, power consumption may increase.



1 TV Guide Menu Area

Select from the following features:

- “TV Listings”: Up to 24 hours of program listings are available. You can also organize the program listings by categories.
- “Browse/Search”: Search for programs by browsing through categories or by entering a keyword or title.
- “Ads”: Provides advertisements from TV Guide sponsors.
- “Settings”: Adjust the settings for the TV Guide.
- “My TV”: Allows you to organize the program listings.

2 Video Preview Window

Displays the last viewed program before you entered the guide. You can also set this to preview the program that is selected within the TV Guide listings.

3 Information Box

Shows program information in details.

4 Listings Grid

Select a program to watch or to obtain program information.

5 Channel logo

Display the broadcaster’s channel logo.

6 Ad panels

Provides advertisements from TV Guide sponsors.

Using the My TV Feature

The “My TV” feature allows you to organize the program listings by profiles such as Movie, Sport or Kids. You can also create your own profile to organize your favorite programs, channels or keywords.



- Select “My TV” from the menu area to launch the “My TV” screen.
- Channels you add to the main profile of “My TV” will automatically appear as your favorite channels in “Favorites.”

[▲ Return to Top](#)

"BRAVIA" TV Features

Watching TV

Using the Home Menu

Fun Features with
Connected Equipment

Parts Description

Troubleshooting

Index

[→ i-Manual online map](#)

Favorites



Manages your preferred TV channels, photos, music, video content and external inputs for quick and easy access.

The "Favorites" feature provides quick access to your frequently used items, such as preferred TV channels or external inputs (e.g. game console, DVD player). In addition, your favorite media files, Internet content and Widgets can be shown in the "Favorites" screen.

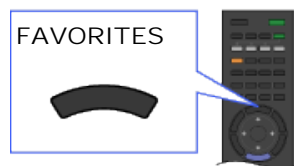

- Internet content (e.g. Internet Video, Internet Widgets) may not be available in some regions/countries.

Displaying Your Favorites

Select the desired icon listed at the bottom of the screen by using the remote control, and press to expand it into a full view.



- Items in your "Favorites" are displayed as icons.



- A slideshow automatically starts when a folder of photos is selected.

Displaying Your Recently Viewed Items

By selecting the “Recently Viewed” stack of items in the “Favorites” screen, you can display a history of content you have recently viewed. The “Recently Viewed” list is erased whenever the TV is powered off.



- “Recently Viewed” items are displayed in a stack list. Press / to move between the items.

Recommendations

The “Recommendations” feature automatically analyzes your interests by referencing your viewing history to find programs and items you may like, and presents them in the “Favorites” menu.

Press HOME, then select > Preferences > Recommendation > On.



- The “Recommendations” feature may not be available depending on your region, country and broadcasting conditions.

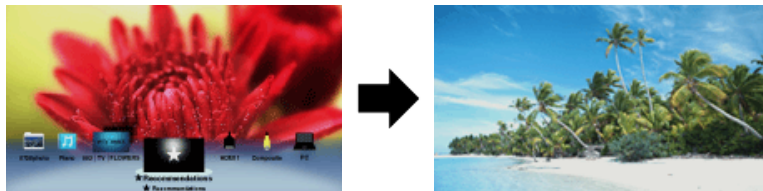

- Recommended programs that are currently being broadcast are displayed in a stack list of items. Press to expand the selected item into a full view.

Adding/Removing Favorites

You can add/remove your favorite items through the “XMB” or while you are displaying content on the screen.

1. Press OPTIONS after selecting the desired item on the “XMB.”
2. Select “Add to Favorites” or “Remove from Favorites.”

[▲ Return to Top](#)

- "BRAVIA" TV Features
- Watching TV
- Using the Home Menu
- Fun Features with Connected Equipment
- Parts Description
- Troubleshooting
- Index

[→ i-Manual online map](#)

Wide Mode

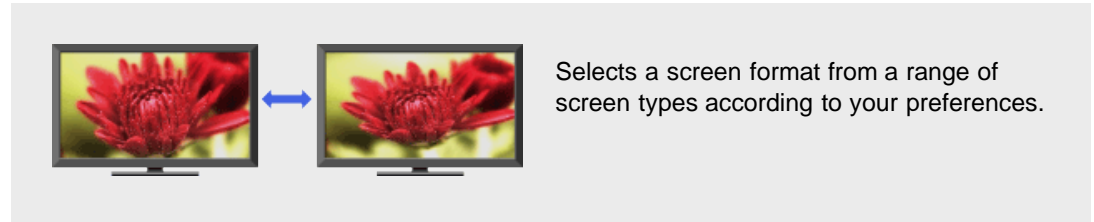

"Wide Mode" allows you to select a screen format to better fit content you are viewing. Based on the original signal source, a black frame or black bars may surround the picture.

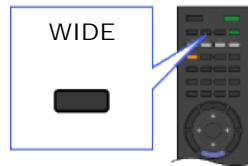
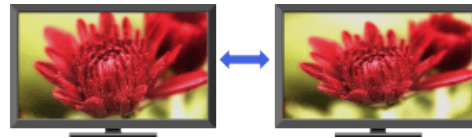

Changing the Wide Mode from 4:3 Original Source

| | | |
|--|------------------|--|
| | Wide Zoom | Enlarges the picture to fill a 16:9 screen, preserving the original picture as much as possible. |
| | Normal | Displays a 4:3 picture in its original size. Side bars are shown to fill the 16:9 screen. |
| | Full | Stretches the 4:3 picture horizontally, to fill the 16:9 screen. |
| | Zoom | Displays the cinemascopic (letter box format) picture in the correct proportion. |

Changing the Wide Mode from 16:9 Original Source

| | | |
|--|------------------|--|
| | Wide Zoom | Enlarges the picture to fill a 16:9 screen, preserving the original picture as much as possible. |
| | Full | Displays a 16:9 picture in its original size. |

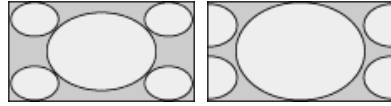
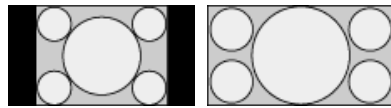

H Stretch* Stretches the picture horizontally keeping the vertical size in its original. This is only available with 720p, 1080i, 1080p and 1080/24p sources.

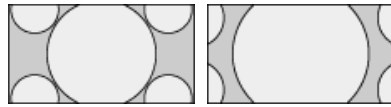

Zoom Displays the cinemascopic (letter box format) picture in the correct proportion.

* This Wide Mode is only available depending on your TV model/region/country.

Changing the Wide Screen Mode for PC Timing

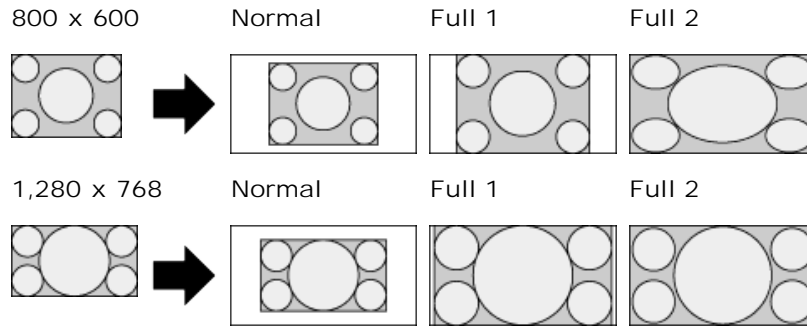

[▲ Return to Top](#)

"BRAVIA" TV Features

Watching TV

Using the Home Menu

Fun Features with
Connected Equipment

Parts Description

Troubleshooting

Index

[→ i-Manual online map](#)

Picture in Picture (PIP)

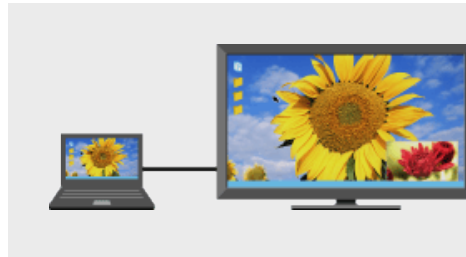

Displays two pictures (PC input and TV program/composite video) on the screen simultaneously.

"PIP" displays a picture from the connected PC in the full screen, and a TV program or composite video in an inset window. This feature is available when a PC is connected with an HDMI cable. Available inputs may vary depending on the TV model.

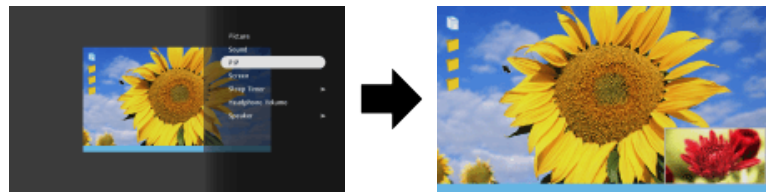

1. Press **OPTIONS** and select the "PIP" from the **OPTIONS** Menu.
2. Use the **OPTIONS** Menu to switch audio output between the two pictures.

[▲ Return to Top](#)

"BRAVIA" TV Features

Watching TV

Using the Home Menu

Fun Features with
Connected Equipment

Parts Description

Troubleshooting

Index

[→ i-Manual online map](#)

Angle Adjustment (Swivel)

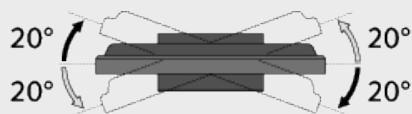

Adjust the viewing angle left and right as shown in the illustration.

Adjust the viewing angle left and right as shown in the illustration.

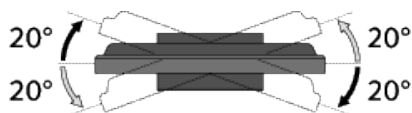

- Swivel is available depending on the TV size.
- When adjusting the angle, hold the stand with one hand to avoid having the stand slip or tip over.

[▲ Return to Top](#)

"BRAVIA" TV Features

Watching TV

Using the Home Menu

Fun Features with
Connected Equipment

Parts Description

Troubleshooting

Index

→ i-Manual online map

About the Home Menu



The Home Menu of the "XMB" (XrossMediaBar) provides quick access to program listings, input sources, the settings menu of your TV and more.

With the Home Menu ("XMB"), you can customize your TV settings. The Home Menu also provides you access to TV channels, media files (e.g. photos, music, videos), "BRAVIA" Internet Widgets, and external input sources.



Select a category from the Media Category Bar using the \leftarrow/\rightarrow buttons.
Select an item from the Category Object Bar using the \uparrow/\downarrow buttons.

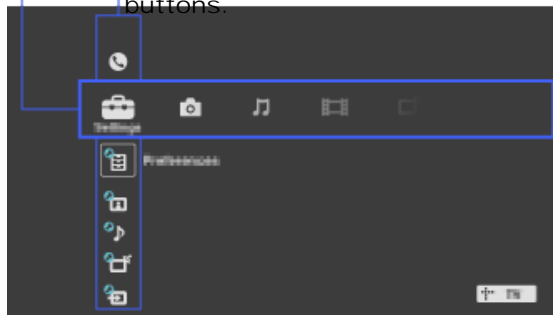

Media Category Bar

The category icons organize your TV settings and TV features for quick and easy access.

Settings

Contains all of the necessary configurations to customize your TV



settings.



Photo

Enjoy photo content via USB devices or your home network, including Internet content services.



Music

Enjoy music content via USB devices or your home network, including Internet content services.



Video

Enjoy video content via USB devices or your home network, including Internet content services.



TV

Select a channel or display the TV Guide.



- TV Guide is available depending on your region.



External Inputs

Select equipment connected to the TV.



Network

Enjoy "BRAVIA" Internet Widgets. You can access the "Widget Gallery" and downloaded Widgets. ("BRAVIA" Internet Widgets is available depending on your region/country.)



Qriocity

Access "Qriocity" online service.



- This function is available depending on your region.



- The options you can select may vary depending on the situation.
- Unavailable options are grayed out or not displayed.

[▲ Return to Top](#)

"BRAVIA" TV Features

Watching TV

Using the Home Menu

Fun Features with
Connected Equipment

Parts Description

Troubleshooting

Index

[→ i-Manual online map](#)

? Product Support

[i-Manual](#)

[Contact Sony](#)

[Signal Diagnostics](#)

[Automatic Software Update](#)

[▲ Return to Top](#)

"BRAVIA" TV Features

Watching TV

Using the Home Menu

Fun Features with
Connected Equipment

Parts Description

Troubleshooting

Index

[→ i-Manual online map](#)

Preferences

[Scene Select](#)

[Eco](#)

[Clock/Timers](#)

[Language](#)

[Region](#)

[Closed Captions \(CC\)](#)

[Parental Lock](#)

[Info Banner](#)

[Home Menu Scrolling](#)

[Recommendation](#)

[Quick Start](#)

[Picture Adjustments Lock](#)

[Initial Setup](#)

[▲ Return to Top](#)

"BRAVIA" TV Features

Watching TV

Using the Home Menu

Fun Features with
Connected Equipment

Parts Description

Troubleshooting

Index

[→ i-Manual online map](#)

Picture & Display

[Picture Adjustments](#)

[Ambient Sensor](#)

[Screen \(for inputs other than a PC\)](#)

[Screen \(for PC input\)](#)

[▲ Return to Top](#)

"BRAVIA" TV Features

Watching TV

Using the Home Menu

Fun Features with
Connected Equipment

Parts Description

Troubleshooting

Index

[→ i-Manual online map](#)

Sound

[Sound Adjustments](#)

[MTS Audio](#)

[Speakers](#)

[Audio Out](#)

[Key Tone](#)

[▲ Return to Top](#)

"BRAVIA" TV Features

Watching TV

Using the Home Menu

Fun Features with
Connected Equipment

Parts Description

Troubleshooting

Index

[→ i-Manual online map](#)

Channels & Inputs

[Manage Inputs](#)

[Cable/Antenna](#)

[Auto Program](#)

[Add Digital Channels](#)

[Show/Hide Channels](#)

[Edit Channel Labels](#)

[Program Information Source](#)

[Analog Fine Tune](#)

[Video 1/Component 1 Selection](#)

[HDMI Settings](#)

[USB Auto Start](#)

[▲ Return to Top](#)

"BRAVIA" TV Features

Watching TV

Using the Home Menu

Fun Features with
Connected Equipment

Parts Description

Troubleshooting

Index

[→ i-Manual online map](#)

Network

[Network Setup \(Follow Wired Setup > Custom.\)](#)

[Refresh Internet Content](#)

[Show/Hide Media Servers](#)

[Media Server Troubleshooting](#)

[Renderer](#)

[▲ Return to Top](#)

- "BRAVIA" TV Features
- Watching TV
- Using the Home Menu
- Fun Features with Connected Equipment
- Parts Description
- Troubleshooting
- Index

[→ i-Manual online map](#)

VCR/DVD Player

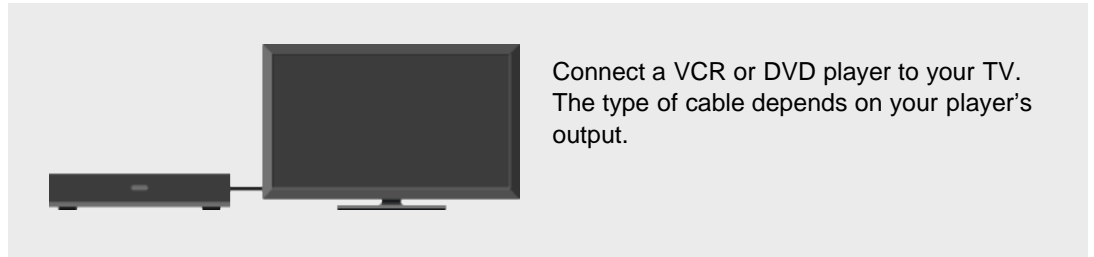

VCR/DVD Player with HDMI Connection

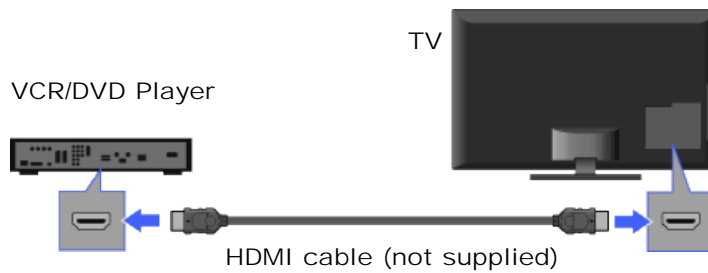

- HDMI connection is recommended for optimum picture quality.

VCR/DVD Player with Component Video Connection

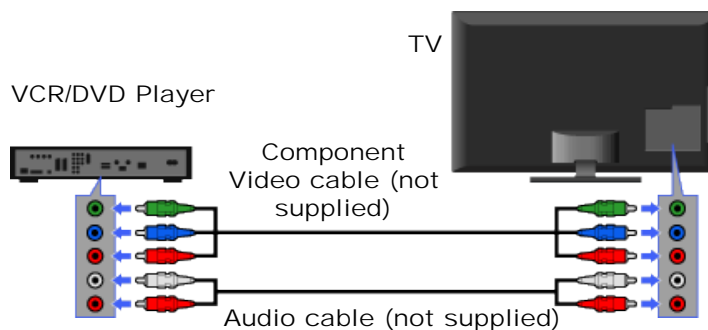

VCR/DVD Player with Composite Connection

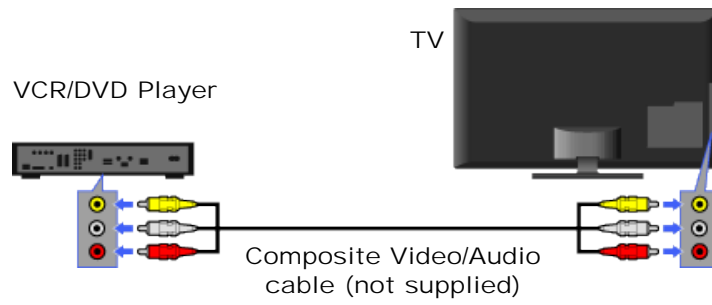

Viewing Pictures from Connected Equipment



1. Turn on the connected equipment.
2. Press INPUT and select the desired input source.

[▲ Return to Top](#)

| |
|--|
| "BRAVIA" TV Features |
| Watching TV |
| Using the Home Menu |
| Fun Features with Connected Equipment |
| Parts Description |
| Troubleshooting |
| Index |

[→ i-Manual online map](#)

Audio System

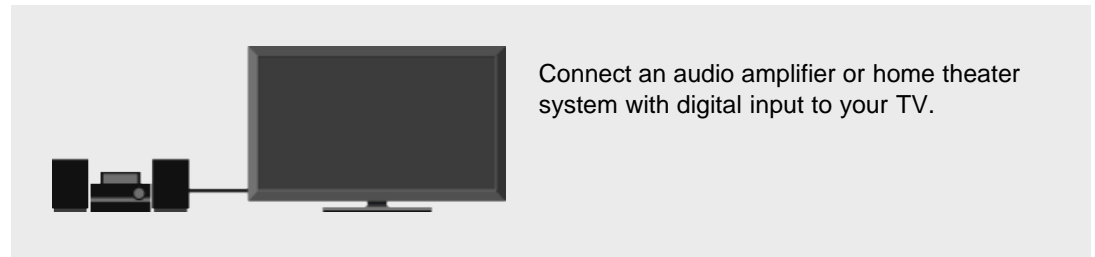

Audio System with Optical Audio Cable

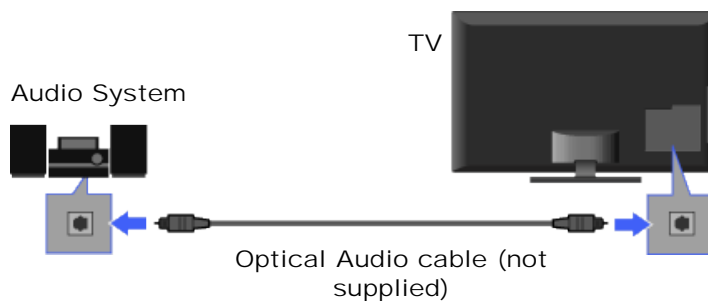

Audio System with HDMI Cable

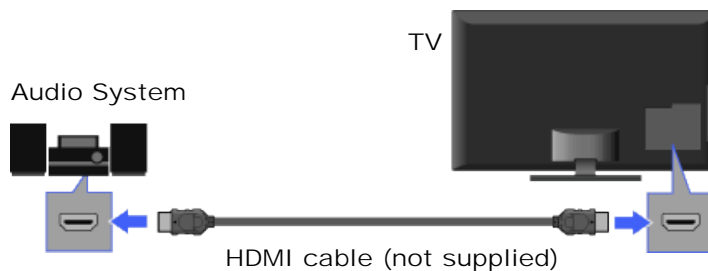

- When connecting a digital audio system that is compatible with "Control for HDMI" ("BRAVIA" Sync) and Audio Return Channel (ARC) technology, connect to HDMI IN 1 with an HDMI cable. If connecting a system that is incompatible with "Control for HDMI" or Audio Return Channel, an additional audio connection via DIGITAL AUDIO OUT (OPTICAL) is necessary.

Audio System with Audio Cable

TV

Audio System

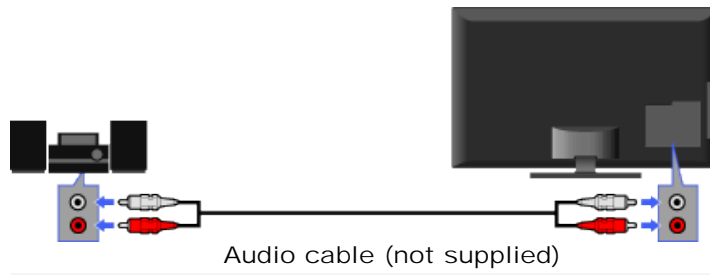

- When using an external audio system, audio out of the TV can be controlled using the TV's remote control.

[▲ Return to Top](#)

| |
|--|
| "BRAVIA" TV Features |
| Watching TV |
| Using the Home Menu |
| Fun Features with Connected Equipment |
| Parts Description |
| Troubleshooting |
| Index |

[→ i-Manual online map](#)

Digital Still Camera

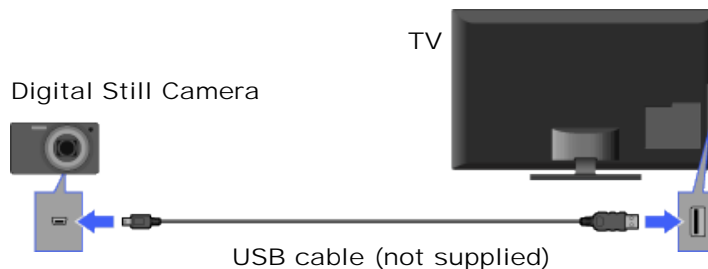
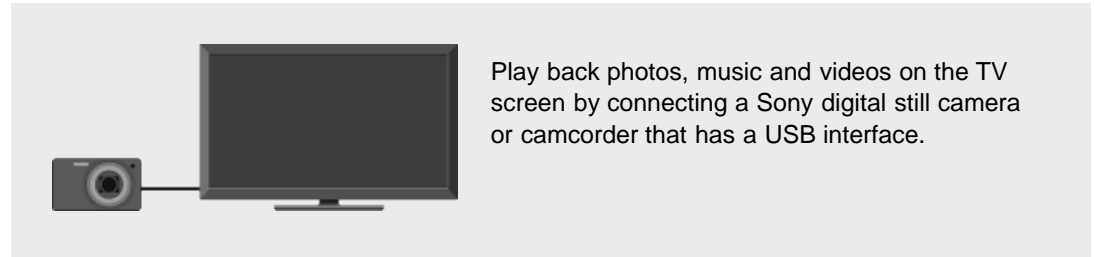

- Photo playback automatically starts when you connect a USB storage device after turning on the TV, and "Slideshow" or "Thumbnail View" is selected in the "USB Auto Start" settings.
- When connecting a Sony digital camera to the TV with a USB cable, USB connection settings on your camera need to be set to "Auto" or "Mass Storage" mode.

Photo/Music/Video Playback

Enjoy photo/music/video files stored in a Sony digital still camera or camcorder through a USB cable, or USB storage media.

1. Press HOME and select the listed USB devices under the "Photo," "Music" or "Video" category.
2. Select files or folders to play from the list on the selected USB device.



- USB Photo Viewer supports FAT12, FAT16 and FAT32 file systems.
- USB playback of the following photo file formats is available:
 - JPEG (JPEG format files with the extension ".jpg" and conforming to DCF or Exif)
 - RAW (ARW/ARW 2.0 format files with the extension ".arw") (For preview only.)
- USB playback is supported for the following music file format:
 - MP3 (files with the extension ".mp3" that have not been copyrighted)
- USB playback is supported for the following video file format:
 - AVCHD (files with the extension ".mts" or ".m2ts")
 - MP4 (AVC) (files with the extension ".mp4")

- MPEG1 (files with the extension “.mpg”)

- Avoid losing your files by backing up all your media files stored on a USB device. Sony cannot accept responsibility for lost or damaged data stored on a USB device.

Picture Frame – Displaying a Photograph

“Picture Frame” displays a photo for a selected period of time. You can select a photo from the connected USB device or preset picture folder.

1. While the desired photo is displayed, press **OPTIONS**, then select **File Actions > Picture Frame**.
2. Press **HOME**, then select  **> Picture Frame**.

[▲ Return to Top](#)

"BRAVIA" TV Features

Watching TV

Using the Home Menu

Fun Features with
Connected Equipment

Parts Description

Troubleshooting

Index

→ i-Manual online map

HDMI Equipment

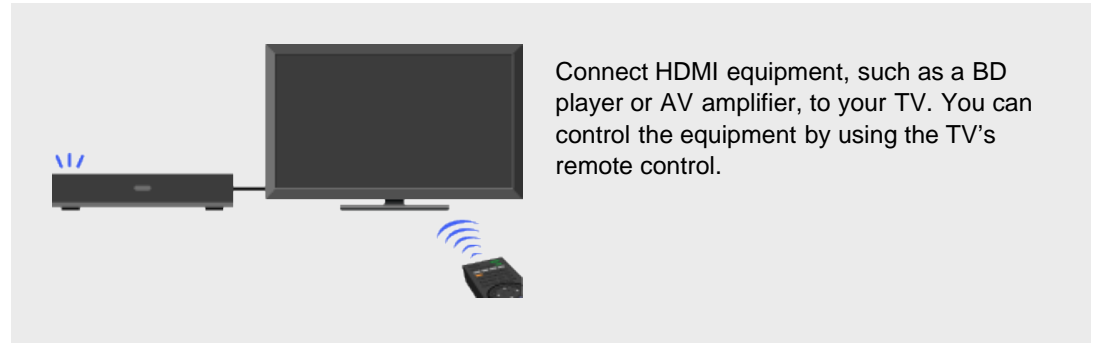

HDMI (High-Definition Multimedia Interface) Equipment

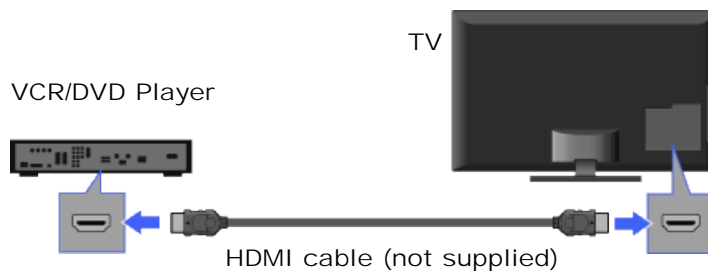

Viewing Pictures from Connected HDMI Equipment

HDMI is an uncompressed all-digital audio/video interface between the TV and any HDMI-compatible A/V equipment. In addition, if you connect equipment that is compatible with "Control for HDMI," you can control it by simply using the TV's remote control.



1. Turn on the connected equipment.
2. Press INPUT and select the desired input source.



- Be sure to use an authorized HDMI cable bearing the HDMI logo.
- If the equipment has a DVI jack, connect it to the HDMI (with AUDIO IN) port through a DVI - HDMI adapter interface (not supplied), and connect the equipment's audio out jacks to the AUDIO IN on the HDMI (with AUDIO IN) port.

Using "BRAVIA" Sync with Control for HDMI

With the "Control for HDMI" function, "BRAVIA" Sync helps to communicate with "BRAVIA" Sync-compatible equipment using HDMI CEC (Consumer Electronics Control). Use the following settings and tips to help unify control of your connected equipment.

Press HOME, then select  > Channels & Inputs > HDMI Settings > Control for HDMI > On.



- "Control for HDMI" ("BRAVIA" Sync) is only available for the connected Sony equipment that has the "BRAVIA" Sync logo or is compatible with "Control for HDMI."
- The "Control for HDMI" settings must be set on both the TV and connected equipment. For settings on the connected equipment, refer to their instruction manuals.
- When specific Sony equipment compatible with "Control for HDMI" ("BRAVIA" Sync) is connected, "BRAVIA" sync is automatically activated on the equipment.

Controlling "BRAVIA" Sync-Compatible Equipment

"BRAVIA" Sync-compatible equipment is listed as a new input source under  (External Inputs) in the Home Menu. To control the equipment by using the remote control, press SYNC MENU and select the desired equipment from "HDMI Device Selection."



BD/DVD Player

- Automatically turns the "BRAVIA" Sync-compatible equipment on and switches the input to that equipment when you select it from the Home Menu or Sync Menu.
- Automatically turns the TV on and switches the input to the connected equipment when the equipment starts to play.
- Automatically turns the connected equipment off when you switch the TV to standby mode.

AV Amplifier

- Automatically turns the connected AV amplifier on and switches the sound output from the TV speaker to the audio system when you turn the TV on. This function is only available if you have previously used the AV amplifier to output TV sound.
- Automatically switches the sound output to the AV amplifier by turning the AV amplifier on when the TV is turned on.
- Automatically turns the connected AV amplifier off when you switch the TV to standby mode.
- Adjusts the volume (VOL +/-) and mutes the sound (MUTING) of the connected AV amplifier through the TV's remote control.



-

When connecting a digital audio system that is compatible with Audio Return Channel (ARC) technology, connect to HDMI IN 1 with an HDMI cable. If connecting a system that is incompatible with "Control for HDMI" or Audio Return Channel, an additional audio connection via DIGITAL AUDIO OUT (OPTICAL) is necessary.

Video Camera

- Automatically turns the TV on and switches the input to the connected video camera when the connected video camera is turned on.
- Automatically turns the connected video camera off when you switch the TV to standby mode.

[▲ Return to Top](#)

- "BRAVIA" TV Features
- Watching TV
- Using the Home Menu
- Fun Features with Connected Equipment
- Parts Description
- Troubleshooting
- Index

[→ i-Manual online map](#)

Settings

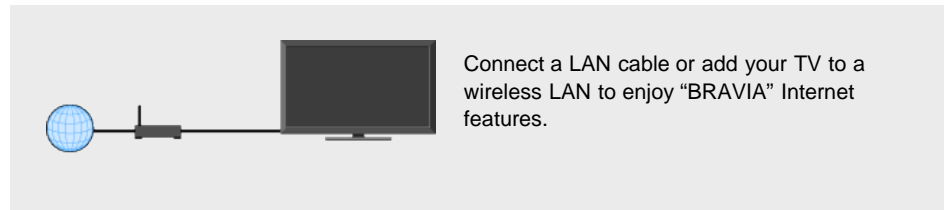

Internet Settings

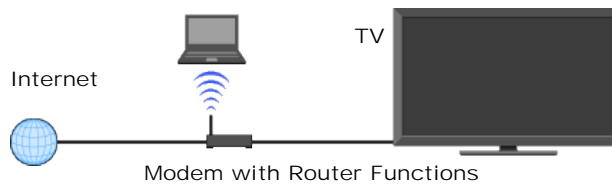

Connecting to the Internet

Using the network feature you can connect the TV to the Internet. The setup procedure differs depending on the type of network and LAN router.

Before setting up the Internet connection:

- Be sure to set up a LAN router.
- Check your wireless LAN environment using the following chart. If you have a wired network environment, directly refer to (4).

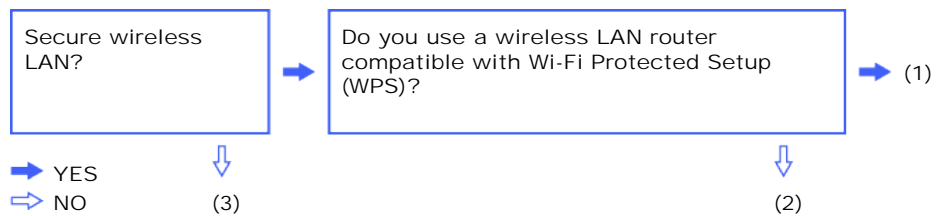

- (1) ➔ Follow the configuration for "Network Setup" and "Secured Network with Wi-Fi Protected Setup (WPS)."
- (2) ➔ Follow the configuration for "Network Setup" and "Secured Network without Wi-Fi Protected Setup (WPS)."
- (3) ➔ Follow the configuration for "Network Setup" and "Unsecured Network with Any Type of Wireless LAN Router."
- (4) ➔ Refer to "Network Setup" and follow the instructions that appear on the screen.

Network Setup

"Network Setup" helps you configure network settings with the settings wizard. Follow the instructions on the screen.

Press HOME, then select > Network > Network Setup.

The start-up screen allows you to select a setting procedure according to your network environment.

"View Network Status": Select to confirm your network status.

"Wired Setup": Use to connect to a wired network.

"Wireless Setup": Use to connect to a wireless network.

Secured Network with Wi-Fi Protected Setup (WPS)

The WPS standard makes setup of a secure wireless home network as simple as pressing the WPS button on the wireless LAN router. Before setting up a wireless LAN, check the location of the WPS button on the router and verify how to use it.

1. Select "Wireless Setup" from the "Network Setup" start-up screen.
2. Select "WPS (Push Button)" for Push Button method or "WPS (PIN)" for PIN method.
3. Follow the instructions that appear on the setup screen.



- To connect to a wireless LAN with WPS, your wireless LAN router needs to support the WPS standard.

Secured Network without Wi-Fi Protected Setup (WPS)

For setting up a wireless LAN, SSID (wireless network name) and security key (WEP or WPA key) will be required. If you do not know them, consult the instruction manual of your router.

1. Select "Wireless Setup" from the "Network Setup" start-up screen.
2. Select "Scan," then select a network from the list of scanned wireless networks.
3. Follow the instructions that appear on the setup screen.

Unsecured Network with Any Type of Wireless LAN Router

For setting up a wireless LAN, SSID (wireless network name) will be required. Security key (WEP or WPA key) will not be required because you need to select no security method in this procedure.

1. Select "Wireless Setup" from the "Network Setup" start-up screen.
2. Select "Scan," then select a network from the list of scanned wireless networks.
3. Follow the instructions that appear on the setup screen.

Checking the Network Connection

Enter the respective alphanumeric values for your router if necessary. The items that need to be set (e.g. IP Address, Subnet Mask, DHCP) may differ depending on the Internet service provider or router. For details, refer to the instruction manuals provided by your Internet service provider, or those supplied with the router.

1. Select "Auto" to set the IP Address and proxy server automatically, or "Custom" to set them manually.
2. Follow the instructions that appear on the setup screen.

[▲ Return to Top](#)

| |
|--|
| "BRAVIA" TV Features |
| Watching TV |
| Using the Home Menu |
| Fun Features with Connected Equipment |
| Parts Description |
| Troubleshooting |
| Index |

[→ i-Manual online map](#)

"BRAVIA" Internet Video

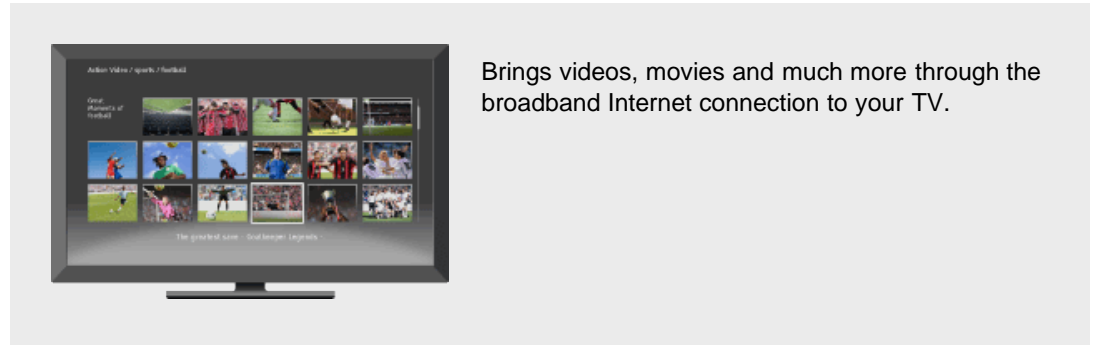

"BRAVIA" Internet Video serves as a gateway to Internet content, delivering a variety of on-demand entertainment straight to your TV. By making a broadband Internet connection, you can enjoy video content, including movies and cartoons.

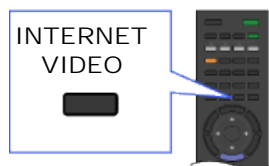

- Be sure to connect your TV to the broadband Internet and complete the initial setup and "Network Setup."

Selecting the "BRAVIA" Internet Video

Highlight the video icon you want to watch by using the remote control, then press **⊕** to make a selection.

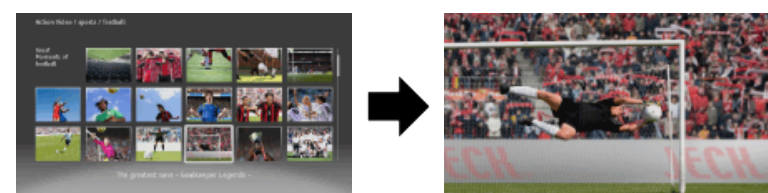

- Information about the highlighted icon appears in the information banner.



- The interface to Internet content depends on the Internet content providers.
- Services block video content based on the “Parental Lock” setting of the TV. Some service providers do not support this function.
- To update “BRAVIA” Internet Video content services, press HOME, then select  > Network > Refresh Internet Content.

Using the Internet Video

You can seek forward or seek backward in the video content. (This feature is available depending on Internet content services.)



Press the corresponding buttons on your remote control.

[▲ Return to Top](#)

"BRAVIA" TV Features

Watching TV

Using the Home Menu

Fun Features with
Connected Equipment

Parts Description

Troubleshooting

Index

[→ i-Manual online map](#)

Photomap

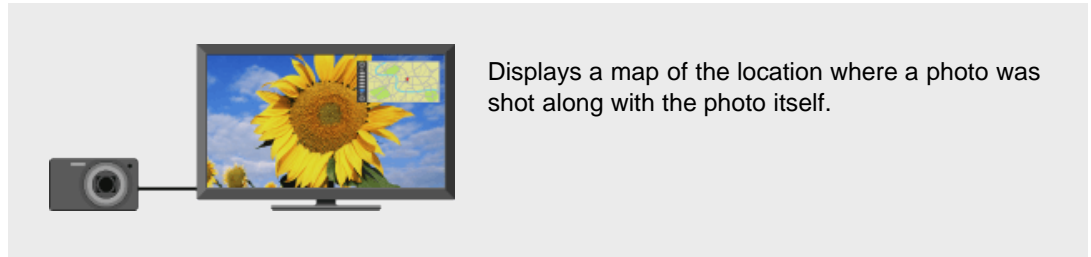

By connecting a digital still camera with GPS function, you can display a photo with a map of the location where the photo was taken. To use this feature, the TV has to be connected to the Internet to download map information.



1. Select a photo by using the "XMB."
2. Press the / buttons to zoom in/out on the map.
3. Press the far left colored button repeatedly to change the display position of the map.



- Only a large-scale map that cannot be zoomed in or out is displayed if the TV is not connected to the Internet or the online map service is terminated.
- The position indicated on the map may differ depending on the image capture device.
- The Internet online map service is provided by a third party. For this reason, service may be changed or terminated without prior notification.

[▲ Return to Top](#)

"BRAVIA" TV Features

Watching TV

Using the Home Menu

Fun Features with
Connected Equipment

Parts Description

Troubleshooting

Index

→ i-Manual online map

Home Network

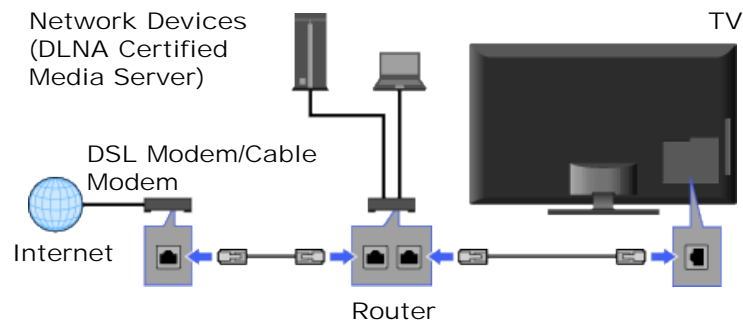
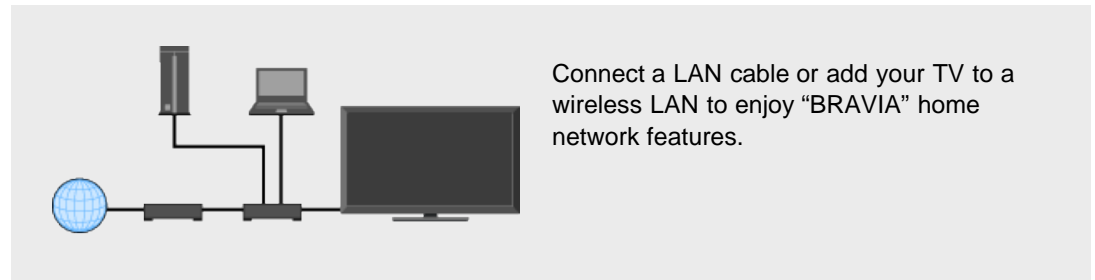

Enjoying Photo/Music/Video Files via the Network

Enjoy various content, such as photo/music/video files, stored in DLNA Certified media server on your home network. With the home network feature, you can enjoy network content on the TV even in other rooms. To enjoy your home network, DLNA Certified media server is required.

1. Press HOME and select the listed media servers under the "Photo," "Music" or "Video" category.
2. Select files or folders to play from the list on the selected media server.



- Files from a network device need to be compatible with the following file formats.
 - Still images: JPEG format
 - Music: MP3 format or linear PCM format
 - Video: AVCHD or MPEG2 format (not playable in some cases)

Renderer

You can play back photo, music and video files stored in network devices (e.g. digital still cameras, mobile phones) on the TV screen by directly operating the target device. The network device should also be renderer-compatible.

To set a renderer, press HOME then select > Network > Renderer > the desired settings.



- Play back media files by using the network devices.

Adjusting Display Settings for Media Server

Select home network servers to be displayed in the Home Menu. Up to 10 servers can be displayed in the Home Menu automatically.

1. Press HOME, then select  > Network > Show/Hide Media Servers.
2. Select the server you want to display on the Home Menu and adjust the settings.

Media Server Troubleshooting

The TV detects if the server is being correctly recognized when you cannot connect it to your home network. If the diagnostic results indicate a failure, check possible causes, and network connections and settings.

1. Press HOME, then select  > Network > Media Server Troubleshooting.
2. The diagnostic result list appears when the detection is complete.

[▲ Return to Top](#)

| |
|---------------------------------------|
| "BRAVIA" TV Features |
| Watching TV |
| Using the Home Menu |
| Fun Features with Connected Equipment |
| Parts Description |
| Troubleshooting |
| Index |

[→ i-Manual online map](#)

PC

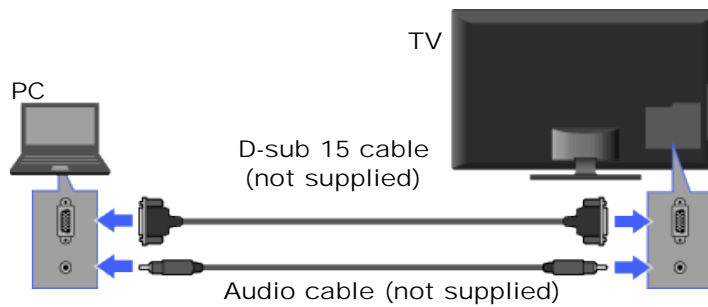
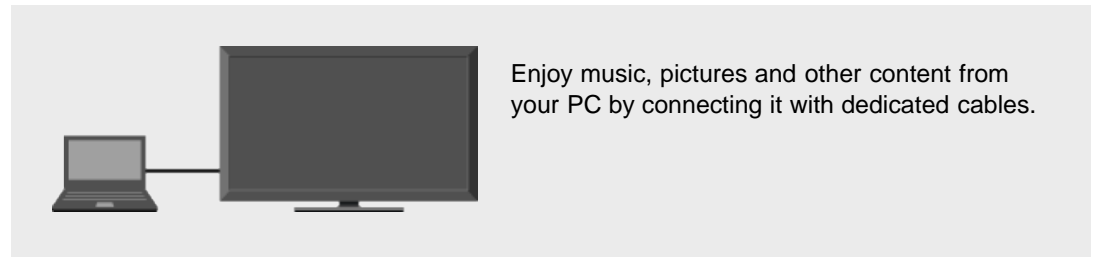

- For some Apple Macintosh computers, it may be necessary to use an adapter (not supplied). If an adapter is used, connect the adapter to the computer before connecting the HD15-HD15 cable.
- You can connect an HDMI-compatible PC with an HDMI cable.

PC Input Signal Reference Chart

- VGA**
 - Horizontal (Pixel)/Vertical (Line): 640/480
 - Horizontal frequency (kHz)/Vertical frequency (Hz): 31.5/60
 - Standard: VGA
- SVGA**
 - Horizontal (Pixel)/Vertical (Line): 800/600
 - Horizontal frequency (kHz)/Vertical frequency (Hz): 37.9/60
 - Standard: VESA Guidelines
- XGA**
 - Horizontal (Pixel)/Vertical (Line): 1024/768
 - Horizontal frequency (kHz)/Vertical frequency (Hz): 48.4/60
 - Standard: VESA Guidelines
- WXGA**
 - Horizontal (Pixel)/Vertical (Line): 1280/768, 1280/768, 1360/768
 - Horizontal frequency (kHz)/Vertical frequency (Hz): 47.4/60, 47.8/60, 47.7/60

- Standard: VESA
- SXGA (Full HD model only)
 - Horizontal (Pixel)/Vertical (Line): 1280/1024
 - Horizontal frequency (kHz)/Vertical frequency (Hz): 64.0/60
 - Standard: VESA
- HDTV* (Full HD model only)
 - Horizontal (Pixel)/Vertical (Line): 1920/1080
 - Horizontal frequency (kHz)/Vertical frequency (Hz): 67.5/60
 - Standard: CEA-861*



- This TV's PC input does not support Sync on Green or Composite Sync.
- This TV's PC VGA input does not support interlaced signals.
- For optimum picture quality, it is recommended to use the signals in the chart. In plug and play, signals with a 60 Hz vertical frequency will be detected automatically. (PC reboot may be necessary.)

* The 1080p timing when applied to the HDMI input will be treated as a video timing and not PC timing. This will affect "Preferences" and "Picture & Display" settings. To view PC content, set "Scene Select" to "Graphics," "Wide Mode" to "Full," and "Display Area" to "Full Pixel."

[▲ Return to Top](#)

"BRAVIA" TV Features

Watching TV

Using the Home Menu

Fun Features with
Connected Equipment

Parts Description

Troubleshooting

Index

[→ i-Manual online map](#)

Top

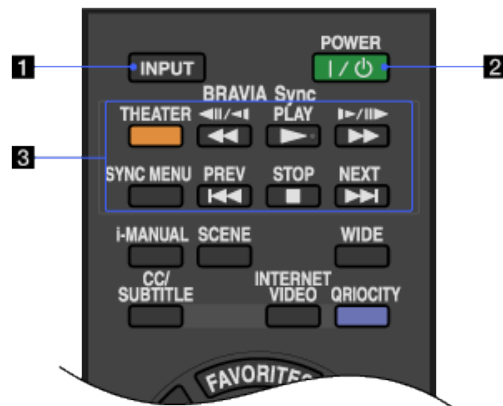
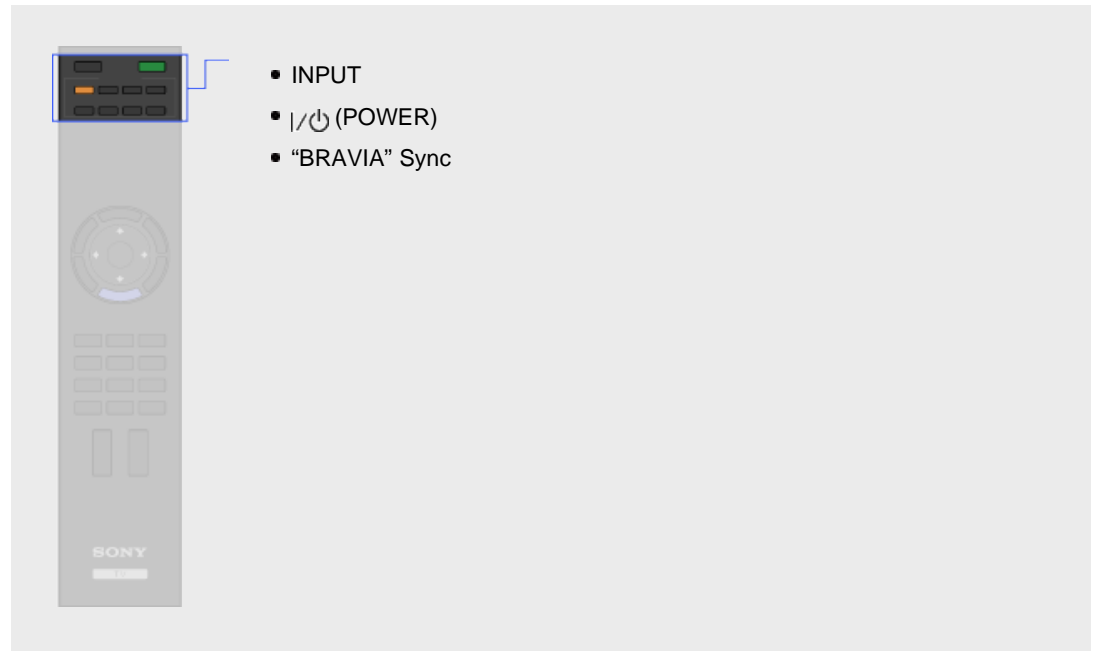

1 INPUT

Press to display a list of inputs.

2 |/⏻ (POWER)

Press to turn on the TV or to enter standby mode.

3 "BRAVIA" Sync

: When the "BRAVIA" Sync-compatible equipment is connected to the TV, you can operate the equipment via the TV remote control, while viewing pictures from the equipment.

THEATER: Set "Theater Mode" to on for optimum sound and picture quality of film-based content.

SYNC MENU: Press to display the "BRAVIA" Sync Menu and then select connected HDMI equipment from "HDMI Device Selection."



- If you turn the TV off, “Theater Mode” is also turned off.
- When you change the “Scene Select” setting, “Theater Mode” turns off automatically.
- “Control for HDMI” (“BRAVIA” Sync) is only available for the connected Sony equipment that has the “BRAVIA” Sync logo or is compatible with “Control for HDMI.”

[▲ Return to Top](#)

| |
|---------------------------------------|
| "BRAVIA" TV Features |
| Watching TV |
| Using the Home Menu |
| Fun Features with Connected Equipment |
| Parts Description |
| Troubleshooting |
| Index |

[→ i-Manual online map](#)

Upper

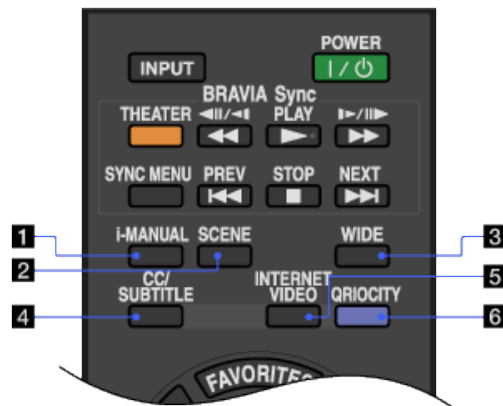
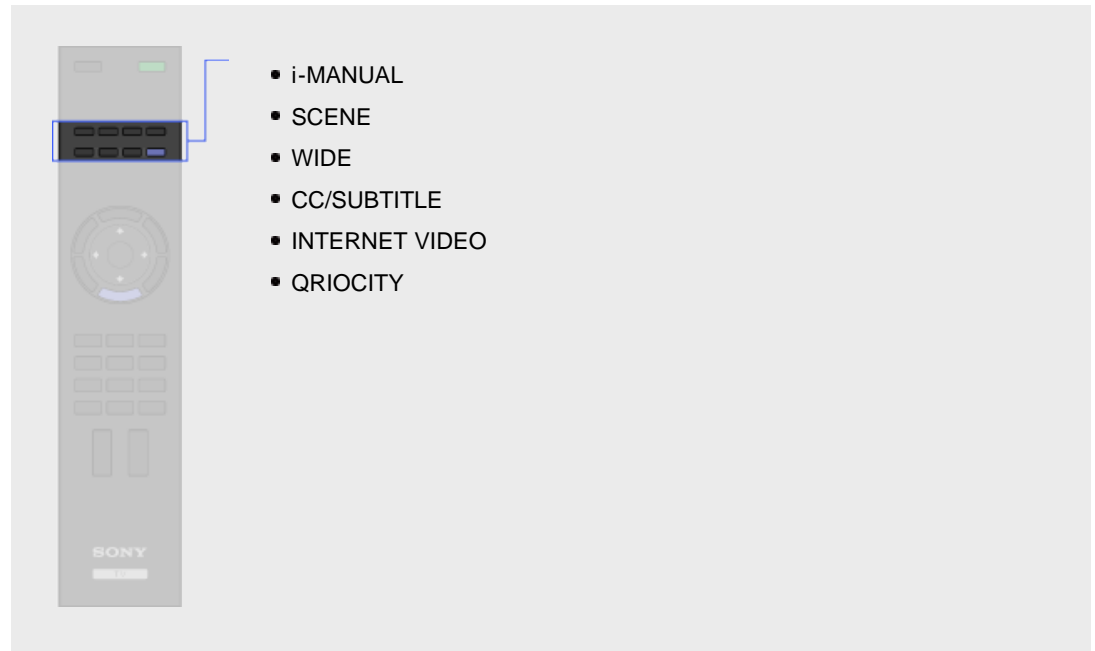

1 i-MANUAL

Press to display the on-screen instruction manual (this manual).

2 SCENE

Press to display the "Scene Select" menu. Select the desired scene option for optimum sound and picture quality.

3 WIDE

Press to change the wide mode.

4 CC/SUBTITLE

Press to turn closed captions/subtitles on or off (when the feature is available).

5 INTERNET VIDEO

Press to access Internet content on the "XMB."

6 QRIO CITY

Press to access "Qriocity" online service.



- This feature (button) may not be available in some regions/countries.

[▲ Return to Top](#)

| |
|---------------------------------------|
| "BRAVIA" TV Features |
| Watching TV |
| Using the Home Menu |
| Fun Features with Connected Equipment |
| Parts Description |
| Troubleshooting |
| Index |

[→ i-Manual online map](#)

Middle

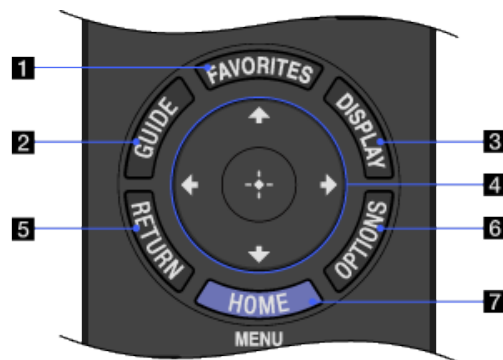

1 FAVORITES
Press to display the "Favorites" menu.

2 GUIDE
Press to display the program guide.



- The Guide feature is available depending on your region/country.

3 DISPLAY
Press once to display information about the channel/program/input you are viewing. The information will time out in a few seconds or press again to exit.

4
Press to move the on-screen cursor. Press to select/confirm a

highlighted item.

5 RETURN

Press to return to the previous screen or exit from the menu.

6 OPTIONS

Press to display a list of convenient functions and menu shortcuts. The menu items vary based on the current input and/or content.

7 HOME

Press to display the TV Home Menu.

[▲ Return to Top](#)

"BRAVIA" TV Features

Watching TV

Using the Home Menu

Fun Features with
Connected Equipment

Parts Description

Troubleshooting

Index

[→ i-Manual online map](#)

Lower

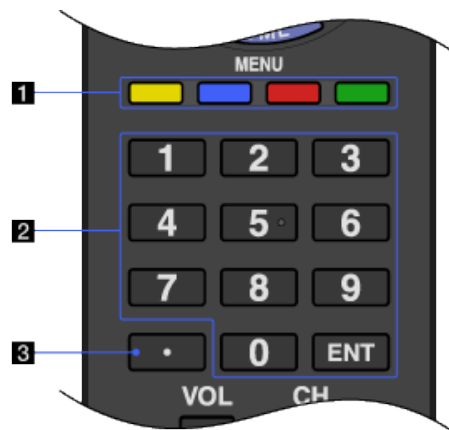
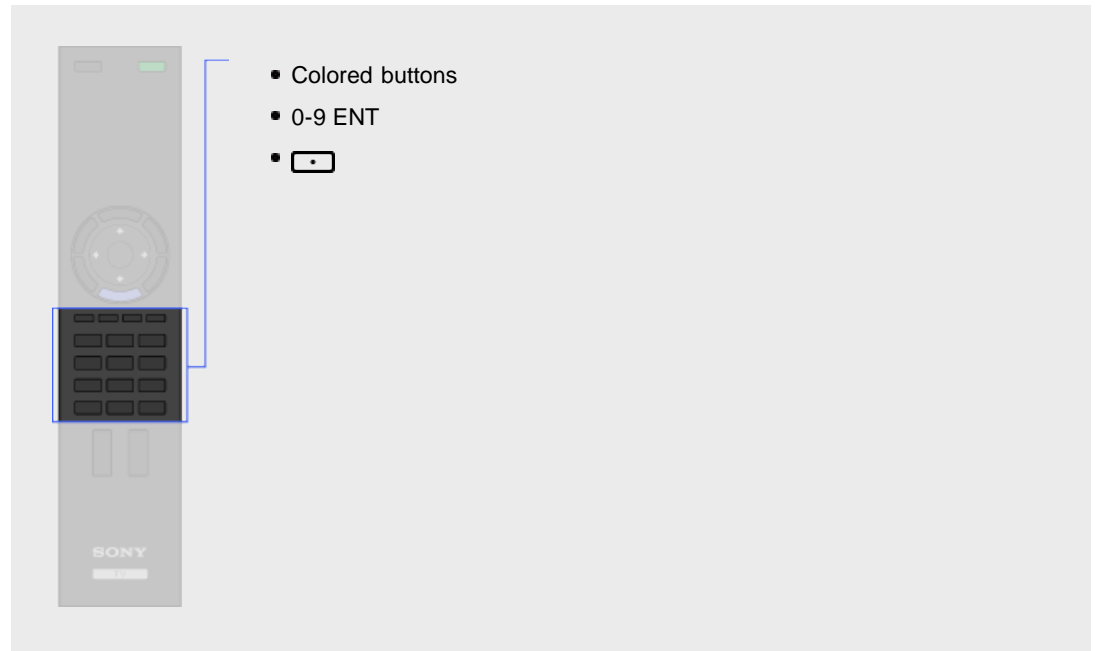

1 Colored buttons

When the colored buttons are available, an operation guide appears on the screen.

2 0-9 ENT

Press 0-9 to select a channel. Press ENT to change channels immediately.

3

Use with 0-9 and ENT to select digital channels. For example, to enter 2.1, press 2, , 1 and ENT.

[▲ Return to Top](#)

"BRAVIA" TV Features

Watching TV

Using the Home Menu

Fun Features with
Connected Equipment

Parts Description

Troubleshooting

Index

[→ i-Manual online map](#)

Bottom

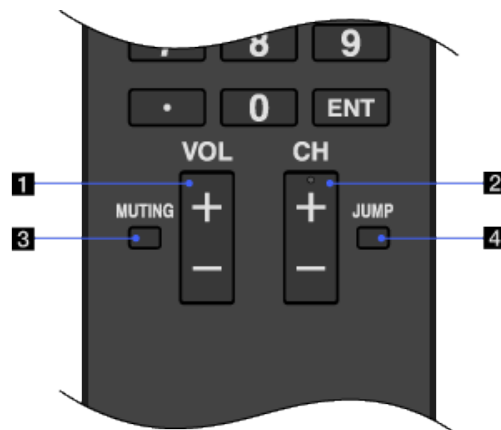
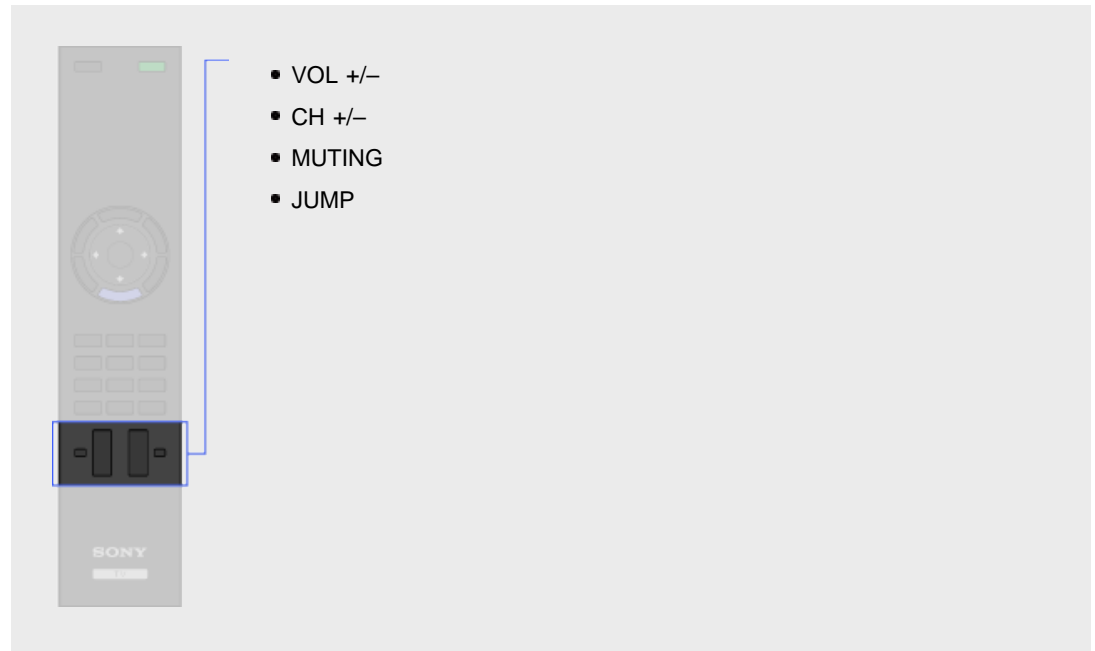

1 VOL +/-

Press to adjust the volume.

2 CH +/-

Press to select the next (+) or previous (-) channel.

3 MUTING

Press to mute the sound. Press again to restore the sound.

4 JUMP

Press to jump back and forth between two channels or inputs. The TV alternates between the current channel or input and the last channel or input that was selected.

"BRAVIA" TV Features

Watching TV

Using the Home Menu

Fun Features with
Connected Equipment

Parts Description

Troubleshooting

Index

[→ i-Manual online map](#)

Back

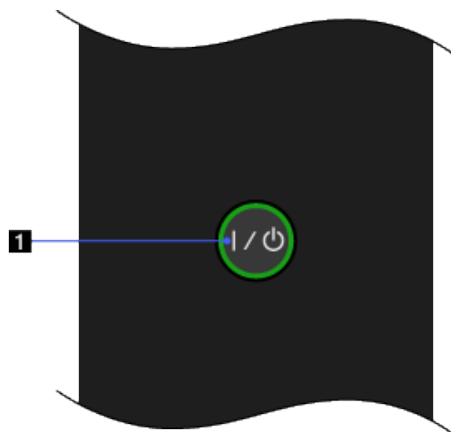

1 I/O (POWER)

Press to turn on the TV or to enter standby mode.

[▲ Return to Top](#)

"BRAVIA" TV Features

Watching TV

Using the Home Menu

Fun Features with
Connected Equipment

Parts Description

Troubleshooting

Index

→ i-Manual online map

Front

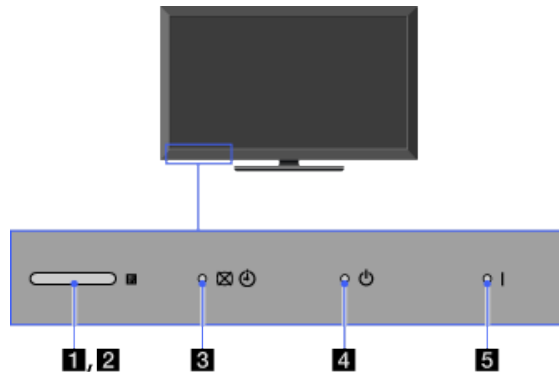
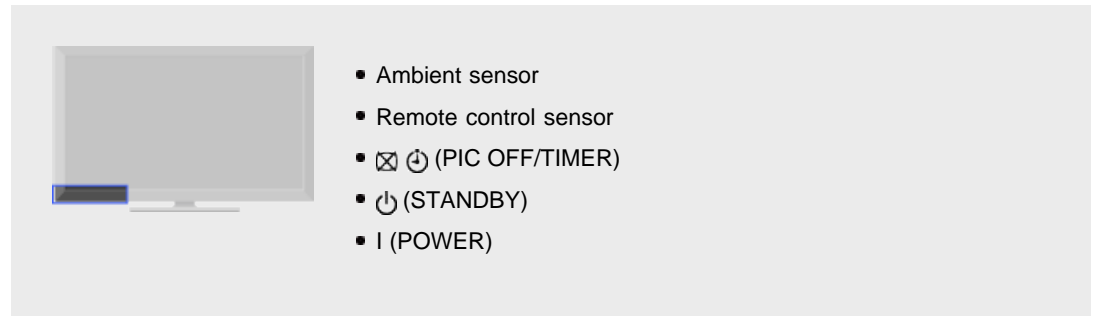

1 Ambient sensor

Senses the ambient light level and adjusts the brightness and color temperature of the picture accordingly.

Do not put anything near the sensor, doing so may affect its function.

2 Remote control sensor

Receives signals from the remote control.

Do not put anything near the sensor, doing so may affect its function.

3 ☒ ⏻ (PIC OFF/TIMER)

Lights up in green when you select "Picture Off."

Lights up in orange when you set the timer.

Lights up and/or blinks in orange during a software upgrade.

4 ⏻ (STANDBY)

Lights up in red when your TV is in standby mode, PC power saving mode or during a software upgrade.

5 I (POWER)

Lights up in green when the TV is on.

▲ Return to Top

"BRAVIA" TV Features

Watching TV

Using the Home Menu

Fun Features with
Connected Equipment

Parts Description

Troubleshooting

Index

[→ i-Manual online map](#)

Right



- POWER
- CHANNEL +/-
- VOLUME +/-
- INPUT
- HOME
- ENERGY SAVING SWITCH

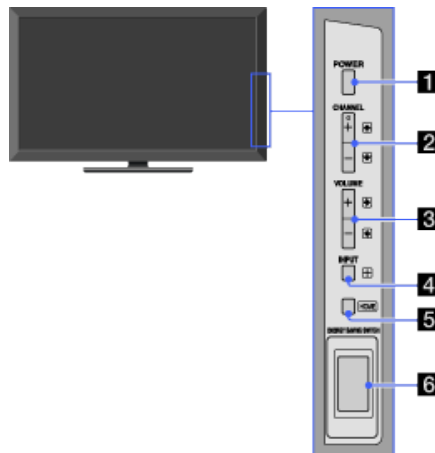

1 POWER

Press to turn on the TV or to enter standby mode.



- When ENERGY SAVING SWITCH is off, the TV cannot be turned on.

2 CHANNEL +/-

Press to select the next (+) or previous (-) channel.



- In the TV menu, these buttons will work as .

3 VOLUME +/-

Press to adjust the volume.



- In the TV menu, these buttons will work as .

4 INPUT

Press to display a list of inputs.



- In the TV menu, this button will work as .

5 HOME

Press to display the TV Home Menu.

6 ENERGY SAVING SWITCH

Press to turn the TV on or off. When ENERGY SAVING SWITCH is switched off, power consumption is reduced.



- When ENERGY SAVING SWITCH is switched off, you will not be able to perform functions such as saving clock settings.

[▲ Return to Top](#)

"BRAVIA" TV Features

Watching TV

Using the Home Menu

Fun Features with
Connected Equipment

Parts Description

Troubleshooting

Index

→ i-Manual online map

Back



- LAN
- PC IN
- HDMI IN 1/4
- DIGITAL AUDIO OUT (OPTICAL)
- AUDIO OUT (VAR/FIX)
- VIDEO IN 1, COMPONENT IN 1/2
- CABLE/ANTENNA

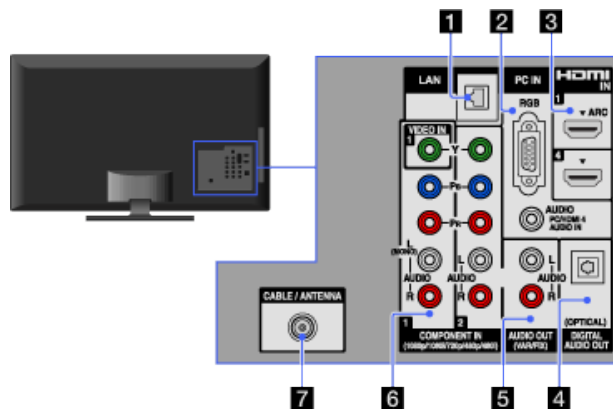

1 LAN

Connects to an existing network using an Ethernet cable.

2 PC IN

Connects to a personal computer's video and audio output connector. Can also be connected to other analog RGB equipment.



- For some Apple Macintosh computers, it may be necessary to use an adapter (not supplied). If this is the case, connect the adapter to the computer before connecting the HD15-HD15 cable.
- It is indispensable to use a PC cable with ferrite cores.

3 HDMI IN 1/4

HDMI (High-Definition Multimedia Interface) provides an uncompressed, all-digital audio/video interface between this TV and any HDMI-equipped audio/video equipment. In addition, when you connect the equipment that is compatible with "Control for HDMI," communication with the connected equipment is supported.



- Be sure to use only an authorized HDMI cable bearing the HDMI logo.

- If connecting a digital audio system that is compatible with Audio Return Channel (ARC) technology, use the HDMI IN 1. If not, an additional connection with DIGITAL AUDIO OUT (OPTICAL) is necessary.
- If the equipment has a DVI jack, connect it to the HDMI IN 4 through a DVI - HDMI adapter interface (not supplied), and connect the equipment's audio out jacks to the PC/HDMI 4 AUDIO IN which is located in the PC IN.

4 DIGITAL AUDIO OUT (OPTICAL)

Connects to the optical audio input of digital audio equipment that is PCM/Dolby Digital compatible.

5 AUDIO OUT (VAR/FIX)

Connects to the left and right audio input jacks of your analog audio equipment. You can use these outputs to listen to your TV's audio through your stereo system.

6 VIDEO IN 1, COMPONENT IN 1/2 (1080p/1080i/720p/480p/480i)

This input can be used as a composite video input or as a component video input.

For composite use, connect to VIDEO IN 1 for video, and to AUDIO (L/R) of COMPONENT IN 1 for audio signals.

For component connection, use Y, PB, PR for video signals and also connect to AUDIO (L/R) for audio signals.



- The TV will automatically detect and switch between VIDEO IN 1 and COMPONENT IN 1. To manually set the input type, press HOME, select  > Channels & Inputs > Video 1/Component 1 Selection.

7 CABLE/ANTENNA

RF input that connects to your cable or over-the-air antenna.

[▲ Return to Top](#)

"BRAVIA" TV Features

Watching TV

Using the Home Menu

Fun Features with
Connected Equipment

Parts Description

Troubleshooting

Index

→ i-Manual online map

Right



- USB
- HDMI IN 2/3
- VIDEO IN 2

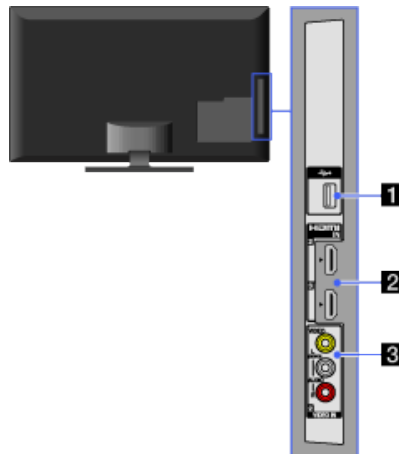

1 USB

You can enjoy photo, music, video files stored on a USB device.

2 HDMI IN 2/3

HDMI (High-Definition Multimedia Interface) provides an uncompressed, all-digital audio/video interface between this TV and any HDMI-equipped audio/video equipment. In addition, when you connect the equipment that is compatible with "Control for HDMI," communication with the connected equipment is supported.



- Be sure to use only an authorized HDMI cable bearing the HDMI logo.
- If connecting a digital audio system that is compatible with Audio Return Channel (ARC) technology, use the HDMI IN 1 on the rear of the TV. If not, an additional connection with DIGITAL AUDIO OUT (OPTICAL) is necessary.
- If the equipment has a DVI jack, connect it to the HDMI IN 4 on the rear of the TV, through a DVI - HDMI adapter interface (not supplied), and connect the equipment's audio out jacks to the PC/HDMI 4 AUDIO IN which is located in the PC IN.

3 VIDEO IN 2

Connect with a composite video cable. When connecting mono equipment, connect to the L (MONO) audio jack.

"BRAVIA" TV Features

Watching TV

Using the Home Menu

Fun Features with
Connected Equipment

Parts Description

Troubleshooting

Index

[→ i-Manual online map](#)

Picture

- You cannot receive any channels.
- TV is locked to one channel.
- You cannot receive or select channels.
- TV turns off automatically.
- No picture from some video sources.
- Picture quality is not as good as viewed at the store.
- Broadcast HD formats have poor quality.
- Double images or ghosts appear.
- Only snow and noise appear on the screen.
- Dotted lines or stripes appear.

You cannot receive any channels.

- Make sure the "Cable/Antenna" setting is correct for your TV signal source.

TV is locked to one channel.

- Perform "Auto Program" to add receivable channels that are not present in the TV's memory.

You cannot receive or select channels.

- Perform "Auto Program" to add receivable channels that are not present in the TV's memory.
- To receive or select cable channels, make sure that signal type in the channel settings is set to "Cable."
- To receive or select UHF channels over an antenna, make sure signal type is set to "Antenna."

TV turns off automatically.

- Check if "Sleep Timer" is activated.
- Check if "Presence Sensor" is activated.
- Check if "Auto Shut-off" in "Eco" is activated.

No picture from some video sources.

- Press INPUT on the remote control.
- Press HOME on the remote control. Select the desired input from the .

Picture quality is not as good as viewed at the store.

- Picture quality depends on the signal content. See the specifications to display the best possible picture for that signal.

Broadcast HD formats have poor quality.

- Content and signal quality are regulated by the signal provider. Many HD channels and content are actually upscaled versions of standard-definition broadcasts. The picture is affected by the quality of the signal received, which varies between channel and program.
-

Double images or ghosts appear.

- Check cable or antenna connections.
 - Check the antenna location and direction.
 - Set the "Motionflow" to "Standard" or "Off."
-

Only snow and noise appear on the screen.

- Check if the antenna is broken or bent.
 - Check if the antenna has reached the end of its serviceable life (3-5 years in normal use, 1-2 years at the seaside).
-

Dotted lines or stripes appear.

- Keep the TV away from noise sources such as cars, motorcycles, or hair-dryers.
 - If using the 300-ohm twin lead, move the excess lead away from the TV or try using the 75-ohm coaxial cable (not supplied) instead.
-

No color/Dark picture/Color is not correct/Picture is too bright.

- Press OPTIONS then select "Picture Adjustments" to make adjustments.
 - Adjust the "Picture Mode" in "Picture Adjustments."
 - If you set the "Power Saving" mode to "Low" or "High," black level will be enhanced.
-

Noisy picture.

- Make sure that the antenna is connected using a 75-ohm coaxial cable.
 - Keep the antenna cable away from other connecting cords.
 - To avoid TV interference, make sure to use an undamaged antenna cable.
-

Blurry picture or poor color.

- Transporting the TV from a cold to a warm location or a sudden change in room temperature may cause moisture condensation, resulting in a blurry picture or poor color. Turn off your TV and wait a few hours before powering on again.
-

[▲ Return to Top](#)

"BRAVIA" TV Features

Watching TV

Using the Home Menu

Fun Features with
Connected Equipment

Parts Description

Troubleshooting

Index

[→ i-Manual online map](#)

Sound

- No sound but good picture.
- Audio Noise.
- No audio or low audio with Home Theater System.

No sound but good picture.

- Check the volume control.
- Press MUTING or VOL + so that "Muting" disappears from the screen.
- Set "Speakers" to "TV Speakers" in "Sound" settings. If it is set to "Audio System," sound is not output from the TV's speakers regardless of the TV's volume control.
- When using HDMI input with Super Audio CD or DVD-Audio, DIGITAL AUDIO OUT (OPTICAL) may not provide an audio signal.

Audio noise.

- Make sure that the antenna is connected using a 75-ohm coaxial cable.
- Keep the antenna cable away from other connecting cords.
- To avoid TV interference, make sure to use an undamaged antenna cable.

No audio or low audio with Home Theater System.

- Press THEATER for "BRAVIA" Sync activated Theater System.
- Set "Speakers" to "Audio System" in the "Sound" settings.
- Set "Audio Out" to "Fixed" in the "Sound" settings.

[▲ Return to Top](#)

"BRAVIA" TV Features

Watching TV

Using the Home Menu

Fun Features with
Connected Equipment

Parts Description

Troubleshooting

Index

[→ i-Manual online map](#)

Channels

- You cannot select the desired channels.
- Some channels are blank.
- You cannot view digital channels.

You cannot select the desired channels.

- Switch between digital and analog mode, and select the desired channel.

Some channels are blank.

- The channel is for scrambled/subscription service only. Subscribe to a pay TV service.
- The channel is used only for data (no picture or sound).
- Contact the broadcaster for transmission details.

You cannot view digital channels.

- Ask a local installer if digital transmissions are provided in your area.
- Upgrade to a higher gain antenna.

[▲ Return to Top](#)

"BRAVIA" TV Features

Watching TV

Using the Home Menu

Fun Features with
Connected Equipment

Parts Description

Troubleshooting

Index

[→ i-Manual online map](#)

Home Network

- DLNA Certified equipment cannot connect to the server.
- The message "Network disconnected" appears on your TV screen.
- DLNA Certified media server is listed under the "Photo"/"Music"/"Video" category, but is inaccessible.
- Sometimes the video streaming quality is poor when using the wireless LAN.
- Wireless LAN connection fails or radio reception conditions are bad.

DLNA Certified equipment cannot connect to the server.

- Check the LAN cable or connection to your server and your TV.
- Check if your network is properly configured on your TV.

The message "Network disconnected" appears on your TV screen.

- Check the current network settings. Press HOME and select > Network > Network Setup > View Network Status. If all of your network settings are 0.0.0.0, your server may not be connected properly. Check your network connections and/or server's instruction manual for connection information.
- Reconfigure your network settings.
- If the LAN cable is connected to an active server and the TV has acquired an IP Address, check your DLNA Certified media server's connections and configurations.



- Your IP Address configuration can be viewed by selecting the "View Network Status" option.

DLNA Certified media server is listed under the "Photo"/"Music"/"Video" category, but is inaccessible.

- The TV may have lost connection with the server, check your LAN cable/connection or your server connections.
- To check if your media server is properly communicating with the TV run the diagnostic check. Press HOME and select > Network > Media Server Troubleshooting. Once the diagnostic check is complete, media server results will appear.

Sometimes video streaming quality is poor when using the wireless LAN.

- The wireless network connection quality varies depending on the distance between TV or USB Wireless LAN Adapter and the router, environment interference, and wireless router quality. It is suggested to use wireless routers supporting 5GHz operation for video streaming and place the router closer to the bridge adapter.

Wireless LAN connection fails or radio reception conditions are bad.

- Check the installation location for the TV and wireless LAN router. Signal condition may be affected for the following reasons.
 - Other wireless devices, microwaves, fluorescent lights, etc., are placed nearby.
 - There are floors or walls between the wireless LAN router and TV.
- When using a USB Wireless LAN Adapter, move it to avoid signal interference by using an extension cable with base unit (optional accessory).

[▲ Return to Top](#)

Copyright 2010 Sony Corporation

"BRAVIA" TV Features

Watching TV

Using the Home Menu

Fun Features with
Connected Equipment

Parts Description

Troubleshooting

Index

[→ i-Manual online map](#)

Remote Control

- Remote control does not operate./Replace the batteries.

Remote control does not operate./Replace the batteries.

- To determine if the problem is with the remote control or not, press a button on the TV.
- Check the polarity of the batteries or replace the batteries.

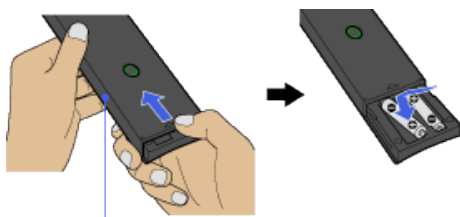

Slide the cover to open.

- Point the remote control at the remote control sensor located at the front of the TV.
- Keep the remote control sensor area clear from obstacles.
- Fluorescent light can interfere with remote control operation; try turning off the fluorescent light.

[▲ Return to Top](#)

"BRAVIA" TV Features

Watching TV

Using the Home Menu

Fun Features with
Connected Equipment

Parts Description

Troubleshooting

Index

[→ i-Manual online map](#)

General

- You cannot find a connected "BRAVIA" Sync HDMI device.
- You cannot control a second AV receiver.
- Poor picture quality on PC input.
- Poor picture on "BRAVIA" Internet Video.
- Small picture on "BRAVIA" Internet Video.
- Certain Internet video programs display a loss of detail, especially during fast-motion or dark scenes.
- Good picture quality but no sound on Internet video content.

You cannot find a connected "BRAVIA" Sync HDMI device.

- Make sure that "Control for HDMI" is set up on both the TV and the optional equipment compatible with "BRAVIA" Sync.

You cannot control a second AV receiver.

- Only one AV receiver may be used with the "BRAVIA" Sync and "Control for HDMI" functions at one time.
- The buttons on the remote control do not operate equipment with the "Control for HDMI" function.



Poor picture quality on PC input.

- Adjust the resolution.
- Adjust "Pitch" and "Phase."

Poor picture on "BRAVIA" Internet Video.

- The quality of the video displayed on your TV depends on the quality of the video provided by the video content provider as well as your connection bandwidth.

Small picture on "BRAVIA" Internet Video.

- Press /  to zoom in and out.

Certain Internet video programs display a loss of detail, especially during fast-motion or dark scenes.

- Video quality and picture size vary and are dependent upon broadband speed and delivery by content providers.

Good picture quality but no sound on Internet video content.

- Quality depends on content provided by the video content provider as well as your connection bandwidth.

- Due to the nature of Internet video, not all videos will contain sound.

You do not see many videos in the Internet Video Guide.

- Press the **OPTIONS** button and select categories to view more content.
- Check the “Parental Lock” ratings on the TV; some Internet content may be blocked based on the rating.

Wide Mode changes automatically.

- The current “Wide Mode” setting is automatically replaced with the “4:3 Default” setting when you change the channel or video input, if “4:3 Default” in the “Screen” settings is set to anything other than “Off.” If you want to lock in “Wide Mode” selected with **WIDE** on the remote control, set “4:3 Default” to “Off” in the “Screen” settings.
- Check the “Auto Wide” option in the “Screen” settings.

Suddenly the picture becomes small.

- The picture gets smaller during commercials due to the method by which a provider broadcasts its content. When HD content channels switch to SD content (commercials), the picture may be small with a black border.
- “Auto Wide” will not expand the picture during these content changes since the content information is regulated by the channel signal provider. You can manually change the “Wide Mode” if you prefer. This setting will remain in effect until you change the channel or input or manually change the “Wide Mode” again.

Black box on screen.

- You have selected a text option and no text is available. To turn off this feature, set the “CC Display” option to “Off.” If you were trying to select closed captioning, select “CC 1” instead of “Text 1”-“Text 4.”

Black bands appear at the edges of the screen.

- Some wide screen programs are filmed in aspect ratios that are greater than 16:9 (this is especially common with theatrical releases). Your TV will show these programs with black bands at the top and bottom of the screen. For more details, check the documentation that came with your DVD (or contact your program provider).
- Programs in 4:3 aspect ratio will have bands on the left and right sides of the screen.
- Programs broadcasted in HD formats (720p and 1080i) with 4:3 content will commonly have black bands on the left and right sides of the screen which are added by the broadcaster.
- “Auto Wide” will not expand the picture when the black bands on the sides of the screen are added by the broadcaster. You can manually change the “Wide Mode” to “Wide Zoom,” “H Stretch” or “Zoom” to fill the screen, which will remain in affect until you change the channel or inputs or manually change the “Wide Mode” again.

Certain programs on DVD or other digital sources display a loss of detail, especially during fast-motion or dark scenes.

- This is due to the digital compression of the source content used by certain digital broadcasts and DVDs which may cause your TV’s screen to display less detail than usual, or cause artifacts (small blocks or dots, pixelations) to appear on your screen. These signal compressions are more visible and depend on the clarity and resolution of the TV.

Some digital cable channels are not displayed.

- Certain cable companies have limitations on the broadcast of digital cable channels. Check with your cable company for more information.
- The digital cable channel may be set to “Hidden” in the “Show/Hide Channels” setting.

Some photo, music or video files are not displaying from your USB device or DLNA Certified media server.

- The accessible file or folder limit in a directory is 1,000 for USB and 30,000 for a DLNA Certified

media server. This limit includes non-supported files or just folders. Files or folders are populated based on their time stamps. Photo, music files or folders exceeding the limit will not be displayed.

Photo images appear small on the screen.

- Whether or not photo images can or cannot be displayed in full screen depends on the resolution or aspect ratio of the file.
-

Photo images or folders take time to display.

- Depending on the image dimension, file size, and number of files in a folder, some photo images or folders take time to display.
 - The first time a camera is connected to the TV via USB cable, it may take up to a couple of minutes for the photos to display.
-

TV screen feels warm.

- Due to the thin profile of this television, the heat generated by the LCD panel backlight and supporting electronics will be more noticeable. This is normal operation and not a cause for concern.
-

[▲ Return to Top](#)

"BRAVIA" TV Features

Watching TV

Using the Home Menu

Fun Features with
Connected Equipment

Parts Description

Troubleshooting

Index

[➔ i-Manual online map](#)

Add Digital Channels

Select to add digital channels.

Be sure to have the signal type option selected appropriately for the signal source.

[▲ Return to Top](#)

"BRAVIA" TV Features

Watching TV

Using the Home Menu

Fun Features with
Connected Equipment

Parts Description

Troubleshooting

Index

[→ i-Manual online map](#)

Picture Adjustments

Setting Memory

Select an input to make custom picture settings. Select "Common" to apply common picture settings to all inputs.



- Available inputs may vary depending on your region/country.

Picture Mode

Vivid

Enhances picture contrast and sharpness.

Standard

For standard pictures. Recommended for basic home use.

Custom

Stores your preferred settings.

Cinema

For film-based content. Suitable in a theater-like environment.

Sports

Optimizes picture quality for viewing sports.

Game-Standard

For standard picture suitable for games.

Game-Original

Adjusts the game picture according to your preference.

Graphics

Optimizes picture quality for viewing graphics.

Photo-Vivid

Enhances contrast, sharpness, and color of photographs.

Photo-Standard

For standard viewing of photographs.

Photo-Original

Enhances the visual warmth of photographs.

Photo-Custom

Adjusts the detailed settings for viewing photographs and stores your preferred settings.

Reset

Resets all the "Picture Adjustments" settings to the factory settings excluding "Setting Memory,"

“Picture Mode” and “Advanced Settings.”

Backlight

Adjusts the brightness of the backlight.

Picture

Adjusts picture contrast.

Brightness

Adjusts brightness of the picture.

Color

Adjusts color intensity.

Hue

Adjusts green and red tones.



- “Hue” is available depending on color system.
-

Color Temperature

Adjusts the whiteness of the picture.

Cool

Gives white colors a bluish tint.

Neutral

Gives white colors a neutral tint.

Warm 1/Warm 2

Gives white colors a reddish tint. “Warm 2” gives a redder tint than “Warm 1.”

Sharpness

Adjusts sharpness of the picture.

Noise Reduction

Auto

Automatically reduces picture noise (analog TV mode, or composite input signal only).

High/Medium/Low

Modifies the effect of noise reduction.

Off

Turns off “Noise Reduction.”



- “Noise Reduction” is available when “Intelligent Picture” is set to “Off” depending on your region/country.
 - Setting items vary depending on your region/country.
-

MPEG Noise Reduction

High/Medium/Low

Reduces noise in MPEG-compressed videos.

Off

Turns off "MPEG Noise Reduction."

Motionflow

High

Provides smoother picture movement, such as for film-based content.

Standard

Provides smoother picture movement. Use this setting for standard use.

Off

Use this setting if "High" or "Standard" results in picture noise.



- "Motionflow" is available depending on the TV model.
- Depending on the picture content, you may not see the effect visually even if you have changed the settings.

CineMotion

Auto

Provides the original film-based content as is.

Auto 1

Provides smoother picture movement than the original film-based content. Use this setting for standard use.

Auto 2

Provides the original film-based content as is.

Off

Turns off "CineMotion."



- If the image contains irregular signals or too much noise, this setting is automatically turned off even if "Auto 1," "Auto 2" or "Auto" is selected.



- Setting items vary depending on the TV model.

Advanced Settings

Sets "Picture Adjustments" settings in more detail.

Reset

Resets all the advanced settings to the factory settings.

Black Corrector

Enhances black areas of the picture for stronger contrast.

Adv. Contrast Enhancer

Adjusts "Backlight" and "Picture" by judging the brightness of the screen. This setting is effective for dark images and scenes.

Gamma

Adjusts the balance between bright and dark areas of the picture.

Auto Light Limiter

Reduces glare such as in scenes where the entire screen is white.

Clear White

Emphasizes white colors.

Live Color

Makes colors more vivid.

White Balance

Adjusts the temperature of each color.

[▲ Return to Top](#)

"BRAVIA" TV Features

Watching TV

Using the Home Menu

Fun Features with
Connected Equipment

Parts Description

Troubleshooting

Index

[→ i-Manual online map](#)

Parental Lock

Sets an age restriction for viewing, or blocks specific channels. To view any rated program you specify or any blocked channel, enter the correct password.



- For the password, refer to Troubleshooting in the paper manual supplied with this TV.
- "Country," "Rating" and "Unrated" are available depending on your region/country.

Password

Sets a four-digit password.

Country

Select "U.S.A." or "Canada" for the appropriate ratings.

Rating

Select the rating permission.

Downloadable U.S. Rating/Digital Rating

(item name varies depending on your region/country)

Customizes "Parental Lock" with downloadable digital rating.

Unrated

Allows or blocks programs or movies that are broadcasted without a rating.

Channel Block/Analog Channel Block

(item name varies depending on your region/country)

Blocks specific channels regardless of program ratings. To view any blocked channel, enter the correct password.

[▲ Return to Top](#)

"BRAVIA" TV Features

Watching TV

Using the Home Menu

Fun Features with
Connected Equipment

Parts Description

Troubleshooting

Index

[→ i-Manual online map](#)

Ambient Sensor

Optimizes the picture by sensing the lighting environment surrounding the TV.

[▲ Return to Top](#)

"BRAVIA" TV Features

Watching TV

Using the Home Menu

Fun Features with
Connected Equipment

Parts Description

Troubleshooting

Index

[→ i-Manual online map](#)

Closed Captions (CC)

CC Display

Displays "Closed Captions (CC)." Select "On when Muting" to automatically display closed captions when the TV is muted.

Analog CC

For the basic analog (EIA-608) closed caption options.

Digital CC

For both analog (EIA-608) and digital (EIA-708) closed caption options.

Display Options

Customizes the closed caption appearance.

[▲ Return to Top](#)

"BRAVIA" TV Features

Watching TV

Using the Home Menu

Fun Features with
Connected Equipment

Parts Description

Troubleshooting

Index

[➔ i-Manual online map](#)

Auto Program

Automatically scans for all available channels and stores them in the TV.

You can run "Auto Program" after moving to a new residence, changing service providers, or to search for newly launched channels.

[▲ Return to Top](#)

"BRAVIA" TV Features

Watching TV

Using the Home Menu

Fun Features with
Connected Equipment

Parts Description

Troubleshooting

Index

[→ i-Manual online map](#)

MTS Audio

For enjoying stereo, bilingual and monaural programs in analog mode.

Stereo

For stereo reception.

Auto SAP

For second audio reception of programs such as bilingual.

Mono

For monaural reception.

Use this item when the stereo signal is unstable.



- You can access "Alternate Audio" by using OPTIONS on the remote control. (This feature is only available for digital channels.)

[▲ Return to Top](#)

"BRAVIA" TV Features

Watching TV

Using the Home Menu

Fun Features with
Connected Equipment

Parts Description

Troubleshooting

Index

[→ i-Manual online map](#)

Program Information Source

Select a source to receive program information.

[▲ Return to Top](#)

"BRAVIA" TV Features

Watching TV

Using the Home Menu

Fun Features with
Connected Equipment

Parts Description

Troubleshooting

Index

[→ i-Manual online map](#)

Cable/Antenna

Select "Cable" or "Antenna" according to your receiving signal.



- You should run "Auto Program" after changing "Cable/Antenna."

[▲ Return to Top](#)

"BRAVIA" TV Features

Watching TV

Using the Home Menu

Fun Features with
Connected Equipment

Parts Description

Troubleshooting

Index

[→ i-Manual online map](#)

Edit Channel Labels

Assigns a channel name of your choice.

[▲ Return to Top](#)

"BRAVIA" TV Features

Watching TV

Using the Home Menu

Fun Features with
Connected Equipment

Parts Description

Troubleshooting

Index

[→ i-Manual online map](#)

Clock/Timers

Current Time

Set the current time. When the TV has received the time from the broadcast signal, the clock cannot be manually set.

Timer

Turns on the TV from standby mode at a time you set.

Sleep Timer

Turns the TV to standby mode after a preset length of time.



- When you turn off the TV and turn it on again, "Sleep Timer" is reset to "Off."

[▲ Return to Top](#)

"BRAVIA" TV Features

Watching TV

Using the Home Menu

Fun Features with
Connected Equipment

Parts Description

Troubleshooting

Index

[➔ i-Manual online map](#)

Contact Sony

Sony contact information is available from this screen for your convenience. TV specific information such as model name, serial number, software version and downloadable ratings (if available from the TV) are displayed here.

[▲ Return to Top](#)

"BRAVIA" TV Features

Watching TV

Using the Home Menu

Fun Features with
Connected Equipment

Parts Description

Troubleshooting

Index

[→ i-Manual online map](#)

Home Menu Scrolling

Select the cursor speed for navigating through menu items from "Standard," "Slow" or "No Auto Repeat."

[▲ Return to Top](#)

"BRAVIA" TV Features

Watching TV

Using the Home Menu

Fun Features with
Connected Equipment

Parts Description

Troubleshooting

Index

[→ i-Manual online map](#)

Eco

Changes the settings related to power consumption.



- "Presence Sensor" is available only for TV models compatible with the presence sensor function.

Power Saving

Reduces power consumption by adjusting the TV backlight. When you select "Picture Off," only sound remains.

Presence Sensor

When the sensor detects no audience in front of the TV for a certain period of time, it turns the picture off automatically, while leaving the TV sound on. Additionally, if no presence is detected after 30 minutes in picture off mode, the TV will switch to standby mode.

Idle TV Standby

Turns the TV off after it has been idle for the preset length of time.

Auto Shut-off

Turns the TV off when no input signal is detected for a certain period of time.

On

Switches to standby mode after 15 minutes.

Off

Turns off "Auto Shut-off."

[▲ Return to Top](#)

"BRAVIA" TV Features

Watching TV

Using the Home Menu

Fun Features with
Connected Equipment

Parts Description

Troubleshooting

Index

[→ i-Manual online map](#)

Manage Inputs

Assigns an icon or name to external equipment.

Select "Auto" to display icons or names only when the equipment is connected, or "Always" to display regardless of connection status.



- For a PC connection, icon and label cannot be set.

[▲ Return to Top](#)

"BRAVIA" TV Features

Watching TV

Using the Home Menu

Fun Features with
Connected Equipment

Parts Description

Troubleshooting

Index

[➔ i-Manual online map](#)

Analog Fine Tune

Allows you to fine-tune the channels to adjust picture quality.

Select "Auto" to adjust to the most appropriate analog channel or "Custom" to adjust manually.

[▲ Return to Top](#)

"BRAVIA" TV Features

Watching TV

Using the Home Menu

Fun Features with
Connected Equipment

Parts Description

Troubleshooting

Index

[→ i-Manual online map](#)

HDMI Settings

Communicates with equipment compatible with the "Control for HDMI" function.



- "Control for HDMI" settings must be made on the connected equipment.

Control for HDMI

Links the operations of the TV and the connected equipment.

For specific Sony equipment compatible with "Control for HDMI," this setting is applied automatically to the connected equipment when "On" is set.

Device Auto Power Off

Turns off the connected equipment when you turn off the TV.

TV Auto Power On

Turns on the TV when you turn on or perform playback, etc., on the connected equipment.

Device List

Displays a list of connected equipment compatible with "Control for HDMI."

Device Control Keys

Select button functions of the TV's remote control to operate the connected equipment.

None

For basic operations, such as navigation buttons (up, down, left or right, etc).

Tuning Keys

For basic operations and operation of channel-related buttons, such as CH +/- or 0 - 9, etc.
Useful when you control a tuner or set-top box, etc; via the remote control.

Menu Keys

For basic operations and operation of the HOME/OPTIONS buttons.
Useful when you select menus of a BD player, etc; via the remote control.

Tuning and Menu Keys

For basic operations and operation of channel-related buttons and HOME/OPTIONS buttons.

[▲ Return to Top](#)

"BRAVIA" TV Features

Watching TV

Using the Home Menu

Fun Features with
Connected Equipment

Parts Description

Troubleshooting

Index

[➔ i-Manual online map](#)

Info Banner

Displays information about the currently viewed TV channel and program.

[▲ Return to Top](#)

"BRAVIA" TV Features

Watching TV

Using the Home Menu

Fun Features with
Connected Equipment

Parts Description

Troubleshooting

Index

[→ i-Manual online map](#)

Initial Setup

Runs the initial setup that appeared when you first connected the TV. Follow the instructions on the screen. This setting is useful when you change the settings after moving to a new residence, or when you search for newly launched channels.

[▲ Return to Top](#)

"BRAVIA" TV Features

Watching TV

Using the Home Menu

Fun Features with
Connected Equipment

Parts Description

Troubleshooting

Index

[→ i-Manual online map](#)

Key Tone

Select "On" to play sounds as you navigate with the remote control.



- When you select "Off," the TV start-up sound is also turned off.

[▲ Return to Top](#)

"BRAVIA" TV Features

Watching TV

Using the Home Menu

Fun Features with
Connected Equipment

Parts Description

Troubleshooting

Index

[→ i-Manual online map](#)

Language

Select the language displayed on the menu screens.

[▲ Return to Top](#)

"BRAVIA" TV Features

Watching TV

Using the Home Menu

Fun Features with
Connected Equipment

Parts Description

Troubleshooting

Index

[→ i-Manual online map](#)

Media Server Troubleshooting

Diagnoses whether the TV can connect to each server on the home network.

[▲ Return to Top](#)

[Top Page](#) > [Using the Home Menu](#) > [Network](#) > Network Setup (Follow Wired Setup > Custom.)

"BRAVIA" TV Features

Watching TV

Using the Home Menu

Fun Features with
Connected Equipment

Parts Description

Troubleshooting

Index

[→ i-Manual online map](#)

Network Setup (Follow Wired Setup > Custom.)

IP Address Setting

Select "Manual" to set the IP address manually, or "Auto" to set it automatically.

IP Address/Subnet Mask/Default Gateway/Primary DNS/Secondary DNS

Configure each item when "Manual" is selected in "IP Address Setting."

MAC Address:

Displays the MAC address, which is a fixed, globally unique identifier of the network device.

Proxy Server

Configure the proxy server name and port number if you use a proxy server.

Network (SSID)

Select SSID (network name) of the target router.

Security

Select an appropriate security key.

[▲ Return to Top](#)

"BRAVIA" TV Features

Watching TV

Using the Home Menu

Fun Features with
Connected Equipment

Parts Description

Troubleshooting

Index

[→ i-Manual online map](#)

i-Manual

Displays the on-screen instruction manual (this manual).



- Some features can be started directly from the i-Manual. Press  to start the feature when "Use this feature" is displayed at the bottom of the screen.

[▲ Return to Top](#)

"BRAVIA" TV Features

Watching TV

Using the Home Menu

Fun Features with
Connected Equipment

Parts Description

Troubleshooting

Index

[→ i-Manual online map](#)

Picture Adjustments Lock

Prevents the picture adjustments from being changed.

[▲ Return to Top](#)

"BRAVIA" TV Features

Watching TV

Using the Home Menu

Fun Features with
Connected Equipment

Parts Description

Troubleshooting

Index

[→ i-Manual online map](#)

Quick Start

Turns the TV on faster than usual when TV| is pressed on the remote control. Up to three time periods can be set. When you set "Smart Mode" to "On", the TV recognizes the time periods when you watch TV the most and will turn on faster.



- If "Quick Start" is set, power consumption may increase.

[▲ Return to Top](#)

"BRAVIA" TV Features

Watching TV

Using the Home Menu

Fun Features with
Connected Equipment

Parts Description

Troubleshooting

Index

[→ i-Manual online map](#)

Recommendation

Searches for and shows programs you may like under "Recommendations" in "Favorites."

[▲ Return to Top](#)

"BRAVIA" TV Features

Watching TV

Using the Home Menu

Fun Features with
Connected Equipment

Parts Description

Troubleshooting

Index

[→ i-Manual online map](#)

Region

Select your location to receive services from Internet content providers as well as TV Guide program data.

[▲ Return to Top](#)

"BRAVIA" TV Features

Watching TV

Using the Home Menu

Fun Features with
Connected Equipment

Parts Description

Troubleshooting

Index

[→ i-Manual online map](#)

Renderer

Renderer

Enables the TV to playback photo/music/video files located on other control devices, such as a digital still camera or mobile phone, using those control devices via the network.

Renderer Access Control

Select "Allow" to allow access from a specified control device.

Renderer Options

"Auto Access Permission" permits access to the TV automatically when a control device accesses the TV for the first time.

When "Smart Select" is set to "On," the TV can respond to infrared signals sent from control devices.

You can set the name of the TV shown on the control device in "Renderer Name."

[▲ Return to Top](#)

"BRAVIA" TV Features

Watching TV

Using the Home Menu

Fun Features with
Connected Equipment

Parts Description

Troubleshooting

Index

[→ i-Manual online map](#)

Scene Select

Optimizes picture and sound quality by selecting the following items.



- When you set "Theater Mode" to "On," "Scene Select" is automatically set to "Cinema."

Cinema

Optimizes picture scenes and sound just like those in a theater.

Sports

Presents realistic pictures and sound just like those in a stadium.

Photo

Reproduces the texture and color of a printed photo.



- "Photo" is available only when the input signal is 1080i/p (except broadcast signal).

Music

Lets you experience dynamic and clear sound just like at a concert.

Game

Broadens your game-playing experience with superb picture and sound quality.

Graphics

Eases prolonged monitor viewing with clearer detailed pictures.

General

Optimized to view general content.

Auto

Automatically optimizes picture and sound quality according to the input source.

[▲ Return to Top](#)

"BRAVIA" TV Features

Watching TV

Using the Home Menu

Fun Features with
Connected Equipment

Parts Description

Troubleshooting

Index

[→ i-Manual online map](#)

Screen (for PC input)

Auto Adjust

Automatically adjusts the display position, and phase of the picture in PC mode.



- "Auto Adjust" may not work well with certain input signals. In such cases, manually adjust "Phase," "Pitch," "H Center," and "V Center."

Reset

Resets all PC screen settings to factory settings.

Phase

Adjusts the phase when the screen flickers.

Pitch

Adjusts the pitch when the picture has unwanted vertical stripes.

H Center

Adjusts the horizontal position of the picture.

V Center

Adjusts the vertical position of the picture.

Wide Mode

Select "Normal" to display the original picture, "Full 1" to enlarge the picture to fill the display area maintaining its original, or "Full 2" to enlarge the picture to fill the display area.

[▲ Return to Top](#)

"BRAVIA" TV Features

Watching TV

Using the Home Menu

Fun Features with
Connected Equipment

Parts Description

Troubleshooting

Index

[→ i-Manual online map](#)

Screen (for inputs other than a PC)

Setting Memory

Select an input to make custom screen settings. Select "Common" to apply common screen settings to all inputs.



- Available inputs may vary depending on your region/country.

Wide Mode



- "H Stretch" is available depending on your region/country.

Wide Zoom

Fills the screen with minimum distortion.

Normal

Displays the 4:3 picture in its original size. Side bars are shown to fill the 16:9 screen.

Full

Enlarges the picture horizontally to fill the screen when the original source is 4:3.

When the original source is 16:9 (High-definition source), select this item to display the 16:9 picture in its original size.

H Stretch

Enlarges the picture horizontally to fill the screen when the original source is 16:9 screen.

It is useful for HD channels with 4:3 content.

Zoom

Displays the cinemascopic (letter box format) picture in the correct proportion.

Auto Wide

Automatically changes "Wide Mode" to match the input signal.

4:3 Default

Sets the default screen format for a 4:3 broadcast.

Auto Display Area

Automatically adjusts the picture to the most appropriate display area.

Display Area

Adjusts the picture display area. Select "Full Pixel" to display the original picture when parts of the picture are cut, "+1" to display the original picture, "Normal" to display the recommended size picture, or "-1" to enlarge the picture.



- "Full Pixel" is available depending on the TV model.

Screen Position

Adjusts the vertical position and horizontal position of the picture.

Vertical Size

Adjusts the vertical size of the picture.

[▲ Return to Top](#)

"BRAVIA" TV Features

Watching TV

Using the Home Menu

Fun Features with
Connected Equipment

Parts Description

Troubleshooting

Index

[→ i-Manual online map](#)

Show/Hide Media Servers

Displays the connected server list. You can select the server to display in the Home Menu.

[▲ Return to Top](#)

"BRAVIA" TV Features

Watching TV

Using the Home Menu

Fun Features with
Connected Equipment

Parts Description

Troubleshooting

Index

[→ i-Manual online map](#)

Show/Hide Channels

Select channels to show or hide when you surf with the CH +/- button or in the channel list on the "XMB."

[▲ Return to Top](#)

"BRAVIA" TV Features

Watching TV

Using the Home Menu

Fun Features with
Connected Equipment

Parts Description

Troubleshooting

Index

[→ i-Manual online map](#)

Signal Diagnostics

Select to view the diagnostics information for the current signal.

[▲ Return to Top](#)

"BRAVIA" TV Features

Watching TV

Using the Home Menu

Fun Features with
Connected Equipment

Parts Description

Troubleshooting

Index

[→ i-Manual online map](#)

Automatic Software Update

Updates the TV software automatically through your existing antenna/cable/Internet (when available).

To always keep the software updated to the newest version, it is recommended to have this menu item set to "On."



- "Automatic Software Update" through the Internet is available only on certain TV models.
- The software updates when the TV is in standby mode.
- If performing an update, your TV may take up to several minutes to turn on.

[▲ Return to Top](#)

"BRAVIA" TV Features

Watching TV

Using the Home Menu

Fun Features with
Connected Equipment

Parts Description

Troubleshooting

Index

[→ i-Manual online map](#)

Sound Adjustments



- "Equalizer" is available depending on your region/country.

Setting Memory

Select an input to make custom sound settings. Select "Common" to apply common sound settings to all inputs.



- Available inputs may vary depending on your region/country.

Sound Mode

Dynamic

Enhances the treble and bass sound to make sound clear.

Standard

Provides natural sound.

Clear Voice

Makes voice clearer by lowering background sound.

Custom

For customized sound settings.



- "Custom" is available depending on your region/country.

Reset

Resets all the "Sound Adjustments" settings to the factory settings excluding "Setting Memory" and "Sound Mode."

Treble

Adjusts higher-pitched sounds.

Bass

Adjusts lower-pitched sounds.

Balance

Emphasizes the left or right speaker.

Surround

S-FORCE Front Surround

Virtually reproduces realistic sound.

Sports

Delivers surround effects that make you feel like you are watching a live sports event.

Music

Delivers surround effects that make you feel like you are in a music hall.

Cinema

Delivers surround effects just like the high-grade audio systems found in movie theaters.

Game

For virtual game world experience.

Simulated Stereo

Adds a surround-like effect to monaural programs.

Off

Turns off "Surround."



- "Simulated Stereo" is available depending on your region/country.
- Before selecting "Surround," be sure to set menu items in "Scene Select" according to your target program type to obtain surround effects.

Sound Enhancer

Reproduces clear sound by complementing high-frequency bands.

Equalizer

Adjusts the frequency response.

Steady Sound

Keeps volume level constant across all programs and advertisements (e.g. Advertisements tend to be louder than programs).

Volume Offset

Adjusts the current volume level relative to other inputs, when "Setting Memory" is set to the current input.

[▲ Return to Top](#)

"BRAVIA" TV Features

Watching TV

Using the Home Menu

Fun Features with
Connected Equipment

Parts Description

Troubleshooting

Index

[→ i-Manual online map](#)

Speakers

Select TV speakers or external audio system connected to the TV to output TV sound.



- To use multi-channel audio, select external audio system and connect optical out for equipment compatible with Dolby Digital.
- "Audio System" must be selected to listen to 5.1 multi-channel audio.

[▲ Return to Top](#)

"BRAVIA" TV Features

Watching TV

Using the Home Menu

Fun Features with
Connected Equipment

Parts Description

Troubleshooting

Index

[→ i-Manual online map](#)

Refresh Internet Content

For reconnection to the Internet to receive available Internet content services.

[▲ Return to Top](#)

"BRAVIA" TV Features

Watching TV

Using the Home Menu

Fun Features with
Connected Equipment

Parts Description

Troubleshooting

Index

[➔ i-Manual online map](#)

USB Auto Start

Select "Slideshow" or "Thumbnail View" to start photo playback automatically.



- Be sure to turn on the TV before connecting a USB device to the TV.

[▲ Return to Top](#)

"BRAVIA" TV Features

Watching TV

Using the Home Menu

Fun Features with
Connected Equipment

Parts Description

Troubleshooting

Index

[→ i-Manual online map](#)

Video 1/Component 1 Selection

Switches between Component 1 input and Video 1 input.

If you select "Auto," the TV detects the terminal connection signal and switches to either Component 1 or Video 1.



- You cannot use Component 1 and Video 1 at the same time.

[▲ Return to Top](#)

"BRAVIA" TV Features

Watching TV

Using the Home Menu

Fun Features with
Connected Equipment

Parts Description

Troubleshooting

Index

[→ i-Manual online map](#)

Audio Out

Select "Fixed" to adjust volume with an audio system's remote control, or "Variable" to adjust volume with the TV's remote control, when using an external audio system.

[▲ Return to Top](#)

Free Manuals Download Website

<http://myh66.com>

<http://usermanuals.us>

<http://www.somanuals.com>

<http://www.4manuals.cc>

<http://www.manual-lib.com>

<http://www.404manual.com>

<http://www.luxmanual.com>

<http://aubethermostatmanual.com>

Golf course search by state

<http://golfingnear.com>

Email search by domain

<http://emailbydomain.com>

Auto manuals search

<http://auto.somanuals.com>

TV manuals search

<http://tv.somanuals.com>