

**SONY**<sup>®</sup>

4-101-456-21(1)



**FD Trinitron**  
**WEGA**<sup>®</sup>

---

Operating Instructions

KV-27FS120

© 2004 by Sony Corporation



## WARNING

To reduce the risk of fire or electric shock, do not expose the TV to rain or moisture.

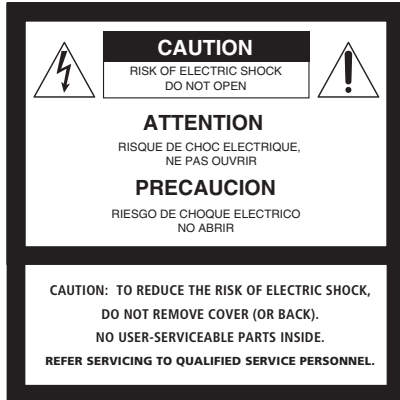

This symbol is intended to alert the user to the presence of uninsulated "dangerous voltage" within the product's enclosure that may be of sufficient magnitude to constitute a risk of electric shock to persons.



This symbol is intended to alert the user to the presence of important operating and maintenance (servicing) instructions in the literature accompanying the appliance.

### Note to the CATV Installer

This reminder is provided to call the CATV system installer's attention to Article 820-40 of the NEC that provides guidelines for proper grounding and, in particular, specifies that the cable ground shall be connected to the grounding system of the building as close to the point of cable entry as practical.

### SAFETY PRECAUTIONS

- Operate the TV only on 120 V AC.
- One blade of the power plug is wider than the other for safety purposes and will fit into the power outlet only one way. If you are unable to insert the plug fully into the outlet, contact your dealer.
- If any liquid or solid object falls into the TV, unplug it and have it checked by qualified personnel before operating it further.

### CAUTION

When using TV games, computers, and similar products with your TV, keep the brightness and contrast functions at low settings. If a fixed (non-moving) pattern is left on the screen for long periods of time at a high brightness or contrast setting, the image can be permanently imprinted onto the screen. Continuously watching the same channel can cause the imprint of station logos onto the TV screen. These types of imprints are not covered by your warranty because they are the results of misuse.



To reduce the risk of electric shock, do not use this polarized plug with an extension cord, receptacle, or other outlet unless the blades can be fully inserted to prevent blade exposure.



You are cautioned that any changes or modifications not expressly approved in this manual could void your authority to operate this equipment.

### NOTIFICATION

This equipment has been tested and found to comply with the limits for a Class B digital device pursuant to Part 15 of the FCC Rules. These limits are designed to provide reasonable protection against harmful interference in a residential installation. This equipment generates, uses, and can radiate radio frequency energy and, if not installed and used in accordance with the instructions, may cause harmful interference with radio communications. However, there is no guarantee that interference will not occur in a particular installation. If this equipment does cause harmful interference to radio or television reception, which can be determined by turning the equipment off and on, the user is encouraged to try to correct the interference by one or more of the following measures:

- Reorient or relocate the receiving antennas.
- Increase the separation between the equipment and receiver.
- Connect the equipment into an outlet on a circuit different from that to which the receiver is connected.
- Consult the dealer or an experienced radio/TV technician for help.

### Protecting the TV

- To prevent internal heat build-up, do not block the ventilation openings.
- Do not install the TV in a hot or humid place, or in a place subject to excessive dust or mechanical vibration.

### Note on Caption Vision

This television receiver provides display of television closed captioning in accordance with § 15.119 of the FCC rules. Use of this television for other than private viewing of programs broadcast on UHF or VHF or transmitted by cable companies for the use of the general public may require authorization from the broadcaster-cable company and/or program owner.

### Owner's Record

The model and serial numbers are located on the front cover of this manual and at the rear of your TV.

### Trademarks and Copyrights

ENERGY STAR is a registered mark.



As an ENERGY STAR® Partner, Sony has determined that this product or product model meets the ENERGY STAR® guidelines for energy efficiency.



SRS and the (●)® symbol are trademarks of SRS Labs, Inc.



Manufactured under license from BBE Sound, Inc. Licensed by BBE Sound, Inc. under USP 4638258, 5510752 and 5736897. BBE and BBE symbol are registered trademarks of BBE Sound, Inc.

WEGA, FD Trinitron, ClearEdge VM, Steady Sound and Caption Vision are registered trademarks of Sony Corporation.

# IMPORTANT SAFEGUARDS

For your protection, please read these instructions completely, and keep this manual for future reference. Carefully observe and comply with all warnings, cautions and instructions placed on the set, or described in the operating instructions or service manual.

## WARNING

To guard against injury, the following basic safety precautions should be observed in the installation, use, and servicing of the set.

## Use

### Power Sources

This set should be operated only from the type of power source indicated on the serial/model plate. If you are not sure of the type of electrical power supplied to your home, consult your dealer or local power company. For those sets designed to operate from battery power, refer to the operating instructions.



### Grounding or Polarization

This set may be equipped with a polarized alternating current line plug (a plug having one blade wider than other). This plug will fit into the power outlet only one way. This is a safety feature. If you are unable to insert the plug fully into the outlet, try reversing the plug. If the plug still fails to fit, contact your electrician to replace your obsolete outlet. Do not defeat the safety purpose of the polarized plug.



### For the set with a three-wire grounding type AC plug

This plug will only fit into a grounding-type power outlet. This is a safety feature. If you are unable to insert the plug into the outlet, contact your electrician to have a suitable outlet installed. Do not defeat the safety purpose of the grounding plug.

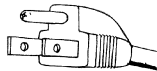

### Overloading

Do not overload wall outlets, extension cords or convenience receptacles beyond their capacity, since this can result in fire or electric shock.

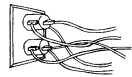

Always turn the set off when it is not to be used. When the set is left unattended and unused for long periods of time, unplug it from the wall outlet as a precaution against the possibility of an internal malfunction that could create a fire hazard.

Do not disconnect the antenna or the power cord during a heavy storm. Lightning may strike while you are holding the cable or cord, causing serious injury. Turn off your TV and wait for the weather to improve.

### Object and Liquid Entry

Never push objects of any kind into the set through the cabinet slots as they may touch dangerous voltage points or short out parts that could result in a fire or electric shock. Never spill liquid of any kind on the set.



## Attachments

Do not use attachments not recommended by the manufacturer, as they may cause hazards.

Do not place any objects, especially heavy objects, on top of the set. The object may fall from the set, causing injury.

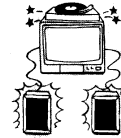

## Cleaning

Unplug the set from the wall outlet before cleaning or polishing it. Do not use liquid cleaners or aerosol cleaners. Use a cloth lightly dampened with water for cleaning the exterior of the set.



If a snapping or popping sound from a TV set is continuous or frequent while the TV is operating, unplug the TV and consult your dealer or service technician. It is normal for some TV sets to make occasional snapping or popping sounds, particularly when being turned on or off.



## Installation

Always use two or more people to lift or move the set. The set is heavy and the bottom surface is flat. Serious injury can result from trying to move the set by yourself alone, or from unsteady handling.

Install the set on a stable, level surface.

## Water and Moisture

Do not use power-line operated sets near water — for example, near a bathtub, washbowl, kitchen sink, or laundry tub, in a wet basement, or near a swimming pool, etc.



## Accessories

Do not place the set on an unstable cart, stand, tripod, bracket, table, or shelf. The set may fall, causing serious injury to a child or an adult, and serious damage to the set. Use only a cart or stand recommended by the manufacturer for the specific model of TV. Any mounting of the product should follow the manufacturer's instructions, and should use a mounting accessory recommended by the manufacturer. An appliance and cart combination should be moved with care. Quick stops, excessive force, and uneven surfaces may cause the appliance and cart combination to overturn.



Quick stops, excessive force, and uneven surfaces may cause the appliance and cart combination to overturn.

## Ventilation

The slots and openings in the cabinet and in the back or bottom are provided for necessary ventilation. To ensure reliable operation of the set, and to protect it from overheating, these slots and openings must never be blocked or covered.

- Never cover the slots and openings with a cloth or other materials.



- Never block the slots and openings by placing the set on a bed, sofa, rug or other similar surface.

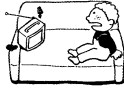

- Never place the set in a confined space, such as a bookcase or built-in cabinet, unless proper ventilation is provided.



- Do not place the set near or over a radiator or heat register, or where it is exposed to direct sunlight.



### Power-Cord Protection

Do not allow anything to rest on or roll over the power cord, and do not place the set where the power cord is subject to wear or abuse.

### Antennas

#### Outdoor Antenna Grounding

If an outdoor antenna is installed, follow the precautions below. An outdoor antenna system should not be located in the vicinity of overhead power lines or other electric light or power circuits, or where it can come in contact with such power lines or circuits.

WHEN INSTALLING AN OUTDOOR ANTENNA SYSTEM, EXTREME CARE SHOULD BE TAKEN TO KEEP FROM CONTACTING SUCH POWER LINES OR CIRCUITS AS CONTACT WITH THEM IS ALMOST INVARIABLY FATAL.

Be sure the antenna system is grounded so as to provide some protection against voltage surges and built-up static charges. Section 810 of the National Electrical Code (NEC) in USA and Section 54 of the Canadian Electrical Code in Canada provides information with respect to proper grounding of the mast and supporting structure, grounding of the lead-in wire to an antenna discharge unit, size of grounding conductors, location of antenna discharge unit, connection to grounding electrodes, and requirements for the grounding electrode.

#### Antenna Grounding According to the NEC

Antenna Grounding According to the National Electrical Code, ANSI/NFPA 70.

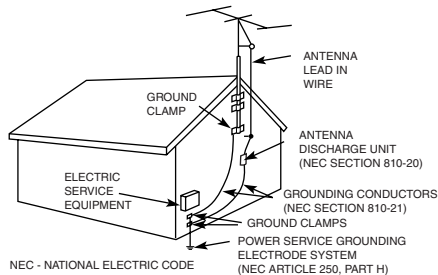

### Lightning

For added protection for this television receiver during a lightning storm, or when it is left unattended and unused for long periods of time, unplug it from the wall outlet and disconnect the antenna. This will prevent damage to the receiver due to lightning and power-line surges.

## Service

### Damage Requiring Service

Unplug the set from the wall outlet and refer servicing to qualified service personnel under the following conditions:

- When the power cord or plug is damaged or frayed.

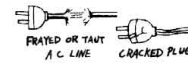

- If liquid has been spilled into the set or objects have fallen into the product.



- If the set has been exposed to rain or water.



- If the set has been subject to excessive shock by being dropped, or the cabinet has been damaged.

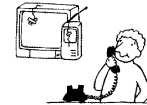

- If the set does not operate normally when following the operating instructions. Adjust only those controls that are specified in the operating instructions. Improper adjustment of other controls may result in damage and will often require extensive work by a qualified technician to restore the set to normal operation.

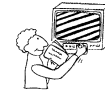

- When the set exhibits a distinct change in performance — this indicates a need for service.

### Service

Do not attempt to service the set yourself since opening the cabinet may expose you to dangerous voltage or other hazards. Refer all servicing to qualified service personnel.



### Replacement Parts

When replacement parts are required, be sure the service technician certifies in writing that he has used replacement parts specified by the manufacturer that have the same characteristics as the original parts. Unauthorized substitutions may result in fire, electric shock, or other hazards.



### Safety Check

Upon completion of any service or repairs to the set, ask the service technician to perform routine safety checks (as specified by the manufacturer) to determine that the set is in safe operating condition, and to so certify. When the set reaches the end of its useful life, improper disposal could result in a picture tube implosion. Ask a qualified service technician to dispose of the set.





# Contents

## Introduction

Introducing the FD Trinitron WEGA® Features.....	1
About this Manual.....	2
Batteries for the Remote Control .....	2
Front Panel Menu Controls .....	2

## Using the Remote Control

Remote Control Description.....	3
Programming the Remote Control.....	5
Manufacture's Codes.....	6
Using your TV Remote Control with Other Equipment.....	7







## Connecting Your TV

TV Rear Panel.....	9
Basic Connections .....	11
Connecting Additional Equipment.....	12

## Using Basic Functions

Setting Up the TV.....	23
Quick Start to the Menus .....	24

## Using the Menus

How to Access Menus.....	27
Using the Video  Menu.....	28
Using the Audio  Menu .....	29
Using the Channel  Menu.....	31
Using the Parent  Menu .....	33
Parental Control.....	34
United States: Selecting Custom Rating Options.....	36
Canada: Selecting Custom Rating Options.....	38
Using the Timer  Menu .....	39
Using the Setup  Menu.....	40

## Other Information

Troubleshooting.....	41
Specifications.....	45

Index.....	47
------------	----





# Introduction

Congratulations on your purchase of the Sony FD Trinitron WEGA®.

## Introducing the FD Trinitron WEGA® Features

Some of the features you will enjoy include:

- ❑ **FD Trinitron Flat CRT** — Delivers a picture with uncompromising accuracy and outstanding image detail via a technologically advanced tube.
- ❑ **Y, P<sub>B</sub>, P<sub>R</sub> Inputs** — Provides component video inputs for superior picture quality (480i only).
- ❑ **BBE** — Gives sound more impact by using audio technology to compensate for phase effects in speakers.
- ❑ **SRS** — Produces a dynamic three-dimensional sound for stereo programs.
- ❑ **ClearEdge VM** — Sharpens picture definition to give objects a crisp, clean edge.
- ❑ **Favorite Channels** — Provides instant access to your favorite channels with the touch of a button.
- ❑ **Info Banner** — Displays the name and the remaining time of the current program viewed, if available.
- ❑ **Universal Remote Control** — Operates your connected cable box, VCR, digital satellite receiver, DVD player, or DVD/VCR combination unit.
- ❑ **Energy Star®** — Meets the Energy Star guidelines for energy efficiency.
- ❑ **Parental Control (V-Chip)** — Helps parents monitor what their children watch on TV by establishing rating limits.
- ❑ **Front Panel Controls** — Allows access to the on-screen menus without the use of a remote control.
- ❑ **Front A/V Inputs** — Lets you quickly connect video games, camcorders or stereo/mono equipment.
- ❑ **16:9 Enhanced** — Provides enhanced picture resolution for wide-screen sources such as DVD.

## About this Manual

This manual provides instructions to help you enjoy your new TV. It shows you how to connect to an antenna or cable, cable box, VCR, DVD, satellite receiver, stereo system, or camcorder. Once your TV is connected, follow the instructions and use the remote control to access the on-screen menus.

## Batteries for the Remote Control

Insert two AA (R6) batteries (supplied) into the remote control using the following illustration as a guide.

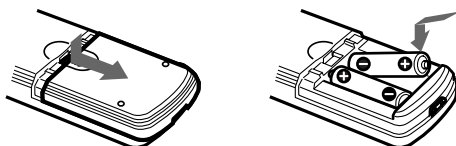



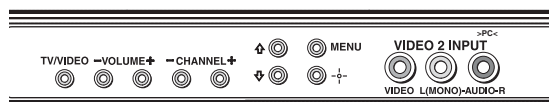

 Under normal conditions, batteries will last up to six months. If the remote control does not operate properly, the batteries might be worn out.

 If you will not be using the remote control for an extended period of time, remove the batteries to avoid possible damage from battery leakage.

## Front Panel Menu Controls













The front Audio/Video panel controls allow you to access the menu without the remote control.

- Press  to display the on-screen menu.
- Use the  and  buttons on the front Audio/Video panel instead of your remote control.
- Use the  button on the front Audio/Video panel to navigate through the menus, then select an item. The front panel controls also allow you to change your channels (CH+/-), adjust the volume (VOL +/-), and change video inputs.

 To navigate the menus with your remote control, see "Using the Menus" on page 27.

# Using the Remote Control

## Remote Control Description

Button	Description
 <b>1 MUTING</b>	Press to turn off the sound. Press again or press  to restore sound.
 <b>2 SYSTEM OFF</b>	Press to turn off the equipment programmed into the remote control. See "Programming the Remote Control" on page 5. This button does not work with DVD/VCR combo units, and may not work with older Sony equipment.
 <b>3 TV/VCR/DVD</b>	Press to change the VHF/UHF output of the VCR (or DVD/VCR combination unit). If you have a non-Sony VCR or DVD, you will need to program the remote control to recognize your VCR or DVD. For details, see "Programming the Remote Control" on page 5.
 <b>4 PICTURE MODE</b>	Press repeatedly to step through the available video picture modes: Vivid, Standard, Movie and Pro. Also available in the Video menu. See "Using the Video Menu" on page 28 for details.
 <b>5 SLEEP</b>	Press repeatedly until the TV displays the time in minutes (15, 30, 45, 60, or 90) that you want the TV to remain on before shutting off automatically. Cancel by pressing until Sleep Off appears. While the Sleep feature is set, press once to view the remaining time.
 <b>6 JUMP</b>	Press to jump back and forth between two channels. The TV alternates between the current channel and the last channel that you selected. JUMP will not work if any FUNCTION Mode (VCR/DVD, SAT/CABLE, TV) is activated.
 <b>7 TV/SAT</b>	Press to switch between the TV and SAT (satellite) inputs when in SAT FUNCTION mode.
 <b>8 RESET</b>	Press for a direct selection of Effect settings (Simulated, SRS, Off) when the remote is in TV FUNCTION mode. See "Using the Audio Menu" on page 29 for details.
 <b>8 RESET</b>	Press to return to factory settings while in an on-screen menu.
 <b>9 VOL (volume)</b>	Press (+) or (-) to adjust the volume.

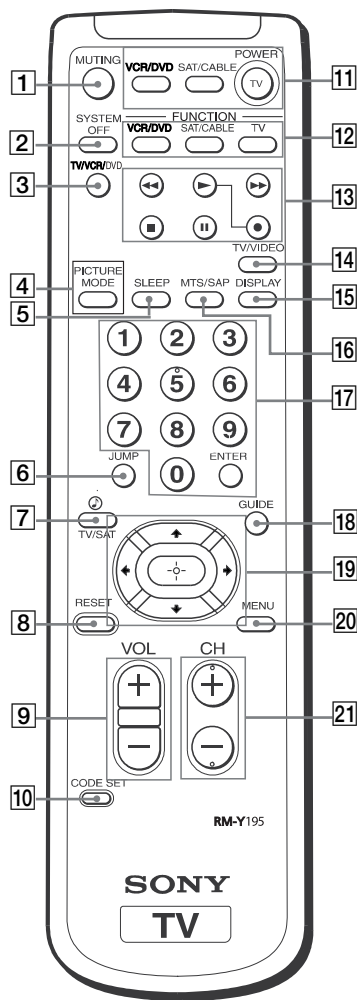

Button	Description
10 <b>CODE SET</b>	Press to program your remote control to operate connected video equipment. See "Programming the Remote Control" on page 5.
11 <b>POWER buttons</b>	Press to turn on and off the TV and other audio/video equipment you have programmed into the remote control. For instructions, see "Programming the Remote Control" on page 5.
12 <b>FUNCTION buttons</b>	Press to select the equipment (VCR/DVD, SAT/CABLE, TV) that you want to operate with the remote control. The indicator (LED) lights up momentarily when pressed to show which device the remote control is operating.
13 <b>VCR (operating)</b>	Press to operate your VCR. The VCR must be programmed into the remote control. For instructions, see "Programming the Remote Control" on page 5.
14 <b>TV/VIDEO</b>	Press to cycle through available video inputs.
15 <b>DISPLAY</b>	Press once to display the current time (if set) and the program status such as channel number, Channel Label (if set), video input, and Video Label (if set). Press again to turn off the display.
16 <b>MTS/SAP</b>	Press to cycle through the Multi-channel TV Sound (MTS) options: Stereo, Auto SAP (Second Audio Programming), and Mono.
17 <b>0-9 and ENTER</b>	Press to change channels. The channel changes after two seconds.
18 <b>GUIDE</b>	Press to display the program guide of your satellite receiver.
19 	Press the arrow buttons to move the cursor in the on-screen menus. Press the center button to select an option.
20 <b>MENU</b>	Press to display the on-screen menu. Press again to exit the menu at any time.
21 <b>CH (channel)</b>	Press to change channels. To scan rapidly through the channels, press and hold down the CH+ or CH- button.





 If you lose your remote control, see page 42.

## Programming the Remote Control

If you have video equipment other than Sony brand (or if you have a Sony DVD/VCR combination unit) that you want to control with the TV's remote control, use the following procedure to program the remote control.



- 1 Check the list of "Manufacturer's Codes" on page 6 and find the three-digit code number for the manufacturer of your component. If more than one code number is listed, use the number listed first.

- 2 Press .

 The  and  FUNCTION button will flash when you press .

- 3 Press  or  FUNCTION button to indicate the type of component you want to program with the remote control.

 You must do step 4 within 10 seconds of step 3, or you must redo steps 2 and 3.

- 4 Use the - buttons to enter the three-digit manufacturer's code number.

- 5 Press .

- 6 To check if the code number works, aim the TV's remote control at the component and press on the green POWER button (VCR/DVD, SAT/CABLE, TV) that corresponds with that component. If it responds, you are done. If not try using another code listed for that manufacturer.

 If you have problems programming your remote control, see "Troubleshooting" on page 42.

**Manufacturer's Codes****VCRs**

<b>Manufacturer</b>	<b>Code</b>
Sony	301, 302, 303
Admiral (M. Ward)	327
Aiwa	338, 344
Audio Dynamic	314, 337
Broksonic	319, 317
Canon	309, 308
Citizen	332
Craig	302, 332
Criterion	315
Curtis Mathes	304, 338, 309
Daewoo	341, 312, 309
DBX	314, 336, 337
Dimensia	304
Emerson	319, 320, 316, 317, 318, 341
Fisher	330, 335
Funai	338
General Electric	329, 304, 309
Go Video	322, 339, 340
Goldstar	332
Hitachi	306, 304, 305, 338
Instant Replay	309, 308
JC Penney	309, 305, 304, 330, 314, 336, 337
JVC	314, 336, 337, 345, 346, 347
Kenwood	314, 336, 332, 337
LXI (Sears)	332, 305, 330, 335, 338
Magnavox	308, 309, 310
Marantz	314, 336, 337
Marta	332
Memorex	309, 335
Minolta	305, 304
Mitsubishi/ MGA	323, 324, 325, 326
Multitech	325, 338, 321
NEC	314, 336, 337
Olympic	309, 308
Optimus	327
Panasonic	308, 309, 306, 307

Pentax	305, 304
Philco	308, 309
Philips	308, 309, 310
Pioneer	308
Quasar	308, 309, 306
RCA/ PROSCAN	304, 305, 308, 309, 311, 312, 313, 310, 329
Realistic	309, 330, 328, 335, 324, 338
Sansui	314
Samsung	322, 313, 321
Sanyo	330, 335
Scott	312, 313, 321, 335, 323, 324, 325, 326
Sharp	327, 328
Shintom	315
Signature 2000 (M. Ward)	338, 327
SV2000	338
Sylvania	308, 309, 338, 310
Symphonic	338
Tashiro	332
Tatung	314, 336, 337
Teac	314, 336, 338, 337
Technics	309, 308
Toshiba	312, 311
Wards	327, 328, 335, 331, 332
Yamaha	314, 330, 336, 337
Zenith	331

**Laserdisc Players**

<b>Manufacturer</b>	<b>Code</b>
Sony	701
Panasonic	704, 710
Pioneer	702

**DVD/VCR Combination Units**

<b>Manufacturer</b>	<b>Code</b>
Sony	601
Broksonic	605
JVC	604
Panasonic	609
Samsung	603
Toshiba	602

**DVD Players**

<b>Manufacturer</b>	<b>Code</b>
Sony	751
Hitachi	758
JVC	756
Magnavox	757
Mitsubishi	761
Onkyo	762
Oritron	759
Panasonic	753
Philips	757
Pioneer	752
RCA	755
Samsung	758
Toshiba	754
Zenith	760

**Cable Boxes**









<b>Manufacturer</b>	<b>Code</b>
Sony	230
Hamlin/Regal	222, 223, 224, 225, 226
Jerrold/G.I./ Motorola	201, 202, 203, 204, 205, 206, 207, 208, 218
Oak	227, 228, 229
Panasonic	219, 220, 221
Pioneer	211, 214, 215
Scientific Atlanta	209, 210, 211
Tocom	216, 217
Zenith	212, 213

**Satellite Receivers**



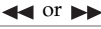

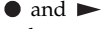





<b>Manufacturer</b>	<b>Code</b>
Sony	801
DIRECT TV	809
Dish Network	810
Echostar	810
General Electric	802
Hitachi	805
Hughes	804
Mitsubishi	809
Panasonic	803
RCA/ PROSCAN	802, 808
Toshiba	806, 807

## Using your TV Remote Control with Other Equipment



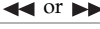

### Operating a VCR

Press	To
	Activate the remote control to operate the VCR (FUNCTION button)
	Power on/off the VCR (VCR/DVD green button)
 or <b>0-9</b> , ENTER (using tuner)	Change channels
	Play video tape
	Stop
	Rewind or Fast-forward a video tape
	Pause
 and  (Simultaneously)	Record
	Switch between VCR and TV inputs





### Operating a DVD Player

Press	To
	Activate the remote control to operate the DVD (FUNCTION button)
	Power on/off the DVD (VCR/DVD green button)
<b>0-9</b> , ENTER	Select chapters
	Search chapters forward or backward
	Play DVD
	Stop
	Pause
	Search the picture forward or backward during playback
	Display the DVD menu
	Use the arrow buttons to move the cursor in the menu, and the center button to select an option
	Switch between DVD and TV inputs















### Operating a Cable Box or Satellite Receiver

Press	To
	Activate the remote control to operate the cable box or satellite receiver (FUNCTION button)
	Power on/off the cable box or satellite receiver (SAT/CABLE green button)
 or <b>0-9</b> , ENTER (using tuner)	Change channels
	Change back to previous channel
	Display channel number (satellite receiver)

### Operating a Cable Box or Satellite Receiver

Press	To
	Display SAT Guide (satellite receiver)
	Display SAT Menu (satellite receiver)
	Use the arrow buttons to move the cursor in the menu, and the center button to select an option (satellite receiver)
	Press to switch between the TV and SAT inputs (satellite receiver)

### Operating a DVD/VCR Combination Unit

Press	To
	Activate the remote control to operate the DVD/VCR (FUNCTION button)
	Power on/off the DVD/VCR combination unit (VCR/DVD green button)
	When the VCR is not playing,  switches between the DVD player and VCR's tuner
	Display the DVD Menu
	Play
	Stop
	Pause
	Rewind or fast-forward a video tape (VCR) Search the picture forward or backward during playback (DVD)
	Use the arrow buttons to move the cursor in the menu, and the center button to select an option (DVD)
 and  (Simultaneously)	Record (VCR)
 or  , ENTER (using tuner)	Change channels (VCR)



# Connecting Your TV

Read this section before setting up your TV for the first time. This section explains how to make the basic connections and how to connect optional equipment.

## TV Rear Panel

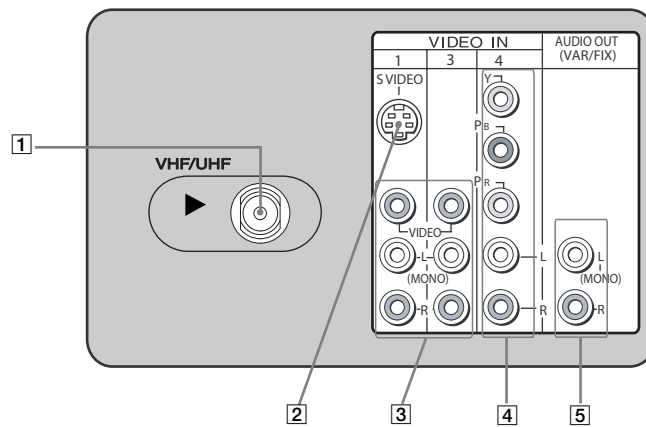

Jack	Description
<b>1 VHF/UHF</b>	This input connects to your VHF/UHF antenna or cable.
<b>2 S VIDEO</b>	This input connects to the S VIDEO OUT jack on your VCR or other video equipment that has S VIDEO. S VIDEO provides better picture quality than the VHF/UHF jacks or the video input jack. S VIDEO does not provide sound, so you still must connect the audio cables.
<b>3 VIDEO/AUDIO L(MONO), R</b>	This input connects to the AUDIO/VIDEO output jacks on your VCR or other video equipment. A third video input jack (VIDEO 2) is located on the front panel of the TV. These AUDIO/VIDEO input jacks provide better picture quality than the VHF/UHF jack.

---

<b>4 Y, P<sub>B</sub>, P<sub>R</sub>/ L, R</b>	This input connects to the component video Y, P <sub>B</sub> , P <sub>R</sub> , and AUDIO L, R jacks on your DVD player or digital set-top box (480i only).
<b>5 AUDIO OUT (VAR/FIX) L(MONO), R</b>	This jack connects to the Audio input jacks on your audio equipment. You can listen to your TV's audio through your stereo system.

---

## Basic Connections

### TV with Cable, Indoor, or Outdoor Antenna

Depending on the cable system available in your home, choose one of the connections below:

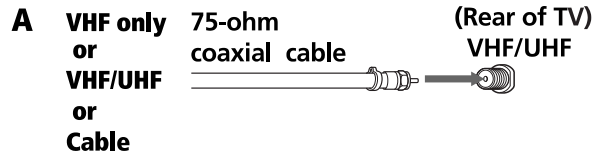

Use this to connect the TV to a cable system or an antenna with a 75-ohm cable (usually built into newer homes).

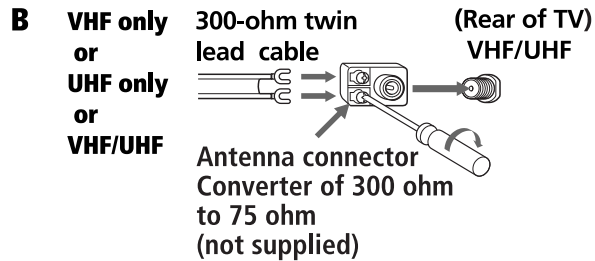

Use this to connect the TV to a dipole antenna, also known as a “rabbit ears” antenna (usually found in older homes).

 If you are connecting to an indoor or outdoor antenna, you may need to adjust the orientation of the antenna for the best reception.

# Connecting Additional Equipment

## Connecting a TV and VCR

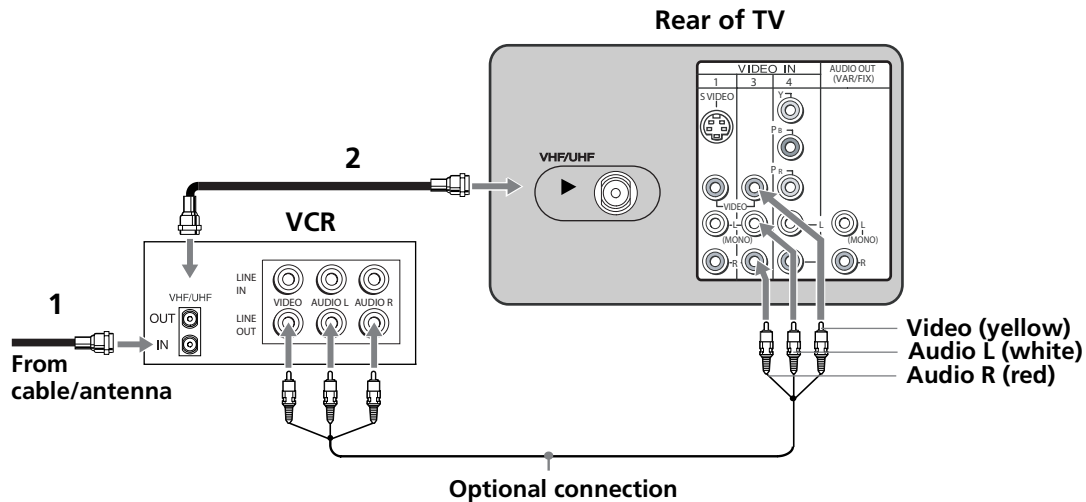



- 1 Connect the coaxial cable from your TV antenna or cable service to the IN jack on your VCR.
- 2 Connect a coaxial cable (not supplied) from the OUT jack on your VCR to the VHF/UHF jack on the TV.

### Optional connection

- ❑ If your VCR is equipped with video outputs, you can get better picture quality by connecting audio/video cables (not supplied) from AUDIO/VIDEO OUT on your VCR to AUDIO/VIDEO IN on your TV.
- ❑ For better picture quality, use S VIDEO instead of the yellow video cable. S VIDEO does not provide sound, so you still must connect the audio cables.

### Using your TV with this connection

This connection allows you to do the following:

- ❑ Program your Sony remote control to operate your VCR (see page 5).
- ❑ To activate your remote, press  (FUNCTION button) to operate your VCR. To do this, first program your remote control, then use the Channel Fix feature to set your TV to channel 3 or 4 (see page 31).
- ❑ Press  repeatedly to switch between VCR input (VIDEO input) and VHF/UHF (local channels).

## TV and Cable Box

Some cable TV systems use scrambled or encoded signals that require a cable box to view all channels. If you subscribe to such type of service, use this connection.

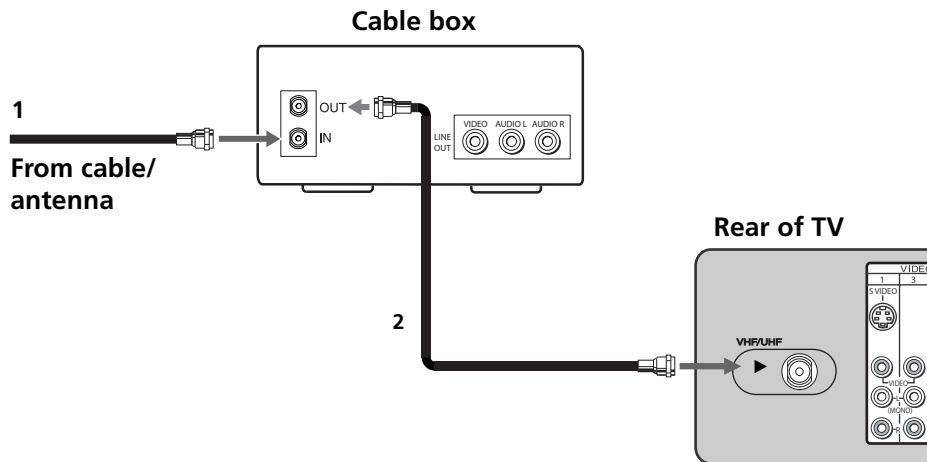

- 1** Connect the coaxial cable from your cable service to the IN jack on your cable box.
- 2** Connect a coaxial cable (not supplied) from the OUT jack on your cable box to the VHF/UHF jack on your TV.

### Using your TV with this connection

This connection allows you to do the following:

- Program your Sony remote control to operate your cable box (see page 5).
- To activate your remote press  (FUNCTION button) to operate your cable box and then use the ①-⑨ buttons or CH+/- buttons to change the channels. In order to do this, first program your remote control, then use the Channel Fix feature to set your TV to channel 3 or 4 (see page 31).

## Connecting a TV, VCR, and Cable Box

 **DIGITAL CABLE BOX USERS:** If you are connecting a digital cable box, you will need a special bi-directional splitter (5-900 Mhz minimum) that is designed to work with your digital cable box.

Use this connection if you subscribe to a cable system that scrambles some channels (pay channels), but not all of them. This setup allows you to:

- change channels through your cable box or VCR when you are receiving a scrambled signal
- change channels through your TV

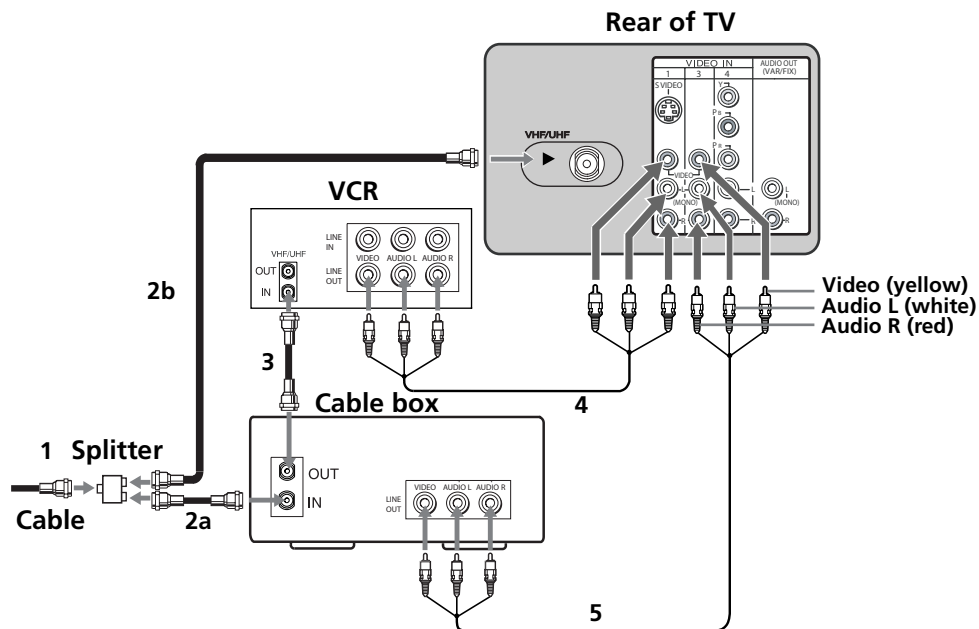



- 1** Connect the single input jack of the splitter (not supplied) to your incoming cable connection.
- 2** Using coaxial cables (not supplied), connect the two output jacks of the splitter (not supplied) to:
  - a)** the IN jack on your cable box
  - b)** the VHF/UHF jack on the TV
- 3** Using a coaxial cable (not supplied), connect the OUT jack on your cable box to the IN jack on your VCR.
- 4** Using the audio/video cables (not supplied), connect the AUDIO VIDEO OUT on your VCR to the AUDIO/VIDEO IN on your TV.
- 5** Using the audio/video cables (not supplied), connect the AUDIO VIDEO OUT on your cable box to the AUDIO/VIDEO IN on your TV.

### Optional connection

- ❑ For better picture quality, use S VIDEO instead of the yellow video cable. S VIDEO does not provide sound, so you still must connect the audio cables.

### Using your TV with this connection

- ❑ Program your Sony remote control to operate your VCR or cable box (see page 5).
- ❑ To activate your remote, press  (FUNCTION button) to operate your VCR or  (FUNCTION button) to operate your cable box. To do this, first program your remote control, then use the Channel Fix feature to set your TV to channel 3 or 4 (see page 31).
- ❑ Press  repeatedly to switch between VCR input (VIDEO input), VHF/UHF (local channels or unscrambled), or cable box (cable system or scrambled channels).

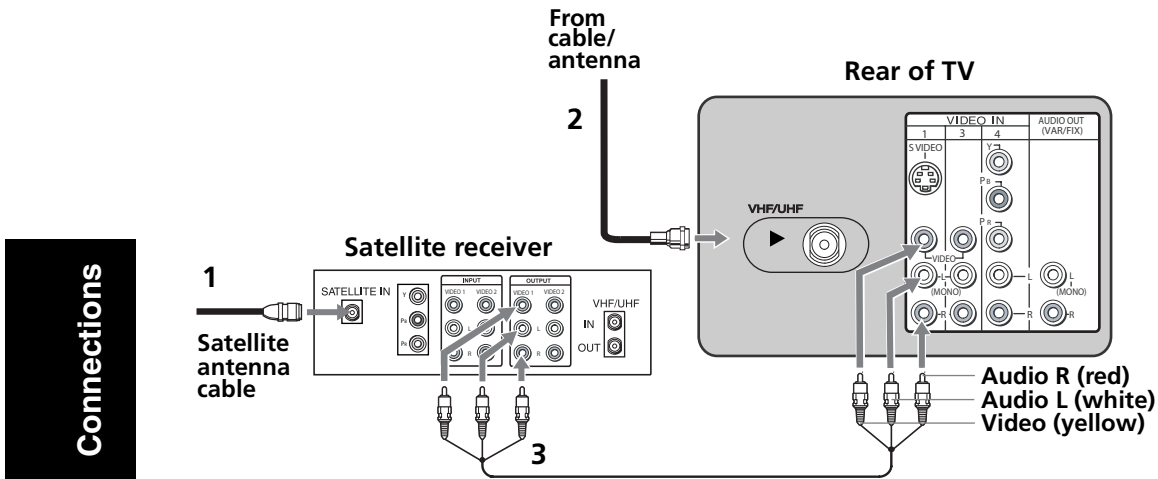

## Connecting a TV and Satellite Receiver



- 1** Connect the cable from your satellite antenna to SATELLITE IN on your satellite receiver.
- 2** Connect the coaxial cable from your cable service or antenna to the VHF/UHF jack on your TV.
- 3** Using audio/video cables (not supplied), connect AUDIO/VIDEO OUT on your satellite receiver to AUDIO/VIDEO IN on your TV.

### Using your TV with this connection

This connection allows you to do the following:

- Program your Sony remote control to operate your satellite receiver (see page 5).
- To activate your remote, press  (FUNCTION button) to operate your satellite receiver. See page 7 on how to operate other functions.
- Press  repeatedly to switch to satellite receiver input (VIDEO input).



## Connecting a TV, VCR, Cable/Antenna, and Satellite Receiver using Composite Video (VIDEO/AUDIO L(MONO), R)

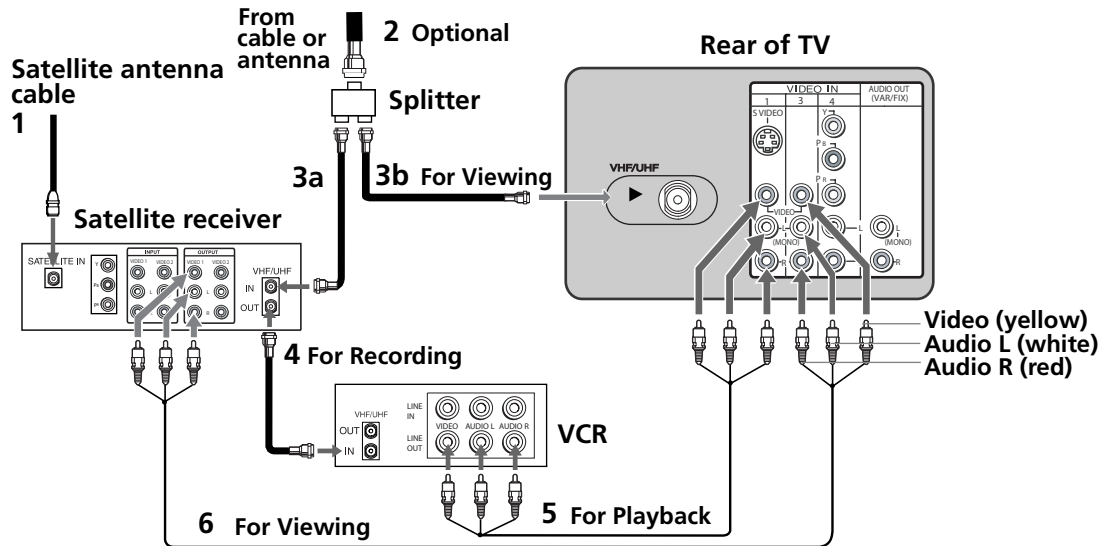

- 1** Connect the cable from your satellite antenna to SATELLITE IN on your satellite receiver.
- 2** Connect the single input jack of the splitter (not supplied) to your incoming cable/antenna (optional connection to view local channels or broadcast).
- 3** Using coaxial cables (not supplied), connect the two output jacks of the splitter (not supplied) to:
  - a)** the IN jack on your satellite receiver
  - b)** the VHF/UHF jack on the TV
- 4** Using a coaxial cable (not supplied), connect the OUT jack on your satellite receiver to the VHF/UHF IN on your VCR.
- 5** Using audio/video cables (not supplied), connect AUDIO/VIDEO OUT on your VCR to the AUDIO/VIDEO IN on your TV.
- 6** Using audio/video cables (not supplied), connect the AUDIO/VIDEO OUT on your satellite receiver to the AUDIO/VIDEO IN on your TV.

### Using your TV with this connection

This connection allows you to do the following:

- Program your Sony remote control to operate your VCR or satellite receiver (see page 5).
- To activate your remote, press (FUNCTION button) to operate your VCR or (FUNCTION button) to operate your satellite receiver.
- Press repeatedly to switch between VCR input (VIDEO input), VHF/UHF (local channels or unscrambled), or your cable box (cable system or scrambled channels).

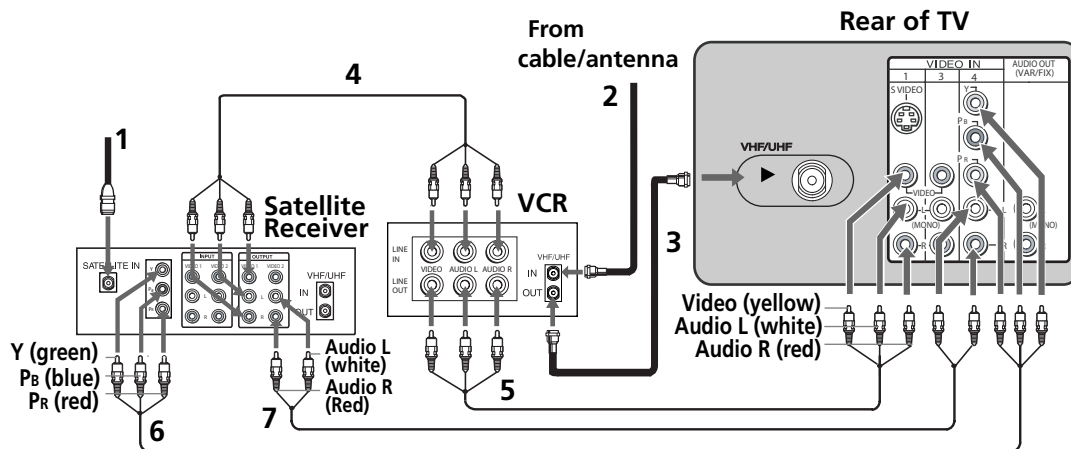

## Connecting a TV, VCR, and Satellite Receiver using Component Video (Y, P<sub>B</sub>, P<sub>R</sub>)



- 1** Connect the coaxial cable from your satellite antenna to SATELLITE IN on the satellite receiver.
- 2** Connect the coaxial cable from your cable service or antenna to the IN jack on your VCR.
- 3** Using a coaxial cables (not supplied), connect the OUT jack on your VCR to the VHF/UHF jack on your TV.
- 4** Using audio/video cables (not supplied), connect AUDIO/VIDEO OUT on your satellite receiver to AUDIO/VIDEO IN on your VCR.
- 5** Using audio/video cables (not supplied), connect the AUDIO/VIDEO OUT on your VCR to AUDIO/VIDEO IN on your TV.
- 6** Using component video cables (not supplied), connect the Y, P<sub>B</sub>, P<sub>R</sub> OUT on your satellite receiver to Y, P<sub>B</sub>, P<sub>R</sub> IN on your TV.
- 7** Connect AUDIO OUT on your satellite receiver to AUDIO IN on your TV.

### Using your TV with this connection

This connection allows you to do the following:

- Program your Sony remote control to operate your VCR or satellite receiver (see page 5).
- Turn on your VCR to enable your satellite receiver to work with this connection.
- To activate your remote, press  (FUNCTION button) to operate your VCR or  (FUNCTION button) to operate your satellite receiver.
- Press  repeatedly to switch between VCR input (VIDEO input), VHF/UHF (local channels or unscrambled), or your cable box (cable system or scrambled channels).

## Connecting a DVD Player using Composite Video (VIDEO/AUDIO L(MONO),R)

Using audio/video cables (not supplied), connect AUDIO/VIDEO OUT on your DVD player to AUDIO/VIDEO IN on your TV.

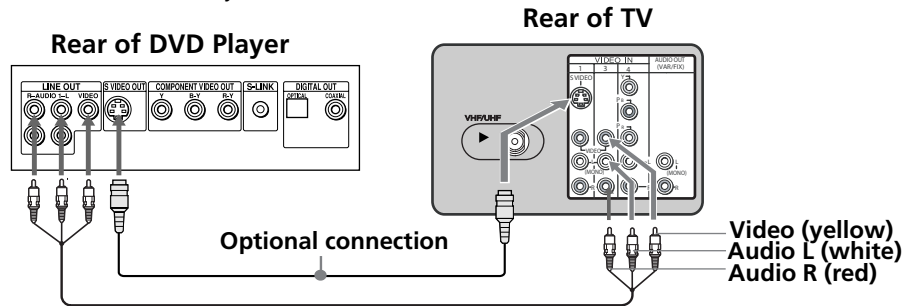

### Optional connection

- ❑ For better picture quality, use S VIDEO instead of the yellow video cable. S VIDEO does not provide sound, so you still must connect the audio cables.

## Connecting a DVD Player using Component Video (Y, P<sub>B</sub>, P<sub>R</sub>/R, L)

If your DVD player is equipped with component video outputs (Y, P<sub>B</sub>, P<sub>R</sub>), you can improve the picture quality by using component video cables (480i only).

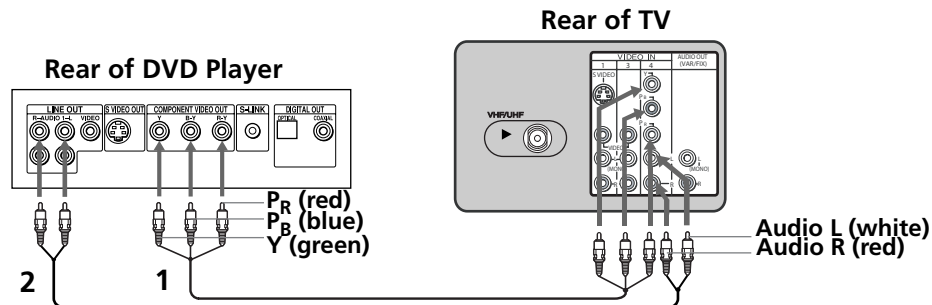



- 1** Using component video cables (not supplied), connect the Y, P<sub>B</sub>, P<sub>R</sub> OUT on your DVD player to Y, P<sub>B</sub>, P<sub>R</sub> IN on your TV.
- 2** Connect AUDIO OUT on your DVD player to AUDIO IN on your TV.

 The Y, P<sub>B</sub>, P<sub>R</sub> outputs on your DVD player are sometimes labeled Y, C<sub>B</sub>, and C<sub>R</sub> or Y, B-Y, and R-Y. If so, connect the cables to like colors.

### Using your TV with this connection

This connection allows you to do the following:

- ❑ Program your Sony remote control to operate your DVD (see page 5).
- ❑ To activate your remote, press  (FUNCTION button) to operate your DVD (see page 7).
- ❑ Press  repeatedly to switch to the DVD player's input (VIDEO input).

## Connecting an Audio System

 If you are connecting a Home Theater, please refer to your Home Theater manual for additional connections.

- 1** Using audio/video cables (not supplied), connect AUDIO OUT on your TV to one of the unused line inputs (e.g. TV, AUX, TAPE2) on your stereo.
- 2** Set the Speaker option to Off. For more instructions, see "Using the Audio Menu" on page 29.
- 3** After you connect the audio system, you can control the volume level from your TV or audio system.
  - To control the volume from the TV, use the front panel controls or the VOL +/- buttons on the remote.
  - To control the volume through the connected audio system, open the Audio Out option on the Audio Menu and select Fixed. For more instructions, see "Using the Audio Menu" on page 29.

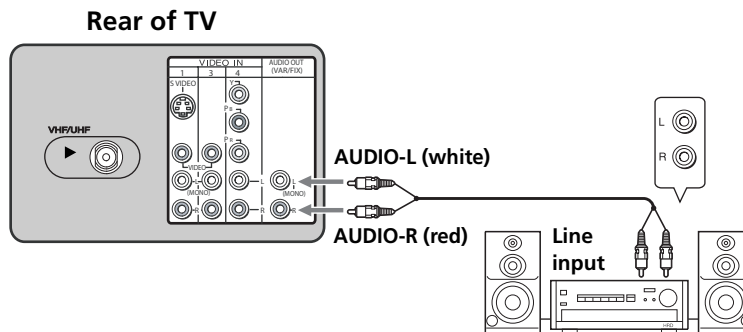

## Connecting a Camcorder (for playback)

To connect your camcorder, you can use the Audio/Video inputs on either the front or rear panel of the TV. Using the audio/video cables (not supplied), connect the AUDIO/VIDEO OUT on your camcorder to the AUDIO/VIDEO IN on your TV.

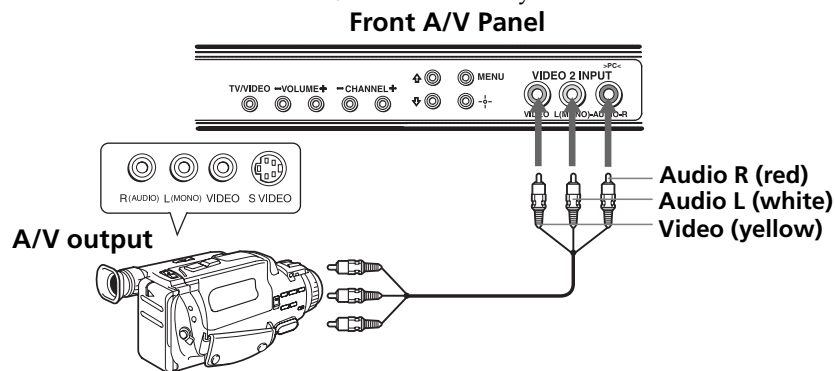

### Optional connection

- For better picture quality, use S VIDEO instead of the yellow video cable. S VIDEO does not provide sound, so you still must connect the audio cables.

## Connecting for Video Tape Editing (VCR and Camcorder)

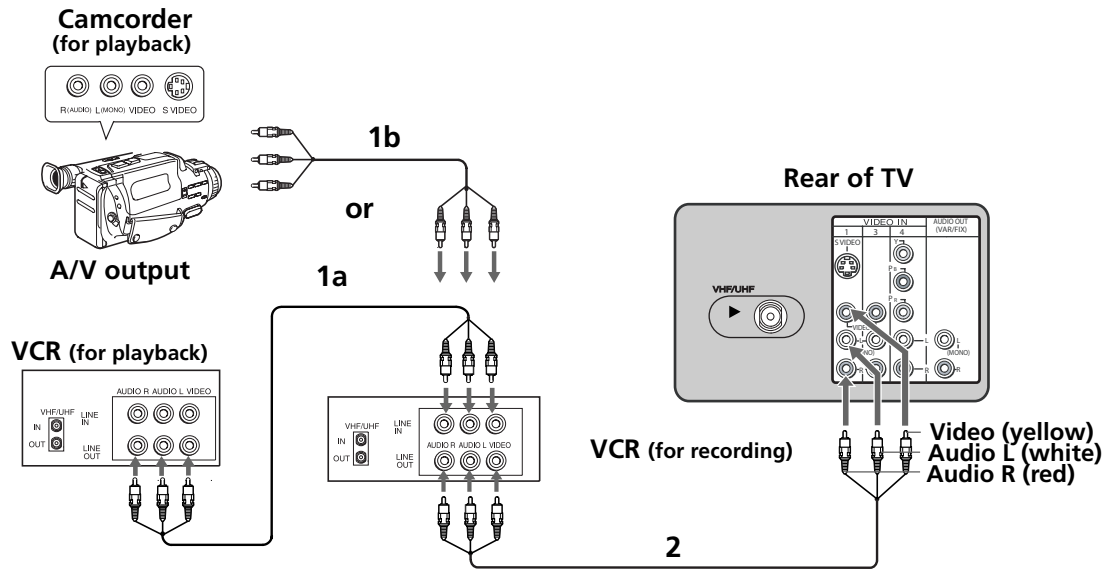

Connections

- 1** For video tape editing connect to the VCR the following sources (VCR or Camcorder):
  - Using audio/video cables (not supplied), connect AUDIO/VIDEO OUT on your first VCR to AUDIO/VIDEO IN on your second VCR (option 1a)
  - Using audio/video cables (not supplied), connect the AUDIO/VIDEO OUT on your Camcorder to the AUDIO/VIDEO IN on your second VCR (option 1b)
- 2** Using audio/video cables (not supplied), connect AUDIO/VIDEO OUT on the second VCR to the AUDIO/VIDEO IN on your TV.

### Using your TV with this connection

This connection allows you to do the following:

- Program your Sony remote control to operate your VCR (see page 5).
- To activate your remote, press  (FUNCTION button) to operate your VCR, see page 7 on how to operate other functions.



# Using Basic Functions

## Setting Up the TV

After you have finished connecting your TV, you can use Auto Program to set up your channels. During Auto Program, the TV will automatically search for available channels and program receivable channels.

 When you start Auto Program wait until it is finished; otherwise it will skip over channels that are available. Perform Auto Program again to program receivable channels.











- 1 Press  to turn on the TV. The Initial Setup screen appears.





- 2 Press  on the remote control or on the TV front panel to start Auto Program, or press  to exit.

 The Initial Setup screen appears each time you turn on the TV until you perform Auto Program.

### To perform Auto Program again

- 1 Press .
- 2 Press  to highlight Channel Menu.
- 3 Press  to highlight Cable. Press  to select.
- 4 Press  or  to highlight On or Off according to how you connected your TV. Press  to select.
- 5 Press  to highlight Auto Program. Press  to search for channels.
- 6 After Auto Program finishes, press  to exit.

### To reset the TV to factory settings

- 1 Turn the TV on.
- 2 Hold down  on the remote control.
- 3 Press and release the POWER button on the TV front panel. The TV will turn itself off, then back on.
- 4 Release .

## Quick Start to the Menus

The following settings are available in your on-screen menus. For more details on how to use the menus, see "Using the Menus" on page 27.

### Menu

### Allows you to

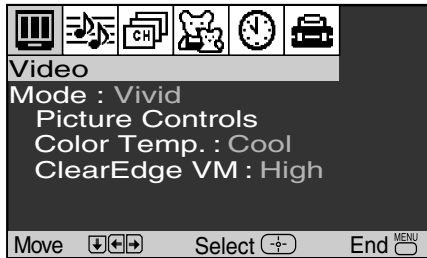

Adjust your picture settings.

### Basic Functions

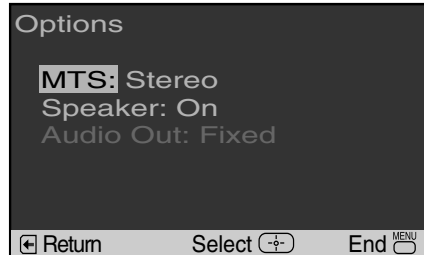
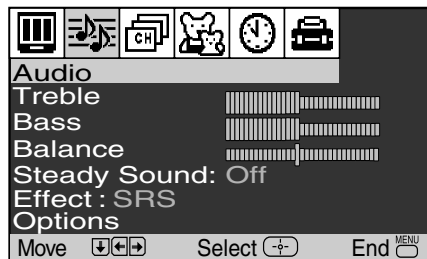

Change your audio settings.



Customize your channel settings.



Set rating limits on your TV based on program rating or content.



---

**Menu****Allows you to**

---



Set the clock on your TV and program scheduled viewing using Timer 1 and Timer 2.



Select closed captioning options, display the name of the current program and its remaining time (Info Banner), label video inputs, adjust tilt correction, enhance your DVD picture resolution (16:9 Enhanced) or select menu language.



# Using the Menus

This section shows the options available for setting up and adjusting the TV.

## Using the Remote Control to Navigate on the On-Screen Menu

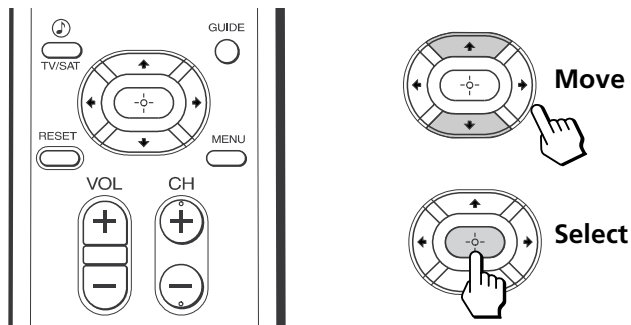

To navigate on the on-screen menu, use the “arrow” buttons (↑, ↓, ←, →) to move the cursor. Pressing these arrows will cause the cursor to move in the corresponding direction. Pressing center button (⏏) will allow you to select an option.

## How to Access Menus

### To Access Menus



- 1 Press to display the on-screen menu.
- 2 Use the ← or → buttons to highlight the desired menu icon. Press to select it.
- 3 Use the ↑ or ↓ buttons to scroll up and down through the features.
- 4 Follow the instructions on the screen.
- 5 For instructions on using a specific menu, see the page in this section that talks about that menu.
- 6 Press to exit the menu.

Press once to display the on-screen menu, and press again to return to normal viewing. If no buttons are pressed, the menu closes automatically after about 90 seconds.

## Using the Video Menu

To access the Video menu, use the following steps:



Press  to highlight an option; then press .

### Mode

*Customized picture viewing*











Use the  or  buttons to highlight one of the following options, then press  to select it.

- Vivid:** Select for enhanced picture contrast and sharpness.
- Standard:** Select for a standard picture.
- Movie:** Select for a finely detailed picture.
- Pro:** Select for natural picture and sharpness.

 Press  on the remote control for direct access to the picture modes (Vivid, Standard, Movie, Pro).



### Picture Control

With the Picture Controls menu open, press  or  to select one of the following option:

- Picture:** Press  to decrease the contrast. Press  to increase contrast.
- Brightness:** Press  to darken the picture. Press  to brighten the picture.
- Color:** Press  to decrease color saturation. Press  to increase color saturation.
- Hue:** Press  to increase the red tones. Press  to increase the green tones.
- Sharpness:** Press  to soften the picture. Press  to sharpen the picture.



### Color Temp.

*White color tint adjustment*

Use the  or  buttons to select from one of the following options:

- Cool:** Gives the white colors a blue tint.
- Neutral:** Gives the white colors a neutral tint.
- Warm:** Gives the white colors a red tint.



### ClearEdge VM





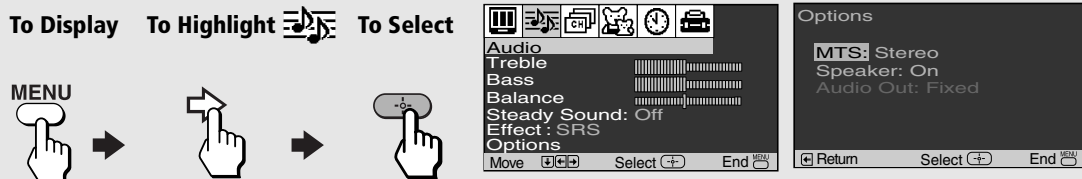





Sharpens picture definition to give objects a crisp edge. Use the  or  buttons to highlight of the following options: **High, Low, Off**; then press to  select it.

## Using the Audio Menu







To access the Audio menu, use the following steps:



Press  to highlight an option; then press .

<b>Treble</b>	Press  to decrease the higher pitched sounds. Press  to increase the higher pitched sounds.
<b>Bass</b>	Press  to decrease the lower pitched sounds. Press  to increase the lower pitched sounds.
<b>Balance</b>	Press  to emphasize the left speaker. Press  to emphasize the right speaker.
<b>Steady Sound</b> <i>Stabilizes volume</i>	Press  or  to select one of the following options: <b>On:</b> Select to stabilize the volume when changing channels. <b>Off:</b> Select to turn Steady Sound off.
<b>Effect</b>	Use the  or  buttons to highlight one of the following options, then press  to select it. <b>Simulated:</b> Simulates theater quality sound for mono programs. <b>SRS:</b> Produces a dynamic three-dimensional sound for stereo programs. <b>Off:</b> Normal stereo or mono reception.

 Press  to directly select Effect settings (Simulated, SRS, Off).

<b>Options</b>	Use these features to change your Audio setting.
<b>MTS</b> <i>Multi-Channel TV Sound</i>	Use the  or  buttons to highlight one of the following options, then press  to select it. <b>Stereo:</b> Select when viewing a broadcast in stereo. <b>Auto SAP:</b> Select to have the TV automatically switch to a Second Audio Program (SAP) when a signal is received. <b>Mono:</b> Select to reduce noise in areas of poor reception.
<b>Speaker</b> <i>Custom selection of audio output source</i>	Use the  or  buttons to highlight one of the following options, then press  to select it. <b>On:</b> Select to listen to the sound from the TV speakers with or without a separate stereo system. <b>Off:</b> Select to turn off the TV speakers and listen to the TV's sound only through external audio system speakers.

**Audio Out** Use the  $\uparrow$  or  $\downarrow$  buttons to highlight one of the following options, then press  $\rightarrow$  to select it.  
*Use to control the TV's volume through a stereo*

**Variable:** Adjust the volume through your TV.  
**Fixed:** Adjust the volume through a connected stereo.





 Press  $\text{MTS/SAP}$  to directly select MTS settings (Stereo, Auto SAP, Mono).



 If your TV is set to Auto SAP, some programs may be muted or distorted. If your TV does not output sound, change your Audio MTS setting to Stereo or Mono.

 You can only set Audio Out settings when you have set Speaker to Off.

## Using the Channel Menu









To access the Channel menu, use the following steps:





<p><b>To Display</b></p> 	→	<p><b>To Highlight</b> </p> 	→	<p><b>To Select</b></p> 	
--	---	--	---	---	--

Press  to highlight an option; then press .

### **Favorite Channels**

*Quick access to favorite channels*

- 1 Use the  or  buttons to highlight the position (1-8) where you want to set a favorite channel, then press .
- 2 Use the  or  buttons to find the channel you want to add to your favorite channels.
- 3 Press  to select the channel. The TV will automatically change to the selected channel.
- 4 Press  to return to the Channel menu or press  to exit.

 To use Favorite Channels, exit all menus and press . Press  or  to move the cursor to the desired channel number and press .

### **Cable**

Use the  or  buttons to highlight one of the following options, then press  to select it.

- On:** Select if you are receiving cable channels with a CATV cable.  
**Off:** Select if you are using a TV antenna.

 After changing your cable settings, you will need to perform Auto Program. See "To perform Auto Program again" on page 23.

### **Channel Fix**

Use the  or  buttons to highlight one of the following options, then press  to select it.

- Off:** Channel Fix is not set.  
**2-6:** Select when you want to control all channel selection through a cable box or VCR. Select the appropriate channel (usually 3 or 4) and use the cable box's or VCR's remote control for channel selection.  
**Video 1:** Select from available video inputs when you have connected video equipment (e.g., a satellite receiver) and you want your TV fixed to it.

---

**Auto Program** Perform Auto Program whenever setting up your TV. Auto Program will search for available channels and program receivable channels.

---

**Channel Skip/Add** Use this feature after you run Auto Program to skip unwanted channels or add new ones.

- 1 Use the  $\uparrow$  or  $\downarrow$  buttons to highlight the position of the desired channel, then press  $\rightarrow$ .
- 2 Use the  $\uparrow$  or  $\downarrow$  buttons to highlight **Skip** or **Add**, then press  $\rightarrow$ .
- 3 Press  $\leftarrow$  to return to the Channel menu or press  $\rightarrow$  <sup>MENU</sup> to exit.

 Press CH + or CH - to skip over channels that have been skipped. You can still use the 0-9 buttons to directly tune to skipped channels.

---

**Channel Label** 1 Press  $\rightarrow$ , then use the  $\uparrow$  or  $\downarrow$  buttons until you reach the desired channel number.

*Label up to 40 channels with their call letters*

- 2 Press  $\rightarrow$  to activate the channel.
- 3 Press  $\downarrow$  to highlight **Label**, then press  $\rightarrow$ . Use the  $\uparrow$  or  $\downarrow$  buttons to display the first call letter or number of the label. Press  $\rightarrow$  to select. Repeat this process until you finish selecting all the call letters.
- 4 When finished, press  $\rightarrow$  to activate.
- 5 Press  $\leftarrow$  to return to the Channel menu or press  $\rightarrow$  <sup>MENU</sup> to exit.

 You cannot use Favorite Channels, Cable, Channel Skip/Add, or Channel Label when Channel Fix is set.



---



## Using the Parent Menu

To access the Parent menu, use the following steps:

**To Display**      **To Highlight**       **To Select**



The Parental Control feature helps parents monitor what their children watch on television.

### To use the Parent Menu

When you select the Parent menu, you are prompted to set a 4-digit password. You cannot access the Parent menu settings without this password.

- 1 Use the 0-9 buttons to enter a 4-digit password.
- 2 Confirm your password by entering it again.

 Keep this manual in a safe place. You need your password for any future access to the Parent menu. If you forget your password, see page 41.

# Parental Control

## Setting the Rating

You can change the Rating by selecting one of the Parental Lock options.



- 1 Press  $\updownarrow$  to highlight **Parental Lock**, then press  $\ominus\oplus$ .

If you are not familiar with Parental Guideline rating system, use one of the following preset categories to simplify the rating selection: Child, Youth, Young Adult.

- 2 Use the  $\updownarrow$  or  $\leftarrow\rightarrow$  to highlight the desired rating and press  $\ominus\oplus$ .

Rating	TV will allow a maximum rating of
Off	No rating limit
Child	TV-Y, TV-G, G (U.S.), G, C (Canada)
Youth	TV-PG, PG (U.S.), 8 ans + (Canada)
Young Adult	TV-14, PG-13 (U.S.), 14+ (Canada)
Custom	Select to set more restrictive ratings (see next section)

## Changing your Password

- 1 Use the  $\updownarrow$  or  $\leftarrow\rightarrow$  buttons to highlight **Change Password** and press  $\ominus\oplus$ .
- 2 Follow steps 1 and 2 for "Using the Parent Menu" on page 33.



## Select a Country

Select U.S.A. to use US ratings (see pages 36-37) or select Canada to use Canadian ratings (see page 38). If you select a Country (U.S.A. or Canada) that is not where you live, the rating you select will not be activated.

- 1 Press  $\updownarrow$  to highlight **Country**, then press  $\ominus\oplus$ .
- 2 Use the  $\updownarrow$  or  $\leftarrow\rightarrow$  to highlight the desired country and press  $\ominus\oplus$ .

## Information for Parents

### To view a program that exceeds the TV rating

- Press , then use the - buttons to enter your password.

 Entering your password to view a blocked program will temporarily turn **Parental Lock** to Off. To reactivate your Lock settings, turn the TV off then back on; the TV will return to the settings that you have selected.

## Using the Custom Menu

Follow the instructions on the screen to make your custom settings. Select the country desired for your TV's rating limit. See page 36 for U.S. models and page 38 for Canadian models for more information.

 Once you have blocked a rating or content, all higher ratings or content will be automatically blocked.

## United States: Selecting Custom Rating Options

For the United States, the Custom Rating menu includes the following options: Movie Rating, TV Rating and Unrated. (For Canada, see page 38.)

### Movie Rating

This system defines the rating levels of movies shown in theaters and on prime cable channels.

Rating	Defined as
<b>G</b>	General audience
<b>PG</b>	Parental guidance suggested
<b>PG-13</b>	Parents strongly cautioned
<b>R</b>	Restricted
<b>NC-17</b>	No one 17 and under admitted
<b>X</b>	Adult audience only



### TV Rating

The TV rating is divided into two groups: age-based and content-based.

Menus

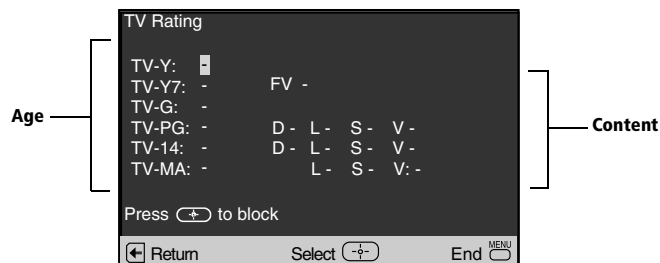

Age	Defined as
<b>TV-Y</b>	All children
<b>TV-Y7</b>	Directed to older children
<b>TV-G</b>	General audience
<b>TV-PG</b>	Parental guidance suggested
<b>TV-14</b>	Parents strongly cautioned
<b>TV-MA</b>	Mature audience only

Content	Defined as
<b>FV</b>	Fantasy violence
<b>D</b>	Suggestive dialogue
<b>L</b>	Strong language
<b>S</b>	Sexual situations
<b>V</b>	Violence

 The content ratings will increase depending on the level of the age-based rating. For example, a program with a TV-PG V (Violence) rating may contain moderate violence, while a TV-14 V (Violence) rating may contain intense violence.

## Unrated

You have the option of blocking TV programs or movies that are not rated.

<b>Allow</b>	Allows all unrated programs
<b>Block</b>	Blocks all unrated programs



 If you choose to block unrated TV programs, please be aware that the following programs may be blocked: emergency broadcasts, political programs, pro, news, public service announcements, religious programs, and weather.

## Canada: Selecting Custom Rating Options

For Canada, the Custom Rating menu includes the following options: English Rating, French Rating, and U.S.A. Rating.

### English Rating

These ratings are for Canadian programs that are broadcast in English.

Rating	Defined as
<b>C</b>	Children
<b>C8+</b>	Children 8 years and older
<b>G</b>	General programming
<b>PG</b>	Parental guidance
<b>14+</b>	Viewers 14 and older
<b>18+</b>	Adult programming

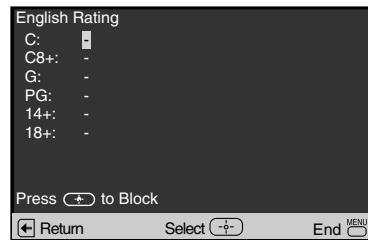

### French Rating

These ratings are for Canadian programs that are broadcast in French.

Rating	Defined as
<b>G</b>	General
<b>8 ans+</b>	Not recommended for younger children
<b>13 ans+</b>	Not recommended for children under age 13
<b>16 ans+</b>	Not recommended for ages under 16
<b>18 ans+</b>	This program is restricted to adults

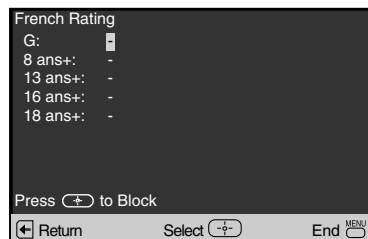

### U.S.A. Rating

For programs from the United States, see "TV Rating" on page 36.

## Using the Timer ⌚ Menu

To access the Timer menu, use the following steps:

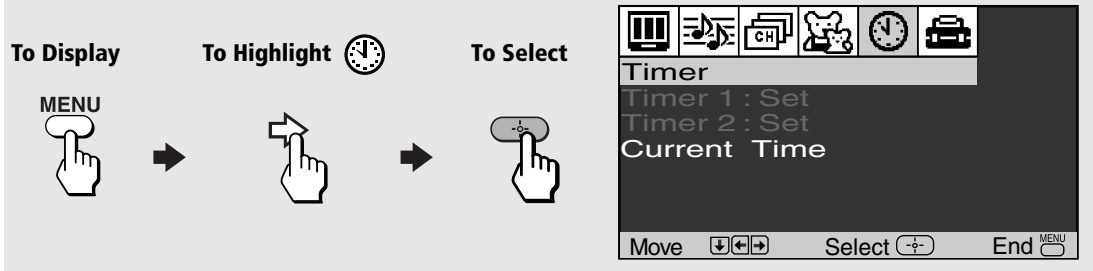

**Current Time** Set your TV to the current day and time. Press to open the Current Time menu:

- 1 Use the or buttons to enter the correct day and time, then press .
- 2 Press to exit the menu.

You must set the Current Time before you can use Timer 1 or Timer 2.

**Timer 1 and Timer 2** Use the timers to program your TV to turn on and off by day, time, duration, and channel. The timer duration is a maximum of six hours. When the channel is fixed, it is not necessary to set the channel.

*Scheduled viewing*





- 1 Use the or buttons to highlight **Timer 1** or **Timer 2**, then press .
- 2 Use the or buttons to enter the desired day, start time, duration, and channel, then press . The timer status should be On when the Timer has been set, and the timer light on the front panel of the TV should be on.
- 3 Press to exit the menu.



Select Off to turn off the Timer. Your previous settings will be saved.









When you perform Auto Program, Timer 1 and Timer 2 settings will be cleared. Also, in the event of any loss of power, Current Time, Timer 1, and Timer 2 settings will be cleared.

## Using the Setup Menu



To access the Setup menu, use the following steps:

<p><b>To Display</b></p> 	→	<p><b>To Highlight</b> </p> 	→	<p><b>To Select</b></p> 
--	---	--	---	---

Press  to highlight an option; then press .

					
<b>Setup</b>					
Caption Vision : Off					
Info Banner : Off					
Video Label					
Tilt Correction					
Language : English					
16:9 Enhancement : Off					
				End 	



**Caption Vision** Allows you to select from three closed caption modes for programs that are broadcast with closed captioning.

*Closed-Captioning* Use the  or  buttons to highlight one of the following options, then press  to select it.

**Off:** Caption Vision is not activated.

**CC1, 2, 3, 4:** Displays printed dialogue and sound effects of a program.

**Text1, 2, 3, 4:** Displays network/station information.



**Info Banner** Displays the name of the current program and its remaining time (if available) when you change the channel or press the DISPLAY button. Use the  or  buttons to highlight one of the following options: **On, Off**. Then press .



**Video Label** Allows you to identify the video components connected to the TV: VHS, DVD, etc. When you press TV/VIDEO to switch inputs, the Video Label appears on-screen.

*Label*



*connected*



*equipment*

**1** Press the  or  buttons to highlight the input you want to label and press .

**2** Press the  or  buttons to highlight a label and press .

**3** Press  to return to the Setup menu or press  to exit.

**Tilt Correction** Use the  or  buttons to set the tilt of the picture from -5 to +5, then press  to activate.

**Language** Display all menus in the language of your choice. Use the  or  buttons to select from one of the following options: **English, Español** (Spanish) and **Français** (French). Then press .

**16:9 Enhanced** Provides enhanced picture resolution for wide-screen sources such as DVD. This is only available when the TV is in Video mode.





# Other Information

## Troubleshooting

If you have a problem with your TV, try the suggestions below. If the problem persists, see “Contacting Sony” at the end of this section.

### General

Problem	Possible Remedies
<b>I want to reset the TV to the factory settings</b>	<input type="checkbox"/> Turn on the TV. While holding down  on the remote control, press POWER button on the TV front panel. The TV will turn itself off, then back on again. Release  .
<b>The TV is dirty</b>	<input type="checkbox"/> Clean the TV with a soft dry cloth. Never use strong solvents such as thinner or benzine, which might damage the finish of the cabinet.
<b>I lost the parental control password</b>	<input type="checkbox"/> In the password screen, enter the following master password: 4357. After using the master password, you must create a new password. You cannot use the master to unlock currently blocked channels.
<b>There is a black box on the screen</b>	<input type="checkbox"/> You have selected a text option in the Setup menu (page 40) and no text is available. To turn off this feature, select Off in the Caption Vision option. If you were trying to select closed captioning, select CC1-4 instead of Text1-4.
<b>There was a blackout or power outage, and now the TV won't turn on and the timer LED is flashing</b>	<input type="checkbox"/> Press the POWER button on your remote control or on the TV front panel.
<b>Digital cable box does not work</b>	<input type="checkbox"/> Be sure that you have not connected the digital cable box to the TV's TO CONVERTER jack. This jack is not compatible with digital cable boxes. <input type="checkbox"/> If you are connecting a VCR and digital cable box using a splitter, as described in page 14, you must use a special bi-directional splitter (5~900MHz minimum) that is designed to work with your digital cable box.

## Remote Control

Problem	Possible Remedies
I cannot operate the remote control	<ul style="list-style-type: none"><li><input type="checkbox"/> Press TV (FUNCTION) when operating your TV.</li><li><input type="checkbox"/> Check the orientation of the batteries.</li><li><input type="checkbox"/> Batteries could be weak. Replace them (page 2).</li><li><input type="checkbox"/> Move the TV three to four feet away from fluorescent lights.</li></ul>
I cannot change channels with the remote control	<ul style="list-style-type: none"><li><input type="checkbox"/> Make sure you have not inadvertently switched your TV from the channel 3 or 4 setting if you are using another device to change channels.</li><li><input type="checkbox"/> If you are using another device to control channels, be sure that you have pressed the FUNCTION button for that device. For example, if you are using your VCR to control channels, be sure to press the VCR/DVD FUNCTION button (page 4).</li></ul>
I lost the remote control	<ul style="list-style-type: none"><li><input type="checkbox"/> You can use the front panel controls to access your menus, change channels, adjust the volume, or change video inputs (page 2). Contact your nearest Sony Dealer to order a replacement, please call our Sony Direct Accessory and Part Center at 1-800-488-7669 (U.S. residents only).</li></ul>

## Programming the Remote Control

Problem	Possible Remedies
More than one code is listed	<ul style="list-style-type: none"><li><input type="checkbox"/> Try entering them one by one until you come to the correct code for your component.</li></ul>
I entered the wrong code number	<ul style="list-style-type: none"><li><input type="checkbox"/> If you enter a new code number, the code number you previously entered at that setting is erased.</li></ul>
I cannot operate a component with the remote control	<ul style="list-style-type: none"><li><input type="checkbox"/> Use the component's own remote control.</li></ul>
When I changed the batteries, the code numbers changed back to the factory settings	<ul style="list-style-type: none"><li><input type="checkbox"/> You must reprogram the remote control (page 5).</li></ul>

## Video

Problem	Possible Remedies
<b>No picture, no sound</b>	<ul style="list-style-type: none"> <li><input type="checkbox"/> Make sure the power cord is plugged in.</li> <li><input type="checkbox"/> If a red light is flashing on the front of your TV for more than a few minutes, disconnect and reconnect the power cord. If the problem continues, call your local service center.</li> <li><input type="checkbox"/> Check the TV/VIDEO setting: when watching TV, set it to TV; when watching video equipment, set it to VIDEO 1, 2, 3 or 4 (page 4).</li> <li><input type="checkbox"/> Try another channel to rule out station trouble.</li> </ul>
<b>Poor or no picture, good sound</b>	<ul style="list-style-type: none"> <li><input type="checkbox"/> Adjust the <b>Picture</b> setting in the Video menu (page 28).</li> <li><input type="checkbox"/> Adjust the <b>Brightness</b> setting in the Video menu (page 28).</li> <li><input type="checkbox"/> Check the antenna and/or cable connections (page 11).</li> </ul>
<b>No color</b>	<ul style="list-style-type: none"> <li><input type="checkbox"/> Adjust the <b>Color</b> setting in the Video menu (page 28).</li> </ul>
<b>Only snow appears on the screen</b>	<ul style="list-style-type: none"> <li><input type="checkbox"/> Check the <b>Cable</b> setting in the Channel menu (page 31).</li> <li><input type="checkbox"/> Check the antenna and/or cable connections (page 11).</li> <li><input type="checkbox"/> Make sure the channel selected is currently broadcasting.</li> </ul>
<b>Dotted lines or stripes</b>	<ul style="list-style-type: none"> <li><input type="checkbox"/> Adjust the antenna.</li> <li><input type="checkbox"/> Move the TV away from other electronic equipment. Some electronic equipment creates electrical noise, which can interfere with TV reception.</li> </ul>
<b>Double images or ghosts</b>	<ul style="list-style-type: none"> <li><input type="checkbox"/> Check your outdoor antenna or call your cable service.</li> </ul>

## Audio

Problem	Possible Remedies
<b>Good picture, no sound</b>	<ul style="list-style-type: none"> <li><input type="checkbox"/> Press  so that Muting disappears from the screen (page 3).</li> <li><input type="checkbox"/> Check your Audio settings. Your TV may be set to Auto SAP in the MTS feature (page 29).</li> <li><input type="checkbox"/> Make sure the speaker option is set to On in the Audio Menu.</li> <li><input type="checkbox"/> Adjust TV's volume.</li> </ul>
<b>Low or no audio (TV and Cable box)</b>	<ul style="list-style-type: none"> <li><input type="checkbox"/> Some cable boxes have volume level controls. Check and see if your cable box or cable box remote has a volume control.</li> </ul>

## Channels

Problem	Possible Remedies
<b>I cannot receive higher number channels (UHF) when using an antenna</b>	<ul style="list-style-type: none"><li><input type="checkbox"/> Make sure <b>Cable</b> is set to Off in the Channel menu (page 31).</li><li><input type="checkbox"/> Perform Auto Program to add channels that are not presently in the memory (page 23).</li></ul>
<b>Cable stations don't seem to work</b>	<ul style="list-style-type: none"><li><input type="checkbox"/> Make sure <b>Cable</b> is set to On in the Channel menu (page 31).</li><li><input type="checkbox"/> Perform Auto Program to add channels that are not presently in the memory (page 23).</li></ul>

## Contacting Sony

Before calling our Customer Information Services Center, reset the TV to factory settings (see page 23). Please have your TV serial number ready. The number is located on the rear of your TV and on the front cover of this manual.

Our Customer Information Services Center phone number is 1-877-899-SONY (7669) (US residents only) or (416) 499-SONY (7669) (Canadian residents only).

## Specifications

Television system	American TV standard/NTSC		
Channel coverage	VHF: 2-13/UHF: 14-69/CATV: 1-125		
Antenna	75-ohm external antenna terminal for VHF/UHF		
Picture tube	FD Trinitron® tube		
Power requirements	120V, 60 Hz		
Supplied accessories	Size AA (R6) batteries (2) Remote Control RM-Y195		
Optional accessories	TV Stand: SU-27FS2		
<b>KV-27FS120</b>			
Screen size	Visible screen size: 679 mm (27 inches) measured diagonally Actual screen size: 736.6 mm (29 inches) measured diagonally		
Inputs/outputs	Inputs	1 video, 1 audio (front) 2 video, 2 audio (rear) 1 S VIDEO 1 RF 1 Y, PB, PR, 1 audio	Outputs 1 AUDIO OUT
Speaker output	10 W x 2		
Power consumption	180 W in use less than 1 W in standby		
Dimensions (W/H/D)	768 x 589 x 497 mm (30 1/4 x 23 1/4 x 19 5/8 inches)		
Mass	45.2 kg (99 lbs. 10 oz)		

*Design and specifications are subject to change without notice.*



# Index

- 16:9 Enhanced **40**
- A**
  - Audio Out **30**
  - Auto Program **23, 32**
  - Auto SAP **29**
- B**
  - Balance **29**
  - Bass **29**
  - Batteries
    - Inserting in remote **2**
  - Brightness **28**
- C**
  - Cable **31**
  - Caption Vision **40**
  - Channel Fix **31**
  - Channel Label **32**
  - Channel Skip/Add **32**
  - ClearEdge VM **28**
  - Color **28**
  - Connections
    - Cable and antenna **11**
    - Connecting a Camcorder **20**
    - Connecting an Audio System **20**
    - DVD Player using Component Video (Y, P<sub>B</sub>, P<sub>R</sub>/R, L) **19**
    - DVD Player using Composite Video (VIDEO/AUDIO L(MONO),R) **19**
    - TV and Satellite Receiver **16**
    - TV and VCR **12**
    - TV, VCR and Cable Box **14**
    - TV, VCR, and Satellite Receiver using Component Video (Y, P<sub>B</sub>, P<sub>R</sub>) **18**
    - TV, VCR, Cable/Antenna, and Satellite Receiver using Composite Video (VIDEO/AUDIO L(MONO), R) **17**
    - VideoTape Editing (VCR or Camcorder) **21**
  - Current Time **39**
- E**
  - Effect
    - Off **29**
    - SRS **29**
    - Simulated **29**
- F**
  - Favorite Channels **31**
- H**
  - Hue **28**
- I**
  - Index **47**
  - Info Banner **40**
- L**
  - Language **40**
- M**
  - Manufacturer's Codes **6**
  - Menus
    - Audio **29**
    - Channel **31**
    - Parent **33**
    - Setup **40**
    - Timer **39**
    - Video **28**
  - Mode
    - Movie **28**
    - Pro **28**
    - Standard **28**
    - Vivid **28**
  - MTS
    - Auto SAP **29**
    - Mono **29**
    - Stereo **29**
- P**
  - Parental Control **34**
  - Picture **28**
  - Picture Control **28**
  - Picture Controls
    - Brightness **28**
    - Color **28**
    - Hue **28**
    - Picture **28**
    - Sharpness **28**
  - Programming The Remote Control **42**
- R**
  - Remote Control
    - Programming **5**
- S**
  - Setting the Rating
    - English Rating **38**
    - French Rating **38**
    - Movie Rating **36**
    - TV Rating **36**
    - U.S.A. Rating **38**
    - Unrated **37**
  - SLEEP **3**
  - Speaker **29**
  - Specifications **45**
  - Steady Sound **29**
- T**
  - Tilt Correction **40**
  - Timer 1 and Timer 2 **39**
  - Treble **29**
  - Troubleshooting **41**
  - TV Features **1**
  - TV Front Panel **2**
  - TV Rear Panel **9**
- V**
  - Video Label **40**

Sony Corporation

<http://www.sony.net>

Printed in U.S.A.



## Free Manuals Download Website

<http://myh66.com>

<http://usermanuals.us>

<http://www.somanuals.com>

<http://www.4manuals.cc>

<http://www.manual-lib.com>

<http://www.404manual.com>

<http://www.luxmanual.com>

<http://aubethermostatmanual.com>

Golf course search by state

<http://golfingnear.com>

Email search by domain

<http://emailbydomain.com>

Auto manuals search

<http://auto.somanuals.com>

TV manuals search

<http://tv.somanuals.com>