

Multi Channel AV Receiver

Operating Instructions

Please read the Quick Setup Guide supplied with the receiver first. This allows you to understand the connections and operations flow of the receiver more easily.

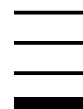

WARNING

To reduce the risk of fire or electric shock, do not expose this apparatus to rain or moisture.

To reduce the risk of fire, do not cover the ventilation opening of the appliance with newspapers, tablecloths, curtains, etc.

Do not expose the appliance to naked flame sources (for example, lighted candles).

Do not install the appliance in a confined space, such as a bookcase or built-in cabinet.

To reduce the risk of fire or electric shock, do not expose this appliance to dripping or splashing, and do not place objects filled with liquids, such as vases, on the appliance.

As the main plug is used to disconnect the unit from the mains, connect the unit to an easily accessible AC outlet. Should you notice an abnormality in the unit, disconnect the main plug from the AC outlet immediately.

Do not expose batteries or appliances with battery-installed to excessive heat, such as sunshine and fire.

The unit is not disconnected from the mains as long as it is connected to the AC outlet, even if the unit itself has been turned off.



This symbol is intended to alert the user to the presence of the Hot Surface that may be hot if it is touched during the normal operation.



This symbol is intended to alert the user to the presence of uninsulated "dangerous voltage" within the product's enclosure that may be of sufficient magnitude to constitute a risk of electric shock to persons.



This symbol is intended to alert the user to the presence of important operating and maintenance (servicing) instructions in the literature accompanying the appliance.

For customers in the United States

Owner's Record

The model and serial numbers are located on the rear of the unit. Record these numbers in the space provided below. Refer to them whenever you call upon your Sony dealer regarding this product.

Model No. _____ Serial No. _____

Important Safety Instructions

- 1) Read these instructions.
 - 2) Keep these instructions.
 - 3) Heed all warnings.
 - 4) Follow all instructions.
 - 5) Do not use this apparatus near water.
 - 6) Clean only with dry cloth.
 - 7) Do not block any ventilation openings. Install in accordance with the manufacturer's instructions.
 - 8) Do not install near any heat sources such as radiators, heat registers, stoves, or other apparatus (including amplifiers) that produce heat.
 - 9) Do not defeat the safety purpose of the polarized or grounding-type plug. A polarized plug has two blades with one wider than the other. A grounding type plug has two blades and a third grounding prong. The wide blade or the third prong are provided for your safety. If the provided plug does not fit into your outlet, consult an electrician for replacement of the obsolete outlet.
 - 10) Protect the power cord from being walked on or pinched particularly at plugs, convenience receptacles, and the point where they exit from the apparatus.
 - 11) Only use attachments/accessories specified by the manufacturer.
 - 12) Use only with the cart, stand, tripod, bracket, or table specified by the manufacturer, or sold with the apparatus. When a cart is used, use caution when moving the cart/apparatus combination to avoid injury from tip-over.
- 
- 13) Unplug this apparatus during lightning storms or when unused for long periods of time.

14) Refer all servicing to qualified service personnel. Servicing is required when the apparatus has been damaged in any way, such as power-supply cord or plug is damaged, liquid has been spilled or objects have fallen into the apparatus, the apparatus has been exposed to rain or moisture, does not operate normally, or has been dropped.

- Consult the dealer or an experienced radio/TV technician for help.

CAUTION

You are cautioned that any changes or modifications not expressly approved in this manual could void your authority to operate this equipment.

To reduce the risk of electric shock, the speaker cord should be connected to the apparatus and the speakers in accordance with the following instructions.

- 1) Disconnect the AC power cord from the MAINS.
- 2) Strip 10 to 15 mm of the wire insulation of the speaker cord.
- 3) Connect the speaker cord to the apparatus and the speakers carefully so as not to touch the core of speaker cord by hand. Also disconnect the AC power cord from the MAINS before disconnecting the speaker cord from the apparatus and the speakers.

Properly shielded and grounded cables and connectors must be used for connection to host computers and / or peripherals in order to meet FCC emission limits.

For the customers in Canada

Properly shielded and grounded cables and connectors must be used for connection to host computers and / or peripherals.

About the Lighting Control Adapter (UWA-C4Z)

This Class B digital apparatus complies with Canadian ICES-003.

The following FCC statement applies only to the version of this model manufactured for sale in the U.S.A. Other versions may not comply with FCC technical regulations.

This device complies with Part 15 of the FCC Rules. Operation is subject to the following two conditions: (1) this device may not cause harmful interference, and (2) this device must accept any interference received, including interference that may cause undesired operation.

NOTE:

This equipment has been tested and found to comply with the limits for a Class B digital device, pursuant to Part 15 of the FCC Rules. These limits are designed to provide reasonable protection against harmful interference in a residential installation.

This equipment generates, uses and can radiate radio frequency energy and, if not installed and used in accordance with the instructions, may cause harmful interference to radio communications. However, there is no guarantee that interference will not occur in a particular installation. If this equipment does cause harmful interference to radio or television reception, which can be determined by turning the equipment off and on, the user is encouraged to try to correct the interference by one or more of the following measures:

This equipment must not be co-located or operated in conjunction with any other antenna or transmitter.

This equipment complies with FCC radiation exposure limits set forth for an uncontrolled environment and meets the FCC radio frequency (RF) Exposure Guidelines in Supplement C to OET65. This equipment should be installed and operated keeping the radiator at least 20cm or more away from person's body (excluding extremities: hands, wrists, feet and ankles).

- Reorient or relocate the receiving antenna.
- Increase the separation between the equipment and receiver.
- Connect the equipment into an outlet on a circuit different from that to which the receiver is connected.

Operation is subject to the following two conditions: (1) this device may not cause harmful interference, and (2) this device must accept any interference, including interference that may cause undesired operation of this device.

continued

This equipment complies with IC radiation exposure limits set forth for an uncontrolled environment and meets RSS-102 of the IC radio frequency (RF) Exposure rules. This equipment should be installed and operated keeping the radiator at least 20cm or more away from person's body (excluding extremities: hands, wrists, feet and ankles).

About This Manual

- The instructions in this manual are for model STR-DA5800ES (the receiver). Check your model number by looking at the lower right corner of the front panel.
- The instructions in this manual describe mostly the operation of the receiver with the supplied remote control. You can also use the buttons or knobs on the receiver if they have the same or similar names as those on the remote control.

On Copyrights

This receiver incorporates Dolby* Digital and Pro Logic Surround and the DTS** Digital Surround System.

* Manufactured under license from Dolby Laboratories.

Dolby, Pro Logic, Surround EX, and the double-D symbol are trademarks of Dolby Laboratories.

** Manufactured under license under U.S. Patent No's: 5,956,674, 5,974,380, 5,978,762, 6,487,535, 6,226,616, 7,212,872, 7,003,467, 7,272,567, 7,668,723, 7,392,195, 7,333,929, 7,548,853 & other U.S. and worldwide patents issued and pending. DTS-HD, the Symbol, & DTS-HD and the Symbol together are registered trademarks & DTS-HD Master Audio is a trademark of DTS, Inc. Product includes software. © DTS, Inc. All Rights Reserved.

HDMI

This receiver incorporates High-Definition Multimedia Interface (HDMI™) technology.

The terms HDMI and HDMI High-Definition Multimedia Interface, and the HDMI Logo are trademarks or registered trademarks of HDMI Licensing LLC in the United States and other countries.

The font type (Shin Go R) installed in this receiver is provided by MORISAWA & COMPANY LTD. These names are the trademarks of MORISAWA & COMPANY LTD., and the copyright of the font also belongs to MORISAWA & COMPANY LTD.

iPhone, iPod, iPod classic, iPod nano, and iPod touch are trademarks of Apple Inc., registered in the U.S. and other countries.

All other trademarks and registered trademarks are of their respective holders. In this manual, ™ and ® marks are not specified.



“Made for iPod,” and “Made for iPhone” mean that an electronic accessory has been designed to connect specifically to iPod or iPhone, respectively, and has been certified by the developer to meet Apple performance standards. Apple is not responsible for the operation of this device or its compliance with safety and regulatory standards. Please note that the use of this accessory with iPod or iPhone may affect wireless performance.



DLNA™, the DLNA Logo and DLNA CERTIFIED™ are trademarks, service marks, or certification marks of the Digital Living Network Alliance.

MPEG Layer-3 audio coding technology and patents licensed from Fraunhofer IIS and Thomson.

“BRAVIA” Sync is a trademark of Sony Corporation.

“x.v.Color” and “x.v.Color” logo are trademarks of Sony Corporation.

“PlayStation®” is a registered trademark of Sony Computer Entertainment Inc.

“AVCHD” and the “AVCHD” logo are trademarks of Panasonic Corporation and Sony Corporation.

Windows Media is either a registered trademark or trademark of Microsoft Corporation in the United States and/or other countries.

This product contains technology subject to certain intellectual property rights of Microsoft. Use or distribution of this technology outside of this product is prohibited without the appropriate

license(s) from Microsoft.

Content owners use Microsoft PlayReady™ content access technology to protect their intellectual property, including copyrighted content. This device uses PlayReady technology to access PlayReady-protected content and/or WMDRM-protected content. If the device fails to properly enforce restrictions on content usage, content owners may require Microsoft to revoke the device’s ability to consume PlayReady-protected content. Revocation should not affect unprotected content or content protected by other content access technologies. Content owners may require you to upgrade PlayReady to access their content. If you decline an upgrade, you will not be able to access content that requires the upgrade.

“WALKMAN” and “WALKMAN” logo are registered trademarks of Sony Corporation.

“Android” is a registered trademark or a trademark of Google Inc.

InstaPrevue™ is a trademark or registered trademark of Silicon Image, Inc. in the United States and other countries.

The Control4 and the 4ball logos are registered trademarks of Control4 Corporation. All rights reserved.

This product contains software that is subject to the GNU General Public License (“GPL”) or GNU Lesser General Public License (“LGPL”). These establish that customers have the right to acquire, modify, and redistribute the source code of said software in accordance with the terms of the GPL or the LGPL.

For details of the GPL, LGPL and other software licenses, please refer to “System Settings” → “Software License” on the “Settings” menu on the receiver.

The source code for the software used in this product is subject to the GPL and LGPL, and is available on the Web. To download, please access the following:

URL: <http://www.sony.net/Products/Linux>

Please note that Sony cannot answer or respond to any inquiries regarding the content of this source code.

Main features of the receiver

Compatible with a variety of connections and formats

Feature	Description	Page
9.2 channels	The receiver can output up to 9.2 channels. The receiver supports a bi-amplifier connection of a front speaker.	24, 26
Compatible with various standards	The receiver is compatible with various audio formats, such as Dolby TrueHD, DTS-HD Master Audio, DSD, multi-channel Linear PCM, FLAC, etc.	22
HDMI (9 in 2 out + 1 zone out)	The receiver is equipped with 8 HDMI input jacks (of which two, HDMI IN 2 and IN 3, are the “for AUDIO” jacks which take sound quality into account) on the back panel, and 1 HDMI jack on the front panel. You can connect various equipment using an HDMI connection.	28, 30, 32, 33, 35, 37
	The receiver is compatible with various HDMI standards, such as Deep Color, “x.v.Color,” or 4K* and 3D transmission, Audio Return Channel (ARC), etc. * The HDMI IN 1, IN 2, and IN 9 jacks support 4K transmission.	36, 87
	4K The receiver can output 4K signals through its HDMI output jacks.	21, 36
	Fast View You can select an HDMI Input method that is faster than the normal selection (Fast View). HDMI IN 1, IN 2, IN 3, IN 4, and IN 9 jacks support the Fast View function.	115
	Control for HDMI You can operate the receiver and other equipment in conjunction with each other using the Control for HDMI function.	83, 114
Preview for HDMI	The receiver allows you to display a live picture-in-picture preview of an HDMI input connected to this receiver. Preview windows will be displayed only for HDMI IN 1/IN 2/IN 3/IN 4 Input. You can select each preview HDMI input using the remote control. (This function is made possible by Silicon Image InstaPrevue™ technology.)	90
Network	The receiver is equipped with four LAN ports that have switching hub functions.	44
	The receiver is compatible with Internet content streaming.	56
	The receiver allows you to play back content on a home network via the DLNA-compliant home network function.	54
USB	iPod/iPhone applicable USB port You can easily play back iPod/iPhone content via the receiver using a USB connection.	53
	You can easily play back content on a USB device/WALKMAN via the receiver using a USB connection.	52

Feature	Description	Page
Multi-zone	In addition to the main room, you can enjoy music and video in another room, different from the content in the main room.	75
	You can output HDMI signals from HDMI IN jacks to the HDMI ZONE 2 OUT jack.	21, 75, 79

Better image and sound quality

Feature	Description	Page
Image up-conversion	The receiver upscales or downscales analog video signals. The signals can be upscaled to 4k using an HDMI output jack. The receiver also upscales or downscales analog video signals for zone 2.	21
Digital Cinema Auto Calibration (D.C.A.C.) function	The receiver is equipped with the Digital Cinema Auto Calibration (D.C.A.C.) function. This function allows you to perform automatic calibration and settings of audio parameters to produce optimum sound.	99, 101
Sound fields	You can select from a variety of sound field modes according to speaker connections or input sources. The receiver is also provided with the following sound options: – Three modes to reproduce the sound characteristics of famous music halls: “Berlin Philharmonic Hall,” “Concertgebouw Amsterdam,” or “Musikverein Vienna.” – Two modes to match the position of the sound source to the screen: “Movie Height,” and “Vocal Height.”	62, 64
Raising the center speaker sounds to an appropriate height (Center Speaker Lift Up)	By using the front high speakers, you can lift up the sounds of the center speaker to an appropriate height on the screen. This function (Center Speaker Lift Up) allows you to enjoy natural representation without discomfort.	102
Reproducing front high speakers virtually (Virtual Front High)	The receiver can reproduce front high speakers virtually even when there are no actual front high speakers connected. This function allows you to reproduce the Center Speaker Lift Up effect using the front high speakers, as well as reproduce various sound field features utilizing the front high channels the receiver is equipped with.	101
High quality reproduction of compressed audio files	You can play back compressed audio files with high quality using the D.L.L. (Digital Legato Linear) function.	106
High quality digital Audio Transmission System (H.A.T.S.) function	The High quality digital Audio Transmission System (H.A.T.S.) function transmits signals from a Super Audio CD player connected via an HDMI connection with high quality.	114

Useful functions

Feature	Description	Page
Easy and accessible operations	The receiver is equipped with a GUI (Graphical User Interface). You can operate the receiver intuitively using a menu displayed on the TV screen.	49
	You can set the basic settings of the receiver easily using Easy Setup.	46
	A remote control for operating connected equipment and the Multi-zone function is supplied with the receiver.	18
	You can recall various settings of the receiver, including lighting scenes, all at one time with the press of the EASY AUTOMATION button.	71
Flexible functions	The Sound Optimizer function optimizes audio output in accordance with the volume level.	66
	The A/V Sync function adjusts the time gap between audio output and the visual display.	107
	The Pass Through function outputs HDMI signals to the TV, even when the receiver is in standby mode.	86

Others

Feature	Description	Page
Environment-friendly function	The Auto Standby function switches the receiver to standby mode automatically if you do not operate the receiver for a specific period of time or when there is no signal input to the receiver.	119
More useful	You can operate the receiver using a smartphone equipped with “ES Remote” application software.* * Compatible with an iPod touch/iPhone and Android phones	91
Lighting Control	The receiver allows you to operate Control4-compatible lighting devices. You can turn them on or off, and adjust the lighting level. You can also register settings combining multiple lighting devices as a lighting scene.	73
Universal Remote Control	The receiver allows you to operate your equipment such as a BD/DVD player with the supplied remote control by registering the player in advance.	68

Table of Contents

Main features of the receiver	6
Description and location of parts	11

Getting Started

Read the following before you connect any equipment	20
1: Installing speakers	24
2: Connecting the monitor	28
3: Connecting the video equipment	30
4: Connecting the audio equipment	37
5: Connecting the IR blaster	42
6: Making connections for using Lighting Control	43
7: Connecting to the network	44
8: Preparing the receiver and the remote control	45
9: Setting up the receiver using the Easy Setup	46
10: Setting up connected equipment	48
11: Preparing a computer to use as a server	49
Guide to on-screen display operation	49

Enjoying images/sound

Enjoying images/sound from connected equipment	51
USB Device/WALKMAN	52
iPod/iPhone	53
Home Network (DLNA)	54
Internet content	56
FM/AM	57

Enjoying Sound Effects

Selecting the sound field	61
Using the Sound Optimizer function	66
Adjusting the equalizer	66

Using the Universal Remote Control Function

Selecting the equipment you want to operate	68
Operating the AV equipment	68
Turning off all connected equipment (ROOM OFF)	70
Making Universal Remote Control settings	70

Using the Home Automation Function

Saving various settings for the receiver and recalling those settings all at one time (Easy Automation)	71
Lighting Control	73

Using Multi-zone Features

What you can do with the Multi-zone function	75
Making a multi-zone connection	75
Setting the speakers in zone 2	79
Setting the HDMI output in zone 2	79
Switching the zone setting of the remote control	80
Operating the receiver from another zone (ZONE 2/ZONE 3 operations)	81

Using Other Features

Using "BRAVIA" Sync features	83
Switching the monitors that output the HDMI video signals	86
Outputting the HDMI signals even when the receiver is in standby mode (Pass Through)	86
Switching between digital and analog audio	87
Using other video/audio input jacks	88

continued

Preview for HDMI	90
Operating the receiver using a smartphone	91
Using the sleep timer	92
Recording using the receiver	92
Switching the command mode of the receiver and the remote control	92
Using a bi-amplifier connection	94
Reverting back to the factory default settings	95

Adjusting Settings

Using the setting menu	96
Easy Setup	99
Speaker Settings	99
Audio Settings	106
Video Settings	109
HDMI Settings	113
Input Settings	115
Network Settings	116
Home Control Settings	117
Zone Settings	118
System Settings	119
Network Update	120
Operating without using the GUI	121

Additional Information

Precautions	128
Troubleshooting	129
Specifications	141
Index	145

Description and location of parts

Front panel

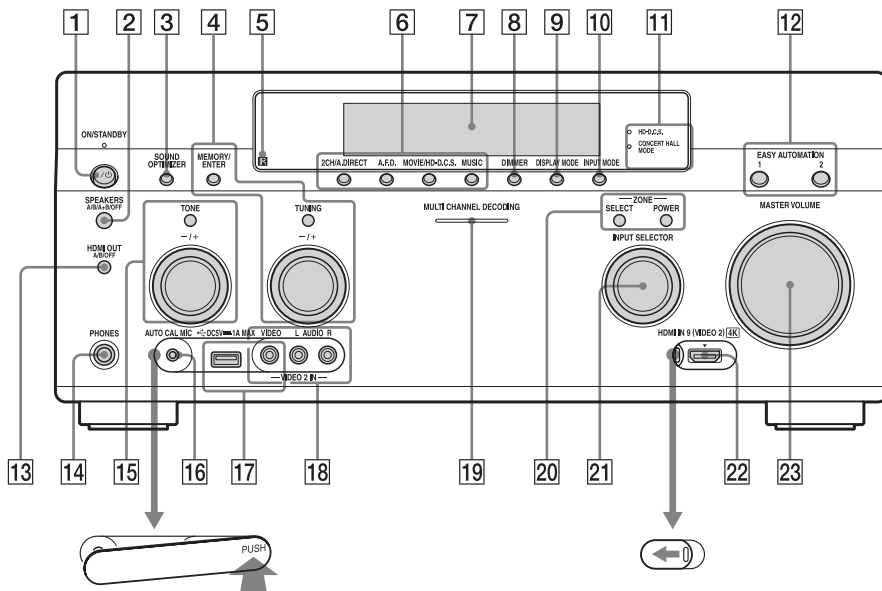

To remove the cover

Press PUSH.

When you remove the cover, keep it out of reach from children.

To open the cover

Slide the cover to the left.

1 I/O ON/STANDBY

Turns the receiver on or off.

The lamp above the button lights up as follows:

Green: The receiver is turned on.
Amber: The receiver is in standby mode, and

- “Control for HDMI” (page 114) or “Network Standby” (page 116) is set to “On.”
- “Pass Through” (page 114) is set to “On” or “Auto.”
- The receiver in zone 2 or zone 3 is turned on.

The lamp turns off when the receiver is in standby mode and the above settings are off.

2 SPEAKERS (A/B/A+OFF) (page 47)

3 SOUND OPTIMIZER (page 66)

4 MEMORY/ENTER, TUNING +/- (page 60)

5 Remote sensor

Receives signals from remote control.

6 2CH/A.DIRECT, A.F.D., MOVIE/HD-D.C.S., MUSIC (page 61, 62)

7 Display window (page 13)

continued

- 8 DIMMER**
Press DIMMER repeatedly to adjust the brightness of the display window.
- 9 DISPLAY MODE (page 127)**
- 10 INPUT MODE (page 87)**
- 11 HD-D.C.S. lamp (page 62)**
Lights up when the HD-D.C.S. sound field is selected.
- CONCERT HALL MODE lamp (page 64)**
Lights up when one of the Berlin Philharmonic Hall, Concertgebouw Amsterdam, or Musikverein Vienna sound fields is selected.
- 12 EASY AUTOMATION 1, 2 (page 71)**
- 13 HDMI OUT (A/B/OFF) (page 86)**
- 14 PHONES jack**
Connects to headphones.
- 15 TONE +/-**
Press TONE repeatedly to select the speaker and range. Then turn the dial to adjust the bass/middle/treble level of the speaker.
- 16 AUTO CAL MIC jack (page 99)**
Connect the supplied optimizer microphone for “Auto Calibration” to this jack.
- 17 iPod/iPhone (↔) (USB) port and VIDEO IN jack) (page 35, 52, 53)**
- 18 VIDEO 2 IN jacks (page 35)**
- 19 MULTI CHANNEL DECODING lamp**
Lights up when multi-channel audio signals are decoded.
- 20 ZONE SELECT, POWER (page 82)**
- 21 INPUT SELECTOR (page 51)**
- 22 HDMI IN 9 (VIDEO 2) jack (page 36)**
- 23 MASTER VOLUME (page 51)**

Indicators on the display

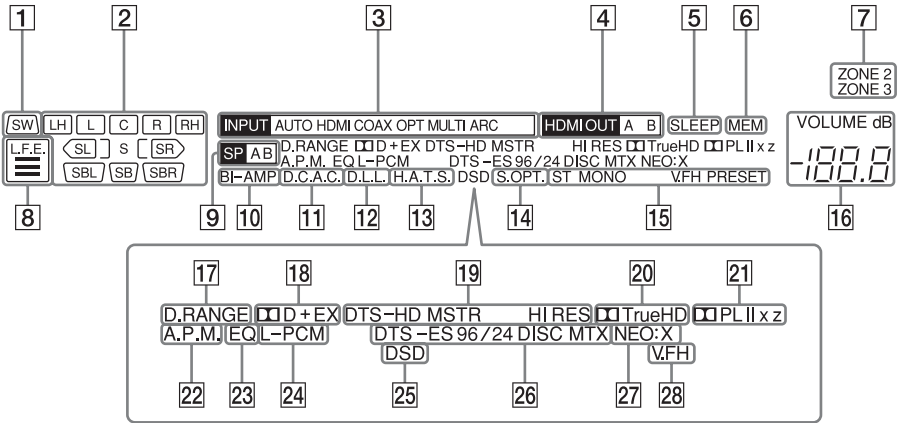

1 SW

Lights up when subwoofer(s) is (are) connected and the audio signal is output from the PRE OUT SUBWOOFER jack(s).

2 Playback channel indicator

Indicates the speaker that is designated to output sound. Shows how the receiver down-mixes or up-mixes the source sound, based on the speaker settings.

- L**
Front Left
- R**
Front Right
- C**
Center
- LH**
Left High
- RH**
Right High
- SL**
Surround Left
- SR**
Surround Right
- SBL**
Surround Back Left
- SBR**
Surround Back Right

SB

Surround Back

Example:

Recording format: 5.1
Speaker pattern: 3/0.1
Sound Field: A.F.D. Auto

[SW] [L] [C] [R]

3 INPUT indicator

Lights up to indicate the current input.

AUTO

The INPUT MODE is set to "AUTO."

HDMI

COAX

OPT

MULTI (MULTI CHANNEL INPUT) ARC (page 87)

4 HDMI OUT A/B (page 86)

5 SLEEP (page 92)

6 MEM

Lights up when the preset memory function is activated.

7 ZONE 2/ZONE 3 (page 75)

8 L.F.E.

Lights up when input signals being played back contain an L.F.E. (Low Frequency Effects) channel. The L.F.E. channel signal is actually being reproduced, the bars underneath the

continued

letters light up to indicate the level. Since the L.F.E. signal is not recorded in all parts of the input signal, the bar indication will fluctuate (and may turn off) during playback.

9 Speaker system indicator (page 47)

10 BI-AMP (page 94)

11 D.C.A.C. (page 99)

Lights up when the measurement results of the “Auto Calibration” function are applied.

12 D.L.L. (page 106)

13 H.A.T.S. (page 114)

14 S.OPT.

Lights up when the sound optimizer function is activated (page 66).

15 Tuning indicator

Lights up when the receiver tunes to a radio station.

ST

Stereo reception

MONO

FM mode is set to the monaural mode.

PRESET

The tuning mode is set to the preset mode.

16 VOLUME

Displays the current volume.

17 D.RANGE

Lights up when dynamic range compression is activated.

18 Dolby Digital Surround indicator

Lights up with one of the respective indicators when the receiver is decoding the corresponding Dolby Digital format signals.

DD

Dolby Digital

DD+

Dolby Digital Plus

DD EX

Dolby Digital Surround EX

19 DTS-HD indicator

Lights up when the receiver is decoding DTS-HD.

DTS-HD

Lights up constantly with the one of the following indicators.

MSTR

DTS-HD Master Audio

HI RES

DTS-HD High Resolution Audio

20 DDDTrueHD

Lights up when the receiver is decoding Dolby TrueHD.

21 Dolby Pro Logic indicator

Lights up with one of the respective indicators when the receiver performs Dolby Pro Logic processing. This matrix surround decoding technology can enhance input signals.

DDPL

Dolby Pro Logic

DDPLII

Dolby Pro Logic II

DDPLIIX

Dolby Pro Logic IIX

DDPLIIZ

Dolby Pro Logic IIZ

22 A.P.M. (page 101)

Lights up when the A.P.M. (Automatic Phase Matching) function is activated.

23 EQ

Lights up when the equalizer is activated.

24 L-PCM

Lights up when Linear PCM (Pulse Code Modulation) signals are input.

25 DSD

Lights up when the receiver is receiving DSD (Direct Stream Digital) signals.

26 DTS-(ES) indicator

Lights up when DTS or DTS-ES signals are input.

DTS

Lights up when the receiver is decoding DTS signals.

DTS-ES

Lights up with one of the following indicators, depending on the input signal decoding format.

96/24

DTS 96/24 (96 kHz/24 bit) decoding

DISC

DTS-ES Discrete 6.1

MTX

DTS-ES Matrix 6.1

27 NEO:X

Lights up when DTS Neo:X Cinema/Music/Game decoding is activated.

28 V.FH

Lights up when the Virtual Front High feature is enabled so that the sound output from the front speakers can be virtually reproduced, even in an environment without front L/R speakers.

Rear panel

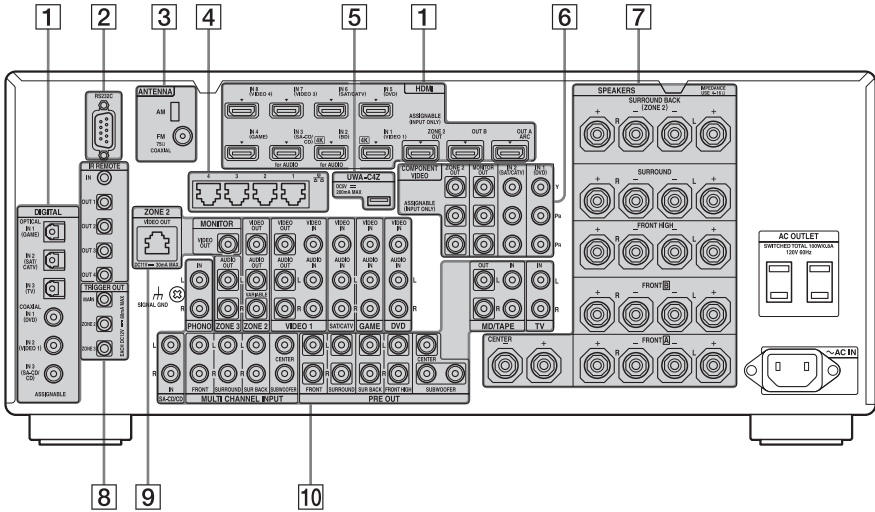

1 DIGITAL INPUT/OUTPUT section



OPTICAL IN jacks
(page 28, 32, 33)



COAXIAL IN jacks
(page 31, 38)



HDMI IN/OUT* jacks
(page 28, 30, 32, 33)

2 RS232C port



Used for maintenance and service.

3 ANTENNA section



AM ANTENNA jack
(page 40)



FM ANTENNA jack
(page 40)

4 LAN ports (switching hubs)

(page 44)



5 UWA-C4Z

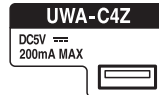

Connect the supplied Lighting Control Adapter (UWA-C4Z) to this port.

6 COMPONENT VIDEO INPUT/OUTPUT section

(page 28, 31, 33)



Y, P_B, P_R IN/OUT* jacks

7 SPEAKERS section

(page 26)



8 Control jacks for Sony and other external equipment

 **IR REMOTE IN/OUT jacks (page 75)**

Connect an IR repeater (not supplied) to IN to use the Multi-zone function.
Connect an IR blaster (supplied) to OUT to use the Universal Remote Control function.

 **TRIGGER OUT jacks (page 118)**

Connect to interlock on/off of the power supply of other 12V TRIGGER compliant equipment.

9 VIDEO/AUDIO INPUT/OUTPUT section (page 28, 31, 32, 33, 34)

L  **AUDIO IN/OUT jacks**



 **VIDEO IN/OUT* jacks**



**AUDIO OUT jacks
VIDEO OUT jack
(page 75)**



**ZONE 2 VIDEO OUT jack
(page 77)**

An RJ-45 jack used to send a video signal to the equipment in zone 2. Use a CAT5 cable for the connection. Used for custom installation. For information on how to use this jack, consult your dealer.

Attention

Do not use this jack for an Ethernet LAN connection. Doing so may cause a malfunction.

10 AUDIO INPUT/OUTPUT section

L  **AUDIO IN/OUT jacks
(page 38, 41)**
R 



MULTI CHANNEL INPUT jacks (page 38)



PRE OUT jacks

Connect to an external power amplifier.

* You must connect the HDMI OUT or MONITOR OUT jack to your TV to watch the selected input image (page 28).

Remote control (RM-AAU194)

Use the supplied remote control to operate this receiver and other equipment.

Note

Do not expose the remote sensor to direct sunlight or lighting apparatuses. Doing so may cause a malfunction.

Tip

When the receiver no longer responds to the remote control, replace all the batteries with new ones.

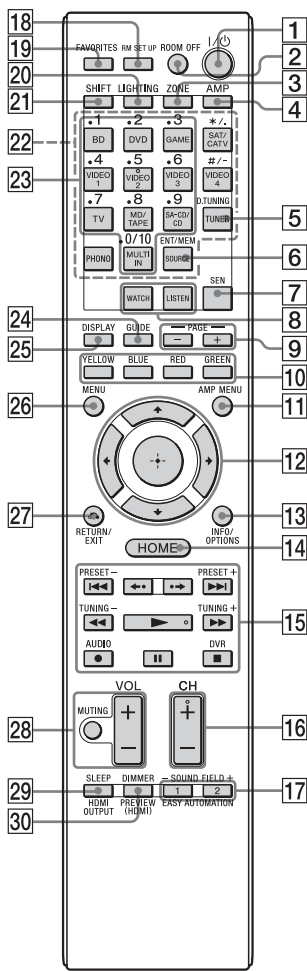

1 I/⏻ (on/standby)

Turns the receiver on or off.

2 ROOM OFF

Turns all the connected devices in the room on or off.

3 ZONE (page 75)

4 AMP

Activates the receiver operation for the main zone.

5 D.TUNING (page 58)

Press SHIFT (21), then press D.TUNING to enter direct tuning mode.

6 ENT/MEM

Press SHIFT (21), then press ENT/MEM to enter the value or track using the numeric buttons (23), or press ENT/MEM, then press the numeric buttons (23) to select a preset number to which a station is stored during tuner operation.

7 SEN

Accesses the home page of the Sony Entertainment Network (SEN), a network service provided by Sony.

8 WATCH, LISTEN (page 51)

9 PAGE +/- (page 68)

Allows you to scroll quickly through lists of media.

10 Color buttons

Works according to the guide on the TV screen.

11 AMP MENU (page 121)

12 ⏻ ⬆️ ⬇️ ⬅️ ➡️ ⬆️

Press ⬆️/⬇️/⬅️/➡️ to select the menu items. Then press ⏻ to enter the selection.

13 INFO/OPTIONS (page 50, 57, 60)

Displays and selects items from the options menu. The INFO button is mapped to an info function for certain devices.

14 HOME (page 50)

Displays the home menu on the TV screen.

- 15** ◀▶/▶▶ 1), ■ 1), || 1), ▶▶ 1) 2),
◀◀/▶▶ 1), ● 1)

Press the buttons to operate the DVD player, Blu-ray Disc Player, CD player, MD deck, tape deck, equipment connected to the  (USB) port or to the network, or Internet, etc.

TUNING +/-

Press SHIFT (21), then press TUNING +/- to select a station.

PRESET +/-

Press SHIFT (21), then press PRESET +/- to select preset stations.

AUDIO 3)

Press SHIFT (21), then press AUDIO to select audio format/track.

DVR

Press SHIFT (21), then press DVR to jump to the DVR capabilities of DVR capable devices.

◀././▶ 3)

Press ◀././▶ to

- replay the previous scene or fast forward the current scene.
- skip to the previous or next album when using an iPod/iPhone.

- 16** CH + 2)/-

Scans channels on the selected device.

- 17** SOUND FIELD +/- (page 61, 62, 64),
EASY AUTOMATION 1, 2 (page 71)

- 18** RM SET UP (page 92)

- 19** FAVORITES (page 56)

- 20** LIGHTING (page 73)

- 21** SHIFT

Changes the remote control button function to activate the buttons printed in pink.

- 22** Input buttons

Press one of the buttons to select the equipment you want to use. When you press any of the input buttons, the receiver turns on.

***./, #-**

Press SHIFT (21), then press the buttons. The special #, -, ., and * keys are used mostly for HD channel selection.

- 23** Numeric buttons

Press SHIFT (21), then press numeric buttons to input numbers.

Press numeric buttons to select channel numbers of the TV.

- 24** GUIDE

Press SHIFT (21), then press GUIDE to display the on-screen program guide.

- 25** DISPLAY

Displays the control panel on the TV screen when playing back content via Internet or a home network.

- 26** MENU

Brings up a device specific menu on most devices. For DVD players, the MENU button takes the user to the DVD menu.

- 27** RETURN/EXIT ↶

Returns to the previous menu or exit the menu.

- 28** VOL +/- (page 51)

Adjusts the volume of the selected equipment.

MUTING (page 51)

Turns off the sound of the selected equipment temporarily.

- 29** SLEEP (page 92), HDMI OUTPUT (page 86)

- 30** DIMMER

Press SHIFT (21), then press DIMMER repeatedly to adjust the brightness of the display window.

PREVIEW (HDMI) (page 90)

Press PREVIEW (HDMI) to open picture-in-picture screens to preview input from four HDMI IN jacks.

¹⁾See the table on page 69 for information on the buttons that you can use to control each types of equipment.

²⁾A tactile dot is attached to these buttons (5/VIDEO 2, ▶, CH +). Use it as a mark of operation.

³⁾Functions are available only for a USB input or a Sony Entertainment Network (SEN).

Note

The above explanations are intended to serve as examples.

Getting Started

Read the following before you connect any equipment

Before connecting cords, make sure to disconnect the AC power cord (mains lead).

Installing Speakers

See "1: Installing speakers" (page 24).

Connecting the monitor

See "2: Connecting the monitor" (page 28).

Connecting the video equipment

The image quality depends on the connecting jack. See the illustration on the right. Select the connection according to the jacks on your equipment.

The receiver has a video conversion function. For details, see "Function for conversion of video signals" (page 21). See "3: Connecting the video equipment" (page 30).

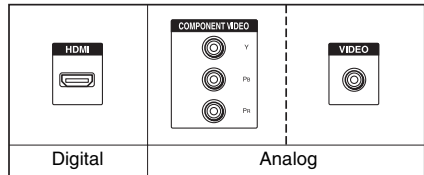

Connecting the audio equipment

See "4: Connecting the audio equipment" (page 37).

Preparing the receiver and the remote control

See "8: Preparing the receiver and the remote control" (page 45).

Setting the receiver

See "9: Setting up the receiver using the Easy Setup" (page 46).

Setting the audio output settings on the connected equipment

See "10: Setting up connected equipment" (page 48).

For details on a multi-zone connection, see page 75.

For details on a bi-amplifier connection, see page 94.

Function for conversion of video signals

This receiver is equipped with a function for converting video signals.

- Composite video signals can be output as HDMI video and component video signals.
- Component video signals can be output as HDMI video and video signals.

As the factory default setting, video signals input from the connected equipment are output to the HDMI OUT or MONITOR OUT jacks as shown in the table below.

We recommend you set the video conversion function to match the resolution of the monitor you are using.

For details on the video converting function, see “Video Settings” (page 109).

OUTPUT jack \ INPUT jack	HDMI OUT A/B (up to 4K)	COMPONENT VIDEO MONITOR OUT (up to 1080i)	MONITOR VIDEO OUT	VIDEO 1 OUT
HDMI IN	○	—	—	—
VIDEO IN	○*	○**	○**	○
COMPONENT VIDEO IN	○*	○**	○**	—

○ : Video signals are output.

— : Video signals are not output.

* When “Auto” is selected in “Resolution,” up to 4K up-scaling is enabled.

To enjoy 4K signals, a 4K-compatible monitor must be connected.

** Video signals may not be output, depending on the setting in “Resolution” (page 109).

Note on converting video signals

Video signals for which the resolution has been converted may not be output from the COMPONENT VIDEO MONITOR OUT jacks or the HDMI OUT jacks simultaneously.

If you connect equipment to both the COMPONENT VIDEO MONITOR OUT jacks and the HDMI OUT jacks, priority is given to the output from the HDMI OUT jacks.

Note on Zone 2 HDMI video output

Only HDMI IN input signals can be output through the HDMI ZONE 2 OUT jack.

To display Closed Caption

Set “Resolution” to “Direct” in the Video Settings menu when receiving a signal that supports Closed Captions.

Use the same kind of cords for the input/output signals.

To connect a recording device

When recording, connect the recording device to the VIDEO OUT jacks of the receiver.

Connect cords for input and output signals to the same type of jack, as VIDEO OUT jacks do not have an up-conversion function.





The HDMI OUT and the MONITOR OUT jacks cannot be used for recording.

Digital audio formats supported by the receiver

Digital audio formats that this receiver can decode depend on digital audio input jacks of the equipment connected.

This receiver supports the following audio formats.

Connection between the playback equipment and the receiver

Audio format	Maximum number of channels	COAXIAL/OPTICAL	HDMI
Dolby Digital 	5.1ch	○	○
Dolby Digital EX 	6.1ch	○	○
Dolby Digital Plus* 	7.1ch	—	○
Dolby TrueHD* 	7.1ch	—	○
DTS 	5.1ch	○	○
DTS-ES 	6.1ch	○	○
DTS 96/24 	5.1ch	○	○
DTS-HD High Resolution Audio* 	7.1ch	—	○
DTS-HD Master Audio* 	7.1ch	—	○
DSD* 	5.1ch	—	○
Multi-Channel Linear PCM*	7.1ch	—	○

* Audio signals are output in another format if the playback equipment does not correspond to the format. For details, refer to the operating instructions of the playback equipment.

Network/USB

Type of content	File format	Extensions
Music	WAV ⁵⁾	“.wav”
	WMA ^{1) 2) 4)}	“.wma”
	MP3	“.mp3”
	AAAC ^{1) 2) 4)}	“.m4a”
	FLAC ⁵⁾	“.flac”
Video ⁶⁾	MPEG-1 Video/PS ¹⁾ MPEG-2 Video/PS, TS ¹⁾	“.mpg,” “.mpeg,” “.m2ts,” “.mts”
	MPEG-4 AVC ¹⁾	“.mkv,” “.mp4,” “.m4v,” “.m2ts,” “.mts”
	WMV9 ¹⁾	“.wmv,” “.asf”
	AVCHD	3)
	Xvid	“.avi”
Photo	JPEG	“.jpg,” “.jpeg,” “.mpo”
	PNG	“.png”
	GIF	“.gif”

- 1) The receiver does not play coded files such as DRM.
- 2) The receiver may not play a file of this format placed on a DLNA server.
- 3) The receiver plays AVCHD format files that are recorded on a digital video camera, etc.
- 4) The receiver cannot play an encrypted file such as a lossless file.
- 5) Compatible sampling frequency/bit depth: Maximum 192 kHz/24 bit
- 6) For USB devices only

Notes

- Some files may not play depending on the file format, file encoding, recording condition, or DLNA server condition.
- Some files edited on a computer may not play.
- The receiver can recognize the following files or folders in USB devices:
 - up to folders in the 3rd tree
 - up to 500 files in a single tree
- The receiver can recognize the following files or folders stored in the DLNA server:
 - up to folders in the 18th tree
 - up to 999 files in a single tree
- Concerning the formats defined in the DLNA guidelines, the server is required to offer the content to which the format information defined in the DLNA guidelines has been added properly.

1: Installing speakers

This receiver allows you to use up to a 9.2 channel system (9 speakers and two subwoofers).

Examples of speaker system configuration

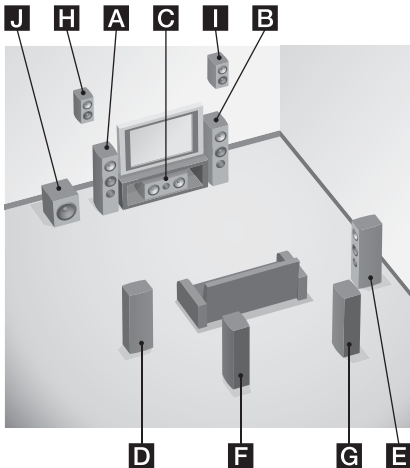

9.1 channel speaker system

You can enjoy high-quality multi-channel surround sound maximally just you would in an ideal dubbing theater in 9.1 channel or 9.2 channel format.

- A** Front left speaker
- B** Front right speaker
- C** Center speaker
- D** Surround left speaker
- E** Surround right speaker
- F** Surround back left speaker
- G** Surround back right speaker
- H** Left high speaker
- I** Right high speaker
- J** Subwoofer

7.1 channel speaker system using surround back speakers

You can enjoy high fidelity reproduction of DVD or Blu-ray Disc software recorded sound in 6.1 channel or 7.1 channel format.

- A** Front left speaker
- B** Front right speaker
- C** Center speaker
- D** Surround left speaker
- E** Surround right speaker
- F** Surround back left speaker
- G** Surround back right speaker
- J** Subwoofer

7.1 channel speaker system using front high speakers

You can enjoy vertical sound effects (e.g., Pro Logic IIz mode, Neo:X mode).

- A** Front left speaker
- B** Front right speaker
- C** Center speaker
- D** Surround left speaker
- E** Surround right speaker
- H** Left high speaker
- I** Right high speaker
- J** Subwoofer

5.1 channel speaker system

To fully enjoy theater-like multi-channel surround sound requires five speakers (two front speakers, a center speaker, and two surround speakers) and a subwoofer (5.1 channel system).

- A** Front left speaker
- B** Front right speaker
- C** Center speaker
- D** Surround left speaker
- E** Surround right speaker
- J** Subwoofer

Recommended speaker placement

9 or 7 channel speaker system

- The angle **A** shown in the illustration should be the same.

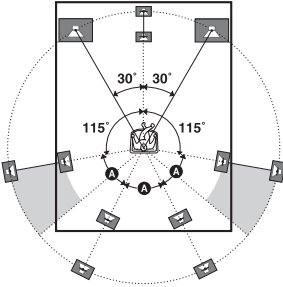

- If you cannot place the speakers at the optimum angle, separate the surround speakers and the surround back speakers adequately and arrange them as symmetrically as possible.
- You can calibrate speaker positioning using “Speaker Relocation” even if you cannot place the speakers at the optimum angle (page 102). Arrange the surround back speakers spread further back than 90 degrees to operate “Speaker Relocation” effectively.
- Install the front high speakers at the same angle as that of the front speakers. The position should be at a height on or above an extended diagonal line across the screen of a TV or monitor.

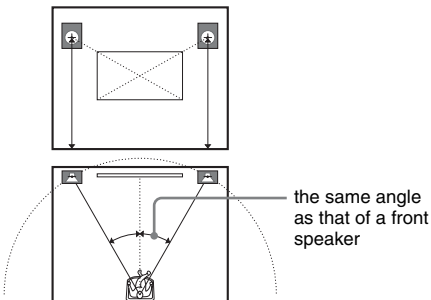

6 channel speaker system

- Place the surround back speaker behind the seating position.

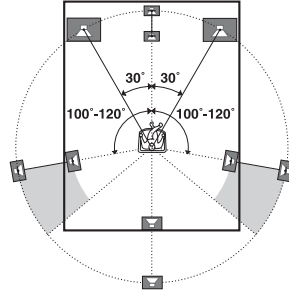

Tip

Since the subwoofer does not emit highly directional signals, you can place it wherever you want.

Connecting speakers

Before connecting cords, make sure to disconnect the AC power cord (mains lead).

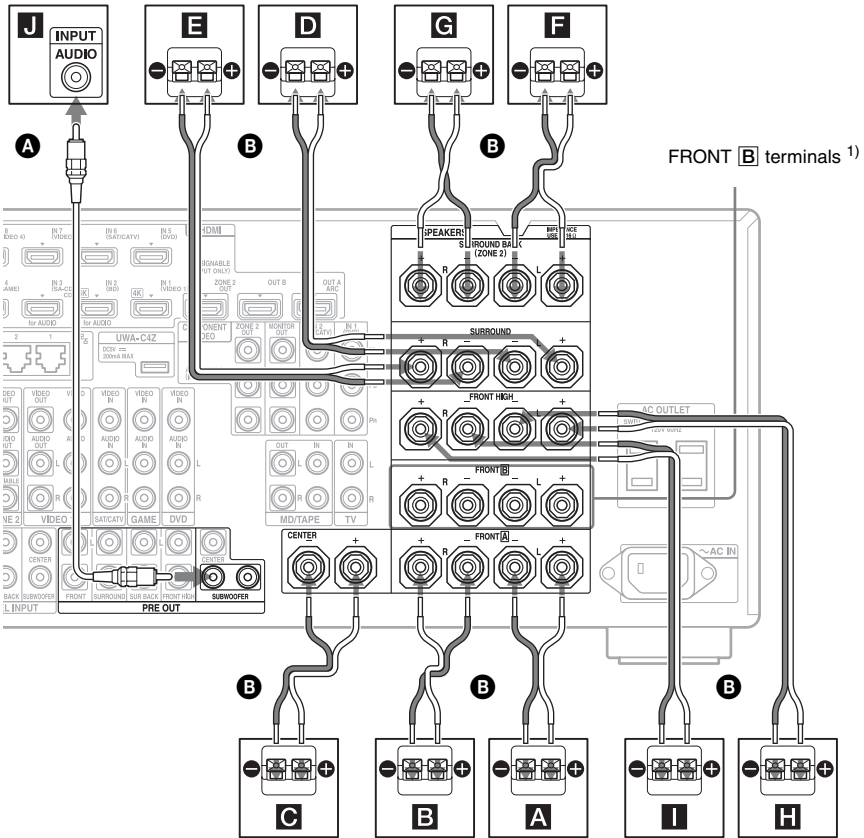

- A** Monaural audio cord (not supplied)
- B** Speaker cords (not supplied)

- A** Front speaker **A** (L)
- B** Front speaker **A** (R)
- C** Center speaker
- D** Surround speaker (L)²⁾
- E** Surround speaker (R)
- F** Surround back speaker (L)²⁾
- G** Surround back speaker (R)²⁾
- H** Front high speaker (L)
- I** Front high speaker (R)
- J** Subwoofer³⁾

- ¹⁾ If you have an additional front speaker system, connect it to the FRONT **B** terminals. You can select the front speaker system you are using with SPEAKERS on the front panel (page 11).
- ²⁾ If you connect only one surround back speaker, connect it to the SURROUND BACK (ZONE 2) L terminals.
- ³⁾ When you connect a subwoofer with an auto standby function, turn off the function when watching movies. If the auto standby function of the subwoofer is set to on, it goes into standby automatically based on the level of the input signal to the subwoofer, and the sound may not be output.

You can connect two subwoofers to the receiver. The same signals are output from each of the PRE OUT SUBWOOFER jacks.

Tip

You can loosen or tighten the SPEAKERS terminal easily using the supplied speaker cord connection tool.

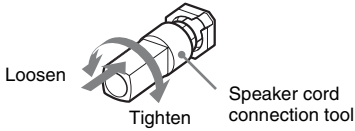

ZONE 2 connection

Only if you do not use surround back speakers, you can assign the SURROUND BACK (ZONE 2) terminals **F** and **G** to the speakers of zone 2. Set the SURROUND BACK (ZONE 2) terminals to “Zone2 Speakers” in “Speaker Connection” in the Speaker Settings menu (page 101).

See “Using Multi-zone Features” (page 75) for details on connection and operation in zone 2.

2: Connecting the monitor

You can watch the selected input image when you connect the HDMI OUT or MONITOR OUT jacks to a TV. You can operate this receiver using the on-screen GUI (Graphical User Interface).

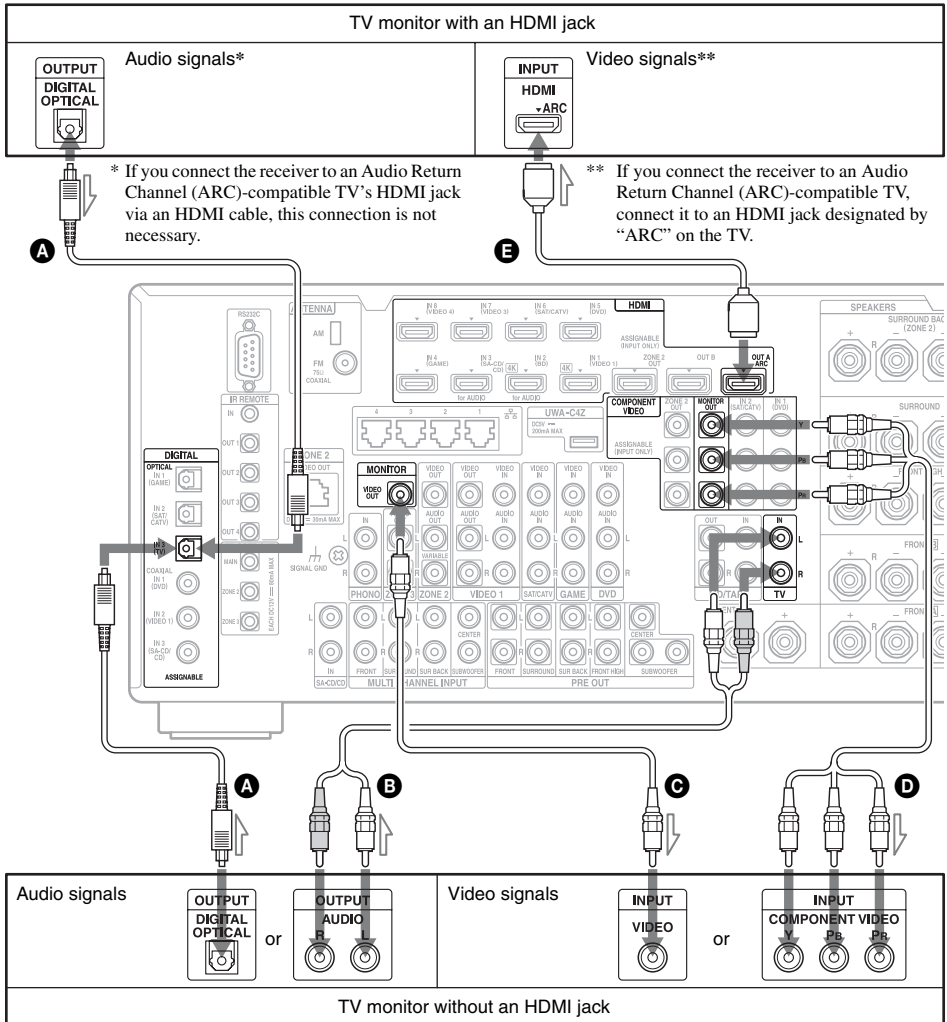

It is not necessary to connect all the cords. Connect cords according to the jacks of your equipment.

- A** Optical digital cord (not supplied)
- B** Audio cord (not supplied)
- C** Video cord (not supplied)
- D** Component video cord (not supplied)

- E** HDMI cable (not supplied)
We recommend that you use a Sony HDMI cable.

TV type	Audio Return Channel (ARC)	Required cable (cord)	
		Video	Audio
HDMI equipped	Compatible*	E	–
	Incompatible	E	A or B **
Non-HDMI equipped	–	D or C	A or B **

* You can output the TV's sound (multi-channel surround sound) from the receiver only by connecting the TV with an HDMI cable.

** If you want to output multi-channel surround sound from the receiver, use **A** for the audio connection.

Notes

- If you connect the TV to the receiver using video cord, set "Playback Resolution" to "480i/576i" (page 112).
- When connecting optical digital cords, insert the plugs straight until they click into place.
- Do not bend or tie optical digital cords.

Tip

The sound of the TV is output from the speakers connected to the receiver if you connect the audio output jack of the TV and the TV IN jacks of the receiver. In this configuration, set the sound output jack of the TV to "Fixed" if it can be switched between either "Fixed" or "Variable."

3: Connecting the video equipment

Connections required for watching content recorded on Blu-ray Discs or DVDs

To connect equipment with HDMI jacks

If your equipment does not have an HDMI jack, see page 31.

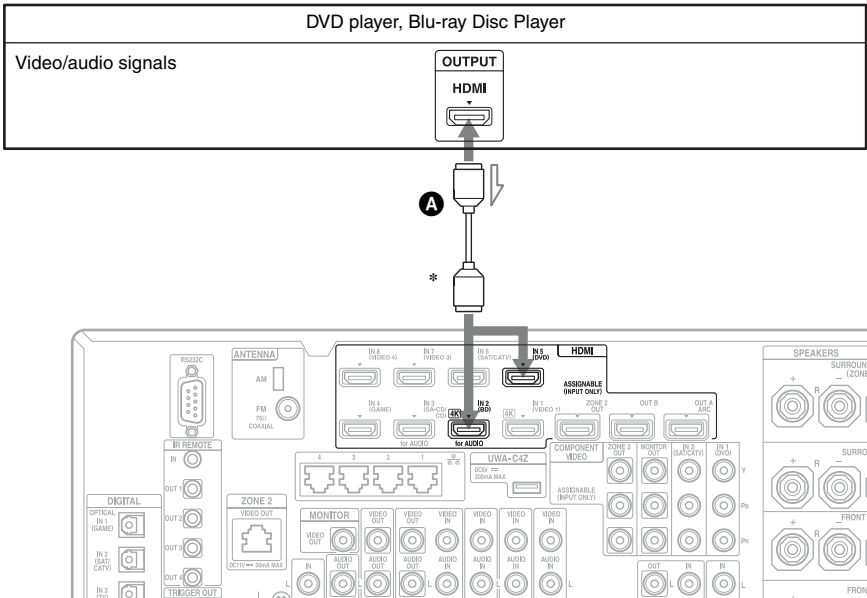

A HDMI cable (not supplied)
We recommend that you use a Sony HDMI cable.

* You can connect any equipment with HDMI output jacks to the HDMI IN jacks of the receiver.

To connect equipment with jacks other than HDMI jacks

It is not necessary to connect all the cords. Connect cords according to the jacks of your equipment.

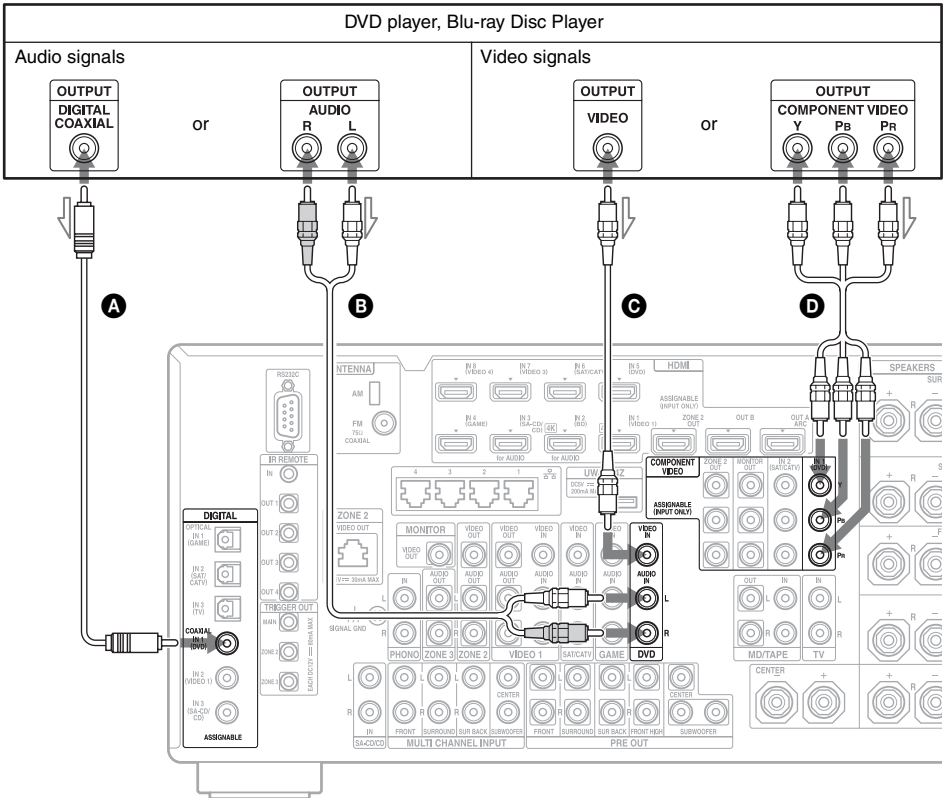

- A** Coaxial digital cord (not supplied)
- B** Audio cord (not supplied)
- C** Video cord (not supplied)
- D** Component video cord (not supplied)

Connections required for playing video games

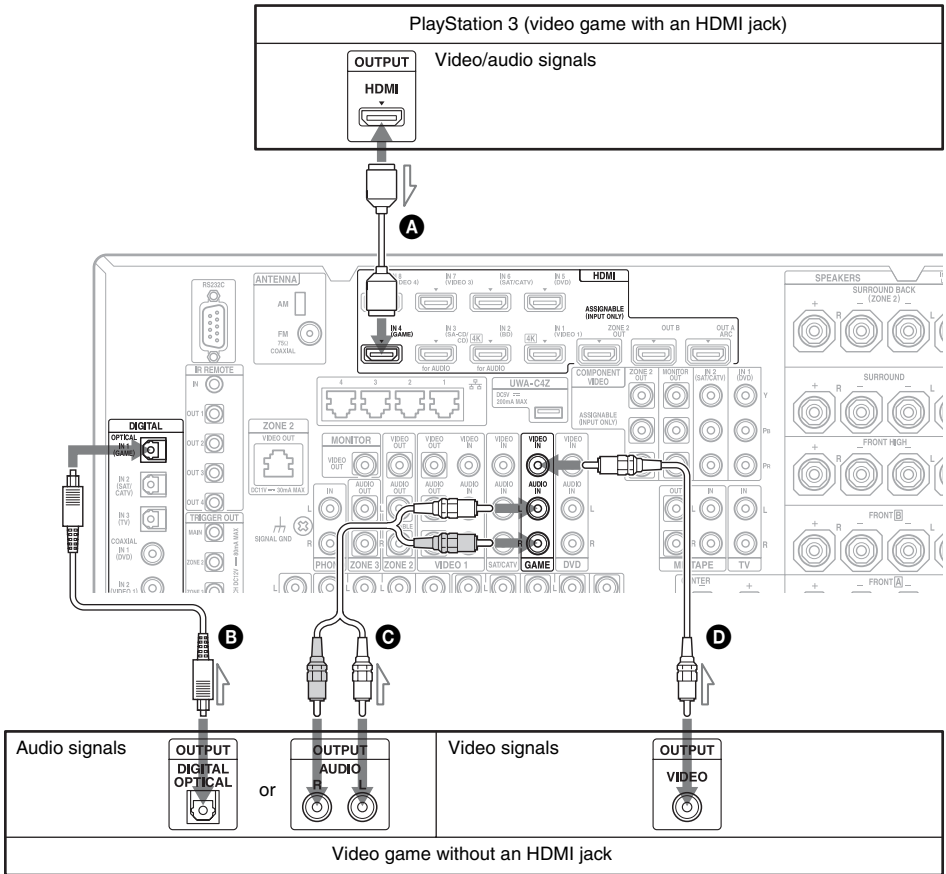

It is not necessary to connect all the cords. Connect cords according to the jacks of your equipment.

- A** HDMI cable (not supplied)
- B** Optical digital cord (not supplied)
- C** Audio cord (not supplied)
- D** Video cord (not supplied)

Video game type	Required cable (cord)	
	Video	Audio
HDMI equipped*	A	—
Non-HDMI equipped	D	B or C **

* You can output the video game's sound (multi-channel surround sound) from the receiver only by connecting the video game with an HDMI cable.
 ** If you want to output multi-channel surround sound from the receiver, use **B** for the audio connection.

Notes

- When connecting optical digital cords, insert the plugs straight until they click into place.
- Do not bend or tie optical digital cords.

Connections required for watching programs via satellite broadcasting or via a cable TV

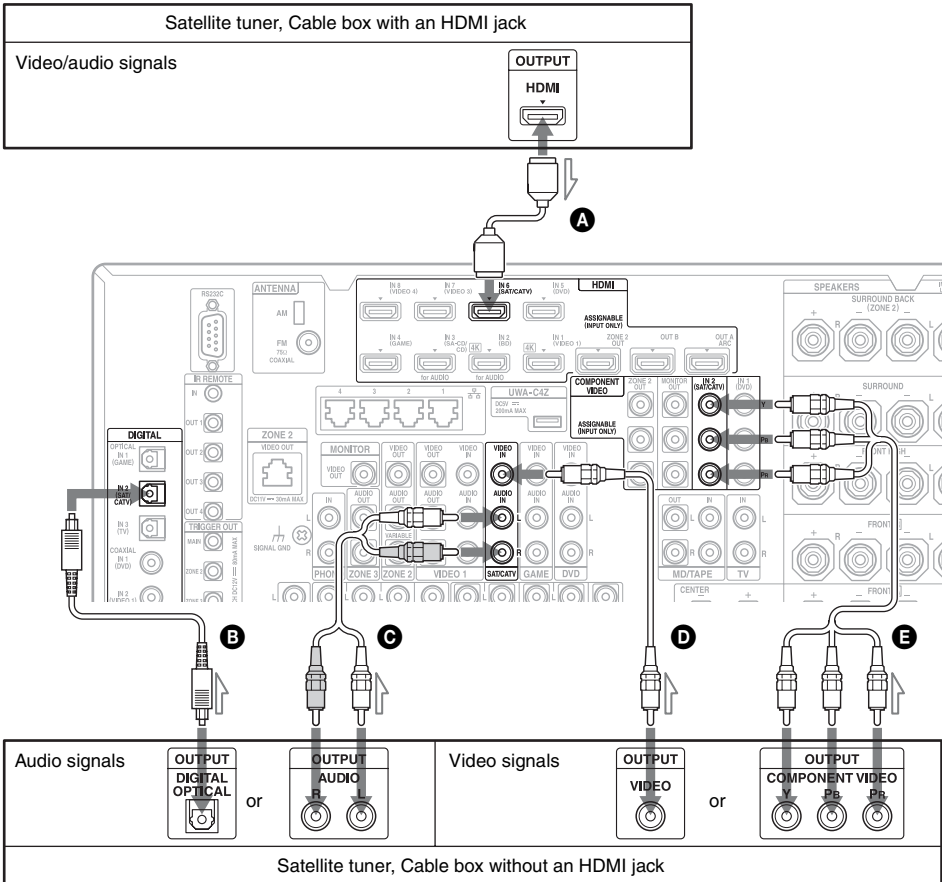

It is not necessary to connect all the cords. Connect cords according to the jacks of your equipment.

- A** HDMI cable (not supplied)
- B** Optical digital cord (not supplied)
- C** Audio cord (not supplied)
- D** Video cord (not supplied)
- E** Component video (not supplied)

Satellite tuner/Cable box type	Required cable (cord)	
	Video	Audio
HDMI equipped*	A	—
Non-HDMI equipped	E or D	B or C **

* You can output the satellite tuner/cable box's sound (multi-channel surround sound) from the receiver only by connecting the satellite tuner/cable box with an HDMI cable.

** If you want to output multi-channel surround sound from the receiver, use **B** for the audio connection.

continued

Notes

- When connecting optical digital cords, insert the plugs straight until they click into place.
- Do not bend or tie optical digital cords.

Connections required for watching content recorded on video tapes

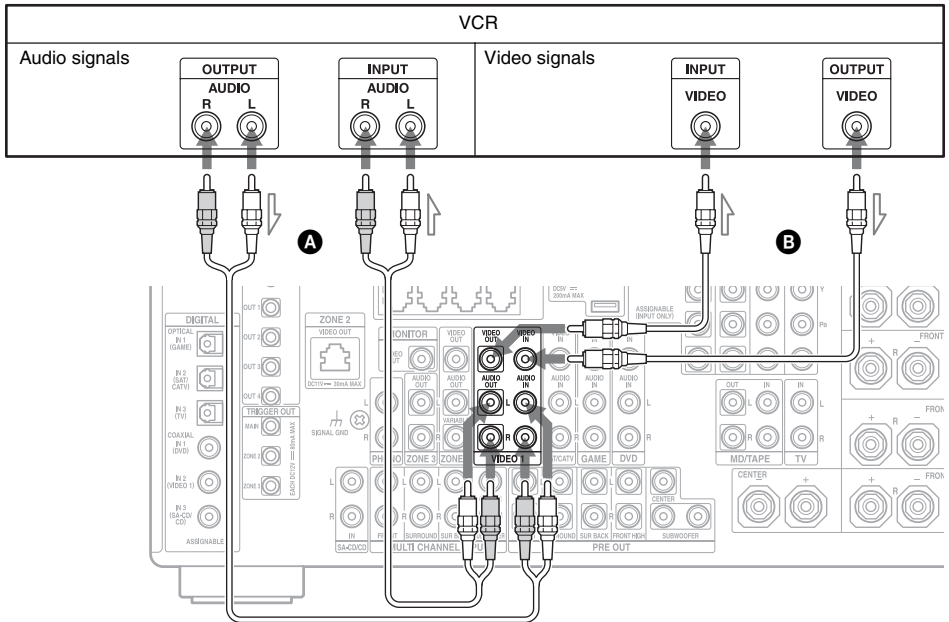

- A** Audio cord (not supplied)
- B** Video cord (not supplied)

Connections required for watching content via a camcorder

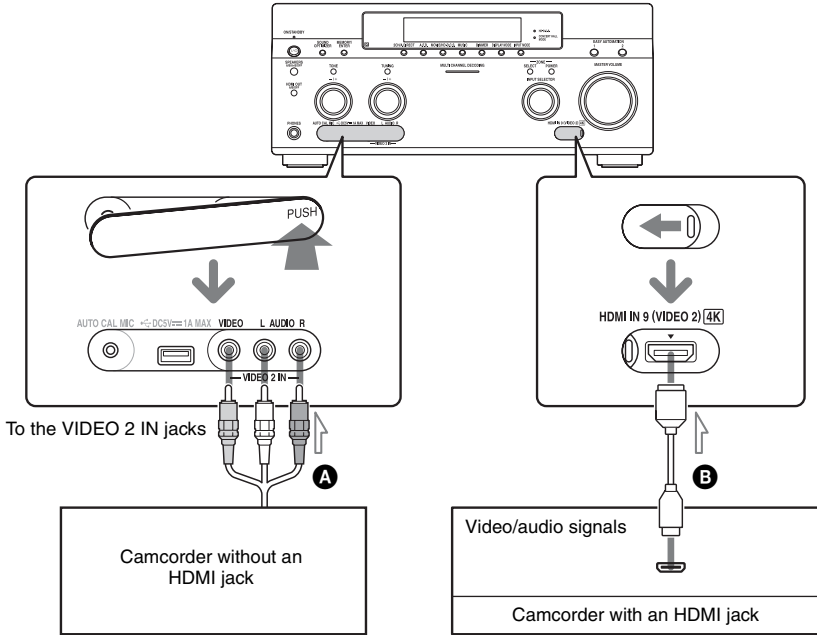

- A** Video/audio cord (not supplied)
- B** HDMI cable (not supplied)

HDMI features

- Digital audio signals transmitted by HDMI can be output from the speakers and the PRE OUT jacks on this receiver. This signal supports Dolby Digital, DTS, DSD, and Linear PCM. For details, see “Digital audio formats supported by the receiver” (page 22).
- Analog video signals input to the VIDEO jack, or COMPONENT VIDEO jacks can be output as HDMI signals. Audio signals are not output from the HDMI OUT jacks while the image is being converted.
- Analog video input, however, cannot be output via the HDMI OUT jacks in zone 2.
- This receiver supports High Bitrate Audio (DTS-HD Master Audio, Dolby TrueHD), Deep Color, “x.v.Color,” and 3D or 4K transmissions.
- The HDMI jacks of this receiver support the Control for HDMI function. The HDMI OUT B jack and the HDMI ZONE 2 OUT jacks, however, do not support the Control for HDMI function.
- To enjoy 3D images, connect 3D-compatible TV and video equipment (Blu-ray Disc Player, Blu-ray Disc recorder, PlayStation 3, etc.) to the receiver using High Speed HDMI cables, put on 3D glasses, and then play back 3D-compatible content.
- The receiver is compatible with 4K signals output through its HDMI output jacks. Analog input video signals can be up-scaled to 4K. The 4K input signals via HDMI IN 1/IN 2 on the rear and IN 9 on the front from a 4K-compatible player are output as they are as 4K signals. To enjoy 4K images, connect 4K-compatible TV or projector to the HDMI output jacks.
- You can view HDMI IN 1/IN 2/IN 3/IN 4 input on picture-in-picture preview windows.

Notes on connecting cables

- Use a High Speed HDMI cable. If you use a Standard HDMI cable, 4K, 1080p, Deep Color, or 3D images may not be displayed properly.
- Sony recommends that you use an HDMI-authorized cable or Sony HDMI cable.

Note on using an HDMI-DVI conversion cable

We do not recommend using an HDMI-DVI conversion cable. When you connect an HDMI-DVI conversion cable to a DVI-D device, the sound and/or the image may be lost. Connect separate audio cords or digital connecting cords, then set “Video Input Assign” and “Audio Input Assign” in the Input Settings menu if the sound is not output correctly.

4: Connecting the audio equipment

Connections required for listening content recorded on Super Audio CDs or ordinary CDs

To connect equipment with HDMI jacks

If your equipment does not have an HDMI jack, see page 38.

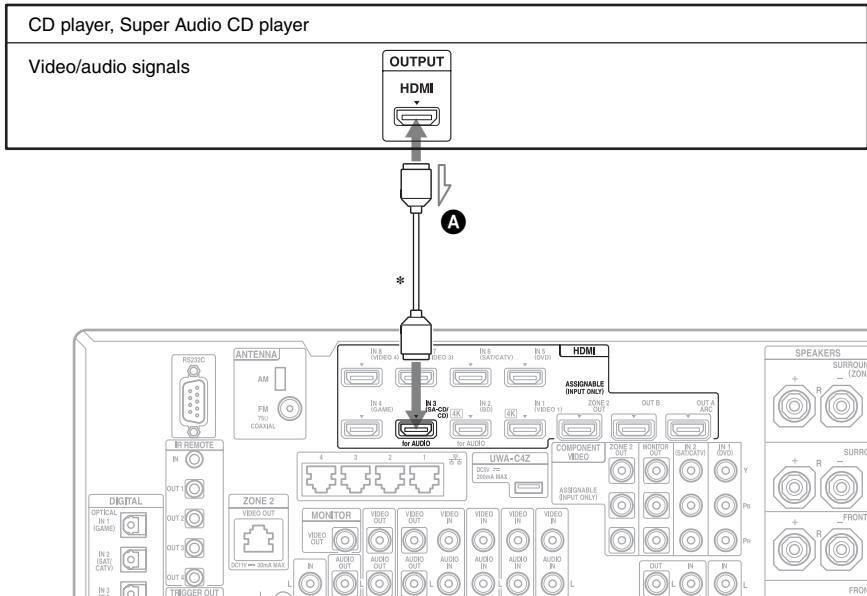

A HDMI cable (not supplied)

We recommend that you use a Sony HDMI cable.

* You can connect any equipment with HDMI output jacks to the HDMI IN jacks of the receiver.

To connect equipment with jacks other than HDMI jacks

If your Super Audio CD player is equipped with multi-channel output jacks, you can connect them to the MULTI CHANNEL INPUT jacks of this receiver to enjoy multi-channel sound. Alternatively, the MULTI CHANNEL INPUT jacks can be used to connect an external multi-channel decoder.

It is not necessary to connect all the cords. Connect cords according to the jacks of your equipment.

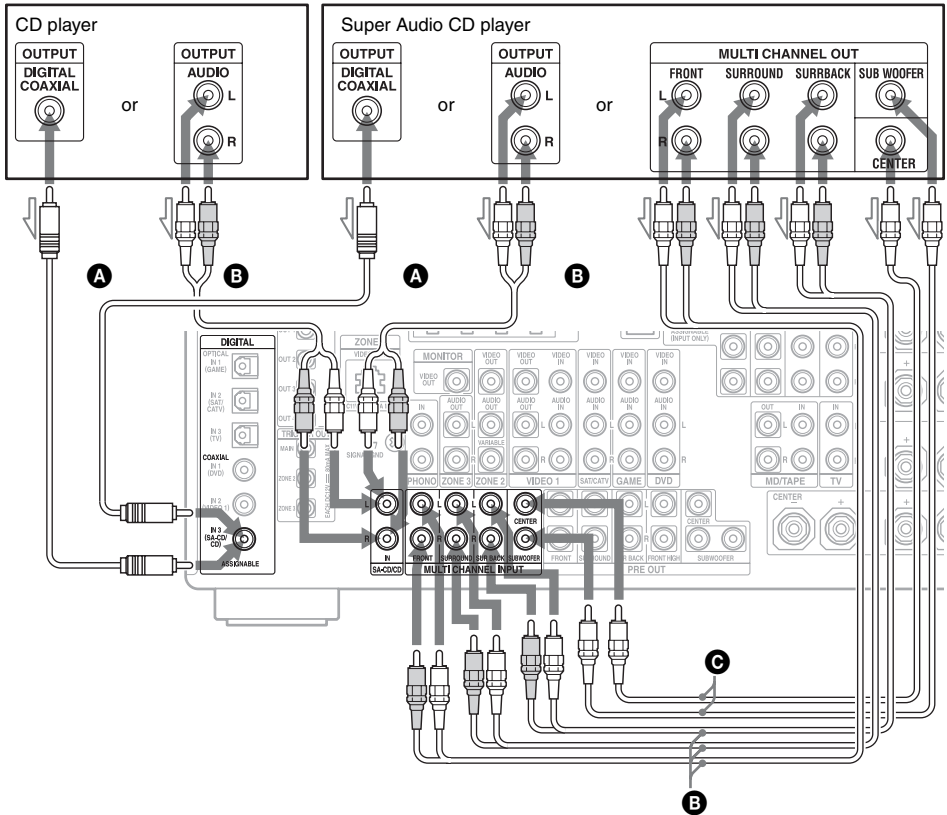

- A** Coaxial digital cord (not supplied)
- B** Audio cord (not supplied)
- C** Monaural audio cord (not supplied)

Note

Audio input signals from MULTI CHANNEL INPUT jacks cannot be recorded.

Tip

All the digital audio jacks are compatible with 32 kHz, 44.1 kHz, 48 kHz, 88.2 kHz and 96 kHz sampling frequencies. The COAXIAL IN jacks are also compatible with 192 kHz sampling frequency.

Note on playing a Super Audio CD on a Super Audio CD player

No sound is output when playing a Super Audio CD on a Super Audio CD player connected to only the COAXIAL SA-CD/CD IN jack on this receiver. When you play a Super Audio CD, connect the player to the MULTI CHANNEL INPUT or SA-CD/CD IN jacks, or connect a player which can output DSD signals from the HDMI jack to the receiver using an HDMI cable. Refer to the operating instructions supplied with the Super Audio CD player.

If you want to connect several digital devices, but cannot find an unused input

See “Using other video/audio input jacks” (page 88).

Connections required for listening to the radio

AM loop antenna (aerial)
(supplied)

FM wire antenna (aerial) (supplied)

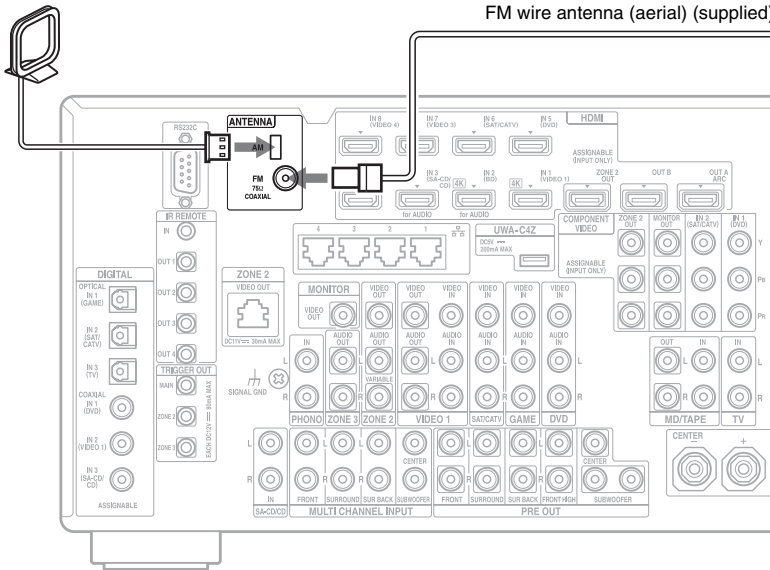

Notes

- To prevent noise pickup, keep the AM loop antenna (aerial) away from the receiver and other equipment.
- Be sure to fully extend the FM wire antenna (aerial).
- After connecting the FM wire antenna (aerial), keep it as horizontal as possible.

Connections required for listening to the content recorded on MDs, cassette tapes or records

For connecting an MD deck, it is not necessary to connect all the cords. Connect cords according to the jacks of your equipment.

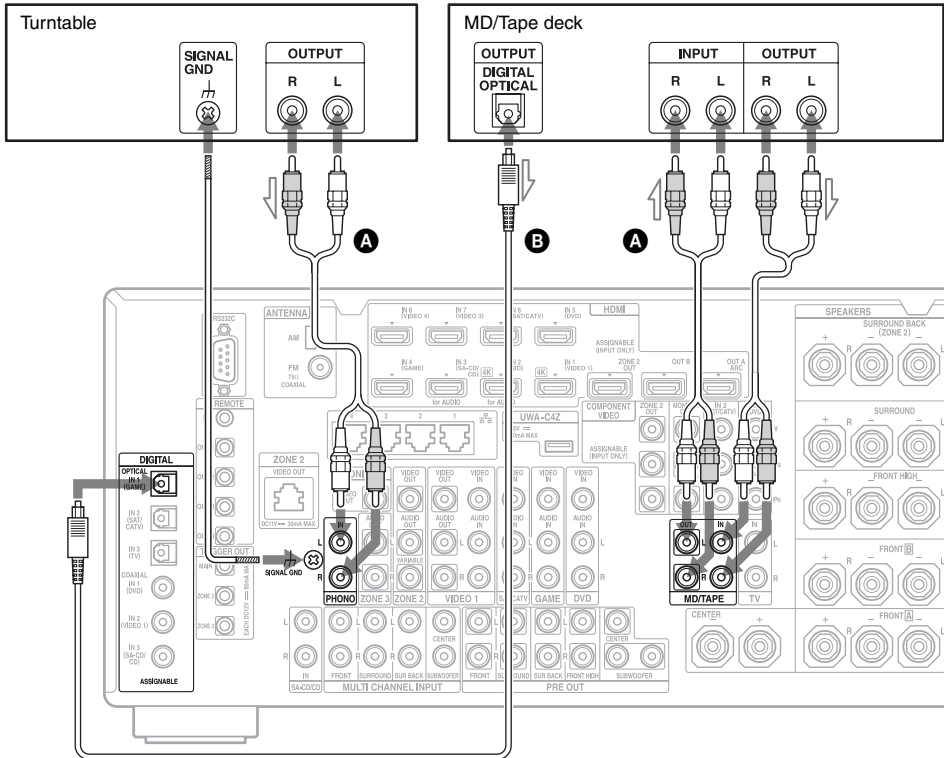

- A** Audio cord (not supplied)
- B** Optical digital cord (not supplied)

Notes

- When you connect an MD deck with digital cords, you can connect it to any digital IN jack on the receiver. To enable the connection, you should assign the jack to an MD deck input in the menu. See "Using other video/audio input jacks" (page 88).
- If your turntable has a ground (earth) wire, connect it to the (⏏) SIGNAL GND terminal.

5: Connecting the IR blaster

To operate the equipment connected to the receiver with the supplied remote control, attach one of the supplied IR blasters to the connected equipment.

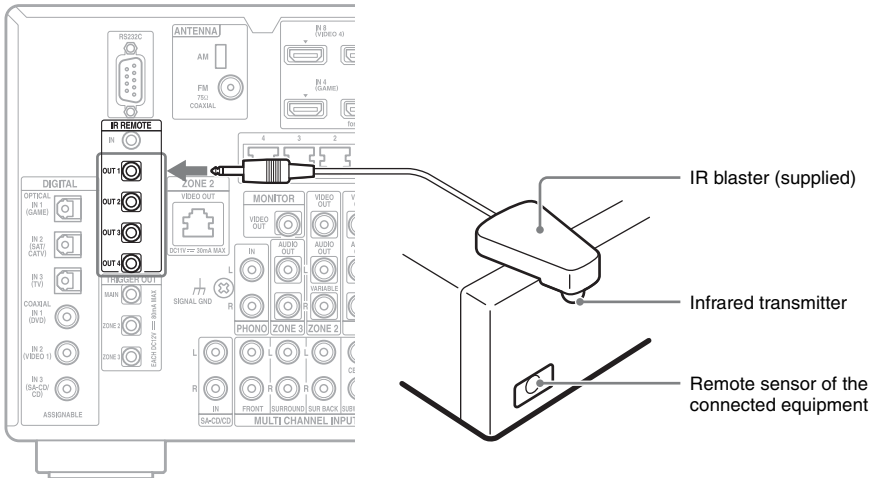

Place the equipment and the IR blaster as follows when you want to operate more than one device with the IR blaster.

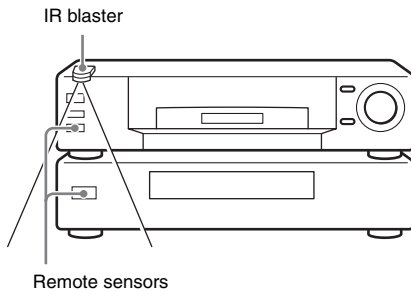

If the remote sensors on more than one device do not line up as shown in the illustration above, use another IR blaster (supplied) and another IR REMOTE OUT jack.

Tips

- If the IR blaster cable is too short, use a 3.5 mm jack extension cable (not supplied).
- You can set up a configuration such that you can operate multiple devices using one IR REMOTE OUT jack.

Refer to the operating instructions of the equipment you want to control with the supplied remote control. Then connect the IR blaster to an IR REMOTE OUT jack of the receiver, and place it above or below the remote sensor of the equipment so that the transmitter of the IR blaster is placed just above or below the remote sensor. Remote sensors on Sony products are identified by the  symbol.

Note

The IR blaster is equipped with double-sided sticker tape so that you can attach it to the connected equipment. Be sure to stick the IR blaster on in the proper place, because it is difficult to be removed.

6: Making connections for using Lighting Control

To operate Control4-compatible equipment with the supplied remote control, plug the supplied Lighting Control Adapter (UWA-C4Z) into the receiver.

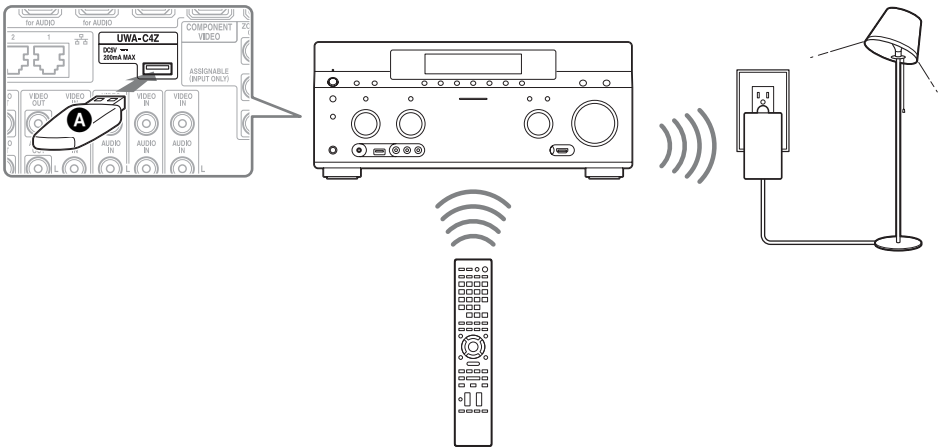

A Lighting Control Adapter (UWA-C4Z) (supplied)

Note

Do not remove the Lighting Control Adapter while the receiver is turned on. Data may be damaged and the receiver may become inoperative. When you remove the Lighting Control Adapter, make sure that the receiver is turned off (not in the Network Standby mode, but in the mode where the power of the receiver is turned completely off).

7: Connecting to the network

If you have an Internet connection, you can connect this receiver to the Internet.

Configuration example

The following illustration is a configuration example of a home network with the receiver, a computer. We recommend that you use a wired connection.

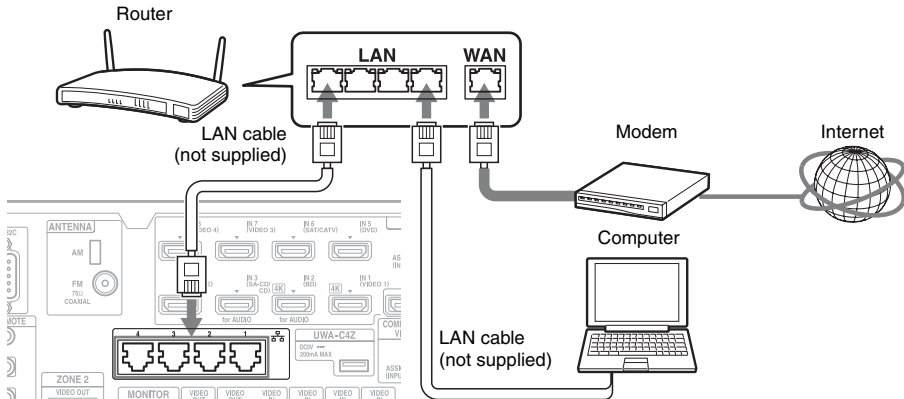

Note

Connect a router to one among ports 1 to 4 of the receiver using only one LAN cable. Do not connect the same router to the receiver using more than one LAN cable. It may cause a malfunction.

System requirements

The following system environment is required to use the network function of the receiver.

A Broadband line connection

A Broadband line connection to the Internet is required in order to enjoy Internet content or to use the software update function of the receiver.

Modem

This is the device that is connected to the broadband line to communicate with the Internet. Some of these devices are integrated with the router.

Router

- Use a router compatible with 100 Mbps to enjoy content on your home network.
- We recommend that you use a router equipped with the built-in DHCP (Dynamic Host Configuration Protocol) server. This function automatically assigns IP addresses on the LAN.
- The receiver does not support a network connection with transmission speeds of 1 Gbps or greater.

LAN cable (CAT5)

- We recommend that you use this type of cable for a wired LAN. Some flat-type LAN cables are easily affected by noise. We recommend that you use normal-type cables.
- If the receiver is used in an environment in which there is power supply noise from electric products or in a noisy network environment, use a shielded-type LAN cable.

8: Preparing the receiver and the remote control

Connecting the AC power cord (mains lead)

Connect the supplied AC power cord (mains lead) to the AC IN terminal on the receiver firmly, then connect the AC power cord (mains lead) to a wall outlet.

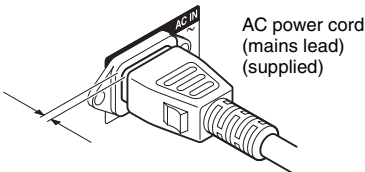
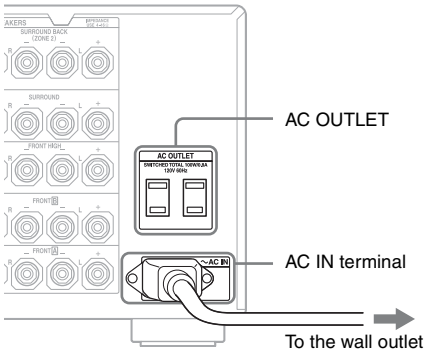

A several space is left between the plug and the rear panel even when the power cord (mains lead) is inserted firmly. The cord is supposed be connected this way. This is not malfunction.

Notes

- The AC OUTLET(s) on the rear of the receiver is a switched outlet, which supplies power to the connected component only while the receiver is turned on.
- If the power for zone 2 or zone 3 is turned on, the AC OUTLET(s) supplies power to the connected component even when the receiver (main zone) is in standby mode.

- Make sure that the total power consumption of the equipment connected to the receiver's AC OUTLET(s) does not exceed the wattage stated on the rear panel. Do not connect high-wattage electrical home appliances such as electric irons, fans, or TVs to this outlet. This may cause a malfunction.

Turning on the receiver

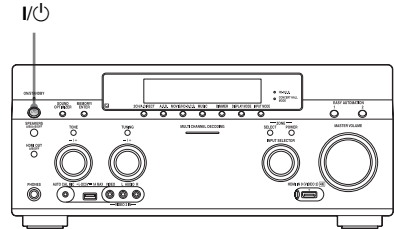

Press I/O to turn on the receiver.

You can also turn on the receiver using I/O on the remote control.

When you turn off the receiver, press I/O again. "STANDBY" flashes on the display window. Do not disconnect the AC power cord (mains lead) while "STANDBY" is flashing. This may cause a malfunction.

To save the power in standby mode

Set "Control for HDMI" (page 114), "Pass Through" (page 114), "Network Standby" (page 116), and "RS232C Control" (page 120) to "Off" or "Auto" (for "Pass Through" only), and turn off the power for zone 2/zone 3. If "Control for HDMI" (page 114), "Pass Through" (page 114), or "Network Standby" (page 116) is set to "On," or the power for zone 2 or zone 3 is turned on, the lamp above I/O lights up in amber.

Note

The top of the receiver may become hot while the receiver is in standby mode. This condition occurs because current is flowing in the internal circuits of the receiver. This is not a malfunction.

Inserting batteries into the remote control

Insert two R6 (size-AA) batteries in the RM-AAU194 remote control. Observe the correct polarity when installing batteries.

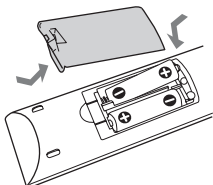

RM-AAU194

Notes

- Do not leave the remote control in an extremely hot or humid place.
- Do not use a new battery with old ones.
- Do not mix manganese batteries and other kinds of batteries.
- If you do not intend to use the remote control for an extended period of time, remove the batteries to avoid possible damage from battery leakage and corrosion.

9: Setting up the receiver using the Easy Setup

You can set the basic settings of the receiver easily by operating the receiver in accordance with the instructions on the TV screen.

Switch the input of the TV to the input to which the receiver is connected.

When you turn on the receiver for the first time, the EULA screen appears on the TV screen. Agree to the EULA to proceed to the Easy Setup screen, then set up the receiver in accordance with the instructions on the Easy Setup screen.

You can set up the following functions using the Easy Setup.

- Network Settings
- Input Settings
- Home Control Settings
- Speaker Settings

Tip

A check mark will be displayed to the right of any function items that you have set up.

Notes on Speaker Settings (Auto Calibration)

Insert the plug of the optimizer microphone all the way inside the AUTO CAL MIC jack.

Confirm active subwoofer setup

- When a subwoofer is connected, turn on the subwoofer and turn up the volume prior to activating the subwoofer. Turn the LEVEL knob to just before the mid-point.
- If you connect a subwoofer with the crossover frequency function, set the value to maximum.

- If you connect a subwoofer with an auto standby function, set it to off (deactivated).

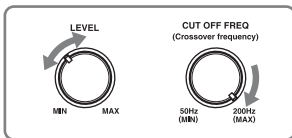

Notes

- Depending on the characteristics of the subwoofer you are using, the setup distance value may be different from the actual position.
- If you perform “Speaker Settings (Auto Calibration)” using the Easy Setup, the measurement results will be overwritten and saved on the currently selected position (“Pos.1” is selected as the factory default setting).

Tips

- Depending on the position of the subwoofer, the measurement results for polarity may vary. However, there will be no problems even if you continue to use the receiver with that value.
- Depending on the speakers, “Out Phase” may appear even if there is no problem with the speaker connection. This is caused by the speaker specifications, and there will be no problems even if you continue to use the speakers.

When you connect two subwoofers to the receiver

If you cannot obtain measurement results of the “Auto Calibration” function correctly, depending on the environment, or you want to make fine adjustments, you can set up the subwoofers manually. For details, see “Speaker Setup” in the Speaker Settings menu (page 103).

Notes on the speaker impedance

- If you are not sure of the impedances of the speakers, refer to the operating instructions supplied with your speakers. (This information is often on the back of the speaker.)
- When you connect speakers all with a nominal impedance of 8 ohms or higher, set “Speaker Impedance” to “8 Ω.” When

connecting other types of speakers, set it to “4 Ω.”

- When you connect front speakers to both the FRONT [A] and FRONT [B] terminals, connect the speakers with a nominal impedance of 8 ohms or higher.
 - When you connect speakers with impedance of 16 ohms or higher in both “[A]” and “[B]” configuration:
 - Set “Speaker Impedance” to “8 Ω” in the Speaker Settings menu.
 - For other types of speakers in other configurations:
 - Set “Speaker Impedance” to “4 Ω” in the Speaker Settings menu.

To select the front speakers

You can select the front speakers you want to drive.

SPEAKERS (A/B/A+B/OFF)

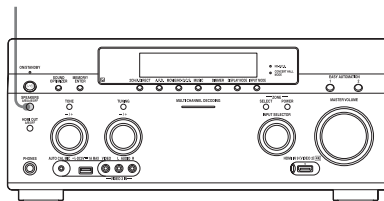

Press SPEAKERS (A/B/A+B/OFF) repeatedly to select the front speaker system you want to drive.

You can confirm which set of terminals ([A] or [B]) are selected by checking the indicators in the display window.

Indicators	Selected speakers
SP [A]	The speakers connected to the FRONT [A] terminals.
SP [B]	The speakers connected to the FRONT [B] terminals.
SP [AB]	The speakers connected to both the FRONT [A] and FRONT [B] terminals (parallel connection).
	“SPEAKERS OFF” appears in the display window. No audio signals are output from any speaker terminals, or the PRE OUT jacks.

continued

To use the receiver as a pre-amplifier

You can use the “Auto Calibration” function when you use the receiver as a pre-amplifier. In this case, the distance value shown on the display may differ from the actual distance value. However, there will be no problems, even if you continue to use the receiver with that value.

To cancel the measurement process

The measurement process is cancelled by the following operations.

- Turning the power off
- Changing the volume
- Switching inputs
- Changing the setting of SPEAKERS (A/B/A+B/OFF)
- Connecting headphones

Operations other than the above are not allowed during the measurement process.

To set up the receiver manually

See “Adjusting Settings” (page 96).

10: Setting up connected equipment

To output multi-channel digital audio, check the digital audio output setting on the connected equipment.

For a Sony Blu-ray Disc Player, check that “Audio (HDMI),” “DSD Output Mode,” “Dolby Digital/DTS,” “Dolby Digital,” and “DTS” are set to “Auto,” “On,” “Bitstream,” “Dolby Digital,” and “DTS,” respectively (as of August 1, 2012).

For a PlayStation 3, after having connected the receiver with an HDMI cable, select the “Audio Output Settings” in “Sound Settings,” and select “HDMI” and “Automatic” (with system software version 4.21).

For details, refer to the operating instructions supplied with the connected equipment.

11: Preparing a computer to use as a server

A server is a device which delivers content (music and photos) to a DLNA device on a home network.

You can play back content stored on a computer on a home network with this receiver via that network after you have installed application software* which has a DLNA compliant server function.

* If you use a Windows 7-based computer, use Windows Media® Player 12 bundled with Windows 7.

If you use a Windows 8-based computer, the new UI system may not be able to recognize the receiver. If this occurs, switch the setting to “Desktop UI.”

Guide to on-screen display operation

You can display the menu of the receiver on the TV screen and select the function you want to use on the TV screen by pressing $\uparrow/\downarrow/\leftarrow/\rightarrow$ and \oplus on the remote control.

When you start operating the receiver, make sure to press AMP on the remote control first. Otherwise, operations that follow may not be aimed at the receiver.

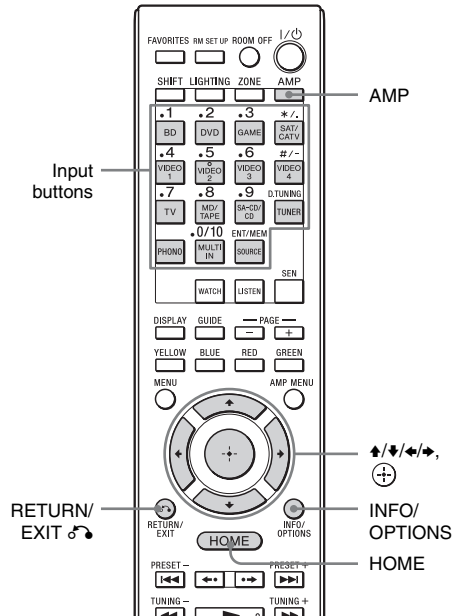

Using the menu

1 Switch the input of the TV to the input to which the receiver is connected.

2 Press **HOME**.

The home menu is displayed on the TV screen.

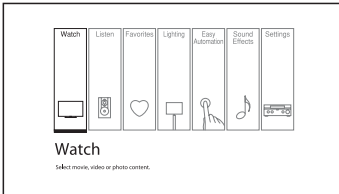

3 Press **←/→** repeatedly to select the menu you want, then press **+** to enter the menu mode.

The menu item list appears on the TV screen.

Example: When you select "Watch."



Tip

When "OPTIONS" appears in the lower right portion of the screen, you can display the function list by pressing INFO/OPTIONS and selecting a related function.

To return to the previous screen

Press **RETURN/EXIT** .

To exit the menu

Press **HOME** to display the home menu, then press **HOME** again.

Overview of the home menu

Menu	Description
Watch	Selects the video or photo source to be input to the receiver, or video or photo content to be delivered via USB jack, or photo content to be delivered via a home network (page 51).
Listen	Selects the music source to be input to the receiver, or the music content to be delivered via Internet or a home network (page 51). You can also enjoy FM/AM radio of the built-in receiver.
Favorites	Displays the Internet content added to the Favorites List. You can save up to 18 favorite Internet content items (page 56).
Lighting	Enables you to control and operate registered lighting devices (page 73).
Easy Automation	Enables you to save various settings with the receiver and recalling the settings all at one time (page 71).
Sound Effects	Enables you to enjoy sound development provided by various Sony proprietary technologies or functions (page 61).
Settings	Enables you to adjust the settings of the receiver (page 96).

Enjoying images/sound

Enjoying images/sound from connected equipment

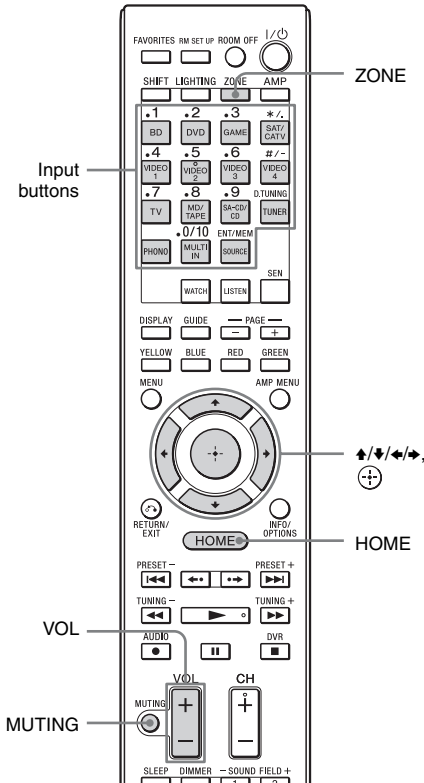

- 1 Select “Watch” or “Listen” from the home menu, then press \odot .**

The menu item list appears on the TV screen.

- 2 Select the equipment you want, then press \odot .**

- 3 Turn on the equipment and start playback.**

When a Sony BD/DVD player or other device is equipped with the IR blaster, you can turn them on or off. (Operation of all the devices is not guaranteed.)

- 4 Press VOL +/- to adjust the volume.**

To select the input source

You can turn the INPUT SELECTOR dial on the receiver or press the input buttons on the remote control to select the equipment you want.

To select the input source for zone 2 or zone 3, press ZONE SELECT on the receiver or ZONE on the remote control to select zone 2 or zone 3 first (“ZONE 2 [input name]” or “ZONE 3 [input name]” appears on the display window).

Tips

You can adjust the volume differently using the MASTER VOLUME knob on the receiver or the VOL +/- button on the remote control.

- To turn the volume up or down quickly
 - Turn the MASTER VOLUME knob quickly.
 - Press and hold the VOL +/- button.
- To make fine adjustment
 - Turn the MASTER VOLUME knob slowly.
 - Press the VOL +/- button and release it immediately.

To activate the muting function

Press MUTING on the remote control. To cancel, press MUTING on the remote control again or press VOL + to raise the volume. If you turn the receiver off while the sound is muted, the muting selection is cancelled.

To avoid damaging your speakers

Before you turn off the receiver, be sure to turn down the volume level.

USB Device/WALKMAN

You can play video/music/photo files on the connected USB device.

For playable types of files, see “Network/USB” (page 23).

1 Connect the USB device to the (USB) port on the receiver.

Refer to the operating instructions of the USB device before connecting.

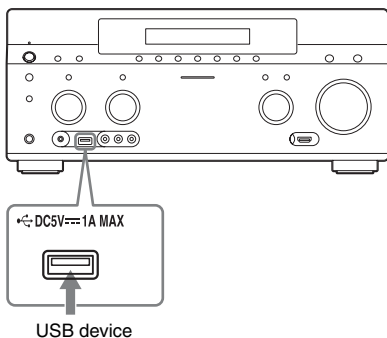

2 Select “Watch” or “Listen” from the home menu, then press .

3 Select “My Video,” “My Music,” or “My Photo,” then press .

Note

If no picture is output, change the setting for “Playback Resolution” (page 112).

4 Select “USB device (front),” then press .

The folders and video/music/photo files are listed on the TV screen.

5 Press , , , or and to select the file that you want to play.

The image or sound from the USB device is played on the receiver.

Notes

- Do not remove the USB device during operation. To avoid data corruption or damage to the USB device, turn the receiver off when removing the USB device.
- If you connect a WALKMAN to the receiver, operate the WALKMAN using the remote control of the receiver the same way you do when you connect other USB devices to the receiver. You cannot use the controls on the WALKMAN.
- Some USB devices may not work with this receiver.
- The receiver can recognize Mass Storage Class (MSC) devices (such as flash memory or an HDD) (front USB jack only).

iPod/iPhone

You can enjoy the music/video/photo and charge the battery of an iPod/iPhone via the receiver.

For details on the compatible iPod/iPhone models with this function, see page 53.

Note

You cannot use headphones during playback.

1 Connect the iPod/iPhone to the (USB) port on the receiver.

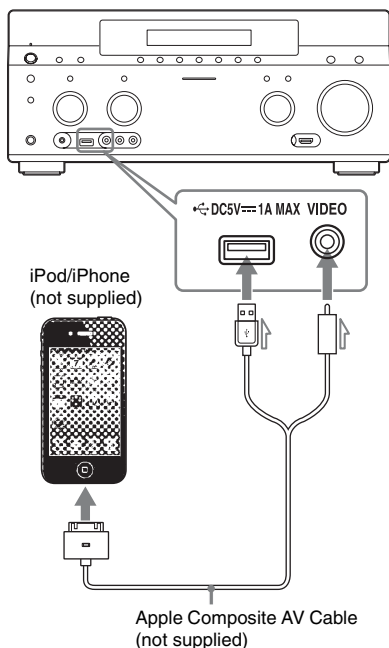

2 Select “Watch” or “Listen” from the home menu, then press .

3 Select “My Video,” “My Music,” or “My Photo,” then press .

Note

If no picture is output, change the setting for “Playback Resolution” (page 112).

4 Select “iPod (front),” then press .

The video/music files are listed on the TV screen.

If you select “iPod (front)” on “My Photo,” select a photo file using the controls on the iPod/iPhone (you do not need to proceed to step 5).

5 Press , , , and to select the file that you want to play.

The image or sound from the iPod/iPhone is played back on the receiver.

You can operate the iPod/iPhone using the buttons on the remote control.

For operation details of the iPod/iPhone, also refer to the operating instructions of the iPod/iPhone.

Made for iPod/iPhone models

The compatible iPod/iPhone models are as follows. Update your iPod/iPhone with the latest software before using with the receiver.

Compatible models are as follows:

- iPod touch
 - iPod touch (4th generation)/iPod touch (3rd generation)/iPod touch (2nd generation)
- iPod nano
 - iPod nano (6th generation)/iPod nano (5th generation) (video camera)/iPod nano (4th generation) (video)/iPod nano (3rd generation) (video)
- iPod
 - iPod classic
- iPhone
 - iPhone 4S/iPhone 4/iPhone 3GS/iPhone 3G

To operate the iPod/iPhone using the remote control

You can operate the iPod/iPhone using the buttons on the remote control. The following table shows an example of buttons that can be used. (Depending on the iPod/iPhone model, the operation may be different.)

continued

For “My Video”/“My Music”

Press	Operation
▶	Starts play.
⏸	Pauses play.
■	Stops play.
◀◀ or ▶▶	Fast reverses or forwards.
◀◀ or ▶▶	Goes to the previous/next file or chapter (if any).

For “My Photo”

Press	Operation
▶, ⏸	Starts/pauses play.
■	Pauses play.
◀◀ or ▶▶	Fast reverses or forwards.
◀◀ or ▶▶	Goes to the previous/next file.

Notes

- You cannot transfer songs onto the iPod/iPhone from this receiver.
- Sony cannot accept responsibility in the event that data recorded to iPod/iPhone is lost or damaged when using an iPod/iPhone connected to this receiver.
- This product has been designed specifically to work with iPod/iPhone and has been certified to meet Apple performance standards.
- Do not remove the iPod/iPhone during operation. To avoid data corruption or damage to the iPod/iPhone, turn the receiver off when connecting or removing the iPod/iPhone.
- When you connect an iPod that is not compatible with the video output function and select “iPod (front)” in “My Video” or “My Photo,” an alert message appears on the TV screen.

Tips

- The iPod/iPhone is charged when connected to the receiver while the receiver is turned on.
- The receiver can recognize up to 3,000 files (including folders).

Home Network (DLNA)

You can play music/photo files on other DLNA-certified devices by connecting them to your home network.

This receiver can be used as a player and renderer.

- Server: Stores and sends files.
- Player: Receives and plays files from the server.
- Renderer: Receives and plays files from the server, and can be operated by another device (controller).
- Controller: Operates the renderer component.

Preparations for using the DLNA function

- Connect the receiver to your home network (page 44).
- Prepare other DLNA-certified equipment. For details, refer to the operating instructions of the equipment.

1 Select “Watch” or “Listen” from the home menu, then press .



2 Select “My Music” or “My Photo,” then press .

Note

If no picture is output, change the setting for “Playback Resolution” (page 112).

3 Select the DLNA server icon, then press .

The folders and music/photo files are listed on the TV screen.

4 Press  and  to select the file that you want to play.

The image or sound from the DLNA server is played back on the receiver.

To play remote files by operating the receiver (Renderer) via a DLNA controller

You can operate the receiver with a DLNA-certified controller, such as Windows Media® Player 12, when playing files stored on a DLNA server.

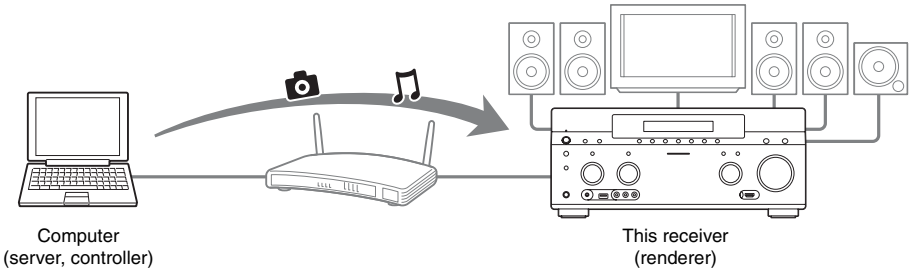

Control this receiver using a DLNA controller.
For details of operation, see the operating instructions of the DLNA controller.

Note

Do not operate the receiver with the supplied remote control and a DLNA controller at the same time.

Tip

The receiver is compatible with the “Play To” function of Windows Media® Player 12 that comes standard with Windows 7.

Internet content

You can play back a variety of Internet content using the receiver.

- 1 Connect the receiver to a network (page 44).**
- 2 Select “Listen” from the home menu, then press \odot .**
- 3 Select “Internet Music,” then press \odot .**

The Internet content screen appears.

Note

If no picture is output, change the setting for “Playback Resolution” (page 112).

- 4 Select an Internet content provider icon, then press \odot .**

If the Internet content list has not been retrieved, it will be represented by an unacquired icon or a new icon.

Note

The Internet content is subject to being suspended or changed without notice.

To use the control panel

The control panel appears when the Internet content file starts playing. The displayed items may differ, depending on Internet content providers.

To display again, press DISPLAY.

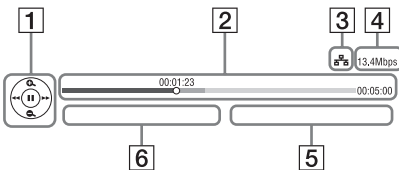

- 1 Control display**
Press $\blacktriangle/\blacktriangledown/\blacktriangleleft/\blacktriangleright$ or \odot for playback operations.

- 2 Playing status bar**
Status bar, cursor indicating the current position, playing time, duration of the content file
- 3 Network condition indicator**
- 4 Network transmission speed**
- 5 The next content file name**
- 6 The currently selected content file name**

Registering your favorite content

You can register your favorite Internet content in “Favorites List.”

- 1 Display the Internet content screen.**
- 2 Select an Internet content provider icon you want to register in Favorites List, then press INFO/OPTIONS.**
- 3 Select “Add to Favorites,” then press \odot .**

To remove content from Favorites List

- 1 Press FAVORITES.**
The Favorites List appears.
- 2 Select an Internet content provider icon you want to remove from Favorites List, then press INFO/OPTIONS.**
- 3 Select “Remove from Favorites,” then press \odot .**

Available options

Item	Details
Favorites List	Displays the Favorites List.
Add to Favorites	Adds Internet content to the Favorites List.
Remove from Favorites	Removes Internet content from the Favorites List.

FM/AM

You can listen to FM and AM broadcasts through the built-in tuner. Before operation, make sure you have connected the FM and AM antennas (aerials) to the receiver (page 40).

- 1 Select "Listen" from the home menu, then press \odot .
- 2 Select "FM/AM," then press \odot .

FM/AM screen

You can select and operate each item on the screen by pressing $\blacktriangle/\blacktriangledown/\blacktriangleleft/\blacktriangleright$ and \odot .

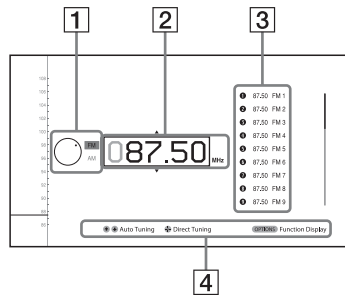

- 1 Band switch (page 58)
- 2 Frequency indication (page 58)
- 3 Preset station list (page 59)
- 4 Preset station name (page 59)

continued

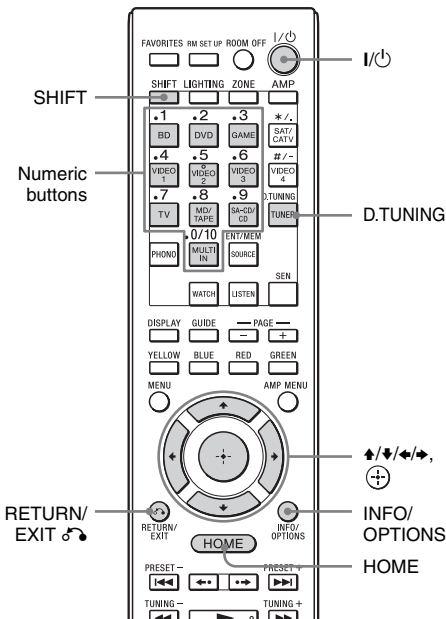

2 Press \uparrow/\downarrow .

\uparrow scans from lower to higher frequency stations and \downarrow for scanning higher to lower.

The receiver stops scanning whenever a station is received.

In case of poor FM stereo reception

1 Tune in the station you want to listen to using Auto Tuning, Direct Tuning, or select the preset station you want (page 59).

2 Press INFO/OPTIONS.
The options menu appears.

Note

You can set “FM Mode” in the options menu when the frequency indication is selected, or when called for in another situation.

3 Select “FM Mode,” then press \oplus .

4 Select “Monaural,” then press \oplus .

toggling between FM and AM radio

1 Select “Listen” from the home menu, then press \oplus .

2 Select “FM/AM,” then press \oplus .
The FM/AM screen appears.

3 Select the band switch.

4 Press \uparrow/\downarrow to select “FM” or “AM,” then press \oplus .

Tuning to a station automatically (Auto Tuning)

1 Select the frequency indication on the FM/AM screen.

Tuning into a station directly (Direct Tuning)

Enter the frequency of a station directly by using the numeric buttons on the remote control.

1 Press SHIFT, then press D.TUNING on the FM/AM screen.

2 Press the numeric buttons to enter the frequency, then press \oplus .

Example 1: FM 102.50 MHz

Select 1 \rightarrow 0 \rightarrow 2 \rightarrow 5

Example 2: AM 1,350 kHz

Select 1 \rightarrow 3 \rightarrow 5 \rightarrow 0

Tips

- Adjust the direction of the AM loop antenna (aerial) for optimum reception upon tuning to an AM station.

- The tuning scale for direct tuning is shown below.
 - FM band 100 kHz
 - AM band 10 kHz*
- * The AM tuning scale can be changed (page 60).

If you cannot tune to a station

“---.--- MHz” or “---- kHz” appears and then the display returns to the current frequency.

Make sure you have entered the right frequency. If not, repeat step 2. If you still cannot tune to a station, the frequency may not be in use in your area.

Programming FM/AM radio stations

You can program up to 30 FM and 30 AM stations as your favorite stations as preset stations.

1 Tune to the station that you want to program using Auto Tuning (page 58) or Direct Tuning (page 58).

In case of poor FM stereo reception, switch the FM reception mode (page 58).

2 Press INFO/OPTIONS.

The options menu appears.

Note

You can set “Preset Memory” in the options menu when the frequency indication is selected, or when called for in another situation.

3 Select “Preset Memory,” then press .

4 Select a preset number, then press .

The station is stored as the selected preset number.

5 Repeat steps 1 to 4 to program another station.

You can store stations as follows:

- FM band: FM1 to FM30
- AM band: AM1 to AM30

Tuning to preset stations

1 Select “Listen” from the home menu, then press .

2 Select “FM/AM,” then press .

3 Select the preset number from the list, then press .

Preset numbers from 1 to 30 are available.

To name preset stations (Name Input)

1 Select the preset number on which you want to name.

2 Press INFO/OPTIONS. The options menu appears.

3 Select “Name Input,” then press .

The soft keyboard appears on the screen.

4 Press , , , and to select a character one by one to enter the name.



5 Select “Enter,” then press .

The name you entered is registered.

To cancel naming input

Press RETURN/EXIT  or HOME.

Selecting the sound field

- 1** Select “Sound Effects,” from the home menu, then press .
- 2** Select “Sound Field,” then press .
- 3** Select the sound field you want.

Playing back with 2-channel sound

You can switch the output sound to 2-channel sound regardless of the recording formats of the software you are using, the playback equipment connected, or the sound field settings of the receiver.

2CH mode	Effect
2ch Stereo	The receiver outputs the sound from the front left/right speakers only. There is no sound from the subwoofer. Standard 2 channel stereo sources completely bypass the sound field processing and multi-channel surround formats are downmixed to 2 channels.
2ch Analog Direct	You can switch the audio of the selected input to 2 channel analog input. This function enables you to enjoy high quality analog sources. When using this function, only the volume and front speaker level can be adjusted.

To listen to music through headphones connected to the receiver

Sound field	Effect
Headphone (2ch)	This mode is selected automatically if you use headphones and when the mode other than “2ch Analog Direct” is selected. Standard 2 channel stereo sources completely bypass the sound field processing and multi-channel surround formats are downmixed to 2 channels.
Headphone (Direct)	Outputs analog signals without processing by tone, sound field, etc. This mode is selected automatically if the “2ch Analog Direct” option is selected.
Headphone (Multi)	This mode is selected automatically if you use headphones when “MULTI IN” is selected. Outputs the front analog signals from the MULTI CHANNEL INPUT jacks.

Playing back with multi-channel surround

The Auto Format Direct (A.F.D.) mode allows you to listen to higher fidelity sound and select the decoding mode for listening to a 2 channel stereo or monaural sound as multi-channel sound.

A.F.D. mode	Effect
A.F.D. Auto	Presets the sound as it was recorded/encoded without adding any surround effects.
Multi Stereo	Outputs 2 channel left/right or monaural signals from all speakers.

Tip

We recommend "A.F.D. Auto."

Enjoying a surround effect for movies

You can take advantage of surround sound simply by selecting one of the receiver's preprogrammed sound fields. They bring the exciting and powerful sound of movie theaters into your home.

Sound field	Effect
HD-D.C.S.	HD Digital Cinema Sound (HD-D.C.S.) is Sony's new innovative home theater technology using the latest acoustic and digital signal processing technologies. It is based on the precise response measurement data of a mastering studio. With HD-D.C.S., you are able to enjoy Blu-ray and DVD movies at home with not only the high quality of sound, but also the best sound ambience, just as the movie's sound engineer intended in the mastering process. You can select the effect type for HD-D.C.S. For details, see "About the effect type for HD-D.C.S." (page 63).
Movie Height	Raises the sound image of the center speaker to the inside of the screen using the front high speakers. Suitable especially when the center speaker is placed under a large screen, etc. Even without front high speakers, this processing can be performed using virtual speakers.
PLII Movie	Performs Dolby Pro Logic II Movie mode decoding. This setting is ideal for movies encoded in Dolby Surround. In addition, this mode can reproduce sound in 5.1 channel for watching videos of overdubbed or old movies.
PLIIx Movie	Performs Dolby Pro Logic IIx Movie mode decoding. This setting expands Dolby Pro Logic II Movie or Dolby Digital 5.1 to discrete 7.1 movie channels.
PLIIz Height	Performs Dolby Pro Logic IIz mode decoding. This setting can expand a source sound into up to 9.1 channels to which a vertical component is applied, and gives a dimension of presence and depth. "PLIIz Height" is the same sound field as that is described on page 64. You can adjust the gain level for "PLIIz Height." For details, see "About the gain level for PLIIz Height" (page 65).
Neo:X Cinema	Performs DTS Neo:X Cinema mode decoding. A source recorded in 2 to 7.1 channel format is enhanced up to 9.1 channels.

About the effect type for HD-D.C.S.

HD-D.C.S. has three different types:

Dynamic, Theater, and Studio. Each type has different reflection and reverberation sound mixture levels and is optimized to match a listener's room uniqueness, taste and mood.

■ Dynamic

The "Dynamic" setting is suitable for an environment which is reverberant but lacks a spacious feeling (where sound absorption is not sufficient). This setting emphasizes the reflection of sound and reproduces the sound of a large, classical movie theater. Thus, the spacious feeling of a dubbing theater is emphasized and a unique acoustic field is created.

■ Theater

Factory default setting. The "Theater" setting is suitable for a general living room. This setting reproduces the reverberation of sound just like in a movie theater (dubbing theater). It is most appropriate for watching content recorded on a Blu-ray Disc when you want the atmosphere of a movie theater.

■ Studio

The "Studio" setting is suitable for a living room with the appropriate sound equipment. This setting reproduces the reverberation of sound provided when a theatrical sound source is remixed for a Blu-ray Disc to a volume level suitable for home use. The level of reflection and reverberation of sound is kept to the minimum. However, dialogues and surround effects are reproduced vividly.

Enjoying a surround effect for music

You can take advantage of surround sound simply by selecting one of the receiver's pre-programmed sound fields. They bring the exciting and powerful sound of concert halls into your home.

Sound field	Effect
Berlin Philharmonic Hall	Reproduces the sound characteristics of the Berlin Philharmonic Hall. You can also adjust the effect level. For details, see "About the effect level for Concert Hall" (page 65). Also works automatically in conjunction with reception of the "The Berliner Philharmoniker's Digital Concert Hall" Internet service.
Concertgebouw Amsterdam	Reproduces the sound characteristics produced by reflectivity of a concert hall in Amsterdam, Netherlands, which features a large sound stage. You can also adjust the effect level. For details, see "About the effect level for Concert Hall" (page 65).
Musikverein Vienna	Reproduces the sound characteristics of a concert hall in Vienna, Austria, which features a resonant and unique reverberation sound. You can also adjust the effect level. For details, see "About the effect level for Concert Hall" (page 65).
Vocal Height	Raises the sound image using the front high speakers. This setting is appropriate to watching music content accompanied by a display on a large screen. Even without front high speakers, this processing can be performed using virtual speakers.
Jazz Club	Reproduces the acoustics of a jazz club.
Live Concert	Reproduces the acoustics of a 300-seat live house.
Stadium	Reproduces the feeling of a large open-air stadium.
Sports	Reproduces the feeling of sports broadcasting.
Portable Audio	Reproduces a clear enhanced sound image from your portable audio device. This mode is ideal for MP3 and other compressed music.
PLII Music	Perform Dolby Pro Logic II Music mode decoding. This setting is ideal for normal stereo sources such as CDs.
PLIIx Music	Performs Dolby Pro Logic IIx Music mode decoding. This setting is ideal for normal stereo sources such as CDs.
PLIIz Height	Performs Dolby Pro Logic IIz mode decoding. This setting can expand a source sound into up to 9.1 channels to which a vertical component is applied, and gives a dimension of presence and depth. "PLIIz Height" is the same sound field as that is described on page 62. You can adjust the gain level for "PLIIz Height." For details, see "About the gain level for PLIIz Height" (page 65).
Neo:X Music	Performs DTS Neo:X Music mode decoding. A source recorded in 2 to 7.1 channel format is enhanced up to 9.1 channels.
Neo:X Game	Performs DTS Neo:X Game mode decoding. A source recorded in 2 to 7.1 channel format is enhanced up to 9.1 channels.

About the effect level for Concert Hall

You can set the reverberation level for the following sound fields:

- Berlin Philharmonic Hall
- Concertgebouw Amsterdam
- Musikverein Vienna

■ Low

Turns down the reverberation volume level.

■ Mid

Sets the reverberation volume level to the factory default.

■ High

Turns up the reverberation volume level.

About the gain level for PLIIz Height

You can adjust the gain level of the front height channels for Pro Logic IIz mode (common for movie and music).

■ Low

No gain will be applied.

■ Mid

+3 dB will be applied (factory default setting).

■ High

+5 dB will be applied.

speaker pattern you select, or with audio formats.

- The receiver may play back signals at a lower sampling frequency than the actual sampling frequency of the input signals, depending on the audio format.
- “PLIIx Movie/Music,” “PLIIz Height,” “Vocal Height,” and “Movie Height” may not appear, depending on the speaker pattern and Virtual Front High settings you select.
- Some speakers or the subwoofer may not output sound, depending on the sound field setting.
- If there is any noise present, the noise may be different, depending on the sound field you select.
- “Neo:X (Cinema/Music/Game)” does not work when signals with a sampling frequency of 32 kHz are being received.

Notes on the sound fields

- Depending on the country or region, the “Berlin Philharmonic Hall” Internet service may not be available.
- The sound fields do not work when “MULTI IN” is selected.
- You cannot select “2ch Analog Direct” when you play back content via a USB device, a home network, or Internet content.
- “Multi Stereo” does not work when multi-channel audio signals are being received.
- The sound fields for movie and music may not work, depending on the input or the

Using the Sound Optimizer function

The Sound Optimizer function imparts a sense of presence and intensity of sound to playback of high volume sound, regardless of the volume level of the receiver.

You can enjoy clear and dynamic sound even at low volumes late at night.

The optimum effect to suit your environment is obtained by taking advantage of the “Auto Calibration” function.

- 1 Select “Settings” from the home menu, then press \oplus .**
- 2 Select “Audio Settings,” then press \oplus .**
- 3 Select “Sound Optimizer,” then press \oplus .**
- 4 Select “Normal” or “Low,” then press \oplus .**

The Sound Optimizer function is activated. To adjust for the reference level of a movie, select “Normal.” To adjust for a CD or other software whose average sound pressure level is processed highly, select “Low.” You can also set the Sound Optimizer function to “Normal” or “Low,” and “Off” using SOUND OPTIMIZER on the receiver.

Notes

- This function does not work in the following cases.
 - “MULTI IN” is selected.
 - “2ch Analog Direct” is being used.
 - Headphones are being used.
- The receiver may play back signals at a lower sampling frequency than the actual sampling frequency of the input signals, depending on the audio format.

Tip

By using the equalizer function and adjusting all the speakers at one time, you can make fine adjustments with the Sound Optimizer.

Adjusting the equalizer

You can use following parameters to adjust the tonal quality (bass/treble level) of front, surround/surround back and front high speakers.

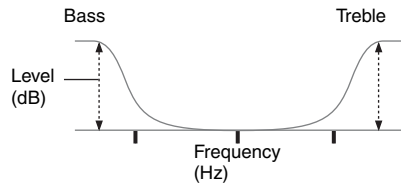

For the center speaker, you can also adjust the middle level:

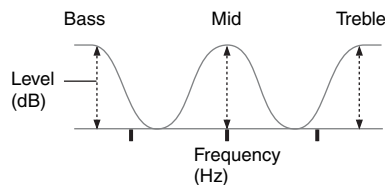







- 1 Select “Settings” from the home menu, then press \oplus .**
- 2 Select “Audio Settings,” then press \oplus .**
- 3 Select “Equalizer,” then press \oplus .**
- 4 Select “Front,” “Center,” “SUR/SB,” or “Front High,” then press \oplus .**
- 5 Select “Bass,” “Mid” (for the “Center” speaker only), or “Treble.”**
- 6 Adjust the gain, then press \oplus .**

Notes

- This function does not work in the following cases.
 - “MULTI IN” is selected.
 - “2ch Analog Direct” is being used.
- Frequencies for Bass, Treble, and Mid are fixed.

To adjust all the speakers at one time (All EQ Adjustment)

You can adjust the tonal quality (bass/treble) of all the speakers at one time.

- 1 Select "Settings" from the home menu, then press .
- 2 Select "Audio Settings," then press .
- 3 Select "Equalizer," then press .
- 4 Select "All," then press .
- 5 Select "Bass" or "Treble," then press .
- 6 Adjust the gain, then press .



Note

Depending on the equalizer setting for each channel, the actual levels set with the All EQ Adjustment may be lower or higher than the specified values.

Using the Universal Remote Control Function

Selecting the equipment you want to operate

By using the remote control supplied with the receiver, you can control AV equipment, such as a Blu-ray Disc player. You should make connections and settings in advance. For details, see “5: Connecting the IR blaster” (page 42) and “Making Universal Remote Control settings” (page 70).

- 1 Select “Watch” or “Listen” on the home menu, then press .**
- 2 Select the equipment you want to operate, then press .**

The selected equipment is turned on, and the receiver is switched to the input from that equipment. Depending on the equipment and settings, the monitor is also turned on.

Tips

- You can turn the INPUT SELECTOR dial on the receiver to select the equipment you want to operate. To select equipment in zone 2 or zone 3, press ZONE SELECT on the receiver. (“ZONE 2 [input name]” or “ZONE 3 [input name]” appears on the display window of the front panel.)
- You can also press the input buttons on the remote control to select the equipment you want to operate. To select equipment in zone 2 or zone 3, press ZONE on the remote control first.

Operating the AV equipment

Press the appropriate button on the remote control to operate the equipment.

The receiver will transmit infrared commands to operate the selected AV equipment via the IR blaster connected to the IR REMOTE OUT jack.^{1) 2)}

- ¹⁾You should make necessary connections and settings in advance.
- ²⁾Depending on the equipment and settings, some buttons or functions may not work.

Refer to the next table for the available buttons to operate the equipment.

Table of buttons available to operate the equipment

Equipment Category	TV	Projector	Blu-ray Disc Player/DVD player/Game	Cable box	Disc Changer	Satellite Receiver	VCR/MD/ Camcorder	CD
Button								
Numeric buttons	●		●	●	●	●	●	●
GUIDE	●		●	●	●	●	●	●
Color buttons	●		●		●			
INFO/OPTIONS	●		●	●	●	●	●	●
RETURN/EXIT	●	●	●	●	●	●	●	
▲/▼/◀/▶ (⊕)	●	●	●	●	●	●	●	●
⏮/⏭			●	●	●	●	●	●
⏪/⏩			●	●	●	●	●	●
▶, , ■			●	●	●	●	●	●
CH +/-	●		●	●	●	●	●	
MENU	●	●	●	●	●	●	●	●
PAGE +/-			●			●		
●			●			●	●	

Note

The above buttons are typically set so they are available to operate the equipment. Depending on the equipment and/or settings, some of the buttons may not work.

Turning off all connected equipment (ROOM OFF)

By pressing just one button, you can turn off the zone and the equipment in that zone all at once.

The receiver remembers which pieces of equipment it has turned on. When ROOM OFF is pressed, the receiver turns them all off. Pieces of equipment that you have turned on manually without using the receiver will remain on.

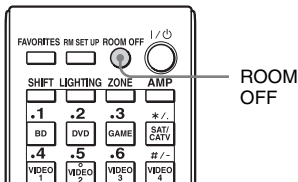



Press **ROOM OFF**.

Making Universal Remote Control settings

With the TV Control or AV Equipment Control wizard, you can make settings required for Universal Remote Control of the AV equipment you want to use.

The remote control is initially set to operate Sony products.

- 1 Press HOME.**
- 2 Select “Settings,” then press .**
- 3 Select “Home Control Settings,” then press .**

4 Select “TV Control” to set up a TV or projector. Select “AV Equipment Control” to set up a player.

5 Follow the on-screen instructions to set up the equipment.

Note

This function downloads settings for each piece of equipment from a server on the Internet. To perform these operations, the receiver should be connected to the Internet.

Using the Home Automation Function

Saving various settings for the receiver and recalling those settings all at one time (Easy Automation)

As well as the settings for the receiver operations, you can save various settings with the player, monitor, lighting, or curtain conditions at home, according to your listening and viewing style. You can register those settings for “one-touch” operation, and then recall the environment created with the settings easily, so you can enjoy listening and viewing at home.

For example, by saving the settings in the “1: Movie” scene as follows, you can switch the settings of the receiver all at one time by a simple, one-touch operation without switching each setting for “Input,” “Calibration Type,” “Sound Field,” and “HDMI Out,” individually.

Setting item	Value set for “1: Movie”
Input	BD
Calibration Type	No Change
Sound Field	HD-D.C.S.
HDMI Out	HDMI OUT B
Party Mode	ON
Lighting Scenes	Scene 5

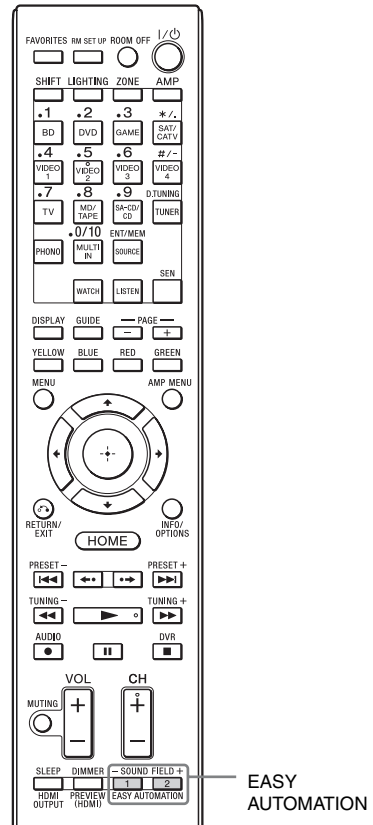

The items for which you can save settings and the default values for each item are as follows.

Setting item	Default value			
	1: Movie	2: Music	3: Party	4: Night
Input	BD	SA-CD/ CD	No Change	No Change
Tuner Preset	–	–	–	–
Player Operation	Play	Play	Play	–
Interval	30s	10s	10s	–
Sound Field	HD-D.C.S.	Berlin Philharmonic Hall	Multi Stereo	No Change
Sleep	No Change	No Change	Off	30 min.
Volume	No Change	No Change	–10 dB	–30 dB

continued

Setting item	Default value			
	1: Movie	2: Music	3: Party	4: Night
HDMI Out	No Change	No Change	No Change	No Change
Party Mode	No Change	No Change	On	No Change
Calibration Type	No Change	No Change	No Change	No Change
Sound Optimizer	No Change	No Change	Off	Normal
Equalizer (All)	No Change	No Change	No Change	No Change
Equalizer (Front)	No Change	No Change	No Change	No Change
Equalizer (Center)	No Change	No Change	No Change	No Change
Equalizer (SUR/SB)	No Change	No Change	No Change	No Change
Equalizer (Front High)	No Change	No Change	No Change	No Change
Main Zone 12V Trigger	No Change	No Change	No Change	No Change
Zone2 12V Trigger	No Change	No Change	No Change	No Change
Zone3 12V Trigger	No Change	No Change	No Change	No Change
Lighting Scenes	Scene2 All Off	Scene3 50% On	Scene1 All On	Scene2 All Off

Recalling the settings saved to the Scene

- 1 Select “Easy Automation” from the home menu, then press **+**.
- 2 Select a Scene you want, then press **+**.

Saving the settings to a Scene

- 1 Select “Easy Automation” from the home menu, then press **+**.
- 2 Select a Scene for which you want to save settings among from “1: Movie,” “2: Music,”

“3: Party,” or “4: Night,” then press **INFO/OPTIONS**.

- 3 Select the menu you want, then press **+**.

Menu	Explanation
Edit a saved Scene	Allows you to customize and save the settings to suit your preferences.
Import Current Settings	Loads the present settings of the receiver and saves those settings with the Scene. “Input” and “Volume” are set to “No Change.”

Notes

- Settings items saved as “No Change” are not changed from the present settings even when you recall the Scene. Select “Edit a saved Scene,” then uncheck the box for a setting item on the edit screen to set “No Change.”
- When you recall the Scene, the settings that cannot be applied are ignored (e.g., the value for “Sound Field” when “MULTI IN” is selected, etc.).
- When any of the setting items “Main Zone 12V Trigger,” “Zone2 12V Trigger,” or “Zone3 12V Trigger” is set to either “ON” or “OFF” rather than “No Change,” the “12V Trigger” of Zone Setup for each zone will be changed to “Ctrl” automatically.

Tip

You can recall the setting(s) saved for “1: Movie” or “2: Music” directly by pressing **EASY AUTOMATION 1** or **EASY AUTOMATION 2** on the receiver or the remote control. You can also overwrite “1: Movie” or “2: Music” with the present settings by holding down **EASY AUTOMATION 1** or **EASY AUTOMATION 2** for 3 seconds in the same way as you do when you select “Import Current Settings” from the menu.

Lighting Control

You can operate Control4-compatible lighting devices in your home via the on-screen GUI with the supplied remote control, or via “ES Remote” on your iPod touch/iPhone/Android smart phone. You can turn those devices on or off, or adjust their lighting level. You can also save your favorite settings as scenes and call up them quickly.

To enjoy Lighting Control, connect the supplied Lighting Control Adapter (UWA-C4Z) to the UWA-C4Z port on the rear of the receiver. Then prepare the Control4-compatible lighting devices, and set them up in advance.

Operating a lighting device

You can operate a lighting device from the Lighting page on the on-screen GUI or from the remote control.

1 Select “Lighting” on the home menu.

The lighting devices available are displayed.

2 Select the desired lighting device with \uparrow/\downarrow .

3 Turn the selected lighting device on/off or adjust the lighting level.

Turn the lighting device on or off:
Press \oplus to turn on the lighting device so that “ON” is displayed. To turn it off, press \ominus again so that “OFF” is displayed.

Adjust the lighting level:

Press \leftarrow/\rightarrow to move the cursor ($\blacktriangleleft/\blacktriangleright$) to adjust the level. (for equipment that has a “Dimmer” function.)

Selecting a lighting scene

1 Select “Lighting” on the home menu.

The lighting devices available are displayed.

2 Press INFO/OPTIONS.

The Lighting Scenes list appears.

3 Select the desired lighting scene with \uparrow/\downarrow then press \oplus .

Tip

To select a Lighting Scenes using the remote control, press LIGHTING on the remote control. (The LIGHTING and SHIFT buttons light.) Then press the appropriate numeric buttons, so that the receiver switches to the Lighting Scenes of the selected number.

Setting up a lighting device

The Lighting Control wizard allows you to set up lighting devices.

1 Select “Settings” from the home menu, then press \oplus .

2 Select “Home Control Settings,” then press \oplus .

3 Select “Lighting Control,” then press \oplus .

The Lighting Control wizard starts.

4 Follow the on-screen instructions to set up the lighting device.

Setting up a lighting scene

The Lighting Scenes wizard allows you to set up a lighting scene. There are 10 preset lighting scenes. You can set up a lighting scene by overwriting a preset scene.

- 1 Select “Settings” from the home menu, then press .**
- 2 Select “Home Control Settings,” then press .**
- 3 Select “Lighting Scenes,” then press .**

The Lighting Scenes wizard starts and the current lighting scenes list appears.
- 4 Select the lighting scene you want to edit with  then press .**
- 5 Follow the on-screen instructions to set each lighting device.**

Note

Do not remove the Lighting Control Adapter while the receiver is turned on. Data may be damaged and the receiver may become inoperative. When you remove the receiver, make sure that all the Lighting Control Adapters have been removed using the Wizard and then turn the receiver off (not in the Network Standby mode, but in the mode where the power of the receiver is turned completely off).

Using Multi-zone Features

What you can do with the Multi-zone function

You can enjoy images and sounds from a device connected to the receiver in a zone other than the main zone. For example, you can watch the DVD in the main zone and listen to the CD in zone 2 or zone 3.

When using an IR repeater (not supplied), you can operate both a device in the main zone and Sony receiver in zone 2 or zone 3 from zone 2 or zone 3 using the remote control. Use an IR repeater when you install the receiver in a place where signals from the remote control cannot reach.

Making a multi-zone connection

To output to zone 2: Signals from equipment connected to analog input jacks are output through the ZONE 2 VIDEO/AUDIO OUT or ZONE 2 OUT component jacks. The ZONE 2 VIDEO/AUDIO OUT or ZONE 2 OUT component jacks cannot output the signals from HDMI IN jacks. To output the HDMI signals, use HDMI ZONE 2 OUT jacks.

To output to zone 3: Only signals from equipment connected to the analog input jacks are output through the ZONE 3 OUT jacks. No signals are output from equipment connected to only the digital input jacks.

1: Zone 2 connections

- ① Outputs sound from speakers in zone 2 using the SURROUND BACK (ZONE 2) terminals of the receiver.

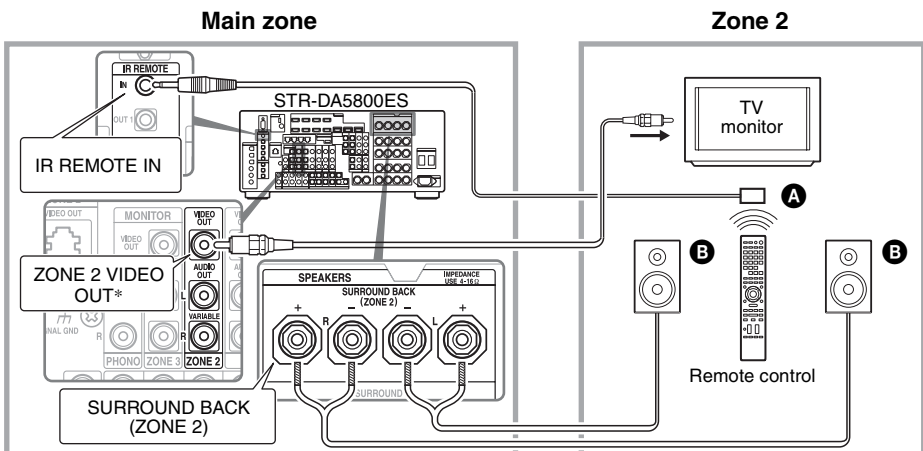

② Outputs sound from speakers in zone 2 using the receiver and another amplifier.

Setting the speakers in zone 2 is required (page 79).

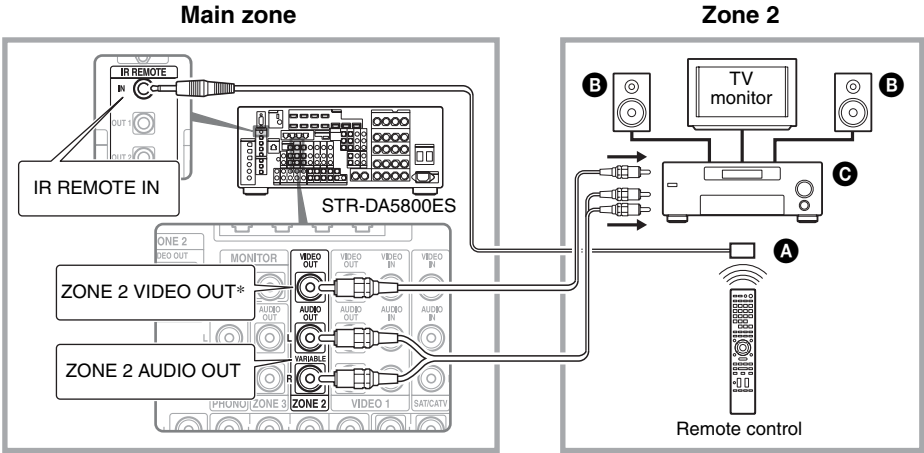

A IR repeater (not supplied)

B Speakers

C Other amplifier/receiver

* You can also connect to the ZONE 2 COMPONENT VIDEO OUT jack.

③ Making a zone 2 connection using HDMI

Outputs HDMI input video/audio signals in zone 2 using the HDMI ZONE 2 OUT jack of the receiver.

Setting the HDMI output in zone 2 may be required (page 79).

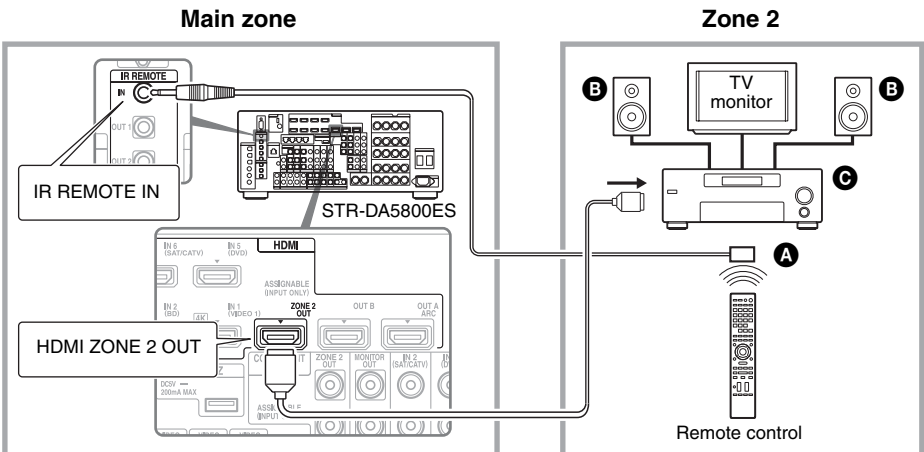

A IR repeater (not supplied)

B Speakers

C Other amplifier/receiver

Note

You can connect the HDMI ZONE 2 OUT jack directly to a TV in zone 2 (without any amplifier/receiver). It is recommended, however, that you connect a TV via an amplifier/receiver for higher audio/video capabilities, reducing possible effects on the main zone. When you select the same HDMI input for both the main zone and zone 2, the audio/video capabilities in the main zone will be limited in accordance with those in zone 2.

④ Making a zone 2 connection using ZONE 2 VIDEO OUT (RJ-45 jack)

ZONE 2 VIDEO OUT (RJ-45 jack) is used only for custom installation by a qualified person. ZONE 2 VIDEO OUT (RJ-45 jack) is a jack that sends a source video signal to the component video input for zone 2. For details, consult your dealer.

Attention

Do not use this jack for an Ethernet LAN connection. Doing so may cause a malfunction. The router may be damaged.

ZONE 2 VIDEO OUT (RJ-45 jack) connection

The RJ-45 pinouts use the T568B standard. Refer to the illustration below.

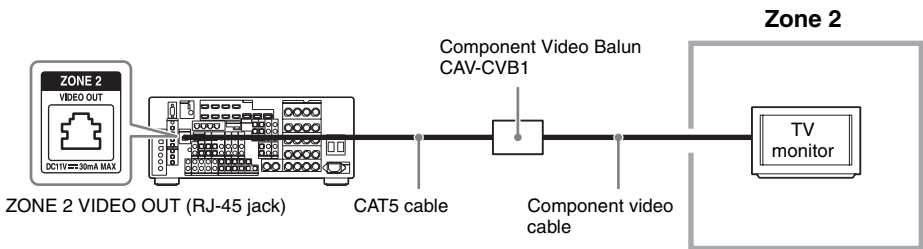

Note

CAV-CVB1 (Component Video Balun) must be used. Other types will cause trouble and may void your warranty.

CAT5 cable

Be sure to verify the CAT5 wiring connection is correct. Use Category 5e or Category 6 cable.

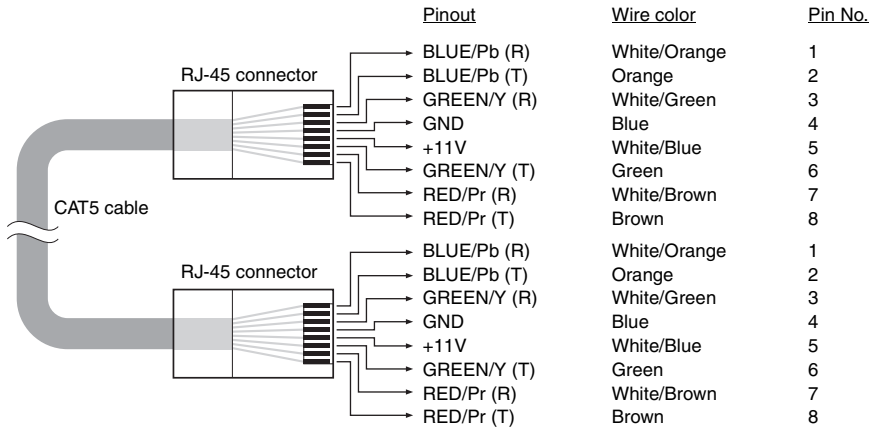

2: Zone 3 connections

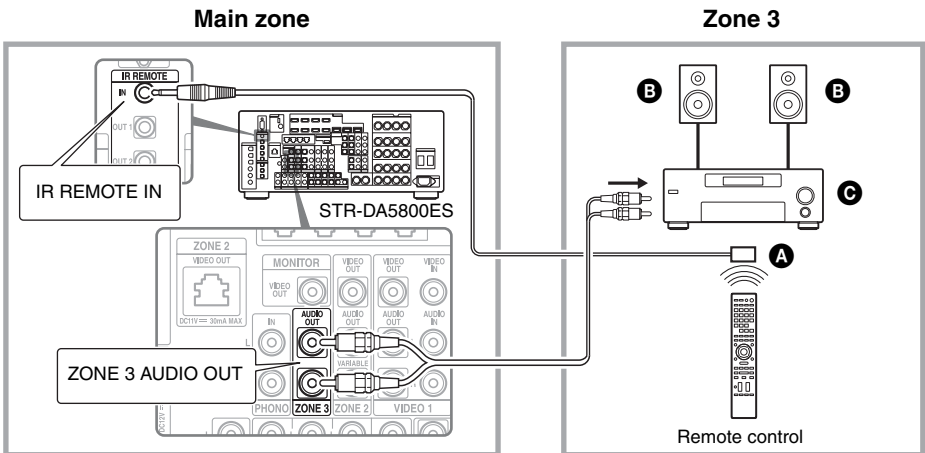

- A** IR repeater (not supplied)
- B** Speakers
- C** Other amplifier/receiver





Setting the speakers in zone 2

When the speakers in zone 2 are connected to the SURROUND BACK (ZONE 2) terminals of the receiver (page 75), make the setting so that the sound selected in zone 2 is output from the speakers connected to the SURROUND BACK (ZONE 2) terminals.

For details, see “Speaker Connection” in the Speaker Settings menu (page 101).

Set the volume control for zone 2

You can set the volume control for the ZONE 2 AUDIO OUT jacks variable or fixed.

- 1** Select “Settings” from the home menu, then press .
- 2** Select “Zone Settings,” then press .
- 3** Select “Zone Setup,” then press .
- 4** Select “Line Out” for “Zone2,” then press .
- 5** Select the parameter you want, then press .

Parameter	Explanation
Variable	The volume control is set to -40 dB initially. When you select this parameter, the volume for the ZONE 2 AUDIO OUT and the SURROUND BACK (ZONE 2) terminals can be changed in conjunction with each other. Recommended when using a power amplifier.

Parameter	Explanation
Fixed	The volume control is fixed to ± 0 dB. Recommended when using a device with the variable volume control.





Setting the HDMI output in zone 2

When equipment such as a TV or A/V amplifier is connected to the HDMI ZONE 2 OUT jack, you can output HDMI signals from the equipment in zone 2.

For details, see “ Making a zone 2 connection using HDMI” (page 76).

Setting the Zone2 HDMI output

You can output the signals from HDMI IN jacks to Zone2 equipment via the HDMI ZONE 2 OUT jacks as follows:





- 1** Select “Settings” from the home menu, then press .
- 2** Select “HDMI Settings,” then press .
- 3** Select “Zone2 Out,” then press .
- 4** Select “On,” then press .

Note

- When the Zone2 Out function is enabled, the following functions are disabled:
 - Control for HDMI (“BRAVIA” Sync)
 - Fast View (Including Preview for HDMI: On)

Setting the priority for the main zone and zone 2

When the Zone2 Out function is enabled and you select the same HDMI input for both the main zone and zone 2, there may be some interference on the audio and video signals in the main zone. To avoid possible interference, you can place priority on the main zone for HDMI input selection.

- 1** Select “Settings” from the home menu, then press .
- 2** Select “HDMI Settings,” then press .
- 3** Select “Priority,” then press .
- 4** Select “Main Only,” then press .

Switching the zone setting of the remote control

The remote control is basically designed for use in the main zone. The zone setting of the remote control is basically for use in zone 2. If you want to use it in zone 3, switch the zone setting of the remote control.

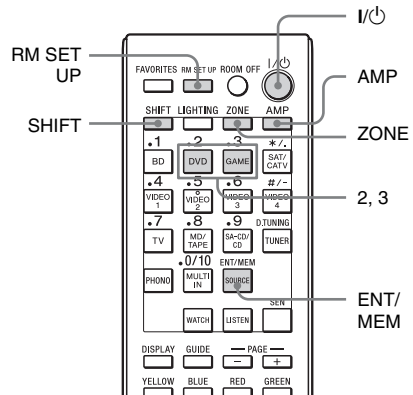

- 1** Press  while pressing **RM SET UP**.
The AMP and ZONE buttons flash.
- 2** Press **ZONE**.
The AMP button goes off, the ZONE button keeps flashing and the SHIFT button lights up.
- 3** Press the numeric button **2** for the zone 2, or **3** for the zone 3 while the ZONE button is flashing.
The ZONE button lights up.
- 4** Press **ENT/MEM**.
The ZONE button flashes twice and the remote control switches to zone 2 or zone 3 mode.

Operating the receiver from another zone

(ZONE 2/ZONE 3 operations)

You can operate the receiver from zone 2 or zone 3. The procedures in this section describe the operations when an IR repeater, useful for multi-zone features, is connected. When an IR repeater is not connected, use this receiver in the main zone.

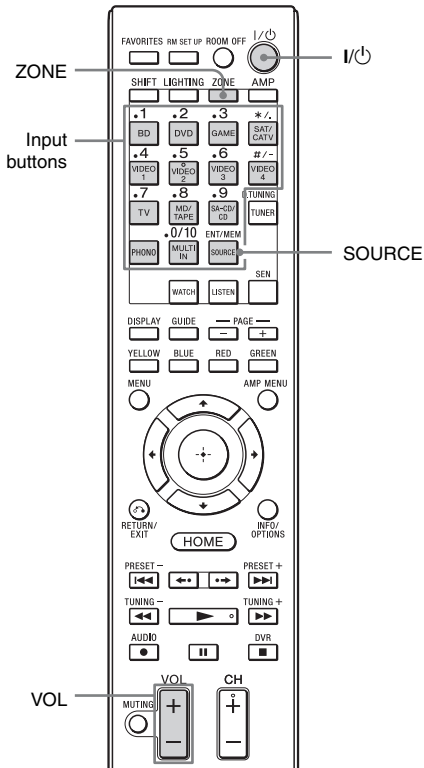

1 Turn on the amplifier in zone 2 or zone 3.

In the case of illustration 1-① (page 75), skip this step.

2 Press ZONE.

The remote control switches to zone 2 or zone 3. Change the zone setting of the remote control to zone 2 or zone 3 in advance (page 80).

3 Press I/⏻.

The zone function is activated.

4 Press one of the input buttons on the remote control to select the source signals you want to output.

5 Adjust to a suitable volume.

- In the case of illustration 1-① (page 75), adjust the volume using VOL +/- on the remote control.
- In the case of illustration 1-② (page 76) or 2 (page 78), adjust the volume using the receiver in zone 2 or zone 3. If you set "Line Out" for "Zone2" to "Variable," you can also adjust the volume in zone 2 using VOL +/- on the remote control (page 79).

Available multi-zone operations

INPUT	ZONE 2 ¹⁾	ZONE 3 ¹⁾
SOURCE ²⁾	○	○
BD	○	○
DVD	○	○
GAME	○	○
SAT/CATV	○	○
VIDEO 1	○	○
VIDEO 2	○	○
VIDEO 3	○	○
VIDEO 4	○	○
TV ³⁾	○	○
MD/TAPE	○	○
SA-CD/CD	○	○
FM ⁴⁾	○	○
AM ⁴⁾	○	○
PHONO ³⁾	○	○

continued

INPUT	ZONE 2 ¹⁾	ZONE 3 ¹⁾
MULTI IN ³⁾		
My Music ⁵⁾	○	○
My Video ⁵⁾	○	○
My Photo ⁵⁾	○	○
Internet services ⁵⁾	○	○

¹⁾For zone 2, HDMI signals, component video signals, analog video and audio signals are output. For zone 3, only analog audio signals are output. When you select SOURCE, the signals of the current input in the main zone are output.

²⁾When SOURCE is selected, the signals input to the MULTI CHANNEL INPUT jacks is not output from the ZONE 2 OUT or ZONE 3 OUT jacks even when “MULTI IN” is selected.

³⁾“TV,” “PHONO,” or “MULTI IN” can be selected in the main zone only.

⁴⁾You can select either “FM” or “AM” from the main zone, zone 2, or zone 3. When you want to switch between “FM” and “AM” from zone 2 or zone 3, select the appropriate zone using the remote control, and then press TUNER repeatedly. Every time you press the button, “FM” and “AM” are switched. When different programs are selected in multiple zones, the input you have selected most recently is given preference.

⁵⁾Only when SOURCE is selected in zone 2 or zone 3, you can enjoy the content, being viewed in the main zone, in zone 2 or zone 3.

To finish the zone 2/zone 3 operation

Press ZONE, then press I/⏻.

Tip

You can select a zone on the receiver. Press ZONE SELECT repeatedly to select zone 2, zone 3 or the main zone. Each time you press ZONE POWER, the output signals for the selected zone will be turned on or off.

Using “BRAVIA” Sync features

What is “BRAVIA” Sync?

“BRAVIA” Sync is the name of a function on Sony products that enables compatible equipment connected via HDMI cables to be operated mutually using the “BRAVIA” remote control.

This mutual operation is enabled by the Control for HDMI function using HDMI CEC (Consumer Electronics Control) standardized for HDMI (High-Definition Multimedia Interface).

By connecting Sony equipment that are compatible with the “BRAVIA” Sync with an HDMI cable (not supplied), operation is simplified as below:

- System Power-Off (page 84)
- One-Touch Play (page 84)
- System Audio Control (page 84)
- Audio Return Channel (ARC) (page 85)
- Scene Select (page 85)
- Home Theater Control (page 85)
- Remote Easy Control (page 85)

The Control for HDMI function does not work in the following cases:

- When you connect the receiver to a device which does not correspond to the Sony Control for HDMI function.
- When you connect the receiver and equipment using other than an HDMI connection.
- The Control for HDMI function does not work on a device connected to the HDMI OUT B jack of the receiver.

- When you set “Zone2 Out” in the “HDMI Settings” menu to “On,” you cannot use the “Control for HDMI” function.

We recommend that you connect the receiver to products featuring “BRAVIA” Sync.





Notes

- The following features may operate with non-Sony equipment. However, compatibility with all non-Sony equipment is not guaranteed.
 - System Power-Off
 - One-Touch Play
 - System Audio Control
- The following features are Sony proprietary functions. They cannot operate with non-Sony equipment.
 - Scene Select
 - Home Theater Control
- Equipment not compatible with “BRAVIA” Sync cannot activate these features.

Preparing for the “BRAVIA” Sync

To use the “BRAVIA” Sync, turn the Control for HDMI function on for both the receiver and the connected equipment.

Turn the Control for HDMI function of the receiver and the connected equipment on individually.

- 1** Select “Settings” from the home menu, then press .
 - 2** Select “HDMI Settings,” then press .
 - 3** Select “Control for HDMI,” then press .
 - 4** Select “On,” then press .
- The Control for HDMI function of the receiver is activated.

5 Turn the Control for HDMI function of the connected equipment on.

For details on setting the connected equipment, refer to its operating instructions.

6 Repeat step 5 to set the Control for HDMI function and to display the image of all the playback equipment you want to use.

Note

When you pull out the HDMI cable or change the connection, perform the steps above. However, you do not need to perform these steps when you use an HDMI IN 1, IN 2, IN 3, or IN 9 jack.

System Power-Off

When you turn the TV off, using the power button on the TV's remote control, the receiver and the connected equipment turn off automatically.

Notes

- Set the TV power supply interlock function to on before using the System Power-Off function. For details, refer to the operating instructions of the TV.
- Depending on the condition of the connected equipment, the connected equipment may not be turned off. For details, refer to the operating instructions of the connected equipment.
- If you use the System Power-Off function with a non-Sony TV, program the remote control according to the maker of the TV.

One-Touch Play

When you play back content on the equipment connected to the receiver via an HDMI connection, the receiver is also turned on automatically and is switched to the appropriate HDMI input.

When you set "Pass Through" to "On," or "Auto," sound and image can be output only from the TV while the receiver remains in standby mode.

Start playback on the playback equipment.

To use the One-Touch Play function of the camcorder

- 1 Turn the Control for HDMI function on for both the receiver and your camcorder.
- 2 Connect your camcorder to one of the HDMI IN 1, IN 2, IN 3, and IN 9 jacks (page 35).
If you use a Sony camcorder, the TV is turned on in conjunction with the receiver, then the camcorder starts playback automatically. If you use a non-Sony camcorder, play back the camcorder continuously.

Notes

- Depending on the TV, the start of the content may not appear.
- Connect equipment such as a Sony camcorder equipped with the One-Touch Play function simply by making an HDMI connection to the HDMI IN 1, IN 2, IN 3, and IN 9 jacks. If you use other HDMI IN jacks, the receiver may not be switched to an appropriate input. In this case, manually select the input to which the camcorder is connected.

System Audio Control

You can enjoy the TV sound from the speakers connected to the receiver by a simple operation. You can also adjust the volume and turn off the sound of the receiver using the TV's remote control.

You can use the System Audio Control function as follows.

- The sound of the TV is output from the speakers connected to the receiver when you turn the receiver on while the sound is being output from the TV speaker. If you turn off

the receiver, the sound is output from the TV speaker.

- When you adjust the TV volume, the System Audio Control function adjusts the receiver's volume simultaneously.

You can also operate this function using the TV menu. For details, refer to the operating instructions of the TV.

Note

When "Control for HDMI" is set to "On," the "Audio Out" settings in the HDMI Settings menu will set automatically based on the System Audio Control settings.

Audio Return Channel (ARC)

If the TV is compatible with the Audio Return Channel (ARC), an HDMI cable connection also sends a digital audio signal from the TV to the receiver. You do not need to make a separate audio connection for listening to TV sound from the receiver.

For details, see "Switching between digital and analog audio" (page 87).

Scene Select

The optimum picture quality and sound field are selected automatically according to the scene selected on your TV.

For details on the operation, refer to the operating instructions of the TV.

Note

The sound field may not switch depending on the TV.

Correspondence table

Scene setting on the TV	Sound field
Cinema	HD-D.C.S.
Sports	SPORTS
Music	Live Concert
Animation	A.F.D. Auto
Photo	A.F.D. Auto
Game	A.F.D. Auto

Scene setting on the TV	Sound field
-------------------------	-------------

Graphics	A.F.D. Auto
----------	-------------

Home Theater Control

If a "Home Theater Control"-compatible TV is connected to the receiver, an icon for Internet based applications appears on the connected TV.

You can switch an input of the receiver or switch sound fields by using your TV's remote control. You can also adjust the level of the center speaker or the subwoofer, or adjust the settings of "Sound Optimizer" (page 66), "Dual Mono" (page 106), or "A/V Sync" (page 107).

To use the Home Theater Control function, your TV must be able to access a broadband service.

Remote Easy Control

You can use the TV remote control to operate the menu of the receiver.

Select the receiver (AV AMP) recognized by the TV.

Notes

- The receiver is recognized as "Tuner (AV AMP)" by the TV.
- Your TV must be compatible with the link menu.
- Depending on the type of TV, some of operations may not be available.

Switching the monitors that output the HDMI video signals

When you have two monitors connected to the HDMI OUT A and HDMI OUT B jacks, you can switch the output for these two monitors using the HDMI OUTPUT button on the remote control.

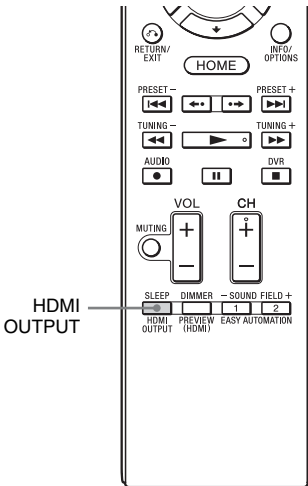

- 1 Turn on the receiver and the two monitors.
- 2 Press HDMI OUTPUT.

Each time you press the button, the output will be switched as follows:

HDMI A → HDMI B → OFF → HDMI A...

You can also use the HDMI OUT button on the receiver.

Outputting the HDMI signals even when the receiver is in standby mode

(Pass Through)

You can output the video and audio signals from the HDMI IN jack to the TV connected to the HDMI OUT A jack even when the receiver is in standby mode.

If you use this function while “Control for HDMI” is set to “On,” the input of the receiver is switched in accordance with the operation of the connected equipment, even when the receiver is in standby mode.

When you activate this function, make the settings for “Pass Through” following the steps below.

- 1 Select “Settings” from the home menu, then press **⊕**.
- 2 Select “HDMI Settings,” then press **⊕**.
- 3 Select “Pass Through,” then press **⊕**.
- 4 Select the parameter you want, then press **⊕**.

Parameter	Explanation
Auto	When the TV is turned on while the receiver is in standby mode, the receiver outputs HDMI signals from the receiver’s HDMI OUT A jack. Sony recommends this setting if you use a TV that is compatible with “BRAVIA” Sync. This setting saves power in standby mode compared with the “On” setting.

Parameter	Explanation
On	When the receiver is in standby mode, the receiver outputs HDMI signals from the receiver's HDMI OUT A jack.
Off	The receiver does not output HDMI signals when in standby mode. Turn on the receiver to enjoy the connected equipment's source on the TV. This setting saves power in standby mode, compared with the "On" setting.

Notes

- The "Auto" setting is effective only when "Control for HDMI" is set to "On." If "Control for HDMI" is set to "Off," the receiver performs the same operations in "Auto" as in "On."
- In the standby status where other function such as Network Standby works, the power consumption is not reduced, even when "Pass Through" is set to "Auto."

Switching between digital and analog audio

When you connect equipment to both digital and analog audio input jacks on the receiver, you can fix the audio input mode to either of them, or switch from one to the other, depending on the type of material you intend to watch.

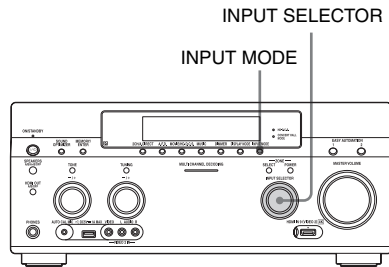

1 Select the input source using **INPUT SELECTOR** on the receiver.

2 Press **INPUT MODE** on the receiver.

The selected audio input mode appears in the display window.

- **AUTO**

Gives priority to digital audio signals when there are both digital and analog connections.

If there are no digital audio signals, analog audio signals are selected.

When TV input is selected, priority is given to the Audio Return Channel (ARC) signals. If your TV is not compatible with Audio Return Channel (ARC), the digital optical audio signals are selected.

If the Control for HDMI functions of both the receiver and the TV are not activated, the Audio Return Channel (ARC) function does not work.

- **OPT**
Appears only when an optical jack is assigned to the input and selects the optical input jack automatically.
- **COAX**
Appears only when a coaxial jack is assigned to the input and selects the coaxial input jack automatically.
- **ANALOG**
Specifies the analog audio signals input to the AUDIO IN (L/R) jacks.

Notes



- Based on the input, “-----” appears on the display window, and other modes cannot be selected.
- When “2ch Analog Direct” is being used, or “MULTI IN” is selected, audio input is set to “Analog.” You cannot select other modes.

Using other video/audio input jacks

You can reassign video and/or audio signals to another input jacks.

Example) Connect the OPTICAL OUT jack of the DVD player to the OPTICAL IN 1 jack of this receiver when you want to input the only digital optical audio signals from the DVD player.

Connect the component video jack of the DVD player to the COMPONENT VIDEO IN 1 or COMPONENT VIDEO IN 2 jacks of this receiver when you want to input the video signals from the DVD player.

- 1** Select “Settings” from the home menu, then press .
- 2** Select “Input Settings,” then press .
- 3** Select “Video Input Assign” or “Audio Input Assign,” then press .

4 Select the audio and/or video signals you want to assign to each input.

Notes

- If you assign an input to any of the HDMI IN 1 to IN 9 jacks in “Video Input Assign” or “Audio Input Assign,” the same HDMI input jack is assigned to both the video input and audio input. If you want to assign an HDMI IN jack to either the video input or audio input, first assign an input to any of the HDMI IN 1 to IN 9 jacks in “Video Input Assign” or “Audio Input Assign.” Then, set the assignment of an HDMI IN jack to “None” in either “Video Input Assign” or “Audio Input Assign,” for whichever one you do not want to assign an HDMI IN jack to.
- When you operate the receiver without using the GUI, you can change the assignment of an HDMI IN jack using “HDMI VIDEO ASSIGN ?” or “HDMI AUDIO ASSIGN ?” in “INPUT SETTINGS” (page 125).
- If you change the assignment of an HDMI IN jack while the Control for HDMI function is being used, switch the input of the receiver to the input to which the HDMI equipment is connected. Otherwise the Control for HDMI function may not work properly.
- If you set the assignment of an HDMI IN jack to “None” in both “Video Input Assign” and “Audio Input Assign,” you cannot select the input signals via the HDMI input. In this case, the Control for HDMI function works only on equipment other than the receiver. However, this is not malfunction.

Input name		BD	DVD	GAME	SAT/ CATV	VIDEO 1	VIDEO 2	VIDEO 3	VIDEO 4	MD/ TAPE	SA-CD/ MULTI IN CD	
Assignable video input jacks	COMPONENT IN 1 (DVD)	○	○*	○	○	○	○	○	○	○	○	○
	COMPONENT IN 2 (SAT/CATV)	○	○	○	○*	○	○	○	○	○	○	○
	HDMI IN 1 (VIDEO 1)	○	○	○	○	○*	○	○	○	○	○	○
	HDMI IN 2 (BD)	○*	○	○	○	○	○	○	○	○	○	○
	HDMI IN 3 (SA-CD/CD)	○	○	○	○	○	○	○	○	○	○*	○
	HDMI IN 4 (GAME)	○	○	○*	○	○	○	○	○	○	○	○
	HDMI IN 5 (DVD)	○	○*	○	○	○	○	○	○	○	○	○
	HDMI IN 6 (SAT/CATV)	○	○	○	○*	○	○	○	○	○	○	○
	HDMI IN 7 (VIDEO 3)	○	○	○	○	○	○	○*	○	○	○	○
	HDMI IN 8 (VIDEO 4)	○	○	○	○	○	○	○	○*	○	○	○
HDMI IN 9 (VIDEO 2)	○	○	○	○	○	○*	○	○	○	○	○	
Assignable audio input jacks	OPTICAL IN 1 (GAME)	○	○	○*	○	○	○	○	○	○	○	-
	OPTICAL IN 2 (SAT/CATV)	○	○	○	○*	○	○	○	○	○	○	-
	OPTICAL IN 3 (TV)	○	○	○	○	○	○	○	○	○	○	-
	COAXIAL IN 1 (DVD)	○	○*	○	○	○	○	○	○	○	○	-
	COAXIAL IN 2 (VIDEO 1)	○	○	○	○	○*	○	○	○	○	○	-
	COAXIAL IN 3 (SA-CD/CD)	○	○	○	○	○	○	○	○	○	○	-
	HDMI IN 1 (VIDEO 1)	○	○	○	○	○*	○	○	○	○	○	-
	HDMI IN 2 (BD)	○*	○	○	○	○	○	○	○	○	○	-
	HDMI IN 3 (SA-CD/CD)	○	○	○	○	○	○	○	○	○	○	-
	HDMI IN 4 (GAME)	○	○	○*	○	○	○	○	○	○	○	-
	HDMI IN 5 (DVD)	○	○*	○	○	○	○	○	○	○	○	-
	HDMI IN 6 (SAT/CATV)	○	○	○	○*	○	○	○	○	○	○	-
	HDMI IN 7 (VIDEO 3)	○	○	○	○	○	○	○*	○	○	○	-
HDMI IN 8 (VIDEO 4)	○	○	○	○	○	○	○	○*	○	○	-	
HDMI IN 9 (VIDEO 2)	○	○	○	○	○	○*	○	○	○	○	-	

* factory default setting

continued

Notes

- When you assign the digital audio input, the INPUT MODE setting may change automatically.
- When you assign a video input to the component or composite input, and an audio input to the HDMI input, component or composite video signals are not output from the HDMI OUT jacks. Component or composite video signals are output from the COMPONENT VIDEO MONITOR OUT jacks or the MONITOR VIDEO OUT jack.
- You cannot assign different HDMI jacks to separate video and audio input jacks of an input.
- You can assign multiple inputs to the same HDMI IN jack. However, if you use the One-Touch Play function on the equipment connected to the HDMI IN jack, the input which has most recently been assigned is preferentially selected.

Preview for HDMI

You can turn on a live picture-in-picture preview of HDMI inputs connected to this receiver. Up to four preview windows are displayed for HDMI IN 1/IN 2/IN 3/IN 4 Input.

You can select each preview HDMI input by using the remote.

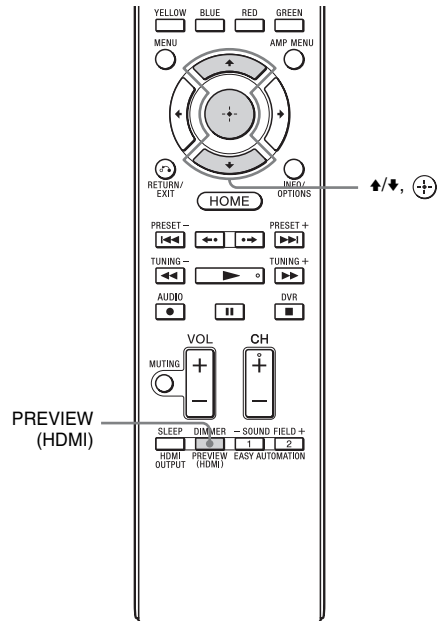

1 Press PREVIEW (HDMI).

Up to 4 PIP windows appear, each of them showing input pictures from HDMI IN jacks.

2 To switch the pictures in a PIP window with those on the main screen, press \uparrow/\downarrow to select the desired PIP window, then press \leftarrow/\rightarrow .

The HDMI input of the selected PIP window is displayed in the main window.

Tips

- This function does not work under the following conditions:
 - An HDMI device is not connected.
 - A specific HDMI device is connected while its power is off.
 - An unsupported HDMI video format is input.
 - The current input is not HDMI input
 - When the GUI menu is displayed.
 - When “Zone2 Out” is set to “On”
 - When “Fast View” is set to “Off”
- This function is made possible by Silicon Image InstaPrevue™ technology.

Operating the receiver using a smartphone

You can operate the receiver using a smartphone equipped with the “ES Remote” application software. The “ES Remote” application software can be downloaded from the App Store (for iPod touch/iPhone) or the Google Play (for Android phone) for free.

Using the sleep timer

You can set the receiver to turn off automatically at a specified time.

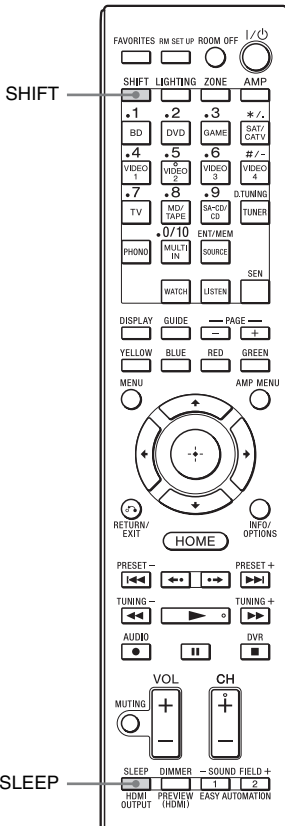

Press **SHIFT**, then press **SLEEP**.

Each time you press **SLEEP**, the display changes cyclically as follows:

0:30:00 → 1:00:00 → 1:30:00 → 2:00:00 → OFF

When sleep timer is being used, “**SLEEP**” lights up in the display window of the receiver. To check the remaining time before the receiver turns off, press **SLEEP**. The remaining time appears on the display window. If you press **SLEEP** again, the sleep timer is set to “**OFF**.”

Recording using the receiver

You can record from a video/audio device using the receiver. Refer to the operating instructions supplied with your recording equipment.

- 1** Select “**Watch**” or “**Listen**” from the home menu, then press **+**.
- 2** Select the playback equipment, then press **+**.
- 3** Prepare the equipment for playing.
For example, insert the video tape you want to copy into the VCR.
- 4** Prepare the recording equipment.
Insert a blank video tape, etc., into the recording equipment (VIDEO 1) for recording.
- 5** Start recording on the recording equipment, then start the playback equipment.

Switching the command mode of the receiver and the remote control

You can switch the command mode (COMMAND MODE AV1 or COMMAND MODE AV2) of the receiver and the remote control.

Switch the command mode from the factory default setting to the appropriate setting, if other Sony equipment is operated accidentally by the same remote control, when you are operating the receiver using the remote control supplied with the receiver.

The command modes of both the receiver and the remote control are those of the factory default setting (COMMAND MODE AV2). The receiver and the remote control, on the contrary, should use the same command mode. If the command modes of the receiver and the remote control are different, you cannot use the remote control to operate the receiver.

Switching the command mode of the receiver

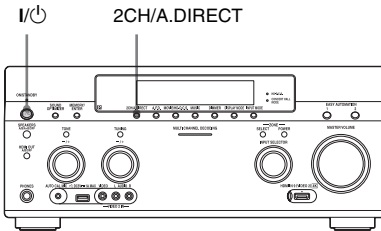

- 1** Press I/⏻ to turn off the receiver.
- 2** While holding down 2CH/A.DIRECT, press I/⏻ to turn on the receiver.

When the command mode is set to “AV2,” “COMMAND MODE [AV2]” appears on the display.

When the command mode is set to “AV1,” “COMMAND MODE [AV1]” appears on the display.

Switching the command mode of the remote control

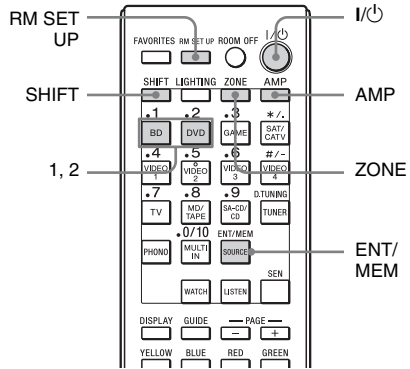

- 1** Press I/⏻ while pressing RM SET UP.
The AMP and ZONE buttons flash.
- 2** Press AMP.
The ZONE button goes off, the AMP button keeps flashing and the SHIFT button lights up.
- 3** Press the numeric button 1 or 2 while the AMP button is flashing.
When you press 1, the command mode is set to COMMAND MODE AV1. When you press 2, the command mode is set to COMMAND MODE AV2.
The AMP button lights up.
- 4** Press ENT/MEM.
The AMP button flashes twice, then the command mode setting process is completed.

Using a bi-amplifier connection

If you are not using surround back speakers you can use the SURROUND BACK (ZONE 2) terminals for the front speakers for use with a bi-amplifier connection.

To connect speakers

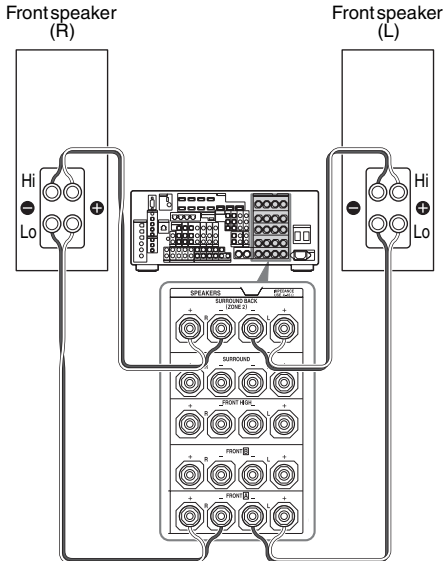

Connect the jacks on the Lo (or Hi) side of the front speakers to the FRONT **A** terminals, and connect the jacks on the Hi (or Lo) side of the front speakers to the SURROUND BACK (ZONE 2) terminals. Make sure that metal fittings of Hi/Lo attached to the speakers have been removed from the speakers to avoid receiver malfunction.

To set up speakers

For details, see “Speaker Connection” in the Speaker Settings menu (page 101).

Notes

- You cannot use the FRONT **B** terminals for a bi-amplifier connection.

- Make the bi-amplifier settings before you perform the Auto Calibration function.
- If you make the bi-amplifier settings, the speaker level, balance, and equalizer settings of the surround back speakers become invalid, and those of the front speakers are used.
- Signals output from the PRE OUT jacks are used with the same settings as those of the SPEAKERS terminals.
- If the speaker pattern is set so that there are surround back speakers, you cannot set the SURROUND BACK (ZONE 2) terminals for a bi-amplifier connection.
- When you operate the receiver without using the GUI, set “SB ASSIGN” to “BI-AMP” in “SPEAKER SETTINGS” (page 124).

Reverting back to the factory default settings

You can clear all memorized settings and revert the receiver back to the factory default settings by performing the following procedure. This procedure can also be used to initialize the receiver before you use it for the first time.

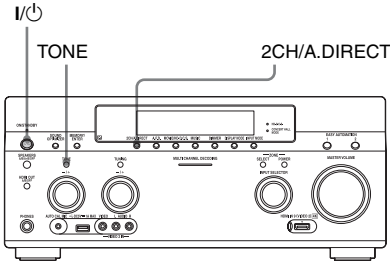

- 1 Press I/⏻ to turn off the receiver.**
- 2 While holding down the TONE and 2CH/A.DIRECT, press I/⏻ to turn on the receiver.**
- 3 Release the TONE and 2CH/A.DIRECT after a few seconds.**

The “MEMORY CLEARING...” appears on the display window for a while, then changes to “MEMORY CLEARED!” Changes or adjustments made to the settings are now reset to the defaults.

Note

It takes about a few minutes for the memory to be cleared completely. Do not turn the receiver off until “MEMORY CLEARED!” appears on the display.

Adjusting Settings

Using the setting menu

You can adjust the various settings for speakers, surround effects, multi-zone, etc., using the setting menu.

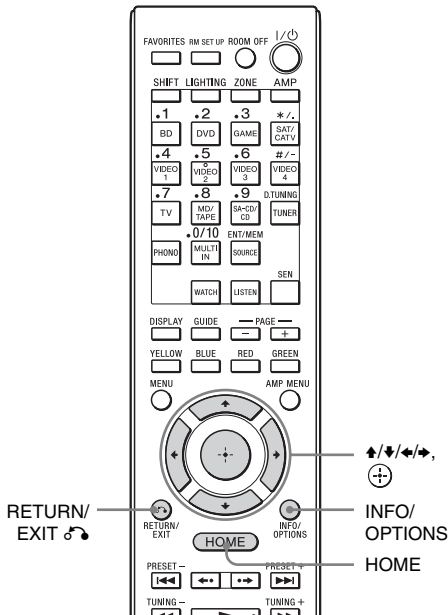

- 1 Select “Settings” from the home menu, then press **+** to enter the menu mode.

The setting menu list appears on the TV screen.

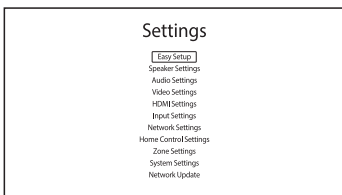

- 2 Select the menu item you want, then press **+** to access the menu item.

Example: When you select “Audio Settings.”

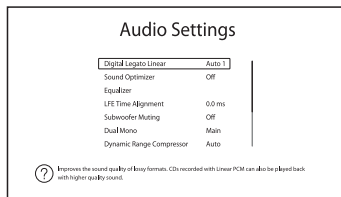

- 3 Select the parameter you want, then press **+** to enter.

To return to the previous screen
Press RETURN/EXIT **↶**.

To exit the menu

Press HOME to display the home menu,
then press HOME again.

Setting menu list

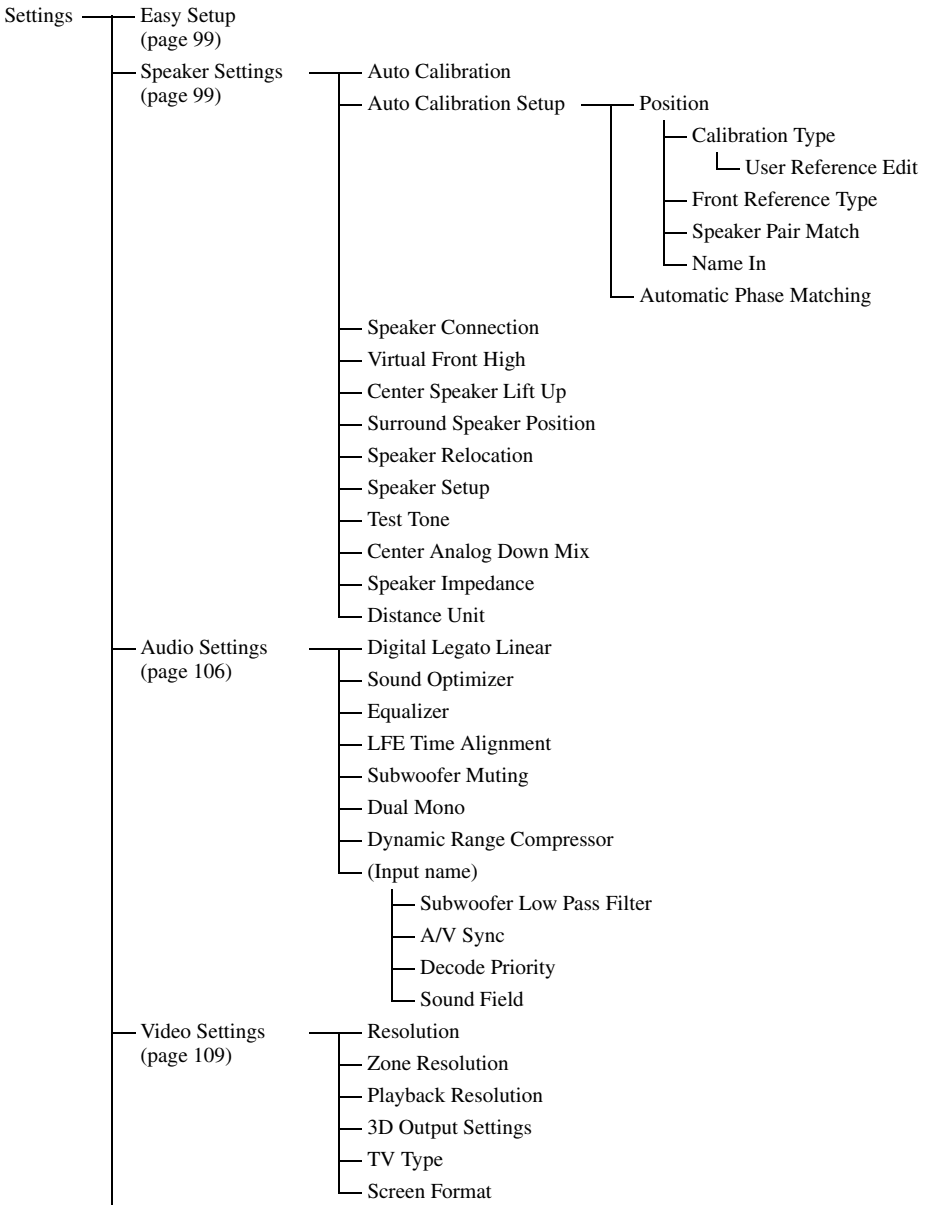

HDMI Settings (page 113)	<ul style="list-style-type: none"> (Input name) <ul style="list-style-type: none"> Subwoofer Level Audio Out H.A.T.S. Control for HDMI Pass Through Zone2 Out Priority Fast View
Input Settings (page 115)	<ul style="list-style-type: none"> Input Edit Audio Input Assign Video Input Assign
Network Settings (page 116)	<ul style="list-style-type: none"> Internet Settings Connection Server Settings Renderer Options Renderer Access Control External Control Network Standby
Home Control Settings (page 70)	<ul style="list-style-type: none"> TV Control AV Equipment Control Lighting Control Lighting Scenes Registration
Zone Settings (page 118)	<ul style="list-style-type: none"> Zone Control Zone Setup
System Settings (page 119)	<ul style="list-style-type: none"> Language Auto Standby Settings Lock RS232C Control Software Update Notification Initialize Personal Information System Information EULA Software License
Network Update (page 120)	

Easy Setup

Re-runs the Easy Setup to make the basic settings. Follow the on-screen instructions (page 46).

Speaker Settings

You can set up your viewing environment (with the speaker system you are using) either automatically or manually.

Auto Calibration

Performs the D.C.A.C. (Digital Cinema Auto Calibration) function. This function allows you to perform automatic calibration, such as checking the connection between each speaker and the receiver, adjusting the speaker level, and measuring the distance of each speaker from your seating position automatically.

Calibration Matching

When Auto Calibration is executed, this function works automatically, matching the distance and level of the right and left speakers. You can set this function only after the DCAC measurement process has been completed and the results of the DCAC measurement are saved. The setting is valid until you change it.

Note

The previous measurement results will be overwritten and the current results are saved for the currently selected position.

Please read “Notes on Speaker Settings (Auto Calibration)” in “9: Setting up the receiver using the Easy Setup” (page 46).

Auto Calibration Setup

Lets you register three patterns for “Position,” depending on the seating positions, listening environment, and measurement conditions. You can also select a calibration type to compensate the each speaker.

Position

You can register more than one set of settings for the listening environment or recall a set of settings.

continued

Select the “Position” for which you want to register the measurement results on the Auto Calibration Setup screen.

- Pos.1
- Pos.2
- Pos.3

To set a compensation type for the speakers

You can select the compensation type to be used for the speakers for each Position.

- 1 Select the “Position” for which you want to set the speaker compensation type, then press \oplus .
- 2 Select the “Calibration Type” you want, then press \oplus .
 - Full Flat
Makes the measurement of frequency from each speaker flat.
 - Engineer
Sets the frequency to match that of the Sony listening room standard.
 - Front Reference
Adjusts the characteristics of all the speakers to match the characteristics of the front speakers.
 - User Reference
Sets the frequency to one that you customized using “User Reference Edit.”
 - Off
Sets the Auto Calibration EQ to off.

Note

You cannot set the “Calibration Type” for “Position” for which the measurement results have not been registered.

To set the reference value when you select “Front Reference” for the “Calibration Type”

- 1 Select the “Front Reference Type” in the Calibration Type menu, then press \oplus .
- 2 Select the parameter you want, then press \oplus .

- L/R
Sets the data of the left and right channels to the reference value.
- L
Sets the data of the left channel to the reference value.
- R
Sets the data of the right channel to the reference value.

Notes

- This function works only when you select “Front Reference” for the “Calibration Type”.
- Perform “Auto Calibration” after you set “Front Reference Type.”

To customize the frequency for the “User Reference”

You can customize the frequency for the “User Reference” in the “Calibration Type” based on the “Full Flat” compensation type.

- 1 Select the “User Reference Edit” in the Calibration Type menu, then press \oplus .
- 2 Adjust the frequency.

To set the pair match mode for the Auto Calibration EQ pattern

- 1 Select the “Position” for which you want to set the pair match mode, then press \oplus .
- 2 Select “Speaker Pair Match,” then press \oplus .
 - All
Calibrates all the speakers using the pair match processing of the left and right channels for each pair of speakers.
 - Sur
Calibrates the surround speakers and the surround back speakers using the pair match processing or the left and right channels for each pair of speakers.
 - Off
Calibrates each speaker individually.

Notes

- This function does not work when “Auto Calibration” has not been performed.

- You cannot set “SP Pair Matching” to “ALL” when you select “Front Reference” for the “Calibration Type” (page 100).

To name the Position

- 1 Select the “Position” for which you want to name, then press \oplus .
- 2 Select “Name In,” then press \oplus .
The soft keyboard appears on the screen.
- 3 Press $\uparrow/\downarrow/\leftarrow/\rightarrow$ and \oplus to select a character one by one.

Automatic Phase Matching

Lets you set the A.P.M. (Automatic Phase Matching) function in the D.C.A.C. (Digital Cinema Auto Calibration) function (page 99). Calibrates the phase characteristics of the speakers and ensures a well-coordinated surround space.

■ Off

Does not activate the A.P.M. function.

■ Auto

Switches the A.P.M. function on or off automatically.

Notes

- This function does not work in the following cases.
 - “MULTI IN” is selected.
 - “2ch Analog Direct” is being used.
 - Headphones are connected.
 - “Auto Calibration” has not been performed.
- The receiver may play back signals at a lower sampling frequency than the actual sampling frequency of the input signals, depending on the audio format.

Speaker Connection

Lets you adjust each speaker manually. You can also adjust the speaker levels after Easy Setup is completed.

The Speaker Settings are only for the current “Position.”

You can make the following settings using the wizard.

Speaker Pattern

Lets you select the speaker pattern for the speaker systems you are using.

Surround Back Assign

Lets you set the SURROUND BACK (ZONE 2) terminals for a bi-amplifier or a zone 2 connection.

■ Zone2 Speakers

■ Bi-Amplifier

■ No Assign

Note

If the speaker pattern is set so that there are surround back speakers, you cannot set the SURROUND BACK (ZONE 2) terminals for a bi-amplifier connection or a zone 2 connection.

Virtual Front High

Lets you reproduce sound outputs virtually from the front high speakers even in an environment without front high L/R speakers.

■ On

The Virtual Front High function is activated. When Front High signals are input, sounds are processed as if they were output from front high L/R speakers.

■ Off

The Virtual Front High function is disabled.

Note

- This function does not work in the following cases:
 - There are no surround speakers.
 - “MULTI IN” is selected.
 - “2ch Analog Direct” is selected.
 - Headphones are connected.

Center Speaker Lift Up

By using the front high speakers, you can lift up the sounds of the center speaker to an appropriate height on the screen, allowing you to enjoy natural representation without discomfort.

■ 1~10

■ Off

Note

- This function does not work in the following cases.
 - “MULTI IN” is selected.
 - Headphones are connected.
 - There is no center speaker.
 - There are no front high speakers and “Virtual Front High” is set to “Off.”
 - The 2CH mode sound field is being used.
 - The sound filed for music is being used.
 - The “Multi Stereo” sound filed is being used.
 - The “Movie Height” sound filed is being used.

Surround Speaker Position

Lets you set the correct angles of the surround speakers for the Speaker Relocation function.

■ Front

■ Back

Note

- This function does not work in the following cases:
 - There are no surround speakers.
 - Headphones are connected.

Speaker Relocation

Lets you calibrate speaker positioning (configuration angle of each speaker from the measurement position) to improve the surround effect.

■ Type A

Places surround back speakers on the back wall in addition to those speakers in Recommendation ITU-R for 5.1 channel speaker placement.

Drawing of the relocated speaker placement

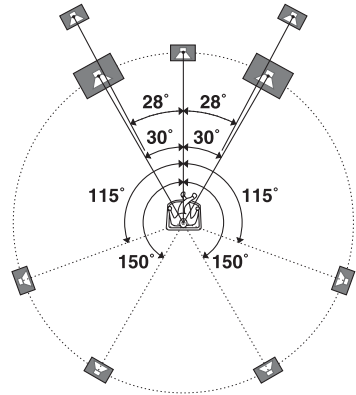

■ Type B

Places four surround speakers at virtually identical angles, according to Recommendation ITU-R for 7.1 channel speaker placement.

Drawing of the relocated speaker placement

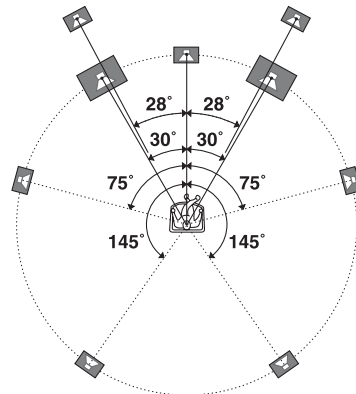

■ Off

Does not relocate speaker positioning.

Note

- This function does not work in the following cases.
 - “MULTI IN” is selected.
 - Headphones are connected.
 - “2ch Analog Direct” is being used.
 - There are no surround back speakers and “Surround Speaker Position” is set to “Front.”
 - There are no surround speakers.

Speaker Setup

Lets you adjust each speaker manually on the Manual Setup screen. You can also adjust the speaker levels after “Auto Calibration” is completed.

Select “Level/Distance/Size,” then press \oplus .

To adjust the speaker level

You can adjust each speaker’s level (center, surround left/right, surround back left/right, front high left/right, subwoofer).

- 1 Select the speaker on the screen for which you want to adjust the level, then press \oplus .
- 2 Select “Level,” then press \oplus .
You can adjust the level from -20 dB to $+10$ dB in 0.5 dB intervals.
You can adjust the front left level from $FL-10.0$ dB to $FL+10.0$ dB in 0.5 dB intervals. You can also adjust the front right level from $FR-10.0$ dB to $FR+10.0$ dB in 0.5 dB intervals.

To adjust the distance from the seating position to each speaker

You can adjust the distance from the seating position to each speaker (front left/right, center, surround left/right, surround back left/right, front high left/right, subwoofer).

- 1 Select the speaker on the screen for which you want to adjust the distance, then press \oplus .
- 2 Select a “Distance,” then press \oplus .

You can adjust the distance from 1.0 meter to 10.0 meters (3 feet 3 inches to 32 feet 9 inches) in 1 cm (1 inch) intervals.

To adjust the size of each speaker

You can adjust each speaker’s (front left/right, center, surround left/right, surround back left/right, front high left/right) size.

- 1 Select the speaker on the screen for which you want to adjust the size, then press \oplus .
- 2 Select a “Size,” then press \oplus .
 - Large
If you connect large speakers that will effectively reproduce bass frequencies, select “Large.” Normally, select “Large.”
 - Small
If the sound is distorted, or you feel a lack of surround effects when using multi-channel surround sound, select “Small” to activate the bass redirection circuitry and output the bass frequencies of each channel from the subwoofer or other “Large” speakers.

Notes

- When headphones are connected, Size and Distance cannot be set.
- The surround back speakers will be set to the same setting as that of the surround speakers.
- When the front speakers are set to “Small,” the center, surround, surround back, and front high speakers are also automatically set to “Small.”
- If you do not use the subwoofer, the front speakers are automatically set to “Large.”

To adjust the crossover frequency of each speaker

Lets you set the bass crossover frequency of speakers that has been set to “Small” in the Size menu. Measured speaker crossover frequency is set for each speaker after “Auto Calibration.”

- 1 Select “Crossover Frequency,” then press \oplus .

continued

- 2 Select the speaker on the screen for which you want to adjust the crossover frequency.
- 3 Set the crossover frequency of the selected speaker.

Notes

- When headphones are connected, this function does not work.
- The surround back speakers will be set to the same setting as that of the surround speakers.

To adjust the level of the rear speakers

You can adjust the level of the rear speakers (surround speakers and surround back speaker(s)) in contrast to the level of the front speakers all at one time.



- 1 Select "All Surround Level," then press .
- 2 Adjust the level of the rear speakers. You can adjust the level from -5 dB to +5 dB in 1 dB intervals.

Test Tone

Lets you select the test tone type on the Test Tone screen.

To output a test tone from each speaker

You can output a test tone from the speakers in sequence.

- 1 Select "Test Tone," then press . The Test Tone screen appears.
- 2 Adjust the parameter, then press .
 - Off
 - Auto

The test tone is output from each speaker in sequence.
 - L, C, R, SR, SL, SB*, SBL, SBR, LH, RH, SW



* "SB" appears when only one surround back speaker is connected.

You can select which speakers will output the test tone.

- 3 Adjust "Level," then press .

To output a test tone from adjacent speakers



You can output a test tone from adjacent speakers so that you can adjust the balance between the speakers.

- 1 Select "Phase Noise," then press . The Phase Noise screen appears.
- 2 Adjust the parameter, then press .
 - Off
 - L/R, L/C, C/R, R/SR, SR/SBR, SR/SB*, SBR/SBL, SR/SL, SB/SL*, SBL/SL, SL/L, LH/RH, L/SR, SL/R, L/RH, LH/R * "SR/SB" and "SB/SL" appear when only one surround back speaker is connected.

Lets you output the test tone sequentially from adjacent speakers.
Some items may not be displayed, depending on the setting of the speaker pattern.
- 3 Adjust "Level," then press .

To output the source sound from adjacent speakers

You can output the source sound from adjacent speakers so that you can adjust the balance between the speakers.

- 1 Select "Phase Audio," then press . The Phase Audio screen appears.
- 2 Adjust the parameter, then press .
 - Off
 - L/R, L/C, C/R, R/SR, SR/SBR, SR/SB*, SBR/SBL, SR/SL, SB/SL*, SBL/SL, SL/L, LH/RH, L/SR, SL/R, L/RH, LH/R * "SR/SB" and "SB/SL" appear when only one surround back speaker is connected.

Lets you output front 2 channel source sound (instead of the test tone) sequentially from adjacent speakers.

Some items may not be displayed, depending on the setting of the speaker pattern.

3 Adjust “Level,” then press .

Center Analog Down Mix

Lets you set the analog downmix settings on or off.

■ Off

If the speaker pattern is set so that there is a center speaker, this setting is set to “Off” automatically.

■ On

We recommend you set “Center Analog Down Mix” to “On” to enjoy digital audio with high quality sound when you do not have a center speaker connected. Analog downmix works when you set “Center Analog Down Mix” to “On.” This setting is also effective to input signals from the MULTI CHANNEL INPUT jacks.

Note

- This function does not work in the following cases.
 - “MULTI IN” is selected.
 - Headphones are connected.
 - There is a center speaker.

Speaker Impedance

Lets you set the speaker impedance. For details, see “9: Setting up the receiver using the Easy Setup” (page 46).

■ 4 Ω

■ 8 Ω

Distance Unit

Lets you select the unit of measurement for setting distances.

■ meter

The distance is displayed in meters.

■ feet

The distance is displayed in feet.

Audio Settings

You can adjust settings for the audio to suit your preference.

Digital Legato Linear (D.L.L.)

The D.L.L. function is Sony proprietary technology that allows low quality digital audio signals and analog audio signals to be played back with high quality sound.

■ Off

■ Auto 1

This function is available for lossy compression audio formats and analog audio signals.

■ Auto 2

This function is available for Linear PCM signals, as well as lossy compression audio formats and analog audio signals.

Notes

- This function may not work, depending on the content via a USB device, or a home network.
- This function works when “A.F.D. Auto” is selected. However, this function does not work in the following cases.
 - Linear PCM signals with a sampling frequency of other than 44.1 kHz are being received.
 - Dolby Digital Plus, Dolby Digital EX, Dolby TrueHD, DTS 96/24, DTS-ES Matrix 6.1, DTS-HD Master Audio, or DTS-HD High Resolution Audio signals are being received.

Sound Optimizer

Lets you set the sound optimizer function (page 66).

■ Off

■ Low

■ Normal

Equalizer

Lets you adjust the bass, middle*, and treble level for each speaker (page 66).
(* for the center speaker only.)

LFE Time Alignment

The LFE Time Alignment function allows you to shift the output timing of the LFE channel by –20ms (delay) to +20ms (forward) for other channels. This function is effective for adjusting content in which the LFE channel phase has a gap from that of other channels.

Note

- This function does not work in the following cases.
 - “MULTI IN” is selected.
 - “2ch Analog Direct” is being used.

Subwoofer Muting

Lets you prevent signals from being output via the PRE OUT SUBWOOFER jacks.

■ Off

The PRE OUT SUBWOOFER jacks output signals.

■ On

The PRE OUT SUBWOOFER jacks do not output signals.

Note

- This function does not work in the following cases.
 - Headphones are connected.
 - “2ch Analog Direct” is selected.
 - “2ch Stereo” is selected.
 - A speaker pattern without a subwoofer is selected.

Dual Mono

Lets you select the language you want when you listen to the dual audio of a digital broadcast when available. This feature only functions for Dolby Digital sources.

■ Main/Sub

Sound of the main language will be output through the front left speaker, and sound of the sub language will be output through the front right speaker simultaneously.

■ Main

Sound of the main language will be output.

■ Sub

Sound of the sub language will be output.

Dynamic Range Compressor

Lets you compress the dynamic range of the soundtrack. This may be useful when you want to watch movies at low volumes late at night. Dynamic range compression is possible with Dolby Digital and Dolby TrueHD sources only.

■ Off

The dynamic range is not compressed.

■ Auto

The dynamic range is compressed automatically when there is a flag in the sound source that recommends the Dynamic Range Compressor.

■ On

The dynamic range is compressed as intended by the recording engineer.

Note

- This function does not work in the following case.
 - “MULTI IN” is selected.

Subwoofer Low Pass Filter

Lets you turn the low-pass filter for the subwoofer output on or off. You can set the function for each input to which an audio input jack is assigned independently. Turn the function on if you connect a subwoofer without the crossover frequency function.

■ Off

Does not activate the low-pass filter.

■ On

Always activates the low-pass filter with a cutoff frequency of 120 Hz.

Note

- This function does not work in the following cases.
 - “MULTI IN” is selected.
 - “2ch Analog Direct” is being used.

A/V Sync (Synchronizes audio and video output)

Lets you delay the output of audio to minimize the time gap between audio output and visual display.

This function is useful when you use a large LCD or plasma monitor or a projector. You can set the function for each input independently.

■ HDMI Auto

The time gap between audio output and visual display for the monitor connected via an HDMI connection will be adjusted automatically based on the information for the TV. This feature is available only when the monitor supports the A/V Sync function.

■ 0 ms – 1200 ms

You can adjust the delay from 0 ms to 1200 ms* in 10 ms intervals.

- * The maximum delay may be limited to the lower value, depending on the audio stream.

Note

- This function does not work in the following case.
 - “MULTI IN” is selected.

Decode Priority (Digital audio input decoding priority)

Lets you specify the input mode for the digital signal input to the DIGITAL IN jacks or HDMI IN jacks.

You can set the function for each input independently.

■ PCM

When signals from the DIGITAL IN jack are selected, PCM signals are given priority (to prevent interruption when playback starts). However, when other signals are input, there may be no sound, depending on the format. In this case, set this item to “Auto.”

When signals from the HDMI IN jack are selected, only PCM signals are output from the connected player. When signals in any other format are received, set this item to “Auto.”

■ Auto

Automatically switches the input mode between Dolby Digital, DTS, or PCM.

Notes

- This function does not work in the following cases.
 - “MULTI IN” is selected.
 - Analog input mode is selected.
 - “2ch Analog Direct” is being used.
- Even when “Decode Priority” is set to “PCM,” the start of the sound may not be output due to signals on the CD being played back.

Sound Field

Lets you select a sound effect applied to input signals. For details, see “Enjoying Sound Effects” (page 61).

You can set the function for each input independently.

Video Settings

You can adjust settings for video.

Resolution (Converting video signals)

Lets you convert the resolution of analog video input signals and output the converted signals.

■ Direct

Lets you output analog video input signals directly.

■ 480p/576p

■ 720p

■ Auto

■ 1080i

■ 480i/576i

■ 1080p

When an HDMI monitor is being connected with HDMI OUT ON

"Resolution" menu setting	Output from		HDMI OUT jacks	MONITOR COMPONENT VIDEO OUT jacks	MONITOR VIDEO OUT jack
	Input from				
Direct, Auto	HDMI IN jacks		●	–	–
	COMPONENT VIDEO IN jacks		○ ^{a)}	●	–
	VIDEO IN jacks		○ ^{a)}	–	●
480i/576i, 480p/576p, 720p, 1080i, 1080p	HDMI IN jacks		●	–	–
	COMPONENT VIDEO IN jacks		○ ^{b)}	●	–
	VIDEO IN jacks		○ ^{b)}	–	●

When an HDMI monitor is not connected with HDMI OUT OFF

"Resolution" menu setting	Output from		HDMI OUT jacks	MONITOR COMPONENT VIDEO OUT jacks	MONITOR VIDEO OUT jack
	Input from				
Direct	HDMI IN jacks		–	–	–
	COMPONENT VIDEO IN jacks		–	●	–
	VIDEO IN jacks		–	–	●
Auto	HDMI IN jacks		–	–	–
	COMPONENT VIDEO IN jacks		–	480i/576i	○
	VIDEO IN jacks		–	480i/576i	●

continued

“Resolution” menu setting	Output from	HDMI OUT jacks	MONITOR COMPONENT VIDEO OUT jacks	MONITOR VIDEO OUT jack
	Input from			
480i/576i, 480p/ 576p	HDMI IN jacks	–	–	–
	COMPONENT VIDEO IN jacks	–	○ ^{b)}	○
	VIDEO IN jacks	–	○ ^{b)}	●
720p, 1080i	HDMI IN jacks	–	–	–
	COMPONENT VIDEO IN jacks	–	○ ^{c)}	–
	VIDEO IN jacks	–	○ ^{c)}	●
1080p	HDMI IN jacks	–	–	–
	COMPONENT VIDEO IN jacks	–	●	–
	VIDEO IN jacks	–	–	●

● : Video signals are output without a video conversion or processing.

○ : Video signals are output. (Values for the resolution are shown when video signals are output at the specified resolution.)

○^{a)}: Video signals are converted automatically to an optimum resolution that the monitor connected supports, and then they are output.

○^{b)}: Video signals are output at the resolution specified in the “Resolution” menu.

○^{c)}: Video signals are output at the resolution specified in the “Resolution” menu. Video signals protected by Macrovision are output at the 480p/576p resolution.

– : Video signals are not output.

Notes

- If you select a resolution which the connected TV does not support in the “Resolution” menu, the images from the TV cannot be output correctly.
- Converted HDMI image output does not support “x.v.Color,” Deep Color, and 3D.

Zone Resolution

Lets you convert the resolution of analog video input signal in zone 2.

■ **Direct**

■ **720p**

■ **480i/576i**

■ **1080i**

■ **480p/576p**

“Zone Resolution” menu setting	Output from		HDMI OUT jacks	ZONE 2 COMPONENT VIDEO OUT jacks	ZONE 2 VIDEO OUT jack
	Input from				
DIRECT	HDMI IN jacks		●	–	–
	COMPONENT VIDEO IN jacks		–	●	–
	VIDEO IN jacks		–	–	●
480i/576i (factory default setting)	HDMI IN jacks		●	–	–
	COMPONENT VIDEO IN jacks		–	○	○
	VIDEO IN jacks		–	○	●
480p/576p	HDMI IN jacks		●	–	–
	COMPONENT VIDEO IN jacks		–	○	–
	VIDEO IN jacks		–	○	–
720p, 1080i	HDMI IN jacks		●	–	–
	COMPONENT VIDEO IN jacks		–	○*	–
	VIDEO IN jacks		–	○*	–

○ : Video signals are output at the resolution specified in the “Resolution” menu.

● : Video signals are output without a video conversion or processing.

– : Video signals are not output.

* When the content is protected by Macrovision, video signals may be output at the 480p/576p resolution.

Playback Resolution

This function targets content via a USB device, a home network, and Internet content.

■ 480i/576i

■ 1080i

■ 480p/576p

■ 1080p

■ 720p

Output video resolution “Playback Resolution” menu setting	HDMI OUT jacks	MONITOR COMPONENT VIDEO OUT jacks	MONITOR VIDEO OUT jack	ZONE 2 COMPONENT VIDEO OUT jacks	ZONE 2 VIDEO OUT jack
480i/576i	480i/576i	480i/576i*	480i/576i*	480i/576i*	480i/576i*
480p/576p	480p/576p	480p/576p*	480i/576i*	480p/576p*	480i/576i*
720p (factory default setting)	720p	720p*	–	720p*	–
1080i	1080i	1080i*	–	1080i*	–
1080p	1080p	1080i*	–	1080i*	–

* If you play back content that is protected by Macrovision, the receiver may output the image at low resolution, or a warning message which informs that the video signals cannot be output may appear.

Notes

- If the warning message “Video cannot be output from this jack.” appears, perform the following procedure.
 - ① Select “BD” as the input for the main zone.
 - ② Set “Playback Resolution” to “480i/576i” or “480p/576p.”
- If no picture is output when you play back content via a USB device, a home network, or Internet content from the Watch/Listen menu, perform the following procedure.
 - ① Select “BD” as the input for the main zone.
 - ② Set “Playback Resolution” to a lower resolution.

3D Output Settings

This function targets content via a USB device and a home network.

■ Auto

Select this to display 3D compatible content in 3D.

■ Off

Select this to display all content in 2D.

TV Type

This function targets content via a USB device, a home network, and Internet content.

■ 16:9

Select this when connecting to a wide-screen TV or a TV with a wide-mode function.

■ 4:3

Select this when connecting to a 4:3 screen TV without a wide-mode function.

Screen Format

This function targets content via a USB device, a home network, and Internet content.

■ Original

Select this when connecting to a TV with a wide-mode function. Displays a 4:3 screen picture in 16:9 aspect ratio even on a wide-screen TV.

■ Fixed Aspect Ratio

Changes the picture size to fit the screen size with the original picture aspect ratio.

HDMI Settings

You can adjust the required settings for equipment connected to the HDMI jacks.

Subwoofer Level

Lets you set the level of the subwoofer to 0 dB or +10 dB when PCM signals are input via an HDMI connection. You can set the level for each input to which an HDMI input jack is assigned independently.

■ 0 dB

■ Auto

Automatically sets the level to 0 dB or +10 dB, depending on the audio stream.

■ +10 dB

Audio Out

Lets you set the HDMI audio signals output from the playback equipment connected to the receiver via an HDMI connection.

■ TV+AMP

The sound is output from the TV speaker and the speakers connected to the receiver.

Notes

- The sound quality of the playback equipment depends on the TV's sound quality, such as the number of channels, and the sampling frequency, etc. If the TV has stereo speakers, the sound output from the receiver is also in stereo as that of the TV, even if you play multi-channel source.
- When you connect the receiver to a video device (projector, etc.), sound may not be output from the receiver. In this case, select "AMP."
- When you do not select an HDMI input jack as an audio input in "Audio Input Assign" in the Input Settings menu, sound is not output from the TV.

■ AMP

The HDMI audio signals from the playback equipment is only output to speakers connected to the receiver. The multi-channel sound can be played back as it is.

Note

When “Control for HDMI” is set to “On,” “Audio Out” may be changed automatically.

H.A.T.S.

Lets you turn the H.A.T.S. (High quality digital Audio Transmission System) function on or off. When the H.A.T.S. function is turned on, the sound quality is enhanced because there is no jitter (timing gaps when reading signals) when transmitting digital audio signals.

■ Off

■ On

Notes

- It takes some time to output the sound after a playback operation is performed on the connected equipment (e.g., pressing the PLAY button, pressing the STOP button, pressing the PAUSE button) due to limitations of the H.A.T.S. system. The time lag depends on the sound source.
- The H.A.T.S. function of this receiver works when a Sony SCD-XA5400ES is connected to the receiver.
- While the H.A.T.S. function is working, sound is not output from the front high speakers.
- The H.A.T.S. function works only when “A.F.D. Auto,” “2ch Stereo,” or “Headphone (2ch)” is selected.

Stream information about the H.A.T.S. function available

Audio signal input	Sampling frequency
Linear PCM 2ch	44.1 kHz, 48 kHz, 88.2 kHz, 96 kHz, 176.4 kHz, 192 kHz
Linear PCM Multi	44.1 kHz, 48 kHz, 88.2 kHz, 96 kHz, 176.4 kHz, 192 kHz
DSD	2.8224 MHz

Control for HDMI

Lets you turn the function which controls equipment connected to the HDMI jack using an HDMI cable on or off.

■ Off

■ On

Note

This function is enabled only when “Zone2 Out” is set to “Off.”

Pass Through

Lets you output HDMI signals to the TV even when the receiver is in standby mode. For details, see “Outputting the HDMI signals even when the receiver is in standby mode (Pass Through)” (page 86).

■ Off

■ On

■ Auto

Zone2 Out

Lets you enable or disable the HDMI ZONE 2 OUT jacks.

■ Off

■ On

Priority

Lets you set the priority when you select the same input for both the main zone and zone 2.

■ Main & Zone 2

You can enjoy the same input in the main zone and zone 2. However, there may be some interference in the audio and video signals in the main zone and zone 2.

■ Main Only

You can enjoy good audio and video quality in the main zone. There is no output in zone 2.

Note

This function is enabled only when “Zone2 Out” is set to “On.”

Fast View (Fast HDMI Switching)

Lets you set the operation of Fast View. HDMI IN 1, IN 2, IN 3, IN 4, and IN 9 support the Fast View function.

■ Auto

You can select HDMI Input faster than with the normal selection.

■ Off

This function and the Preview for HDMI function are not available.

Note

This function is enabled only when “Zone2 Out” is set to “Off.”

Input Settings

You can adjust the settings for the connections of the receiver and other equipment.

Input Edit

Lets you set the following items for each input.

■ Watch/Listen

Sets whether an input is displayed on the Watch menu or the Listen menu.

- Watch: Displays an input to the Watch menu.
- Listen: Displays an input to the Listen menu.
- Watch/Listen: Displays an input to both the Watch and Listen menus.
- Hidden: Does not display an input to both the Watch and Listen menus. When you select an input, you can skip an input which is set to “Hidden.”

■ Icon

Sets the icon displayed on the Watch/Listen menu.

■ Name

Sets the name displayed on the Watch/Listen menu.

Note

You cannot select an input which is set to “Hidden,” or “HIDDEN” in “INPUT SKIP ?” in “INPUT SETTINGS” (page 125) without using the GUI, even if you use INPUT SELECTOR on the receiver.

Audio Input Assign

Lets you set the audio input jack(s) assigned to each input.

For details, see “Using other video/audio input jacks” (page 88).

■ HDMI

HDMI IN 1/2/3/4/5/6/7/8/9, None

■ Digital

OPT IN 1/2/3, COAX IN 1/2/3, None

■ Analog

Factory default setting

Video Input Assign

Lets you set the video input jack(s) assigned to each input.

For details, see “Using other video/audio input jacks” (page 88).

■ HDMI

HDMI IN 1/2/3/4/5/6/7/8/9, None

■ Component

COMPONENT IN 1/2, None

■ Analog

Factory default setting

Network Settings

You can adjust the settings for the network.

Internet Settings

Lets you check or change the network settings. You can change the settings for the following items either manually or automatically.

- IP Address
- DNS
- Proxy Server

Connect the receiver to the network beforehand. For details, see “7: Connecting to the network” (page 44).

LAN Port Activation

Lets you set whether or not to activate each LAN port on the rear panel.

Among the four LAN ports on the rear panel, check the ports that you want to activate. The receiver will use the activated ports to access a network.

By disabling unused ports, you can save power consumption. The ports not connected to a router or a hub will be grayed out.

Connection Server Settings

Lets you set whether or not to display the connected DLNA server.

Renderer Options

■ Renderer Name

Shows the renderer name of the receiver.

■ Auto Access Permission

Sets whether or not to allow automatic access from newly detected DLNA controller.

Renderer Access Control

Lets you set whether or not to accept commands from DLNA controllers.

External Control

Lets you turn the function which controls the receiver from “ES Remote” on the home network on or off.

■ Off

■ On

Network Standby

Lets you turn on or off the function that activates the switching hubs on the rear of the receiver and allows a network controller, “ES Remote,” etc., to control the receiver even when it is in standby mode. In the network standby mode, the start-up time of the GUI and the network function will be reduced after the receiver is turned on.

■ Off

The Network Standby mode is disabled and the receiver enters the normal standby mode when it is in standby mode.

■ On

The Network Standby mode is enabled and the receiver enters the Network Standby mode when it is in standby mode.

Home Control Settings

You can make settings for Universal Remote Control and Lighting Control features.

TV Control

Lets you set up a connection between a display device and the receiver via an IR blaster, so that the remote control of the receiver can operate the device. You can also carry out a connection test.

AV Equipment Control

Lets you set up a connection between a player and the receiver via an IR blaster, and a BD, DVD, SAT, or another type of AV equipment so that the remote control of the receiver can operate the device. You can also carry out a connection test.

Lighting Control

Lets you set up a Control4-compatible lighting device via the Lighting Control Adapter (UWA-C4Z) so that you can operate the lighting device with the receiver.

Lighting Scenes

Lets you set up lighting scene control. Initially, there are 10 preset lighting scenes. You can edit and overwrite a preset scene to make a new scene. You can set the level of a dimmer of a lighting device for each scene or turn the lighting on or off.

Registration

For assistance, please access <http://www.sony.com/essupport>.

To find a local Control4 dealer and upgrade your receiver to full Control4 Automation, go to <http://www.control4.com/sony>.



Zone Settings

You can adjust settings for the main zone, zone 2 or zone 3.

Zone Control



To turn the power on or off for zone 2/zone 3

You can turn zone 2 or zone 3 operation on or off.

- 1 Select the zone you want to turn on or off, then press .
- 2 Select "On" or "Off," then press .
 - On
 - Off

To select the output source for each zone



You can select the source that is output to the zone. Audio and video signals are output to zone 2, while only audio signals are output to zone 3.

- 1 Select the zone to which you want to output video/audio signals, then press .
- 2 Select "Input," then press .
- 3 Select the input, then press .

To adjust the volume for zone 2

If the SURROUND BACK (ZONE 2) terminals are used with a zone 2 connection, you can also adjust the volume of zone 2. If you set "Line Out" to "Variable," you can also adjust the volume using "Zone Control." If you want to adjust the volume of zone 2 in zone 2 using the remote control, see "Operating the receiver from another zone (ZONE 2/ZONE 3 operations)" (page 81).



- 1 Select the zone for which you want to adjust the volume, then press .

- 2 Select "Volume," then press .
- 3 Adjust the volume, then press .

Zone Setup

To preset the volume for main zone/zone 2

You can preset the volume of turning the power on for each zone.

- 1 Select the zone for which you want to preset the volume, then press .
- 2 Select "Preset Volume," then press .
- 3 Adjust the volume, then press .

During the adjustment, the sound is output at the volume level to which you have adjusted it, regardless of the value of MASTER VOLUME control.

If you select "Off," each zone is activated at the same volume as that in effect when you turned the power off last time.

Note

- You cannot preset the volume in the following cases.
 - The SURROUND BACK (ZONE 2) terminals are used for the surround back speakers or the front high speakers, or are used with a bi-amplifier connection.
 - "Line Out" is set to "Fixed."

Line Out

You can set the volume control for the ZONE 2 AUDIO OUT jacks to "Variable" or "Fixed." For details, see "Set the volume control for zone 2" (page 79)

■ Fixed

■ Variable

12V Trigger

Lets you select various options for use of the 12V Trigger function.

■ Off

Lets you turn off output of 12V triggers even when the main receiver is turned on.

■ Ctrl

Lets you turn the output of 12V triggers on or off manually using the control command of an external control device.

■ Zone

Lets you turn the output of 12V triggers on or off based on whether the selected zone is turned on or off.

■ Input (for “Main” only)

Lets you turn on the output of 12V triggers when the preset input is selected. When you select “Input,” the setting display which sets each input trigger to on/off appears. Press $\blacktriangle/\blacktriangledown$ to select the input, then press \oplus to check the box.

■ HDMI A (for “Main” only)

Lets you turn the output of 12V triggers on or off based on the output setting of the HDMI OUT A jack.

■ HDMI B (for “Main” only)

Lets you turn the output of 12V triggers on or off based on the output setting of the HDMI OUT B jack.

■ Main (for “Zone2” and “Zone3” only)

Lets you link operation of trigger in zone 2 or zone 3 to the TRIGGER OUT MAIN jack.

System Settings

You can customize the settings of the receiver.

Language

Lets you select the language for the messages on the screen.

■ English**■ Español****■ Français****■ Deutsch**

Auto Standby

Lets you turn the function that switches the main zone to standby mode automatically if you do not operate the receiver for a specific period of time or when there is no signal input to the receiver on or off.

■ Off

Does not switch to standby mode.

■ On

Switches to standby mode after approximately 30 minutes.

Note

- This function does not work in the following cases.
 - When you play back via a USB device, an iPod/iPhone, a home network, or Internet content.
 - When the receiver is in the sleep mode.

Settings Lock

Lets you lock the settings of the receiver.

■ On

You can only turn this function on using the setting menu. When you turn this function off, perform the following procedure.

continued

SPEAKERS (A/B/A+B/OFF)

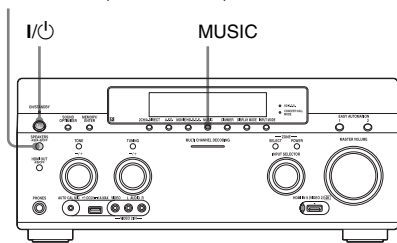

- 1 Press I/ON to turn off the receiver.**
- 2 While holding down MUSIC and SPEAKERS (A/B/A+B/OFF), press I/ON to turn on the receiver.**

RS232C Control

Let you turn the control mode for maintenance and service on or off.

- Off
- On

Software Update Notification

Lets you set whether or not to inform you of newer software version information on the TV screen.

- On
- Off

To update the receiver

See “Network Update” (page 120) to update the software of the receiver.

Note

- New software version information does not appear in the following cases.
 - The latest version is already being used.
 - The receiver cannot obtain data via a network.

Initialize Personal Information

Lets you erase personal information related to Internet, such as the Internet content list, “Favorites List,” etc.

System Information

Displays the software version of the receiver.

EULA

Displays the EULA screen on the TV screen.

Software License

Displays the Software License information on the TV screen.

Network Update

You can update and improve the functions of the receiver.

For information about update functions, refer to the following web site:
<http://www.sony.com/essupport>

The GUI and display window of the receiver are turned off, and the lamp above the I/ON ON/STANDBY button flashes in green during the update.

When the update is completed, the receiver will restart automatically.

It may take about 50 minutes for the update to complete. The time required for the update to complete varies, depending on the speed of the Internet connection.

Note

Do not turn the receiver off or disconnect the network cable during software updating. It may cause a malfunction.

Operating without using the GUI

You can operate the receiver using the display window of the receiver even if the TV is not connected to the receiver.

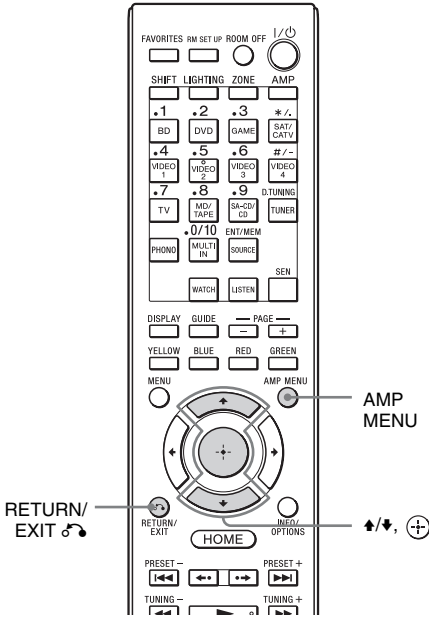

3 Press \uparrow/\downarrow repeatedly to select the menu, then press \oplus .

4 Press \uparrow/\downarrow repeatedly to select the menu item, then press \oplus .
The parameter appears in brackets.



5 Press \uparrow/\downarrow repeatedly to select the parameter you want, then press \oplus .

The parameter is entered and the brackets disappear from the display.



To return to the previous step

Press RETURN/EXIT \leftarrow .

Using the menu in the display window

1 Turn on the receiver.

2 Press AMP MENU.

The menu is displayed in the display window of the receiver.

Example: When you select "SPEAKER SETTINGS:"



Menu list (in the display window)

The following options are available in each menu.

“■■■■...” in the table signifies the parameter for each item.

Menu	Item	Parameter
AUTO CALIBRATION	AUTO CAL START ?	
	5 4 3 2 1	
	MEASURING: TONE	
	MEASURING: T.S.P.	
	MEASURING: WOOFER	
	COMPLETE [■■■■■■■■■■■■■■■■]	RETRY, SAVE EXIT, WRN CHECK, PHASE INFO, DIST. INFO, LEVEL INFO, EXIT
	CAL MATCHING? [■■■■]	YES, NO
	WARNING CODE [■■■■:4■]	FL, FR, C, SL, SR, SBR, SBL, SW, LH, RH : 0, 1, 2, 3, 4
	NO WARNING	
	PHASE.INFO [■■■■:■■■■]	FL, FR, C, SL, SR, SBR, SBL, SW, LH, RH :OUT, IN
	DIST.INFO [■■■■■■■■■■■■■■■■]	FL, FR, C, SL, SR, SBR, SBL, SW, LH, RH
	LEV.INFO [■■■■:■■■■■■■■■■]dB	FL, FR, C, SL, SR, SBR, SBL, SW, LH, RH
	ERROR CODE [■■■■:3■]	F, SR, SB : 0, 1, 2, 3, 4
	RETRY? [■■■■■■]	YES, EXIT
	CANCEL	
	CAL TYPE [■■■■■■■■■■■■■■■■]	FULL FLAT, ENGINEER, FRONT REF, USER REF, OFF
	A.P.M. [■■■■■■]	AUTO, OFF
	FRONT REF TYPE [■■■■]	L/R, L, R
	SP PAIR MATCH [■■■■]	ALL, SUR, OFF
POSITION [■■■■■■■■■■■■■■■■]	POS.1, POS.2, POS.3	
NAME IN ? [■■■■■■■■■■■■■■■■]		

Menu	Item	Parameter
LEVEL SETTINGS	TEST TONE [■■■■■■■■■■]	OFF, L to RH (AUTO), L to RH (FIX)
	PHASE NOISE [■■■■■■■■■■]	OFF, L/R, L/C, C/R, R/SR, SR/SBR, SR/SB, SBR/SBL, SR/SL, SB/SL, SBL/SL, SL/L, LH/RH, L/SR, SL/R, L/RH, LH/R
	PHASE AUDIO [■■■■■■■■■■]	OFF, L/R, L/C, C/R, R/SR, SR/SBR, SR/SB, SBR/SBL, SR/SL, SB/SL, SBL/SL, SL/L, LH/RH, L/SR, SL/R, L/RH, LH/R
	FRONT L [■■■■.■dB]	-10.0 dB to +10.0 dB (0.5 dB interval)
	FRONT R [■■■■.■dB]	-10.0 dB to +10.0 dB (0.5 dB interval)
	CENTER [■■■■.■dB]	-20.0 dB to +10.0 dB (0.5 dB interval)
	SURROUND L [■■■■.■dB]	-20.0 dB to +10.0 dB (0.5 dB interval)
	SURROUND R [■■■■.■dB]	-20.0 dB to +10.0 dB (0.5 dB interval)
	SUR BACK [■■■■.■dB]	-20.0 dB to +10.0 dB (0.5 dB interval)
	SUR BACK L [■■■■.■dB]	-20.0 dB to +10.0 dB (0.5 dB interval)
	SUR BACK R [■■■■.■dB]	-20.0 dB to +10.0 dB (0.5 dB interval)
	LEFT HIGH [■■■■.■dB]	-20.0 dB to +10.0 dB (0.5 dB interval)
	RIGHT HIGH [■■■■.■dB]	-20.0 dB to +10.0 dB (0.5 dB interval)
	SUBWOOFER [■■■■.■dB]	-20.0 dB to +10.0 dB (0.5 dB interval)
	ALL SUR LEVEL [■■■■.■dB]	-5 dB to +5 dB (1 dB interval)

Menu	Item	Parameter
SPEAKER SETTINGS	SP PATTERN [■■■■■]	5/4.1 to 2/0 (28 patterns)
	VIRTUAL FH [■■■]	ON, OFF
	CENTER LIFT UP [■■■]	OFF, 1 to 10
	SUR POSITION [■■■■■]	BACK, FRONT
	SP RELOCATION [■■■■■]	TypeA, TypeB, OFF
	FRONT SIZE [■■■■■]	LARGE, SMALL
	CENTER SIZE [■■■■■]	LARGE, SMALL
	SURROUND SIZE [■■■■■]	LARGE, SMALL
	FH SIZE [■■■■■]	LARGE, SMALL
	SB ASSIGN [■■■■■]	OFF, BI-AMP, ZONE2
	FRONT L [■■■■■■■■■]	
	FRONT R [■■■■■■■■■]	
	CENTER [■■■■■■■■■]	
	SURROUND L [■■■■■■■■■]	
	SURROUND R [■■■■■■■■■]	
	SUR BACK [■■■■■■■■■]	1.0 to 10.0 (m) (1 cm interval) 3' 3" to 32' 9" (1 inch interval)
	SUR BACK L [■■■■■■■■■]	
	SUR BACK R [■■■■■■■■■]	
	LEFT HIGH [■■■■■■■■■]	
	RIGHT HIGH [■■■■■■■■■]	
	SUBWOOFER [■■■■■■■■■]	
	DISTANCE UNIT [■■■■■]	meter, feet
	FR CROSSOVER [■■■Hz]	40 to 200 (10 Hz interval)
	CNT CROSSOVER [■■■Hz]	40 to 200 (10 Hz interval)
	SUR CROSSOVER [■■■Hz]	40 to 200 (10 Hz interval)
	FH CROSSOVER [■■■Hz]	40 to 200 (10 Hz interval)
CNT A.DOWN MIX [■■■]	OFF, ON	
SP IMPEDANCE [■ohm]	8 ohm, 4 ohm	

Menu	Item	Parameter
INPUT SETTINGS	NAME IN ? [■■■■■■■■■■]	
	INPUT SKIP ?	
	■■■■■■■■■■ [■■■■■■■■]	SHOWN, HIDDEN
	HDMI AUDIO ASSIGN ?	
	■■■■■■■■■■ [■■■■■■■■■■■■■■■■■■■■]	
	HDMI VIDEO ASSIGN ?	
	■■■■■■■■■■ [■■■■■■■■■■■■■■■■■■■■]	
DIGITAL A.ASSIGN ?		
■■■■■■■■■■ [■■■■■■■■■■■■■■■■■■■■]		
COMPONENT V.ASSIGN ?		
■■■■■■■■■■ [■■■■■■■■■■■■■■■■■■■■]		
SUR SETTINGS	HD-DCS TYPE [■■■■■■■■■■]	DYNAMIC, THEATER, STUDIO
	EFFECT LEVEL [■■■■■■]	HIGH, MID, LOW
	HEIGHT GAIN [■■■■■■]	HIGH, MID, LOW
EQ SETTINGS	ALL BASS [■■■■.■dB]	-10 dB to +10 dB (0.5 dB interval)
	ALL TREB [■■■■.■dB]	-10 dB to +10 dB (0.5 dB interval)
	FRONT BASS [■■■■.■dB]	-10 dB to +10 dB (0.5 dB interval)
	FRONT TREB [■■■■.■dB]	-10 dB to +10 dB (0.5 dB interval)
	CENTER BASS [■■■■.■dB]	-10 dB to +10 dB (0.5 dB interval)
	CENTER MID [■■■■.■dB]	-10 dB to +10 dB (0.5 dB interval)
	CENTER TREB [■■■■.■dB]	-10 dB to +10 dB (0.5 dB interval)
	SUR/SB BASS [■■■■.■dB]	-10 dB to +10 dB (0.5 dB interval)
	SUR/SB TREB [■■■■.■dB]	-10 dB to +10 dB (0.5 dB interval)
	FH BASS [■■■■.■dB]	-10 dB to +10 dB (0.5 dB interval)
FH TREB [■■■■.■dB]	-10 dB to +10 dB (0.5 dB interval)	
MULTIZONE SETTINGS	P.VOL. MAIN [■■■■.■dB]	OFF, -∞, -92.0 dB to +23.0 dB (0.5 dB interval)
	P.VOL. ZONE2 [■■■■dB]	OFF, -∞, -92 dB to +23 dB (1 dB interval)
	Z2 LINEOUT [■■■■■■■■■■]	FIXED, VARIABLE
	12V TRIG. MAIN [■■■■■■■]	OFF, CTRL, ZONE, INPUT, HDMIA, HDMIB
	12V TRIG. ZONE2 [■■■■■■■]	OFF, CTRL, ZONE, MAIN
	12V TRIG. ZONE3 [■■■■■■■]	OFF, CTRL, ZONE, MAIN
TUNER SETTINGS	FM MODE [■■■■■■■■■]	STEREO, MONO
	FM■■■	
	NAME IN ? [■■■■■■■■■■]	
	AM■■■	
	NAME IN ? [■■■■■■■■■■]	

continued

Menu	Item	Parameter
AUDIO SETTINGS	D.L.L. [■■■■■]	AUTO2, AUTO1, OFF
	S.OPTIMIZER [■■■■■■■]	NORMAL, LOW, OFF
	LFE TIME [■■■■■ms]	-20.0 ms to +20.0 ms (0.5 ms Interval)
	S.WOOFER LPF [■■■■]	ON, OFF
	S.WOOFER MUTING [■■■■]	ON, OFF
	A/V SYNC [■■■■■■■■■■]	HDMI AUTO, 0 ms to 1200 ms (10 ms interval)
	DUAL MONO [■■■■■■■■■■]	MAIN/SUB, MAIN, SUB
	DEC. PRIORITY [■■■■■]	AUTO, PCM
VIDEO SETTINGS	D. RANGE COMP. [■■■■■]	ON, AUTO, OFF
	RESOLUTION [■■■■■■■■■■]	DIRECT, AUTO, 480/576i, 480/576p, 720p, 1080i, 1080p
HDMI SETTINGS	ZONE RESO. [■■■■■■■■■■]	DIRECT, 480/576i, 480/576p, 720p, 1080i
	CTRL FOR HDMI [■■■■]	ON, OFF
	PASS THROUGH [■■■■■]	ON, AUTO, OFF
	H.A.T.S. [■■■■]	ON, OFF
	ZONE2 OUT [■■■■]	ON, OFF
	PRIORITY [■■■■■■■■■■■■■■]	MAIN&ZONE2, MAIN ONLY
	AUDIO OUT [■■■■■■■■]	AMP, TV+AMP
	SW LEVEL [■■■■■]	AUTO, +10 dB, 0 dB
SYSTEM SETTINGS	FAST VIEW [■■■■■]	AUTO, OFF
	RS232C CONTROL [■■■■]	ON, OFF
	NETWORK STANDBY [■■■■]	ON, OFF
	AUTO STANDBY [■■■■]	ON, OFF
	VERSION [■■■■■]	-

To change the display

The display panel provides various information of the receiver status such as sound field.

- 1 Select the input for which you want to check the information.
- 2 Press DISPLAY MODE on the receiver repeatedly.

Each time you press DISPLAY MODE, the display will change as follows.

Input you selected → Sound field type → Stream information* → Input name you entered ...

* Stream information may not be displayed.

When listening to FM and AM radio

Station name → Frequency → Sound field type ...

Index name appears only when you have assigned one to the input or preset station.

Index name does not appear when only blank spaces have been entered.

Precautions

On safety

Should any solid object or liquid fall into the cabinet, unplug the receiver and have it checked by qualified personnel before operating it any further.

On power sources

- Before operating the receiver, check that the operating voltage is identical with your local power supply.
The operating voltage is indicated on the nameplate on the back of the receiver.
- If you are not going to use the receiver for a long time, be sure to disconnect the receiver from the wall outlet. To disconnect the AC power cord (mains lead), grasp the plug itself; never pull the cord.
- One blade of the plug is wider than the other for the purpose of safety and will fit into the wall outlet only one way. If you are unable to insert the plug fully into the outlet, contact your dealer.
- AC power cord (mains lead) must be changed only at a qualified service shop.

On heat buildup

Although the receiver heats up during operation, this is not a malfunction. If you continuously use this receiver at a large volume, the cabinet temperature of the top, side and bottom rises considerably*. To avoid burning yourself, do not touch the cabinet.

* The top of the cabinet may become too hot to touch.

On placement

- Place the receiver in a location with adequate ventilation to prevent heat buildup and prolong the life of the receiver.

- Do not place the receiver near heat sources, or in a place subject to direct sunlight, excessive dust, or mechanical shock.
- Do not place anything on top of the cabinet that might block the ventilation holes and cause malfunctions.

On cleaning

Clean the cabinet, panel, and controls with soft dry cloth. Do not use any type of abrasive pad, scouring powder, or solvent, such as alcohol or benzene.

If you have any questions or problems concerning your receiver, please consult your nearest Sony dealer.

Troubleshooting

If you experience any of the following difficulties while using the receiver, use this troubleshooting guide to help you remedy the problem. Should any problem persist, consult your nearest Sony dealer.

General

The receiver is turned off automatically.

- “Auto Standby” is set to “On” (page 119).
- The sleep timer function is working (page 92).
- “PROTECTOR” is working (page 139).

The receiver is turned on automatically.

- “Control for HDMI” is set to “On” or “Pass Through” is set to “Off.” In this case, the receiver may be turned on by operating other equipment connected to it.

No picture and no sound are output, or the picture and sound are corrupted.

- The receiver is placed near equipment such as a television, VCR, or tape deck. If the receiver is being used in combination with a television, VCR, or tape deck, and is placed too close to that equipment, noise may result, and picture quality may suffer. This is especially likely when using an indoor antenna (aerial). Therefore, we recommend using an outdoor antenna (aerial).

The top of the receiver is hot.

- Phenomenon is specific to this amplifier. This is not a malfunction. If “Control for HDMI” or “Network Standby” is set to “On,” or “Pass Through” is set to “On,” or “Auto,” the power for zone 2 or zone 3 is turned on, the top of the receiver may become hot even while the receiver is in standby mode. This condition occurs

because current is flowing in the internal circuits of the receiver, and this is normal.

Video

There is no picture or an unclear picture appears on the TV screen or monitor, regardless of type of picture.

- Select the appropriate input on the receiver (page 51).
- Set your TV to the appropriate input mode.
- Move your TV away from the audio equipment.
- Assign the component video input correctly (page 88).
- The input signal should be same as input when you are up-converting an input signal with this receiver (page 21).
- Make sure that cables are correctly and securely connected to equipment.
- Depending on the playback equipment, equipment may need to be set up. Refer to the operating instructions supplied with the equipment.

Images appear later than the associated sound is played.

- Depending on the equipment connected to the HDMI jack, or the source played back, images may appear later than the associated sound. In this case, change the setting of “A/V Sync” in the Audio Settings menu (page 107).

Recording cannot be carried out.

- Check that the equipment is connected correctly (page 30).
- Select the source equipment (page 51).
- Check the connection of the recording deck according to the video signals you want to record. Analog input signals (composite video) can be output only from the analog output jacks.
- Video input signals via the HDMI IN jacks cannot be recorded.

continued

129^{US}

- Copyright protection to prevent recording is contained in the sources. In this case, you may not be able to record from the sources.
- Set “Auto Standby” to “Off” (page 119). While only composite video signals are being recorded, the auto standby function of the receiver may start up and interrupt the recording.
- When the Zone2 Out function is enabled and you select the same HDMI input for both the main zone and zone 2, there may be some interference on the audio and video signals in the main zone and zone 2. To avoid possible interference in the main zone, you can place priority on the main zone for HDMI input selection (page 80).
- Be sure to use a connecting cable for the HDMI jack corresponding to a High Speed HDMI cable when you want to view images or listen to sound, especially for 1080p, Deep Color, or 3D or 4K transmissions.

Specific type of image is not output or corrupted.

Component video output

- The resolution of output signals from the COMPONENT VIDEO OUT jacks may not be supported by your TV. In this case, select the appropriate resolution on the receiver (page 109).
- COMPONENT VIDEO MONITOR OUT jacks have restrictions on resolution when the resolution of video signals protected by copyright technology is converted. The resolution of the signals output to the COMPONENT VIDEO MONITOR OUT jacks is converted up to 480p/576p.

HDMI output

- The output of the HDMI video signals of the receiver may be set to “OFF.” In this case, select “HDMI A” or “HDMI B” using the HDMI OUTPUT button (page 86).
- When “Zone2 Out” is set to “Off,” no signals from HDMI ZONE 2 will be output.
- GUI and upconverted video signals will not be output from the HDMI ZONE 2 OUT jack.
- The audio and video signals of the HDMI IN jacks will not be output from the HDMI ZONE 2 OUT jack when the same input is selected for both the main zone and zone 2 and the GUI menu is displayed on the TV in the main zone.

4K image

- Depending on the TV or video equipment, 4K images may not be displayed. Check the video capability and setting of your TV or video device. Also, make sure to connect the video equipment to an available 4K HDMI IN jack of the receiver.

3D image

- Depending on the TV or the video equipment, 3D images may not be displayed. Check the 3D image formats supported by the receiver (page 143).

VCR

- If you use a VCR without an image improvement circuit, such as TBC, the images may be distorted.

When you select “My Video,” “My Music,” “My Photo,” “Internet Music,” “Network,” or “Sony Entertainment Network” from the Watch/Listen menu, no picture is output.

- Select “BD” or “DVD” using INPUT SELECTOR on the receiver once, then set “Playback Resolution” to “480i/576i” or “480p/576p” in the Video Settings menu using the GUI (page 112), and select the content again.

The Pass Through function does not work.

- “HDMI B” or “Off” is selected. Select “HDMI A” using the HDMI OUTPUT button.
- When “Control for HDMI” is set to “On” and “Pass Through” is set to “Auto,” the receiver saves power consumption in standby mode according to the TV status. To enable the power saving, the “Control for HDMI” on the TV should be set effective. If it is not effective, set “Pass Through” on the receiver to “On.”

Audio

There is no sound, no matter which equipment is selected, or only a very low-level sound is heard.

- Check that the speakers and equipment are connected correctly.
- Check that both the receiver and all equipment are turned on.
- Check that MASTER VOLUME control is not set at $-\infty$ dB. Try to set it at about -40 dB.
- Check that SPEAKERS (A/B/A+B/OFF) is not set to OFF (page 47).
- Press MUTING on the remote control to cancel the muting function.
- Try pressing the input button on the remote control or INPUT SELECTOR on the receiver to select the equipment of your choice.
- Check that headphones are not connected.
- When you want to listen to the sound from the TV speaker, set “Audio Out” to “TV+AMP” in the HDMI Settings menu. If set to “AMP,” the sound is not output through the TV speaker. If you output the multi-channel sound from the receiver, set to “AMP.”

- When the Zone2 Out function is enabled and you select the same HDMI input for both the main zone and zone 2, there may be some interference on the audio and video signals in the main zone and zone 2. To avoid possible interference in the main zone, you can place priority on the main zone for HDMI input selection (page 80).
- Sound may be interrupted when the sampling frequency, the number of channels or audio format of audio output signals from the playback equipment is switched.
- Set the “EQ” setting of the iPod/iPhone to “Off” or “Flat.”

There is severe hum or noise.

- Check that the speakers and equipment are connected correctly.
- Check that the connecting cords are away from a transformer or motor, and at least 3 meters away from a TV set or fluorescent light.
- Move your TV away from the audio equipment.
- Make sure you have grounded the \hbar SIGNAL GND terminal (only when a turntable is connected).
- The plugs and jacks are dirty. Wipe them with a cloth slightly moistened with alcohol.

There is no sound from specific speaker(s).

Front

- Connect headphones to the PHONES jack to verify that sound is output to the headphones. If only one channel is output to the headphones, check that all the cords are fully inserted into the jacks on both the receiver and the equipment. If both channels are output to the headphones, check the connection of the front speaker which is not outputting any sound.

- Make sure you have connected both the L and R jacks to a monaural device, analog device requires both L and R jack connections. Use a monaural-stereo cable (not supplied). However, there will be no sound from the center speaker when a sound field (Pro Logic, etc.) is selected.

Center/surround/surround back/front high speaker(s)

- Check that the speaker settings are appropriate for the setup using “Auto Calibration” or “Speaker Connection” in the Speaker Settings menu. And then check that sound is output from each speaker correctly, using “Test Tone” in the Speaker Settings menu.
- Select the “HD-D.C.S.” sound field (page 62).
- Adjust the speaker level (page 103).
- Make sure the center/surround/front high speaker(s) is (are) set to either “Small” or “Large.”

Surround back

- Some discs have no Dolby Digital Surround EX information.
- If the speaker pattern is set so that there are no surround back speakers, the input signals to the SUR BACK jacks are invalid, because the receiver cannot down-mix the surround back channels.

Subwoofer

- Check that the subwoofer is connected correctly and securely.
- Make sure you have turned on your subwoofer.

There is no sound from a specific device.

- Check that the device is connected correctly to the audio input jacks for that device.
- Check that the cord(s) used for the connection is (are) fully inserted into the jacks on both the receiver and the device.
- Set the INPUT MODE to “AUTO” (page 87).

HDMI input

- When “2ch Analog Direct” is being used, the sound is not output. Use other sound field (page 61).
- Check the HDMI connection (page 30, 32, 33, 35).
- Check that you use an HDMI cable that have an HDMI logo authorized by HDMI Licensing LLC.
- Depending on the playback equipment, equipment may need to be set up. Refer to the operating instructions supplied with the equipment.
- Be sure to use a connecting cable for the HDMI jack corresponding to High Speed HDMI cable when you view images or listen to sound during a 1080p, Deep Color, or 3D or 4K transmissions.
- Sound may not be output from the receiver while the GUI appears on the TV screen. Press HOME to turn the GUI off.
- Audio signals (format, sampling frequency, bit length, etc.) transmitted from an HDMI jack may be suppressed by the connected equipment. Check the setup of the connected equipment if an image is poor or the sound does not come out of a device connected via the HDMI cable.
- When the connected equipment is not compatible with copyright protection technology (HDCP), the image and/or the sound from the HDMI OUT jack may be distorted or may not be output. In this case, check the specification of the connected equipment.
- Set the image resolution of the player to more than 720p/1080i to enjoy High Bitrate Audio (DTS-HD Master Audio, Dolby TrueHD).
- The image resolution of player may need certain settings be made before you can enjoy DSD and multi-channel Linear PCM. Refer to the operating instructions of the player.
- Make sure the TV is compatible with the System Audio Control function.

- If the TV does not have System Audio Control function, set the “Audio Out” settings in the HDMI Settings menu to
 - “TV+AMP” if you want to listen to the sound from the TV speaker and receiver.
 - “AMP” if you want to listen to the sound from the receiver. When you connect the receiver to a video device (projector, etc.), sound may not be output from the receiver. In this case, select “AMP.”
- You cannot listen to the sound of a device connected to the receiver while a TV is selected as the input on the receiver.
 - Be sure to change the input of the receiver to HDMI when you want to watch a program on a device connected to the receiver.
 - Change the TV channel when you want to watch a TV broadcast.
 - Be sure to select the correct equipment or input you want when you watch a program from the equipment connected to the TV.
- When using the Control for HDMI function, you cannot control the connected equipment using TV’s remote control.
 - Depending on the connected equipment and TV, you may need to set up the HDMI setting of the equipment and TV. Refer to the operation instructions supplied with the equipment and TV.
 - Change the input of the receiver to the HDMI input connected to the equipment.

Coaxial/optical input

- When “2ch Analog Direct” is being used, the sound is not output. Use other sound field (page 61).
- Check the INPUT MODE (page 87).
- Check to make sure the selected audio (digital) input jack is not assigned to other inputs in “Audio Input Assign” in the Input Settings menu (page 88).

Analog 2 channel input

- Check to make sure the selected audio (analog) input jack is not assigned to other inputs in “Audio Input Assign” in the Input Settings menu (page 88).

The left and right sounds are unbalanced or reversed.

- Check that the speakers and equipment are connected correctly.
- Adjust the balance parameters using the “Speaker Setup” in the Speaker Settings menu.
- Adjust the level of the speakers.

Dolby Digital or DTS multi-channel sound is not reproduced.

- Check that the DVD, etc., you are playing is recorded in Dolby Digital or DTS format.
- When connecting the DVD player, etc., to the digital input jacks of this receiver, make sure the digital audio output setting on the connected equipment.
- You can enjoy High Bitrate Audio (DTS-HD Master Audio, Dolby TrueHD), DSD, and multi-channel Linear PCM with an HDMI connection only.

Multi-channel sound cannot be output.

- When “Control for HDMI” is set to “On,” “Audio Out” may be automatically set to “AMP.” In this case, set “Audio Out” to “AMP.”

The surround effect cannot be obtained.

- Make sure the sound field function is on (press MOVIE/HD-D.C.S. or MUSIC).
- “PLII (Movie/Music),” “PLIIX (Movie/Music),” “PLIIZ Height,” and “Neo:X (Cinema/Music/Game)” do not work when the speaker pattern is set to 2/0 or 2/0.1.

The MULTI CHANNEL DECODING lamp does not light up in blue.

- Check that the playback equipment is connected on a digital jack and the input is selected properly on this receiver.
- Check whether the input source of the software being played back corresponds to the multi-channel format.
- Check whether the setup on the playback equipment is set to multi-channel sound.
- Check to make sure the selected audio (digital) input jack is not assigned to other inputs in “Audio Input Assign” in the Input Settings menu (page 88).

Recording cannot be carried out.

- Check that the equipment is connected correctly (page 37).
- Select the source equipment (page 51).
- Audio input signals via the HDMI IN and MULTI CHANNEL INPUT jacks cannot be recorded.
- Check the connection of the recording deck according to the audio signals you want to record. Analog input signals can be output only from the analog output jacks.

A test tone is not output from the speakers.

- The speaker cords may not be connected securely. Check to see if they are connected securely and cannot be disconnected by pulling on them slightly.
- The speaker cords may have the short-circuit problem.

A test tone is output from a different speaker than the speaker displayed on the screen.

- The speaker configuration set up is incorrect. Make sure that the speaker connections and the configuration match correctly.

The H.A.T.S. function does not work.

- “Audio Out” is set to “TV+AMP.” Select “AMP” for “Audio Out.”
- When the A.F.D. mode is set to “Multi Stereo,” the H.A.T.S. function does not work.
- The H.A.T.S. function may not work, depending on the settings.

Tuner

The FM reception is poor.

- Use a 75-ohm coaxial cable (not supplied) to connect the receiver to an outdoor FM antenna (aerial) as shown below. If you connect the receiver to an outdoor antenna (aerial), ground it against lightning. To prevent a gas explosion, do not connect the ground (earth) wire to a gas pipe.

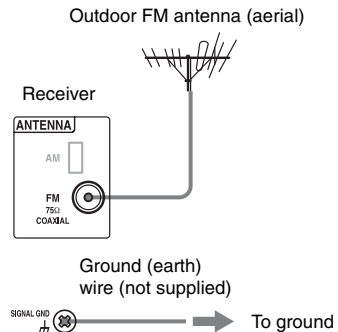

Radio stations cannot be tuned in.

- Check that the antennas (aerials) are connected securely. Adjust the antennas (aerials) and connect an external antenna (aerial), if necessary.
- The signal strength of the stations is too weak with automatic tuning. Use direct tuning.
- No stations have been preset or the preset stations have been cleared (when tuning by scanning preset stations is used). Preset the stations (page 59).

- Press DISPLAY MODE on the receiver so that the frequency appears on the display window.

USB device

The USB device is not recognized.

- Turn off the receiver, then disconnect the USB device. Turn on the receiver again and reconnect the USB device.
- Connect the supported USB device.
- The USB device does not work properly. Refer to the USB device operating instruction on how to deal with this problem.

Content on the USB device is not displayed.

- The hierarchy of folders has exceeded 4 levels. The receiver can display content in only up to 4 levels (including the “ROOT” folder). However, folders in a 4th level folder are not displayed.

No sound is output.

- Turn off the receiver, then disconnect the USB device. Turn on the receiver again and reconnect the USB device.
- Connect the supported USB device.
- Press ► to start playback.
- When “2ch Analog Direct” is being used, the sound is not output. Use other sound field (page 61).
- The music data itself contains noise, or the sound is distorted.
- Depending on the file format, there may be files that sometimes cannot be played back. For details, see “Network/USB” (page 23).
- USB device formatted with file systems other than FAT12/16/32, VFAT, or NTFS are unsupported.*
- If you use partitioned USB device, only audio files on the first partition can be played back.
- Playback is possible up to 4 levels (including the “ROOT” folder).

- The number of files in a folder has exceeded 500 (including folders).
- Files that are encrypted or protected by passwords, etc. cannot be played back.
- If you play back music files stored on a WALKMAN using the receiver, move the files to the WALKMAN from a computer by drag & drop, then save them on the WALKMAN in a format supported by the receiver (e.g., MP3).

* This receiver supports FAT12/16/32, VFAT, or NTFS, but some USB device may not support all of these file systems.

For details, refer to the operating instruction of each USB device or contact the manufacturer.

The USB device cannot be connected into the ◀ (USB) port.

- The USB device is being connected upside down. Connect the USB device in the correct orientation.

Erroneous display.

- The data stored in the USB device may have been corrupted.
- The character codes that can be displayed by this receiver are as follows:
 - Upper case (A to Z)
 - Lower case (a to z)
 - Numbers (0 to 9)
 - Symbols (' < > * + , - . / @ [\] _ ')
 Other characters may not be displayed correctly.

It takes a long time before playback starts.

- The reading process can take a long time in the following cases.
 - There are many folders or files on the USB device.
 - The file structure is extremely complex.
 - The memory capacity is excessive.
 - The internal memory is fragmented.
 Thus, we recommend following the guideline.
 - Total files per folder: 500 or less

iPod/iPhone

The iPod/iPhone cannot be charged.

- Check that the receiver is turned on.
- Make sure the iPod/iPhone is connected firmly.

The iPod/iPhone cannot be operated.

- Check that you have removed the protect case of the iPod/iPhone.
- Depending on the contents of the iPod/iPhone, it may take time to start playback.
- Turn off the receiver, then disconnect the iPod/iPhone. Turn on the receiver again and reconnect the iPod/iPhone.
- You are using an unsupported iPod/iPhone. See “Made for iPod/iPhone models” (page 53) for the supported device types.

The ringtones volume of the iPhone does not change.

- Adjust the ringtones volume using the controls on the iPhone.

Network

Cannot connect to the network.

- Check the network connection (page 44) and the Network Settings menu (page 116).
- Check to see if the port you want to use to connect the system to a network is activated.

Cannot find the server.

- Search the server using “Connection Server Settings” in the Network Settings menu (page 116).
- Check the following:
 - Is the router turned on?
 - If there is another device between the receiver and the router, check that device is turned on.
 - Are all of the cables connected correctly and securely?

- Is the settings to make sure that they match the router’s settings (DHCP or fixed IP address)?
- When using a computer, check the following:
 - The built-in firewall settings for the computer’s operating system.
 - The firewall settings of your security software. To check the firewall settings of your security software, refer to your security software’s Help section.
- Register the receiver with the server. For details, refer to the instructions supplied with the server.
- Wait for a few moments, and then try connecting to the server again.

Cannot find or play back the content on the server.

- On the “My Music” and “My Photo” screens, the receiver displays only the content that can be played back with the receiver from among the content offered by the server within the DLNA guidelines.
- There may be content that is not played back or displayed even if that content is defined in the DLNA guidelines.

Cannot access the receiver from “ES Remote” or the DLNA controller.

- Make sure the controller you want to use is set to “Allow” in “Renderer Access Control” (page 116).
 - If you set “Auto Access Permission” to “On” in “Renderer Options” (page 116), any controller detected can be available automatically.
 - Is the network controller listed on “Renderer Options,” and is it set to “Allow”?
- If the box is not checked, check the box for “Auto Access Permission,” and return to the home menu. Then, operate the receiver using the network controller once, and then uncheck the box for “Auto Access Permission,” if necessary.

- If the network controller is a computer software controller, is the software filtered by antivirus software or firewall software? Permit UPnP communications between the software and the receiver. For details, refer to the operating instructions of the antivirus software, firewall software, or network controller software.

Internet content

The picture/sound is poor/certain programs display with a loss of detail, especially during fast motion or dark scenes.

- Picture/sound quality may be poor, depending on Internet content providers.
- Picture/sound quality may be improved by changing the connection speed.
- Not all content contain sound.

The picture is small.

- Press **▲** to zoom in.

Cannot play back content.

- Some Internet content requires registration via a computer before it can be played.

“BRAVIA” Sync (Control for HDMI)

“Control for HDMI” cannot be set to “On.”

- Set “Zone2 Out” in the “HDMI Settings” to “Off.”

The Control for HDMI function does not work.

- Check the HDMI connection (page 28, 30, 32, 33).
- Make sure “Control for HDMI” is set to “On” in the HDMI Settings menu.
- When “Zone2 Out” is set to “On,” the Control for HDMI function does not work.
- Make sure the connected equipment is compatible with the Control for HDMI function.

- Check the Control for HDMI settings on the connected equipment. Refer to the operating instructions of the connected equipment.
- If you change the HDMI connection, connect/disconnect the AC power cord (mains lead), or there is a power failure, repeat the procedures of “Preparing for the “BRAVIA” Sync” (page 83).
- When you select “HDMI OUT B” or “OFF,” the Control for HDMI function does not work properly.
- If you select “HDMI OUT A” after you have selected “HDMI OUT B” or “OFF,” the Control for HDMI function may not work properly for a while. This is because the equipment connected to the HDMI OUT A jack must re-recognize the receiver that is equipped with the Control for HDMI function. If the Control for HDMI function does not work properly for a long time, perform the steps given in “Preparing for the “BRAVIA” Sync” (page 83).
- The types and the number of devices which can be controlled by the “BRAVIA” Sync feature are restricted in the HDMI CEC standard as follows.
 - Recording equipment (Blu-ray Disc recorder, DVD recorder, etc.): up to 3 devices
 - Playback equipment (Blu-ray Disc Player, DVD player, etc.): up to 3 devices
 - Tuner-related equipment: up to 4 devices (The receiver uses one of them for its GUI operations.)
 - Audio System (AV Receiver) : up to 1 devices

When you try to use the One-Touch Play function, input is not switched as intended.

- Check to see if “Zone2 Out” is set to “Off.”
- Check the assignment of the HDMI input (page 88). When you assign multiple inputs to the same HDMI input jack, if you use the One-Touch Play function on the equipment connected to the HDMI input, the input you have assigned last is preferentially selected.

The Audio Return Channel (ARC) does not work.

- Make sure “Control for HDMI” is set to “On” in the HDMI Settings menu.
- Make sure that the INPUT MODE for “TV” is set to “AUTO” (page 87).

Remote control

The remote control does not function.

- Point the remote control at the remote sensor on the receiver (page 11).
- Remove any obstacles in the path between the remote control and the receiver.
- Replace all the batteries in the remote control with new ones, if they are weak.
- When you start operating the receiver, make sure to press AMP on the remote control first. Otherwise, operations that follow may not be aimed at the receiver. Then select the devices you want to use by pressing one of the input buttons.
- Make sure that the command modes of the receiver and the remote control are the same. If the command mode of the receiver and the remote control are different, you cannot operate the receiver with the remote control (page 92).
- Make sure you select the correct input on the remote control.

If the trouble is other than one of the cases described above and the trouble is not solved even if you wait for a while, perform either of the operations below.

- Press I/⏻ on the remote control to turn the receiver off and then on again.
- Hold down I/⏻ on the receiver until the lamp above the button flashes in green to reboot the receiver.

Universal Remote Control

The Universal Remote Control function does not work.

- Make sure the connections required are made.
If the trouble is other than one of the cases described above and the trouble is not solved even if you wait for a while, perform either of the operations below.
- Press I/⏻ on the remote control to turn the receiver off and then on again.
- Hold down I/⏻ on the receiver until the lamp above the button flashes in green to reboot the receiver.
- If the remote sensor of the receiver and that of another Sony product face the same direction, interference may occur. In this case, set the remote sensors so that they face different directions or use an IR shield on the other Sony product to shield the IR from interference from the receiver IR remote.
- Make sure the receiver is connected to the Internet.
- Press ROOM OFF on the remote control to turn off the receiver and the AV equipment.

Lighting Control

The lighting device cannot be identified.

- Try pressing the button on the top of the lighting device 4 times. Then repeat this procedure more than once.
- If the LED continues blinking weakly, press and hold the button on the lighting device for 5 seconds then tap four times on the button on the wizard.

- To reset the lighting device, press the button on the top of the lighting device 13 times. The LED will turn to red and then back to green or emit an orange-yellow strobe.

The lighting device cannot be operated.

- The device may be updating its software. Wait for about half an hour until the update is completed.
- It may be off-line. Wait for half an hour until the device returns online.
- Reset the lighting device and delete the identified device on the receiver. Reboot the receiver and then set up the Lighting Control function again. Also perform the procedures necessary to reset the lighting device described above.

The Lighting Control function doesn't work.

- The Lighting Control Adapter may have been unplugged while the power was on and the system data may be corrupted. Reset the lighting device and delete the identified devices on the receiver. Then reboot the receiver and set up the Lighting Control function again.
- Hold down I/⏻ on the receiver until the lamp above I/⏻ flashes in green to reboot the receiver.

Error messages

You can check the status of the receiver by the message. See the following to solve the problem. If any problem persists, consult your nearest Sony dealer.

PROTECTOR

The receiver is covered and ventilation holes are blocked. The receiver will automatically turn off after a few seconds. Remove the object covering the upper panel of the receiver and turn on the power again.

SPEAKER SHORTED

Irregular current is output to the speakers due to a short circuit on the speaker terminals. The receiver will automatically turn off after a few seconds. If the protective device on the receiver is activated due to a short-circuit problem, turn off the receiver. Check the connection of the speakers and turn on the power again.

FAN STOPPED

Check that the ventilation hole on the top of the receiver is not blocked.

“A new software version is available. Please go to the “Setup” section of the menu and select “Network Update” to perform the update.” appears on the TV screen.

See “Network Update” (page 120) to update the receiver to a newer software version.

Video cannot be output from this jack.

- If you use the receiver in the main zone, connect the receiver to a TV via an HDMI cable.
- If you connect the receiver to a TV via a video cord, set “Playback Resolution” to “480i/576i” (page 112).
- If you connect the receiver to a TV via a component video cord, set “Playback Resolution” to a parameter appropriate to your TV (page 112).

Message list after Auto Calibration measurement

Display	Explanation
Code 30	Headphones are connected. Remove the headphones and perform auto calibration again.
Code 31	SPEAKERS (A/B/A+B/OFF) is set to OFF. Set to other speaker settings and reperform the measurement.
Code 32	None of the speakers were detected. Make sure that the plug of the optimizer microphone is inserted all the way inside the AUTO CAL MIC jack, then reperform the Auto Calibration function.
Code 33	<ul style="list-style-type: none">• None of the front speakers are connected or only one front speaker is connected.• The optimizer microphone is not connected. Make sure that the plug of the optimizer microphone is inserted all the way inside the AUTO CAL MIC jack, then reperform the Auto Calibration function.• Either the left or right surround speaker is not connected.• Surround back speakers are connected even though surround speakers are not meant to be connected. Connect the surround speaker(s) to the SURROUND terminals.• The surround back speaker is connected only to the SURROUND BACK (ZONE 2) R terminals. When you connect only one surround back speaker, connect it to the SURROUND BACK (ZONE 2) L terminals.• Only one front high speaker is connected. Connect the front high speaker to each of the FRONT HIGH terminals.• Front high speakers are connected even though surround speakers are not connected. Connect the surround speaker(s) to the SURROUND terminals.
Code 34	Speakers are not placed in the proper position. Speakers or an optimizer microphone on the right or left may be placed wrongly. See “1: Installing speakers” (page 24) and check the speaker position.
Warning 40	The measurement process has completed with high noise level detection. You may be able to achieve better results if you try in a quite environment again.
Warning 41	The input from the microphone is too big.
Warning 42	<ul style="list-style-type: none">• It may be too close the distance between the speaker and the microphone. Retry the measurement after setting apart from each other.• When you use the receiver as a pre-amplifier, either messages may appear, depending on the power amplifier you connect. However, there will be no problems, even if you continue to use the receiver without changes.
Warning 43	The distance and position of a subwoofer cannot be detected. Or the angle of the speaker position cannot be detected. This may be caused by noise. Try to perform the measurement in a quiet environment.
Warning 44	Measurement has been completed. However the speakers are not placed in the proper position with respect to each other. See “1: Installing speakers” (page 24) and check the relative positions of the speakers.
NO WARNING	There is no warning information.

Clearing the memory

Reference sections

To clear	See
All memorized settings	page 95

Rebooting the receiver

If the buttons on the receiver or the remote control do not work due to a malfunction of the receiver, reboot the receiver.

Hold down **I/⏻** for 10 seconds.
When the lamp above **I/⏻** flashes in green, the reboot starts.

About support information

Refer to the following web site for details of the latest information on the receiver.
<http://www.sony.com/essupport>

Specifications

AUDIO POWER SPECIFICATIONS

POWER OUTPUT AND TOTAL HARMONIC DISTORTION:

With 8 ohm loads, both channels driven, from 20 – 20,000 Hz; rated 130 watts per channel minimum RMS power, with no more than 0.09% total harmonic distortion from 250 milliwatts to rated output.

Amplifier section POWER OUTPUT^{1) 2)}

Rated Power Output at Stereo Mode

(8 ohms 20 Hz – 20 kHz,
THD 0.09%);
130 W + 130 W

Reference Power Output at Stereo Mode

(4 ohms 20 Hz – 20 kHz,
THD 0.15%);
130 W + 130 W

Reference Power Output

(8 ohms 1 kHz, THD 0.7%)
FRONT:
140 W + 140 W
FRONT HIGH:
140 W + 140 W
CENTER: 140 W
SURROUND:
140 W + 140 W
SURROUND BACK:
140 W + 140 W

Reference Power Output

(4 ohms 1 kHz, THD 0.7%)
FRONT:
130 W + 130 W
FRONT HIGH:
130 W + 130 W
CENTER: 130 W
SURROUND:
130 W + 130 W
SURROUND BACK:
130 W + 130 W

- ¹⁾ Measured under the following conditions:
Power requirements: 120 V AC, 60 Hz
- ²⁾ Depending on the sound field settings and the source, there may be no sound output.

Frequency response³⁾

PHONO	RIAA equalization curve ± 1.0 dB (20 Hz – 20 kHz)
MULTI CHANNEL INPUT, SA-CD/CD, MD/TAPE, TV, VIDEO 1/2, DVD, SAT/CATV, GAME	10 Hz – 100 kHz ± 3 dB

Inputs (Analog)

PHONO	Sensitivity: 2.5 mV Impedance: 50 kohms S/N ³⁾ : 90 dB (A, 20 kHz LPF)
MULTI CHANNEL INPUT, SA-CD/CD, MD/TAPE, TV, VIDEO 1/2, DVD, SAT/CATV, GAME	Sensitivity: 150 mV Impedance: 50 kohms S/N ³⁾ : 105 dB (A, 20 kHz LPF. 500 mV)

³⁾ When "A.Direct" is being used.

Inputs (Digital)

IN 1 (DVD), IN 2 (VIDEO 1), IN 3 (SA-CD/CD) (Coaxial)	Impedance: 75 ohms S/N: 96 dB (A, 20 kHz LPF)
IN 1 (GAME), IN 2 (SAT/CATV), IN 3 (TV) (Optical)	S/N: 96 dB (A, 20 kHz LPF)

Outputs

MD/TAPE, VIDEO 1, ZONE 2, ZONE 3 (AUDIO OUT)	Voltage: 150 mV Impedance: 1 kohm
FRONT L/R, CENTER, SURROUND L/R, SURROUND BACK L/R, FRONT HIGH L/R, SUBWOOFER	Voltage: 2 V Impedance: 1 kohm

FM tuner section

Tuning range	87.5 MHz – 108.0 MHz
Antenna (aerial)	FM wire antenna (aerial)
Antenna (aerial) terminals	75 ohms, unbalanced

AM tuner section

Tuning scale	Tuning range
10 kHz step	530 kHz – 1,710 kHz
9 kHz step	531 kHz – 1,710 kHz
Antenna (aerial)	Loop antenna (aerial)

Video section

Inputs/Outputs

Video: 1 V_{p-p}, 75 ohms

COMPONENT VIDEO:

Y: 1 V_{p-p}, 75 ohms

P_B: 0.7 V_{p-p}, 75 ohms

P_R: 0.7 V_{p-p}, 75 ohms

80 MHz HD Pass Through

HDMI Video

Input/Output (HDMI Repeater block)

Format	2D	3D		
		Frame packing	Side-by-Side (Half)	Over-Under (Top-and-Bottom)
4096 × 2160p @ 23.98/24 Hz	○	-	-	-
3840 × 2160p @ 29.97/30 Hz	○	-	-	-
3840 × 2160p @ 25 Hz	○	-	-	-
3840 × 2160p @ 23.98/24 Hz	○	-	-	-
1920 × 1080p @ 59.94/60 Hz	○	-	○	○
1920 × 1080p @ 50 Hz	○	-	○	○
1920 × 1080p @ 29.97/30 Hz	○	○	○	○
1920 × 1080p @ 25 Hz	○	○	○	○
1920 × 1080p @ 23.98/24 Hz	○	○	○	○
1920 × 1080i @ 59.94/60 Hz	○	○	○	○
1920 × 1080i @ 50 Hz	○	○	○	○
1280 × 720p @ 59.94/60 Hz	○	○	○	○
1280 × 720p @ 50 Hz	○	○	○	○
1280 × 720p @ 29.97/30 Hz	○	○	○	○
1280 × 720p @ 23.98/24 Hz	○	○	○	○
720 × 480p @ 59.94/60 Hz	○	-	-	-
720 × 576p @ 50 Hz	○	-	-	-
640 × 480p @ 59.94/60 Hz	○	-	-	-

General

Power requirements	120 V AC, 60 Hz
Power consumption	500 W
Power consumption (during standby mode)	0.5 W (When “Control for HDMI” (page 114), “Pass Through” (page 114), “Network Standby” (page 116), and “RS232C Control” (page 120) are set to “Off,” and the power for zone 2/zone 3 is turned off.)
Dimensions	430 mm × 187.5 mm × 420 mm (17 in × 7 1/2 in × 16 5/8 in) (width/height/depth) including projecting parts and controls
Mass (Approx.)	18.0 kg (39 lb 11 oz)

Supplied accessories

Operating Instructions (this manual)
Quick Setup Guide (1)
Optimizer microphone ECM-AC1 (1)
FM wire antenna (aerial) (1)
AM loop antenna (aerial) (1)
AC power cord (mains lead) (1)
Remote control (1)
R6 (size-AA) batteries (2)
Speaker cord connection tool (1)
Lighting Control Adapter (USB Wireless Adapter UWA-C4Z) (1)
IR blaster (4)

Design and specifications are subject to change without notice.

Index

Symbols

⌚ SIGNAL GND terminal 41

Numerics

12V Trigger 118
 2 channel 61
 2ch Analog Direct 61
 2ch Stereo (mode) 61
 3D Output Settings 113
 5.1 channel 24
 7.1 channel 24
 9.1 channel 24

A

A.F.D. (mode) 62
 A/V Sync 107
 AC power cord (mains lead) 45
 AM 57
 Antenna (aerial) 40
 Audio Input Assign 88, 115
 Audio Out 113
 Audio Return Channel (ARC) 85, 87
 Audio Settings 106
 Auto Calibration 99
 Auto Calibration Setup 99
 Auto Standby 119
 Auto Tuning 58
 Automatic Phase Matching 101
 AV Equipment Control 117

B

Bass 66
 Berlin Philharmonic Hall 64
 Bi-amplifier connection 94
 Blu-ray Disc Player 30

C

Cable box 33
 Calibration Type 100
 Camcorder 35
 CD player 37
 Center Analog Down Mix 105
 Center Speaker Lift Up 102

Changing the display 127
 Clear
 receiver 95
 Concertgebouw Amsterdam 64, 65
 Connection Server Settings 116
 Connections
 antenna (aerial) 40
 audio equipment 37
 monitor 28
 Network 44
 speakers 26
 video equipment 30
 Control for HDMI 114
 Crossover Frequency 103

D

D.C.A.C. (Digital Cinema Auto Calibration)
 99
 Decode Priority 107
 Digital Legato Linear (D.L.L.) 106
 Direct Tuning 58
 Display 13, 122
 Distance Unit 105
 DLNA 54
 Dual Mono 106
 DVD player 30
 Dynamic Range Compressor 107

E

Easy Automation 71
 Easy Setup 46, 99
 Effect type 63
 Equalizer 66, 106
 ES Remote 91
 External Control 116

F

Fast View 115
 Favorites 50
 FM 57
 FM Mode 58
 Front Reference Type 100

continued

145^{US}

G

GUI (Graphical User Interface) 28, 49

H

H.A.T.S. 114
HD-D.C.S. 62
HD-D.C.S. (Effect type) 63
HDMI Settings 113
Home Control Settings 117
Home Theater Control 85

I

Initialize Personal Information 120
Input Edit 115
INPUT MODE 87
Input Settings 115
Internet content 56
Internet Settings 116
iPod/iPhone 53

J

Jazz Club 64

L

L.F.E. (Low Frequency Effect) 13
Language 119
Large 103
LFE Time Alignment 106
Lighting Control 73, 117
Lighting Scenes 74, 117
Line Out 79, 118
Listen 51
Live Concert 64

M

MASTER VOLUME 12, 51
MD deck 41
Menu 50, 96
Messages
 Auto Calibration 140
 Error 139
Mid 66
Movie 62
Movie Height 62
Multi Zone 75
Music 64

Musikverein Vienna 64, 65
Muting 51

N

Name In 101
Name Input 59
Neo:X (Cinema) 62
Neo:X (Game) 64
Neo:X (Music) 64
Network Settings 116
Network Standby 116
Network Update 120

O

One-Touch Play 84

P

Pass Through 86, 114
Phase Audio 104
Phase Noise 104
PHONES 12
Playback Resolution 112
PlayStation 3 32
PLII (Movie) 62
PLII (Music) 64
PLIIx (Movie) 62
PLIIx (Music) 64
PLIIz Height 62, 64, 65
Portable Audio 64
Position 99
Preset stations 59
Priority 114
PROTECTOR 139

R

Recording 92
Registration 117
Remote control 18–19, 46, 68–70
Renderer Access Control 116
Renderer Options 116
Resetting
 receiver 95
Resolution 109
ROOM OFF 70
RS232C Control 120

S

Satellite tuner 33
Scene Select 85
Screen Format 113
Server
 Preparing 49
Setting menu 96
Settings 96
Settings Lock 119
Sleep timer 92
Small 103
Software License 120
Software Update Notification 120
Sound Effects 61
Sound Field 61, 108
Sound Optimizer 66, 106
Speaker Connection 101
Speaker impedance 47, 105
Speaker Pair Match 100
Speaker pattern 101
Speaker Relocation 102
Speaker Settings 99
Speaker Setup 103
SPEAKER SHORTED 139
SPEAKERS (A/B/A+B/OFF) 11, 47
Sports 64
Stadium 64
Subwoofer Level 113
Subwoofer Low Pass Filter 107
Subwoofer Muting 106
Super Audio CD player 37
Surround Back Assign 101
Surround Speaker Position 102
System Audio Control 84
System Information 120
System Power-Off 84
System Settings 119

T

Tape deck 41
Test Tone 104
TONE 12, 95
Treble 66
Tuning 58, 59
Turntable 41
TV Control 117
TV Type 113

U

Up converting 21
USB 52
User Reference Edit 100

V

VCR 34
VIDEO 2 IN jacks 35
Video Input Assign 88, 115
Video Settings 109
Virtual Front High 101
Vocal Height 64

W

WALKMAN 52
Watch 51

Z

Zone Control 118
Zone Resolution 111
Zone Settings 118
Zone Setup 118
Zone2 Out 114

Free Manuals Download Website

<http://myh66.com>

<http://usermanuals.us>

<http://www.somanuals.com>

<http://www.4manuals.cc>

<http://www.manual-lib.com>

<http://www.404manual.com>

<http://www.luxmanual.com>

<http://aubethermostatmanual.com>

Golf course search by state

<http://golfingnear.com>

Email search by domain

<http://emailbydomain.com>

Auto manuals search

<http://auto.somanuals.com>

TV manuals search

<http://tv.somanuals.com>