

SONY

COMPONENT TV TUNER VTX-1000R

OPERATING INSTRUCTIONS

Before operating the set, please read this manual thoroughly, and retain it for future reference.

For detailed instructions for system connections, see the separate booklet "SYSTEM CONNECTION GUIDE".

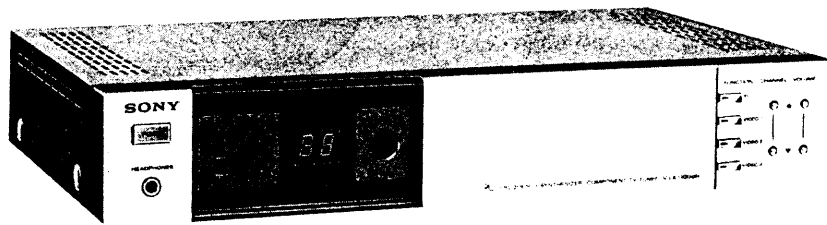

CONTENTS

Warning	2
Precautions	2
Features	3
Location of parts and controls	4
Using the VTX-1000R as a TV tuner	6
Normal TV operation	6
Cable TV operation	8
Sound adjustments	9
Remote control operation	10
Channel presetting	14
Function of rear panel connectors	16
Antenna/cable connection	18
Specifications	19

OWNER'S RECORD

The model and serial numbers are located at the rear. Record the serial number in the space provided below. Refer to these numbers whenever you call upon your Sony dealer regarding this product.

Model No. VTX-1000R Serial No. _____

©1981 by Sony Corporation

WARNING

To prevent fire or shock hazard, do not expose the set to rain or moisture.

To avoid electrical shock, do not open the cabinet. Refer servicing to qualified personnel only.

PRECAUTIONS

USE

- Operate only on 120 V ac.
- This set is equipped with a polarized AC power cord plug (one blade of the plug is wider than the other), which will fit into the power outlet only one way. Should you be unable to insert the plug fully into the outlet, try reversing the plug. If the plug still fails to fit, contact your dealer for assistance. Do not defeat the safety purpose of the polarized plug.
- Should any liquid or solid object fall into the cabinet, unplug the set and have it checked by qualified personnel before operating it any further.
- Unplug the set from the wall outlet if it is not to be used for several days.
- To disconnect the cord, pull it out by the plug. Never pull the cord itself.
- If this set will be used with a TV game, observe the following precautions.
 - Reduce the PICTURE key setting when the TV game is in use.
 - Avoid prolonged operation of the TV game, and turn it off when not in use.

INSTALLATION

- Allow adequate air circulation to prevent internal heat build-up. Do not place the set on surfaces (rugs, blankets, etc.) or near materials (curtains, draperies) that may block the ventilation holes.
- Do not install the set in a location near heat sources such as radiators or air ducts, or in a place subject to direct sunlight, excessive dust, mechanical vibration or shock.
- When an ac power cord connected to the VTX-1000R's SWITCHED AC OUTLET is placed near an AM antenna, AM reception may be affected. If this happens, move the power cord away from the antenna, or connect the power cord to the VTX-1000R's UNSWITCHED AC OUTLET or to a wall outlet.

MAINTENANCE

- Save the original shipping carton and packing material; they will come in handy if you ever have to ship your set. For maximum protection, repack your set as it was originally packed at the factory.
- To keep the set looking brand-new, periodically clean it with a soft cloth. Stubborn stains may be removed with a cloth lightly dampened with a mild detergent solution. Never use strong solvents such as thinner or benzine, or abrasive cleansers since these will damage the cabinet. As a safety precaution, unplug the set before cleaning it.

Use of this television tuner for other than private performance of programs broadcast for the use of the general public may require authorization from the transmitter and/or program owner. Use with cable television transmission may require authorization from the cable system transmitter and/or program owner.

Note to CATV system installer:
This reminder is provided to call the CATV system installer's attention to Article 820.42 of the NEC that provides guidelines for proper grounding and, in particular, specifies that the cable ground shall be connected to the grounding system of the building, as close to the point of cable entry as practical.

FEATURES

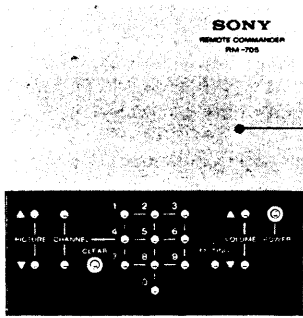

Remote control television tuner with a multi-function Remote Commander.

CATV (cable television) programs or normal broadcast programs can be selected.

Easy channel selection and presetting with 10-key tuning system which employs a PLL (Phase Locked Loop) frequency synthesizer.

Two VHF antenna inputs allow both normal TV/CATV signals and pay cable TV signals to be selected through a home converter. The VHF AUX antenna input may accept a video tape recorder, TV game, disc player, etc.

Split carrier SIF circuit provides high fidelity TV sounds free of any interference from video signals.

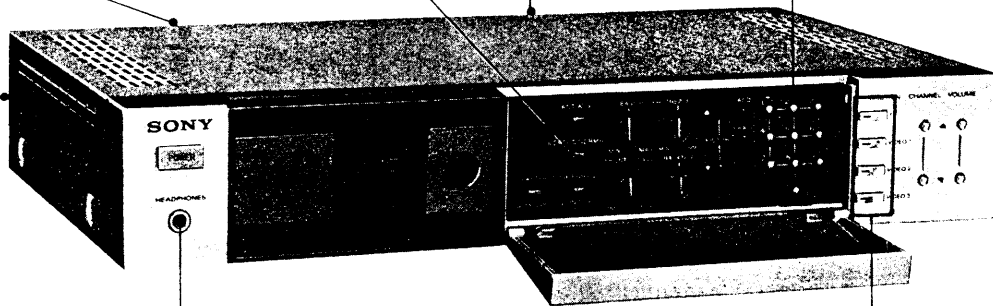

Stereo headphones can be connected.

TV or either of three external video programs can be selected with the corresponding FUNCTION button.

A variety of connections with a Trinitron Component TV, Betamax videocassette recorder, video projection system, audio amplifier, etc. can be made.

LOCATION OF PARTS AND CONTROLS

For the operation of these controls, see the following pages.

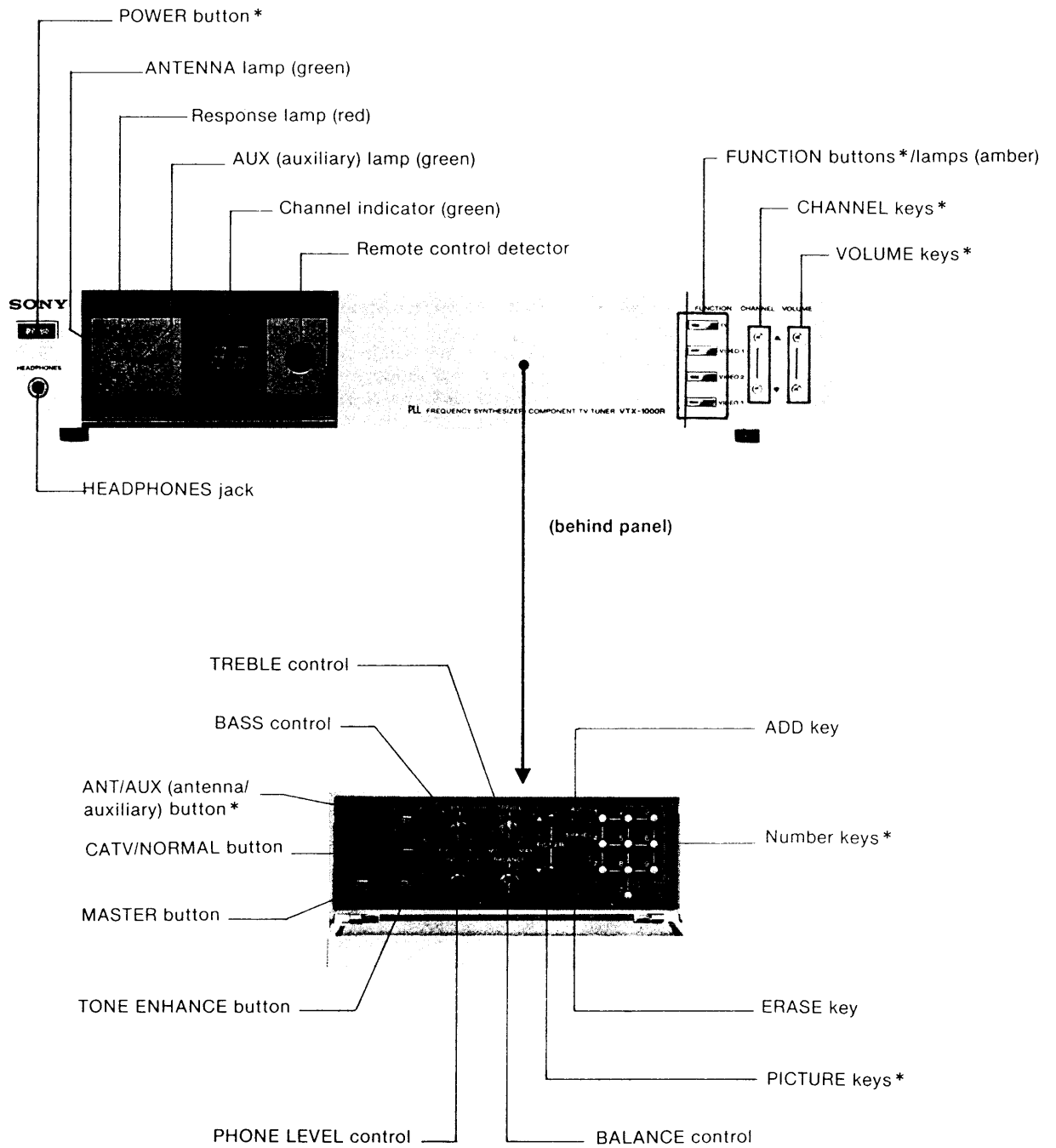

*These functions are also provided on the supplied RM-705 Remote Commander. See page 12.

Rear panel connectors and controls

For antenna/cable connections,
see page 18.

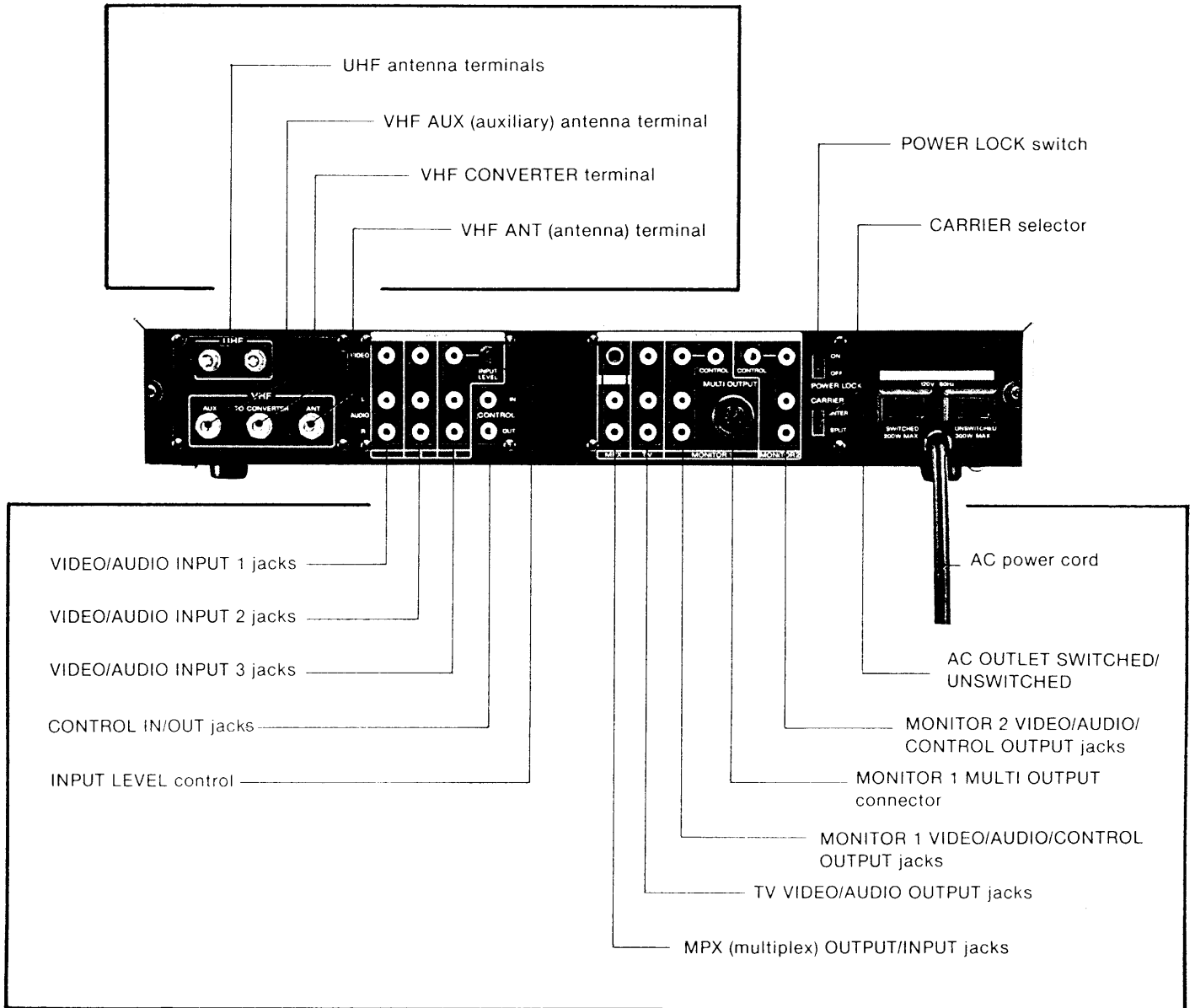

For function of connectors and controls, see page 16.
Make system connections referring to the separate booklet "SYSTEM CONNECTION GUIDE".

USING THE VTX-1000R AS A TV TUNER

NORMAL TV OPERATION (PANEL OPERATION)

1

Set the CATV/NORMAL button to NORMAL (released position).

2

Press the MASTER button.
Keep this button pushed in to be able to operate the set with the Remote Commander.

3

Press the POWER button.
The picture will appear on the monitor. To switch off, press the button again.
Note: If the picture does not appear, check that both the ANTENNA and TV lamps light. If not, press the ANT/AUX button and/or TV button.

Check that the POWER LOCK switch is set to OFF and the CARRIER selector is set to SPLIT.

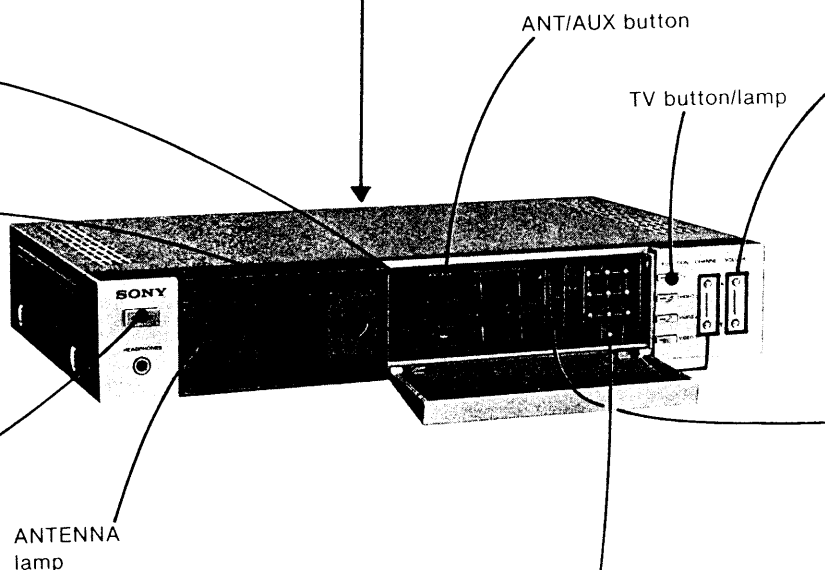

4

Select the desired channel either by —pressing the number keys:

—or by scanning higher or lower for the channel among the pre-memorized channels with the CHANNEL keys:

Examples

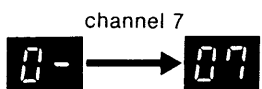
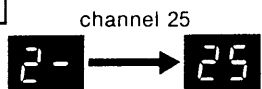

For channels 2 through 9, press the 0 key first.



For higher-numbered channels, press the upper key.

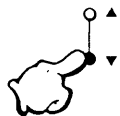

For lower-numbered channels, press the lower key.

This TV tuner is preset at the factory to receive VHF channels 2 through 13 with the CHANNEL keys. To add UHF or CATV channels or to erase inactive channels, see page 14.

When the TV tuner is used with a Sony KX-series Component TV, proceed to steps **5** and **6**.

5

To increase the sound volume, keep the VOLUME ▲ key depressed. To decrease, keep the VOLUME ▼ key depressed.

6

Adjust the PICTURE keys according to the room lighting condition. To increase the picture contrast, keep the PICTURE ▲ key depressed. To decrease, keep the PICTURE ▼ key depressed.

Operating notes

	When turned off with POWER button on the TV or Commander and turned on again.	When turned off with MASTER button and turned on again.
FUNCTION setting	memorized	TV
ANT/AUX setting		ANT
channel		memorized
sound volume		
picture contrast		

POWER LOCK switch

Normally set to OFF.

If the TV tuner is to be switched on or off by a timer, set this switch to ON and keep the MASTER button pushed in.

When power is supplied to the TV tuner with the POWER LOCK switch and MASTER button set to ON, the tuner will turn on automatically.

CARRIER selector

Normally set to SPLIT. The split carrier SIF circuit produces high fidelity TV sounds free from buzz noise caused by interference from video signals.

When receiving UHF signals which have been transmitted through several relay stations, setting to INTER may reduce noise.

When the ANT/AUX button is set to AUX to receive pay cable TV signals or TV game signals from the AUX terminal, the inter carrier will be selected irrespective of the CARRIER selector setting to reduce the hum which might be caused by a channel converter or other equipment.

The PICTURE and VOLUME keys do not function when the TV tuner is used with a video monitor or video projection system not equipped with a control input connector.

Note: If you select an incorrect tens-digit, or forget to first select 0 for channels 2 through 9

Example

When you wish to select channel 7.

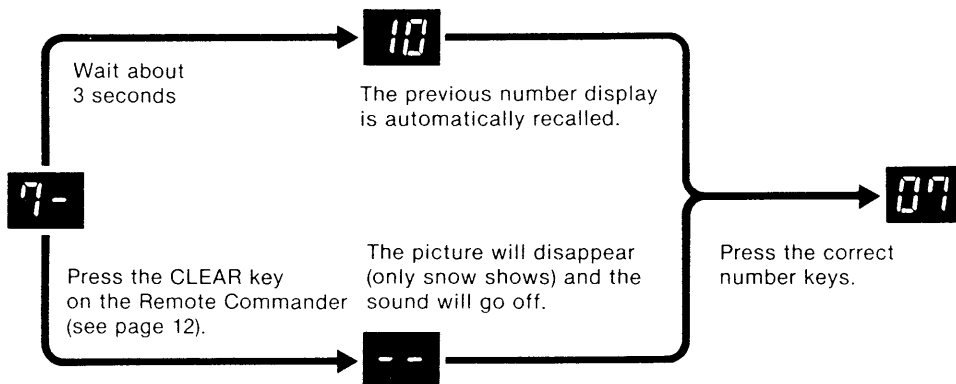

CABLE TV OPERATION (PANEL OPERATION)

In CATV (cable television) systems, programs are brought into the home on the mid-band channels A-I and the super-band channels J-W.

This TV tuner receives CATV channels, A through W, with the NORMAL/CATV selector set to CATV.

Channel A can be tuned in by selecting number 14 on this TV tuner, channel B by selecting number 15, and so on, as follows:

Number on this TV tuner	14	15	16	17	18														
Corresponding CATV channel	A	B	C	D	E														
	19	20	21	22	23	24	25	26	27										
	F	G	H	I	J	K	L	M	N										
	28	29	30	31	32	33	34	35	36										
	O	P	Q	R	S	T	U	V	W										

Most CATV systems use letters to designate channels but some use numbers. To tune in a numbered channel, select the same number on the TV tuner.

Consult your local cable TV company or your nearest Sony dealer to find out which of these channels are receivable and which type of cable system is used in your area. (Most of pay cable TV systems use scrambled or encoded signals and may require special converters.)

CATV programs are tuned in the same way as normal TV programs except for the CATV/NORMAL button and/or the ANT/AUX button setting.

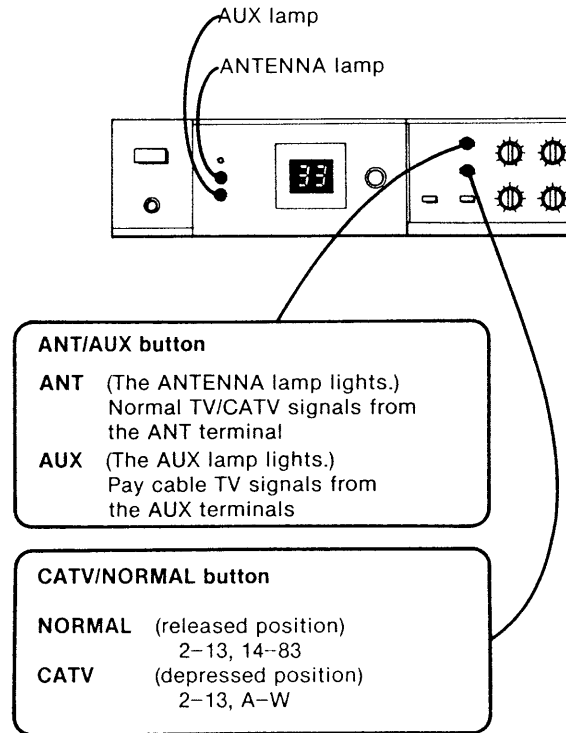

- ❶ Press the CATV/NORMAL button to set to CATV.
- ❷ Press the MASTER button.
- ❸ Press the POWER button. Check that the TV button is selected.
- ❹ Press the ANT/AUX button, if required, to select VHF antenna inputs, ANT or AUX, according to the program to be viewed.
- ❺ Select the desired channel either by pressing the number keys or by scanning higher or lower for the channel among the prememorized channels with the CHANNEL keys. (See page 6.)
 - To tune in the pay cable TV signals, select the output channel number of the channel converter.
 - It may take a little longer to tune in the desired CATV channel than a normal TV channel.

SOUND ADJUSTMENTS

Satisfactory results will usually be obtained with the controls set at the following positions.

If any adjustments are necessary, adjust the required controls to your preference.

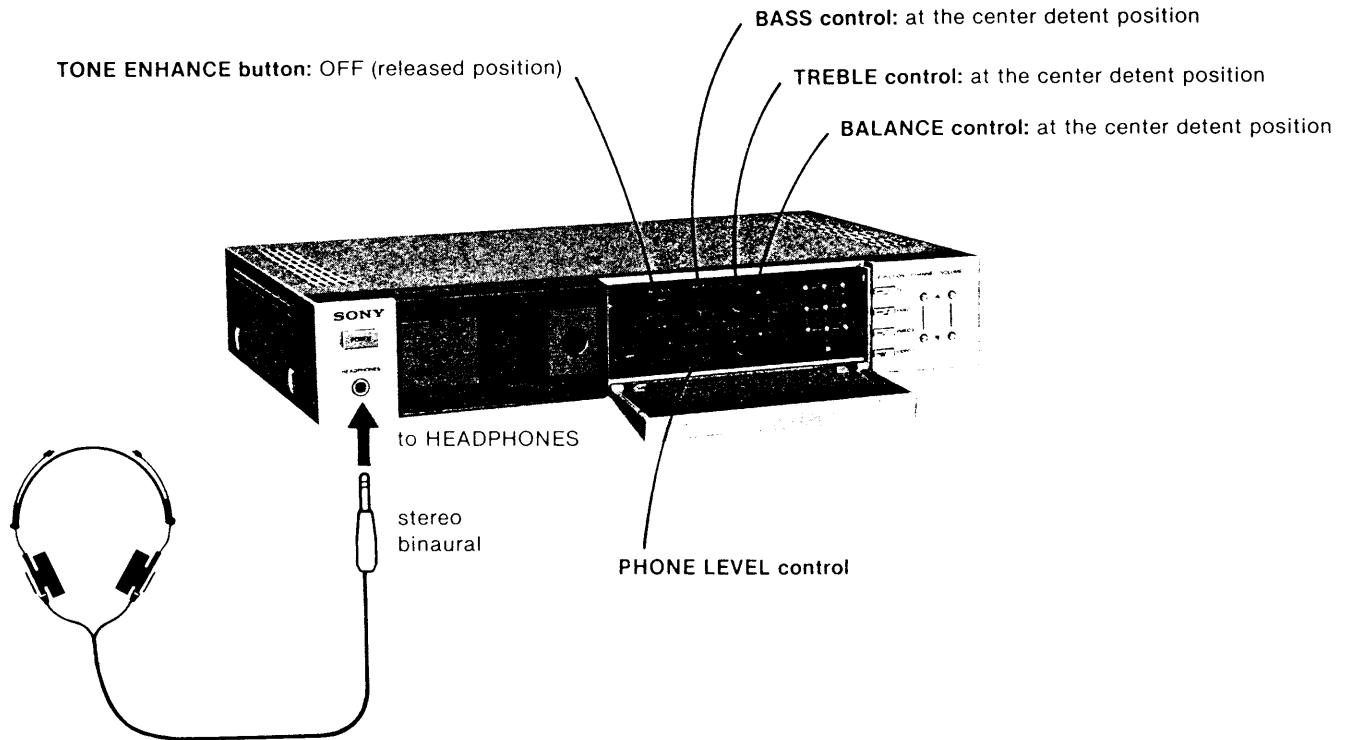

For private listening, connect a headphones to the HEADPHONES jack.

Any low or high impedance stereo headphones can be connected.

Adjust the sound volume with the PHONE LEVEL control.



TREBLE and BASS control

Adjust the tone to your preference.

for less treble



for less bass



BALANCE control

Adjust the amount of sound coming from each paired speaker, if required.

to increase the left speaker volume



to increase the right speaker volume

TONE ENHANCE button

To enhance bass and treble sounds, press this button to set to ON.

Use the TONE ENHANCE system when listening to music at a low volume.

To disengage the TONE ENHANCE, press this button again to set to OFF.

The BASS, TREBLE, BALANCE and TONE ENHANCE settings affect the sound from the headphones or from the MONITOR 1, MONITOR 2 and MULTI OUTPUT connectors.

REMOTE CONTROL OPERATION

Once the MASTER button has been switched on, you can remotely control the TV tuner with the supplied RM-705 Remote Commander up to 7 meters (23 feet) away from the TV tuner and within approx. 30 degrees from the center.

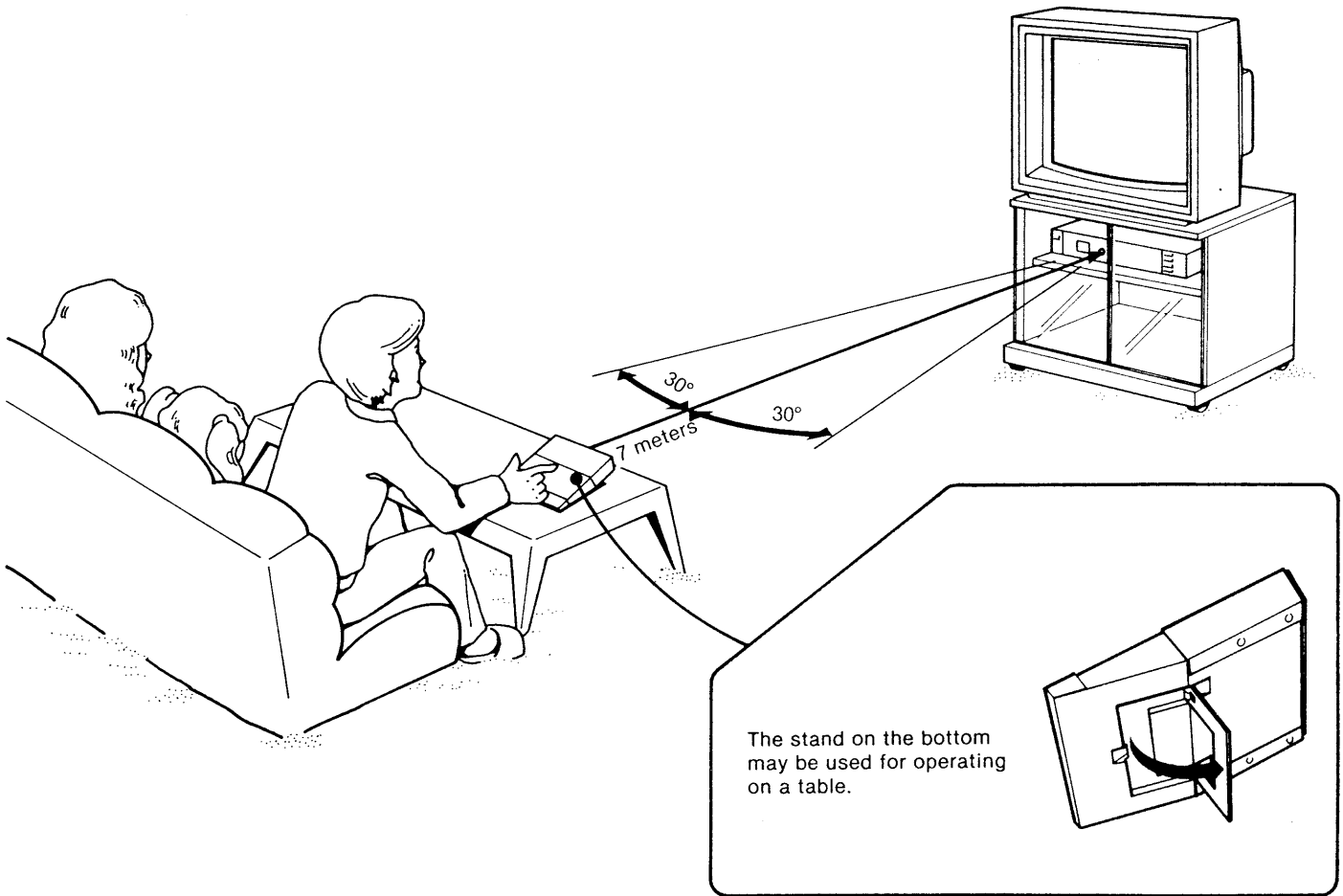

Caution: Make sure that nothing is connected to the CONTROL IN jack on the rear.

Battery installation

The RM-705 operates on two supplied AA batteries (IEC Designation R6).

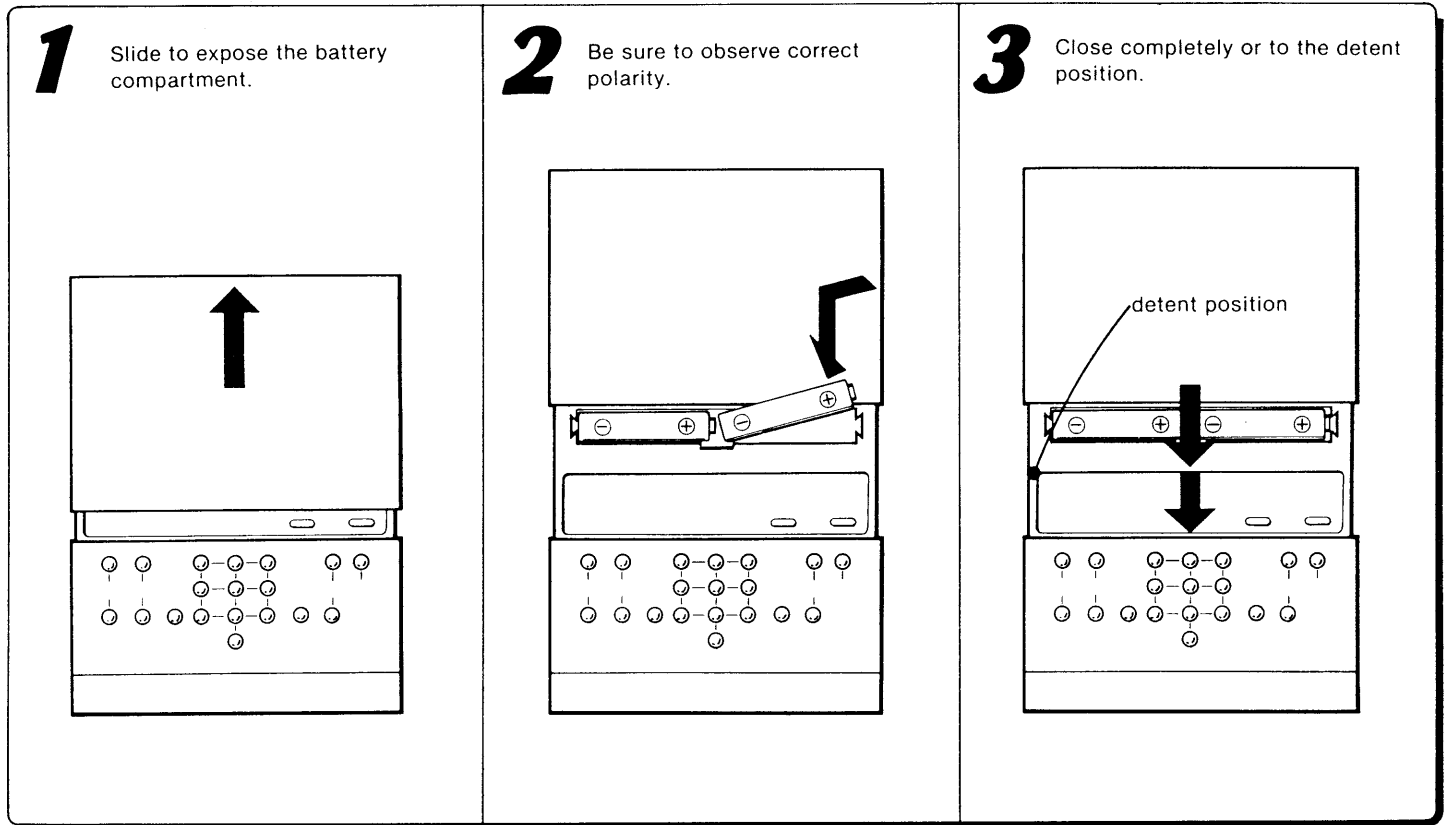

Function of keys and buttons on the Remote Commander

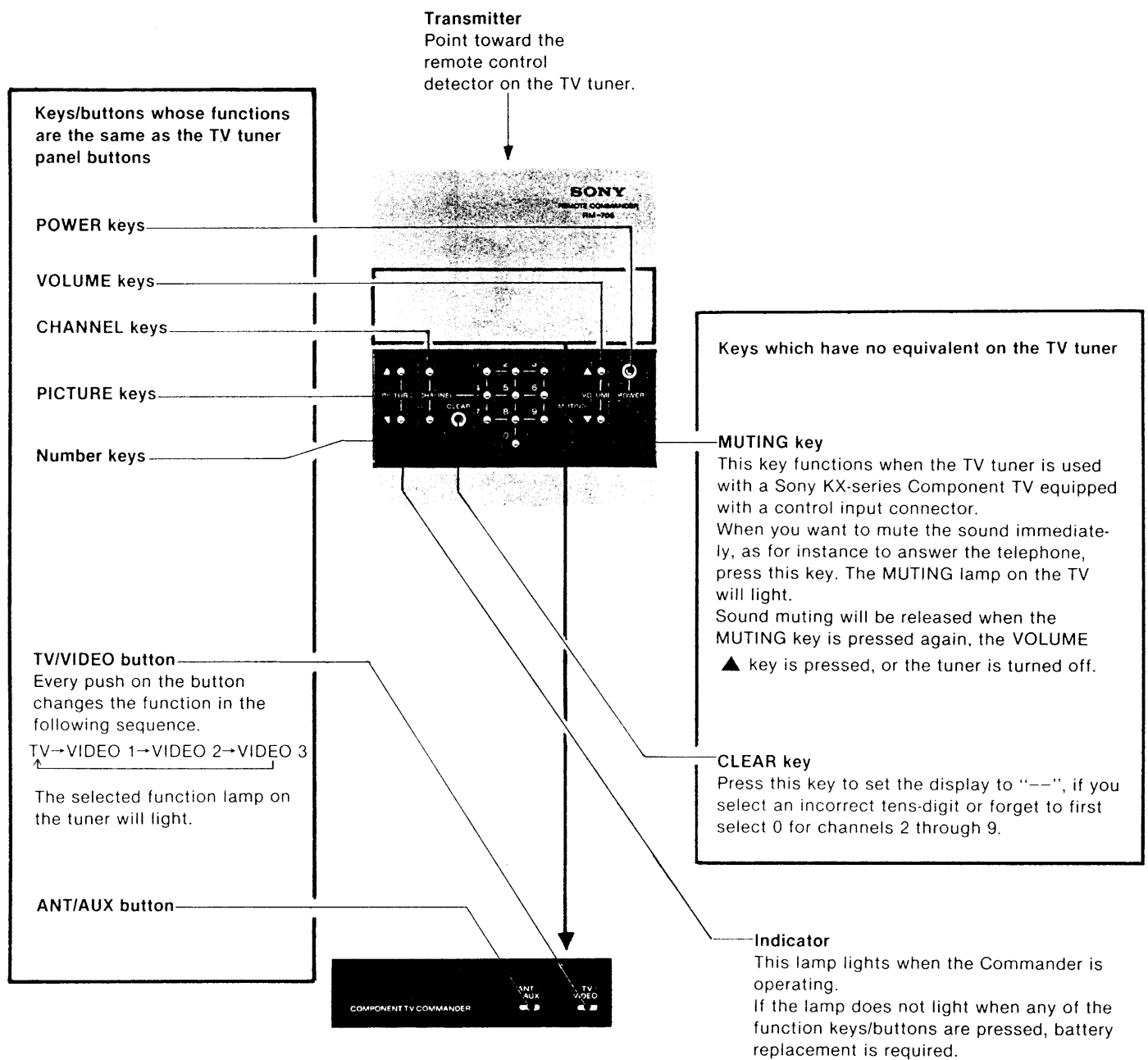

Operation of the Remote Commander

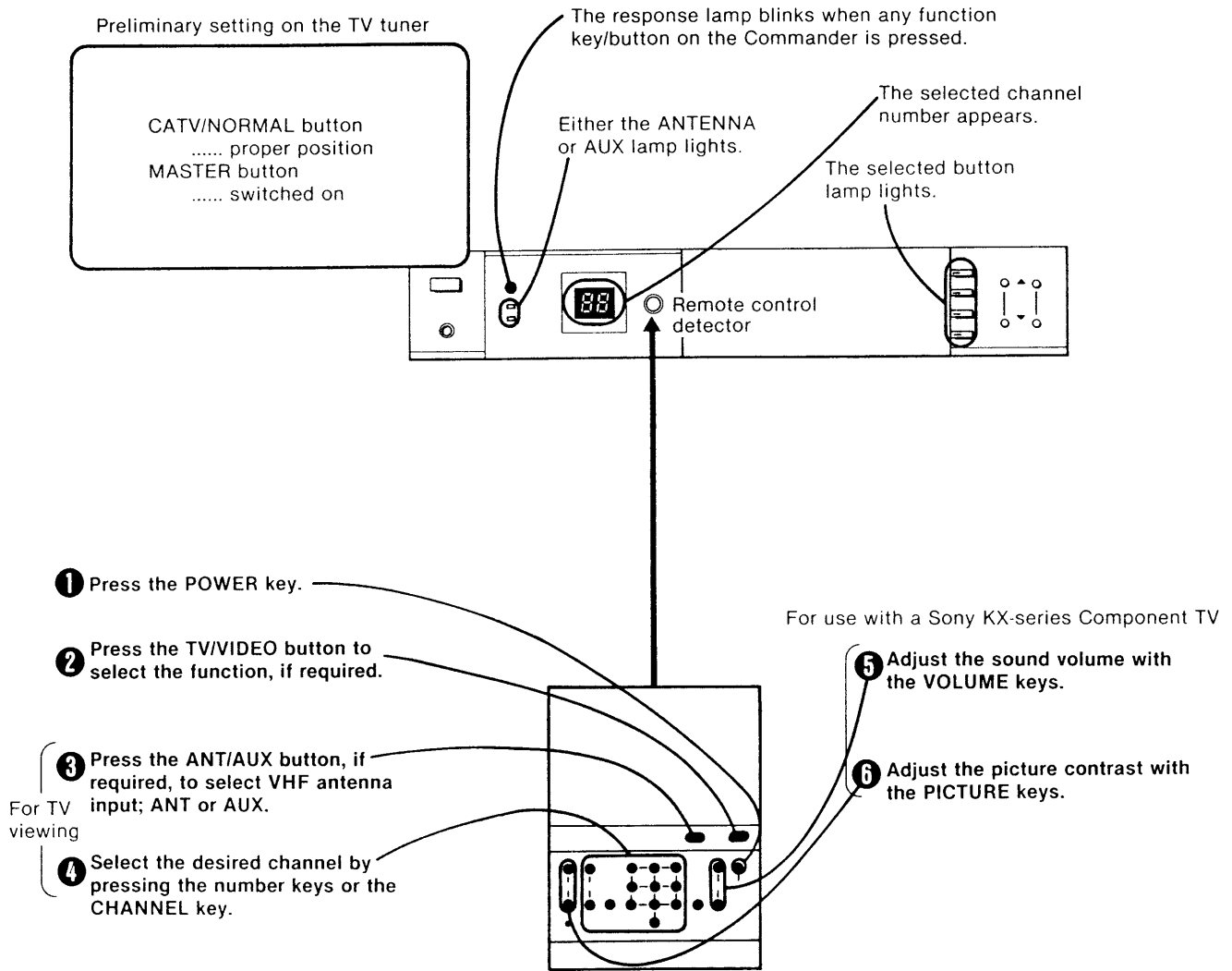

Notes on the Remote Commander

- In normal operation, battery life is up to half a year. When the battery is exhausted, the Commander will not operate the TV tuner properly. In this case, replace the batteries with new ones.
- When the Commander is not used for a long period of time, remove the batteries to avoid damage from possible battery leakage.
- Keep the Commander away from extremely hot or humid places.
- Avoid dropping any foreign objects into the Commander case when replacing batteries.
- To avoid a malfunction, do not simultaneously depress two or more buttons.
- The RM-705 Commander may be used only with those Sony models indicated in the operating instructions.

CHANNEL PRESETTING — How to preset the channels to be scanned with the CHANNEL keys.

Your TV tuner has been set at the factory to receive VHF channels 2 through 13 in sequence when you press the CHANNEL keys. You can add UHF or CATV channels and erase inactive VHF channels so that only the channels available in your area will appear in the sequence.

To add UHF or CATV channels

<p>1</p> <p>Set the CATV/NORMAL button to NORMAL (released position) for UHF and to CATV (depressed position) for CATV channels. (Either position will do for VHF.)</p>	<p>2</p> <p>Press the ANT/AUX button, if required, to select VHF antenna input; ANT or AUX.</p>	<p>Check that the TV button is selected.</p>
--	---	---

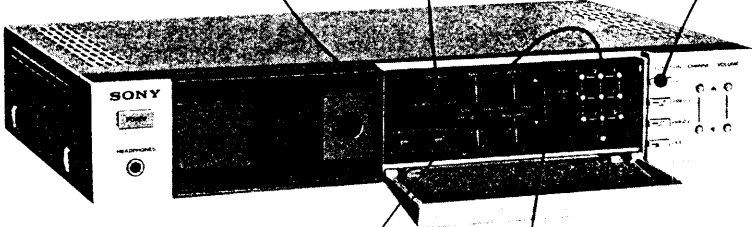

<p>3</p> <p>Select the channel number to be added with the number keys.</p>	<p>4 Press the ADD key.</p>  <p>↓</p> <p>Number of channel added</p> <p>This channel has now been added.</p>	<p>REPEAT THE ABOVE FOR ALL THE CHANNELS TO BE ADDED.</p> <p>The channels will be entered in numerical sequence regardless of the adding sequence.</p> <p>If you have any problem on CATV channel presetting, consult the CATV company in your area.</p>
--	---	--

To erase inactive channels

<p>1</p> <p>Set the CATV/NORMAL button to NORMAL (released position) for UHF and to CATV (depressed position) for CATV channels. (Either position will do for VHF.)</p>	<p>2</p> <p>Press the ANT/AUX button, if required, to select VHF antenna input; ANT or AUX.</p>
--	--

Check that the TV button is selected.

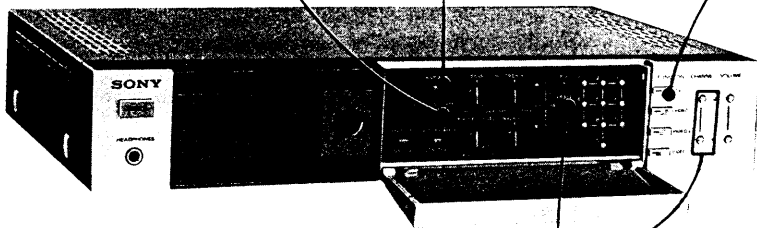

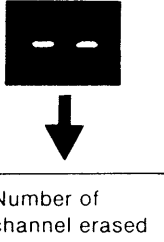
<p>3</p> <p>Select the channel to be erased with the CHANNEL keys.</p>	<p>4 Press the ERASE key.</p>  <p>Number of channel erased</p> <p>This channel has now been erased.</p>
---	---

REPEAT THE ABOVE FOR ALL THE CHANNELS TO BE ERASED.

Operating note: It is not possible to erase a UHF channel from the memory and retain the CATV channel of the same number in the memory, or vice versa. If either the UHF channel or the CATV channel of the same number is to be kept in the memory, do not erase the number.

FUNCTION OF REAR PANEL CONNECTORS

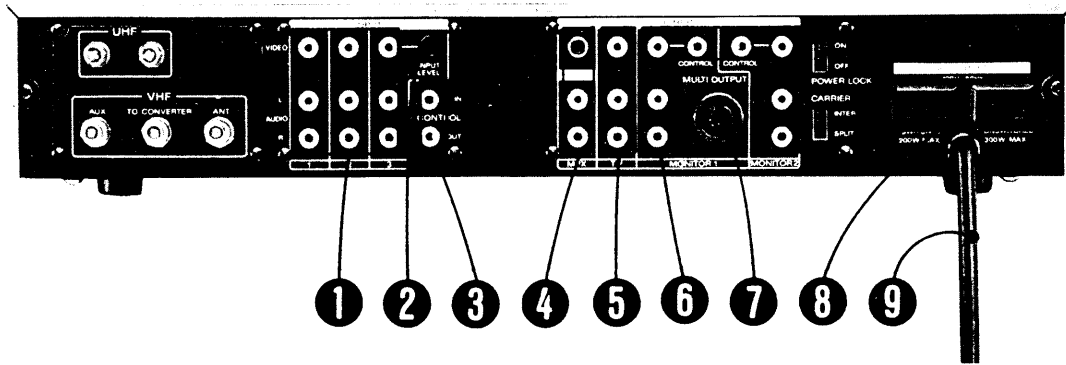

1 INPUT 1, 2 and 3





VIDEO jack (phono jack, yellow)

Connect to the video output of a video tape recorder. Input level of the video signal from the INPUT 3 jack can be adjusted with the INPUT LEVEL control.

AUDIO jacks (phono jacks, L-white, R-red)

Connect to the audio outputs of a video tape recorder. Connect the L and R channels properly. If the recorder is monaural, connect the audio output of the recorder to the L channel. The signal will be obtained from both L and R output channels. (If the signal is connected to the R channel, it will be obtained from only R output channel.)

● **To select the input**, press the desired FUNCTION button on the front panel or the TV/VIDEO button on the Remote Commander. The selected button lamp will light.

-  TV for antenna inputs
-  VIDEO 1 for INPUT 1
-  VIDEO 2 for INPUT 2
-  VIDEO 3 for INPUT 3

2 INPUT LEVEL control

Adjusts the level of the video signal from the VIDEO INPUT 3 jack. Normally set to the center detent position.

If the picture contrast is too weak or too strong, adjust the level (min. 0.5V p-p, max. 2V p-p) by turning the control clockwise or counterclockwise with a screwdriver so that both the TV and video programs are viewed at approximately the same contrast level when the PICTURE keys are in the same position.

3 CONTROL IN/OUT jacks (minijacks)

These jacks allow eventual expansion of your audiovisual system. When an external control unit is connected to the CONTROL IN jack, the TV tuner cannot be operated with the Remote Commander.

4 MPX INPUT/OUTPUT jacks (phono jacks)

These jacks allow a special adaptor to be connected for any future multichannel sound (stereo, bilingual, etc.) TV broadcasts.

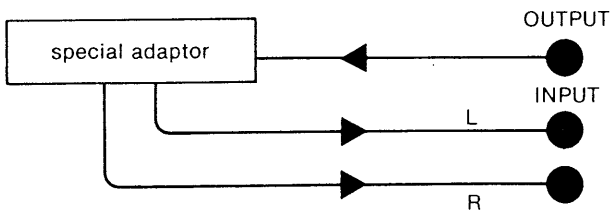

5 TV OUTPUT

VIDEO jack (phono jack, yellow)

To record TV programs on a video tape recorder not equipped with a TV tuner, connect this jack to the video input of the recorder. A video projection system may be connected here so that you can enjoy TV programs on a large screen.

The TV video signal is available irrespective of the FUNCTION setting. The PICTURE keys do not affect these outputs.

AUDIO jacks (phono jacks, L-white, R-red)

To record TV programs on a video tape recorder not equipped with a TV tuner, connect these jacks to the audio inputs of the recorder. An amplifier may also be connected for more audio power.

The TV audio signal is available irrespective of the FUNCTION setting. The VOLUME keys, MUTING key, TONE ENHANCE button, BALANCE, BASS and TREBLE controls do not affect these outputs.

6 MONITOR 1 and 2 OUTPUT

VIDEO jack (phono jack, yellow)

Connect to the video input of a monitor TV or a video projection system.

The signal selected with the FUNCTION button is then available.

AUDIO jacks (phono jacks, L-white, R-red)

Connect to the audio inputs of a monitor TV or a video projection system.

The signal selected with the FUNCTION button is then available.

CONTROL jack (minijack)

When the TV tuner is used with a Sony KX-series Component TV equipped with a control input connector, connect as illustrated with the RK-69A Connecting Cord (optional).

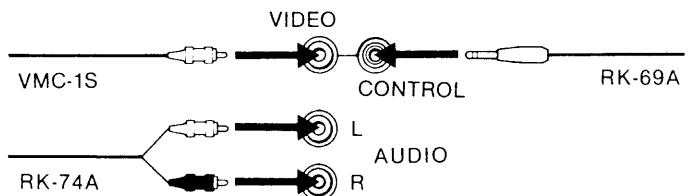

The Component TV volume and picture can be adjusted and the TV turned on and off using the controls on the TV tuner or the Remote Commander.

7 MONITOR 1 MULTI OUTPUT connector (8-pin DIN)

Connect to the MULTI INPUT (8-pin DIN) connector on a Sony KX-series Component TV with the supplied VK-2D Video Cable (2 m). The VK-5DX Video Cable for extension (5 m) is available optionally. The signals selected with the FUNCTION button are available. The Component TV volume and picture can be adjusted and the TV turned on and off using the controls on the TV tuner or the Remote Commander.

Caution: You may use the MONITOR 1 and MONITOR 2 jacks, or MULTI OUTPUT connector and MONITOR 2 jacks, simultaneously. However, do not use the MONITOR 1 VIDEO/AUDIO/CONTROL jacks and the MULTI OUTPUT connector simultaneously.

Connections for FM simulcast TV programs

To receive FM simulcast TV programs (stereo sound transmitted from an FM radio station), connect as illustrated.

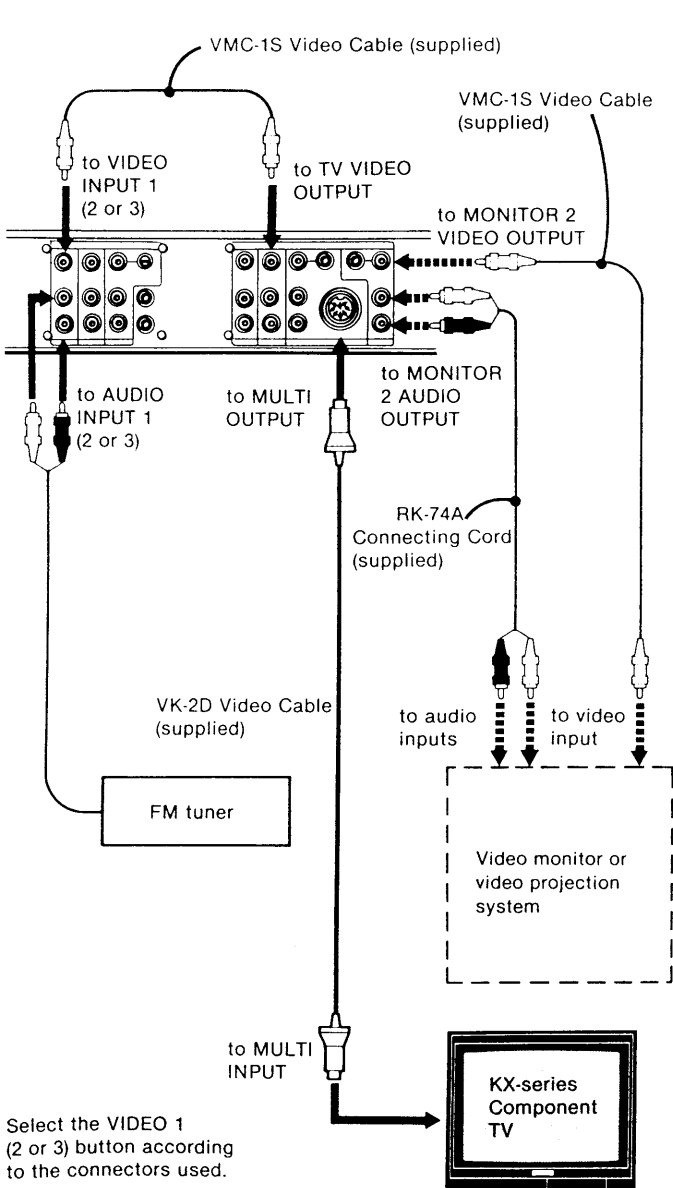

8 AC OUTLET SWITCHED

Provides ac power of 200W max. to other connected equipment. Power can be switched on and off with the POWER button/key on the TV tuner or the Remote Commander.

UNSWITCHED

Provides ac power of 300W max. to other connected equipment. Power is not controlled with the POWER button/key.

Caution: Do not connect electrical home appliances such as an electric iron, fans, or other high-wattage equipment to these outlets.

9 AC power cord

Connect to a convenient 120V ac wall outlet.

Caution: Do not connect this power cord to the SWITCHED AC OUTLET of a Sony KX-series Component TV. If you do, the control on the TV tuner or the Remote Commander will not turn the TV on and off.

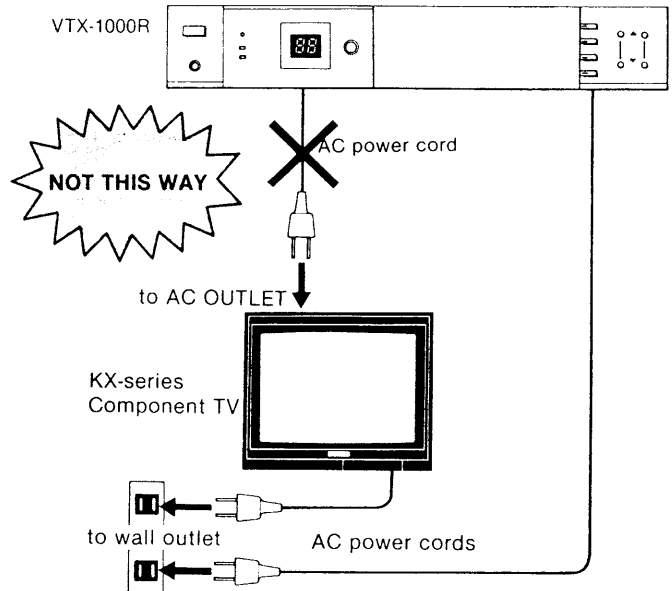

ANTENNA/CABLE CONNECTION

If your local signal is strong, an indoor antenna may be sufficient to obtain a clear picture.

The use of an external antenna is recommended especially in difficult reception areas (inside steel-frame buildings, in mountainous areas, or at great distances from the transmitter).

75-ohm antenna

When the cable is a 75-ohm coaxial type (round)

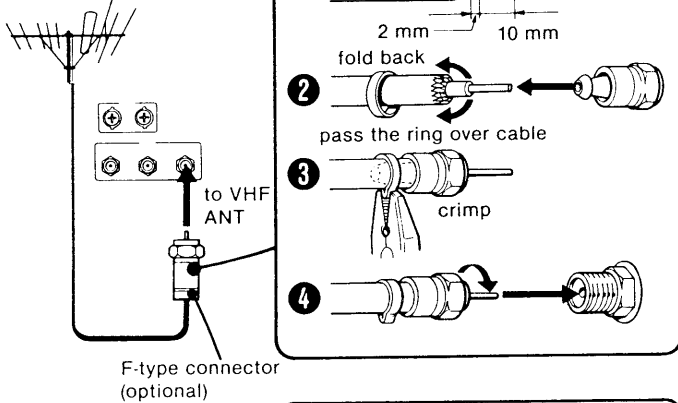

When the cable is a 300-ohm ribbon type lead-in (flat)

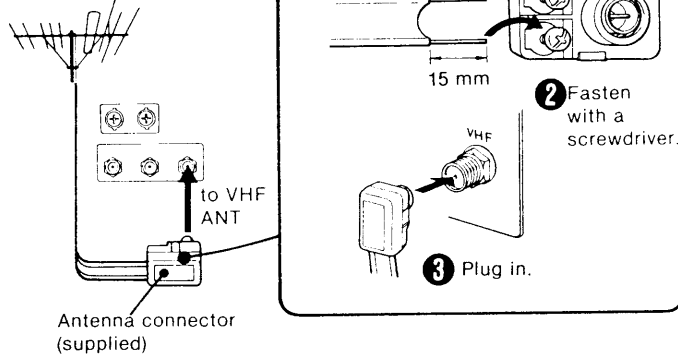

UHF antenna

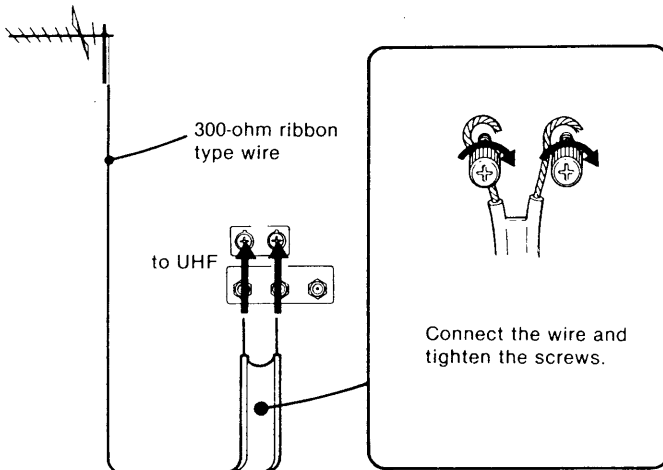

Combination VHF/UHF antenna

Most combination antennas already have a signal splitter. If you need a splitter or a complete antenna system, see your Sony dealer or a qualified technician.

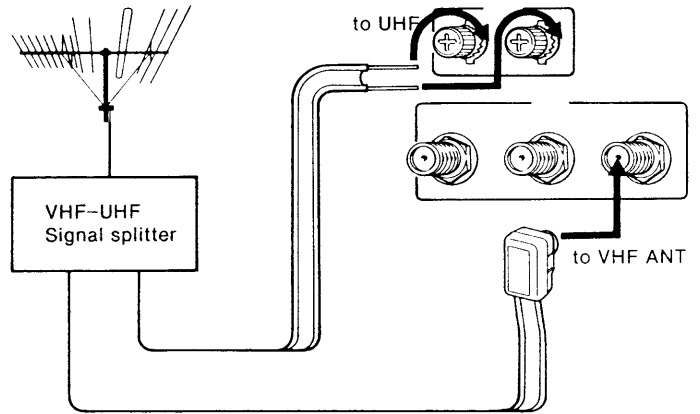

CATV cable without a channel converter

We recommend that you consult your cable company to make sure that the cable is properly connected.

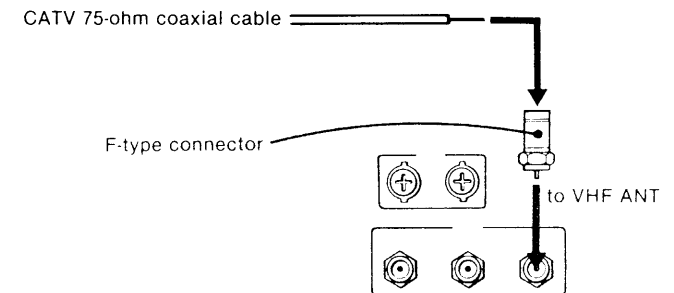

CATV cable with a special channel converter

Pay cable TV systems use scrambled or encoded signals and require special converters. (The converter is supplied by the cable company.)

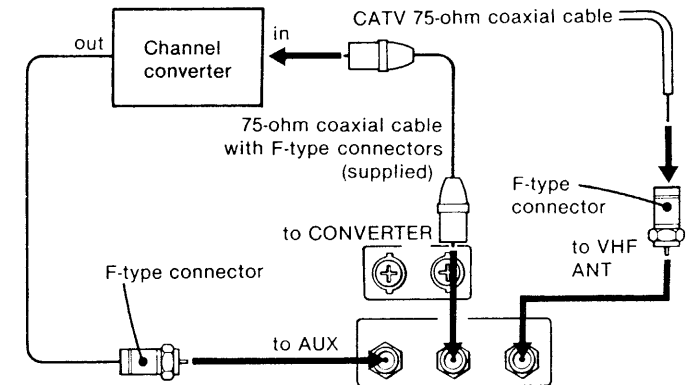

Notes on selection of the VHF antenna inputs

For converted pay cable TV signals from the AUX terminal, press the ANT/AUX button to set to AUX. The green AUX lamp will light. For normal VHF or CATV signals from the VHF ANT terminal, press the ANT/AUX button again to set to ANT. The green ANTENNA lamp will light.

SPECIFICATIONS

Television system	American TV standards
Channel coverage	VHF channels 2-13 UHF channels 14-83 CATV mid-band channels A-I super-band channels J-W
Antenna	75-ohm antenna terminals for VHF ANT, CONVERTER and AUX 300-ohm antenna terminals for UHF
Inputs	VIDEO INPUT 1, 2, and 3 (phono jack) 1V p-p, NTSC, 75 ohms, unbalanced, sync negative AUDIO INPUT 1, 2 and 3 (2 phono jacks) -5 dBs (436 mV rms), 47 kilohms CONTROL IN (minijack) 5V p-p MPX IN (2 phono jacks) -5 dBs (436 mV rms), 47 kilohms
Outputs	TV, MONITOR 1 and 2 VIDEO OUTPUT (phono jack) 1V p-p, NTSC, 75 ohms, unbalanced, sync negative TV, MONITOR 1 and 2 AUDIO OUTPUT (2 phono jacks) -5 dBs, (436 mV rms), 5 kilohms MONITOR 1 and 2 CONTROL OUTPUT (mini jack) 5V p-p MULTI OUTPUT (8-pin DIN) Same as the above MONITOR 1 and 2 VIDEO OUTPUT, AUDIO OUTPUT and CONTROL OUTPUT CONTROL OUT (mini jack) 5V p-p MPX OUT (phono jack) 70 mV rms ± 3 dB, load impedance 50 kilohms (main channel 400 Hz, 100% modulation) 50 Hz-55 kHz, within $^{+0}_{-2}$ dB Positive polarity HEADPHONES (stereo binaural jack) Accepts low and high impedance stereo headphones
Power requirements	120V ac, 60Hz
Power consumption	20W (max.) 18W (average) 4.5 W (in standby condition)
AC outlet	Switched: max. 200W Unswitched: max. 300W
Dimensions	Approx. 430 x 80 x 277 mm (w/h/d) (17 x 3 ¹ / ₈ x 11 inches) incl. projecting parts and controls
Weight	Approx. 5 kg (11 lb)
Accessories supplied	Remote Commander RM-705 Antenna connector (300-75 ohm matching transformer is built-in) 75-ohm coaxial cable with F-type connector (1.5 m) Connecting Cord RK-74A (2 phono plugs to 2 phono plugs, 1.5 m) Video Cable VMC-1S (phono plug to phono plug, 1.2 m) 2 pcs. Video Cable VK-2D (8-pin DIN plug to 8-pin DIN plug, 2 m)

Remote Commander

Remote control system	Infrared control
Power requirements	3V dc Battery size AA x 2 (IEC Battery Designation R6)
Dimensions	Approx. 120 x 24 x 142 mm (w/h/d) (4 ³ / ₄ x 1 x 5 ⁵ / ₈ inches)
Weight	Approx. 282 g (10 oz) incl. batteries.
Accessory supplied	Battery size AA 2 pcs.

Design and specifications subject to change without notice.

OPTIONAL UNITS/ACCESSORIES

Trinitron Component TV KX-1901, KX-2501
Remote Commander RM-705
Speaker System SS-XIA, SS-X10A
Betamax Videocassette Recorder SL-2000, SL-5000
Connecting Cord RK-69A (miniplug to miniplug, 1.2 m)
Video Cable VK-2D (8-pin DIN plug to 8-pin DIN plug, 2 m)
VK-5DX (8-pin DIN socket to 8 pin DIN plug, 5 m)

Free Manuals Download Website

<http://myh66.com>

<http://usermanuals.us>

<http://www.somanuals.com>

<http://www.4manuals.cc>

<http://www.manual-lib.com>

<http://www.404manual.com>

<http://www.luxmanual.com>

<http://aubethermostatmanual.com>

Golf course search by state

<http://golfingnear.com>

Email search by domain

<http://emailbydomain.com>

Auto manuals search

<http://auto.somanuals.com>

TV manuals search

<http://tv.somanuals.com>