

Digital Audio Tape Deck

Operating Instructions

DAT
Digital Audio Tape
DTC-690

WARNING

Operating Instructions

Before operating the unit, please read this manual thoroughly and retain it for future reference.

Owner's Record

The model number is located on the rear exterior and serial number is on the rear. Record the serial number in the space provided below. Refer to these numbers whenever you call upon your Sony dealer regarding this product.

Model No. DTC-690

Serial No. _____

WARNING

To prevent fire or shock hazard, do not expose the unit to rain or moisture.

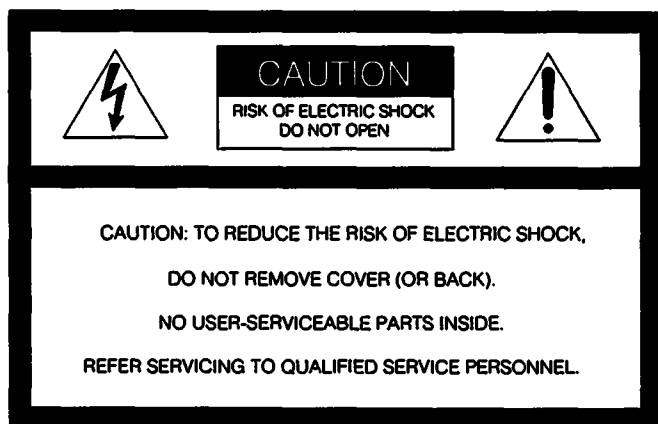

This symbol is intended to alert the user to the presence of uninsulated "dangerous voltage" within the product's enclosure that may be of sufficient magnitude to constitute a risk of electric shock to persons.



This symbol is intended to alert the user to the presence of important operating and maintenance (servicing) instructions in the literature accompanying the appliance.

* The graphical symbols are on the rear enclosure.

INFORMATION (For the customers in the U.S.A.)

This equipment has been tested and found to comply with the limits for a Class B digital device, pursuant to Part 15 of the FCC Rules. These limits are designed to provide reasonable protection against harmful interference in a residential installation. This equipment generates, uses, and can radiate radio frequency energy and, if not installed and used in accordance with the instructions, may cause harmful interference to radio communications. However, there is no guarantee that interference will not occur in a particular installation. If this equipment does cause harmful interference to radio or television reception, which can be determined by turning the equipment off and on, the user is encouraged to try to correct the interference by one or more of the following measures:

- Reorient or relocate the receiving antenna.
- Increase the separation between the equipment and receiver.
- Connect the equipment into an outlet on a circuit different from that to which the receiver is connected.
- Consult the dealer or an experienced radio/TV technician for help.

You are cautioned that any changes or modifications not expressly approved in this manual could void your authority to operate this equipment.

For the customers in Canada

This apparatus complies with the Class B limits for radio noise emissions set out in Radio Interference Regulations.

CAUTION: _____
TO PREVENT ELECTRIC SHOCK, DO NOT USE THIS POLARIZED AC PLUG WITH AN EXTENSION CORD, RECEPTACLE OR OTHER OUTLET UNLESS THE BLADES CAN BE FULLY INSERTED TO PREVENT BLADE EXPOSURE.

Table of Contents

Before using the DAT deck

Warning	2
Digital audio tape	3
Precautions	4
Features	4
Location and function of controls	5
Front panel/remote commander	5
Remote commander operation	9
Installing batteries	9
Display window	10
Rear panel jacks	14
Connections	15
Connecting cords	15
Connection examples	16
Cassette loading	18

Recording

Before recording	19
Blank section and sound muted portion	19
Absolute time codes	20
Recording	21
Recording level adjustment (for analog input signals only)	23
Long play mode	24
Creating a sound muted portion (Record muting)	25
End search	26

Writing sub codes

Sub codes	27
Start ID	30
Writing automatically during recording	30
Writing manually during recording	31
Writing manually during playback (Rehearsal function)	32
Adjusting the position	33
Erasing	33
Program numbers	34
Writing automatically during recording	34
Renumbering	36
Erasing	37
Skip ID	38
Writing during recording	38
Writing during playback (Rehearsal function)	38
Erasing	39
End ID	40
Writing during recording	40
Writing during playback (Rehearsal function)	41
Erasing	42

Playback

Playback	43
Display window	44
Various playback operations	45
Repeat play	45
Automatic music sensor operation	46
Music scan	47
Designating the desired selection	48
Skip play	49
Auto play: restarting playback after rewinding	49
Random music sensor (RMS) operation	50
Timer activated operation	51
Timer activated recording	51
Timer activated playback	52

Additional Information

Maintenance	53
Cleaning the cabinet	53
Cleaning the head	53
Guide to the serial copy management system	54
Troubleshooting guide	56
Specifications	59

Digital Audio Tape

DAT (Digital Audio Tape) is a new recording system which digitalizes the audio signal and records it on a DAT cassette tape.

DAT records the audio signal by converting the analog sound into a digital signal. This converting system is called the PCM (Pulse Code Modulation), and its accurate processing of the audio signal allows recording/playback with lower wow and flutter, wider dynamic range, lower distortion rate, and superb signal-to-noise ratio.

In addition, various control codes called sub codes can be written on the DAT cassette separately from the audio signal. They are written for a variety of convenient playback/tape editing operations, and except for the absolute time, can be rewritten after audio signal recording has been completed.

Precautions

On safety

- Operate the unit only on 120 V AC, 60 Hz.
- The unit is not disconnected from the AC power source (mains) as long as it is connected to the wall outlet, even if the unit itself has been turned off.
- Should any solid object or liquid fall into the cabinet, unplug the unit and have it checked by qualified personnel before operating it any further.
- Unplug the unit from the wall outlet if it is not to be used for an extended period of time. To disconnect the cord, pull it out by grasping the plug. Never pull the cord itself.
- AC power cord must be changed only at the qualified service shop.

Operation

Before making program source connections, be sure to unplug the unit.

Installation

Do not install the unit in a location near heat sources such as radiators or air ducts, or in a place subject to direct sunlight, excessive dust, mechanical vibration or shock.

Moisture Condensation

If the unit is brought directly from a cold to a warm location, moisture may condense inside the unit. In this condition, the tape may adhere to the head drum and be damaged, or the unit may not operate correctly. Always remove the cassette when the unit will not be used.

If moisture is present...

- Function controls will not operate.
- All operations will stop.

When the CAUTION indicator lights and the unit will not operate

Leave the unit turned on for about an hour.

NOTE

When closing the cassette compartment, do not push the cassette lid forcibly by hand, but perform with the \blacktriangle OPEN/CLOSE button.

For the customers in the U.S.A.

For detailed safety precautions, see the "IMPORTANT SAFEGUARDS" leaflet.

If you have any question or problem concerning your unit, please consult your nearest Sony dealer.

Features

Serial copy management system (SCMS)

This unit utilizes the serial copy management system that permits digital-to-digital recording for one generation. You can record CD sound or other digital formats through a digital-to-digital connection. (See page 54.)

Three sampling frequencies

Recording/playback can be done with three sampling frequencies (48 kHz, 44.1 kHz and 32 kHz).

48 kHz: For analog and digital input signals in a standard mode

44.1 kHz: For compact disc and pre-recorded DAT tape

32 kHz: For analog input signals in a long-play mode

Long play mode

This unit can operate in a long-play mode. Analog input signals can be recorded or playback for up to four consecutive hours when the DT-120 DAT cassette tape is used. The sampling frequency will be 32 kHz in the long-play mode.

Visible cassette loading

You can view the tape operation through the lid of the cassette compartment. Due to a revolutionary new transport mechanism, cassette loading time has been significantly reduced.

Excellent sound quality

1-bit A/D converter

For the A/D converter section which converts analog input signals to digital signals, the unit employs a 1-bit A/D converter which theoretically generates no zero-cross distortion for a clear, elegant sound quality.

Pulse D/A converter

Superior playback performance is achieved with a pulse D/A converter.

Rich variety of subcode information

This unit can record subcode information such as Start IDs, program numbers, Skip IDs, and absolute time data, enabling you to quickly locate tunes and display the playback time in the same manner as when playing compact discs.

Post edit recording of sub codes

You can record or rewrite the following sub codes after the audio signal recording has been completed.

Start ID: Signifies the beginning of a selection.

Program number: Gives a number to the selection.

Skip ID: Signifies the beginning of a portion to be skipped

End ID: Signifies the end position of recording/playback

Since sub codes are written on the tape separately from audio signals, the audio signals are not affected.

Location and Function of Controls

Refer to the pages indicated in parenthesis for details.

Front Panel/Remote Commander **A**

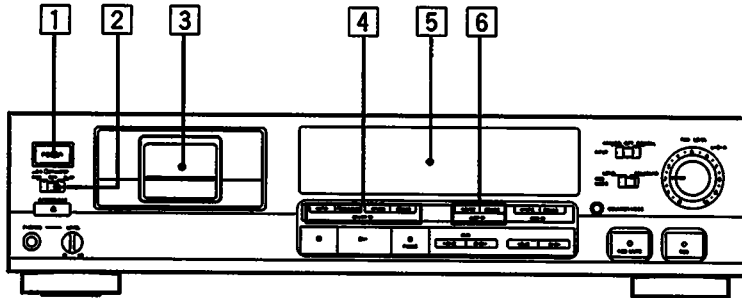

- 1** POWER button
Turns the power on and off.
- 2** TIMER switch
Normally set to the OFF position. When recording or playing back at the desired time using a commercially available audio timer, set to the REC position or the PLAY position respectively. (51)
- 3** Cassette compartment
Insert a cassette with the window side up and the safety tab facing you. (18)
- 4** START ID buttons
AUTO: Press to turn on and off the AUTO indicator. When the AUTO indicator is lit, the start ID will automatically be written during recording. When the AUTO indicator is not lit, press the START ID WRITE button at the point where you want to write a start ID. (30)
WRITE: Press to write the start ID at the desired point during recording or playback. (31)
ERASE: Press to erase a start ID. When a start ID and a program number are written on the tape, both codes are simultaneously erased by pressing this button. (33)
RENUMBER: Press to renumber all programs on the tape. When only the start IDs are written, pressing this button will insert the proper program numbers beginning with "1". The tape will rewind and start from the beginning to accomplish this function. (36)
- 5** Display window
- 6** SKIP ID buttons
WRITE: Press at the beginning of the portion you may wish to skip later. A skip ID will be written from the point where you pressed this button. (38)
ERASE: Press to erase the nearest skip ID which is before the current position. (39)

Location and Function of Controls

A

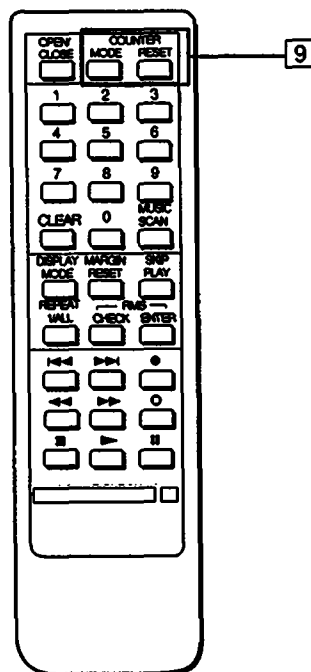
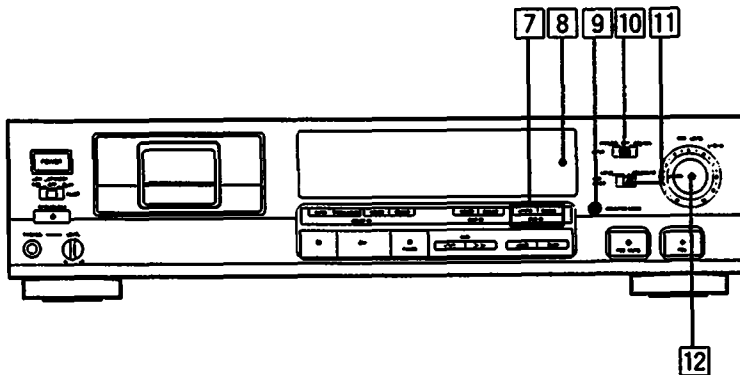

- 7** END ID buttons
WRITE: Press to write the ID signifying the end of playback or recording. (40)
ERASE: Press to erase the end ID. (42)
- 8** Remote sensor
 Receives the signal from the remote commander.
- 9** COUNTER MODE button
 Selects the display mode among the absolute time, remaining time to the end of whole tape and linear counter (tape running time). Each time you press the button, the display changes sequentially. (44)
RESET button (only with the remote commander)
 Resets the linear counter to "0M 00S". (44)
- 10** INPUT selector
 Set according to the signal to be recorded (21)
ANALOG: For recording from the equipment connected to the LINE IN jacks.
OPT: For recording from the equipment connected to the DIGITAL IN (OPTICAL) jack.
COAXIAL: For recording from the equipment connected to the DIGITAL IN (COAXIAL) jack.
- 11** REC MODE selector
 Normally set to the STANDARD position
 When this selector is set to the LONG position, you can record analog input signals or digital signals with 32 kHz in the long-play mode (21, 24)
- 12** REC LEVEL (recording level) controls
 Adjust the recording levels and balance for the analog input signals.
 The outer knob controls the L (left) channel level and the inner knob the R (right) channel level. The knobs can be adjusted together. To adjust each channel independently, turn the knob while holding the other knob.
 When recording digital signals, it is not necessary to adjust the recording levels. (21, 23)

Location and Function of Controls

A

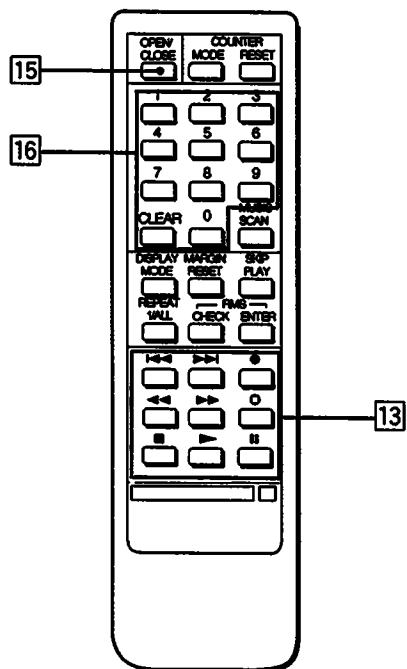
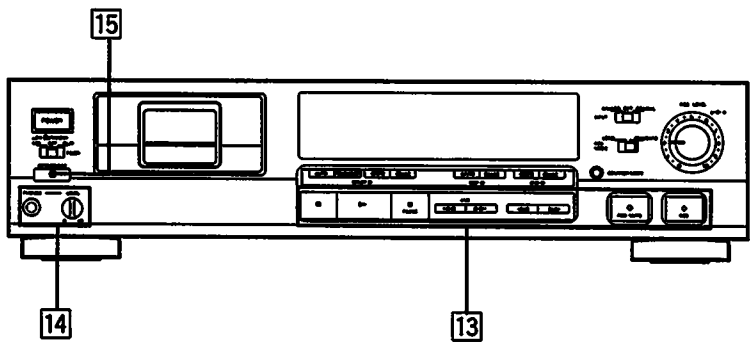

- 13** Tape operating buttons
- (stop): Press to stop recording or playback.
 - ▶ (play): Press to start playback or recording.
 - ⏸ (PAUSE (pause): Press to stop for a moment during recording or playback. To restart recording or playback, press this button again or press the ▶ button.
If the unit is left in the pause mode for about 10 minutes, it will automatically be released and the deck will enter the stop mode. To restart recording or playback from the stop mode, press the ●REC or ▶ button respectively.
 - ⏮/▶ (AMS): Press to locate the beginning of the selection during playback or in the stop mode.
 - ◀/▶ (rewind/review, fast-forward/cue): In the stop mode, press to rewind/fast-forward the tape.
During playback, press to rewind or fast-forward the tape while listening to the sound.
 - REC MUTE (record muting): Inserts a sound-muted portion (space).
 - REC (recording): Press to enter the record-pause mode. After pressing this button, press the ⏸ pause or ▶ button.
- 14** PHONES jack and LEVEL control
Insert the headphones plug to this jack and turn the control to adjust the headphones volume level. (43)
- 15** ▲OPEN/CLOSE button
Press to open or close the cassette compartment. (18)
This button does not function during recording or in the record muting mode.
- 16** Numeric buttons (0-9) and CLEAR button
Designate the desired program number to be played back before starting playback. Designate the desired number in the record-pause mode, the program number is written consecutively from the designated number. (35)
Press the CLEAR button to cancel the program number which has been mistakenly entered.

Location and Function of Controls

A

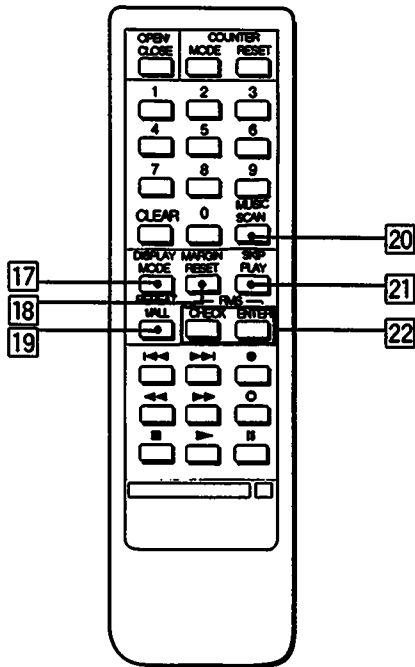

- 17** DISPLAY MODE button
Changes the display mode. (10)
- 18** MARGIN RESET button
Press to reset the margin of peak level
"- -" appears at the MARGIN display
(23)
- 19** REPEAT 1/ALL button
Press to play a desired portion
repeatedly. Each time you press the
button, the indicator changes as
follows:
REPEAT 1 → REPEAT ALL → off (45)
- 20** MUSIC SCAN button
Press to listen to the beginning of each
selection successively. (47)
- 21** SKIP PLAY button
Press to activate the skip ID code
function. The portion of the tape
previously marked will be skipped (49)
- 22** RMS play buttons
ENTER: To program the selections in a
desired order, press this button after
pressing the numeric buttons. (50)
CHECK: Press to check the
programmed contents (50)

Location and Function of Controls

B

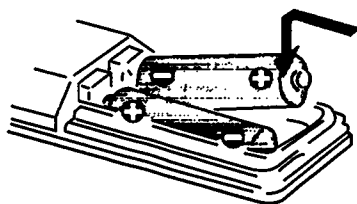
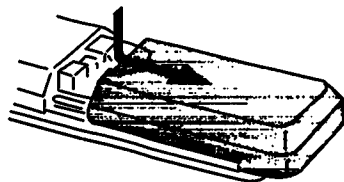

Insert two size AA (R6) batteries with correct polarity, and close the lid.

Remote Commander Operation

Each button on the remote commander functions in the same way as those having the same name on the front panel. However, the following operations cannot be performed using the remote commander. Use the front panel controls instead.

- Turning the power on and off
- Selecting digital(optical/coaxial)/analog input source
- Adjusting the recording level and balance
- Adjusting the headphones level
- Setting the timer recording/playback
- Selecting the record mode (standard or long)
- Writing and erasing a start ID, skip ID and end ID.

The following operations can be performed only with the remote commander.

- Repeat play
- Skip play
- RMS* play
*RMS: Random Music Sensor
- Designating and canceling a program number.
- Resetting the linear counter to "0 M 00S"
- Resetting the margin of peak level.
- Changing the display mode.

Installing Batteries **B**

Notes on remote control

- Do not expose the remote sensor on the deck to strong light such as direct sunlight, lighting apparatus, etc.
- Do not place any obstructions between the remote commander and the remote sensor, or else operations will not be performed correctly.
- The controllable range is limited. Point the remote commander directly at the remote sensor on the deck.
- When remote control operation distance becomes shorter, the batteries are weak. Replace both batteries with new ones.

To avoid battery leakage

When the commander will not be used for a long period of time, remove the batteries to avoid damage caused by battery leakage and corrosion.

Battery life

About half a year of normal operation can be expected when using the Sony SUM-3 (NS) batteries.

Location and Function of Controls

Display Window

To turn off the display window

When the power is turned on, the display window also is turned on. During recording or playback, all display or some parts of the display can be turned off as follows:

This operation can be performed only with the remote commander.

Each time you press the DISPLAY MODE button, the display changes as follows:

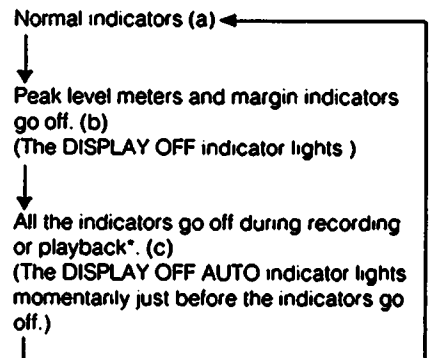

* When pressing the DISPLAY MODE button except during recording or playback, the DISPLAY OFF AUTO indicator lights. In this case, all the indicators go off immediately after recording or playback starts

To change the brightness of the display window

While pressing the COUNTER MODE button, press one of the numeric buttons 1, 2 and 3 on the remote commander. The greater number pressed, the darker the display window becomes.

C

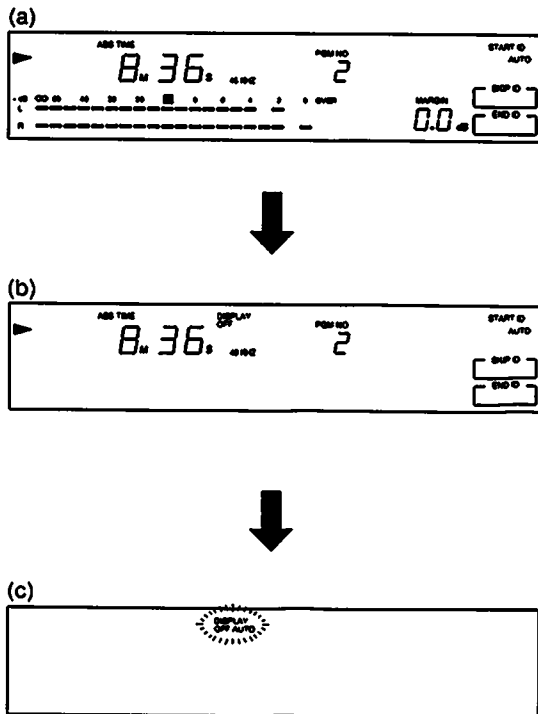

Location and Function of Controls

D

Fig. 1

1 Tape operation indicators

- REC**: Lights during recording or in the record-pause mode. Flashes in the record muting mode.
- ▶**: Lights during recording or playback. It also lights in the record-pause, the play-pause mode or in the record muting mode.
- : Lights in the record-pause mode or in the play-pause mode.

2 LONG play mode indicator

Lights when recording or playback is being performed in the long play mode.

3 Time indicator

Indicates the tape running time, absolute time or remaining time. Each time you press the COUNTER MODE button, the display is changed. When only the time display appears: Shows the tape running time. When the REMAINING (remaining time) indicator appears: Shows the remaining time of the tape. When the ABS TIME (absolute time) indicator appears: Shows the elapsed time from the beginning of the tape.

4 DISPLAY OFF/AUTO indicators

The DISPLAY OFF indicator lights when peak level meters and margin indicators are turned off. The DISPLAY OFF AUTO indicator lights momentarily before all the indicators are turned off.

5 CAUTION indicator

Lights when moisture condensation occurs. If this happens, the deck stops functioning automatically. (4)

6 INPUT selector indicators

The DIGITAL IN OPTICAL or DIGITAL IN COAXIAL indicator lights according to the position of the INPUT selector. No indicator lights when the INPUT selector is set to the ANALOG position.

7 STEP/PGM NO. indicator

Shows the program number of the selection being played. When programming the desired selection with the RMS operation (50), the display shows the step number of the programmed selection.

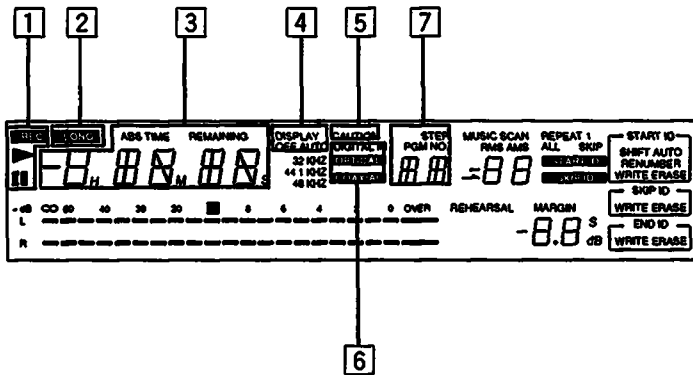

Location and Function of Controls

D

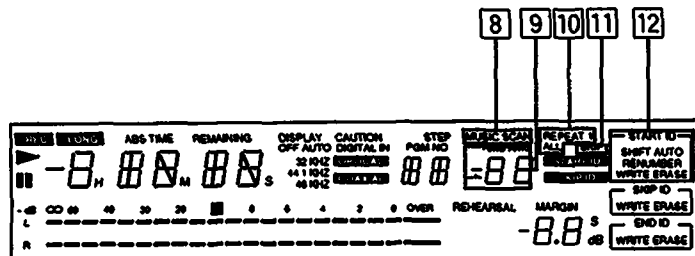

- 8** MUSIC SCAN indicator
Lights after you press the MUSIC SCAN button to listen to the beginning of each selection successively.
- 9** RMS (Random Music Sensor)/AMS (Automatic Music Sensor) indicators
Show the number of selections to be skipped ahead or behind in the AMS operation. When designating a selection directly by the numeric button and the ► button, the display shows the program number of the target selection while the selection is being searched for. When programming the desired selections in the RMS operation (50), the display shows the program number of the selection to be programmed.
- 10** REPEAT indicators
REPEAT 1: Lights when a desired selection is played back repeatedly
REPEAT ALL: Lights when all the selections are played back repeatedly.
- 11** SKIP indicator
When this indicator is lit during playback, the portion marked by the skip ID is skipped and playback continues from the next start ID.
- 12** START ID mode indicators
AUTO: Lights when the AUTO button is pressed to write the start ID automatically.
WRITE: Lights when writing the start ID manually.
ERASE: Lights when erasing the start ID.
AUTO RENUMBER: Lights when renumbering program numbers automatically.
SHIFT RENUMBER: Lights when shifting the start ID and program number position.

Location and Function of Controls

D

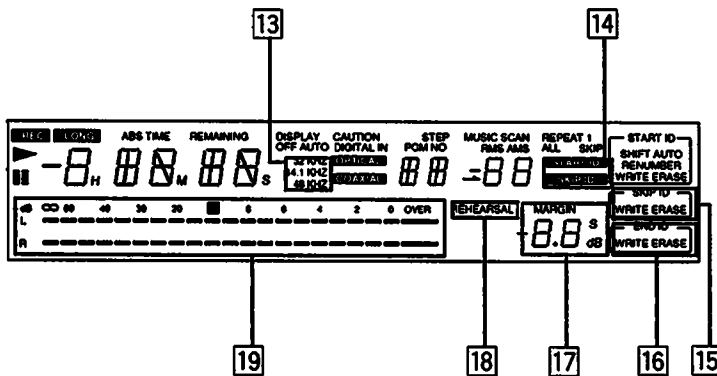

- 13** Sampling frequency indicator
 48 kHz: Lights when recording or playing back analog input signals (standard mode).
 44.1 kHz: Lights when recording or playing back a CD or a pre-recorded DAT cassette tape.
 32 kHz: Lights when recording or playing back analog input signals (long-play mode).
- 14** START ID indicator
 Flashes when writing (for 9 or 18 seconds) or erasing a start ID code, and lights when the start ID is detected during playback.
 SKIP ID indicator
 Lights when writing (for 1 or 2 seconds) or erasing a skip ID code or when the skip ID is detected during playback.
- 15** SKIP ID mode indicator
 WRITE: Lights when writing the skip ID.
 ERASE: Lights when erasing the skip ID.
- 16** END ID mode indicator
 WRITE: Lights when writing the end ID.
 ERASE: Lights when erasing the end ID.
- 17** MARGIN indicator
 Shows how much margin there is between the peak level of input audio signal and 0 dB.
- 18** REHEARSAL indicator
 Lights while the rehearsal function is activated (32).
- 19** Peak level meters
 Indicate the signal levels during playback and recording. There are separate meters for each left and right channel. These meters have a peak hold function which indicates the peak level momentarily.

Location and Function of Controls

Rear Panel Jacks **E**

- 1** **LINE IN** (line input) jacks (phono jack)
Connect to the recording outputs of an amplifier. Signals supplied by the amplifier can be recorded using the sampling frequency of 48 kHz in the standard play mode or 32 kHz in the long play mode.
- 2** **LINE OUT** (line output) jacks (phono jack)
Connect to the DAT or tape inputs of an amplifier. The playback signal of this deck will be output.
- 3** **COAXIAL/OPTICAL DIGITAL IN** (digital input) jacks (coaxial phono jack/optical jack)
Connect to the digital outputs of an amplifier having a built-in D/A converter or other digital source, such as a CD player for digital-to-digital recording
- 4** **OPTICAL DIGITAL OUT** (digital output) jack (optical jack)
Connect to the digital inputs of an amplifier having a built-in D/A converter or another DAT deck, for playback of a DAT cassette or digital-to-digital recording.

Notes on connection

- Use the connecting cords specified in the illustrations.
- Turn off the power for all equipments before making connections.
- Be sure to insert the plugs firmly into the jacks. Loose connections may cause hum and noise. When unplugging, grasp the plug and not the cord.

Note on sound signals

When connecting an optical cable to the DIGITAL IN/DIGITAL OUT jacks, sound signals (L/R) are transmitted together through the cable.

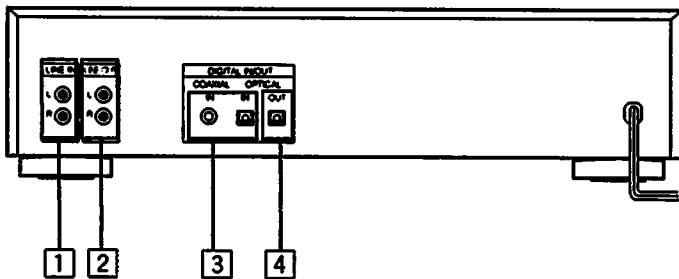

Connections

Connecting Cords

There are following three types of connecting jacks at the rear of the deck. Each type of jack requires a different type of connecting cord.

For LINE IN/OUT (analog input/output) jacks **A**

Use the supplied or an optional audio signal connecting cord such as RK-C710HS, RK-C715HS, RK-C910ES, RK-C915ES etc.

Note

Red plugs and jacks are for the right channel (R) and white ones for the left channel (L).

For COAXIAL IN (digital input) jacks **B**

Use an optional coaxial connecting cord such as VMC-1ES, VMC-10ES etc.

For OPTICAL IN/OUT (optical transmission digital input/output) jacks **C**

Use an optional optical cable such as POC-15, POC-10HS etc.

How to connect the optical cable **D**

Remove the cap and plug it in firmly.

Notes on the optical cable

- Do not bend the cord. When the cord is not used, curl it with a diameter of more than 15 cm (5 7/8 inches).
- Do not use it under high temperatures.
- When the optical cable is not connected, cover the OPTICAL IN/OUT jacks with the supplied caps.

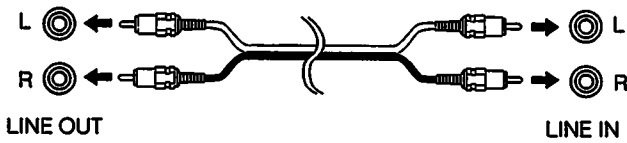
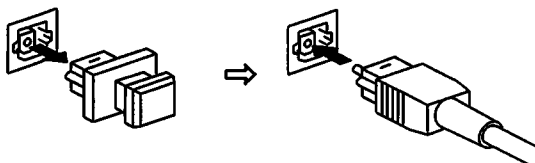
A**B****C****D**

Connections

Connection Examples

If your amplifier is not equipped with digital signal jacks

- a) CD player
- b) DAT deck
- c) Amplifier
- d) to a wall outlet

A) When recording via digital-to-digital connection, connect a DAT deck (the digital input) to DIGITAL OUT OPTICAL of the DTC-690.

B) When recording via digital-to-digital connection, connect the sound source equipment (the digital output) to DIGITAL IN (COAXIAL or OPTICAL) of the DTC-690.

When connecting a microphone

Connecting a stereo microphone amplifier (the analog output) to LINE IN of the DTC-690.

Note

If "PROH" appears on the display, recording via digital-to-digital connection cannot be performed.

In this case, connect the sound source equipment using LINE IN and OUT jacks.

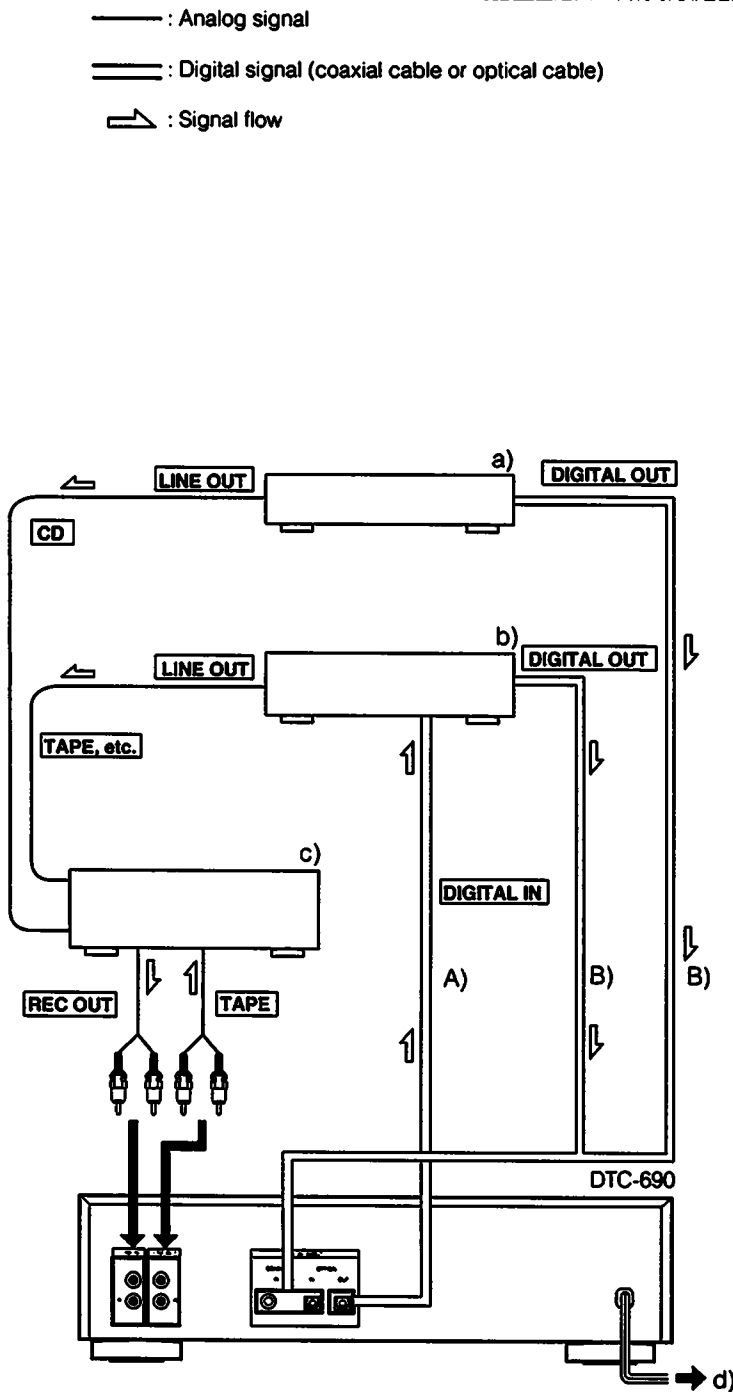

Connections

- : Analog signal
- == : Digital signal (coaxial cable or optical cable)
- ⇨ : Signal flow

If your amplifier is equipped with digital signal jacks

- a) CD player
- b) DAT deck
- c) Amplifier
- d) to a wall outlet

Note

If "PROH" appears on the display, recording via digital-to-digital connection cannot be performed.

In this case, connect the sound source equipment using LINE IN and OUT jacks.

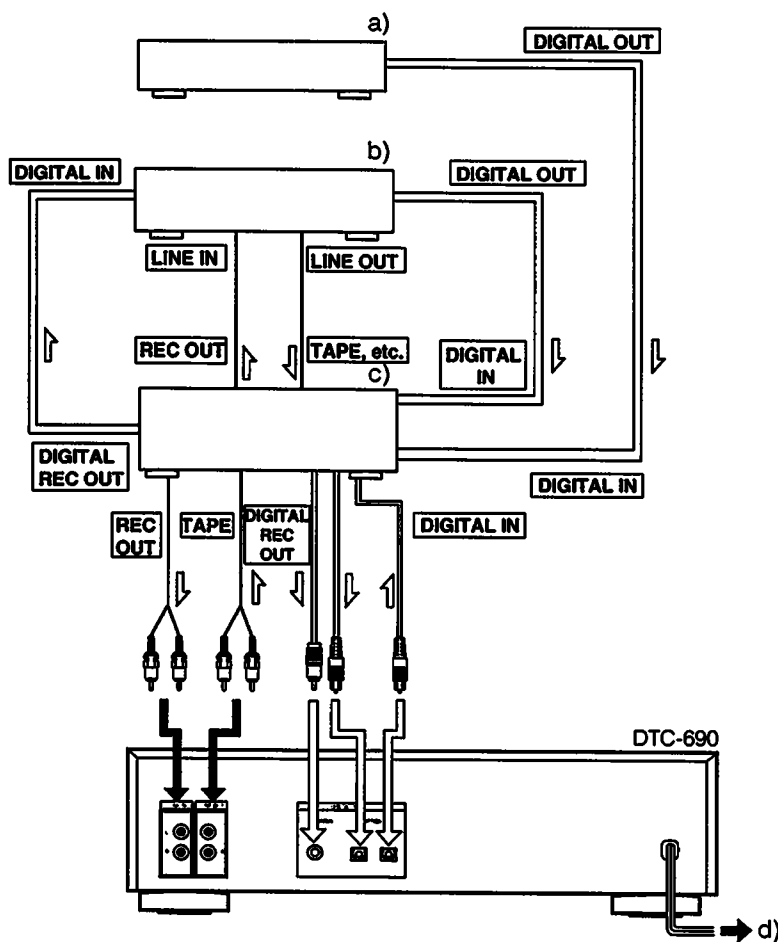

Loading

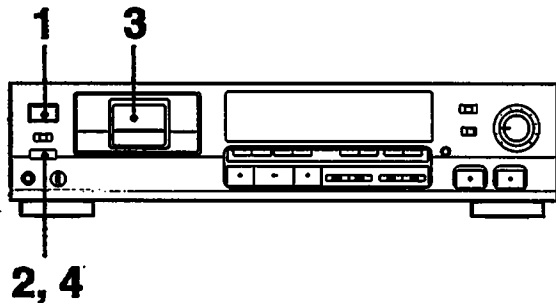

- 1** Turn on the power.
- 2** Press **△OPEN/CLOSE**.
The *OPEN* indicator appears on the display.
- 3** Insert the cassette.
A) Insert the cassette beyond the silver line.
B) Tab facing towards you.
C) Window side up.
- 4** Press **△OPEN/CLOSE**.
The *CLOSE* indicator appears on the display.

To remove the cassette
Press **△OPEN/CLOSE**.

On a digital audio tape

Only the digital audio tape made especially for DAT deck is required. Unlike a conventional analog audio cassette tape, a digital audio tape can be used only one side.

- Digital audio tape is designed to avoid a dust. Do not open the inside of the tape.
- The hole at the back of a tape is a detector slot. Do not cover the slot

Notes

- When you turn on the power, the **II** indicator flashes for a moment in the display window. During this period, no buttons other than the **△OPEN/CLOSE** and **▶** buttons are operative. Wait until flashing stops and the **II** indicator goes off.
- When inserting the cassette, do not push the cassette compartment closed. Be sure to use the **△OPEN/CLOSE** button.

On the sampling frequency

When a cassette is inserted and a source program is played back, the sampling frequency (48 kHz, 44.1 kHz or 32 kHz) of the source program appears in the display window.

To prevent accidental erasure **A**

When a recording is made, any previously recorded signal will be erased automatically. To prevent accidental erasure, set the safety tab to the position shown in the illustration. With the hole open, rewriting sub codes cannot be performed.

- A) Recording is impossible (with the hole open).
- B) Recording is possible (with the hole covered).

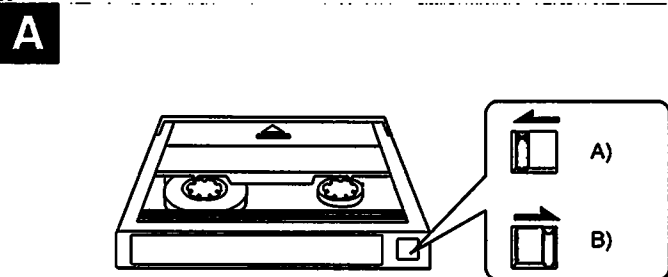
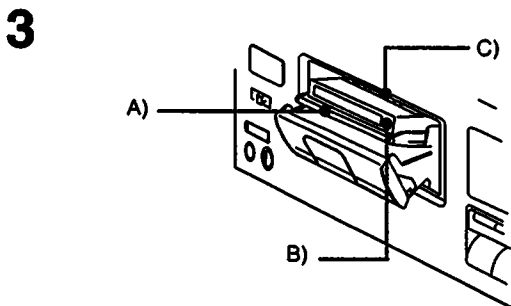

Before Recording

Blank Section and Sound Muted Portion

With conventional analog audio tapes, the tape portion on which no recording ever has been made and the portion on which a recording has been made but the sound is muted are treated the same, since no sound can be heard from these portions. However, with DAT cassette, you should know that the two kinds of "no sound" portions must definitely be distinguished one from the other.

Blank section **A**

Means the portion on which no recording ever has been applied.

A) Blank section

Ⓡ : Recording

Ⓢ : Selection

Sound muted portion **B**

Means the portion on which a recording has been applied but that no audible sound is recorded.

A) Sound muted section

Ⓡ : Recording

Ⓢ : Selection

Important

When recording, be certain that no blank section is left on the tape. If blank sections remain on the tape, search operations using the AMS buttons, for example, may take quite a long time or the absolute time is not written correctly.

Difference between the blank section and sound-muted portion

When you record, a track format is constructed on the recorded area, even if the sound is muted during recording. On the blank section, since no recording is applied, there is no track format.

A

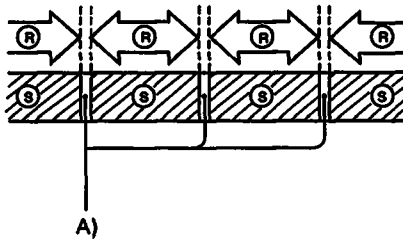

B

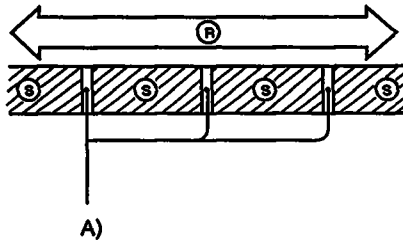

Recording

C

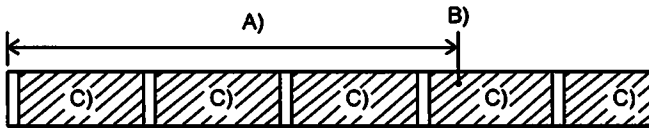

Absolute Time Codes C

The absolute time indicates the position of the tape, giving the time elapsed from the beginning.

- A) ABS time
- B) the position being playing back
- C) selection

The absolute time codes correctly written on the tape can be used in various convenient ways during playback.

Recording absolute time codes

When you record, the absolute time codes are also written automatically from the beginning of the tape.

Once the absolute time codes are recorded, it cannot be re-written. With the absolute time, you can check the elapsed time from the beginning of the tape.

Note, however, that the absolute time codes are not written if you start recording from the middle of blank section. No blank sections should be left on the tape when recording.

Tips for recording:

- To insert silence between selections, use the record muting function (page 25). Do not advance the tape with the ►► or ► button.
- To start recording from the middle of the tape, use the end search function (page 26) to locate the beginning of the blank section. This will avoid leaving a blank section.

If a blank section is left on the tape

If you start recording from the middle of a blank section, the absolute time codes are not recorded, since the DAT deck can no longer count the absolute time from the beginning of the tape.

Recording

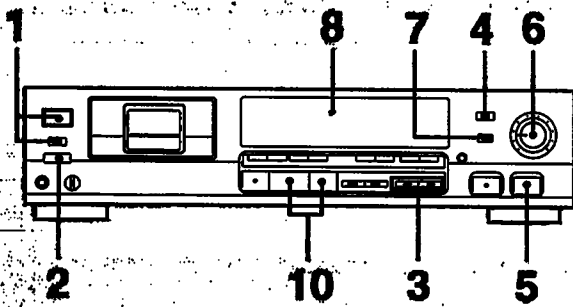

- 1** Make sure that the **TIMER** switch is set to the **OFF** position, and turn on the power.
- 2** Insert a cassette and press the **▲OPEN/CLOSE** button to load the cassette (Page 18).
- 3** Locate the position at which you want to start recording.
To start recording from the beginning of the tape, press the **◀◀** button. (Press the **◀◀** button again, the "TOP" indicator will appear at the beginning of the tape.)
To start from the middle of the tape, locate the point immediately before the blank section with the end search function (Page 26).
- 4** Set the **INPUT** selector to **ANALOG**, **OPT** or **COAXIAL** depending upon your sound source.
- 5** Press the **●REC** button.
[REC], **▶** and **||** indicators light on the display, and the deck enters the record-pause mode. The sampling frequency to be applied for recording appears. If the digital copy prohibit signal is written on the codes of the sound source, the **PROH** indicator appears on the display and signifies that you cannot record that source with the digital-to-digital connection. In this case, use the analog-to-analog connection.
- 6** When recording the analog input signal, adjust the recording level and balance with the **REC LEVEL** controls respectively (Page 23).
No recording level adjustment is required when recording the digital input signal.
- 7** Set the **REC MODE** selector.
When recording in the long play mode or standard mode, set the **REC MODE** selector to the **LONG** or **STANDARD** position respectively (Page 24).
- 8** When writing start ID automatically during recording, make sure that the **AUTO** indicator is lit.
If not, press the **START ID AUTO** button (Page 30).
- 9** When designating the program number, press the desired numeric button (Page 35).
When recording from the beginning of the tape, the program number will be assigned automatically from 1. The program number is also written at the same position as the start ID.
- 10** Press the **||PAUSE** or **▶** (play) button.
The **||** indicator goes off, and recording starts.

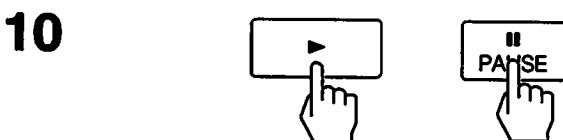
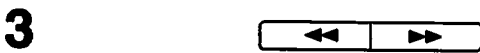
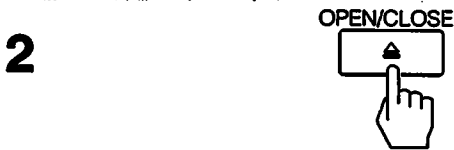
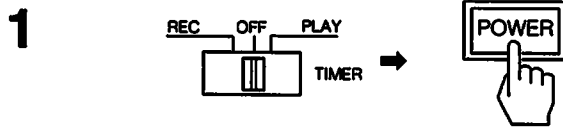

Recording

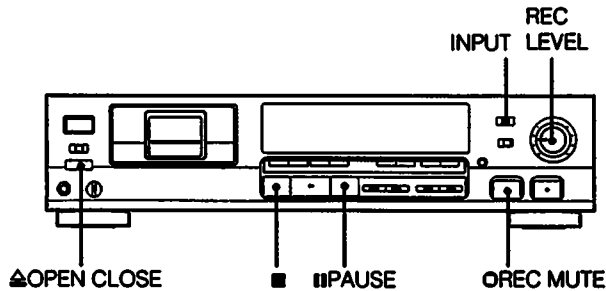

Note on the recording from the beginning of the tape

When you start recording from the beginning of the tape, create a 4 second-muted portion by using record muting function (Page 25). Otherwise, when locating the first selection with the **REWIND** or **STOP** button, the first portion of the first selection may not be played back.

To stop recording

Press the **STOP** button.

To stop recording for a moment

Press the **PAUSE** button.

When you press the **REC MUTE** button, the deck will enter the record-pause mode automatically.

To release pause and restart recording

Press the **PAUSE** or **PLAY** button.

Note on the OPEN/CLOSE button

The **OPEN/CLOSE** button does not function during recording or in the record muting mode. So, when removing the cassette tape, press the **STOP** button to stop recording and then press the **OPEN/CLOSE** button.

If recording cannot be made

Check the following:

- The safety tab of the cassette is not set to the record-possible position. (Page 18.)
- No cassette is loaded.
- The **INPUT** selector is set to the incorrect position.
- Tape is fully rewound to the end.
- The output level of the playback equipment is too low.
- The digital copy prohibit signal is written in the codes of the sound source you want to record. (The **PROH** indicator appears on the display.)
- The **REC LEVEL** controls are set to the 0 position. (Only when recording the analog input signal.)

Note on the INPUT selector and the REC MODE selector

Do not change the position of these selectors after recording starts.

If the cassette is ejected after it has been loaded

Check to see if the cassette is inserted correctly. (Page 18.)

When the tape is recorded to the end

The tape is rewound to the beginning and stops automatically. (Auto rewind function)
The auto rewind function is not applied when the **TIMER** switch is set to the **REC** position.

Accuracy of the electronic linear time counter

The linear time counter provided with this unit is not a clock.
The time indicated by the counter may differ slightly from the actual recording/playback time.

Recording

If the unit is left in the record-pause mode for more than 10 minutes during digital recording

The record-pause mode will be released automatically, and the unit will enter the stop mode. (The "-DA" indicator appears on the display.) In this case, press the ●REC to set the unit to record-pause mode.

If the cable is disconnected or the program source is intermitted, the digital input signal will be interrupted during digital recording

The OPTICAL and II or COAXIAL and II indicators flash and the unit will enter record-pause mode. (For about 10 minutes) If the digital signal is input again in this period, the unit will enter recording mode automatically.

Recording level adjustment (for analog input signals only) A

The peak level meters have a peak hold function which indicates the peak level of the analog input signal momentarily. The MARGIN indicator shows how much margin there is between the peak level of the input audio signal and 0 dB. Whenever a signal having a higher level than the displayed one is input, the new level replaces the lower one on the MARGIN indicator.

Turn the REC LEVEL controls so that the "OVER" segments do not light, even at the highest level.

To reset the margin

Press the MARGIN RESET button. The margin will become "-".

If the level exceeds 0 dB

The "OVER" segments light in red, and "0.0 dB" flashes.

If "OVER" lights steadily, lower the recording level so that the peak level meter lights between -12 dB (12) and 0 dB to avoid sound distortion.

If you keep adjusting the recording level with the unit in the record-pause mode

If the unit is left in the record-pause mode for more than 10 minutes, the record-pause mode will be released automatically, and the unit will enter the stop mode.

The levels of the input audio signals appear even in the stop mode, and you can continue to adjust the recording level. (The "AD-DA" indicator appears on the display.)

In the above case, press the ●REC button again to set the unit to record-pause mode.

A

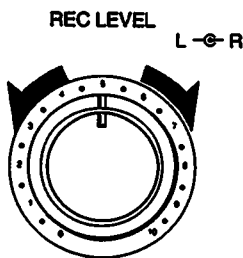
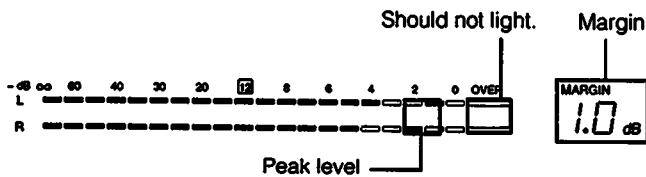

Recording

B

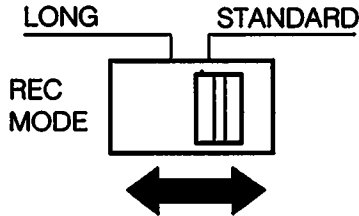

Long-play mode ^B

According to the input signal, recording/playback in the long-play mode can be performed as follows.

Input signal	Recording mode (position of the REC MODE selector)	
	STANDARD	LONG
Analog input signal	standard play (48 kHz)	long play (32 kHz)
Digital input signal 32 kHz*	standard play (32 kHz)	long play (32 kHz)
Digital input signal 44.1 kHz, 48 kHz*	standard play (the same as input signal)	standard play (the same as input signal)

(): sampling frequency

The digital input signal on 44.1 kHz or 48 kHz cannot be recorded/played back in the long play mode, even if the REC MODE selector is set to the LONG position.

* Digitally recorded analog input signal with a sampling frequency of 32 kHz or 48 kHz can be recorded via digital-to-digital connection.

The longest recording period at each mode

Mode	The longest recording period	
	standard	long
Cassette		
DT-120	2h	4h
DT-90	1h 30m	3h
DT-60	1h	2h

(h: hour, m: minute)

The timer counter in the long-play mode

Tape running time, absolute time and total remaining of the tape appears, based on those in the standard mode. To obtain the actual time, double each value.

Recording

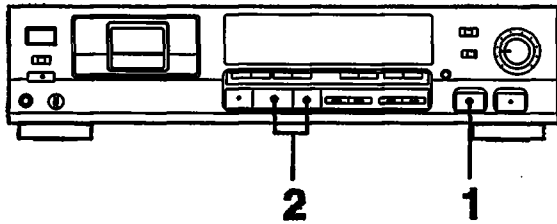

Creating a Sound Muted Portion (Record Muting)

1 During recording or record-pause mode, press the **REC MUTE** button where a sound muted portion is required.

The **REC** indicator flashes and the record muting is activated. After about 4 seconds, the **REC** indicator shows a steady light, and the **II** indicator lights. The deck enters the record-pause mode.

2 To resume recording, press the **II PAUSE** or **▶** (play) button. Recording resumes.

Using sound muted portion

If you intend to dub the DAT cassette onto an analog cassette tape, we recommend that you insert sound muted portions on the DAT cassette. This will ensure that the AMS function of the analog cassette deck works correctly for the recorded tape.

Note

With DAT deck, the AMS function is realized by using the start ID code. (Page 29.)

Caution

To place a space on a DAT cassette, you must not advance the tape with the **▶▶** or **▶** button. If a space is created this way, no absolute time code will be recorded on the succeeding area, and you cannot check the elapsed time of the tape.

To create a sound muted portion of more than 4 seconds

Keep the **REC MUTE** button pressed for as long as you want to make a recorded portion with no signals. After about 4 seconds, the **REC** indicator flashes rapidly. When you release the **REC MUTE** button, the deck enters the record-pause mode.

The interval between selections is indicated at the **MARGIN** display.

To create a sound muted portion of less than 4 seconds

Press the **REC MUTE** button, and then the **II PAUSE** button while the **REC** indicator is flashing.

To start recording in the record muting mode

Press the **●REC** button while the **REC** indicator is flashing.

1



2

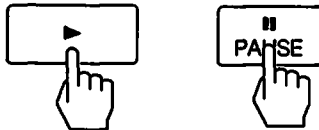

Recording

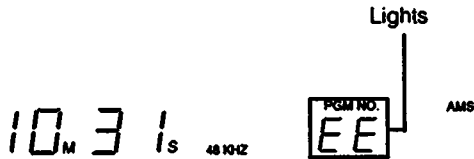
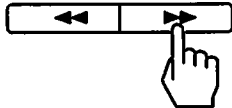
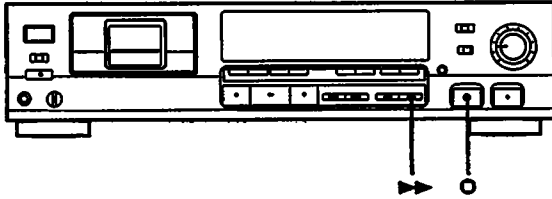

C

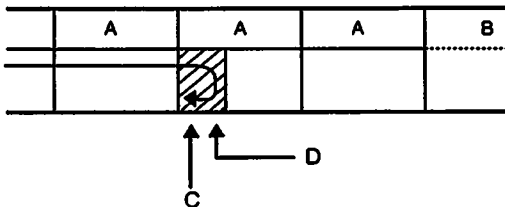

End Search

If the previous recording was applied to the middle of the tape, you must locate exactly the last point of the recorded area, and start the new recording from this point. This will prevent leaving a blank section on the tape.

If you want space between the last recording and the new recording, use the OREC MUTE button to mute the sound.

Press ►►.

The last point of the previous recording (the beginning of the blank section or the beginning of the end ID*) is located, and the tape stops. When the end ID is detected, the "EE" indicator lights at the PGM. NO display.

When new recording is made from the position where the end ID is written, the end ID is erased automatically.

Note

If the point where you pressed the ►► button is blank, the end search operation will not function.

When the end ID is written before a blank section

The end search operation stops at the beginning of this end ID as described in Fig 2.

- A) Selection
- B) Blank
- C) The position at which the end ID stops.
- D) End ID

Note on the duration of a blank section

The blank section must last for more than 9 seconds for the end search operation to function correctly.

With the new cassette tape which no recording is made, the tape will advance to the end.

Sub Codes

A

DAT cassette tape

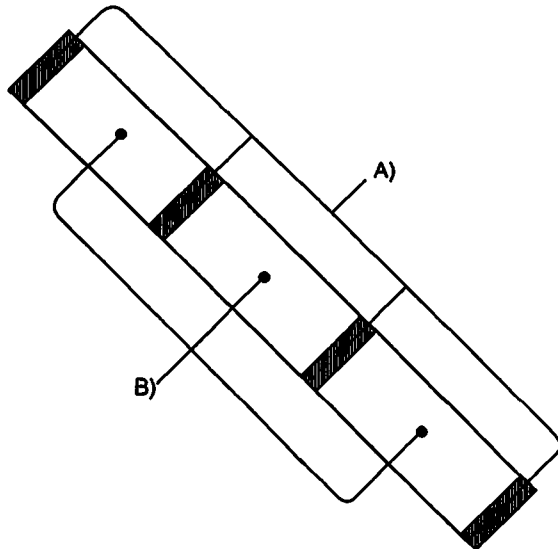

In addition to the ordinary audio signals, various control codes called sub codes can be recorded on the DAT cassette tapes to ease recording and reproducing operation. **A**

A)The sub codes are recorded.

B)Audio signals are recorded.

A desired selection can be called up or time information can be displayed using the sub codes, for example.

The sub codes such as start ID, program number, skip ID, end ID and absolute time are available on this unit.

- Sub codes are written on the tape separately from the audio signals, so the audio signals are not affected.
- Sub codes, except the absolute time, can be rewritten after the audio signal recording has been completed. The recorded audio signals are not affected by the rewritten sub codes.
- When you record the tape with sub codes written onto a new tape via digital-to-digital connection, the sub codes to be written on the new tape are following:

Start IDs	The same as the codes written on the original tape.
Skip IDs	The same as the codes written on the original tape.
Program Numbers	New ones will be written according to the DAT deck you use.
Absolute time	New ones will be written.
End ID	The one written on the original tape will not be written.

When you use analog-to-analog connection, no sub codes on the original tape will be written onto a new tape. New codes will be written according to the DAT deck you use.

B

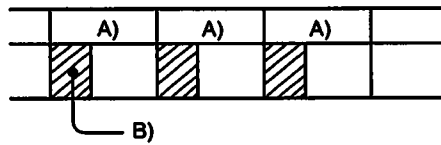

C

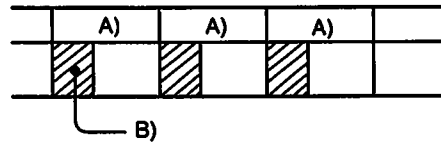

D

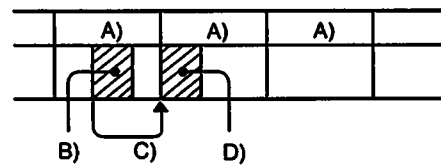

E

1)

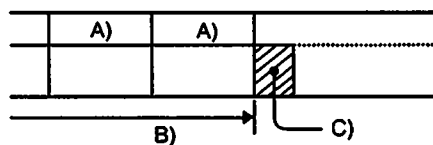

Start ID

This signal indicates the start of a music selection. You can locate the position of the start ID precisely. This signal should be written at the beginning of the selection.
 A) Selection
 B) Start ID

Program number

This signal gives a number to selection. You can record it where the start ID is written. By designating this number, you can choose the desired selection directly or program selections in a desired order.
 A) Selection
 B) Program number

Skip ID

This signal can be marked on the selection wherever you wish. When the SKIP indicator is lit during playback, the deck will skip at high speed from where the skip ID is marked to the next start ID, and then playback will start again. Record this skip ID at the beginning of portion you want to skip.
 A) Selection
 B) Skip ID
 C) Skip to the next start ID.
 D) Start ID

End ID

This signal indicates the end position of a recording.
 1)
 When you do not want to listen to the very end of a tape, record the end ID at the beginning of the portion you do not want to play. When the end ID is detected during playback, playback stops and the tape is rewound to the beginning automatically.
 A) Selection
 B) When the end ID is detected, during playback, the tape is automatically rewound to the beginning.
 C) End ID

Sub Codes

E

2)

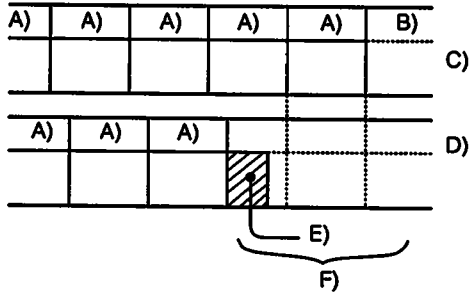

3)

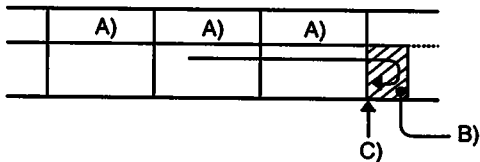

2)
When recording new material on a recorded tape, you can write an end ID at the end of the re-recorded portion. This will help you easily find the position to start recording the next time when you want to record other material onto the same tape.

- A) Selection
- B) Blank
- C) Recorded tape
- D) When recording new material onto the same tape.
- E) End ID
- F) Portion where you have not made a second recording (This first recording has not been erased.)

3)
When an end ID which has been written is detected during locating selections or rehearsal playback of start ID or skip ID, the unit stops at the beginning of the end ID.

- A) Selection
- B) End ID
- C) The position at which the tape stops.

Absolute time

The absolute time indicates the position of the tape, giving the time elapsed from the beginning. The absolute time is recorded automatically at the same time the audio signal is recorded. It cannot be re-recorded. The absolute time allows you to confirm the elapsed time from the beginning of the tape.

When using the sub codes

Things that can be done	Required sub code(s)
Locating a selection (AMS function)	Start ID
Listening to the first portion of selections sequentially (Music Scan)	Start ID
Choosing a selection directly	Start ID/Program number
Programming desired selections in a desired order (RMS play)	Start ID/Program number
Skipping the portion not desired	Skip ID/Start ID
Looking for the position at which the recording or playback ends	End ID

Start ID

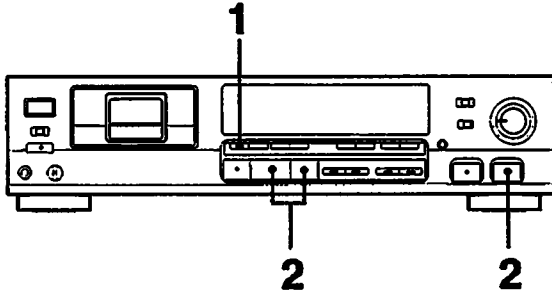

The start ID indicates the beginning of each selection.
You can start playback from the start ID position. (Page 28.)

There are three ways to write start ID

- Writing automatically during recording
- Writing manually at the desired position during recording
- Writing manually at the desired position during playback

Note

While the start ID is being written, all buttons except the **■** button are not operative.

Writing Automatically during Recording

- 1 **Make sure that the AUTO indicator is lit. If it is not, press the START ID AUTO button.**

When turning on the power and inserting a cassette with its safety tab at the record-possible position, the AUTO indicator lights automatically. In timer recording, this indicator will be the same as the one before the power is turned off. Start IDs will be recorded automatically when the AUTO indicator lights.

- 2 **To start recording, press the ●REC button, then press the ||PAUSE or ► (play) button.**

When the non-signal level lasts for more than 3 seconds and a selection then starts, the start ID is written automatically for 9 seconds (18 seconds in the long-play mode). The program number is also written simultaneously. (Page 34.)

While a start ID is being written, the **START ID** indicator flashes on the display.

1



2



Start ID

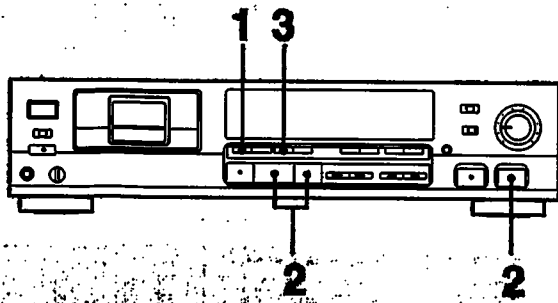

Why 9 seconds or 18 seconds are necessary for writing a start ID ?

A start ID requires 9 or 18 seconds to allow to be detected when rewinding/fast-forwarding a tape. (The speed is 200 times as fast as that of normal tape operation.) After the start ID is located, the tape returns to the beginning of the start ID if necessary, and playback starts from the beginning of the selection.

If the signal level stays very low for more than 3 seconds

If there is a portion of very low volume level during a selection, a start ID may be written even in the middle of the selection. An unwanted start ID can be erased later. (See page 33).

When the portion between selections is not clear

The start ID position may not coincide exactly to the beginning of the selection. To shift the start ID position, see "Shifting Start IDs' and Program Numbers Position" on page 37.

Illustration of writing a start ID

- a) Selection
- b) Start ID
- c) Particular level
- d) More than 3 seconds

When recording from a CD player

If the auto space function is available with your CD player, activate this function to ensure that the start IDs are written correctly.

Writing Manually during Recording

- 1** Make sure that the AUTO indicator is off. If it is not, press the START ID AUTO button to turn it off.
- 2** To start recording, press the ●REC button, then press the ||PAUSE or ►(play) button.
- 3** At the desired position, press the START ID WRITE button. The WRITE indicator lights. The start ID is written for 9 seconds (18 seconds in the long-play mode) from the point where you pressed the START ID WRITE button. While a start ID is being written, the START ID indicator flashes.

1

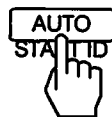

2

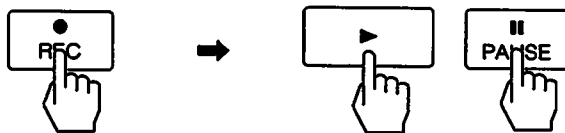

3



A

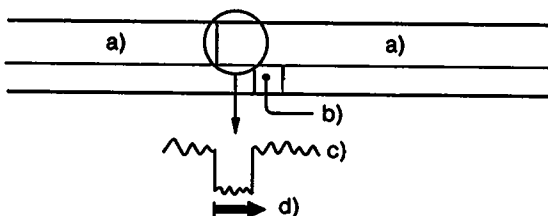

Start ID

Writing Manually during Playback (Rehearsal Function)

During playback, start ID can be written at the desired position more accurately than during recording.

Make sure that the safety tab of the cassette is closed.

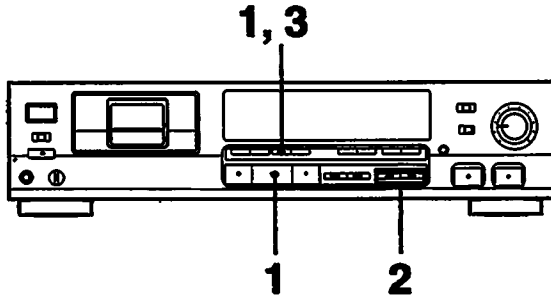

1 Press the ► button to start playback. At the desired position, press the START ID WRITE button. The REHEARSAL indicator lights and the WRITE and START ID indicators flash, and the position for 3 seconds from the point where you pressed the START ID WRITE button is played back repeatedly (rehearsal function). The beginning of the repeated portion will be the beginning of the start ID.

2 Press the ◀◀ or ▶▶ button to adjust the "repeat start" point. The "repeat start" point is shifted backward with the ◀◀ button or forward with the ▶▶ button by about 0.3 of a second. The indicator at the MARGIN display shows how much the "repeat start" point is shifted from the point where you pressed the START ID WRITE button.

3 After setting the beginning of the start ID at the desired point, press the START ID WRITE button again. The WRITE indicator lights steadily and the start ID is written. The program number is not written in this time.
a) When you pressed ▶▶ twice.

Note on the point where a start ID is written

During the rehearsal function, a start ID is written at the beginning of the repeated portion as illustrated.

- a) Point where you pressed START ID WRITE
- b) Repeated portion (for 3 seconds)
- c) Selection
- d) Each time you press ◀◀
- e) Each time you press ▶▶
- f) 0.3 sec.

Normally, the repeated portion is played back 5 times.

When the ◀◀ or ▶▶ button is pressed while the repeated portion is played back, the repeated portion is played back up to 8 times max, and then the tape stops.

1

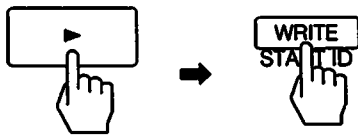

2

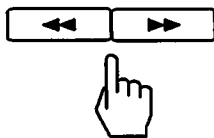

3



A

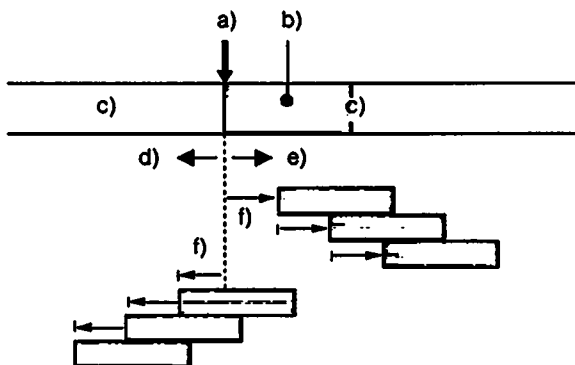

Start ID

START ID ERASE

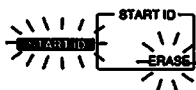
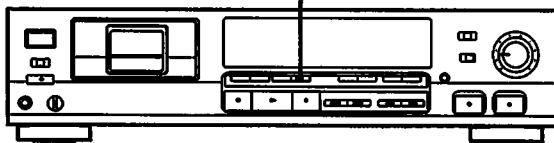

Adjusting the Position

The position of a start ID written during recording or by using the rehearsal function can be finely adjusted. You can shift the start ID position about 2 seconds (about 4 seconds in the long-play mode) backward or forward. To shift it for more than 2 seconds, first erase the start ID (see below) and rewrite it manually.

- 1 During playback, press the **START ID WRITE** button where the start ID to be shifted is written.
- 2 Perform steps 2 and 3 described, "Writing Manually during Playback."

Erasing

While the start ID you want to erase appears on the display during playback or in the stop mode, press the START ID ERASE button.

Make sure that the safety tab of the cassette is closed.

That start ID is erased.

The ERASE indicator flashes while the start ID is detected. While the start ID is being erased, the ERASE indicator lights and the **START ID** indicator flashes.

If you press the START ID ERASE button during the stop mode or while the **START ID indicator is not on the display**

The start ID just before the current position is erased.

When a start ID is erased

If a program number is also written with the start ID, the program number will be erased as well at the same time and the succeeding program number remain unchanged. In this case, re-arrange the program number with the renumbering function. (Page 36.)

Program Numbers

Program numbers are the codes indicating the selection order. (Page 28.) There are two ways to write program numbers:

- Writing automatically during recording
- Renumbering automatically during playback or in the stop mode (Renumbering function)

Writing Automatically during Recording

When you proceed so that start IDs are written automatically during recording, the program numbers are also written.

Writing program numbers from the beginning of the tape

- 1** Make sure that the **AUTO** indicator is lit. If it is not lit, press the **START ID AUTO** button. When turning on the power and inserting a cassette with its safety tab at the record-possible position, the **AUTO** indicator lights. In timer recording, the **AUTO** indicator will be the same as the one before the power is turned off.
- 2** To start recording, press the **REC** button, then press the **PAUSE** or **▶** (play) button. The program numbers will be written in numerical order from "1" at the same position as the start IDs. The **START ID** indicator flashes while the start ID is written for about 9 seconds (18 seconds in the long-play mode).

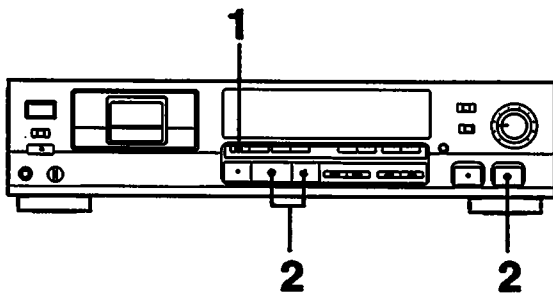

1



2

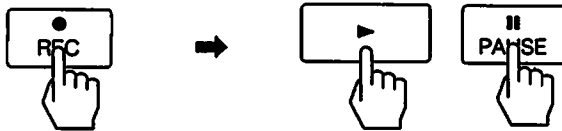

Program Numbers

Writing program numbers from the middle of the tape

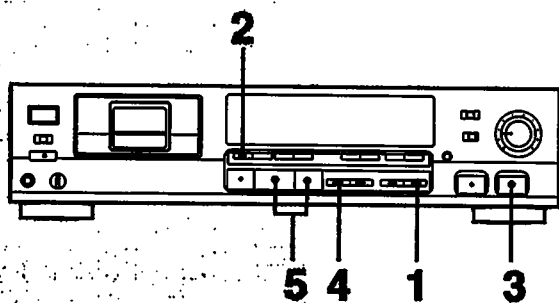

1 To locate the last point of the previous recording, using the end search function. (Page 26)
It is important to proceed with the end search function in order not to leave a blank section on the tape.

2 Make sure that the AUTO indicator is lit. If it is not lit, press the START ID AUTO button.

When turning on the power and inserting a cassette with its safety tab at the record-possible position, the AUTO indicator lights. In timer recording, the AUTO indicator will be the same as the one before the power is turned off.

3 Press the ●REC button to set the deck in the record-pause mode.

4 Designate the next program number (the number that follows the program number of the last selection) with the numeric button on the remote commander.

If you are not aware of the program number, press the ◀◀ button to check the last program number (After checking the program number, locate the last point of the previous recording, using the end search function.)

If the program number of the last selection appears at the PGM NO. display

you need not to designate the next number.

a) Next program number

If the next program number is not designated

The start IDs will be written, but the program numbers will not.

You can write the program numbers using the renumbering function described on the next page.

5 Press the ||PAUSE or ▶ (play) button.

The program numbers are written consecutively, beginning from the designated number at the same position as the start ID.

1

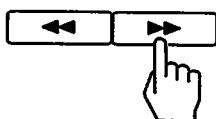

2

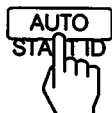

3



4

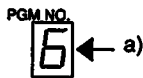
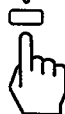
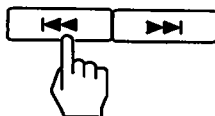
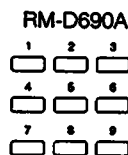

5

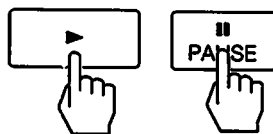

Program Numbers

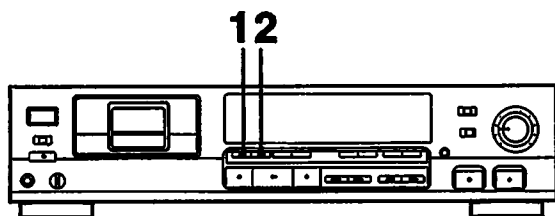

Renumbering

If you record from the beginning to the middle of a tape on which another recording has ever been applied, the same program number may be written twice on that tape.

If you omit designating the next program number when recording from the middle of the tape, the succeeding program numbers are not written.

In such cases, with the renumbering function, you can renumber the program numbers from the beginning of the tape at a high speed.

Renumbering Program Numbers Automatically

1 Make sure that the **AUTO** indicator is lit, and that the safety tab of the cassette is at the record-possible position.

If the **AUTO** indicator is not lit, press the **START ID AUTO** button.

2 Press the **RENUMBER** button during playback or in the stop mode.

The tape will automatically be rewound to the beginning, and the program numbers are re-arranged from "1" in numerical order at each start ID position.

While the program numbers are rewritten, the **[START ID]** indicator flashes and while the tape is fast-forwarded to the next start ID, the **AUTO RENUMBER** indicator flashes. When program numbers are written correctly, the tape is fast-forwarded to the next start ID.

When renumbering is terminated

The tape is automatically rewound to the beginning, and the deck enters stop mode.

Note

The renumbering function may not work correctly in the following cases:

- A blank section is left on the tape.
- The beginning of the new tape is advanced with the **▶▶** or **▶** button.

1



2



Program Numbers

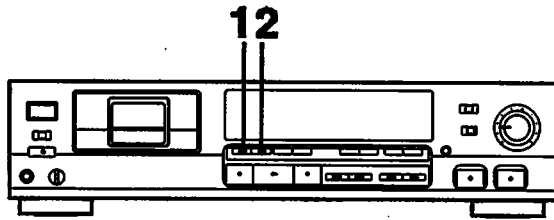

Shifting Start IDs' and Program Numbers Position

The start ID position may not coincide exactly to the beginning of the selection, especially when the portion between selections is not clear. On such a tape, the very beginning of the selection cannot be located using the AMS function. If this happens, you can shift the start ID and program number position, however, you cannot shift the position of the program number 1.

- 1 Make sure that the AUTO indicator is off, and that the safety tab of the cassette is at the record-possible position.**

If the AUTO indicator is lit, press the START ID AUTO button to turn off the indicator.

- 2 Press the RENUMBER button during playback or in the stop mode.**

The start ID and program number position of the 2nd selection and the succeeding selections, will be shifted toward the head of the tape by about 0.3 of a second.

When program numbers are written incorrectly, the renumber function operates.

Erasing

Make sure that the safety tab of the cassette is closed.

During playback, press the START ID ERASE button while the program number to be erased appears on the display.

That program number is erased. The start ID at the same position will also be erased. The ERASE indicator flashes while the program number is being searched for, and the **START ID** indicator flashes while the program number is being erased.

When the program number is erased

Playback continues. The succeeding program numbers remain unchanged. To re-arrange the program numbers, renumber them as described on page 36.

1



2

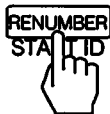

Skip ID

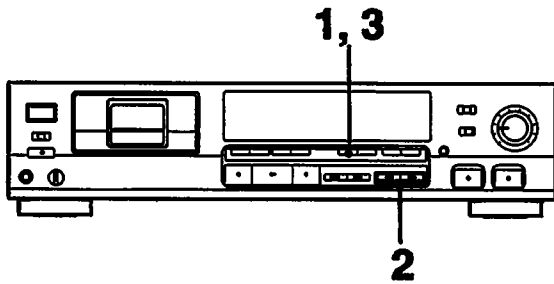

The skip ID indicates the beginning of the portion to be skipped. When the skip ID is detected during playback, the tape skips to the next start ID position, and the normal playback resumes. (SKIP play) (Page 28.) You can write the skip ID during recording or write more accurately during playback.

Writing during Recording

Press the SKIP ID WRITE button at the beginning of the portion you want to skip later.

The [SKIP ID] and WRITE indicators light momentarily.

The skip ID is written for about 1 second (2 seconds in the long-play mode) from where you pressed the button.

Writing during Playback (Rehearsal Function)

During playback, skip ID can be written at the desired position more accurately than during recording. Make sure that the safety tab of the cassette is closed.

1 During playback, press the SKIP ID WRITE button at the desired position.

The REHEARSAL indicator lights and the WRITE indicator flashes, and the portion for 3 seconds to the point where you pressed the SKIP ID WRITE button, is played back repeatedly (rehearsal function). The end of the repeated portion will be the beginning of the skip ID.

2 Press the << or >> button to adjust the "repeat end" point. The "repeat end" point shifted backward with the << button or forward with the >> button by 0.3 of a second.

The indicator at the MARGIN shows how much the "repeat end" point is shifted from the point where you pressed SKIP ID WRITE.

a) When you pressed << twice.

3 After setting the beginning of the skip ID at the desired point, press the SKIP ID WRITE button again. The [SKIP ID] indicator lights, and the skip ID is written.

1



2

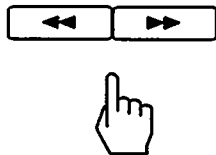

3

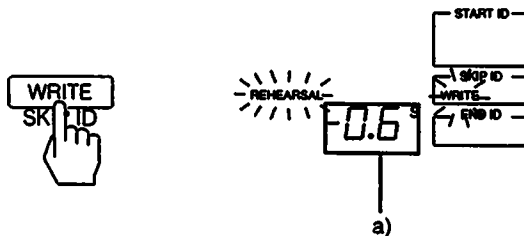

Skip ID

A

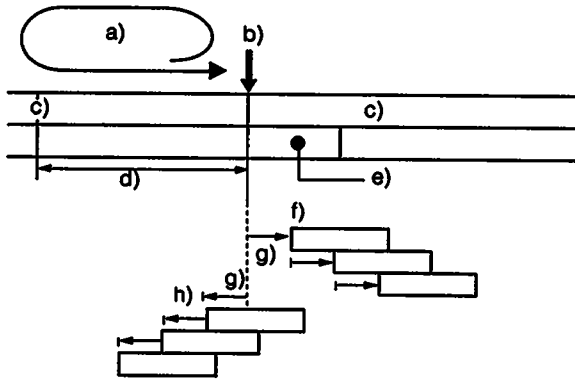

Note on the point where a skip ID is written **A**

During the rehearsal function, a skip ID will be written at the end of the repeated portion as illustrated.

- a) Repeated portion
- b) Point where you pressed SKIP ID WRITE
- c) Selection
- d) 3 seconds
- e) Skip ID (1 second)
- f) Each time you press ►►
- g) 0.3 sec.
- h) Each time you press ◄◄

Normally, the repeated portion is played back 5 times.

When the ◄◄ or ►► button is pressed while the repeated portion is played back, the repeated portion is played back up to 8 times, and then the tape stops.

Erasing

Make sure that the safety tab of the cassette is closed.

During playback or in the stop mode, press the SKIP ID ERASE button immediately after the skip ID to be erased (immediately after the **SKIP ID indicator appears).**

The tape is rewound to the nearest skip ID position and the skip ID is erased. The ERASE indicator lights while the skip ID is being searched for and goes off when the skip ID is erased.

Precaution

When the skip ID and the start ID are overwritten, the skip ID will also be erased if the start ID is erased.

ID to be erased	Operation
Start ID, skip ID	Press the START ID ERASE button.
Skip ID	Press the SKIP ID ERASE button.

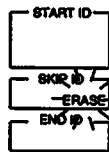
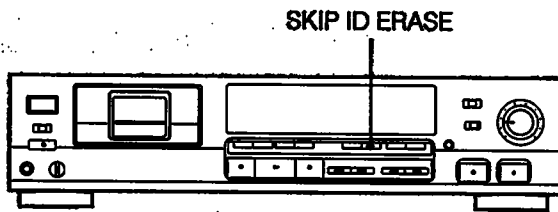

End ID

The end ID indicates the last position of the recording or playback. While recording on the same tape has been done several times, you can locate the point where the previous recording terminates quickly by using the end ID.

When the end ID is detected during playback, the playback stops and the tape is rewound to the beginning automatically.

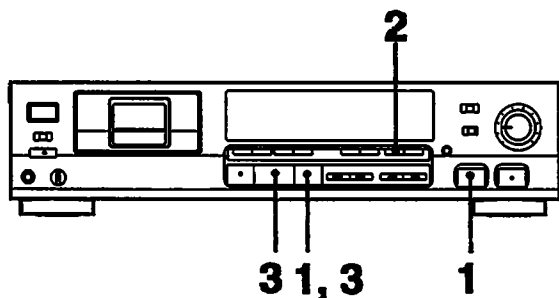

Writing during Recording

- 1 Press the **|| PAUSE** or **OREC MUTE** button to stop recording.

When pressing the **|| PAUSE** button: The deck enters the record-pause mode.

When pressing the **OREC MUTE** button: The deck enters the record-pause mode after a sound muted portion is created for 4 seconds.

- 2 Press the **END ID WRITE** button. The **END ID WRITE** indicator lights.

- 3 Press the **|| PAUSE** or **>> (play)** button to release the record-pause mode.

The "EE" indicator appears on the display.

The end ID is written for about 9 seconds (18 seconds in the long-play mode). Tape returns to the beginning of the end ID after the end ID is written.

After you write an end ID

The portion after the end ID position cannot be played back. (The "EE" indicator appears at the PGM NO. display.)

Erase the end ID (page 42) where you want to play back the portion after the end ID position.

1

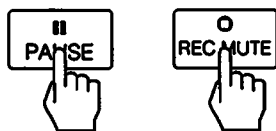

2

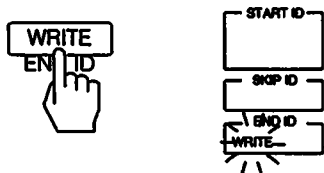

3

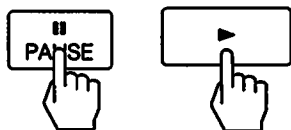

End ID

Writing during Playback (Rehearsal Function)

- During playback, no end ID can be written on a blank section.
- To write the end ID just before a blank section with the end search function, perform "Writing during Recording" described above.
- Make sure that the safety tab of the cassette is closed.

- 1 During playback, press END ID WRITE at the desired position.**
The REHEARSAL indicator lights and the WRITE indicator flashes, and the portion for 3 seconds to the point where you pressed the END ID WRITE button, is played back repeatedly (rehearsal function). The end of the repeated portion will be the beginning of the end ID.
- 2 Press the ◀◀ or ▶▶ button to adjust the "repeat end" point.**
The "repeat end" point is shifted backward with the ◀◀ button or forward with the ▶▶ button by 0.3 of a second.
The indicator at the MARGIN display shows how much the "repeat end" point is shifted from the point where you pressed the END ID WRITE button.
a) When you pressed ▶▶ twice
- 3 After setting the beginning of the end ID at the desired point, press the END ID WRITE button again.**
The 'EE' and WRITE indicators light, and an end ID is written.

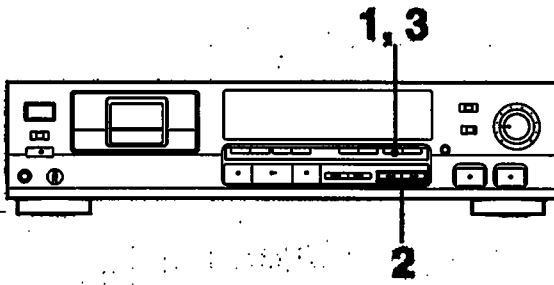

1



2

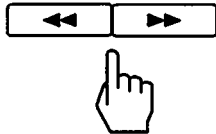

3

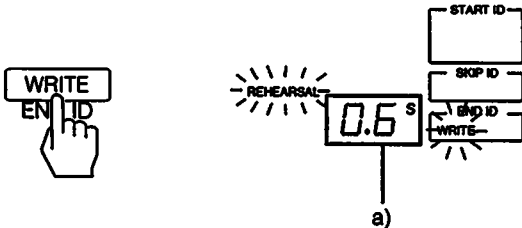

End ID

A

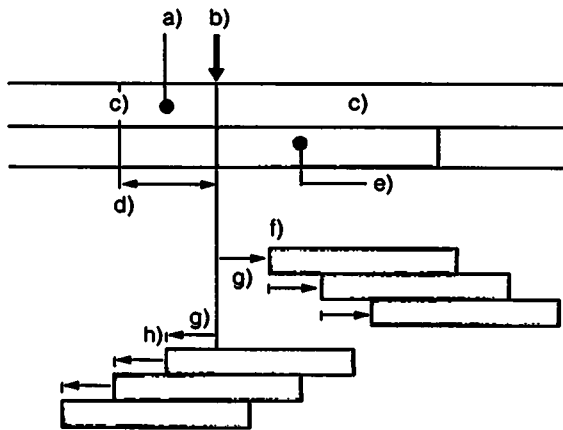

Note on the point where an end ID is written **A**

During rehearsal function, an end ID is written at the end of the repeated portion as illustrated.

- a) Repeated portion
- b) Point where you pressed END ID WRITE
- c) Selection
- d) 3 seconds
- e) End ID (9 seconds)
- f) Each time you press >>>
- g) 0.3 sec.
- h) Each time you press <<<

Normally, the repeated portion is played back 5 times.

When the <<< or >>> button is pressed while the repeated portion is played back, the repeated portion is played back up to 8 times, and then tape stops.

Note

When recording is finished in the middle of a tape, be sure to write the end ID at the end of the last selection.

Erasing

Make sure that the safety tab of the cassette is closed.

- 1** Search for the beginning of the end ID with the >>> button. (Page 26.) When the end ID is detected, the 'EE' indicator lights.
- 2** Press the END ID ERASE button. The END ID ERASE indicator lights while the end ID is being searched for and then goes off when the end ID is erased.

Note

When recording from the point where the end ID is written, the end ID is erased automatically.

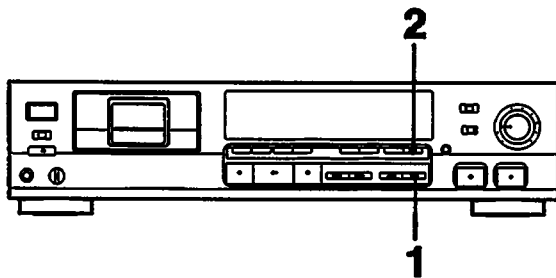

1

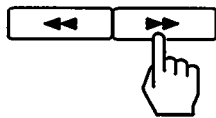

2



Playback

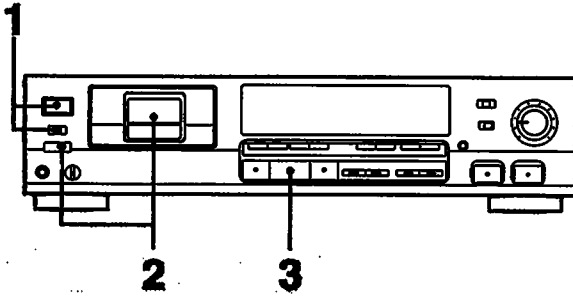

- 1** Make sure that the **TIMER** switch is set to the **OFF** position, and then turn on the power.
- 2** Insert the cassette and press the **▲OPEN/CLOSE** button to load the cassette.
- 3** Press the **▶ (play)** button. Playback begins.
If an end ID is written on the tape or a blank section of more than 9 seconds is detected, playback stops automatically at the end ID position, and the tape will be rewound to the beginning.

To stop playback

Press the **■** button.

To stop playback for a moment

Press the **⏸** PAUSE button.

To release pause and restart playback

Press the **⏸** PAUSE or **▶ (play)** button.

To remove the cassette

Press the **▲OPEN/CLOSE** button.

To rewind or fast-forward the tape

Stop the tape and press the **◀◀** or **▶▶** button.

To advance the tape (cue) with hearing the tape sound*

Press the **▶▶** button during playback.

To rewind the tape (review) with hearing the tape sound*

Press the **◀◀** button during playback.

* Sound is heard while the button is pressed. Release the button at the desired point. Playback resumes.

The speed of the tape increases about 4 seconds after the cue or review starts.

On the volume adjustment

Compared with the analog audio cassette tape, a digital audio tape contains less tape hiss noise. So be sure to turn down the volume before playback.

Adjusting the headphones volume

Use the **LEVEL** control.

When the tape is played back to its end

The tape will be rewound to the beginning and stop automatically.

If tape noise exists, or sound quality has deteriorated

The head may be contaminated. Clean the head, using a cleaning cassette (See page 53).

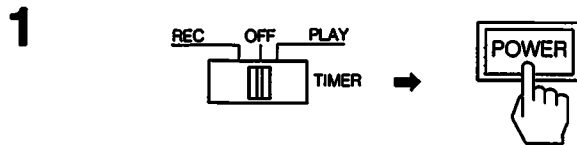

Playback

Display Window **A**

Each time you press COUNTER MODE, the counter changes as follows.

- a) Absolute time
 - b) Remaining time to the end of the whole tape (not to the end of the recorded portion)*
 - c) Linear counter (tape running time)
- * When playing back a pre-recorded tape (software), remaining time to the end of the recorded portion appears.

Notes

- At the beginning of the tape, "33" may appear and immediately go off at the PGM NO. indicator position depending on some types of pre-recorded tapes. ("33" stands for "beginning".)
- To reset the counter to 0M 00S, press COUNTER RESET on the remote commander.

Remaining time does not appear in the following cases

- Immediately after the deck is set in the playback mode.
The remaining time will appear about 16 seconds (in the standard-play mode) later.
- When playback is started from a blank section (page 19), the remaining time may not appear. Press the ◀◀ or ◀◀ button.

Accuracy of the indicator for the remaining time

This unit indicates the remaining time by referring the thickness of the tape. So the remaining time may differ from the actual remaining time according to the type of tape.

A

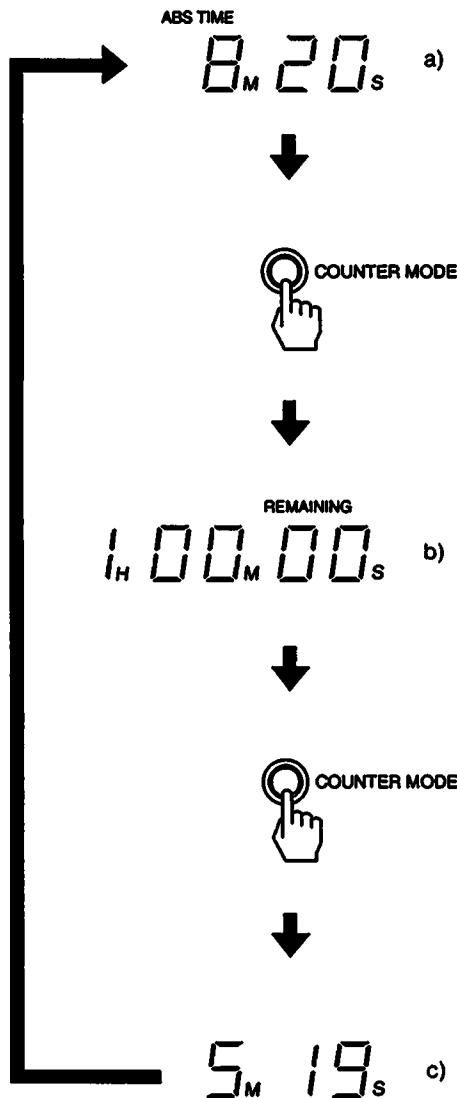

Various Playback Operations

Repeat Play

These functions can be performed only with the remote commander.

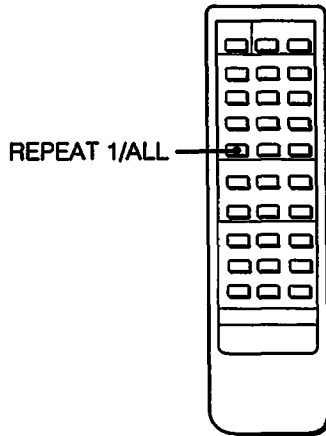

Playing a Selection Repeatedly

Press the REPEAT 1/ALL button on the remote commander while the desired selection is played back.

The REPEAT 1 indicator appears. After the selection is played back, the tape is rewound to the beginning of that selection automatically, and the playback is repeated.

To stop playing a selection repeatedly and return to the normal playback

Press the REPEAT 1/ALL button twice. The REPEAT indicator goes off.

Note on the end of the repeated portion during the REPEAT 1 play

The tape is rewound to the beginning of the selection to be repeated when one of the following is detected.

- Start ID of the next selection
- A blank section of more than 9 seconds
- End of the tape or end ID
- Skip ID with SKIP play activated

Playing all selections repeatedly

During playback, press the REPEAT 1/ALL button until the REPEAT ALL indicator appears on the display.

After the tape is played back to the end, it is rewound to the beginning and the playback of all selections is repeated. In the RMS play (page 50), all the selections programmed are played back repeatedly.

To stop playing all selections repeatedly and return to the normal playback

Press the REPEAT 1/ALL button once. The REPEAT indicator goes off.

Note on the end of the repeated portion during the REPEAT ALL play

The tape is rewound to the beginning of the tape when one of the following is detected.

- End of the tape or end ID
- A blank section of more than 9 seconds

Number of times to be repeated

The selection to be repeated will be played back 5 times, and then the tape will stop.

Various Playback Operations

A

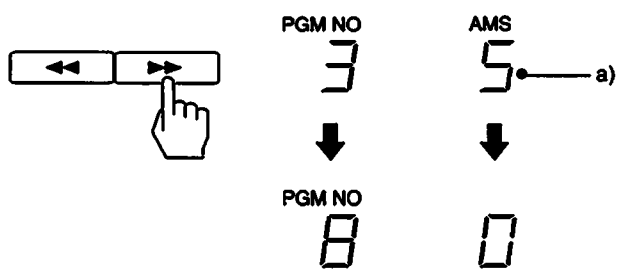

B

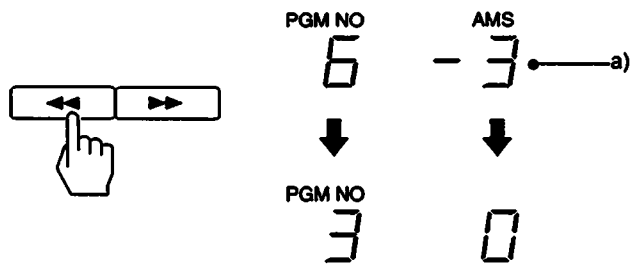

Automatic Music Sensor Operation

When you press the **◀◀** or **▶▶** button during playback or in the stop mode, playback will start from the beginning of the desired selection.

When it is pressed in the pause mode, the deck enters the pause mode at the beginning of the designated selection. Press the **⏸** (PAUSE) or **▶** (play) button to resume playback.

For this operation, the start ID codes must be written on the tape. For how to write the start ID, see page 30.

To locate the selection ahead
 Press the **▶▶** button. Each pressing advances the tape to the next selection in sequence.

Example 1
 To designate five selections ahead, press the **▶▶** button five times.

a) The number of time you pressed **▶▶** is displayed

When the designated selection is located, playback resumes.

To locate the previous selection
 Press the **◀◀** button. Each pressing moves the tape to the previous selection in sequence.

Example 2
 To designate three selection back (excluding the selection being played), press the **◀◀** button four times.

a) The number of time you pressed **◀◀** is displayed

When the designated selection is located, playback resumes. The display returns to the counter display.

When designating the selection being played back by pressing **◀◀** once, **"-0"** appears.

You can designate a selection by pressing the numeric buttons, instead of pressing the **◀◀ or **▶▶** button several times. In this case, press the **◀◀** or **▶▶** button after pressing the numeric buttons.**

Various Playback Operations

Music Scan

With this function, you can listen to the first part of each selection. You can designate the scan time up to 15 seconds in steps of a second. The scan time is 8 seconds if the scan time is not designated. (The designated time remains memorized even if you turn off the unit.) For this operation, the start ID codes must be written on the tape. For how to write the start ID codes, see page 30. This operation can be performed only with the remote commander.

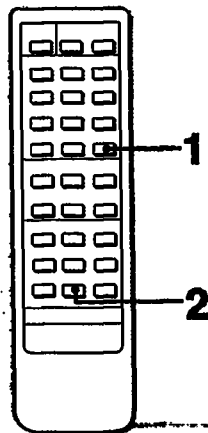

1



MARGIN
8.0^s

2



1 In the stop mode*, press the MUSIC SCAN button.

The MUSIC SCAN indicator flashes and the designated scan time is indicated at the MARGIN display. To designate the scan time, press the ◀◀ or ▶▶ button while the scan time is indicated at the MARGIN display.

2 Press the ▶ (play) button.

The tape is rewound to the beginning, the first part of each selection (start ID position) is played back for the time you designated sequentially. The ▶ and **START ID** indicators light during playback.

When you press the ◀◀/▶▶ button instead of the ▶ (play) button

The nearest start ID before/after the current position is detected and, after playing back the first part of that selection for the time you designated, the next start ID in the reverse/forward direction is located.

This operation continues until the end of the tape.

* When the MUSIC SCAN is pressed during playback, the tape is rewound to the beginning and the music scan starts automatically.

Various Playback Operations

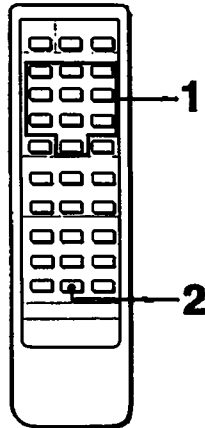

To listen to the beginning of a selection for more than the designated time

Press the ► (play) button while the selection you want to listen to is played back.

While pressing the ► button, the countdown at the MARGIN display stops, and the playback of that selection continues.

To listen to an entire selection

Press the MUSIC SCAN button while the selection you want to listen to is played back.

The music scan function is released, and the playback of that selection continues.

Designating the Desired Selection

By designating the desired program number, you can listen to the desired selections directly.

For this operation, the selections must be numbered by the program numbers. For how to write the program number, see page 34.

This operation can be performed only with the remote commander.

1 Designate the desired program number with the numeric button(s)*.

- a) Current program number
- b) Designated program number

2 Press the ► (play) button.

The designated selection is searched for at high speed and playback starts from the beginning of that selection.

- a) Displayed number is advanced to the designated number one by one.
- b) Goes off.

* When you press the numeric button(s) during play-pause mode, the deck enters the pause mode at the beginning of the designated selection. Press the PAUSE or ► button to resume playback.

If an incorrect number is designated
Before pressing the ► button, press the CLEAR button.

The displayed program number will be cleared. Then designate the correct program number.

Once the ► button is pressed, it is impossible to cancel the designated selection.

1

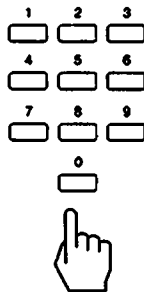

PGM NO



a)



b)

2



PGM NO



AMS



PGM NO



a)



b)

Various Playback Operations

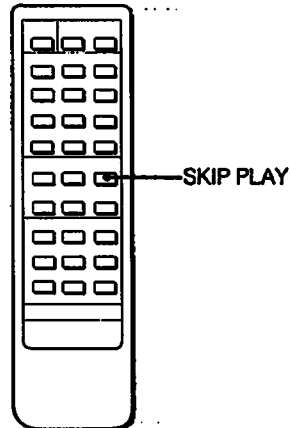

Skip Play

With this function, you can skip the undesired selection which the skip ID is written and listen to the only desired one. For this operation, the skip ID code(s) must be written on the tape.

Press the SKIP PLAY button.

The SKIP indicator lights.

During playback, the tape skips to the next start ID position automatically when a skip ID is detected, and the playback resumes.

To release the SKIP play mode

Press the SKIP PLAY button to turn off the SKIP indicator.

Auto Play: Restarting Playback after Rewinding

While pressing the ◀◀ button, press the ▶ button.

The tape is rewound to the beginning, and playback starts automatically.

Notes

- If the above operation is done immediately after the cassette is inserted, the auto play operation does not function. In this case, press the ▶ button a few seconds after the ◀◀ button is pressed.
- The setting of the skip play and repeat play remains even if the power is turned on/off.

Various Playback Operations

Random Music Sensor (RMS) Operation

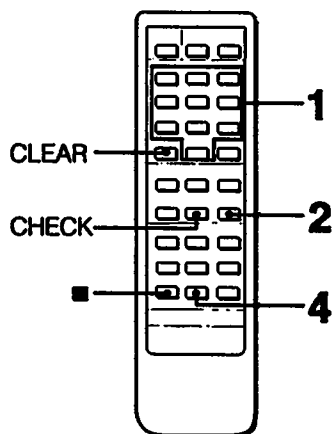

The RMS function allows you to program the desired selections in the desired order. For the operation, program numbers must be written on the tape.

This operation can be performed only with the remote commander.

- 1** Designate the desired selection by pressing the numeric button(s) in the stop mode.
The selection numbers can be specified from 1 to 99.
a) Lights
- 2** Press the ENTER button.
a) Indicates the playing order.
b) The RMS indicator lights after programming the first selection.
- 3** Repeat step 1 and 2.
A maximum of 60 selections can be programmed.
- 4** Press the ► (play) button.
The programmed selections are played back in the designated order

To stop RMS play
Press the ■ button.

To check the programmed selections

Press the CHECK button on the remote commander. Each time you press the CHECK button, the programmed selections appear in the designated order.

To add a selection to the program
Once the RMS play starts, you cannot add a selection. To add a selection, first stop the RMS play, and program new selection(s) by following the procedure described above.

To delete the selection you programmed last

Press the CLEAR button. However, when checking the programmed selection, the CLEAR button cannot be used.

To cancel the entire program

In the stop mode: Press the ■ button once.
In the RMS play mode: Press the ■ button twice.

The program is also erased when the power is turned off.

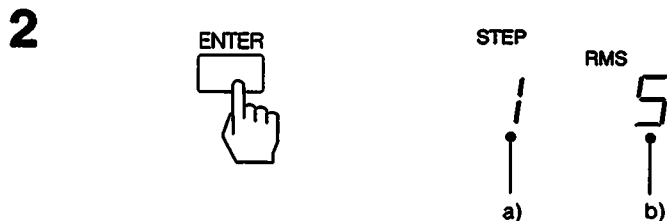
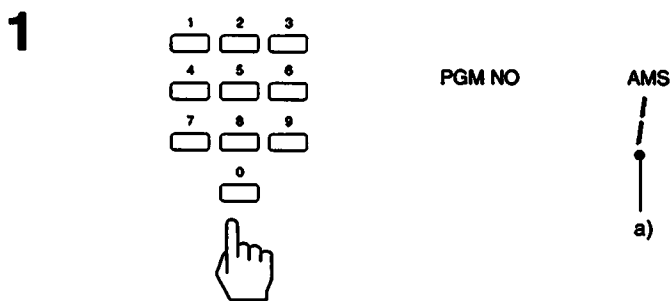

Timer Activated Operation

Use a commercially available audio timer to activate recording or playback at a desired time. Read the operating instructions for the timer and the amplifier.

Timer Activated Recording

- 1 Turn on the timer.**
- 2 Turn on the DAT deck, and prepare for recording. (Follow steps of "recording" on page 21.)**
- 3 Set the timer to the desired time.**
Power to the amplifier and to the DAT deck is turned off. Leave the power switches of the equipment turned on.
- 4 Set TIMER to REC.**
At the preset time, the power is supplied and recording starts after about 4 seconds. The AUTO indicator will be the same as the one before the power of the DAT deck is turned off. When the AUTO indicator lights, start IDs will be written during recording.

When timer activated recording is finished

Be sure to set the TIMER switch to the OFF position.

Precautions

- If the TIMER switch is left at the REC position, recording will start when the power is turned on the next time, and the tape contents will be erased.
- In timer recording (the TIMER switch is set to the REC position), the auto rewind function will not be activated even if the tape is fully taken up. The tape stops without being rewound so that recording will not be performed over the previously recorded material.
- Be sure to activate timer recording with the cassette inserted properly in the cassette compartment. With the cassette compartment lid opened, timer recording will not function.

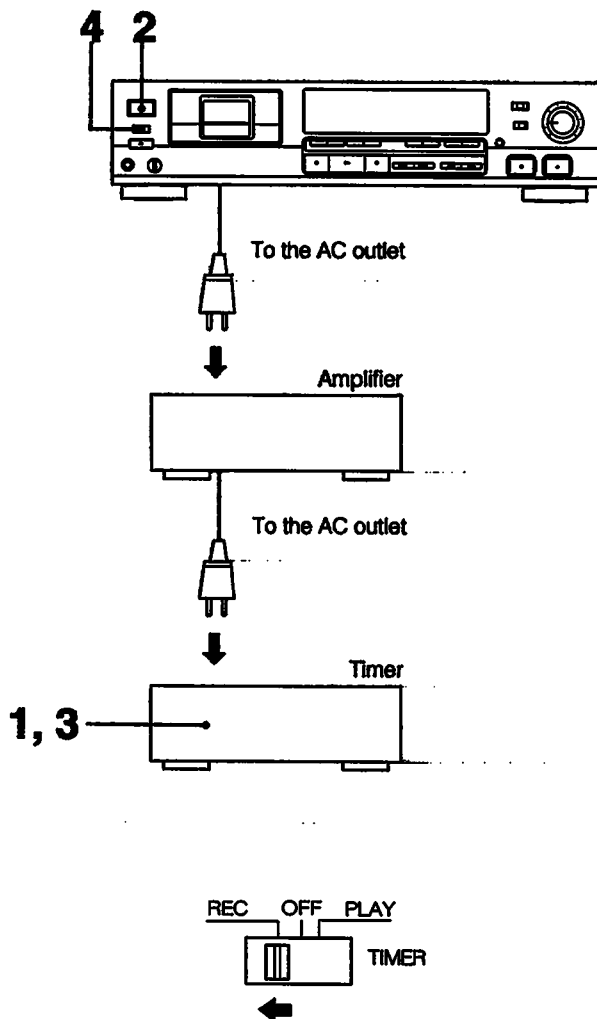

Timer Activated Operation

Timer Activated Playback

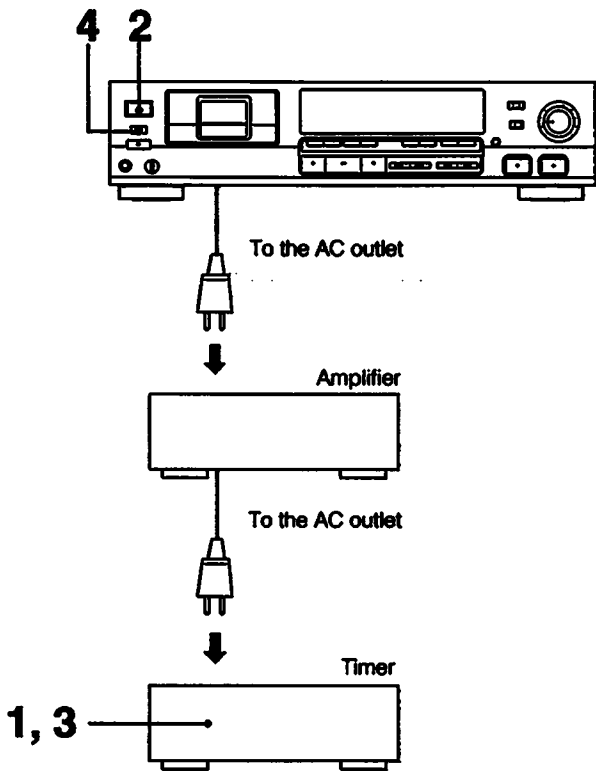

- 1** Turn on the timer.
- 2** Turn on the DAT deck, and insert the cassette.
- 3** Set the timer to the desired time. Power to the amplifier and to the DAT deck is turned off. Leave the power switches of the equipment turned on.
- 4** Set the **TIMER** switch to the **PLAY** position. At the preset time, the power is supplied and playback starts after about 4 seconds.

When timer activated playback is finished
Normally set the **TIMER** switch to the **OFF** position. If you want to start playback at the preset time every day automatically, leave the **TIMER** switch to the **PLAY** position.

4

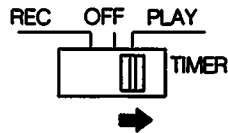

Maintenance

Cleaning the Cabinet

Clean the cabinet, panels and controls with a soft cloth slightly moistened with a mild detergent solution. Do not use any type of abrasive and, scouring powder or solvent such as alcohol or benzine.

Cleaning the Head

Prolonged operation will cause contamination of the head.

To make the best possible recording and playback, we recommend cleaning the head periodically, using the DT-10CL cleaning cassette (not supplied).

How to use the cleaning cassette

- 1 Insert the cleaning cassette as you insert a normal DAT cassette.
- 2 Press ►. Press ■ after about 10 seconds.
- 3 Remove the cleaning cassette without rewinding it.
- 4 Proceed with recording and playback with a normal DAT cassette and check the sound quality.

Notes on the cleaning cassette

- The cleaning cassette cannot be used for recording and playback.
- Do not clean the head with the cleaning cassette more than five times over a short period.
Cleaning the head continuously for a too long period of time may cause wear to the head.
- Do not rewind the cleaning cassette each time you use it. When the cleaning cassette tape is taken up completely, rewind it to the beginning and re-use it. The cleaning cassette can be used two hundred times, with 10 seconds of cleaning each time.

Guide to the Serial Copy Management System

This digital audio tape deck adopts the Serial Copy Management System. This system enables one generation of digital recording of prerecorded software via digital input/output. A summary of this system is as follows:

1

You can record a compact disc to a digital audio tape via digital input/output. But you cannot record the recorded tape to another via digital input/output.

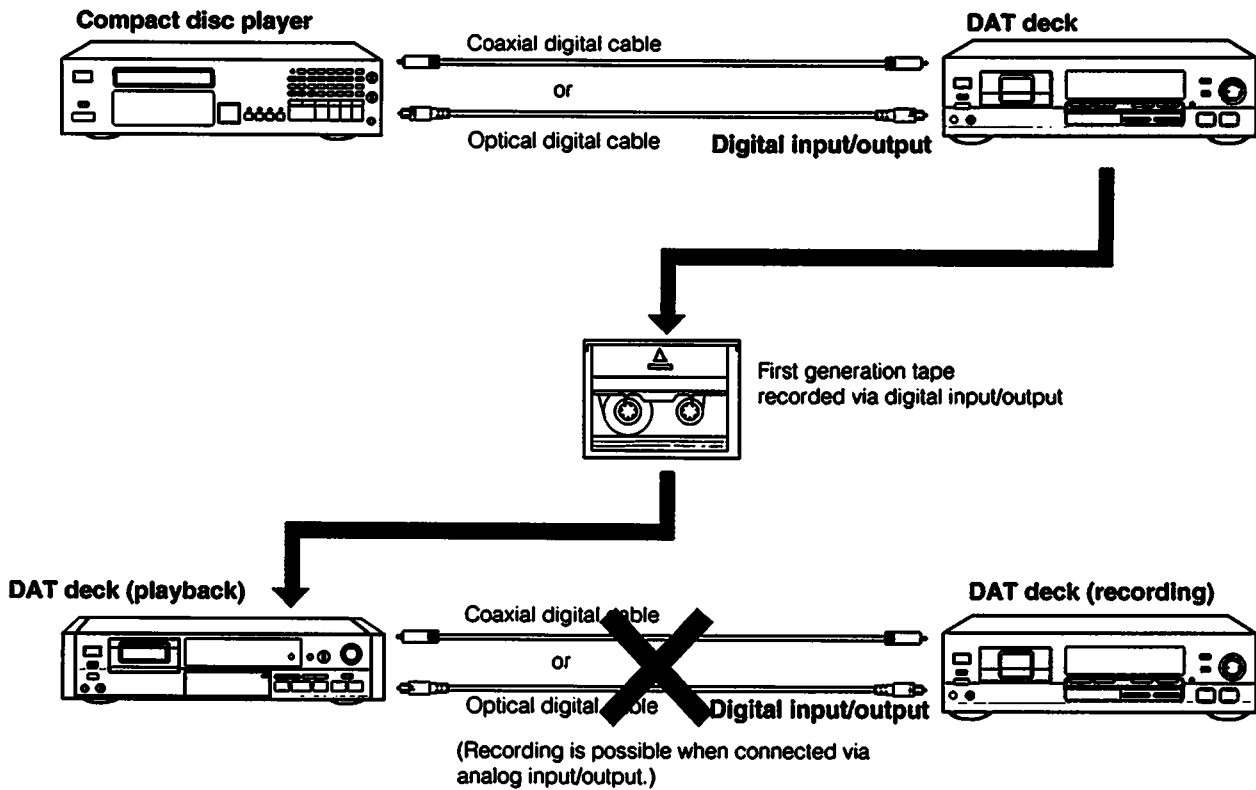

2

You can record a digital audio tape recorded via analog input/output to another via digital input/output. But, you cannot make a second generation tape via digital input/output.

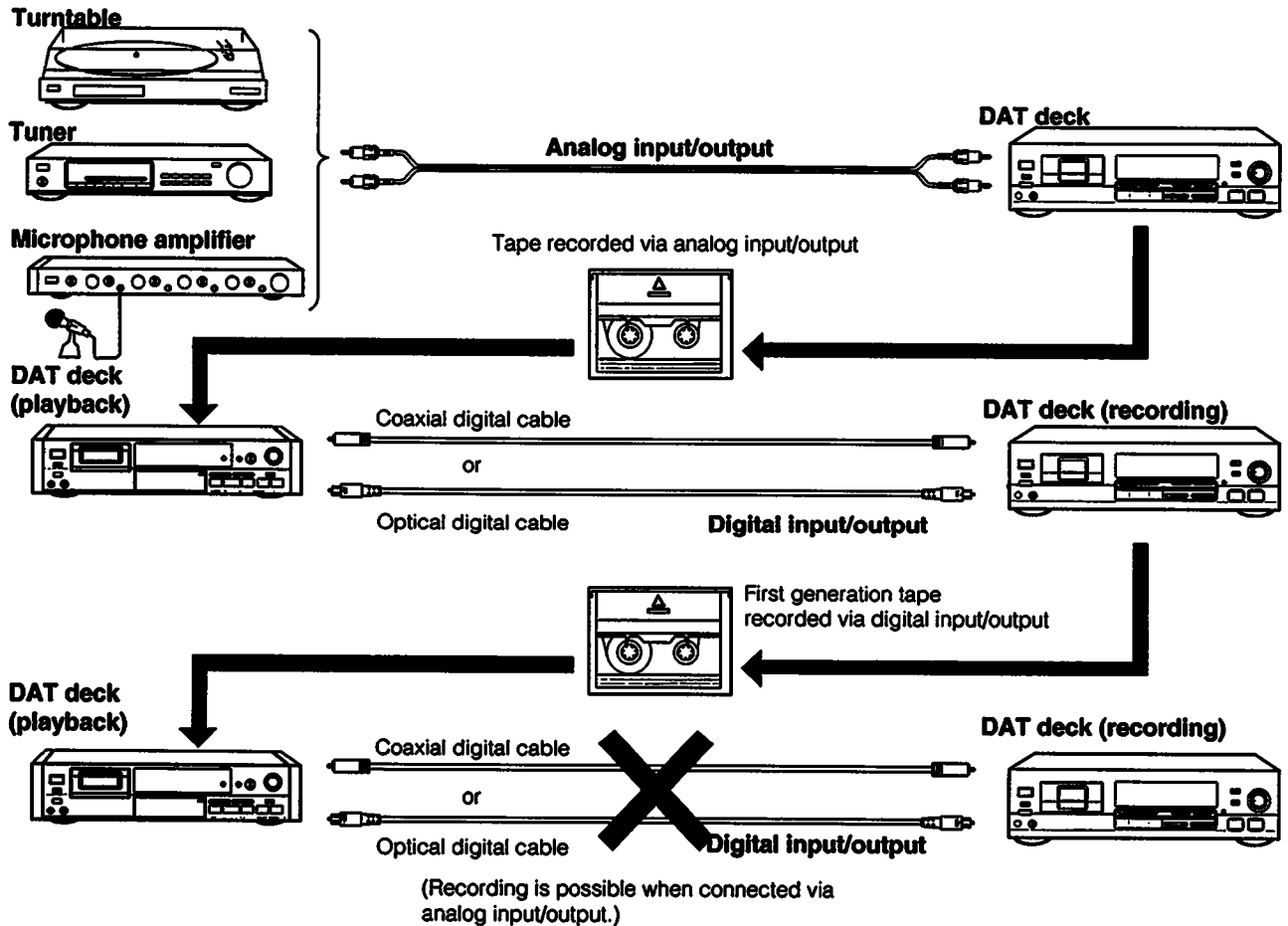

Remarks

There are no restrictions for generation when DAT decks are connected via analog input/output each other. These rules does not apply when you use a DAT deck which does not adopt the Serial Copy Management System.

Troubleshooting Guide

Basic Operation

Symptom	Cause	Remedy
The tape is ejected after being loaded.	The cassette is inserted incorrectly.	Insert the cassette correctly. (page 18)
The tape does not move.	For 4 seconds after the power is turned on, the buttons do not function.	Wait until the blinking of the II indicator goes off and then try again.
	The II PAUSE button is activated. (The II indicator lights.)	Press the II PAUSE button to release pause
	The tape is wound completely.	Press the ◀◀ or ◀◀◀ button to rewind.
The sound is not heard.	Incorrect connections.	Connect properly. (pages 15 to 17)
	Incorrect operation of the connected amplifier.	Operate the amplifier as required by the deck operation. (Refer to the operating instructions of the amplifier.)
Recording cannot be made.	The safety tab of the cassette is open.	Close the tab of the cassette. (page 18)
	Incorrect position of the INPUT selector.	Set the INPUT selector correctly. When recording sound from the equipment connected to the COAXIAL IN or OPTICAL IN jack, set the INPUT selector to the COAXIAL or OPT position respectively. When recording sound from the equipment connected to the LINE IN jacks, set to the ANALOG position.
	The digital copy prohibit signal exists in the source signal input to the digital input jack.	Connect the source equipment to the LINE IN jacks.
The △ OPEN/CLOSE does not function.	The △ OPEN/CLOSE does not function during recording.	Press ■ to stop recording and then press △ OPEN/CLOSE.
The sound is not heard from the recorded tape.	When recording analog input signals, the recording level is turned down completely. (When recording the analog input signal)	Adjust the recording level by using the REC LEVEL control. (page 23)
The CAUTION indicator lights, and no button does function.	Moisture condenses inside the unit.	Leave the unit turned on for about an hour. (page 4)
	Defective or damaged cassette is inserted.	Remove the cassette.
	The cassette is removed forcibly from the cassette compartment.	Turn off the unit and then turn on again.

Sub Code Operation

Symptom	Cause	Remedy
Sub codes cannot be written.	Insert a cassette tape with its safety tab at the record-impossible position.	Insert a cassette tape with its safety tab at the record-possible position. (Page 18)
Start ID cannot be written during recording.	A new start ID cannot be written within 9 seconds (18 seconds in the long-play mode) from the end of another start ID.	Leave at least 9 seconds (18 seconds in the long-play mode) from the end of another start ID.
Search function does not operate during playback.	The start ID is not written correctly.	Erase it (page 33), and then write it again.
	The portion between the end of a start ID and the beginning of the following start ID is less than 9 seconds (18 seconds in the long-play mode) long.	When writing the start IDs manually, write so that the intervals between them are more than 9 seconds (18 seconds in the long-play mode.)
	The selected program number does not exist on the tape. The program numbers are out of order.	Use the RENUMBER button to re-arrange the program numbers. (page 36)
Search function operates suddenly during playback.	The skip play function is operating. (The SKIP indicator lights in the display window.)	Turn off the indicator by pressing SKIP PLAY.
	The repeat play function is operating.	Turn off the indicator by pressing REPEAT 1/ALL.
Search function stops.	There is a blank section between selections. (The sampling frequency indicator blinks on the display.)	Use the end search function (page 26) when recording so that no blank is created.
The tape operation buttons do not operate while writing the start ID.	While writing the start ID (9 seconds or 18 seconds), none of the buttons except the ■ button are operative.	Operate after the start ID is written.
The absolute time codes cannot be written.	Recording was started from the blank section.	Rewind the tape to the beginning, or locate the very last point of the previous recording by using the end search function (page 26), and start recording from the point.
End ID cannot be written during playback.	The portion where you want to write the end ID is blank.	Set the deck in the record-pause mode by pressing ●REC, then write the end ID.
Renumbering function does not operate.	The portion between the end of a start ID and the beginning of the following start ID is less than 9 seconds (18 seconds in the long-play mode) long.	When writing the start IDs manually, write so that the intervals between them are more than 9 seconds (18 seconds in the long-play mode).
Start ID cannot be erased.		
Skip ID cannot be erased.	Two skip IDs are written continuously.	When writing the skip IDs, write so that the intervals between them are more than 1 second (2 seconds in the long-play mode).
End ID cannot be erased.	The end ID is written at the beginning of the tape.	Start recording from the beginning of the tape.
	The end ID is written immediately after a start ID.	First erase the start ID.

Troubleshooting Guide

Others

Symptom	Cause	Remedy
Tape transport noise seems excessively loud in rewind or fastforward mode.	This situation depends upon the cassette being used and is not a problem.	—
The tape stops running suddenly.	A defective or damaged cassette has been inserted.	Press the △OPEN/CLOSE button to change the tape.
Unbalanced left and right volume.	Incorrect adjustment of the recording balance.	Adjust the recording balance correctly by using the REC LEVEL control. (page 23)
Increase of noise or deterioration of sound quality.	Contamination of the head.	Clean the head, using the cleaning tape.
After pressing ◀◀/▶▶ or ⏮/⏭ , the tape stops for a moment, and then starts running.	This is not a problem.	—

Specifications

Tape	Digital audio tape
Recording head	Rotary head
Recording time	Standard: 120 minutes. Long-play mode: 240 minutes (with DT-120)
Tape speed	Standard: 8.15 mm/s, Long play mode: 4.075 mm/s
Drum rotation	Standard: 2,000 rpm, Long-play mode: 1,000 rpm
Error correction	Double Read Solomon code

Tape	
Track pitch	13.6 μ m (20.4 μ m)
Sampling frequency	48 kHz, 44.1 kHz, 32 kHz
Modulation system	8-10 Modulation
Transfer rate	2.46 Mbit/sec.
Number of channel	2 channels, stereo
D/A conversion (Quantization)	Standard: 16-bit linear Long-play mode: 12-bit non-linear
Frequency response	Standard: 2-22,000 Hz (\pm 0.5 dB) Long-play mode: 2-14,500 Hz (\pm 0.5 dB)
Signal to noise ratio	Standard: more than 90 dB Long-play mode: more than 90 dB
Dynamic range	Standard: more than 90 dB Long-play mode: more than 90 dB
Total harmonic distortion	Standard: less than 0.005% (1 kHz) Long-play mode: less than 0.08% (1 kHz)
Wow and flutter	Below measurable limit (\pm 0.001% W. PEAK)

Input

	Jack type	Impedance	Rated input level
LINE IN	phono jack	47 kohms	-4 dBs
DIGITAL IN	phono jack	75 ohms	0.5 Vp-p, \pm 20%
DIGITAL IN	optical jack	—	—

Output

	Jack type	Impedance	Rated output	Load impedance
LINE OUT	phono jack	470 ohms	-4 dBs	More than 10 kohms
PHONES	stereo phone jack	220 ohms	1.3 mW	32 ohms

DIGITAL OUT (optical jack): wavelength 660 nm

General

Power requirements	120 V AC, 60 Hz
Power consumption	31 W
Dimensions	Approx. 430 x 110 x 350 mm (w/h/d) (16 ¹⁵ / ₁₆ x 4 ³ / ₈ x 13 ⁷ / ₈ inches)
Weight	Approx. 5 kg (11 lb)

Remote commander (supplied)

Remote control system	Infrared control
Power requirements	3V DC, with two size AA (R6) batteries
Dimensions	Approx. 40 x 20 x 175 mm (w/h/d) (1 ⁹ / ₁₆ x ¹³ / ₁₆ x 7 inches)
Weight	Approx. 100 g (4 oz) incl. batteries.

Supplied accessories

Remote commander RM-D690A (1)
Sony batteries SUM-3(NS) (2)
Audio connecting cords (2 phono plugs - 2 phono plugs, stereo for line inputs and outputs) (2)

Design and specifications are subject to change without notice.

Accessories not supplied

Optical cable POC-15, POC-10HS etc.
Connecting cord RK-C710HS, etc.
(2 phono plugs - 2 phono plugs: connectors plated with gold, high fidelity LC-OFC line cord)
VMC-1ES, etc. (phono plug - phono plug): for digital connection
DT-10CL

Cleaning cassette

Free Manuals Download Website

<http://myh66.com>

<http://usermanuals.us>

<http://www.somanuals.com>

<http://www.4manuals.cc>

<http://www.manual-lib.com>

<http://www.404manual.com>

<http://www.luxmanual.com>

<http://aubethermostatmanual.com>

Golf course search by state

<http://golfingnear.com>

Email search by domain

<http://emailbydomain.com>

Auto manuals search

<http://auto.somanuals.com>

TV manuals search

<http://tv.somanuals.com>