

CMD-CD18

SERVICE MANUAL

Chinese-Model

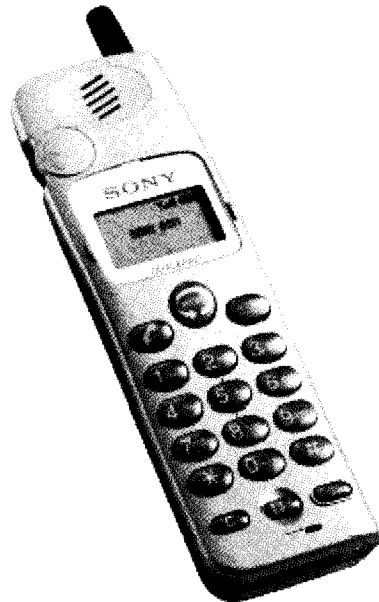

SPECIFICATIONS

Signalling format	Dual-Band
Frequency range	E-GSM 900 MHz, Transmit: 880 ~ 915 MHz Receive: 925 ~ 960 MHz DCS 1800 MHz , Transmit: 1710 ~ 1785 MHz Receive: 1805 ~ 1880 MHz
GSM power class	Class 4 (2W)
DCS power class	Class 1 (1W)
SIM chip	Pluggable mini SIM card
Display	High resolution full graphics display Resolution: 97 x 33 pixels 1 header line for icons -3 lines x 16 large characters
Channel spacing	200 kHz
Number of channels	E-GSM: 174 DCS: 374
Frequency stability	Transmit frequency drift (synchronized) < $\pm 0,1$ p.p.m
RF output power	GSM: 2W DCS : 1W
Battery life	Standby : 50h -180h standard battery 70h -250h extended battery Talk time : 2h30 - 6h standard battery 3h30 - 8h20 extended battery

**PORTABLE DIGITAL CELLULAR TELEPHONE
WITH ACCESSORIES**

SONY

Power requirements	3.8 V (nominal)
Operating temperature	-10°C to +55°C
Accessories operating temperature	± 0°C to +45°C
Battery pack charging temperature	± 0°C to +40°C
Dimensions	139 mm x 45.5 mm x 26.5 mm ³
Weight	139 g
Volume	120 cm ³
Supplied accessories	Power adapter : QN-2AC1 (AEP) QN-2AC2 (UK) QN-2AC3 (Australia)
Optional accessories	Battery (std.) QN-CD5BPS Battery (extd.) QN-CD5BPE Cigar Lighter Charger QN-2CC Travel Charger QN-2TC Handsfree kit QN-CD5HFK EasyCom(SoftModem) QN-2EC PC-Card QN-2PCM Headset QN-2HS Desktop Charger QN-CD5DTC

Design and specifications are subject to change without prior notice.
This appliance conforms with EEC Directive 87/308/EEC regarding interference suppression.

NOTE

This device contains electrostatic sensitive components. Damage can occur to these components if the appropriate handling is not adhered to.

Handling precautions:

A working area where Digital Cellular Telephones may be safely handled without undue risk of damage from electrostatic discharge, must be available.

The area must be equipped as follows:

- All working surfaces must have a dissipative bench mat, safe for use with live equipment, connected via 1.2MΩ resistor to a common ground point.
- A quick release skin contact device with a flexible cord, which has a built in safety resistor of between 5.2MΩ and 1.2MΩ shall be used. The flexible cord must be attached to a dissipative earth point.
- All containers and storage must be of the conductive type.

Batteries:

This device contains an internal battery in addition to the external battery packs. These batteries are recyclable and should be disposed of in accordance with national legislation. They must not be incinerated, or disposed of as ordinary rubbish.

TABLE OF CONTENTS

SECTION 1

Specifications	(see Cover sheet)
----------------------	-------------------

SECTION 2

General Descriptions

2.1 Multi Band	05
2.2 Real Time Clock	05
2.3 Vibra Alert Functionality	05
2.4 Battery Safety	05
2.5 Battery Capacity	06
2.6 Accessory Interface	06-07
2.7 RF Antenna connector / antenna switch.....	08
2.8 Languages	08

SECTION 3

Available Accessories

3.1 Hands free kit	QN-CD5 HFK.....	09
3.2 Cigar Lighter Charger	QN-2 CC.....	09
3.3 Travel Charger	QN-2 TC.....	09
3.4 EasyCom-SoftModem	QN-2 EC.....	09
3.5 PC Card	QN-2 PCM.....	10
3.6 Head set	QN-2 HS.....	10
3.7 Desktop Charger	QN-CD5 DTC.....	10
3.8 Extended Battery	QN-CD5 BPE.....	10

SECTION 4

Operating Instructions

4.1 Basic Features	11
4.2 Icon Glossary	12
4.3 Menu Overview	13

SECTION 5

5.1 Disassembly	14-15
5.2 Interface to GSM-Tester	16

SECTION 6

Programming Instructions

6.1 Requirement	17
6.2 Hardware set-up	17
6.3 Software set-up	17-18
6.4 Display contrast adjustment	19

SECTION 7

7.1 Block Diagram – Radio Frequency	20
7.2 Block Diagram – Baseband	21

SECTION 8

Exploded View	22
---------------------	----

SECTION 9

9.1 Spare Parts and Accessories List	23
--	----

SECTION 2

GENERAL DESCRIPTIONS

2.1 Multi-band :

CMD-CD18 support E-GSM 900 and DCS 1800 multi-band functionality.

Because the usage of multi-band depends on network capabilities, the phone is able to operate as a single band mobile in GSM 900 as well as in DCS 1800; In addition it supports the extra functionality required for multi-band mobile stations: Inter-band/"seamless" hand-over, channel assignment, cell selection and re-selection, all between both bands within a **Public Land Mobile Network**.

The manual and automatic PLMN selection in both bands is given.

The user does not need any special action to use the multi-band functionality of the phone. Users are able to manually roam between PLMN's operating in GSM 900 and DCS 1800 bands.

The CMD-CD18 is a phase II, GSM 900 class 4, DCS 1800 class 1 mobile phone. The nominal maximum output power for GSM 900 is 2W, for DCS 1800 1W.

2.2 Real Time Clock (RTC):

The real time clock is integrated into the phone.

When the mobile is switched on the RTC is powered via the CPU.

When the phone is powered down, the RTC is powered from the main battery via it's own low quiescent current regulator.

When the main battery is low or removed, a back-up battery keeps the clock alive.

After the main battery has reached a voltage level of 3.5V the RTC keeps the time for 10 days. After the main battery is removed the RTC keeps the time for 10 min.

2.3 Vibra Functionality

The vibrator is a 1.3V device with a vibrating frequency fixed at 120Hz ($\pm 20\%$) and located in the handset.

A general port pin of the CPU controls the switch mode of the vibration motor. It is powered directly from the battery by an interface control unit. If the mobile is in the phase of switching on or off the vibrator is off at all times.

2.4 Battery Safety

The battery pack contains a safety circuitry. The charging circuitry and the safety circuitry together guarantee a double fail-safe battery pack. This means that each component can be either short or open and still all the safety requirements will not be violated.

The safety concept protects against:

Over voltage: The charging is stopped when Battery Voltage (Vbat) reaches (4.24V- 4.3V). The charging resumes when Vbat falls below (4.11V - 4.23V).

Under voltage: When the cell voltage drops below (1.3V - 1.7V) the cell is disconnected for discharging. Charging is still possible.

2.5 Battery Capacity:

Standard Battery	1000mAh typical	Li-ion QN-CD5BPS
Extended Battery	1450mAh typical	Li-ion QN-CD5BPE

The phone can be charged even during making phone calls.
However, the shortest charging time will be reached when the phone is switched off.

As the charging circuit is integrated in the battery pack, the phone cannot be powered up by the charger without the battery pack being attached.

2.6 Accessory interface

The table explains what kind of pins the phone supplies to the different accessories.

Pins	GND 18	Charge 1/2	ACC_ power 3	Audio IN 14	Audio Out 13	ACC ID 11	ACC Detect 6	TX (OUT) 9	RX (IN) 10	AGND 12
Charger	√	√								
CLC	√	√								
Desktop charger	√	√								
Head set	√		√	√	√	√	√			√
HFK	√		√	√	√	√	√			√
PCMCIA	√		√			√	√	√	√	
EasyCom	√		√			√	√	√	√	

Connector layout

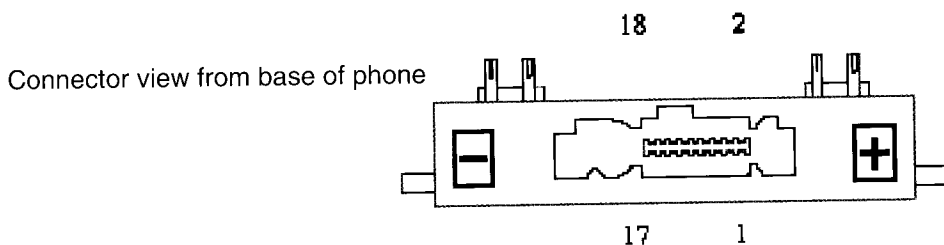

The connector comprises the following pins:

Detection:

The detection of accessory is done by the charge pin and the detect pin.

Any accessory with an active charge will wake up the phone.

The insertion and removal of the charger (Cigar Lighter Charger, Desktop-Charger, AC-Charger) is detected via polling. To reduce the power consumption the polling can take up to 5 sec.

The insertion and removal of other accessory is detected via an Interrupt. This detection is only possible when the phone is powered up.

ID:

The ID pin indicates what kind of accessory is connected.

ACC power:

ACC-power has different functionality with different accessories. ACC-power supplies power to the headset (min.2.7V and min. 10 mA) or will be used as a signaling pin for the Hands Free Kit.

In the car-kit environment the ext. Vbat indicates that a phone call is accepted/in progress. This information is used by the car-kit to power up the audio section of the car-kit, mute the car stereo and keep the car-kit powered up even when the ignition is switched off.

Due to the fact that the ID of the accessory is detected first, the ACC power is not current limited (protected).

RX and TX:

This is the communication interface to the PCMCIA card "QN-2PCM" or the PC-link cable "QN-2EC".

Audio In and Audio Out

These pins build the audio interface to the Head-Set and the Hands Free Kit.

Audio IN:

To limit the noise which is coupled on the Mic-line, the Mic amplifier in the Hands Free Kit "QN-CD5HFK" and Head-set "QN-2HS" have an output 280mVrms into 10k Ω .

Audio OUT:

The single ended output delivers 265mV into a 32 Ω load.

2.7 RF Antenna connector / antenna switch

To connect an external antenna for accessory use, the CMD-CD18 contains a stable RF connector with an integrated mechanical switch. This connector is placed on the PWB. The integrated mechanical switch switches between the helix antenna and the external RF antenna connection. The switching criterion is mechanical pressure from the RF accessory connector.

2.8 Languages

The CMD-CD18 supports the following languages:

- Chinese (Simpl.)
- Chinese (Trad.)
- English

SECTION 3 ACCESSORIES

3.1 Hands Free Kit

The Hands Free Car Kit QN-CD5HFK is designed to offer superior speech quality and Full Duplex speech transmission. In Full Duplex operation both parties can speak simultaneously. The Car Kit has a RF connector for the use of an external antenna to offer a high quality radio link to the base station. It is a one box design for quick and easy installation.

Specifications:

Input voltage	DC 12V-24V, negative ground
Rated output voltage	5.0V
Rated output current	500mA

3.2 Cigar Lighter Charger

The QN-2CC Cigar Lighter Charger is only for use in vehicles equipped with a 12-24 volt negative ground electrical system. This Charger is intended for charging purposes only and not for making/receiving phone calls in the car.

Charging Time:

Full charging can take up to ~3 hours, but will be longer if the CMD-CD5 is switched on or if the temperature is outside the 0°C - 45°C operating range.

Specifications:

Input voltage	DC 12-24V, negative ground
Rated output voltage	5.0V
Rated output current	500mA

3.3 Travel Charger

The Travel Charger QN-2TC is a small and lightweight device. It has a full Input Voltage Range from 100-260Volts. Using a standard cable makes the connection to the mains socket.

Specifications:

Input voltage	100 to 260 V
Rated output voltage	5.0V
Rated output current	500mA

3.4 EasyCom (Soft Modem)

The EasyCom QN-2EC Data Cable connects the phone to a PC via a RS 232 cable. It supports SMS and Phonebook function as well as Full Data/Fax Capability 9.6 Kbps. This configuration is available for Windows 95/98.

3.5 PCMCIA Card

The functionality of the PC Card QN-2PCM is the same as the Data Cable QN-2EC.

3.6 Headset

The Headset QN-2 HS supports full Handsfree Operation, Auto Answering to incoming calls, as well as with microphone muting function.

3.7 Desk Top Charger

The desktop charger QN-CD5 DTC can charge either the Standard or Extended battery with the phone attached. The Desk Top Charger gets its power supply via the Power adapter or the Travel Charger QN-2TC.

Specifications:

Input voltage	DC 5V
Rated output voltage	5.0V
Rated output current	500mA

3.8 Extended Battery

Specifications:



Lithium Ion Battery	QN-CD5 BPE
Maximum output voltage	DC 4.2V
Nominal output voltage	DC 3.8V
Capacity	1450mAh

SECTION 4 OPERATING INSTRUCTIONS

The Basic Features of Your CMD-CD18

The Jog Dial

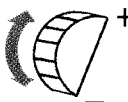

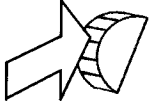
The Jog Dial provides One-Handed Operation navigated by your left hand, freeing your right hand for other activity like taking notes, etc. Give the Jog Dial a quick turn in either direction in standby mode to spin through the main menu options. With one simple press of the Jog Dial in standby mode (the Network Operator name appears on the display), the Phonebook is at your fingertips. Press and hold the Jog Dial (for more than one second) to call a Phonebook selection or number on the display.

Operation Function		Function
Rotate		Scrolls through menu options.
Press (click)		Selects an option (highlighted) in the display. Accepts an entry made by alphanumeric keys.
Press and hold		Dials the phone number selected. Exits from one menu to the previous one.

The Menu Key

In standby mode, press the Menu key and then use the Jog Dial to spin through the Main Menu with options to change your phone settings and access different features. See also Menu Operation.

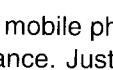
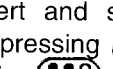
The Manner key



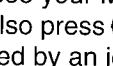
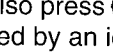



This is the key to good mobile phone manners. Press  once to quickly turn the ringer and all tones to silent mode to avoid disturbance. Just press twice and the ringer is restricted to a discrete single beep. Press again to turn on the Vibra Alert without the ringer; once more to turn on the Vibra Alert and ringer simultaneously; and again to turn the Vibra Alert and single beep ringer. To turn the ringer on again, simply press  again. For your convenience, pressing  in standby mode will toggle between the two last settings. However when the phone is ringing, pressing  once will always turn the ringer and all tones to silent mode. The icons shown above will help you to see your Manner Key setting at a glance in standby mode.

During a call you can also press  again to turn on the microphone. For your reference, the options you activated using  are indicated by an icon in the display. See also Icon Glossary.

The Voice Mail Key



















To speed dial your Voice Mail, press and hold the  to automatically dial your "personal answering service" to listen to messages, etc. See also Phonebook, Voice Mail.

The Keypad Lock

Your CMD-CD18 can be locked to avoid involuntary dialing or menu scrolling especially when carrying your mobile phone. Simply press  followed by  key to lock your CMD-CD18 keypad and even the Jog Dial restricting any activity EXCEPT emergency calls (112). It is still possible to answer an incoming call  and even reject an incoming call by pressing  when the keypad is locked. Simply repeat the key combination  then  in order to unlock your phone again.

Icon Glossary

Your phone lets you see at a glance if you have missed calls, have messages waiting, and the status of options you have selected (like if you have diverted your phone or turned the ringer off). Sony has developed the following icons to provide you with a quick overview of your mobile activity:

ICON	Explanation
	Keypad locked
	SMS Message (flashing = message storage full)
	Voice mail Notification
	Battery strength (flashing = battery level low)
	Network strength
	Network not available (no calls possible)
	Active call
	Incoming call
	Option activated
	Option deactivated
	Missed calls
	Divert option activated
	Vibra Alert activated
	Vibra Alert + Ringer activated
	Vibra Alert + Single Beep activated
	Ringer switched to volume 0
	Ringer and all tones switched to Silent Mode (off)
	Ringer switched to Single Beep
	Ringer Volumes choices
	Speaker Volume
	Microphone Mute

Menu Overview

Rotate the Jog Dial or press the Menu key from standby mode to access the main menu:

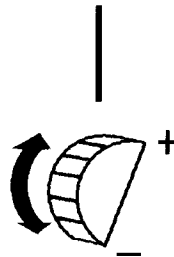
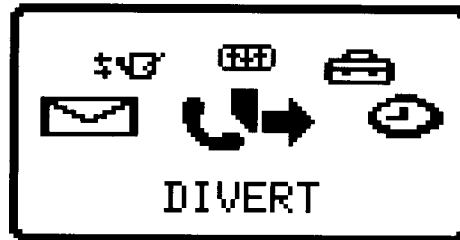

DIVERT	MESSAGING	REDIAL LIST	CONTROL	PRE-FERENCES	TOOLS
If not Reachable	Read	Last Calls	Security	Caller ID	Clock
If No Reply	Create	Received Calls	Network Services	Select Line*	Calculator
If Busy	Service Centre	Missed Calls	Time, Cost	Language	Calendar
All Calls	Settings	Clear All		Ringer Volume	Data Services
Clear All	Local Area Info			Ringer Tone	
				1Minute Beep	
				Key Click Sound	
				DTMF Tones	
				Illumination	
				Auto Redial	
				Auto Answer	
				Any Key Answer	
				Welcome Message	
				Factory Reset	

* Network-dependant

SECTION 5 DISASSEMBLY

IMPORTANT NOTE :

The IMEI Sticker mounted on the main board (visible from the battery compartment) should not be removed at all. The IMEI number is the electronic identification of the hardware, and it is stored electronically. There should be no discrepancy between the number on the sticker and the number within the set logic allowed.

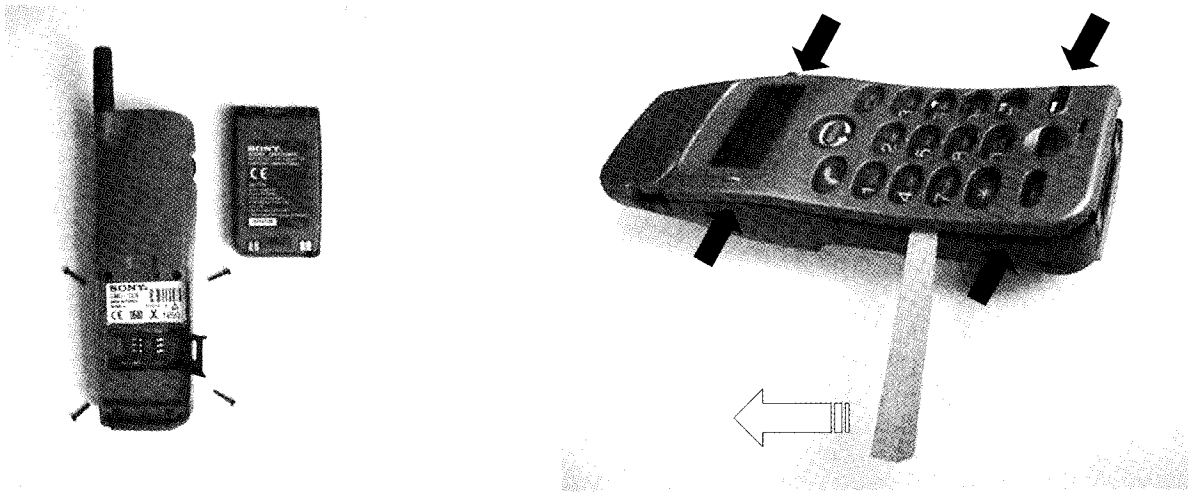

Remove the battery and the 4 screws in the battery compartment. Note that the SIM card is also located in this area

Insert the hook release jig (p/n 3-043-180-01) in the gap between upper and lower case. Then gently slide the jig in the direction of the white arrow. This is to release the claws between the upper and lower case (as indicated by the black arrows).

Important: Do not insert the hook release jig too deep into the gap, that might result in damaging the PWB while sliding the jig.

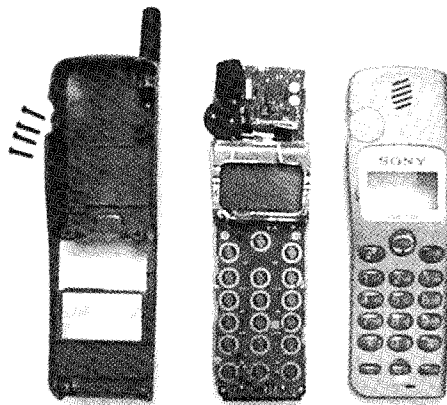

The front cosmetic and back cosmetic can now be separated, and the main board can be taken out.

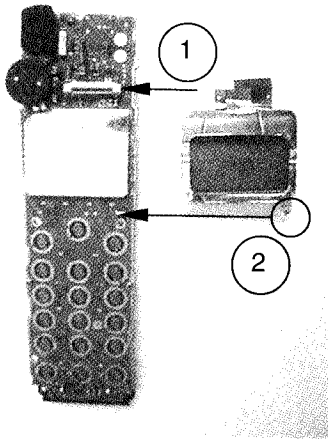

The LCD unit can be lifted out in the way as follows:

1. disconnect the flex cable
2. unsolder the cushion
3. release the LCD assembly clips from the main board.

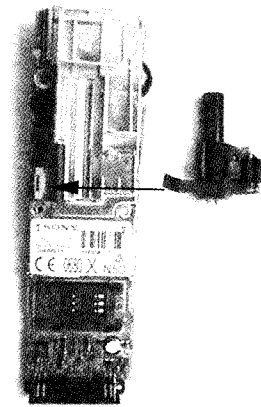

The Vibra Alert unit consisting of the Vibra motor, Capacitor and the flex cable, is attached to the shield case. It is removed by disconnecting from the 9pin connector.

IMPORTANT: Do not detach the shield case from the main board



Parts on the main board specified in the parts list can now be reached.

Re-assembly procedure :

To re-assemble the unit, apply the reverse order of the above mention disassembly procedure.

5.2 Interface to GSM-Tester

CMD-CD18 Level 1 Testing with GSM Tester

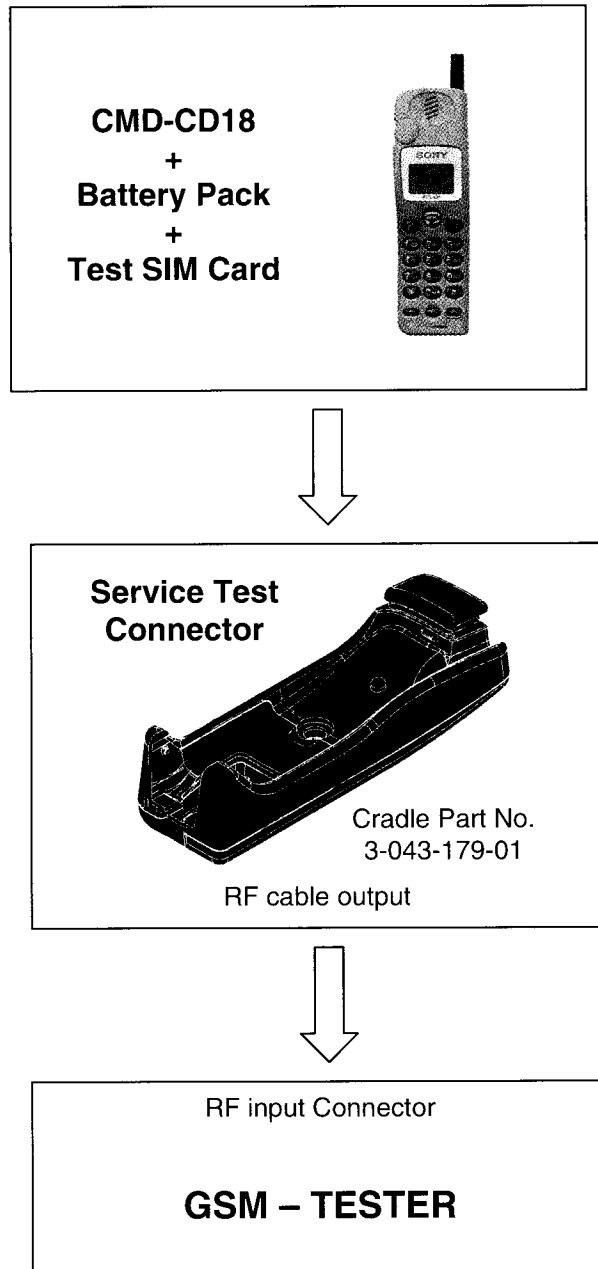

Level Test Procedure with GSM TESTER recommendation:

- Simulate GSM call processing –to check the functionality of transmit and receive audio of loudspeaker and microphone.
- Basic GSM transmission & reception parameter testing –to ensure handset's performance compile with standard GSM specification.

Section 6

PROGRAMMING INSTRUCTIONS

6.1 Requirement

- PC (486 type or higher) with Microsoft "Windows" Operating System
- One COM-port free for usage
- The Data Transfer Jig (p/n 1-792-172-11)

PREPARATION FOR SOFTWARE UPDATE

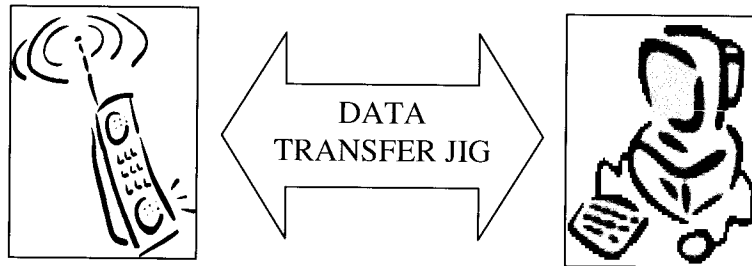

6.2 Hardware set-up

- Copy all the files to the PC (define own directory).
- Connect the Data Transfer Jig to the PC COM-port (COM 1 or COM 2) and the CMD-CD18 external connector.
- Attach battery pack to CMD-CD18; the CMD-CD18 is powered up from the battery pack.
- The initial settings of the flash.exe program may not correspond with the normally correct settings. It is highly advisable to check the settings first (see 3. Software set-up).

3. Software set-up

* Loading new software into the flash

- Start the program flash.exe by double-clicking on its icon in the explorer.  Flash.exe
- Select "File"/"Settings..." and check if the settings for the "Com Port", the "Baud Rate" and the "Erase Mode" are correct. Normally the "Load Options" do not have to be changed. The default values are :

Com Port :	COM 1
Baud Rate :	115200
Load Options :	Both
Erase Mode :	Program Area, Smart Erase (! disable melody area for normal software update) (! disable NVM data area for normal software update)

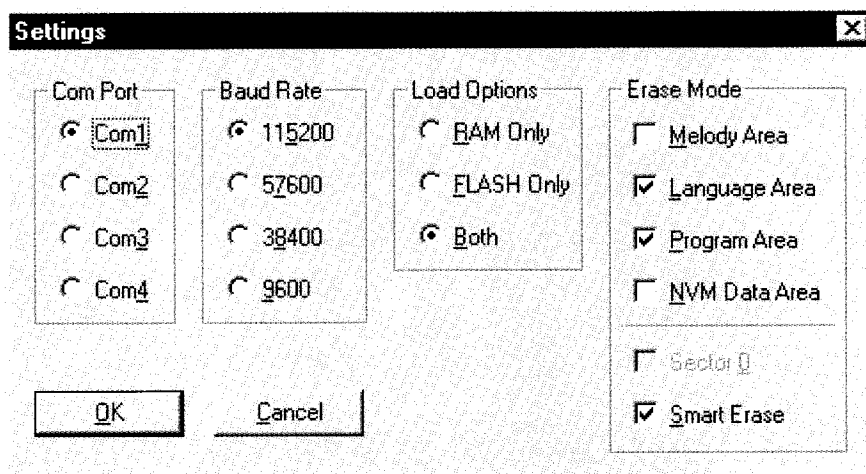

After changing the settings, the new values are stored in the file "flash.ini" in the windows directory.

- Click on "File"/"Open..." and select an SRE file for downloading.
 - The CMD-CD18 software is located in the CD18.SRE file.
 - Any other SRE file is either only needed for the program itself, or can be a melody file (see below)

There are 3 kinds of SRE files:- "CD18.sre" for actual software download
 - "melody.sre" for melody software download
 - "fuflash.sre" is an application software (do not use / modify)

- Press the "LOAD" button of the program.
- Switch on the CMD-CD18.
- Now the program runs automatically.

NOTE

- CMD-CD18 Flash Loader can allow for erasing the entire personal phone book entries and all adjustment settings, by selecting "NVM DATA AREA" only.
 A warning message is displayed if this item is selected.

Once the entire phone book entries are erased, there is no possibility to recover the data.

- CMD-CD18 Flash Loader can allow for loading different ringer melodies by selecting "MELODY AREA" only, then load the new file CD18melody.sre.

It is important to change the erase mode settings back to "PROGRAM AREA" and "LANGUAGE AREA", in preparation for software update.

6.4 Display contrast adjustment

1. The hardware set-up for this adjustment is the same as for the software update.
2. Once the hardware connection is made, the CMD-CD18 must be powered on with the battery pack.
3. The display contrast adjustment software is DOS-based, the program name is LCDCONT.EXE.
4. When activating this program (either from within Windows or from the DOS prompt), by default COM port 1 is selected as the interface between PC and the external connector of the CMD-CD5.

For other COM port selection, go to DOS prompt and enter the following parameter: LCDCONT.EXE -p<port>. (where <port> is the number of the COM port you want to activate)
For example: to select COM port 2, the correct command to activate the program is: LCDCONT.EXE -p2.
5. When the program is correctly set and activated, the following sequence will appear on the PC:

Waiting for mobile (this message will appear for a few seconds only)
LCD contrast: **X** (**X** is a numeric value between 0 and 15)
6. The LCD contrast is adjustable by keying the (↑) and (↓) arrows while observing the CMD-CD18 display.
7. Once the best contrast setting is adjusted, just exit from the program and leave the DOS prompt. The adjusted value will be automatically written into the CMD-CD18 memory.

SECTION 7 DIAGRAMS

7.1 Radio Frequency (RF) Block Diagram

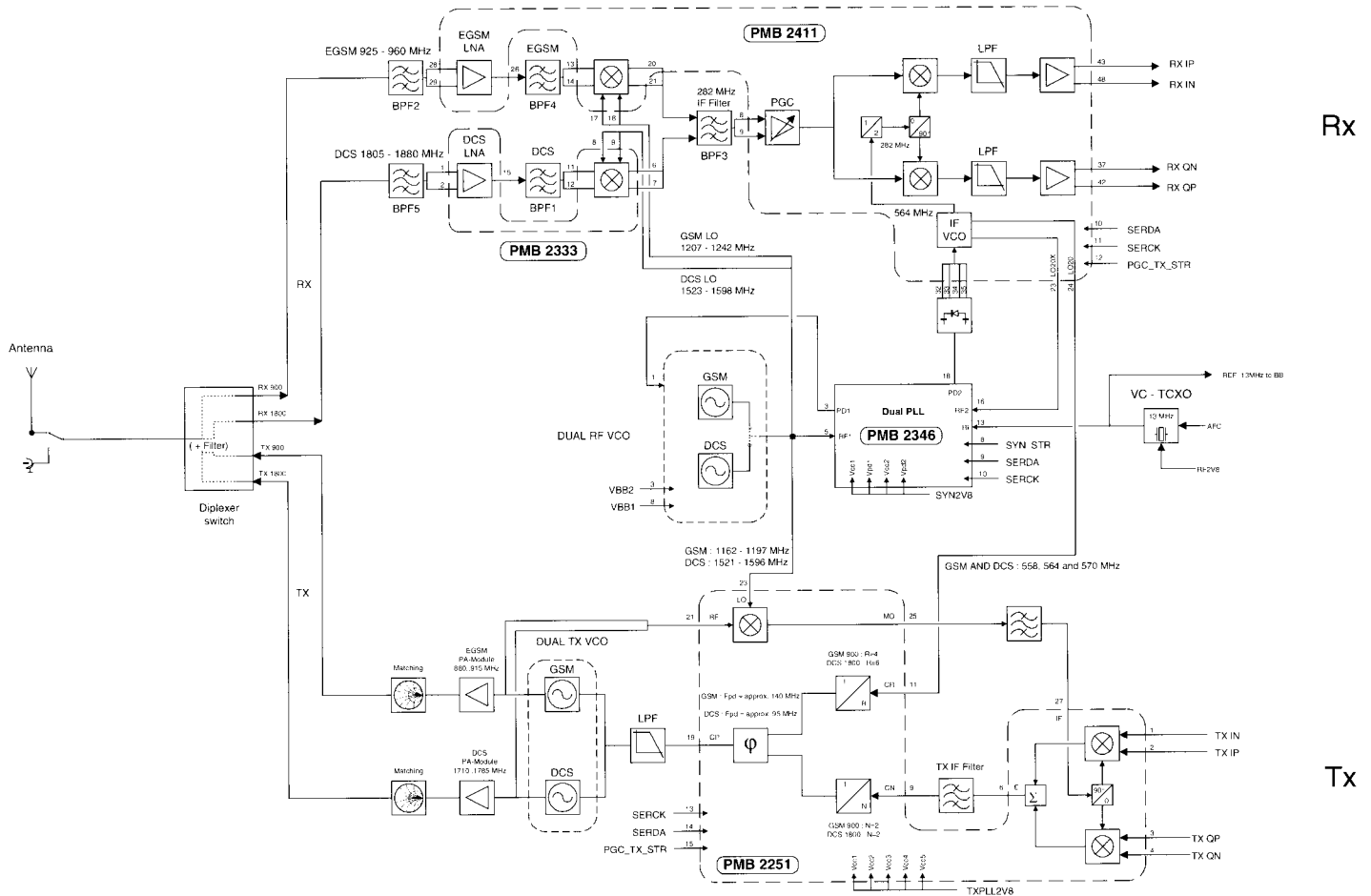

The GMSK modulated 900 MHz / 1800 MHz signal received by the antenna is downconverted into the baseband via an intermediate frequency of 282 MHz. In the transmit direction the digitally GMSK-modulated baseband signal is modulated to the transmit frequency in the 900 MHz / 1800 MHz bands by means of a modulation loop and the dual power VCO.

The radio part mainly consists of the RF Synthesizer, Receiver (RX), Transmitter (TX), power amplifiers, diplexer/switch, antenna connector with integrated switch and antenna.

7.2 Baseband Block Diagram

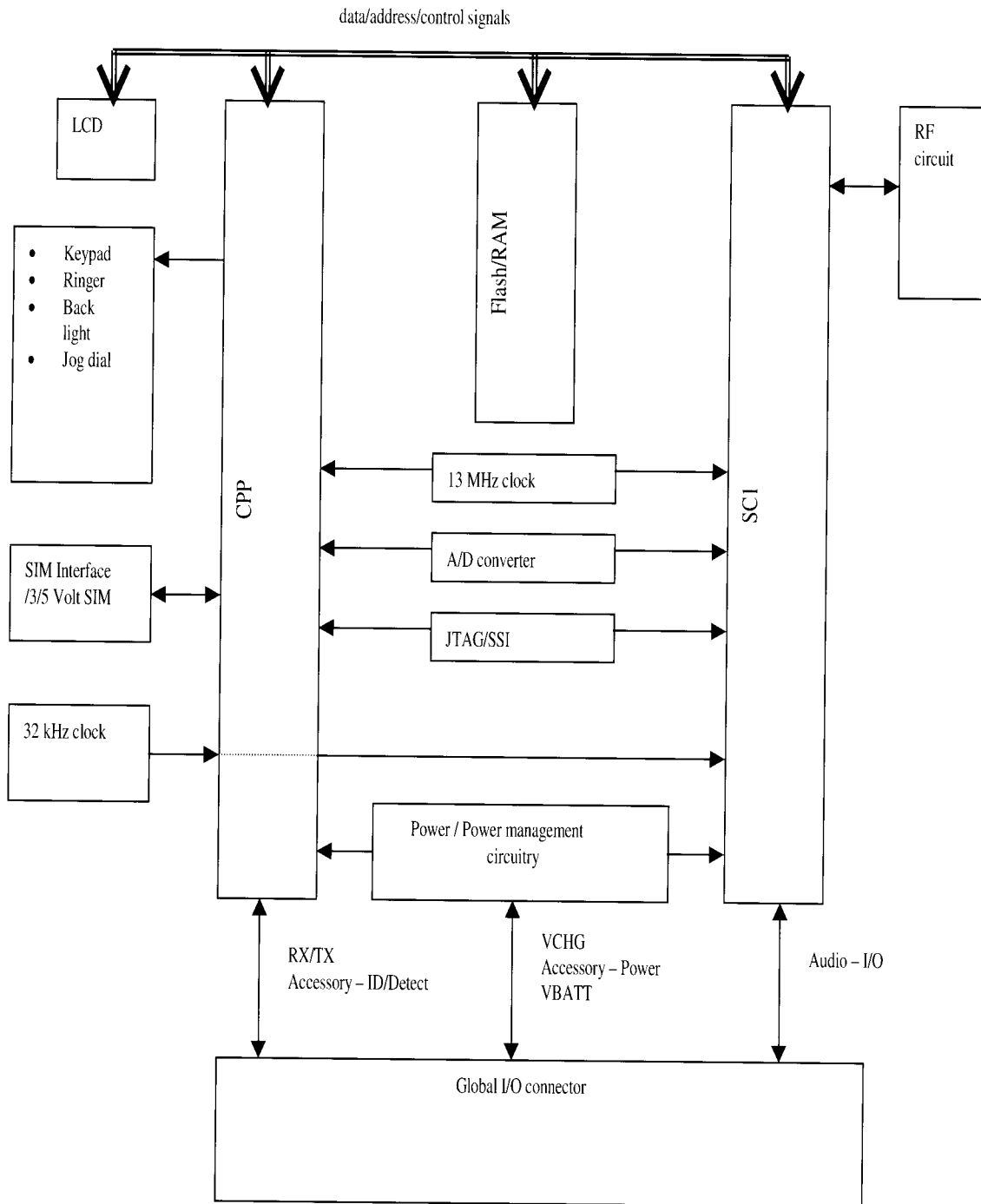

SECTION 8 EXPLODED VIEW

Note:

- The parts with no reference in the exploded view are not supplied.
- The construction parts of an assembled part are indicated with a collation number in the remark column.

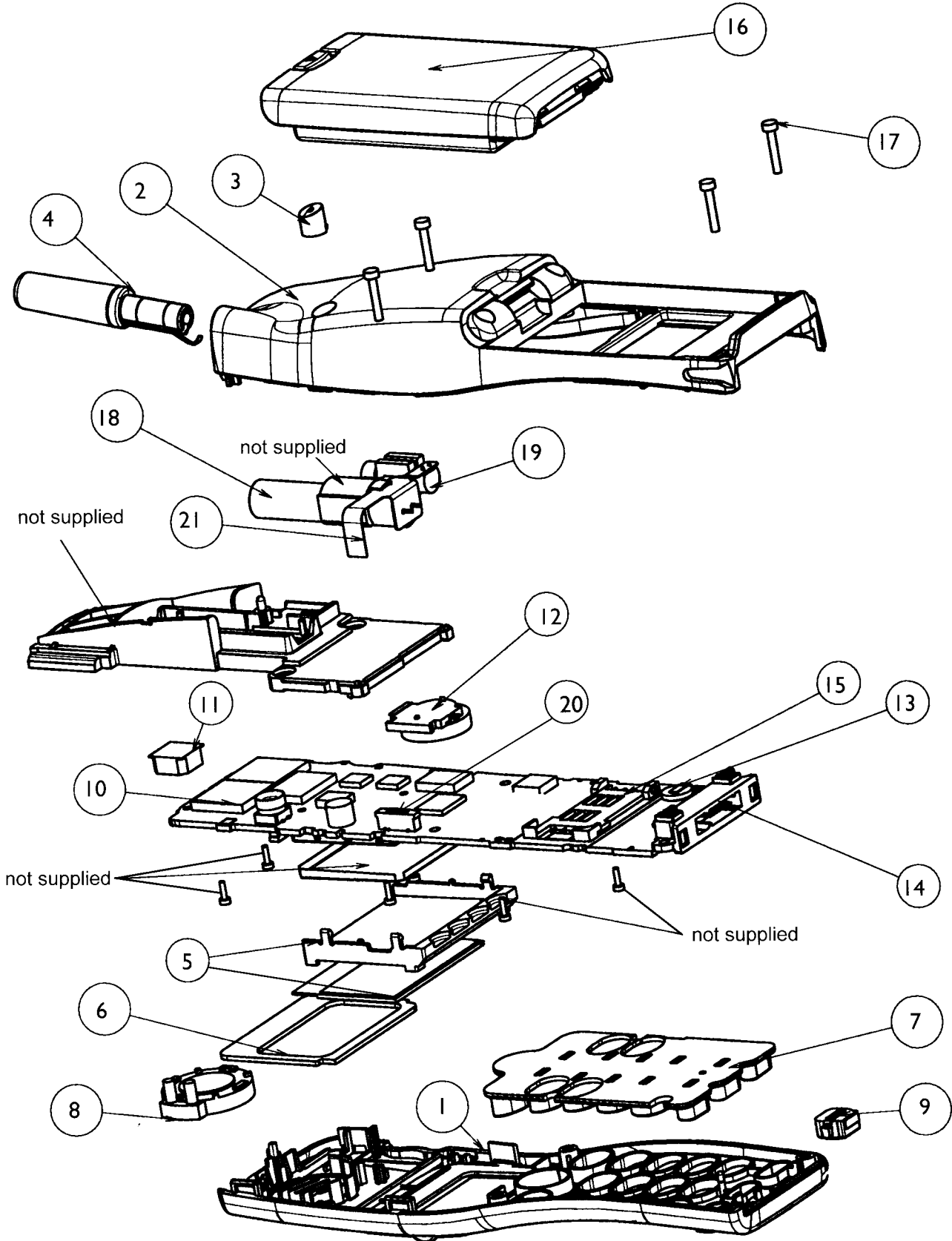

SECTION 9

SPARE PARTS AND ACCESSORIES LIST

Ref. No.	Part Number	Description	Remark
1	X 3377 737 1	Cabinet, Upper Assy	Metallic Black
	X 3377 738 1	Cabinet, Upper Assy	Metallic Blue
	X 3377 739 1	Cabinet, Upper Assy	Classic Silver
2	3 038 175 01	Cabinet Lower	
3	3 038 176 01	Cap, RF	
4	1 754 089 11	Antenna	
5	A 3647 481 A	LCD, Assy	(6)
6	3 031 803 03	Cushion, LCD	
7	3 038 181 01	Rubber Key	
8	1 529 191 12	Loud Speaker	
9	1 542 407 11	Microphone	
10	1 759 436 21	Ringer	
11	3 031 801 01	Cushion, Ringer	
12	1 418 057 22	Jog Encoder	
13	1 756 040 11	Battery, Manganese Lithium	Back up battery
14	1 793 633 21	Connector (External)	25P
15	1 793 605 21	Sim Connector	
16	A 3647 660 A	Battery Pack Assy	
17	3 041 807 01	Screw 2.0x10	
18	1 127 709 41	Capacitor, Elect 4400MF	99.00% 6.3V
19	1 763 207 11	Motor, Oscillation	Vibra Alert
20	1 793 615 21	FFC/FPC Connector	9P
21	1 675 575 11	PWB, Flexible	
Instruction Manual			
	3 868 364 41	Chinese (Simplified)	
	3 868 364 61	Chinese (Traditional)	
	3 867 714 21	English	
AC Power Supply			
	1 418 685 21	QN-2AC8	Chinese
	1 418 679 21	QN-2AC2	UK
Jigs			
	3 043 179 01	Cradle	Service-Test Connector
	1 792 172 11	Data Transfer Jig	Software Update
	3 043 180 01	Hook Release Jig	Housing Opening
	9 870 401 11	Service Manual	Chinese Model

9-870-401-11

**Sony International (Europe)
Digital Telecommunication Europe
Service Promotion Group**

English
Printed in Germany
1999.08
Published by DTCE

Free Manuals Download Website

<http://myh66.com>

<http://usermanuals.us>

<http://www.somanuals.com>

<http://www.4manuals.cc>

<http://www.manual-lib.com>

<http://www.404manual.com>

<http://www.luxmanual.com>

<http://aubethermostatmanual.com>

Golf course search by state

<http://golfingnear.com>

Email search by domain

<http://emailbydomain.com>

Auto manuals search

<http://auto.somanuals.com>

TV manuals search

<http://tv.somanuals.com>