

CD/DVD Player

Operating Instructions _____ **US**

Manual de instrucciones _____ **ES**



*DVP-NS601H
DVP-NS601HP*

WARNING

To reduce the risk of fire or electric shock, do not expose this apparatus to rain or moisture.

To avoid electrical shock, do not open the cabinet. Refer servicing to qualified personnel only.

The AC power cord must be changed only at a qualified service shop.

Batteries or batteries installed apparatus shall not be exposed to excessive heat such as sunshine, fire or the like.

CAUTION

The use of optical instruments with this product will increase eye hazard. As the laser beam used in this CD/DVD player is harmful to eyes, do not attempt to disassemble the cabinet.

Refer servicing to qualified personnel only.



This symbol is intended to alert the user to the presence of uninsulated "dangerous voltage"

within the product's enclosure that may be of sufficient magnitude to constitute a risk of electric shock to persons.



This symbol is intended to alert the user to the presence of important operating and

maintenance (servicing) instructions in the literature accompanying the appliance.

CAUTION

You are cautioned that any changes or modifications not expressly approved in this manual could void your authority to operate this equipment.

For customers in the U.S.A Owner's Record

The model and serial numbers are located at the rear of the unit. Record the serial number in the space provided below. Refer to them whenever you call upon your Sony dealer regarding this product.

Model No. DVP-NS601H
DVP-NS601HP
Serial No. _____

Note

This equipment has been tested and found to comply with the limits for a Class B digital device, pursuant to Part 15 of the FCC Rules. These limits are designed to provide reasonable protection against harmful interference in a residential installation. This equipment generates, uses, and can radiate radio frequency energy and, if not installed and used in accordance with the instructions, may cause harmful interference to radio communications. However, there is no guarantee that interference will not occur in a particular installation. If this equipment does cause harmful interference to radio or television reception, which can be determined by turning the equipment off and on, the user is encouraged to try to correct the interference by one or more of the following measures:

- Reorient or relocate the receiving antenna.
- Increase the separation between the equipment and receiver.
- Connect the equipment into an outlet on a circuit different from that to which the receiver is connected.
- Consult the dealer or an experienced radio/TV technician for help.

Notes About the Discs

- To keep the disc clean, handle the disc by its edge. Do not touch the surface. Dust, fingerprints, or scratches on the disc may cause it to malfunction.



- Do not expose the disc to direct sunlight or heat sources such as hot air ducts, or leave it in a car parked in direct sunlight as the temperature may rise considerably inside the car.
- After playing, store the disc in its case.
- Clean the disc with a cleaning cloth. Wipe the disc from the center out.



- Do not use solvents such as benzene, thinner, commercially available cleaners, or anti-static spray intended for vinyl LPs.
- If you have printed the disc's label, dry the label before playing.

Important Safety Instructions

- 1) Read these instructions.
 - 2) Keep these instructions.
 - 3) Heed all warnings.
 - 4) Follow all instructions.
 - 5) Do not use this apparatus near water.
 - 6) Clean only with dry cloth.
 - 7) Do not block any ventilation openings. Install in accordance with the manufacturer's instructions.
 - 8) Do not install near any heat sources such as radiators, heat registers, stoves, or other apparatus (including amplifiers) that produce heat.
 - 9) Do not defeat the safety purpose of the polarized or grounding-type plug. A polarized plug has two blades with one wider than the other. A grounding type plug has two blades and a third grounding prong. The wide blade or the third prong are provided for your safety. If the provided plug does not fit into your outlet, consult an electrician for replacement of the obsolete outlet.
 - 10) Protect the power cord from being walked on or pinched particularly at plugs, convenience receptacles, and the point where they exit from the apparatus.
 - 11) Only use attachments/accessories specified by the manufacturer.
 - 12) Use only with the cart, stand, tripod, bracket, or table specified by the manufacturer, or sold with the apparatus. When a cart is used, use caution when moving the cart/apparatus combination to avoid injury from tip-over.
- 
- 13) Unplug this apparatus during lightning storms or when unused for long periods of time.
 - 14) Refer all servicing to qualified service personnel. Servicing is required when the apparatus has been damaged in any way, such as power-supply cord or plug is damaged, liquid has been spilled or objects have fallen into the apparatus, the apparatus has been exposed to rain or moisture, does not operate normally, or has been dropped.

Precautions

The power requirements and power consumption of this player are indicated on the back of the player. Check that the player's operating voltage is identical with your local power supply.

Power requirements and power consumption →



On safety

- To prevent fire or shock hazard, do not place objects filled with liquids, such as vases, on the apparatus.
- Should any solid object or liquid fall into the cabinet, unplug the player and have it checked by qualified personnel before operating it any further.

On power sources

- The player is not disconnected from the AC power source as long as it is connected to the wall outlet, even if the player itself has been turned off.
- If you are not going to use the player for a long time, be sure to disconnect the player from the wall outlet. To disconnect the AC power cord, grasp the plug itself; never pull the cord.

On placement

- Place the player in a location with adequate ventilation to prevent heat build-up in the player.
- Do not place the player on a soft surface such as a rug.
- Do not place the player in a location near heat sources, or in a place subject to direct sunlight, excessive dust, or mechanical shock.
- Do not install the player in an inclined position. It is designed to be operated in a horizontal position only.
- Keep the player and the discs away from equipment with strong magnets, such as microwave ovens, or large loudspeakers.
- Do not place heavy objects on the player.
- Do not install this player in a confined space, such as a bookshelf or similar unit.
- Install the player so that the AC power cord can be unplugged from the wall socket immediately in the event of trouble.

On operation

- If the player is brought directly from a cold to a warm location, or

is placed in a very damp room, moisture may condense on the lenses inside the player. Should this occur, the player may not operate properly. In this case, remove the disc and leave the player turned on for about half an hour until the moisture evaporates.

- When you move the player, take out any discs. If you don't, the disc may be damaged.

For the model supplied with the AC plug adaptor

If the AC plug of your unit does not fit into the wall outlet, attach the supplied AC plug adaptor.

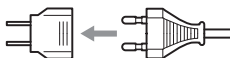

On adjusting volume

Do not turn up the volume while listening to a section with very low level inputs or no audio signals. If you do, the speakers may be damaged when a peak level section is played.

On cleaning

Clean the cabinet, panel, and controls with a soft cloth slightly moistened with a mild detergent solution. Do not use any type of abrasive pad, scouring powder or solvent such as alcohol or benzine.

On cleaning discs, disc/lens cleaners

Do not use cleaning discs or disc/lens cleaners (including wet or spray types). These may cause the apparatus to malfunction.

On replacement of parts

In the event that this unit is repaired, repaired parts may be collected for reuse or recycling purposes.

IMPORTANT NOTICE

Caution: This player is capable of holding a still video image or on-screen display image on your television screen indefinitely. If you leave the still video image or on-screen display image displayed on your TV for an extended period of time you risk permanent damage to your television screen. Plasma display panel televisions and projection televisions are susceptible to this.

If you have any questions or problems concerning your player, please consult your nearest Sony dealer.







Table of Contents

WARNING	2
Notes About the Discs	2
Important Safety Instructions	3
Precautions	3
About This Manual	5
This Player Can Play the Following Discs	6
Guide to Parts and Controls	8
Guide to the Control Menu Display	11
Guide to the 'BRAVIA Sync' Display	13
<hr/>	
Hookups	14
Hooking Up the Player	14
Step 1: Unpacking	14
Step 2: Connecting the Video Cords/HDMI Cords	15
About the CONTROL FOR HDMI functions for 'BRAVIA Sync' (for HDMI connections only)	17
Step 3: Connecting the Audio Cords	18
Step 4: Connecting the Power Cord	20
Step 5: Preparing the Remote	20
Controlling Your TV with the Supplied Remote	21
Step 6: Quick Setup	22
<hr/>	
Playback	24
Playing Discs	24
Various Play Mode Functions (Program Play, Shuffle Play, Repeat Play, A-B Repeat Play)	29
Adjusting the Playback Picture (CUSTOM PICTURE MODE)	33
Sharpening the Picture (SHARPNESS)	34
Adjusting the Delay Between the Picture and Sound (AV SYNC)	35
Locking Discs (CUSTOM PARENTAL CONTROL, PARENTAL CONTROL)	36
<hr/>	
Searching for a Scene	39
Searching for a Particular Point on a Disc (Scan, Slow-motion Play, Freeze Frame)	39
Searching for a Title/Chapter/Track/Scene, etc.	40
Searching by Scene (PICTURE NAVIGATION)	41
<hr/>	
Sound Adjustments	43
Changing the Sound	43
TV Virtual Surround Settings (TVS)	45
<hr/>	
Enjoying MP3 Audio and JPEG Images	46
About MP3 Audio Tracks and JPEG Image Files	46
Playing MP3 Audio Tracks or JPEG Image Files	47
Enjoying JPEG Images as a Slide Show	49

Settings and Adjustments	53
Using the Setup Display.	53
Setting the Display or Sound Track Language (LANGUAGE SETUP)	54
Settings for the Display (SCREEN SETUP).	55
Custom Settings (CUSTOM SETUP).	57
Settings for the Sound (AUDIO SETUP)	58
HDMI Settings (HDMI SETUP)	60
Additional Information	62
Troubleshooting.	62
Self-diagnosis Function (When letters/numbers appear in the display).	66
Specifications.	67
Language Code List.	68
Parental Control Area Code List	68
Index	69

About This Manual

- Instructions in this manual describe the controls on the remote. You can also use the controls on the player if they have the same or similar names as those on the remote.
- “DVD” may be used as a general term for commercial DVDs, DVD+RWs/DVD+Rs/DVD+Rs DL (+VR mode) and DVD-RWs/DVD-Rs/DVD-Rs DL (VR mode, video mode).
- The meaning of the icons used in this manual is described below:

Icons	Meaning
	Functions available for commercial DVDs and DVD+RWs/DVD+Rs/DVD+Rs DL in +VR mode or DVD-RWs/DVD-Rs/DVD-Rs DL in video mode
	Functions available for DVD-RWs/DVD-Rs/DVD-Rs DL in VR (Video Recording) mode
	Functions available for VIDEO CDs (including Super VCDs or CD-Rs/CD-RWs in video CD format or Super VCD format)
	Functions available for music CDs or CD-Rs/CD-RWs in music CD format
	Functions available for DATA CDs (CD-ROMs/CD-Rs/CD-RWs containing MP3* audio tracks, and JPEG image files)
	Functions available for DATA DVDs (DVD-ROMs/DVD+RWs/DVD+Rs/DVD+Rs DL/DVD-RWs/DVD-Rs/DVD-Rs DL containing MP3* audio tracks, and JPEG image files)

* MP3 (MPEG-1 Audio Layer III) is a standard format defined by ISO (International Organization for Standardization)/IEC (International Electrotechnical Commission) MPEG which compresses audio data.

This Player Can Play the Following Discs

Format of discs	
Commercial DVD	
DVD-RW/-R	 
DVD+RW/+R/ +R DL	  
VIDEO CD/ Music CD	 
CD-RW/-R	 

“DVD+RW,” “DVD-RW,” “DVD+R,” “DVD+R DL,” “DVD-R,” “DVD VIDEO,” and “CD” logos are trademarks.

Note about CDs/DVDs

The player can play CD-ROMs/CD-Rs/CD-RWs recorded in the following formats:

- music CD format
- video CD format
- MP3 audio tracks and JPEG image files of format conforming to ISO 9660* Level 1/ Level 2, or its extended format, Joliet
- KODAK Picture CD format

* A logical format of files and folders on CD-ROMs, defined by ISO (International Organization for Standardization).

The player can play DVD-ROMs/ DVD-RWs/DVD-Rs/DVD-Rs DL/ DVD+RWs/DVD+Rs/DVD+Rs DL recorded in the following formats:

- MP3 audio tracks and JPEG image files of format conforming to UDF (Universal Disk Format).

Example of discs that the player cannot play

The player cannot play the following discs:

- CD-ROMs/CD-Rs/CD-RWs other than those recorded in the formats listed on this page.
- CD-ROMs recorded in PHOTO CD format.
- Data part of CD-Extras.
- DVD Audio discs.
- HD layer on Super Audio CDs.
- BDs.
- HD DVDs.
- Disc recorded with an AVCHD-compatible DVD video camera.

Also, the player cannot play the following discs:

- A commercial DVD with a different region code.
- A disc recorded in a color system other than NTSC, such as PAL or SECAM (this player conforms to the NTSC color system).
- A disc that has a non-standard shape (e.g., card, heart).
- A disc with paper or stickers on it.
- A disc that has the adhesive of cellophane tape or a sticker still left on it.

Region code

Your player has a region code printed on the back of the unit and only will play commercial DVDs (playback only) labeled with identical region codes. This system is used to protect copyrights.

Commercial DVDs labeled  will also play on this player.

If you try to play any other commercial DVD, the message “Playback prohibited by area limitations.” will appear on the TV screen. Depending on the commercial DVD, there may be no region code indication, even though playing the commercial DVD is prohibited by area restrictions.

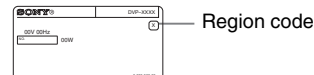

Notes

- **Notes about DVD+RWs/DVD+Rs/DVD+Rs DL, DVD-RWs/DVD-Rs/DVD-Rs DL or CD-Rs/CD-RWs**

Some DVD+RWs/DVD+Rs/DVD+Rs DL, DVD-RWs/DVD-Rs/DVD-Rs DL, or CD-Rs/CD-RWs cannot be played on this player due to the recording quality or physical condition of the disc, or the characteristics of the recording device and authoring software.

The disc will not play if it has not been correctly finalized. For more information, refer to the operating instructions for the recording device.

Note that some playback functions may not work with some DVD+RWs/DVD+Rs/DVD+Rs DL, even if they have been correctly finalized. In this case, view the disc by normal playback. Also some DATA CDs/DATA DVDs created in Packet Write format cannot be played.

- **Music discs encoded with copyright protection technologies**

This product is designed to playback discs that conform to the Compact Disc (CD) standard. Recently, various music discs encoded with copyright protection technologies are marketed by some record companies. Please be aware that among those discs, there are some that do not conform to the CD standard and may not be playable by this product.

- **For player that cannot play images that contain a copy protection only**

Images in DVD-VR mode with CPRM* protection may not be played if they contain a copy protection signal, "Copyright lock" appears on the screen.

* CPRM (Content Protection for Recordable Media) is a coding technology that protects the copyright of images.

- **Note on DualDiscs**

A DualDisc is a two sided disc product which mates DVD recorded material on one side with digital audio material on the other side. However, since the audio material side does not conform to the Compact Disc (CD) standard, playback on this product is not guaranteed.

Note on playback operations of DVDs and VIDEO CDs

Some playback operations of DVDs and VIDEO CDs may be intentionally set by software producers. Since this player plays DVDs and VIDEO CDs according to the disc contents the software producers designed, some playback features may not be available. Also, refer to the instructions supplied with the DVDs or VIDEO CDs.

Copyrights

This product incorporates copyright protection technology that is protected by U.S. patents and other intellectual property rights. Use of this copyright protection technology must be authorized by Macrovision, and is intended for home and other limited viewing uses only unless otherwise authorized by Macrovision. Reverse engineering or disassembly is prohibited.

Guide to Parts and Controls

For more information, see the pages indicated in parentheses.

Front panel

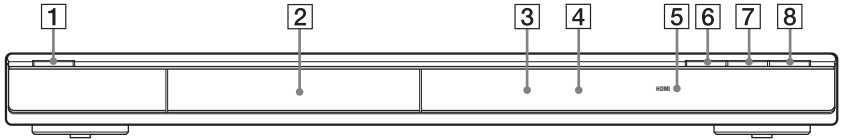

1 I/⏻ (on/standby) button (24)

2 Disc tray (24)

3 Front panel display (9)

4  (remote sensor) (20)

5 HDMI* (High-Definition Multimedia Interface) indicator (16, 60, 61)
Lights up when the HDMI OUT jack is correctly connected to a HDCP (High-bandwidth Digital Content Protection) compliant device with HDMI or DVI (Digital Visual Interface) input.

6  (open/close) button (24)

7  (play) button (24)

8  (stop) button (25)

* This DVD player incorporates High-Definition Multimedia Interface (HDMI™) technology.

“HDMI, the HDMI logo and High-Definition Multimedia Interface are trademarks or registered trademarks of HDMI Licensing LLC.”

Rear panel

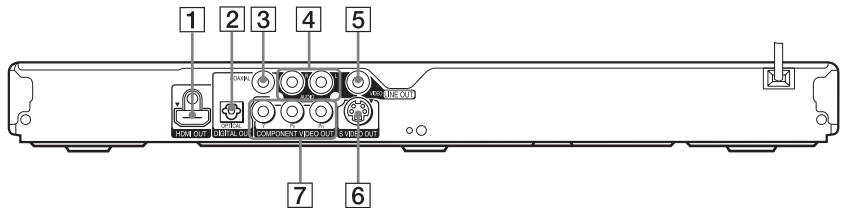

1 HDMI OUT (High-Definition Multimedia Interface out) jack (15)

2 DIGITAL OUT (OPTICAL) jack (18)

3 DIGITAL OUT (COAXIAL) jack (18)

4 LINE OUT L/R (AUDIO) jacks (18)

5 LINE OUT (VIDEO) jack (15)

6 S VIDEO OUT jack (15)

7 COMPONENT VIDEO OUT jacks (15)

Front panel display

When playing back a DVD

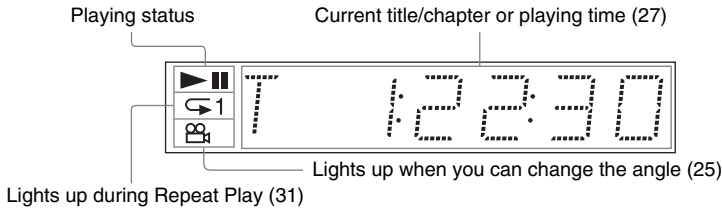

When playing back a VIDEO CD with Playback Control (PBC) (27)

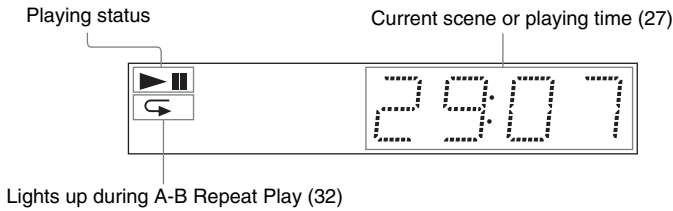

When playing back a CD, DATA CD (MP3 audio), DATA DVD (MP3 audio), or VIDEO CD (without PBC)

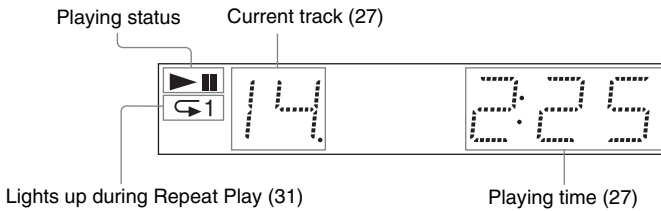

Remote

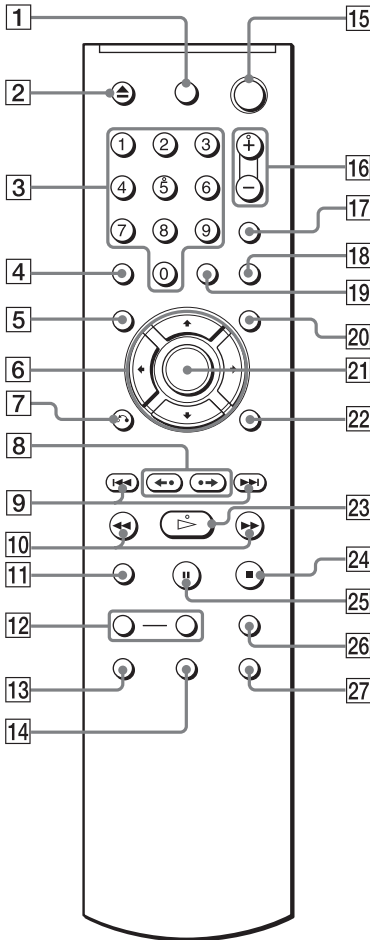

- 1** TV I/⏻ (on/standby) button (21)
- 2** ▲ OPEN/CLOSE button (25)
- 3** Number buttons (27)
The number 5 button has a tactile dot.*
- 4** CLEAR button (30)
- 5** TOP MENU button (26)
- 6** ←/↑/↓/→ buttons (25)
- 7** ↻ RETURN button (26)
- 8** ⏮ ⏪ ⏩ ⏭ REPLAY/STEP/
ADVANCE/STEP buttons (25, 39)

- 9** ⏮/⏭ PREV/NEXT (previous/
next) buttons (25)
- 10** ⏮⏮/⏭⏭ SCAN/SLOW
buttons (39)
- 11** ZOOM button (25, 49)
- 12** SLOW PLAY/FAST PLAY buttons
(25)
- 13** AUDIO button (43)
- 14** SUBTITLE button (25, 49)
- 15** I/⏻ (on/standby) button (24)
- 16** VOL (volume) +/- buttons (21)
The + button has a tactile dot.*
- 17** TV/VIDEO button (21)
- 18** PICTURE NAVI (picture navigation)
button (41, 48)
- 19** TIME/TEXT button (27)
- 20** MENU button (26)
- 21** ENTER button (22)
- 22** DISPLAY button (11)
- 23** ▷ PLAY button (24)
The ▷ button has a tactile dot.*
- 24** ■ STOP button (25)
- 25** ⏸ PAUSE button (25)
- 26** SUR (surround) button (45)
- 27** ANGLE button (25)

* Use the tactile dot as a reference when operating the player.

Guide to the Control Menu Display

Use the Control Menu to select a function and to view related information. Press DISPLAY repeatedly to turn on or change the Control Menu display as follows:

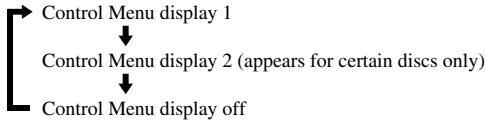

Control Menu display

The Control Menu display 1 and 2 will show different items depending on the disc type.

Example: Control Menu display 1 when playing a DVD VIDEO.

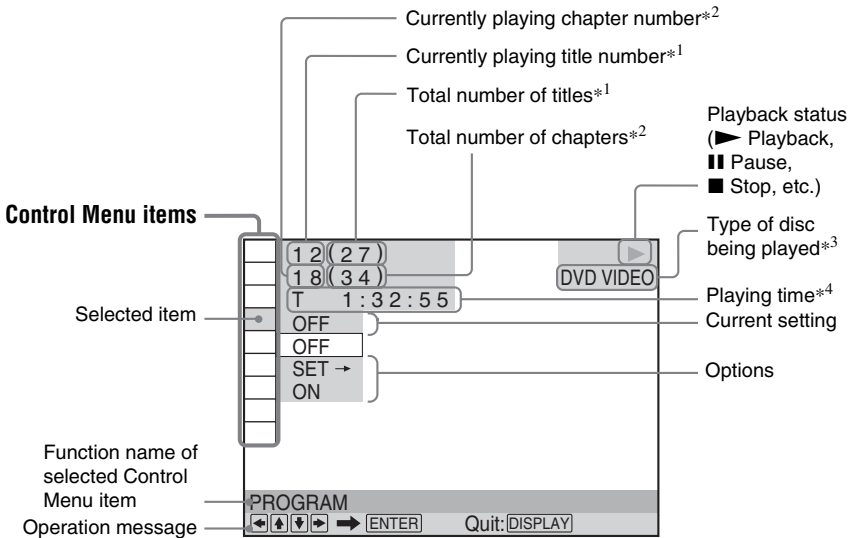













- *1 Displays the scene number for VIDEO CDs (PBC is on), track number for VIDEO CDs/CDs, album number for DATA CDs/DATA DVDs.
- *2 Displays the index number for VIDEO CDs, MP3 audio track number, or JPEG image file number for DATA CDs/DATA DVDs.
- *3 Displays Super VCD as "SVCD."
- *4 Displays the date for JPEG files.

To turn off the display

Press DISPLAY repeatedly.

List of Control Menu items

Item	Item Name, Function
	TITLE/SCENE/TRACK Selects the title, scene, or track to be played.
	CHAPTER/INDEX Selects the chapter or index to be played.
	TRACK Selects the track to be played.
	TIME/TEXT Checks the elapsed time and the remaining playback time. Input the time code for picture and music searching.
	ORIGINAL/PLAY LIST Selects the type of titles (DVD-VR mode) to be played, the ORIGINAL one, or an edited PLAY LIST.
	PROGRAM Selects the title, chapter, or track to play in the order you want.
	SHUFFLE Plays the title, chapter, or track in random order.
	REPEAT Plays the entire disc (all titles/all tracks/all albums) repeatedly or one title/chapter/track/album repeatedly.
	A-B REPEAT Specifies the parts you want to play repeatedly.
	CUSTOM PICTURE MODE Adjusts the video signal from the player. You can select the picture quality that best suits the program you are watching.
	SHARPNESS Exaggerates the outline of the image to produce a sharper picture.
	AV SYNC Adjust the delay between the picture and sound.
	PARENTAL CONTROL Set to prohibit playback on this player.



SETUP

QUICK Setup

Use Quick Setup to choose the desired language of the on-screen display, the aspect ratio of the TV, and the audio output signal.

CUSTOM Setup

In addition to the Quick Setup setting, you can adjust various other settings.

RESET

Returns the settings in "SETUP" to the default setting.



ALBUM

Selects the album that contains MP3 audio track and JPEG image file to be played.



FILE

Selects the JPEG image file to be played.



DATE

Displays the date the picture was taken by a digital camera.



INTERVAL

Specifies the duration for which the slides are displayed on the screen.



EFFECT



Selects the effects to be used for changing slides during a slide show.



MODE (MP3, JPEG)

Selects the data type; MP3 audio track (AUDIO), JPEG image file (IMAGE), or both (AUTO) to be played when playing a DATA CD or DATA DVD.

Hint

The Control Menu icon indicator lights up in green  →  when you select any item except "OFF" ("PROGRAM," "SHUFFLE," "REPEAT," "A-B REPEAT," "SHARPNESS" only). The "ORIGINAL/PLAY LIST" indicator lights up in green when you select "PLAY LIST" (default setting). The "CUSTOM PICTURE MODE" indicator lights up in green when any setting other than "STANDARD" is selected. The "AV SYNC" indicator lights up in green when set to more than 0 ms.

Guide to the 'BRAVIA Sync' Display

You can control the player by selecting the SYNC MENU button on the TV's remote or TV's option menu.

'BRAVIA Sync' display

The 'BRAVIA Sync' display will show different items depending on the disc type.

Example: 'BRAVIA Sync' display when playing a DVD VIDEO.



Select an item using $\leftarrow/\uparrow/\downarrow/\rightarrow$ and then press ENTER.

◆ When playing a DVD VIDEO

Displays MENU and TOP MENU.

◆ When playing in DVD-VR mode

Displays $\mathbf{I}\lll$, $\mathbf{I}\ggg$, and chapter number.

◆ When playing a CD, VIDEO CD, or Super VCD (without PBC)

Displays $\mathbf{I}\lll$, $\mathbf{I}\ggg$, and track number.

◆ When playing a VIDEO CD or Super VCD (with PBC) (page 27)

Displays $\mathbf{I}\lll$, $\mathbf{I}\ggg$, and scene number.
When the disc's menu appears, you can select an item by pressing \uparrow/\downarrow .

◆ When playing a DATA CD or DATA DVD

Displays MENU and PICTURE NAVI.

To turn off the display

Press RETURN or SYNC MENU button on the TV's remote.

💡 Hint

You can also control these functions on the player's remote.

Notes

- The items in the 'BRAVIA Sync' display have the same functions as the player's remote buttons (page 10).
- You can only use this function if your TV supports the 'BRAVIA Sync'.
- For more details of 'BRAVIA Sync', please refer to the operation instructions supplied with the TV.

Hooking Up the Player

Follow steps 1 to 6 to hook up and adjust the settings of the player.

Notes

- Plug cords securely to prevent unwanted noise.
- Refer to the instructions supplied with the components to be connected.
- You cannot connect this player to a TV that does not have a video input jack.
- Be sure to disconnect the power cord of each component before connecting.

Step 1: Unpacking

Check that you have the following items:

- Audio/Video cord (phono plug × 3 ↔ phono plug × 3) (1)
- Remote commander (remote) (1)
- R6 (size AA) batteries (2)
- HDMI cord (1) (supplied with DVP-NS601HP only)

A plug adaptor is included with some models.

Step 2: Connecting the Video Cords/HDMI Cords

Connect this player to your TV monitor, projector, or audio component such as an AV amplifier (receiver) using a video cord. Select one of the patterns **A** through **D**, according to the input jack on your TV monitor, projector, or audio component.

In order to view progressive signal (480p) pictures with a compatible TV, projector, or monitor, you must use pattern **C**. Select pattern **D** when connecting to a TV, projector, or audio component equipped with HDMI input.

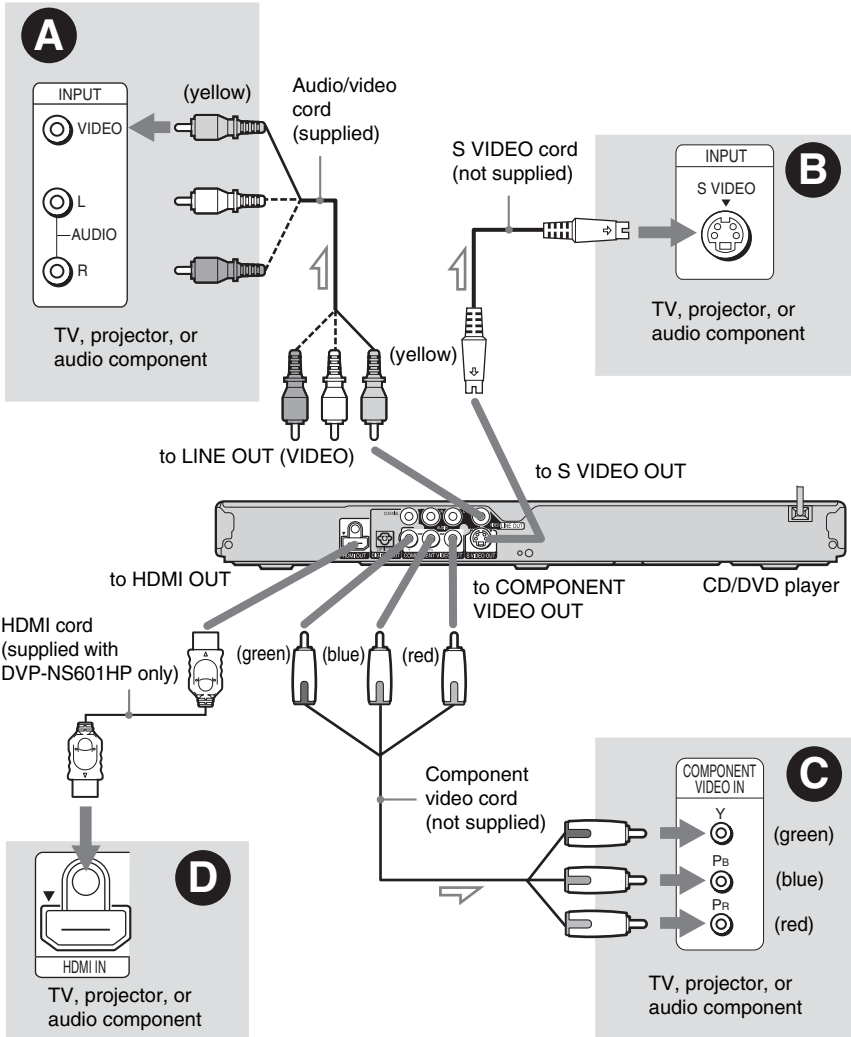

→ : Signal flow

A Video input jack

You will enjoy standard quality images.

B S VIDEO input jack

You will enjoy high quality images.

C Component video input jacks (Y, P_B, P_R)

You will enjoy accurate color reproduction and high quality images.

If your TV accepts progressive 480p format signals, use this connection and set "PROGRESSIVE (COMPONENT OUT ONLY)" in "SCREEN SETUP" to "ON" (page 56) to output progressive signals.

D HDMI/DVI input jack

Use a certified Sony HDMI cord to enjoy high quality digital picture and sound through the HDMI OUT jack.

When connecting to a Sony TV that is compatible with the CONTROL FOR HDMI function, see page 17.

When connecting to the HDMI OUT jack

Follow the steps below. Improper handling may damage the HDMI OUT jack and the connector.

1 Carefully align the HDMI OUT jack on the back of the player and the HDMI connector by checking their shapes.

Make sure the connector is not upside down or tilted.

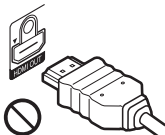

Connector is upside down

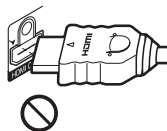

Not straight

2 Insert the HDMI connector straight into the HDMI OUT jack.

Do not bend or apply force to the HDMI connector.

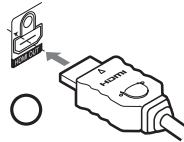

To connect to a TV with DVI input

Use an HDMI-DVI converter cord (not supplied). The DVI jack will not accept any audio signals, so you have to use another audio connection in addition to this connection (page 18). Furthermore, you cannot connect the HDMI OUT jack to DVI jacks that are not HDCP compliant (e.g., DVI jacks on PC displays).

When connecting to a standard 4:3 screen TV

Depending on the disc, the image may not fit your TV screen. To change the aspect ratio, see page 55.

Notes

- Do not connect a VCR, etc., between your TV and the player. If you pass the player signals via the VCR, you may not receive a clear image on the TV screen. If your TV has only one audio/video input jack, connect the player to this jack.

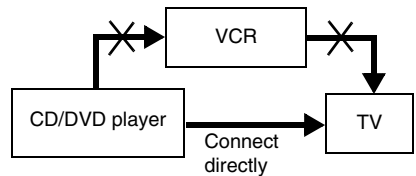

- If the picture appears too white when you are using A or B connection, set "BLACK LEVEL" in "SCREEN SETUP" to "OFF" (page 56).
- Be sure to disconnect the HDMI cord when moving the player.
- Do not apply too much pressure to the cabinet wall, if you place the player on the cabinet with the HDMI cord connected. It may damage the HDMI OUT jack or the HDMI cord.
- When connecting or disconnecting, do not screw in or rotate the HDMI connector.

About the CONTROL FOR HDMI functions for 'BRAVIA Sync' (for HDMI connections only)

By connecting to Sony components that are compatible with the CONTROL FOR HDMI function with an HDMI cord (supplied with DVP-NS601HP only), you can enjoy the following features:

- One-Touch Play (page 24)
- System-Power Off

When you turn the TV off by using the  button on the TV's remote, the components compatible with CONTROL FOR HDMI function turn off automatically.

To prepare for the 'BRAVIA Sync' features

Set "CONTROL FOR HDMI" to "ON" in "HDMI SETUP" (page 61). For details on TV setting, refer to the operating instructions supplied with the TV.

Note

Depending on the connected component, the CONTROL FOR HDMI function may not work. Refer to the operating instructions supplied with the component.

Step 3: Connecting the Audio Cords

Select one of the following patterns **A** or **B**, according to the input jack on your TV monitor, projector, or audio component such as an AV amplifier (receiver). This will enable you to listen to sound.

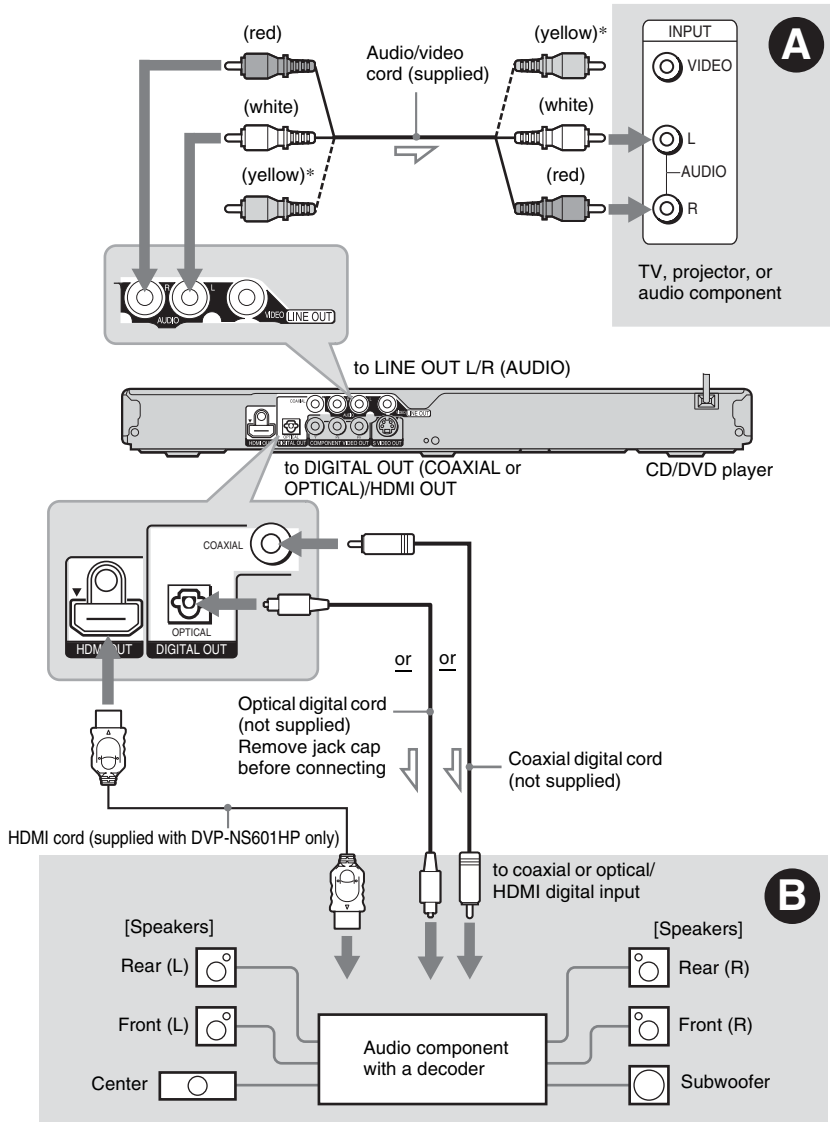

* The yellow plug is used for video signals (page 15).

Hint

For correct speaker location, see the operating instructions supplied with the connected components.

A Audio L/R input jacks

This connection will use your TV's or audio component's two speakers for sound.

B Digital audio input jack

If your audio component has a Dolby*¹ Digital or DTS*² decoder and a digital input jack, use this connection. You can enjoy Dolby Digital (5.1ch) and DTS (5.1ch) surround effect.

If you connect to a Sony audio component that is compatible with the CONTROL FOR HDMI function, refer to the operating instructions supplied with the audio component.

*¹ Manufactured under license from Dolby Laboratories.

Dolby, Pro Logic, and the double-D symbol are trademarks of Dolby Laboratories.

*² Manufactured under license under U.S. Patent #: 5,451,942 & other U.S. and worldwide patents issued & pending. DTS and DTS Digital Out are registered trademarks and the DTS logos and Symbol are trademarks of DTS, Inc. © 1996-2007 DTS, Inc. All Rights Reserved.

Notes

- After you have completed the connection, be sure to set "DOLBY DIGITAL" to "DOLBY DIGITAL" and "DTS" to "ON" in Quick Setup (page 22).
- When you connect an audio component that conforms to the 96 kHz sampling frequency, set "48kHz/96kHz PCM" in "AUDIO SETUP" to "96kHz/24bit" (page 59).
- The TVS effects of this player cannot be used with this connection.
- When you connect the player to an audio component using an HDMI cord, you will need to do one of the following:
 - Connect the audio component to the TV with the HDMI cord.
 - Connect the player to the TV with a video cord other than HDMI cord (component video cord, S VIDEO cord, or audio/video cord).
- When connecting to the HDMI OUT jack, carefully align the HDMI connector with the jack. Do not bend and apply force to the HDMI cord.

Step 4: Connecting the Power Cord

Plug the player and TV power cords into an AC outlet.

Step 5: Preparing the Remote

You can control the player using the supplied remote. Insert two R6 (size AA) batteries by matching the ⊕ and ⊖ ends on the batteries to the markings inside the compartment. When using the remote, point it at the remote sensor  on the player.

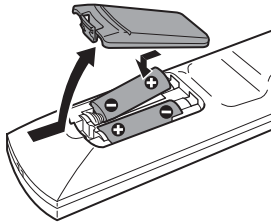

Notes

- Do not leave the remote in an extremely hot or humid place.
- Do not drop any foreign object into the remote casing, particularly when replacing the batteries.
- Do not expose the remote sensor to direct light from the sun or a lighting apparatus. Doing so may cause a malfunction.
- If you do not use the remote for an extended period of time, remove the batteries to avoid possible damage from battery leakage and corrosion.

Controlling Your TV with the Supplied Remote

You can control the sound level, input source, and power switch of your Sony TV with the supplied remote.

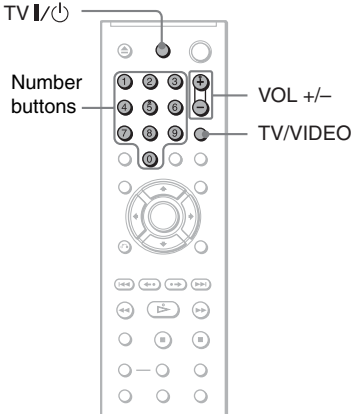

You can control your TV using the buttons below.

By pressing	You can
TV I/Power	Turn the TV on or off
VOL +/-	Adjust the volume of the TV
TV/VIDEO	Switch the TV's input source between the TV and other input sources

Note

Depending on the connected unit, you may not be able to control your TV using all or some of the buttons on the supplied remote.

Step 6: Quick Setup

Follow the steps below to make the minimum number of basic adjustments for using the player. To skip an adjustment, press **▶▶**. To return to the previous adjustment, press **◀◀**.

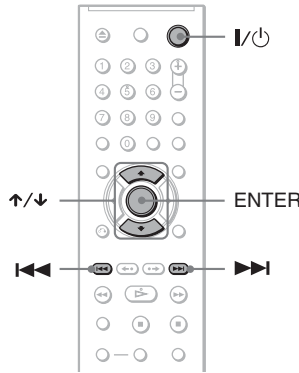

1 Turn on the TV.

2 Press **I/O**.

3 Switch the input selector on your TV so that the signal from the player appears on the TV screen.

“Press [ENTER] to run QUICK SETUP” (press enter to run Quick Setup) appears at the bottom of the screen. If this message does not appear, select “QUICK” (quick) under “SETUP” (setup) in the Control Menu to run Quick Setup (page 54).

4 Press **ENTER** without inserting a disc.

The Setup Display for selecting the language used in the on-screen display appears.

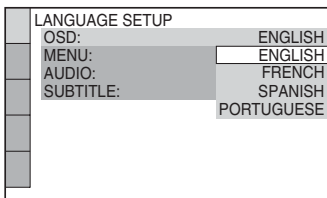

5 Press **↑/↓** to select a language.

The player displays the menu and subtitles in the selected language.

6 Press **ENTER**.

The Setup Display for selecting the aspect ratio of the TV to be connected appears.

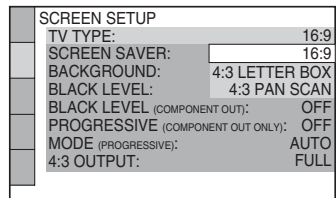

7 Press **↑/↓** to select the setting that matches your TV type.

◆ If you have a wide-screen TV or a 4:3 standard TV with a wide-screen mode

• 16:9 (page 55)

◆ If you have a 4:3 standard TV

• 4:3 LETTER BOX or 4:3 PAN SCAN (page 55)

8 Press ENTER.

The Setup Display for selecting the type of jack used to connect your audio component such as an amplifier (receiver) appears.

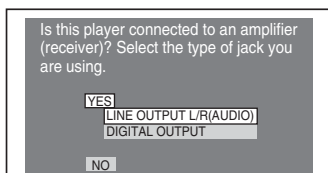

9 Press \uparrow/\downarrow to select the type of jack (if any) you are using to connect to an audio component, then press ENTER.

If you did not connect an audio component, select "NO," then go to step 13.

If you connected an audio component using just an audio cord, select "YES: LINE OUTPUT L/R (AUDIO)," then go to step 13.

If you connected an audio component using a digital coaxial or optical/HDMI cord, select "YES: DIGITAL OUTPUT."

10 Press \uparrow/\downarrow to select the type of Dolby Digital signal you wish to send to your audio component.

If your audio component has a Dolby Digital decoder, select "DOLBY DIGITAL." Otherwise, select "D-PCM."

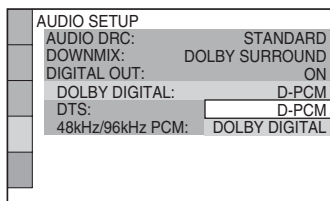

11 Press ENTER.

"DTS" is selected.

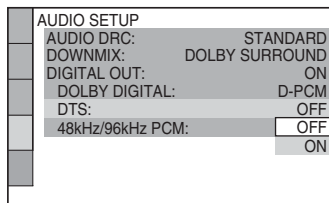

12 Press \uparrow/\downarrow to select whether or not you wish to send a DTS signal to your audio component.

If your audio component has a DTS decoder, select "ON." Otherwise, select "OFF."

13 Press ENTER.

Quick Setup is finished. All connections and setup operations are complete.

Note

When "PhotoTV HD" mode is activated (page 50), the selection for "TV TYPE" is skipped.

Playback

Playing Discs **DVDVideo** **DVDVR**

VCD **CD** **DATA CD** **DATA DVD**

Depending on the DVD or VIDEO CD, some operations may be different or restricted. Refer to the operating instructions supplied with your disc.

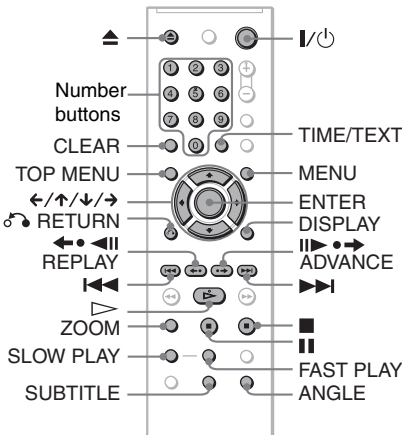

1 Turn on your TV.

2 Press I/⏻.

The player turns on.

3 Switch the input selector on your TV so that the signal from the player appears on the TV screen.

◆ When using an audio component

Turn on the audio component and select the appropriate channel so that you can hear sound from the player.

4 Press on the player, and place a disc on the disc tray.

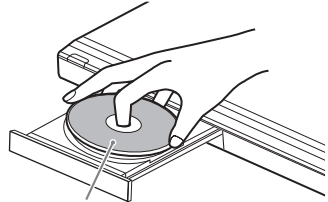

Playback side facing down

5 Press .

The disc tray closes. The player starts playback (continuous play). Adjust the volume on the TV or the audio component.

Depending on the disc, a menu may appear on the TV screen. For DVD VIDEOS, see page 26. For VIDEO CDs, see page 27.

To turn off the player

Press I/⏻. The player enters standby mode.

One-Touch Play (for HDMI connections only)

With one touch of the  button on the remote, the player and your TV automatically turn on and the TV's input is switched to the player. Playback starts automatically. The TV's input will also switch to the player automatically, in the following cases:

– You press , TOP MENU, MENU, or DISPLAY buttons on the remote.

Note that these buttons are not effective when you play audio CD or MP3 audio track in “AUDIO (MP3)” mode.

– If a disc with auto play function is loaded.

Hint

You can have the player turn off automatically whenever you leave it in stop mode for more than 30 minutes. To turn this function on or off, set “AUTO POWER OFF” in “CUSTOM SETUP” to “ON” or “OFF” (page 57).

Notes on playing DTS sound tracks on a DVD VIDEO

- DTS audio signals are output only through the DIGITAL OUT (COAXIAL or OPTICAL)/HDMI OUT jack.
- When you play a DVD VIDEO with DTS sound tracks, set “DTS” to “ON” in “AUDIO SETUP” (page 59).
- If you connect the player to audio equipment without a DTS decoder, do not set “DTS” to “ON” in “AUDIO SETUP” (page 59). A loud noise may come out from the speakers, affecting your ears or causing the speakers to be damaged.

Note

Discs created on DVD recorders must be correctly finalized before they can be played. For more information about finalizing, refer to the operating instructions supplied with the DVD recorder.

Additional operations

To check the position of the buttons below, see the illustration on page 24.

To	Operation
Stop	Press ■
Pause	Press II
Resume play after pause	Press II or ▷
Go to the next chapter, track or scene in continuous play mode	Press ►►
Go back to the previous chapter, track or scene in continuous play mode	Press ◀◀
Stop play and remove the disc	Press ▲
Change the angle	Press ANGLE during playback. Press ANGLE repeatedly to select an angle number.
Display the subtitle	Press SUBTITLE during playback. Press SUBTITLE repeatedly to select a subtitle language.

To	Operation
Replay the previous scene*1	Press ◀◀◀ REPLAY during playback
Briefly fast forward the current scene*2	Press II►► ADVANCE during playback
Magnify the image*3	Press ZOOM repeatedly. Press CLEAR to cancel.

*1 All DVDs except for DVD+Rs/DVD+RWs/DVD+Rs DL.

*2 DVDs only.

*3 Video and JPEG pictures only (except BACKGROUND pictures). You can move the enlarged picture using ◀/↑/↓/▶. Depending upon the contents of the disc, the zoom function may be canceled automatically when the picture is moved.

Note

You may not be able to use the Replay or Advance function with some scenes.

Playing quickly or slowly with sound

You can listen to dialog or sound while playing the current scene quickly or slowly.

During playback, press FAST PLAY or SLOW PLAY.

The speed changes when you press either FAST PLAY or SLOW PLAY.

To return to normal playback



Press ▷.

Notes

- You can only use this function with DVDs, VIDEO CDs, or Super VCDs only.
- “Operation not possible” will appear when maximum or minimum speed is reached.
- During Fast Play or Slow Play mode, you cannot change the angle (page 25), subtitle (page 25), or sound (page 43). The sound can only be changed for VIDEO CDs/Super VCDs.
- Fast Play and Slow Play functions do not work when playing DTS sound tracks.
- You cannot use Fast Play or Slow Play functions when playing a still picture in DVD-VR mode.



Locking the disc tray (Child Lock)

You can lock the disc tray to prevent children from opening it.

When the player is in standby mode, press  RETURN, ENTER, and then  on the remote.

The player turns on and “LOCKED” appears on the front panel display. The  button on the player or the remote does not work while the Child Lock is set.

To unlock the disc tray

When the player is in standby mode, press  RETURN, ENTER, and then  again.

Note

Even if you select “RESET” under “SETUP” in the Control Menu (page 54), the disc tray remains locked.

Resuming Playback From the Point Where You Stopped the Disc (Multi-disc Resume)

VCD

The player stores the point where you stopped the disc for up to 6 discs and resumes playback the next time you insert the same disc. If you store a resume playback point for the 7th disc, the resume playback point for the first disc is deleted.



1 While playing a disc, press to stop playback.

“RESUME” appears on the front panel display.

2 Press .

The player starts playback from the point where you stopped the disc in step 1.

Hint

To play from the beginning of the disc, press  twice, then press .

Notes

- “MULTI-DISC RESUME” in “CUSTOM SETUP” must be set to “ON” (default) for this function to work (page 57).
 - The point where you stopped playing is cleared when:
 - you change the play mode.
 - you change the settings on the Setup Display.
 - For DVD-VR mode, CDs, DATA CDs, and DATA DVDs, the player remembers the resume playback point for the current disc. The resume point is cleared when:
 - you opened the disc tray.
 - you disconnect the power cord.
 - the player enters standby mode (DATA CD/DATA DVD only).
 - Resume Play does not work during Shuffle Play and Program Play.
 - This function may not work with some discs.
 - If “MULTI-DISC RESUME” in “CUSTOM SETUP” is set to “ON” and you playback a recorded disc such as DVD-RW, the player may playback other recorded discs from the same resume point.
-

Using the DVD's Menu

A DVD VIDEO is divided into long sections of a picture or a music feature called “titles.” Press TOP MENU to select a title you want when you play a DVD VIDEO which contains several titles.

Press MENU to select items such as language for the sound and subtitles when you play a DVD VIDEO that allows you to do so.

Selecting “ORIGINAL” or “PLAY LIST” in DVD-VR mode

Some DVD-VR (Video Recording) mode have two types of titles for playback: originally recorded titles (ORIGINAL) and titles that can be created on recordable DVD players for editing (PLAY LIST). You can select the type of title to be played.

1 Press DISPLAY when the player is in stop mode.

The Control Menu appears.

2 Press to select (ORIGINAL/PLAY LIST), then press ENTER.

The options for “ORIGINAL/PLAY LIST” appear.

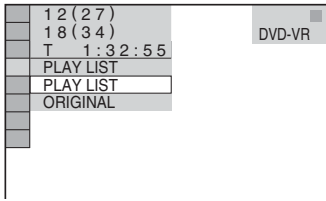

3 Press \uparrow/\downarrow to select a setting.

- PLAY LIST: plays the titles created from “ORIGINAL” for editing.
- ORIGINAL: plays the titles originally recorded.

4 Press ENTER.

Playing VIDEO CDs With PBC Functions (PBC Playback) **VCD**

PBC (Playback Control) allows you to play VIDEO CDs interactively by following the menu on the TV screen.

When you start playing a VIDEO CD with PBC functions, the menu for your selection appears.

Select an item using the number buttons, and press ENTER. Then, follow the instructions in the menu for interactive operations (press \triangleright when “Press SELECT” appears).

Refer to the instructions supplied with the disc, as the operating procedure may differ depending on the VIDEO CD.

To return to the menu

Press \circlearrowleft RETURN.

Hint

To play without using PBC, press \lll / \ggg or the number buttons while the player is stopped to select a track, then press \triangleright or ENTER.

“Play without PBC” appears on the TV screen and the player starts continuous play. You cannot play still pictures such as a menu.

To return to PBC playback, press \blacksquare twice then press \triangleright .

Checking the Playing Time and Remaining Time **DVDvideo** **DVDvr** **VCD**

CD **DATA CD** **DATA DVD**

You can check the playing time and remaining time of the current title, chapter, or track. Also, you can check the DVD/CD text, track name, or ID3 tag information (MP3 audio) recorded on the disc.

1 Press TIME/TEXT during playback.

The following display appears.

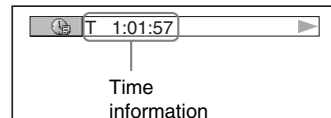

2 Press TIME/TEXT repeatedly to change the time information.

The available time information depends upon the type of disc you are playing.

Checking the play information of the disc

To check the DVD/CD text

Press TIME/TEXT repeatedly to display text recorded on the DVD/CD.

The DVD/CD text appears only when text is recorded in the disc. You cannot change the text. If the disc does not contain text, “NO TEXT” appears.

To check DATA CD/DATA DVD album name, etc.

By pressing TIME/TEXT while playing MP3 audio tracks on a DATA CD/DATA DVD, you can display the name of the album/track and the audio bit rate (the amount of data per second of the current audio track) on your TV screen.

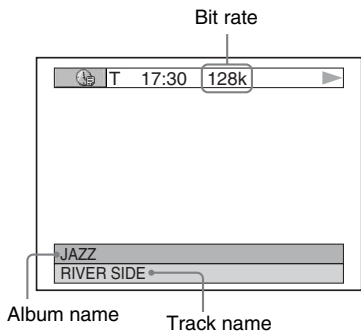

If an MP3 audio track has an ID3 tag, the player will display the album name/track title from the ID3 tag information. ID3 tag information for MP3 audio track is displayed when the tracks have ID3 version 1 or ID3 version 2. If there are ID3 version 1 and version 2 tags, ID3 version 2 tag information has priority. Note that this player supports ID3 versions 1.0/1.1 and 2.2/2.3.

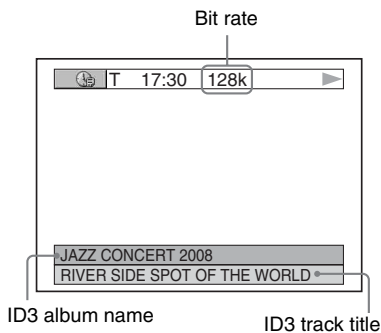

Checking the information on the front panel display

You can view the time information and text displayed on the TV screen also on the front panel display. The information on the front panel display changes as follows when you change the time information on your TV screen.

When playing a DVD

Playing time of the current title

T 10324

Remaining time of the current title

T- 1:15:36

Playing time of the current chapter

C 0:22:30

Remaining time of the current chapter

C-0:13:20

Text

SONY HI

Current title and chapter number

T 16 8

(returns to top automatically)

When playing a DATA CD (MP3 audio) or DATA DVD (MP3 audio)

Playing time and number of the current track

Track name or ID3 track title

Current album and track number
(returns to top automatically)

When playing a VIDEO CD (without PBC functions) or CD

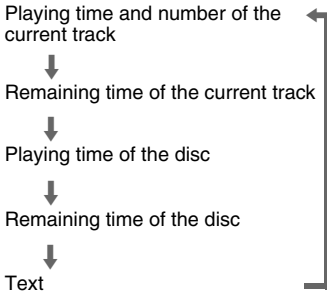

Hints

- When playing VIDEO CDs without PBC functions, the track number, and the index number are displayed after the text.
- When playing VIDEO CDs with PBC functions, the scene number, or the playing time are displayed.
- Long text that does not fit in a single line will scroll across the front panel display.
- You can also check the time information and text using the Control Menu (page 11).

Notes

- Depending on the type of disc being played, the DVD/CD text or track name may not be displayed.
- The player can only display the first level of the DVD/CD text, such as the disc name or title.
- Playing time of MP3 audio tracks may not be displayed correctly.
- If you play a disc containing JPEG image files only, “BGM” appears when “MODE (MP3, JPEG)” is set to “AUTO” or “AUTO (BGM),” and “JPEG” appears when “MODE (MP3, JPEG)” is set to “IMAGE (JPEG)” in the front panel display.

Various Play Mode Functions (Program Play, Shuffle Play, Repeat Play, A-B Repeat Play)

You can set the following play modes:

- Program Play (page 29)
- Shuffle Play (page 31)
- Repeat Play (page 31)
- A-B Repeat Play (page 32)

Note

The play mode is canceled when:

- you open the disc tray.
- the player enters standby mode by pressing .

Creating your own program (Program Play)

You can play the contents of a disc in the order you want by arranging the order of the titles, chapters, or tracks on the disc to create your own program. You can program up to 99 titles, chapters, and tracks.

1 Press DISPLAY.

The Control Menu appears.

2 Press to select (PROGRAM), then press ENTER.

The options for “PROGRAM” appear.

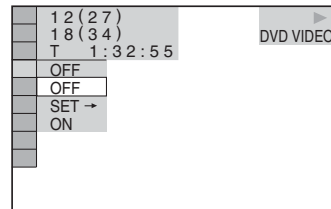

3 Press \uparrow/\downarrow to select “SET \rightarrow ,” then press ENTER.

“TRACK” is displayed when you play a VIDEO CD or CD.

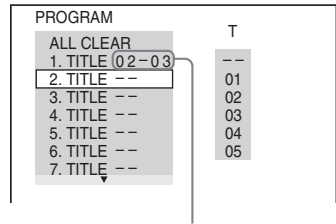
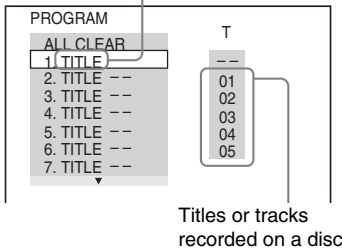

◆ **When playing a VIDEO CD or CD**

For example, select track “02.”

Press \uparrow/\downarrow to select “02” under “T,” then press ENTER.

4 Press \rightarrow .

The cursor moves to the title or track row “T” (in this case, “01”).

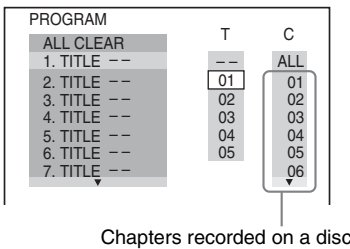

Selected track

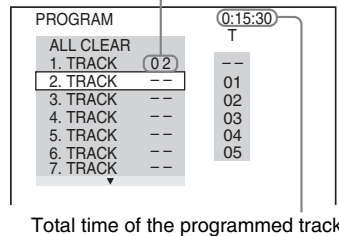

6 To program other titles, chapters, or tracks, repeat steps 4 to 5.

The programmed titles, chapters, and tracks are displayed in the selected order.

5 Select the title, chapter, or track you want to program.

◆ **When playing a DVD VIDEO**

For example, select chapter “03” of title “02.”

Press \uparrow/\downarrow to select “02” under “T,” then press ENTER.

7 Press \triangleright to start Program Play.

Program Play begins.

When the program ends, you can restart the same program again by pressing \triangleright .

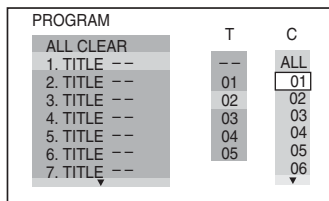

Next, press \uparrow/\downarrow to select “03” under “C,” then press ENTER.

To return to normal play

Press CLEAR, or select “OFF” in step 3. To play the same program again, select “ON” in step 3 and press ENTER.

To change or cancel a program

- Follow steps 1 to 3 of “Creating your own program (Program Play).”
- Select the program number of the title, chapter, or track you want to change or cancel using \uparrow/\downarrow and press \rightarrow . If you want to delete the title, chapter, or track from the program, press CLEAR.
- Follow step 5 for new programming. To cancel a program, select “--” under “T,” then press ENTER.

To cancel all of the titles, chapters, or tracks in the programmed order

- 1 Follow steps 1 to 3 of “Creating your own program (Program Play).”
- 2 Press **↑** and select “ALL CLEAR.”
- 3 Press **ENTER**.

Hint

You can perform Repeat Play, or Shuffle Play of programmed titles, chapters, or tracks. During Program Play, follow the steps of Repeat Play (page 31) or Shuffle Play (page 31).

Notes

- When you program tracks on a Super VCD, the total playing time is not displayed.
- You cannot use this function with VIDEO CDs or Super VCDs with PBC playback.

Playing in random order (Shuffle Play)

DVDVideo **VCD** **CD**

You can have the player “shuffle” titles, chapters, or tracks. Subsequent “shuffling” may produce a different playing order.

1 Press **DISPLAY** during playback.

The Control Menu appears.

2 Press **↑/↓** to select (SHUFFLE), then press **ENTER**.

The options for “SHUFFLE” appear.

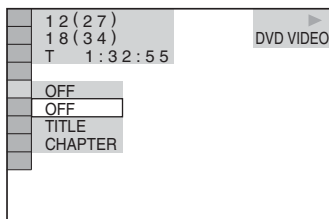

3 Press **↑/↓** to select the item to be shuffled.

◆ When playing a DVD VIDEO

- TITLE
- CHAPTER

◆ When playing a VIDEO CD or CD

- TRACK

◆ When Program Play is activated

- ON: shuffles titles, chapters, or tracks selected in Program Play.

4 Press **ENTER**.

Shuffle Play starts.

To return to normal play

Press **CLEAR**, or select “OFF” in step 3.

Hints

- You can set Shuffle Play while the player is stopped. After selecting the “SHUFFLE” option, press **▷**. Shuffle Play starts.
- Up to 200 chapters in a disc can be played in random order when “CHAPTER” is selected.

Note

You cannot use this function with VIDEO CDs or Super VCDs with PBC playback.

Playing repeatedly (Repeat Play)

DVDVideo **DVDVR** **VCD** **CD** **DATA CD** **DATA DVD**

You can play all of the titles or tracks on a disc, or a single title, chapter, or track repeatedly.

You can use a combination of Shuffle or Program Play modes.

1 Press **DISPLAY** during playback.

The Control Menu appears.

2 Press **↑/↓** to select (REPEAT), then press **ENTER**.

The options for “REPEAT” appear.

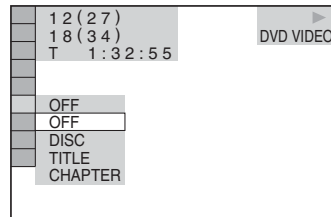

3 Press **↑/↓** to select the item to be repeated.

◆ When playing a DVD VIDEO

- DISC: repeats all of the titles.
- TITLE: repeats the current title on a disc.
- CHAPTER: repeats the current chapter.

◆ When playing in DVD-VR mode

- DISC: repeats all the titles of the selected type.
- TITLE: repeats the current title on a disc.

• CHAPTER: repeats the current chapter.

◆ **When playing a VIDEO CD or CD**

- DISC: repeats all of the tracks.
- TRACK: repeats the current track.

◆ **When playing a DATA CD or DATA DVD**

- DISC: repeats all of the albums.
- ALBUM: repeats the current album.
- TRACK (MP3 audio tracks only): repeats the current track.

◆ **When Program Play or Shuffle Play is activated**

- ON: repeats Program Play or Shuffle Play.

4 Press ENTER.

Repeat Play starts.

To return to normal play

Press CLEAR, or select “OFF” in step 3.

Hint

You can set Repeat Play while the player is stopped. After selecting the “REPEAT” option, press . Repeat Play starts.

Notes

- You cannot use this function with VIDEO CDs or Super VCDs with PBC playback.
- When repeating a DATA CD/DATA DVD which contains MP3 audio tracks and JPEG image files, and their playing times are not the same, the sound will not match the image.
- When “MODE (MP3, JPEG)” is set to “IMAGE (JPEG)” (page 50), you cannot select “TRACK.”

Repeating a specific portion (A-B Repeat Play)

DVDVideo DVDVR VCD CD

You can play a specific portion of a title, chapter, or track repeatedly. (This function is useful when you want to memorize lyrics, etc.)

1 Press DISPLAY during playback.

The Control Menu appears.

2 Press to select (A-B REPEAT), then press ENTER.

The options for “A-B REPEAT” appear.

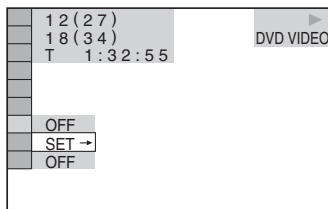

3 Press to select “SET ->,” then press ENTER.

The “A-B REPEAT” setting bar appears.

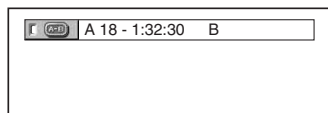

4 During playback, when you find the starting point (point A) of the portion to be played repeatedly, press ENTER.

The starting point (point A) is set.

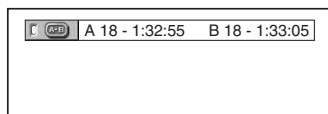

5 When you reach the ending point (point B), press ENTER again.

The set points are displayed and the player starts repeating this specific portion.

To return to normal play

Press CLEAR, or select “OFF” in step 3.

Notes

- When you set A-B Repeat Play, the settings for Shuffle Play, Repeat Play, and Program Play are canceled.
- A-B Repeat Play does not work across multiple titles.
- You may not set A-B Repeat Play for contents in DVD-VR mode that contains still pictures.

Adjusting the Playback Picture (CUSTOM PICTURE MODE)

DVD Video DVD VCR VCD DATA CD

DATA DVD

You can adjust the video signal of the DVD, VIDEO CD, or DATA CD/DATA DVD in JPEG format from the player to obtain the picture quality you want. Choose the setting that best suits the program you are watching. When you select "MEMORY," you can make further adjustments to each element of the picture (color, brightness, etc.).

1 Press DISPLAY twice during playback.

The Control Menu appears.

2 Press \uparrow/\downarrow to select (CUSTOM PICTURE MODE), then press ENTER.

The options for "CUSTOM PICTURE MODE" appear.

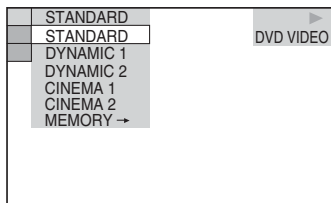

3 Press \uparrow/\downarrow to select the setting you want.

The default setting is underlined.

- **STANDARD**: displays a standard picture.
- **DYNAMIC 1**: produces a bold dynamic picture by increasing the picture contrast and the color intensity.
- **DYNAMIC 2**: produces a more dynamic picture than DYNAMIC 1 by further increasing the picture contrast and color intensity.
- **CINEMA 1**: enhances details in dark areas by increasing the black level.

- **CINEMA 2**: white colors become brighter and black colors become richer and the color contrast is increased.
- **MEMORY**: adjusts the picture in greater detail.

4 Press ENTER.

The selected setting takes effect.

Hint

When you watch a movie, "CINEMA 1" or "CINEMA 2" is recommended.

Adjusting the picture items in "MEMORY"

You can adjust each element of the picture individually.

- **PICTURE**: changes the contrast
- **BRIGHTNESS**: changes the overall brightness
- **COLOR**: makes the colors deeper or lighter
- **HUE**: changes the color balance

1 In step 3 of "Adjusting the Playback Picture," select "MEMORY" and press ENTER.

The "PICTURE" adjustment bar appears.



2 Press \leftarrow/\rightarrow to adjust the picture contrast.

To go to the next or previous picture item without saving the current setting, press \uparrow/\downarrow .

3 Press ENTER.

The adjustment is saved and "BRIGHTNESS" adjustment bar appears.

4 Repeat step 2 and 3 to adjust "BRIGHTNESS," "COLOR," and "HUE."

To turn off the display

Press  RETURN or DISPLAY.

Notes

- This function does not work when “PhotoTV HD” mode is activated (page 50).
- This function does not work if your TV supports “THEATRE” mode and it is set to “ON,” and “CONTROL FOR HDMI” is set to “ON.” For more details, refer to the operation instructions supplied with the TV.

Sharpening the Picture

(SHARPNESS)   

You can enhance the outlines of images to produce a sharper picture.

1 Press DISPLAY twice during playback.

The Control Menu appears.

2 Press to select (SHARPNESS), then press ENTER.

The options for “SHARPNESS” appear.

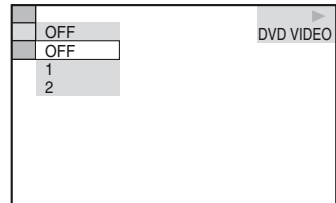

3 Press to select a level.

- 1: enhances the outline.
- 2: enhances the outline more than 1.

4 Press ENTER.

The selected setting takes effect.

To cancel the “SHARPNESS” setting

Select “OFF” in step 3.

Notes

- This function does not work when “PhotoTV HD” mode is activated (page 50).
- This function does not work if your TV supports “THEATRE” mode and it is set to “ON,” and “CONTROL FOR HDMI” is set to “ON.” For more details, refer to the operation instructions supplied with the TV.

Adjusting the Delay Between the Picture and Sound (AV SYNC)

DVDvideo DVDvr VCD

When the sound does not match the pictures on the screen, you can adjust the delay between the picture and sound.

1 Press DISPLAY twice during playback.

The Control Menu appears.

2 Press \uparrow/\downarrow to select (AV SYNC), then press ENTER.

The following display appears.

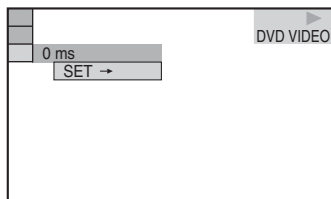

3 Press \downarrow to select "SET ->", then press ENTER.

The "AV SYNC" adjustment bar appears.



4 Press \rightarrow repeatedly to adjust the delay.

Each time you press \leftarrow/\rightarrow , the delay is adjusted by 10 milliseconds.

5 Press ENTER.

The selected setting takes effect.

To reset the "AV SYNC" setting

Press CLEAR in step 4.

Notes

- This function is not effective if you use the DIGITAL OUT (OPTICAL or COAXIAL) jack, and set "DOLBY DIGITAL" or "DTS" in AUDIO SETUP to "DOLBY DIGITAL" or "ON" respectively (page 58).
- This function is not effective if you connect a Dolby Digital or DTS-compliant device via the HDMI OUT jack, and set "DOLBY DIGITAL" or "DTS" in AUDIO SETUP to "DOLBY DIGITAL" or "ON" respectively (page 58).

Locking Discs (CUSTOM PARENTAL CONTROL, PARENTAL CONTROL)

You can set two kinds of playback restrictions for a disc.

- Custom Parental Control

You can set playback restrictions so that the player will not play inappropriate discs.

- Parental Control

Playback of some DVD VIDEOS can be limited according to a predetermined level such as the age of the users. Scenes may be blocked or replaced with different scenes.

The same password is used for both Parental Control and Custom Parental Control.

Custom Parental Control

DVDVideo VCD CD

You can set the same Custom Parental Control password for up to 40 discs. When you set the 41st-disc, the first disc is canceled.

1 Insert the disc you want to lock.

If the disc is playing, press ■ to stop playback.

2 Press DISPLAY while the player is in stop mode.

The Control Menu appears.

3 Press ↑/↓ to select (PARENTAL CONTROL), then press ENTER.

The options for “PARENTAL CONTROL” appear.

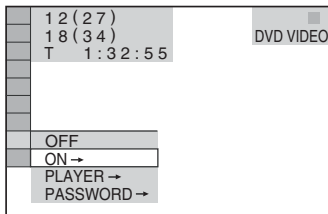

4 Press ↑/↓ to select “ON →,” then press ENTER.

- ◆ If you have not entered a password

The display for registering a new password appears.

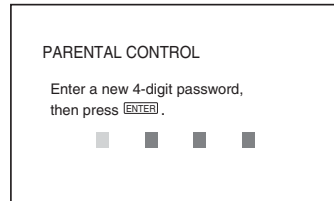

Enter a 4-digit password using the number buttons, then press ENTER.

The display for confirming the password appears.

- ◆ When you have already registered a password

The display for entering the password appears.

5 Enter or re-enter your 4-digit password using the number buttons, then press ENTER.

“Custom parental control is set.” appears and then the screen returns to the Control Menu.

To turn off the Custom Parental Control function

1 Follow steps 1 to 3 of “Custom Parental Control.”

2 Press ↑/↓ to select “OFF →,” then press ENTER.

3 Enter your 4-digit password using the number buttons, then press ENTER.

To play a disc for which Custom Parental Control is set

- 1 Insert the disc for which Custom Parental Control is set.
The "CUSTOM PARENTAL CONTROL" display appears.

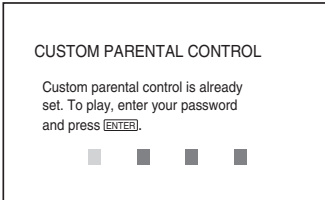

- 2 Enter your 4-digit password using the number buttons, then press ENTER.
The player is ready for playback.

Hint

If you forget your password, enter the 6-digit number "199703" using the number buttons when the "CUSTOM PARENTAL CONTROL" display asks you for your password, then press ENTER. The display will ask you to enter a new 4-digit password.

Parental Control (limited playback)

Playback of some DVD VIDEOS can be limited according to a predetermined level such as the age of the users. The "PARENTAL CONTROL" function allows you to set a playback limitation level.

- 1 Press **DISPLAY** while the player is in stop mode.
The Control Menu appears.
- 2 Press **↑/↓** to select (PARENTAL CONTROL), then press **ENTER**.

The options for "PARENTAL CONTROL" appear.

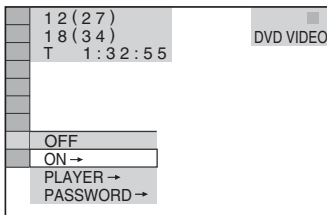

- 3 Press **↑/↓** to select "PLAYER →," then press **ENTER**.

◆ If you have not entered a password

The display for registering a new password appears.
Enter a 4-digit password using the number buttons, then press ENTER.
The display for confirming the password appears.

◆ When you have already registered a password

The display for entering the password appears.

- 4 Enter or re-enter your 4-digit password using the number buttons, then press **ENTER**.

The display for setting the playback limitation level appears.

- 5 Press **↑/↓** to select "STANDARD," then press **ENTER**.

The selection items for "STANDARD" are displayed.

- 6 Press **↑/↓** to select a geographic area as the playback limitation level, then press **ENTER**.

The area is selected.

When you select "OTHERS →," select and enter a standard code in the table on page 68 using the number buttons.

- 7 Press **↑/↓** to select "LEVEL," then press **ENTER**.

The selection items for "LEVEL" are displayed.

- 8 Select the level you want using **↑/↓**, then press **ENTER**.

Parental Control setting is complete.
The lower the value, the stricter the limitation.

To turn off the Parental Control function

Set “LEVEL” to “OFF” in step 8.

To play a disc for which Parental Control is set

- 1 Insert the disc and press \triangleright .
The display for entering your password appears.
- 2 Enter your 4-digit password using the number buttons, then press ENTER.
The player starts playback.

Hint

If you forget your password, remove the disc and repeat steps 1 to 3 of “Parental Control (limited playback).” When you are asked to enter your password, enter “199703” using the number buttons, then press ENTER. The display will ask you to enter a new 4-digit password. After you enter a new 4-digit password, replace the disc in the player and press \triangleright . When the display for entering your password appears, enter your new password.

Notes

- When you play discs which do not have the Parental Control function, playback cannot be limited on this player.
- Depending on the disc, you may be asked to change the parental control level while playing the disc. In this case, enter your password, then change the level. If the Resume Play mode is canceled, the level returns to the previous level.

Changing the password

- 1 Press DISPLAY while the player is in stop mode.
The Control Menu appears.
- 2 Press \uparrow/\downarrow to select  (PARENTAL CONTROL), then press ENTER.
The options for “PARENTAL CONTROL” appear.
- 3 Press \uparrow/\downarrow to select “PASSWORD \rightarrow ,” then press ENTER.
The display for entering the password appears.
- 4 Enter your 4-digit password using the number buttons, then press ENTER.
- 5 Enter a new 4-digit password using the number buttons, then press ENTER.
- 6 To confirm your password, re-enter it using the number buttons, then press ENTER.

If you make a mistake entering your password

Press \leftarrow before you press ENTER and input the correct number.

Searching for a Scene

Searching for a Particular Point on a Disc (Scan, Slow-motion Play, Freeze Frame)

You can quickly locate a particular point on a disc by monitoring the picture or playing back slowly.

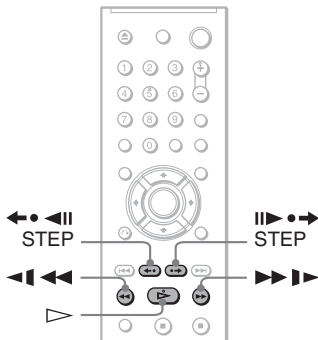

Notes

- Depending on the disc, you may not be able to do some of the operations described.
- For DATA CDs/DATA DVDs, you can search for a particular point only on an MP3 audio track.

Locating a point quickly by playing a disc in fast forward or fast reverse (Scan)

DVDVideo DVDvr VCD CD DATA CD DATA DVD

Press **◀◀◀** or **▶▶▶** while playing a disc. When you find the point you want, press **▷** to return to normal speed. Each time you press **◀◀◀** or **▶▶▶** during scan, the scan speed changes. With each press the indication changes as shown below. Actual speeds may differ between discs.

Playback direction

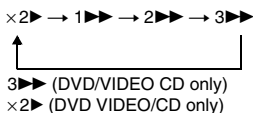

Opposite direction

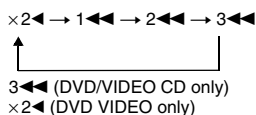

The “ $\times 2 \blacktriangleright$ ”/“ $\times 2 \blacktriangleleft$ ” playback speed is about twice the normal speed.

The “ $3 \blacktriangleright$ ”/“ $3 \blacktriangleleft$ ” playback speed is faster than “ $2 \blacktriangleright$ ”/“ $2 \blacktriangleleft$ ” and the “ $2 \blacktriangleright$ ”/“ $2 \blacktriangleleft$ ” playback speed is faster than “ $1 \blacktriangleright$ ”/“ $1 \blacktriangleleft$ ”.

Watching frame by frame (Slow-motion Play)

DVDVideo DVDvr VCD

Press **◀◀◀** or **▶▶▶** when the player is in pause mode. To return to normal speed, press **▷**.

Each time you press **◀◀◀** or **▶▶▶** during Slow-motion Play, the playback speed changes. Two speeds are available. With each press the indication changes as follows:

Playback direction

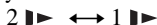

Opposite direction (DVD only)

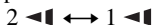

The “ $2 \blacktriangleright$ ”/“ $2 \blacktriangleleft$ ” playback speed is slower than “ $1 \blacktriangleright$ ”/“ $1 \blacktriangleleft$ ”.

Playing one frame at a time (Freeze Frame)

DVDVideo DVDvr VCD

When the player is in the pause mode, press **▶▶▶** to go to the next frame. Press **◀◀◀** to go to the preceding frame (DVD only). To return to normal playback, press **▷**.

Note

You cannot search for a still picture in DVD-Vr mode.

Searching for a Title/ Chapter/Track/Scene, etc.

DVDVideo DVDVR VCD CD

DATA CD DATA DVD

You can search a DVD by title or chapter, and you can search a VIDEO CD/CD/DATA CD/DATA DVD by track, index, file, or scene. As titles and tracks are assigned unique numbers on the disc, you can select the desired one by entering its number. You can also search for a scene using the time code.

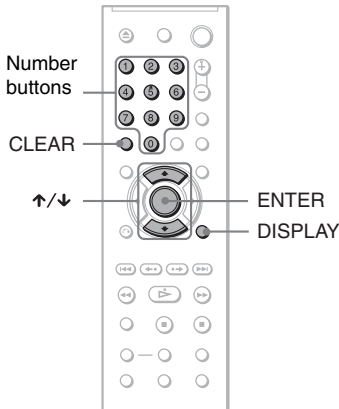



1 Press DISPLAY (When playing a DATA CD or DATA DVD with JPEG image files, press twice).

The Control Menu appears.

2 Press ↑/↓ to select the search method.

◆ When playing a DVD

-  TITLE
-  CHAPTER
-  TIME/TEXT

Select "TIME/TEXT" to search for a starting point by inputting the time code.

◆ When playing a VIDEO CD or Super VCD without PBC Playback

-  TRACK
-  INDEX



◆ When playing a VIDEO CD or Super VCD with PBC Playback

-  SCENE

◆ When playing a CD

-  TRACK

◆ When playing a DATA CD/DATA DVD

-  ALBUM
-  TRACK (MP3 audio tracks only)
-  FILE (JPEG image files only)

Example: when you select  CHAPTER

“** (***)” is selected (** refers to a number). The number in parentheses indicates the total number of titles, chapters, tracks, indexes, scenes, albums, or files.

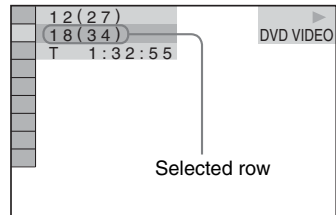

3 Press ENTER.

“** (***)” changes to “-- (**).”

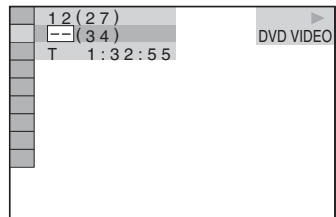

4 Press the number buttons to select the title, chapter, track, index, scene, etc., number you want to search.

If you make a mistake

Cancel the number by pressing CLEAR, then select another number.

5 Press ENTER.

The player starts playback from the selected number.

To search for a scene using the time code (DVD only)

1 In step 2, select TIME/TEXT.

Playing time of the current title is selected.

Then, press ENTER.

2 Input the time code using the number buttons, then press ENTER.

For example, to find the scene at 2 hours, 10 minutes, and 20 seconds after the beginning, just enter "2:10:20."

Hints

- When the Control Menu display is turned off, you can search for a chapter (DVD) or track (CD/DATA CD/DATA DVD) by pressing the number buttons and ENTER.
- You can display the first scene of titles, chapters, or tracks recorded on the disc on a screen divided into 9 sections. You can start playback directly by selecting one of the scenes. For details, see "Searching by Scene (PICTURE NAVIGATION)" (page 41).

Notes

- The title, chapter, or track number displayed is the same number recorded on the disc.
- You cannot search for a scene on a DVD+RW/DVD+R/DVD+R DL using the time code.

Searching by Scene

(PICTURE NAVIGATION) **DVD**Video **VCD**

You can divide the screen into 9 subsections and find the desired scene quickly.

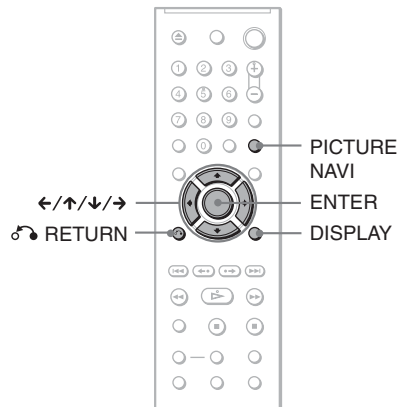

1 Press PICTURE NAVI during playback.

The following display appears.

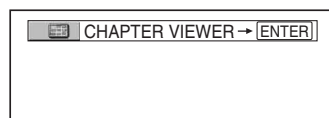

2 Press PICTURE NAVI repeatedly to select an item.

- CHAPTER VIEWER (DVD VIDEO only): displays the first scene of each chapter.
- TITLE VIEWER (DVD VIDEO only): displays the first scene of each title.
- TRACK VIEWER (VIDEO CD/Super VCD only): displays the first scene of each track.

3 Press ENTER.

The first scene of each chapter, title, or track appears as follows.

1	2	3	▼
4	5	6	
7	8	9	

4 Press ←/↑/↓/→ to select a chapter, title, or track, and press ENTER.

Playback starts from the selected scene.

To return to normal play during setting

Press ↶ RETURN or DISPLAY.

💡 Hint

If there are more than 9 chapters, titles, or tracks, ▼ is displayed at the bottom right of the screen.

To display the additional chapters, titles, or tracks, select the bottom scenes and press ↓. To return to the previous scene, select the top scenes and press ↑.

Note

Depending on the disc, you may not be able to select some items.

Sound Adjustments

Changing the Sound

- DVD Video
- DVD VR
- VCD
- CD
- DATA CD
- DATA DVD

When playing a DVD VIDEO recorded in multiple audio formats (PCM, Dolby Digital, or DTS), you can change the audio format. If the DVD VIDEO is recorded with multilingual tracks, you can also change the language.

With CDs or VIDEO CDs, you can select the sound from either the right or left channel and listen to the sound of the selected channel through both the right and left speakers. For example, when playing a disc containing a song with the vocals on the right channel and the instruments on the left channel, you can hear the instruments from both speakers by selecting the left channel.

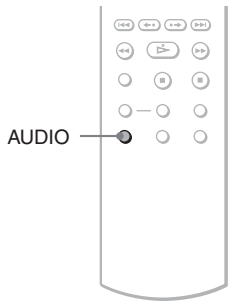

1 Press AUDIO during playback.

The following display appears.

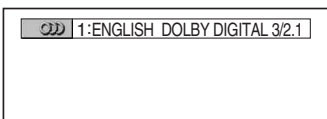

2 Press AUDIO repeatedly to select the desired audio signal.

◆ When playing a DVD VIDEO

Depending on the DVD VIDEO, the choice of language varies. When 4 digits are displayed, they indicate a language code. See “Language Code List” on page 68 to see which language the code represents. When the same language is displayed two or more times, the DVD VIDEO is recorded in multiple audio formats.

◆ When playing in DVD-VR mode

The types of sound tracks recorded on a disc are displayed. The default setting is underlined.

Example:

- 1: MAIN (main sound)
- 1: SUB (sub sound)
- 1: MAIN+SUB (main and sub sound)

◆ When playing a VIDEO CD or CD

The default setting is underlined.

- STEREO: the standard stereo sound
- 1/L: the sound of the left channel (monaural)
- 2/R: the sound of the right channel (monaural)

◆ When playing a Super VCD

The default setting is underlined.

- 1:STEREO: the stereo sound of the audio track 1
- 1:1/L: the sound of the left channel of the audio track 1 (monaural)
- 1:2/R: the sound of the right channel of the audio track 1 (monaural)
- 2:STEREO: the stereo sound of the audio track 2
- 2:1/L: the sound of the left channel of the audio track 2 (monaural)
- 2:2/R: the sound of the right channel of the audio track 2 (monaural)

◆ When playing DATA CD or DATA DVD

The player’s internal background sound will be played.

The default setting is underlined.

- BGM 1
- BGM 2
- BGM 3
- BGM 4

Notes

- While playing a Super VCD on which the audio track 2 is not recorded, no sound will come out when you select “2:STEREO,” “2:1/L,” or “2:2/R.”
- When playing in DVD-VR mode: If you connect to an audio component using the DIGITAL OUT (COAXIAL or OPTICAL)/HDMI OUT jack and want to switch between the sound tracks, set “DOLBY DIGITAL” to “D-PCM” in “AUDIO SETUP” (page 59).
- If “MODE (MP3, JPEG)” is set to “AUTO” or “AUTO (BGM)” (page 50), you can hear the player’s internal background sound when MP3 is not played.

Note

If “DTS” is set to “OFF” in “AUDIO SETUP” (page 59), the DTS track selection option will not appear on the screen even if the disc contains DTS tracks.

Checking the audio signal format DVD Video

You can check the audio signal format by pressing AUDIO repeatedly during playback. The format of the current audio signal (Dolby Digital, DTS, PCM, etc.) appears as shown below.

Example:

Dolby Digital 5.1 ch

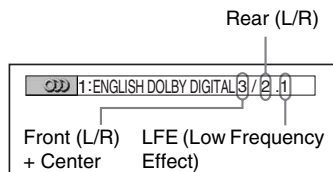

About audio signals

Audio signals recorded in a disc contain the sound elements (channels) shown below.

Each channel is output from a separate speaker.

- Front (L)
- Front (R)
- Center
- Rear (L)
- Rear (R)
- Rear (Monaural): This signal can be either the Dolby Surround Sound processed signals or the Dolby Digital sound’s monaural rear audio signals.
- LFE (Low Frequency Effect) signal

TV Virtual Surround Settings (TVS) DVDVideo

When you connect a stereo TV or 2 front speakers, TVS (TV Virtual Surround) lets you enjoy surround sound effects by using sound imaging to create virtual rear speakers from the sound of the front speakers (L: left, R: right) without using actual rear speakers. TVS was developed by Sony to produce surround sound for home use using just a stereo TV.

This only works when playing a multichannel Dolby audio sound track. Furthermore, if the player is set up to output the signal from the DIGITAL OUT (OPTICAL or COAXIAL)/HDMI OUT jack, the surround effect will only be heard when "DOLBY DIGITAL" is set to "D-PCM" in "AUDIO SETUP" (page 58).

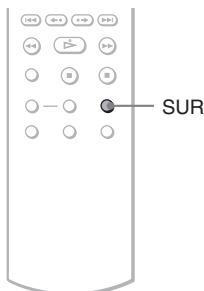

1 Press SUR during playback.

The following display appears.

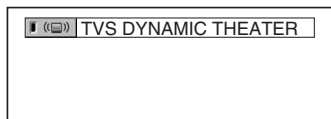

2 Press SUR repeatedly to select one of the TVS sounds.

See the explanations given for each item in the following section.

- TVS DYNAMIC THEATER
- TVS DYNAMIC
- TVS WIDE
- TVS NIGHT
- TVS STANDARD

To cancel the setting

Select "OFF" in step 2.

◆TVS DYNAMIC THEATER, TVS DYNAMIC, TVS WIDE

This mode is effective when the distance between the front L and R speakers is short, such as with built-in speakers on a stereo TV.

◆TVS NIGHT

This feature is useful when you want to hear the dialog and enjoy the surround sound effects of "TVS WIDE" at low volume.

◆TVS STANDARD

Use this setting when you want to use TVS with 2 separate speakers.

Notes

- When the playing signal does not contain a signal for the rear speakers, the surround effects cannot be heard.
- When you select one of the TVS modes, turn off the surround setting of the connected TV or audio component.
- Make sure that your listening position is between and at an equal distance from your speakers and that the speakers are located in similar surroundings.
- Not all discs will respond to the "TVS NIGHT" function in the same way.
- If you use the DIGITAL OUT (OPTICAL or COAXIAL)/HDMI OUT jack and set "DOLBY DIGITAL" to "DOLBY DIGITAL," and "DTS" to "ON" in "AUDIO SETUP," sound will come from your speakers but it will not have the SURROUND effect.
- The TVS effects do not work when using the Fast Play or Slow Play functions, even though you can change the TVS modes.

Enjoying MP3 Audio and JPEG Images

About MP3 Audio Tracks and JPEG Image Files

MP3 is audio compression technology that satisfies the ISO/IEC MPEG regulations. JPEG is image compression technology. You can play DATA CDs/DATA DVDs that contain MP3 audio tracks or JPEG image files.

DATA CDs/DATA DVDs that the player can play

You can play back DATA CDs or DATA DVDs recorded in MP3 (MPEG-1 Audio Layer III) and JPEG format. However, this player only plays DATA CDs whose logical format is ISO 9660 Level 1/ Level 2 or Joliet, and DATA DVDs of Universal Disk Format (UDF). Refer to the instructions supplied with the disc drives and the recording software (not supplied) for details on the recording format.

Note

The player may not be able to play some DATA CDs/DATA DVDs created in the Packet Write format.

MP3 audio track or JPEG image file that the player can play

The player can play the following tracks and files:

- MP3 audio tracks with the extension “.MP3.”
- JPEG image files with the extension “.JPEG” or “.JPG.”
- JPEG image files that conform to the DCF* image file format.

* “Design rule for Camera File system”: Image standards for digital cameras regulated by JEITA (Japan Electronics and Information Technology Industries Association).

Notes

- The player will play any data with the extension “.MP3,” “.JPG,” or “.JPEG,” even if they are not in MP3 or JPEG format. Playing these data may generate a loud noise which could damage your speaker system.
- The player does not conform to audio tracks in mp3PRO format.
- Some JPEG files cannot be played.

About playback order of albums, tracks, and files

Albums play in the following order:

◆Structure of disc contents

Tree 1 Tree 2 Tree 3 Tree 4 Tree 5

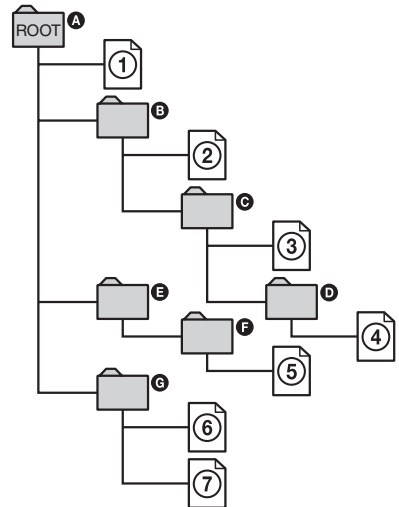

When you insert a DATA CD/DATA DVD and press \triangleright , the numbered tracks (or files) are played sequentially, from ① through ⑦. Any sub-albums/tracks (or files) contained within a currently selected album take priority over the next album in the same tree. (Example: ③ contains ④ so ④ is played before ⑤.)

When you press MENU and the list of album names appears, the album names are arranged in the following order:

A → **B** → **C** → **D** → **F** → **G**. Albums that do not contain tracks (or files) (such as album **E**) do not appear in the list.

💡 Hints

- If you add numbers (01, 02, 03, etc.) to the front of the track/file names when you store the tracks (or files) in a disc, the tracks and files will be played in that order.
- Since a disc with many tracks takes longer to start playback, it is recommended that you create albums with no more than two tracks.

Notes

- Depending on the software you use to create the DATA CD/DATA DVD, the playback order may differ from the above illustration.
- The playback order above may not be applicable if there are more than 200 albums and 300 tracks/files in each album.
- The player can recognize up to 200 albums (the player will count just albums, including albums that do not contain MP3 audio tracks and JPEG image files). The player will not play any albums beyond the 200th album.
- Proceeding to the next or another album may take some time.

Playing MP3 Audio Tracks or JPEG Image Files **DATA CD** **DATA DVD**

You can play MP3 audio tracks and JPEG image files on DATA CDs or DATA DVDs.

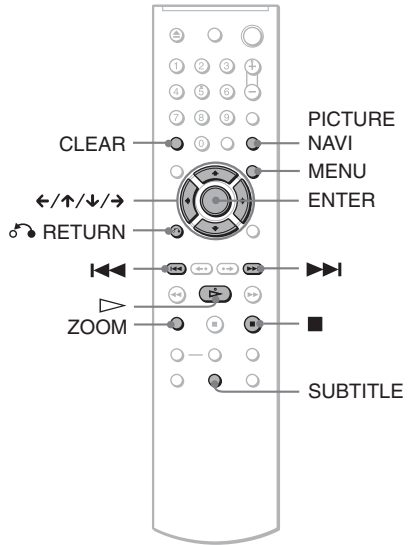

Enjoying MP3 Audio and JPEG Images

💡 Hint

You can view the disc information while playing MP3 audio tracks (page 27).

Notes

- DATA CDs recorded in KODAK Picture CD format automatically start playing when inserted.
- If no MP3 audio track or JPEG image file is recorded on the DATA CD/DATA DVD, “No audio data” or “No image data” appears on the screen.

Selecting an album

1 Press MENU.

The list of albums on the disc appears. When an album is being played, its title is shaded.

2 Press \uparrow/\downarrow to select the album you want to play.

3 Press \triangleright .

Playback starts from the selected album. To select MP3 audio tracks, see "Selecting an MP3 audio track" (page 48). To select JPEG image files, see "Selecting a JPEG image file" (page 48).

To stop playback

Press \blacksquare .

To go to the next or previous page

Press \rightarrow or \leftarrow .

To turn on or off the display

Press MENU repeatedly.

Hint

Of the selected album, you can select to play only the MP3 audio tracks, JPEG image files, or both, by setting "MODE (MP3, JPEG)" (page 50).

Selecting an MP3 audio track

1 After step 2 of "Selecting an album," press ENTER.

The list of tracks in the album appears.

2 Press \uparrow/\downarrow to select a track and press ENTER.

Playback starts from the selected track.

To stop playback

Press \blacksquare .

To go to the next or previous page

Press \rightarrow or \leftarrow .

To return to the previous display

Press \curvearrowright RETURN.

To go to the next or previous MP3 audio track

Press $\blacktriangleright\blacktriangleright$ or $\blacktriangleleft\blacktriangleleft$ during playback. You can select the first track of the next album by pressing $\blacktriangleright\blacktriangleright$ during playback of the last track of the current album.

Note that you cannot return to the previous album by using $\blacktriangleleft\blacktriangleleft$ and that you need to select the previous album from the album list.

Selecting a JPEG image file

1 After step 2 of "Selecting an album," press PICTURE NAVI.

The image files in the album appear in 16 subscreens. A scroll box is displayed on the right.

1	2	3	4	
5	6	7	8	
9	10	11	12	
13	14	15	16	

To display additional images, select a bottom image and press \downarrow . To return to a previous image, select a top image and press \uparrow .

2 Press $\leftarrow/\uparrow/\downarrow/\rightarrow$ to select the image you want to view, and press ENTER.

The selected image appears.

To go to the next or previous JPEG image file

Press \leftarrow or \rightarrow during playback. You can select the first file of the next album by pressing \rightarrow during playback of the last file of the current album.

Note that you cannot return to the previous album by using \leftarrow and that you need to select the previous album from the album list.

To rotate a JPEG image

Press \uparrow/\downarrow while viewing the image. Each time you press \uparrow , the image rotates counterclockwise by 90 degrees.

To return to normal view, press CLEAR.

Note that the view also returns to normal if you press \leftarrow/\rightarrow to go to the next or previous image.

To magnify a JPEG image (ZOOM)

Press ZOOM while viewing the image. You can enlarge the image up to four times the original size and scroll using ←/↑/↓/→.

To return to normal view, press CLEAR.

◆When pressed once (x2)

The image enlarges twice the original size.

◆When pressed twice (x4)

The image enlarges four times the original size.

To display JPEG image information

Press SUBTITLE while viewing JPEG image files.

The file name, camera maker/model, date, time, picture resolution, file size, camera setting information (ISO speed rating, Exposure time, F Number, Exposure bias, or Focal length) of the picture are displayed on the screen.

⚡ is displayed when the picture was taken using flash.

⌛ is displayed when the image is automatically rotated.

To hide the information, press SUBTITLE.

Note that the above information may not appear depending on the digital camera.

To stop viewing the JPEG image

Press ■.

💡 Hints

- While viewing JPEG image files, you can set options such as "INTERVAL" (page 51), "EFFECT" (page 51) and "SHARPNESS" (page 34).
- You can view JPEG images files without MP3 audio by setting "MODE (MP3, JPEG)" to "IMAGE (JPEG)" (page 50).
- The date the picture was taken is displayed beside "DATE" in the Control Menu (page 11). Note that no date may appear depending on the digital camera.

Note

PICTURE NAVI does not work if "AUDIO (MP3)" is selected in "MODE (MP3, JPEG)" (page 50).

Enjoying JPEG Images as a Slide Show

DATA CD DATA DVD

You can play JPEG image files on a DATA CD or DATA DVD successively as a slide show.

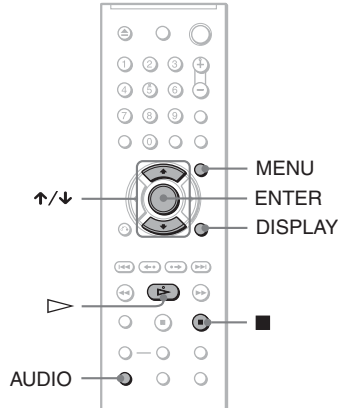

1 Press MENU.

The list of albums on the DATA CD/ DATA DVD appears.

2 Press ↑/↓ to select an album.

3 Press ▽.

The JPEG images in the selected album start playing as a slide show.

To stop playback

Press ■.

Notes

- The slide show stops when ↑/↓ or ZOOM is pressed. To resume the slide show, press ▽.
- This function does not work if "MODE (MP3, JPEG)" is set to "AUDIO (MP3)" (page 50).

Viewing a slide show with sound (MODE (MP3, JPEG))

You can enjoy a slide show with sound.

1 Press DISPLAY during stop mode.

The Control Menu appears.

2 Press \uparrow/\downarrow to select (MODE (MP3, JPEG)) and press ENTER.

The options for “MODE (MP3, JPEG)” appear.

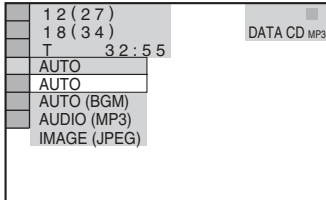

3 Press \uparrow/\downarrow to select “AUTO” (default), and press ENTER.

The default setting is underlined.

- AUTO: plays the JPEG image files with MP3 audio tracks. If there is no MP3 file, plays JPEG image files with the player’s internal background sound.
- AUTO (BGM): plays the JPEG image files with the player’s internal background sound. To choose the melody of the background sound, press AUDIO repeatedly while viewing the image. You can enjoy MP3 audio track whenever MP3 track is selected.
- AUDIO (MP3): plays only MP3 audio tracks continuously.
- IMAGE (JPEG): plays only JPEG image files continuously.

4 Press MENU.

The list of albums on the DATA CD/ DATA DVD appears.

5 Press \uparrow/\downarrow to select the album that contains both the MP3 audio tracks and JPEG images you want to play.

6 Press \triangleright .

A slide show starts with sound.

Hints

- To repeat both MP3 audio tracks and JPEG image files in a single album, repeat the same MP3 audio track or album when “MODE (MP3, JPEG)” is set to “AUTO” or “AUTO (BGM)”. See “Playing repeatedly (Repeat Play)” (page 31) to repeat the track or album.
- The player recognizes a maximum of 200 albums regardless of the selected mode. Of each album, the player recognizes up to 300 MP3 audio tracks and 300 JPEG image files when “AUTO” or “AUTO (BGM)” is selected, 600 MP3 audio tracks when “AUDIO (MP3)” is selected, 600 JPEG image files when “IMAGE (JPEG)” is selected.

Notes

- If you play a disc containing MP3 audio tracks only and “MODE (MP3, JPEG)” is set to “AUTO” or “AUTO (BGM)”, you can listen to MP3 audio tracks only.
- If you play a disc containing JPEG image files only, the player’s internal background sound will be played when “MODE (MP3, JPEG)” is set to “AUTO” or “AUTO (BGM)”.
- If JPEG playback finishes during MP3 playback, MP3 playback continues with background picture.
- If MP3 playback finishes during JPEG playback, player’s internal background sound starts.
- If you play large MP3 track data and JPEG image data at the same time, the sound may skip. It is recommended that you set the MP3 bit rate to 128 kbps or lower when creating the file. If the sound still skips, then reduce the size of the JPEG file.

Viewing a high quality slide show (PhotoTV HD)

If you have a Sony TV that is compatible with “PhotoTV HD,” you can enjoy the best quality images by the following connection and setting.

1 Connect the player to the TV using an HDMI cord (supplied with DVP-NS601HP only).

2 Set the TV’s video setting to “Video-A” mode.

For details about “Video-A,” refer to the operating instructions supplied with the TV.

3 Set “JPEG RESOLUTION” to “PhotoTV HD” in “HDMI SETUP” (page 60).

On “PhotoTV HD”

“PhotoTV HD” allows for highly-detailed pictures, and photo-like expression of subtle textures and colors. By connecting Sony “PhotoTV HD” compatible devices using an HDMI cord, whole new world of photos can be enjoyed in breathtaking Full HD quality. For instance, the delicate texture of the human skin, flowers, sand, and waves can now be displayed on a large screen in beautiful photo-like quality.

Notes

- By connecting to a Sony “PhotoTV HD” compatible device using an HDMI cord, the TV will set the optimal image quality for viewing still picture automatically. For more details, refer to the operation instructions supplied with the TV.
- “PhotoTV HD” is activated when “JPEG RESOLUTION” is set to “PhotoTV HD,” DATA CD /DATA DVD containing MP3 audio tracks/ JPEG image files only is inserted, and the player is connected to a TV by HDMI cord.
- You cannot select “CUSTOM PICTURE MODE” and “SHARPNESS,” when “PhotoTV HD” mode is activated.
- When “PhotoTV HD” mode is activated, the player changes video signal output from “HDMI RESOLUTION” to “1920×1080i,” “TV TYPE” to “16:9,” and “YCbCr/RGB (HDMI)” to “YCbCr” automatically even though the current settings are kept.
- You cannot select “HDMI RESOLUTION” or “YCbCr/RGB (HDMI)” in “HDMI SETUP” (page 60), or “TV TYPE” in “SCREEN SETUP” (page 55), when “PhotoTV HD” mode is activated.
- If you set “PhotoTV HD” mode, the wipe, rotation, zoom, and effect functions are not available.
- When “PhotoTV HD” mode is activated, the selection for “TV TYPE” is skipped during Quick Setup (page 22).

Setting the pace for a slide show (INTERVAL)

You can set the time the slides are displayed on the screen.

- Press **DISPLAY** twice while viewing a JPEG image or when the player is in stop mode.

The Control Menu appears.

- Press **↑/↓** to select  (INTERVAL), then press **ENTER**.

The options for “INTERVAL” appear.

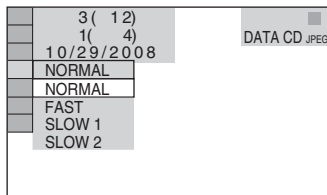

- Press **↑/↓** to select a setting.

The default setting is underlined.

- NORMAL**: sets to standard duration.
- FAST**: sets a duration shorter than NORMAL.
- SLOW 1**: sets a duration longer than NORMAL.
- SLOW 2**: sets a duration longer than SLOW 1.

- Press **ENTER**.

Notes

- Some JPEG files, especially progressive JPEG files or JPEG files of 3,000,000 pixels or more, may take longer to display than others, which may make the duration seem longer than the setting you selected.
- Duration of interval depends on “JPEG RESOLUTION” setting in “HDMI SETUP” (page 60).

Selecting the slides’ appearance (EFFECT)

You can select the way the slides are displayed during a slide show.

- Press **DISPLAY** twice while viewing a JPEG image or when the player is in stop mode.
- Press **↑/↓** to select  (EFFECT), then press **ENTER**.

The options for “EFFECT” appear.

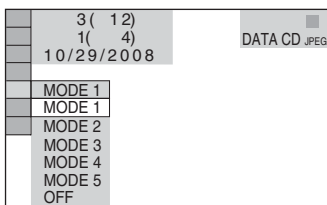

3 Press \uparrow/\downarrow to select a setting.

The default setting is underlined.

- MODE 1: the images randomly cycle through the effects.
- MODE 2: the next image slides over the previous image.
- MODE 3: the image sweeps in from top to bottom.
- MODE 4: the image sweeps in from left to right.
- MODE 5: the image stretches out from the center of the screen.
- OFF: turns off this function.

4 Press ENTER.

Notes

- Note that this setting does not work if the JPEG file has rotation information.
- Depending on the “JPEG RESOLUTION” setting (page 60), some effect may not function.

Settings and Adjustments

Using the Setup Display

By using the Setup Display, you can make various adjustments to items such as picture and sound. You can also set a language for the subtitles and the Setup Display, among other things.

For details on each Setup Display item, see pages from 54 to 61.

Note

Playback settings stored in the disc take priority over the Setup Display settings and not all of the functions described may work.

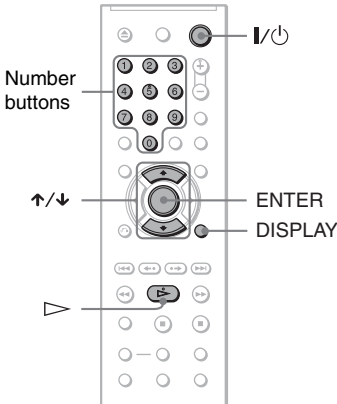

1 Press DISPLAY when the player is in stop mode.

The Control Menu appears.

2 Press ↑/↓ to select (SETUP), then press ENTER.

The options for “SETUP” appear.

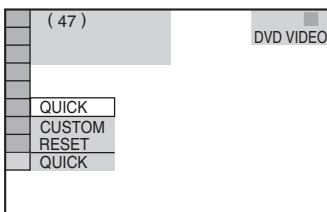

3 Press ↑/↓ to select “CUSTOM,” then press ENTER.

The Setup Display appears.

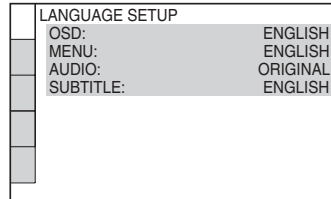

4 Press ↑/↓ to select the setup item from the displayed list: “LANGUAGE SETUP,” “SCREEN SETUP,” “CUSTOM SETUP,” “AUDIO SETUP,” or “HDMI SETUP.” Then press ENTER.

The Setup item is selected.
Example: “SCREEN SETUP”

The Setup item is selected.

Example: “SCREEN SETUP”

Selected item

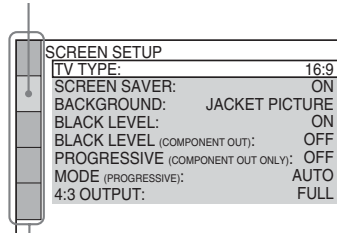

Setup items

5 Press ↑/↓ to select an item, then press ENTER.

The options for the selected item appear.

Example: “TV TYPE”

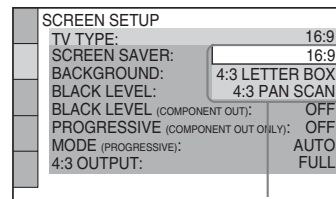

Options

6 Press \uparrow/\downarrow to select a setting, then press ENTER.

The setting is selected and setup is complete.

Example: "4:3 PAN SCAN"

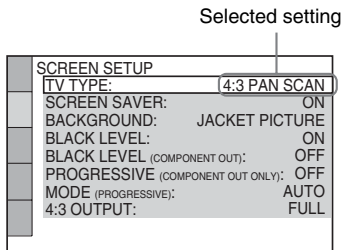

To enter the Quick Setup mode

Select "QUICK" in step 3. Follow from step 5 of the Quick Setup explanation to make basic adjustments (page 22).

To reset all of the "SETUP" settings

- 1 Select "RESET" in step 3 and press ENTER.
- 2 Select "YES" using \uparrow/\downarrow .
You can also quit the process and return to the Control Menu by selecting "NO" here.
- 3 Press ENTER.
All the settings explained on pages 54 to 59 return to the default settings. Do not press I/Power while resetting the player, which takes a few seconds to complete.

Setting the Display or Sound Track Language (LANGUAGE SETUP)

"LANGUAGE SETUP" allows you to set various languages for the on-screen display or sound track.

Select "LANGUAGE SETUP" in the Setup Display. To use the display, see "Using the Setup Display" (page 53).

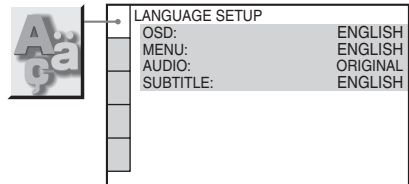

◆ OSD (On-Screen Display)

Switches the display language on the screen.

◆ MENU (DVD VIDEO only)

You can select the desired language for the disc's menu.

◆ AUDIO (DVD VIDEO only)

Switches the language of the sound track. When you select "ORIGINAL," the language given priority in the disc is selected.

◆ SUBTITLE (DVD VIDEO only)

Switches the language of the subtitle recorded on the DVD VIDEO.

When you select "AUDIO FOLLOW," the language for the subtitles changes according to the language you selected for the sound track.

💡 Hint

If you select "OTHERS \rightarrow " in "MENU," "SUBTITLE," or "AUDIO," select and enter a language code from "Language Code List" on page 68 using the number buttons.

Note

If you select a language in "MENU," "SUBTITLE," or "AUDIO" that is not recorded on a DVD VIDEO, one of the recorded languages will be automatically selected.

Settings for the Display

(SCREEN SETUP)

Choose settings according to the TV to be connected.

Select "SCREEN SETUP" in the Setup Display. To use the display, see "Using the Setup Display" (page 53).

The default settings are underlined.

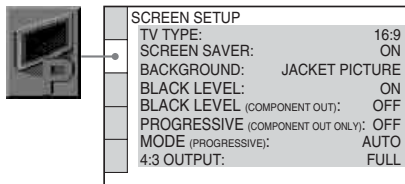

◆ TV TYPE

Selects the aspect ratio of the connected TV (4:3 standard or wide).

You cannot select this when "PhotoTV HD" mode is activated (page 50).

<u>16:9</u>	Select this when you connect a wide-screen TV or a TV with a wide mode function.
4:3 LETTER BOX	Select this when you connect a 4:3 screen TV. Displays a wide picture with bands on the upper and lower portions of the screen.
4:3 PAN SCAN	Select this when you connect a 4:3 screen TV. Automatically displays the wide picture on the entire screen and cuts off the portions that do not fit.

16:9

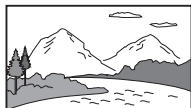

4:3 LETTER BOX



4:3 PAN SCAN

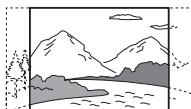

Note

Depending on the DVD, "4:3 LETTER BOX" may be selected automatically instead of "4:3 PAN SCAN" or vice versa.

◆ SCREEN SAVER

The screen saver image appears when you leave the player in pause or stop mode for 15 minutes, or when you play a CD or DATA CD (MP3 audio)/DATA DVD (MP3 audio) for more than 15 minutes. The screen saver will help prevent your display device from becoming damaged (ghosting). Press \triangleright to turn off the screen saver.

<u>ON</u>	Turns on the screen saver.
OFF	Turns off the screen saver.

◆ BACKGROUND

Selects the background color or picture on the TV screen when the player is in stop mode or while playing a CD or DATA CD (MP3 audio)/DATA DVD (MP3 audio).

<u>JACKET PICTURE</u>	The jacket picture (still picture) appears, but only when the jacket picture is already recorded on the disc (CD-EXTRA, etc.). If the disc does not contain a jacket picture, the "GRAPHICS" picture appears.
GRAPHICS	A preset picture stored in the player appears.
BLUE	The background color is blue.
BLACK	The background color is black.

◆ BLACK LEVEL

Selects the black level (setup level) for the video signals output from the jacks other than COMPONENT VIDEO OUT/HDMI OUT.

<u>ON</u>	Sets the black level of the output signal to the standard level.
OFF	Lowers the standard black level. Use this when the picture becomes too white.

◆ BLACK LEVEL (COMPONENT OUT)

Selects the black level (setup level) for the video signals output from the COMPONENT VIDEO OUT jacks. You cannot select this when the player outputs progressive signals (page 15).

<u>OFF</u>	Sets the black level of the output signal to the standard level. Normally, select this position.
ON	Raises the standard black level. Use this setting when the picture appears too dark.

◆ PROGRESSIVE (COMPONENT OUT ONLY)

If your TV accepts progressive (480p) format signals, set "PROGRESSIVE (COMPONENT OUT ONLY)" to "ON". Note that you must connect to a progressive format TV using the COMPONENT VIDEO OUT jacks (page 15).

<u>OFF</u>	To output normal (interlace) signals.
ON	To output progressive signals.

To output progressive signals

- 1 Select "PROGRESSIVE (COMPONENT OUT ONLY)," and press ENTER.
- 2 Select "ON," and press ENTER. The display asks for confirmation.
- 3 Select "Start" and press ENTER. The video switches to a progressive signals for 5 seconds.
- 4 If the picture appears normal, select "YES," and press ENTER. If not, select "NO," and press ENTER.

To reset the setting

If the picture does not appear normal or goes blank, press **I/⏻** to turn off the player, and enter "369" using the number buttons on the remote, then press **I/⏻** to turn on the player again.

◆ MODE (PROGRESSIVE)

In order for these images to appear natural on your screen when output in progressive mode, the progressive video signal needs to be converted to match the type of DVD software that you are watching.

This setting is effective only when you set "PROGRESSIVE (COMPONENT OUT ONLY)" in "SCREEN SETUP" to "ON."

<u>AUTO</u>	Automatically detects the software type (film-based or video-based) and selects the appropriate conversion mode. Normally, select this position.
VIDEO	Fixes the conversion mode to the mode for video-based software.

◆ 4:3 OUTPUT

This setting is effective only when you set "TV TYPE" in "SCREEN SETUP" to "16:9."

Adjust this to watch 4:3 aspect ratio. If you can change the aspect ratio on your TV, change the setting on your TV, not the player.

<u>FULL</u>	Select this when you can change the aspect ratio on your TV.
NORMAL	Select this when you cannot change the aspect ratio on your TV. Shows a 16:9 aspect ratio signal with black bands on left and right sides of the image.

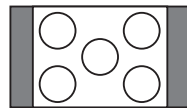

16:9 aspect ratio TV

Custom Settings (CUSTOM SETUP)

Use this to set up playback related and other settings.

Select "CUSTOM SETUP" in the Setup Display. To use the display, see "Using the Setup Display" (page 53).

The default settings are underlined.

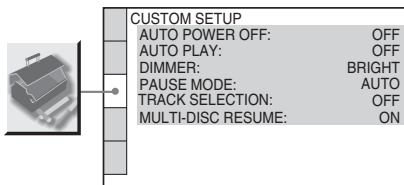

◆ AUTO POWER OFF

Switches the Auto Power Off setting on or off.

<u>OFF</u>	Switches this function off.
ON	The player enters standby mode when left in stop mode for more than 30 minutes.

◆ AUTO PLAY

Switches the Auto Play setting on or off. This function is useful when the player is connected to a timer (not supplied).

<u>OFF</u>	Switches this function off.
ON	Automatically starts playback when the player is turned on by a timer (not supplied).

◆ DIMMER

Adjusts the lighting of the front panel display.

<u>BRIGHT</u>	Makes the lighting bright.
DARK	Makes the lighting dark.
AUTO DARK	Makes the lighting dark if you do not operate the player or remote for a short while.

◆ PAUSE MODE (DVDs only)

Selects the picture in pause mode.

<u>AUTO</u>	The picture, including subjects that move dynamically, is output with no jitter. Normally, select this position.
FRAME	The picture, including subjects that do not move dynamically, is output in high resolution.

◆ TRACK SELECTION (DVD VIDEO only)

Gives the sound track which contains the highest number of channels priority when you play a DVD VIDEO on which multiple audio formats (PCM, DTS, or Dolby Digital format) are recorded.

<u>OFF</u>	No priority given.
AUTO	Priority given.

Notes

- When you set the item to "AUTO," the language may change. The "TRACK SELECTION" setting has higher priority than the "AUDIO" settings in "LANGUAGE SETUP" (page 54).
- If you set "DTS" to "OFF" (page 59), the DTS sound track is not played even if you set "TRACK SELECTION" to "AUTO."
- If PCM, DTS, and Dolby Digital sound tracks have the same number of channels, the player selects PCM, DTS, and Dolby Digital sound tracks in this order.

◆ MULTI-DISC RESUME (DVD VIDEO/VIDEO CD only)

Switches the Multi-disc Resume setting on or off. Resume playback can be stored in memory for up to 6 different DVD VIDEOS/VIDEO CDs (page 26).

<u>ON</u>	Stores the resume setting in memory for up to 6 discs.
OFF	Does not store the resume setting in memory. Playback restarts at the resume point only for the current disc in the player.

Note

If you run Quick Setup, Multi-disc Resume settings stored in memory may return to the default settings.

Settings for the Sound

(AUDIO SETUP)

“AUDIO SETUP” allows you to set the sound according to the playback and connection conditions.

Select “AUDIO SETUP” in the Setup Display. To use the display, see “Using the Setup Display” (page 53). The default settings are underlined.



AUDIO SETUP	
AUDIO DRC:	STANDARD
DOWNMIX:	DOLBY SURROUND
DIGITAL OUT:	ON
DOLBY DIGITAL:	D-PCM
DTS:	OFF
48kHz/96kHz PCM:	48kHz/16bit

◆ AUDIO DRC (Dynamic Range Control) (DVDs only)

Makes the sound clear when the volume is turned down when playing a DVD that conforms to “AUDIO DRC.”

This function affects the output from the following jacks:

- LINE OUT L/R (AUDIO) jacks
- DIGITAL OUT (OPTICAL or COAXIAL)/HDMI OUT jack only when “DOLBY DIGITAL” is set to “D-PCM” (page 59).

<u>STANDARD</u>	Normally, select this position.
TV MODE	Makes low sounds clear even if you turn the volume down.
WIDE RANGE	Gives you the feeling of being at a live performance.

◆ DOWNMIX (DVDs only)

Switches the method for mixing down to 2 channels when you play a DVD which has rear sound elements (channels) or is recorded in Dolby Digital format. For details on the rear signal components, see “Checking the audio signal format” (page 44). This function affects the output of the following jacks:

- LINE OUT L/R (AUDIO) jacks
- DIGITAL OUT (OPTICAL or COAXIAL)/HDMI OUT jack when “DOLBY DIGITAL” is set to “D-PCM” (page 59).

<u>DOLBY SURROUND</u>	Normally, select this position. Multi-channel audio signals are output to 2 channels for enjoying surround sounds.
NORMAL	Multi-channel audio signals are downmixed to 2 channels for use with your stereo.

◆ DIGITAL OUT

Selects if audio signals are output via the DIGITAL OUT (OPTICAL or COAXIAL)/HDMI OUT jack.

<u>ON</u>	Normally, select this position. When you select “ON,” see “Setting the digital output signal” for further settings.
OFF	The influence of the digital circuit upon the analog circuit is minimal. If you are using the HDMI OUT jack, PCM sound will be output depending on the connected equipment. If the signal is encrypted for copyright protection purposes, the signal is only output as 48 kHz/16 bit PCM.

Setting the digital output signal

Switches the method of outputting audio signals when you connect a component such as an audio component or MD deck with a digital input jack.

For connection details, see page 18. Select “DOLBY DIGITAL,” “DTS,” and “48kHz/96kHz PCM” after setting “DIGITAL OUT” to “ON.”

If you connect a component that is incompatible with the selected audio signal, a loud noise (or no sound) may be heard from the speakers, risking damage to your ears or speakers.

Notes

- The AV SYNC function (page 35) is not effective if you use the DIGITAL OUT (OPTICAL or COAXIAL) jack, and set “DOLBY DIGITAL” or “DTS” to “DOLBY DIGITAL” or “ON” respectively.
- The AV SYNC function (page 35) is not effective if you connect a Dolby Digital or DTS-compliant device via the HDMI OUT jack, and set “DOLBY DIGITAL” or “DTS” to “DOLBY DIGITAL” or “ON” respectively.

◆ DOLBY DIGITAL (DVDs only)

Selects the type of Dolby Digital signal.

<u>D-PCM</u>	Select this when the player is connected to an audio component without a built-in Dolby Digital decoder. You can select whether the signals conform to Dolby Surround (Pro Logic) or not by making adjustments to the "DOWNMIX" item in "AUDIO SETUP" (page 58).
DOLBY DIGITAL	Select this when the player is connected to an audio component with a built-in Dolby Digital decoder.

Note

If the HDMI OUT jack is connected to equipment not compatible with DOLBY DIGITAL signals, the "D-PCM" signals will be automatically output even when you select "DOLBY DIGITAL."

◆ DTS

Select the type of DTS audio signals.

<u>OFF</u>	Select this when the player is connected to an audio component without a built-in DTS decoder.
ON	Select this when the player is connected to an audio component with a built-in DTS decoder.

Note

If the HDMI OUT jack is connected to equipment not compatible with DTS signals, the "OFF" signals will be automatically output even when you select "ON."

◆ 48kHz/96kHz PCM (DVD VIDEO only)

Selects the sampling frequency of the audio signal.

<u>48kHz/16bit</u>	The audio signals of DVD VIDEOS are always converted to 48kHz/16bit.
96kHz/24bit	All types of signals including 96kHz/24bit are output in their original format. However, if the signal is encrypted for copyright protection purposes, the signal is only output as 48kHz/16bit.

Notes

- The analog audio signals from the LINE OUT L/R (AUDIO) jacks are not affected by this setting and keep their original sampling frequency level.
- If the HDMI OUT jack is connected to equipment not compatible with 96 kHz/24 bit signals, 48 kHz/16 bit PCM will be automatically output even when you select "96kHz/24bit."

HDMI Settings (HDMI SETUP)

“HDMI SETUP” allows you to adjust items related to the HDMI connection.

Select “HDMI SETUP” in the Setup Display. To use the display, see “Using the Setup Display” (page 53).

The default settings are underlined.

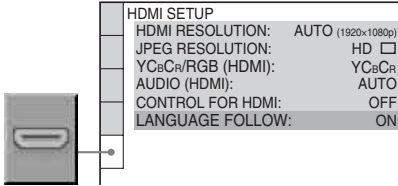

◆ HDMI RESOLUTION

Selects the type of video signals output from the HDMI OUT jack. When you select AUTO (1920×1080p) (default), the player outputs video signals of the highest resolution acceptable for your TV. If the picture is not clear, natural or to your satisfaction, try another option that suits the disc and your TV/projector, etc. For details, refer also to the instruction manual supplied with the TV/projector, etc.

You cannot select this when “PhotoTV HD” mode is activated (page 50).

<u>AUTO</u> (1920×1080p)	Normally, select this.
1920×1080i	Sends 1920×1080i video signals.
1280×720p	Sends 1280×720p video signals.
720×480p	Sends 720×480p video signals.

To reset the setting

If the picture does not appear normal or goes blank, press **I/⏻** to turn off the player, and enter “369” using the number buttons on the remote, then press **I/⏻** to turn on the player again.

Note

In case of “AUTO (1920×1080p),” the player automatically adjusts the video signals that are suitable for the TV.

Other cases, the player directly send the signal even if TV cannot accept.

◆ JPEG RESOLUTION

Selects the type of JPEG resolution so that you can enjoy high picture quality via your HDMI connection.

You cannot select this when “HDMI RESOLUTION” is set to “720×480p” or “TV TYPE” is set to “4:3 LETTER BOX” or “4:3 PAN SCAN”.

PhotoTV HD	Displays extra highly-detailed picture when connecting to a Sony’s “PhotoTV HD”-compatible device
SD <input type="checkbox"/>	Displays standard definition picture with black frame.
<u>HD</u> <input type="checkbox"/>	Displays high definition picture with black frame.
HD	Displays high definition picture without black frame.
(1920×1080i) HD <input type="checkbox"/>	Displays high definition picture with black frame at 1920×1080 pixels.
(1920×1080i) HD	Displays high definition picture without black frame at 1920×1080 pixels.

Notes

- “(1920×1080i) HD ” and “(1920×1080i) HD” are effective only when you set “HDMI RESOLUTION” to “1920×1080i” and “TV TYPE” to “16:9.”
- If you set this setting to “PhotoTV HD,” “(1920×1080i) HD ” or “(1920×1080i) HD,” wipe, rotation, and zoom function are not available.
- If you want to use wipe, rotation, and zoom function; sets this setting to “SD ,” “HD ,” or “HD.”
- If you set this setting to “PhotoTV HD,” “(1920×1080i) HD ” or “(1920×1080i) HD,” next image appears after black mute.
- HDMI signal will stop momentarily during loading or unloading DATA CD or DATA DVD disc.
- When you set to “PhotoTV HD,” the player changes video signal output from “HDMI RESOLUTION” to “1920×1080i,” “TV TYPE” to “16:9,” and “YCbCr/RGB (HDMI)” to “YCbCr” automatically even though the current settings are kept.
- Set this setting to “SD ,” when you want to view JPEG image files in analog video outputs with the HDMI connection.

◆ YCbCr/RGB (HDMI)

Selects the type of HDMI signal output from HDMI OUT jack.

You cannot select this when “PhotoTV HD” mode is activated (page 50).

<u>YCbCr</u>	Outputs YCbCr signals.
RGB	Outputs RGB signals.

Notes

- If the playback picture becomes distorted, set this setting to “RGB.”
- If the HDMI OUT jack is connected to equipment with a DVI jack, “RGB” signals will be automatically output even when you select “YCbCr”.

◆ AUDIO (HDMI)

Selects the type of audio signal output from the HDMI OUT jack.

<u>AUTO</u>	Normally, select this. Outputs audio signals according to the “DIGITAL OUT” settings (page 58).
PCM	Converts Dolby Digital, or 96 kHz/24 bit PCM signals to 48 kHz/16 bit PCM.

Note

A loud noise (or no sound) will be output if you connect the player to a TV that is not compatible with DOLBY DIGITAL/DTS signals and “AUTO” is selected. In this case, select “PCM.”

◆ CONTROL FOR HDMI

Switches the CONTROL FOR HDMI setting on or off.

<u>OFF</u>	Switches this function off.
ON	Allows you to use the CONTROL FOR HDMI features (page 17).

Note

When you change this function from “OFF” to “ON” on a Sony TV that is compatible with the CONTROL FOR HDMI function, all compatible devices will change to “ON” automatically, or vice versa. For more details, refer to the operation instructions supplied with the TV.

◆ LANGUAGE FOLLOW

Switches the languages of the DVD player to the same as the current TV OSD language.

You cannot select this when “CONTROL FOR HDMI ” is set to “OFF.”

<u>ON</u>	Switches this function on.
OFF	Switches this function off.

Notes

- Turn off any display before using this function.
- The OSD language for player keeps if the TV’s language cannot be supported.

Additional Information

Troubleshooting

If you experience any of the following difficulties while using the player, use this troubleshooting guide to help remedy the problem before requesting repairs. Should any problem persist, consult your nearest Sony dealer.

Power

The power is not turned on.

- ➔ Check that the power cord is connected securely.

Picture

There is no picture/picture noise appears.

- ➔ Re-connect the connecting cord securely.
- ➔ The connecting cords are damaged.
- ➔ Check the connection to your TV (page 15) and switch the input selector on your TV so that the signal from the player appears on the TV screen.
- ➔ The disc is dirty or flawed.
- ➔ If the picture output from your player goes through your VCR to get to your TV or if you are connected to a combination TV/VIDEO player, the copy-protection signal applied to some DVD programs could affect picture quality. If you still experience problems even when you connect your player directly to your TV, try connecting your player to your TV's S VIDEO input (page 15).
- ➔ You set the "PROGRESSIVE (COMPONENT OUT ONLY)" in "SCREEN SETUP" to "ON" even though your TV cannot accept the progressive signal. In this case, refer to page 56 to reset the setting.
- ➔ Even if your TV is compatible with progressive format 480p signals and connected using COMPONENT VIDEO OUT jacks, the image may be affected when you set the player to progressive format. In this case, set "PROGRESSIVE (COMPONENT OUT ONLY)" in "SCREEN SETUP" to "OFF" so that the player is set to normal (interlace) format (page 56).

- ➔ The player is connected to an input device that is not HDCP compliant (the HDMI indicator on the front panel does not light up). See page 16.
- ➔ If the HDMI OUT jack is used for video output, changing the "HDMI RESOLUTION" setting in "HDMI SETUP" may solve the problem (page 60). Connect the TV and the player using a video jack other than the HDMI OUT, and switch the TV's input to the connected video input so that you can see the on-screen displays. Change the "HDMI RESOLUTION" setting in "HDMI SETUP," and switch the TV's input back to HDMI. If the picture still does not appear, repeat the steps and try other options.
- ➔ Press **I/⏻** to turn off the player, and enter "369" using the number buttons on the remote, then press **I/⏻** to turn on the player again (page 60).

There is no picture or the picture noise appears when connected to the HDMI OUT jack.

- ➔ Try the following: ① Turn the player off and on again. ② Turn the connected equipment off and on again. ③ Disconnect and then connect the HDMI cord again.

The picture does not fill the screen, even though the aspect ratio is set in "TV TYPE" under "SCREEN SETUP."

- ➔ The aspect ratio of the disc is fixed on your DVD.

Sound

There is no sound.

- ➔ Re-connect the connecting cord securely.
- ➔ The connecting cord is damaged.
- ➔ The player is connected to the wrong input jack on the audio component (page 18).
- ➔ The audio component input is not correctly set.
- ➔ The player is in pause mode or in Slow-motion Play mode.
- ➔ The player is in fast forward or fast reverse mode.
- ➔ If the audio signal does not come through the DIGITAL OUT (OPTICAL or COAXIAL)/HDMI OUT jack, check the audio settings (page 58).

- ➔ While playing a Super VCD on which the audio track 2 is not recorded, no sound will come out when you select “2:STEREO,” “2:1/L,” or “2:2/R.”
- ➔ The equipment connected to the HDMI OUT jack does not conform to the audio signal format, in this case set “AUDIO(HDMI)” in “HDMI SETUP” to “PCM” (page 61).

No sound is output from the HDMI OUT jack

- ➔ Try the following: ①Turn the player off and on again. ②Turn the connected equipment off and on again. ③Disconnect and then connect the HDMI cord again.
- ➔ The HDMI OUT jack is connected to a DVI device (DVI jacks do not accept audio signals).

The sound volume is low.

- ➔ The sound volume is low on some DVDs. The sound volume may improve if you set “AUDIO DRC” in “AUDIO SETUP” to “TV MODE” (page 58).

Operation

The remote does not function.

- ➔ The batteries in the remote are weak.
- ➔ There are obstacles between the remote and the player.
- ➔ The distance between the remote and the player is too far.
- ➔ The remote is not pointed at the remote sensor on the player.

The disc does not play.

- ➔ The disc is turned over.
- ➔ Insert the disc with the playback side facing down.
- ➔ The disc is skewed.
- ➔ The player cannot play certain discs (page 6).
- ➔ The region code on the DVD does not match the player.
- ➔ Moisture has condensed inside the player (page 3).
- ➔ The player cannot play a recorded disc that is not correctly finalized (page 7).

The MP3 audio track cannot be played (page 46).

- ➔ The DATA CD is not recorded in MP3 format that conforms to ISO 9660 Level 1/ Level 2 or Joliet.
- ➔ The DATA DVD is not recorded in MP3 format that conforms to UDF (Universal Disk Format).
- ➔ The MP3 audio track does not have the extension “.MP3.”
- ➔ The data is not formatted in MP3 even though it has the extension “.MP3.”
- ➔ The data is not MPEG-1 Audio Layer III data.
- ➔ The player cannot play audio tracks in mp3PRO format.
- ➔ “MODE (MP3, JPEG)” is set to “IMAGE (JPEG)” (page 50).

The JPEG image file cannot be played (page 46).

- ➔ The DATA CD is not recorded in JPEG format that conforms to ISO 9660 Level 1/ Level 2, or Joliet.
- ➔ The DATA DVD is not recorded in JPEG format that conforms to UDF (Universal Disk Format).
- ➔ The file has an extension other than “.JPEG” or “.JPG.”
- ➔ The image is larger than 3072 (width) × 2048 (height) in normal mode, or more than 3,300,000 pixels in progressive JPEG. (Some progressive JPEG files cannot be displayed even if the file size is within this specified capacity.)
- ➔ The image does not fit the screen (the image is reduced).
- ➔ “MODE (MP3, JPEG)” is set to “AUDIO (MP3)” (page 50).

The MP3 audio tracks and JPEG image files start playing simultaneously.

- ➔ “MODE (MP3, JPEG)” is set to “AUTO” (page 50).

The player’s internal background sound and JPEG image files start playing simultaneously.

- ➔ “MODE (MP3, JPEG)” is set to “AUTO (BGM)” (page 50).

The album/track/file names are not displayed correctly.

- ➔ The player can only display numbers and alphabet. Other characters are displayed as “*”.

The disc does not start playing from the beginning.

- ➔ Program Play, Shuffle Play, Repeat Play, or A-B Repeat Play is selected (page 29).
- ➔ Resume play has taken effect (page 26).

The player starts playing the disc automatically.

- ➔ The disc features an auto playback function.
- ➔ “AUTO PLAY” in “CUSTOM SETUP” is set to “ON” (page 57).

“Copyright lock” appears and the screen turns blue when playing in DVD-VR mode.

- ➔ Images taken from digital broadcasts, etc., may contain copy protection signals, such as complete copy protection signals, single copy signals, and restriction-free signals. When images that contain copy protection signals are played, a blue screen may appear instead of the images. It may take a while when looking for playable images. (For player that cannot play images that contain a copy protection only)

Playback stops automatically.

- ➔ While playing discs with an auto pause signal, the player stops playback at the auto pause signal.

Some functions such as Stop, Fast Play, Slow Play, Slow-motion Play, Repeat Play, Shuffle Play or Program Play cannot be performed.

- ➔ Depending on the disc, you may not be able to do some of the operations above. Refer to the operating manual that comes with the disc.

The language for the sound track cannot be changed.

- ➔ Try using the DVD’s menu instead of the direct selection button on the remote (page 26).
- ➔ Multilingual tracks are not recorded on the DVD being played.
- ➔ The DVD prohibits the changing of the language for the sound track.

The subtitle language cannot be changed or turned off.

- ➔ Try using the DVD’s menu instead of the direct selection button on the remote (page 26).
- ➔ Multilingual subtitles are not recorded on the DVD being played.
- ➔ The DVD prohibits the changing of subtitles.

The angles cannot be changed.

- ➔ Try using the DVD’s menu instead of the direct selection button on the remote (page 26).
- ➔ Multi-angles are not recorded on the DVD being played.
- ➔ The angle can only be changed when the “” indicator lights up on the front panel display (page 9).
- ➔ The DVD prohibits changing of the angles.

The player does not operate properly.

- ➔ When static electricity, etc., causes the player to operate abnormally, unplug the player.

5 numbers or letters are displayed on the screen and on the front panel display.

- ➔ The self-diagnosis function was activated. (See the table on page 66.)

The disc tray does not open and “LOCKED” appears on the front panel display.

- ➔ Child Lock is set (page 26).

The disc tray does not open and “TRAY LOCKED” appears on the front panel display.

- ➔ Contact your Sony dealer or local authorized Sony service facility.

“Data error” appears on the TV screen when playing a DATA CD/DATA DVD.

- ➔ The MP3 audio track/JPEG image file you want to play is broken.
- ➔ The data is not MPEG-1 Audio Layer III data.
- ➔ The JPEG image file format does not conform to DCF (page 46).
- ➔ The JPEG image file has the extension “.JPG” or “.JPEG,” but is not in JPEG format.

The CONTROL FOR HDMI function does not work.

- ➔ When HDMI indicator does not light up on the front panel, check the HDMI connection (page 15).
- ➔ Set the “CONTROL FOR HDMI” setting in “HDMI SETUP” to “ON” (page 61).
- ➔ Make sure that the connected component is compatible with the CONTROL FOR HDMI function. Please refer to the operating instructions of the component for detailed explanation.
- ➔ If you change the HDMI connection, connect and disconnect the AC power cord, or if a power failure occurs, turn on all components connected to HDMI, and set “CONTROL FOR HDMI” setting in “HDMI SETUP” to “OFF,” then set the “CONTROL FOR HDMI” setting in “HDMI SETUP” to “ON” (page 61).

‘BRAVIA Sync’ display does not appear.

- ➔ Turn off any display of the DVD player displays. Then, try again.
- ➔ Please return to the one screen mode if your TV is in two screen mode. Then, try again.

Display language on the screen switches automatically.

- ➔ When “LANGUAGE FOLLOW” is set to “ON” in the “HDMI SETUP” (page 61), the display language on the screen automatically switches, according to the language setting of the connected TV, if you change the language settings on your TV, etc.

The DVD player turns on automatically.

- ➔ HDMI input is selected using TV Interface. Some TV has this function for CONTROL FOR HDMI.
- ➔ “CONTROL FOR HDMI” in “HDMI SETUP” is set to “ON” (page 61).

Self-diagnosis Function

(When letters/numbers appear in the display)

When the self-diagnosis function is activated to prevent the player from malfunctioning, a five-character service number (e.g., C 13 50) with a combination of a letter and four digits appears on the screen and the front panel display. In this case, check the following table.

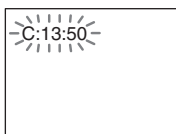

First three characters of the service number	Cause and/or corrective action
C 13	The disc is dirty or recorded in a format that this player cannot play (page 6). ➔ Clean the disc with a cleaning cloth or check its format.
C 31	The disc is not inserted correctly. ➔ Re-insert the disc correctly.
E XX (xx is a number)	To prevent a malfunction, the player has performed the self-diagnosis function. ➔ Contact your nearest Sony dealer or local authorized Sony service facility and give the 5-character service number. Example: E 61 10

Specifications

System

Laser: Semiconductor laser

Outputs

(**Jack name:** Jack type/Output level/Load impedance)

LINE OUT (AUDIO):

Phono jack/2 Vrms/10 kilohms

DIGITAL OUT (OPTICAL):

Optical output jack/-18 dBm (wave length 660 nm)

DIGITAL OUT (COAXIAL):

Phono jack/0.5 Vp-p/75 ohms

HDMI OUT:

HDMI 19 pin-Standard Connector

COMPONENT VIDEO OUT (Y, P_B, P_R):

Phono jack/Y: 1.0 Vp-p/P_B, P_R:
interlace*¹ = 0.648 Vp-p,
progressive or interlace*² = 0.7 Vp-p/75
ohms

*¹ BLACK LEVEL (COMPONENT OUT) is ON

*² BLACK LEVEL (COMPONENT OUT) is OFF

LINE OUT (VIDEO):

Phono jack/1.0 Vp-p/75 ohms

S VIDEO OUT:

4-pin mini DIN/
Y: 1.0 Vp-p, C: 0.286 Vp-p/75 ohms

General

Power requirements:

U.S. models: 120 V AC, 60 Hz

Models for other areas: 110 -240 V AC,
50/60 Hz

See page 3 for further information.

Power consumption: 11 W

Dimensions (approx.):

430 × 43 × 207.2 mm (17 × 1¹¹/₁₆ × 8¹/₇
in.) (width/height/depth) incl. projecting
parts

Mass (approx.): 1.7 kg (3³/₄ lb)

Operating temperature: 5 °C to 35 °C

Operating humidity: 25 % to 80 %

Supplied accessories

See page 14.

Specifications and design are subject to
change without notice.

Language Code List

For details, see pages 43, 54.

The language spellings conform to the ISO 639: 1988 (E/F) standard.

Code Language	Code Language	Code Language	Code Language
1027 Afar	1183 Irish	1347 Maori	1507 Samoan
1028 Abkhazian	1186 Scots Gaelic	1349 Macedonian	1508 Shona
1032 Afrikaans	1194 Galician	1350 Malayalam	1509 Somali
1039 Amharic	1196 Guarani	1352 Mongolian	1511 Albanian
1044 Arabic	1203 Gujarati	1353 Moldavian	1512 Serbian
1045 Assamese	1209 Hausa	1356 Marathi	1513 Siswati
1051 Aymara	1217 Hindi	1357 Malay	1514 Sesotho
1052 Azerbaijani	1226 Croatian	1358 Maltese	1515 Sundanese
1053 Bashkir	1229 Hungarian	1363 Burmese	1516 Swedish
1057 Byelorussian	1233 Armenian	1365 Nauru	1517 Swahili
1059 Bulgarian	1235 Interlingua	1369 Nepali	1521 Tamil
1060 Bihari	1239 Interlingue	1376 Dutch	1525 Telugu
1061 Bislama	1245 Inupiak	1379 Norwegian	1527 Tajik
1066 Bengali;	1248 Indonesian	1393 Occitan	1528 Thai
Bangla	1253 Icelandic	1403 (Afan)Oromo	1529 Tigrinya
1067 Tibetan	1254 Italian	1408 Oriya	1531 Turkmen
1070 Breton	1257 Hebrew	1417 Punjabi	1532 Tagalog
1079 Catalan	1261 Japanese	1428 Polish	1534 Setswana
1093 Corsican	1269 Yiddish	1435 Pashto;	1535 Tonga
1097 Czech	1283 Javanese	Pushto	1538 Turkish
1103 Welsh	1287 Georgian	1436 Portuguese	1539 Tsonga
1105 Danish	1297 Kazakh	1463 Quechua	1540 Tatar
1109 German	1298 Greenlandic	1481 Rhaeto-	1543 Twi
1130 Bhutani	1299 Cambodian	Romance	1557 Ukrainian
1142 Greek	1300 Kannada	1482 Kirundi	1564 Urdu
1144 English	1301 Korean	1483 Romanian	1572 Uzbek
1145 Esperanto	1305 Kashmiri	1489 Russian	1581 Vietnamese
1149 Spanish	1307 Kurdish	1491 Kinyarwanda	1587 Volapük
1150 Estonian	1311 Kirghiz	1495 Sanskrit	1613 Wolof
1151 Basque	1313 Latin	1498 Sindhi	1632 Xhosa
1157 Persian	1326 Lingala	1501 Sangho	1665 Yoruba
1165 Finnish	1327 Laothian	1502 Serbo-	1684 Chinese
1166 Fiji	1332 Lithuanian	Croatian	1697 Zulu
1171 Faroese	1334 Latvian;	1503 Singhalese	
1174 French	Lettish	1505 Slovak	
1181 Frisian	1345 Malagasy	1506 Slovenian	1703 Not specified

Parental Control Area Code List

For details, see page 37.

Code Area	Code Area	Code Area	Code Area
2044 Argentina	2165 Finland	2362 Mexico	2149 Spain
2047 Australia	2174 France	2376 Netherlands	2499 Sweden
2046 Austria	2109 Germany	2390 New Zealand	2086 Switzerland
2057 Belgium	2248 India	2379 Norway	2528 Thailand
2070 Brazil	2238 Indonesia	2427 Pakistan	2184 United Kingdom
2079 Canada	2254 Italy	2424 Philippines	
2090 Chile	2276 Japan	2436 Portugal	
2092 China	2304 Korea	2489 Russia	
2115 Denmark	2363 Malaysia	2501 Singapore	

Index

Numerics

- 16:9 55
- 4:3 LETTER BOX 55
- 4:3 OUTPUT 56
- 4:3 PAN SCAN 55
- 48kHz/96kHz PCM 59
- 5.1 Channel Surround 19

A

- A-B REPEAT 32
- ADVANCE 25
- ALBUM 40
 - Album 46
- ANGLE 25
- AUDIO 43, 54
- AUDIO DRC 58
- AUDIO SETUP 58
- AUTO (BGM) 29, 43, 50
- AUTO PLAY 57
- AUTO POWER OFF 57
- AV SYNC 35

B

- BACKGROUND 55
- Batteries 20
- BLACK LEVEL 55
- BLACK LEVEL (COMPONENT OUT) 56
- 'BRAVIA Sync' 17

C

- CD 6, 24
- CHAPTER 40
- CHAPTER VIEWER 41
- Checking the audio signal
 - format 44
- Child Lock 26
- Connecting 15
- Continuous play
 - CD/VIDEO CD 24
 - DVD 24
- Control Menu 11
- CUSTOM 53
- CUSTOM PARENTAL CONTROL 36
- CUSTOM PICTURE MODE 33
- CUSTOM SETUP 57

D

- DATA CD 5, 46
- DATA DVD 5, 46
- DATE 49
- DIGITAL OUT 58
- Digital output 58
- DIMMER 57
- Display
 - Control Menu Display 11

- Front panel display 9
 - Setup Display 53
- DOLBY DIGITAL 43, 59
- DOWNMIX 58
- DTS 43, 59
- DVD 5, 24
- DVD+RW 5
- DVD-RW 5

E

- EFFECT 51

F

- Fast forward 39
- FAST PLAY 25
- Fast reverse 39
- FILE 40
- Film based software 56
- Freeze Frame 39
- Front panel display 9

H

- Handling discs 2
- HDMI
 - AUDIO (HDMI) 61
 - CONTROL FOR HDMI 17, 61
 - HDMI RESOLUTION 60
 - LANGUAGE FOLLOW 61
- HDMI SETUP 60
- Hooking up 14

I

- ID3 Tag 28
- INDEX 40
- INTERVAL 51

J

- JPEG 5, 46
- JPEG RESOLUTION 60

L

- LANGUAGE SETUP 54
- Locating
 - a specific point by watching the TV screen 39

M

- MEMORY 33
- MENU 54
- MODE (MP3, JPEG) 50
- MODE (PROGRESSIVE) 56
- MP3 5, 46
- MULTI-DISC RESUME 26, 57

N

- Normal (Interlace) format 56

O

- On-screen display
 - Control Menu Display 11
 - Setup Display 53
- ORIGINAL 26
- ORIGINAL/PLAY LIST 27
- OSD 54

P

- PARENTAL CONTROL 36
- PAUSE MODE 57
- PBC Playback 27
- PhotoTV HD 50, 60
- PICTURE NAVIGATION 41, 48
- PLAY LIST 26
- PROGRAM 29
- Program Play 29
- PROGRESSIVE (COMPONENT OUT ONLY) 56
- Progressive format 56

Q

- QUICK 54
- Quick Setup 22, 54

R

- Remote 10, 20, 21
- REPEAT 31
- Repeat Play 31
- REPLAY 25
- RESET 54

S

- Scan 39
- SCENE 40
- SCREEN SAVER 55
- SCREEN SETUP 55
- Searching 39
- SETUP 53
- Setup Display 53
- SHARPNESS 34
- SHUFFLE 31
- Shuffle Play 31
- Slide Show 49
- SLOW PLAY 25
- Slow-motion Play 39
- Speakers
 - Hooking up 18
- SUBTITLE 25, 49, 54
- Surround 45

T

- TIME/TEXT 27
- TITLE 40
- TITLE VIEWER 41
- TRACK 40

Track 9
TRACK SELECTION 57
TRACK VIEWER 41
Troubleshooting 62
TV TYPE 55
TVS (TV Virtual Surround) 45

U

Usable discs 6

V

Video based software 56
VIDEO CD 5, 24

Z

ZOOM 25, 49

Tabla de contenido

Conexiones	2
Conexión del reproductor.	2
Paso 1: Desembalaje.	2
Paso 2: Conexión de los cables del video/HDMI (interfaz multimedia de alta definición).	3
Acerca de las funciones CONTROL PARA HDMI para 'BRAVIA Sync' (sólo para conexiones HDMI)	5
Paso 3: Conexión de los cables de audio	6
Paso 4: Conexión del cable de alimentación.	8
Paso 5: Preparación del control remoto.	8
Control del televisor mediante el control remoto	9
Paso 6: Ajuste rápido.	10

Reproducción	12
Reproducción de discos.	12

ES

Conexión del reproductor

Siga los pasos 1 a 6 para conectar el reproductor y ajustar sus valores.

Notas

- Enchufe los cables firmemente para evitar ruidos no deseados.
- Consulte el manual de instrucciones suministrado con los componentes que va a conectar.
- No es posible conectar este reproductor a un televisor que no tenga una toma de entrada de video.
- Asegúrese de desconectar el cable de corriente de cada componente antes de realizar las conexiones.

Paso 1: Desembalaje

Compruebe que tiene los siguientes elementos:

- Cable de audio/video (clavija fonográfica × 3 ↔ clavija fonográfica × 3) (1)
 - Control remoto (1)
 - Pilas R6 (tamaño AA) (2)
 - Cable de conexión HDMI (1) (suministrado solamente con DVP-NS601HP)
- Algunos modelos incluyen un adaptador de enchufe

Paso 2: Conexión de los cables del video/HDMI (interfaz multimedia de alta definición)

Mediante un cable de vídeo, conecte el reproductor al monitor, proyector o componente de audio, como un amplificador de AV (receptor). Seleccione uno de los patrones **A** a **D** según la toma de entrada del monitor del televisor, del proyector o del componente de audio.

Para visualizar imágenes de señal progresiva (480 p) con un televisor, un proyector o un monitor compatible, debe utilizar el patrón **C**. Seleccione el patrón **D** al conectar a un televisor, un proyector o un componente de audio equipado con entrada HDMI (interfaz multimedia de alta definición).

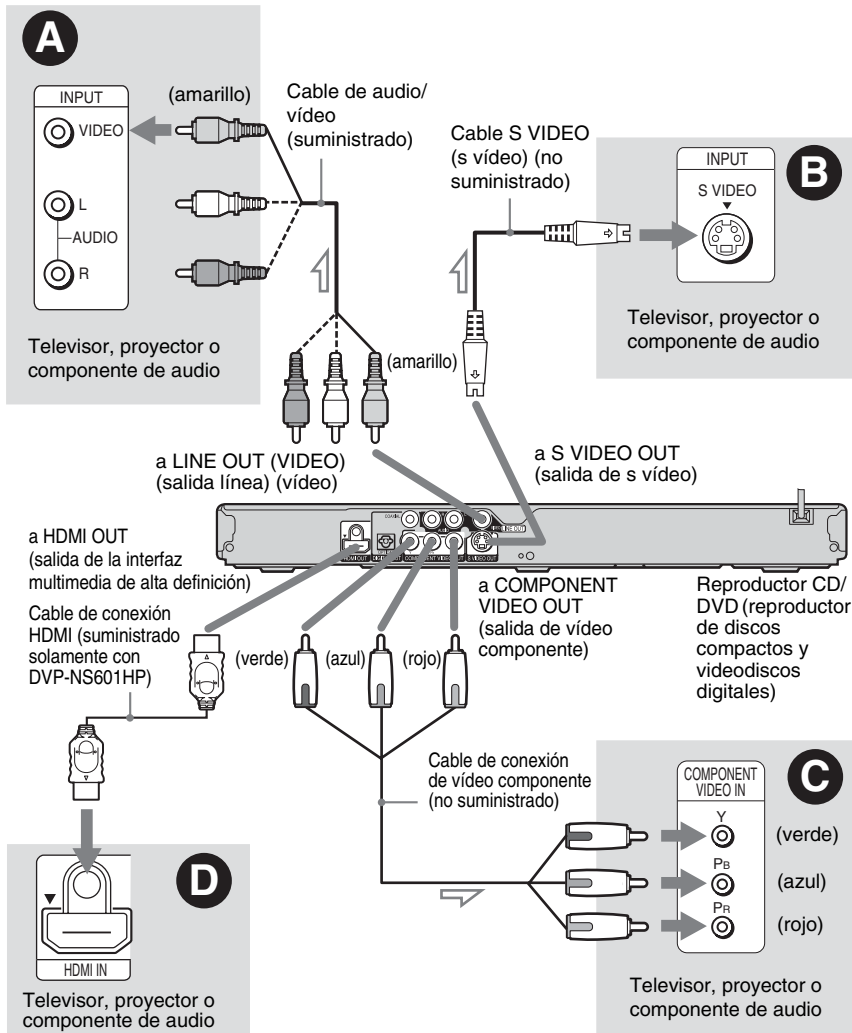

⇒ : flujo de señal

A Toma de entrada de vídeo

Disfrutará de imágenes de calidad estándar.

B Toma de entrada S VIDEO (s vídeo)

Disfrutará de imágenes de alta calidad.

C Tomas de entrada de vídeo componente (Y, P_B, P_R)

Este tipo de conexiones proporciona imágenes de alta calidad con una reproducción fiel de los colores.

Si el televisor admite señales de formato progresivo de 480 p, ajuste la opción "PROGRESSIVE (COMPONENT OUT ONLY)" (progresivo sólo salida componente) del "SCREEN SETUP" en "ON" para emitir señales progresivas (página 70).

D Toma de entrada HDMI/DVI (interfaz multimedia de alta definición/interfaz visual digital)

Utilice un cable Sony HDMI certificado (suministrado solamente con DVP-NS601HP) para disfrutar de una imagen y un sonido digitales de alta calidad a través de la toma HDMI OUT (salida de la interfaz multimedia de alta definición).

Cuando se conecte a un televisor Sony que sea compatible con la función CONTROL PARA HDMI, consulte la página 5.

Al realizar la conexión a la toma HDMI OUT (salida de la interfaz multimedia de alta definición)

Realice los pasos siguientes. Una manipulación incorrecta podría dañar la toma HDMI OUT y el conector.

- 1 **Alinee con cuidado la toma HDMI OUT de la parte posterior del reproductor y el conector HDMI mediante la comprobación de su forma.**

Asegúrese de que el conector no esté al revés ni inclinado.

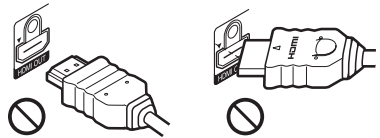

La conector está al revés

No está recta

2 Inserte el conector HDMI directamente en la toma HDMI OUT.

No doble ni fuerce el conector HDMI (interfaz multimedia de alta definición).

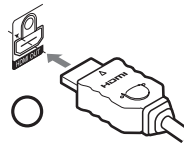

Para conectarlo a un televisor con entrada DVI (interfaz visual digital)

Utilice un cable adaptador HDMI-DVI (no suministrado). La toma DVI (interfaz visual digital) no admitirá señales de audio, por lo que deberá usar otra conexión de audio además de esta conexión (página 6). Además, no es posible conectar la toma HDMI OUT (salida de la interfaz multimedia de alta definición) a las tomas DVI (interfaz visual digital) no compatibles con HDCP (Protección de contenido digital de alto ancho de banda) (por ejemplo, tomas DVI (interfaz visual digital) en pantallas de PC (computadora personal)).

Si lo conecta a un televisor de pantalla 4:3 estándar

Según el disco, es posible que la imagen no quepa en la pantalla del televisor. Para cambiar la relación de aspecto, consulte la página 68.

Notas

- No conecte una videograbadora, etc., entre el televisor y el reproductor. Si pasa las señales del reproductor a través de la videograbadora, es posible que no reciba una imagen clara en la pantalla del televisor. Si el televisor sólo tiene una toma de entrada de audio/vídeo, conecte el reproductor a esta toma.

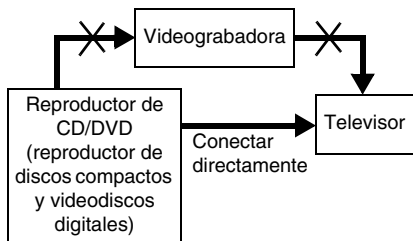

- Si la imagen aparece demasiado blanca cuando utiliza las conexiones **A** o **B**, ajuste la opción "BLACK LEVEL" de "SCREEN SETUP" en "OFF" (página 69).
- Asegúrese de desconectar el cable HDMI cuando mueva el reproductor.
- Si coloca el reproductor en un armario con el cable HDMI conectado, no ejerza presión excesiva en la pared del armario. Podría dañar el cable HDMI o la toma HDMI OUT.
- Cuando conecte o desconecte la unidad, no enrosque ni gire el conector HDMI.

Acerca de las funciones CONTROL PARA HDMI para 'BRAVIA Sync' (sólo para conexiones HDMI)

Si conecta los componentes Sony compatibles con la función CONTROL PARA HDMI con un cable HDMI (suministrado solamente con DVP-NS601HP), podrá disfrutar de las siguientes funciones:

- Reproducción mediante una pulsación (página 13)
- Desconexión del sistema
Cuando apague el televisor mediante el botón **I/⏻** del control remoto del televisor, los componentes compatibles con la función CONTROL PARA HDMI se apagarán automáticamente.

Preparación para las funciones de 'BRAVIA Sync'

Ajuste "CONTROL FOR HDMI" en "ON" en el "HDMI SETUP" (página 76). Para obtener más información acerca de la configuración del televisor, consulte el manual de instrucciones suministrado con el mismo.

Nota

En función del componente conectado, es posible que la función CONTROL PARA HDMI no funcione. Consulte el manual de instrucciones suministrado con el componente.

Paso 3: Conexión de los cables de audio

Seleccione uno de los siguientes patrones, **A** o **B**, según la toma de entrada del monitor del televisor, del proyector o del componente de audio, como un amplificador de AV (receptor). De este modo podrá escuchar el sonido.

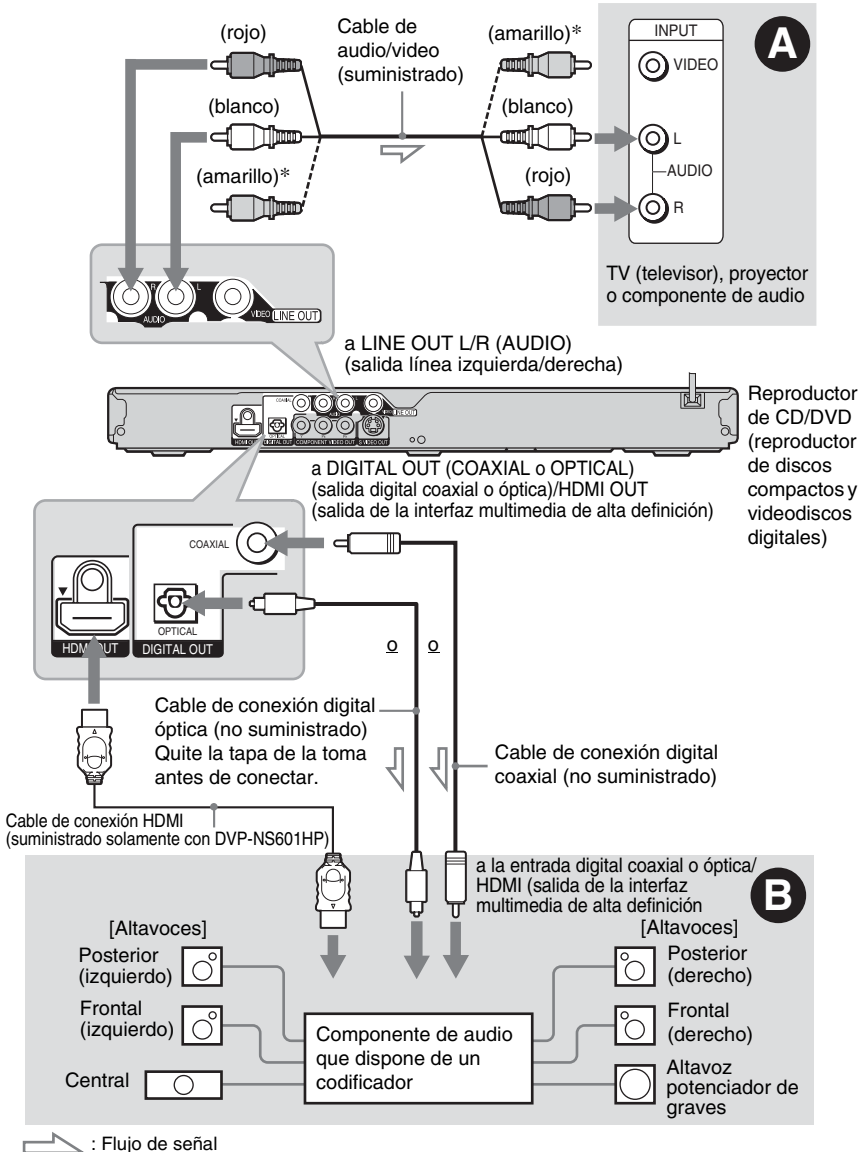

* La clavija amarilla se utiliza para señales de vídeo (página 3).

⚙ Sugerencia

Para la colocación correcta de los altavoces, consulte el manual de instrucciones suministrado con los componentes conectados.

A Tomas de entrada de audio I/D

Esta conexión utilizará los dos altavoces del televisor o del componente de audio para el sonido.

B Tomas de entrada de audio digital

Si el componente de audio dispone de decodificador Dolby*¹ Digital o DTS*² y una toma de entrada digital, utilice esta conexión. Podrá disfrutar de los efectos de sonido envolvente de Dolby Digital (5.1ch) y DTS (5.1ch).

Si se conecta a un componente de audio de Sony que sea compatible con la función CONTROL PARA HDMI, consulte el manual de instrucciones suministrado con el mismo.

*¹ Fabricado bajo licencia de Dolby Laboratories. Dolby, Pro Logic y el símbolo de la doble D son marcas comerciales de Dolby Laboratories.

*² Fabricado bajo licencia según Patente de los EE.UU. N° 5.451.942 y otras patentes emitidas y pendientes en los EE.UU. y el resto del mundo. DTS y DTS Digital Out son marcas registradas, y los logos y símbolo de DTS son marcas comerciales de DTS, Inc. © 1996- 2007 DTS, Inc. Reservados todos los derechos.

Notas

- Después de establecer la conexión, asegúrese de ajustar “DOLBY DIGITAL” en “DOLBY DIGITAL” y “DTS (sistema digital de sala de cine)” en “ON” en Ajuste rápido (página 10).
- Al conectar un componente de audio que admita la frecuencia de muestreo de 96 kHz, ajuste “48kHz/96kHz PCM” de “AUDIO SETUP” en “96kHz/24bits” (página 74).
- Los efectos TVS (sonido envolvente virtual de televisor) de este reproductor no son compatibles con esta conexión.
- Cuando conecte el reproductor a un componente de audio mediante un cable HDMI (interfaz multimedia de alta definición), tendrá que realizar alguno de los pasos siguientes:
 - Conecte el componente de audio al televisor con el cable HDMI (interfaz multimedia de alta definición).
 - Conecte el reproductor al televisor con un cable de video que no sea el cable HDMI (interfaz multimedia de alta definición) (cable de video componente, cable de S video o cable de audio/video).
- Al realizar la conexión a la toma HDMI OUT (salida de la interfaz multimedia de alta definición), haga coincidir el conector HDMI (interfaz multimedia de alta definición) con la toma. No doble y fuerce el cable HDMI (interfaz multimedia de alta definición).

Paso 4: Conexión del cable de alimentación

Conecte los cables de alimentación del reproductor y del televisor a una toma de ca.

Paso 5: Preparación del control remoto

Se puede controlar el reproductor con el control remoto suministrado. Inserte dos pilas R6 (tamaño AA) de forma que coincidan sus extremos \oplus y \ominus con las marcas del interior del compartimiento. Al utilizar el control remoto, oriéntelo hacia el sensor remoto  del reproductor.

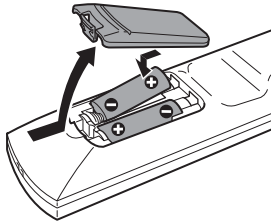

Notas

- No deje el control remoto en lugares extremadamente cálidos o húmedos.
- No permita que caigan objetos extraños sobre el control remoto, especialmente cuando sustituya las pilas.
- No exponga el sensor del control remoto a la luz directa del sol ni a dispositivos de iluminación. Si lo hace, pueden producirse fallas en el funcionamiento.
- Cuando no vaya a usar el control remoto durante un tiempo prolongado, extraiga las pilas para evitar posibles daños por fugas y corrosión.

Control del televisor mediante el control remoto

Puede controlar el nivel del sonido, la fuente de entrada y el interruptor de alimentación del televisor Sony con el control remoto suministrado.

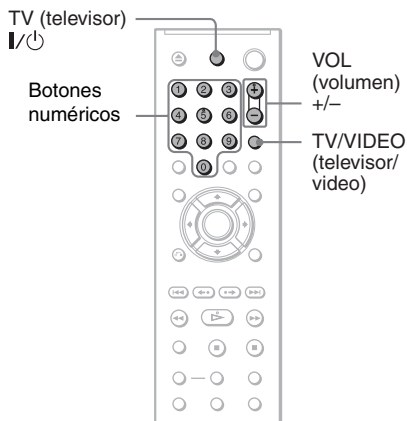

Puede controlar el televisor mediante los botones que se indican a continuación.

Presionando	Puede
TV (televisor) 	Encender o apagar el televisor
VOL (volumen) +/-	Ajustar el volumen del televisor
TV/VIDEO (televisor/video)	Cambiar la fuente de entrada del televisor entre éste y otras fuentes de entrada

Nota

Según la unidad conectada, podrá controlar el televisor utilizando algunos o todos los botones del control remoto suministrado.

Paso 6: Ajuste rápido

Siga los pasos siguientes para realizar el mínimo de ajustes básicos para utilizar el reproductor. Para saltar un ajuste, presione ►►. Para volver al ajuste anterior, presione ◀◀.

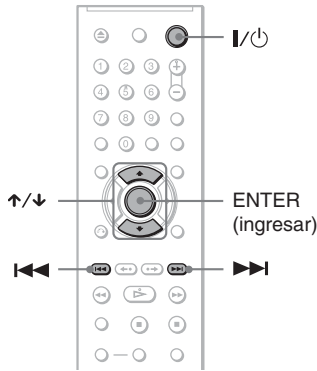

- 1 Encienda el televisor.**
- 2 Presione I/⏻.**
- 3 Cambie el selector de entrada del televisor para que la señal del reproductor aparezca en la pantalla del televisor.**

En la parte inferior de la pantalla, aparecerá "Press [ENTER] to run QUICK SETUP". Si este mensaje no aparece, seleccione "QUICK" en "SETUP" del menú de control para ejecutar el ajuste rápido (página 67).

- 4 Presione ENTER (ingresar) sin insertar ningún disco.**

Aparece la pantalla de ajustes que le permitirá seleccionar el idioma utilizado en la pantalla.

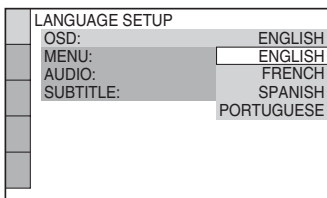

- 5 Presione ↑/↓ para seleccionar un idioma.**

El reproductor muestra el menú y los subtítulos en el idioma seleccionado.

- 6 Presione ENTER (ingresar).**

Aparece la pantalla de ajustes que le permitirá seleccionar la relación de aspecto del televisor que vaya a conectar.

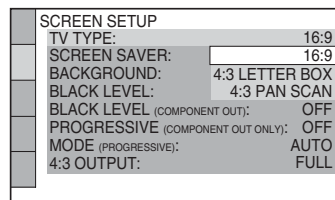

- 7 Presione ↑/↓ para seleccionar el ajuste que coincida con el tipo de televisor.**

◆ Si tiene un televisor con pantalla panorámica o uno 4:3 estándar con el modo de pantalla panorámica

- 16:9 (página 68)

◆ Si tiene un televisor 4:3 estándar

- 4:3 LETTER BOX (tipo buzón) o 4:3 PAN SCAN (exploración PAN) (página 68)

8 Presione ENTER (ingresar).

Aparece la pantalla de ajustes que le permitirá seleccionar el tipo de toma utilizada para conectar su componente de audio, tal como un amplificador (receptor).

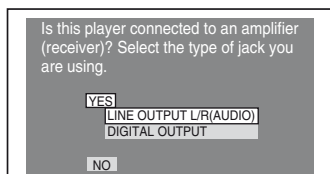

9 Presione ↑/↓ para seleccionar (si existe) el tipo de toma que utilice para conectar a un componente de audio y, a continuación, presione ENTER (ingresar).

Si no conectó el componente de audio, seleccione “NO” y vaya al paso 13.

Si conectó el componente de audio sólo con un cable de audio, seleccione “YES: LINE OUTPUT L/R (AUDIO)” y vaya al paso 13.

Si conectó un componente de audio mediante un cable digital coaxial, óptica/HDMI (interfaz multimedia de alta definición) seleccione “YES: DIGITAL OUTPUT”.

10 Presione ↑/↓ para seleccionar el tipo de señal Dolby Digital que desee enviar al componente de audio.

Si el componente de audio dispone de decodificador Dolby Digital, seleccione “DOLBY DIGITAL”. De lo contrario, seleccione “D-PCM”.

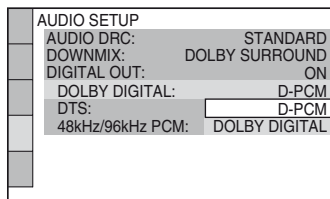

11 Presione ENTER (ingresar).

Se selecciona “DTS” (sistema digital de sala de cine).

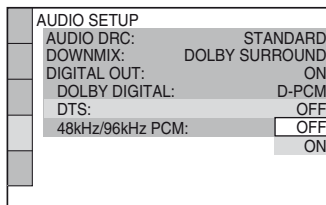

12 Presione ↑/↓ para seleccionar si desea o no enviar una señal DTS (sistema digital de sala de cine) al componente de audio.

Si el componente de audio dispone de decodificador DTS, seleccione “ON”. De lo contrario, seleccione “OFF”.

13 Presione ENTER (ingresar).

El ajuste rápido ha finalizado. Todas las conexiones y operaciones de ajuste se han completado.

Nota

Cuando el modo “PhotoTV HD” está activado (página 61), se salta la selección para “TIPO TV”.

Reproducción

Reproducción de discos

DVD Video *1 DVD VR *2 VCD *3 CD *4

DATA CD *5 DATA DVD *6

Algunas operaciones pueden ser distintas o estar limitadas en función del DVD (videodisco digital) o VIDEO CD (videodisco compacto).

Consulte las instrucciones de uso suministradas con el disco.

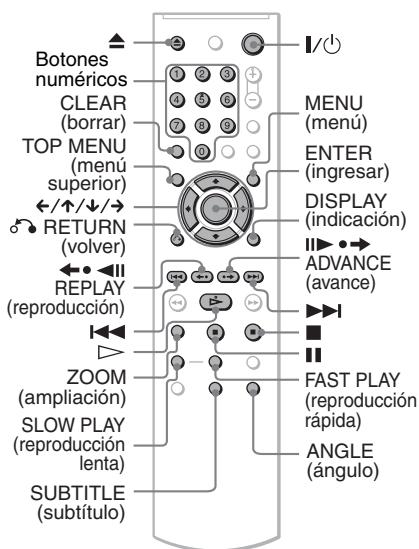

- *1 DVD video (video de videodisco digital).
- *2 DVD-VR (videodisco digital sin función de grabación de video).
- *3 VCD (videodisco compacto).
- *4 CD (disco compacto).
- *5 DATA CD (disco compacto de datos).
- *6 DATA DVD (videodisco digital de datos).

1 Encienda el televisor.

2 Presione I/⏻.

El reproductor se enciende.

3 Cambie el selector de entrada del televisor para que la señal del reproductor aparezca en la pantalla del televisor.

◆ Cuando utilice un componente de audio

Encienda el componente de audio y seleccione el canal adecuado para que pueda escuchar el sonido del reproductor.

4 Presione ▲ en el reproductor y coloque un disco en la bandeja de discos.

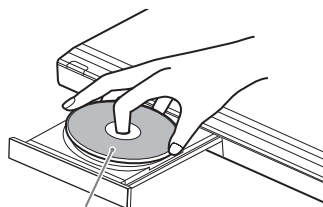



Con la cara de reproducción hacia abajo

5 Presione ▶.

La bandeja de discos se cierra y el reproductor inicia la reproducción (continua). Ajuste el volumen en el televisor o en el componente de audio. De acuerdo con el disco, puede aparecer un menú en la pantalla del televisor. Para los DVD VIDEO (video de videodisco digital), consulte página 30. Para los VIDEO CD (videodiscos compactos), consulte página 31.





Para apagar el reproductor

Presione I/⏻. El reproductor entra en modo de espera.

Para	Funcionamiento
Avanzar rápidamente una pequeña parte de la escena actual* ²	Presione   ADVANCE (avance) durante la reproducción
Aumentar la imagen* ³	Presione ZOOM (ampliación) varias veces. Presione CLEAR (borrar) para cancelar.

*¹ Todos los discos de DVD (videodisco digital) excepto para DVD+R (videodisco digital más grabable)/DVD+RW (videodisco digital más grabable)/DVD+R DL (videodisco digital más grabable de doble capa).

*² Sólo para discos DVD (videodisco digital).

*³ Sólo para imágenes de video y JPEG (grupo conjunto de expertos en fotografía) (salvo imágenes FONDO). Puede mover la imagen ampliada mediante ///. Según el contenido del disco, es posible que se cancele en forma automática la función de zoom (ampliación) cuando se mueva la imagen.

Nota

Tal vez no pueda utilizar la función de repetición o avance en ciertas escenas.



Printed on 70% or more recycled paper using
VOC (Volatile Organic Compound)-free
vegetable oil based ink.



* 1 - 3 2 8 3 1 4 9 2 2 2 *

3-283-149-22(2)

Free Manuals Download Website

<http://myh66.com>

<http://usermanuals.us>

<http://www.somanuals.com>

<http://www.4manuals.cc>

<http://www.manual-lib.com>

<http://www.404manual.com>

<http://www.luxmanual.com>

<http://aubethermostatmanual.com>

Golf course search by state

<http://golfingnear.com>

Email search by domain

<http://emailbydomain.com>

Auto manuals search

<http://auto.somanuals.com>

TV manuals search

<http://tv.somanuals.com>