

The software of this player may be updated in the future. To find out details on any available updates, please visit: <http://support.sony-europe.com/>



To find out useful hints, tips and information about Sony products and services please visit: www.sony-europe.com/myproduct/



AVCHD™

HDMI

BD-LIVE™



DVD
VIDEO

COMPACT
disc
DIGITAL AUDIO



BRAVIA
Sync

PhotoTV
HD

Java
POWERED

<http://www.sony.net/>

Printed on 70% or more recycled paper using VOC (Volatile Organic Compound)-free vegetable oil based ink.

4-261-827-31(1)



* 1 - 4 2 6 1 8 2 7 3 1 2 *

Printed in Malaysia

© 2011 Sony Corporation

Download from www.Somanuals.com. All Manuals Search And Download.

Operating Instructions

Blu-ray Disc™ / DVD Player

BDP-S280

WARNING

To reduce the risk of fire or electric shock, do not expose this apparatus to rain or moisture.

To avoid electrical shock, do not open the cabinet. Refer servicing to qualified personnel only.

The mains lead must be changed only at a qualified service shop.

Batteries or batteries installed apparatus shall not be exposed to excessive heat such as sunshine, fire or the like.

CAUTION

The use of optical instruments with this product will increase eye hazard. As the laser beam used in this Blu-ray Disc/DVD player is harmful to eyes, do not attempt to disassemble the cabinet.

Refer servicing to qualified personnel only.





This label is located on the laser protective housing inside the enclosure.



This appliance is classified as a CLASS 1 LASER product. The CLASS 1 LASER PRODUCT MARKING is located on the rear exterior.

Notice for customers in the United Kingdom and Republic of Ireland

A molded plug complying with BS1363 is fitted to this equipment for your safety and convenience. Should the fuse in the plug supplied need to be replaced, a fuse of the same rating as the supplied one and approved by ASTA or BSI to BS1362, (i.e., marked with  or  mark) must be used.

If the plug supplied with this equipment has a detachable fuse cover, be sure to attach the fuse cover after you change the fuse. Never use the plug without the fuse cover. If you should lose the fuse cover, please contact your nearest Sony service station.



Disposal of Old Electrical & Electronic Equipment (Applicable in the European Union and other European countries with separate collection systems)

This symbol on the product or on its packaging indicates that this product shall not be treated as household waste. Instead it shall be handed over to the applicable collection point for the recycling of electrical and electronic equipment. By ensuring this product is disposed of correctly, you will help prevent potential negative consequences for the environment and human health, which could otherwise be caused by inappropriate waste handling of this product. The recycling of materials will help to conserve natural resources. For more detailed information about recycling of this product, please contact your local Civic Office, your household waste disposal service or the shop where you purchased the product.



Disposal of waste batteries (applicable in the European Union and other European countries with separate collection systems)

This symbol on the battery or on the packaging indicates that the battery provided with this product shall not be treated as household waste. On certain batteries this symbol might be used in combination with a chemical symbol. The chemical symbols for mercury (Hg) or lead (Pb) are added if the battery contains more than 0.0005% mercury or 0.004% lead.

By ensuring these batteries are disposed of correctly, you will help prevent potentially negative consequences for the environment and human health which could otherwise be caused by inappropriate waste handling of the battery. The recycling of the materials will help to conserve natural resources.

In case of products that for safety, performance or data integrity reasons require a permanent connection with an incorporated battery, this battery should be replaced by qualified service staff only.

To ensure that the battery will be treated properly, hand over the product at end-of-life to the applicable collection point for the recycling of electrical and electronic equipment.

For all other batteries, please view the section on how to remove the battery from the product safely. Hand the battery over to the applicable collection point for the recycling of waste batteries.

For more detailed information about recycling of this product or battery, please contact your local Civic Office, your household waste disposal service or the shop where you purchased the product.

The manufacturer of this product is Sony Corporation, 1-7-1 Konan Minato-ku Tokyo, 108-0075 Japan. The Authorised Representative for EMC and product safety is Sony Deutschland GmbH, Hedelfinger Strasse 61, 70327 Stuttgart, Germany. For any service or guarantee matters please refer to the addresses given in separate service or guarantee documents.

Precautions

- This unit operates on 220–240V AC, 50/60Hz. Check that the unit's operating voltage is identical with your local power supply.
- To prevent fire or shock hazard, do not place objects filled with liquids, such as vases, on the apparatus.
- Install this unit so that the mains lead can be unplugged from the wall socket immediately in the event of trouble.

Precautions

This equipment has been tested and found to comply with the limits set out in the EMC Directive using a connection cable shorter than 3 metres.

On placement

- Place the player in a location with adequate ventilation to prevent heat build-up in the player.
- Do not place the player on a soft surface such as a rug that might block the ventilation holes.
- Do not install this player in a confined space, such as a bookshelf or similar unit.
- Do not place the player in a location near heat sources, or in a place subject to direct sunlight, excessive dust, or mechanical shock.
- Do not place the player outdoors, in vehicles, on ships, or on other vessels.
- If the player is brought directly from a cold to a warm location, or is placed in a very damp room, moisture may condense on the lenses inside the player. Should this occur, the player may not operate properly. In this case, remove the disc and leave the player turned on for about half an hour until the moisture evaporates.
- Do not install the player in an inclined position. It is designed to be operated in a horizontal position only.
- This player should be installed and operated with a minimum distance of at least 20 cm or more between the player and a person's body (excluding extremities: hands, wrists, feet and ankles).
- Do not place heavy or unstable objects on the player.
- Do not place any objects other than discs on the disc tray. Doing so may cause damage to the player or the object.

- Take out any discs when you move the player. If you don't, the disc may be damaged.
- Disconnect the AC power cord (mains lead) and all other cables from the player when you move the player.

On power sources

- The player is not disconnected from the AC power source (mains) as long as it is connected to the wall outlet, even if the player itself has been turned off.
- Disconnect the player from the wall outlet if you are not going to use the player for a long time. To disconnect the AC power cord (mains lead), grasp the plug itself; never pull the cord.
- Observe following points to prevent the AC power cord (mains lead) being damaged. Do not use the AC power cord (mains lead) if it is damaged, as doing so may result in an electric shock or fire.
 - Do not pinch the AC power cord (mains lead) between the player and wall, shelf, etc.
 - Do not put anything heavy on the AC power cord (mains lead) or pull on the AC power cord (mains lead) itself.

On adjusting volume

Do not turn up the volume while listening to a section with very low level inputs or no audio signals. If you do, your ears and the speakers may be damaged when a peak level section is played.

On cleaning

Clean the cabinet, panel, and controls with a soft cloth. Do not use any type of abrasive pad, scouring powder or solvent such as alcohol or benzine.

On cleaning discs, disc/lens cleaners

Do not use cleaning discs or disc/lens cleaners (including wet or spray types). These may cause the apparatus to malfunction.

On replacement of parts

In the events that this player is repaired, repaired parts may be collected for reuse or recycling purposes.

On connecting to the HDMI OUT jack

Observe the following as improper handling may damage the HDMI OUT jack and the connector.

- Carefully align the HDMI OUT jack on the rear of the player and the HDMI connector by checking their shapes. Make sure the connector is not upside down or tilted.

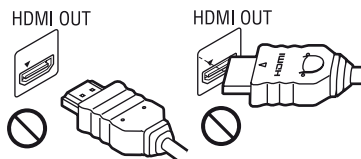

- Be sure to disconnect the HDMI cable when moving the player.



- Hold the HDMI connector straight when connecting or disconnecting the HDMI cable. Do not twist or force the HDMI connector into the HDMI OUT jack.

IMPORTANT NOTICE

Caution: This player is capable of holding a still video image or on-screen display image on your television screen indefinitely. If you leave the still video image or on-screen display image displayed on your TV for an extended period of time you risk permanent damage to your television screen. Plasma display panel televisions and projection televisions are susceptible to this.

If you have any questions or problems concerning your player, please consult your nearest Sony dealer.

Copy Protection

Please be advised of the advanced content protection systems used in both Blu-ray Disc™ and DVD media. These systems, called AAC (Advanced Access Content System) and CSS (Content Scramble System), may contain some restrictions on playback, analogue output, and other similar features. The operation of this product and the restrictions placed may vary depending on the date of purchase, as the governing board of the AAC may adopt or change its restriction rules after the time of purchase.

Copyrights and Trademarks

- “AVCHD” and the “AVCHD” logo are trademarks of Panasonic Corporation and Sony Corporation.
- Java, the coffee cup logo, and all Java based marks are trademarks or registered trademarks of Sun Microsystems, Inc. in the U.S. or other countries.
- “XMB,” and “cross media bar” are trademarks of Sony Corporation and Sony Computer Entertainment Inc.
- This product incorporates High-Definition Multimedia Interface (HDMI™) technology. HDMI, the HDMI logo and High-Definition Multimedia Interface are trademarks or registered trademarks of HDMI Licensing LLC in the United States and other countries.
- “Blu-ray Disc” is a trademark.
- “Blu-ray Disc,” “DVD+RW,” “DVD-RW,” “DVD+R,” “DVD-R,” “DVD VIDEO,” and “CD” logos are trademarks.
- “BD-LIVE,” “BD-LIVE” logo, and “BONUSVIEW” are trademarks of Blu-ray Disc Association.
- “x.v.Colour” and “x.v.Colour” logo are trademarks of Sony Corporation.
- “BRAVIA” is a trademark of Sony Corporation.
- “PhotoTV HD” and the “PhotoTV HD” logo are trademarks of Sony Corporation.
- MPEG Layer-3 audio coding technology and patents licensed from Fraunhofer IIS and Thomson.
- Windows Media is either a registered trademark or trademark of Microsoft Corporation in the United States and/or other countries. This product is protected by certain intellectual property rights of Microsoft Corporation. Use or distribution of such technology outside of this product is prohibited without a license from Microsoft or an authorised Microsoft subsidiary.
- All other trademarks are trademarks of their respective owners.
- Other system and product names are generally trademarks or registered trademarks of the manufacturers.™ and ® marks are not indicated in this document.

Table of Contents

WARNING	2
Precautions	3
Guide to Parts and Controls	6

Hookups and Settings

Step 1: Connecting the Player	9
Step 2: Easy Setup	11
Connecting to the Network	11

Playback

Playing a Disc	12
Playing from a USB Device	13
Playing via a Network	13
Available Options	14

Settings and Adjustments

Using the Settings Displays	15
[Network Update]	15
[Screen Settings]	15
[Audio Settings]	16
[BD/DVD Viewing Settings]	17
[Parental Control Settings]	17
[System Settings]	18
[Network Settings]	18
[Easy Setup]	19
[Resetting]	19

Additional Information

Troubleshooting	20
Specifications	23
Index	27

Guide to Parts and Controls

Front panel



The ► button has a tactile dot. Use the tactile dot as a reference when operating the player.

1 Disc tray

2 Remote sensor

3 Front panel display

►, ■: Lights up during playback or pause.

↺: Lights up when enabling the repeat setting.

HD: Lights up when outputting 720p/1080i/1080p video signals.

4 ■ (stop)

5 ► (play)

6 ▲ (open/close)

7 I/⏻ (on/standby)

Turns on the player, or sets to standby mode.

To lock the disc tray (Child Lock)

You can lock the disc tray to prevent it being opened by mistake.

When the player is turned on, hold down ► on the player for more than 10 seconds. The disc tray is locked or unlocked.

Rear panel

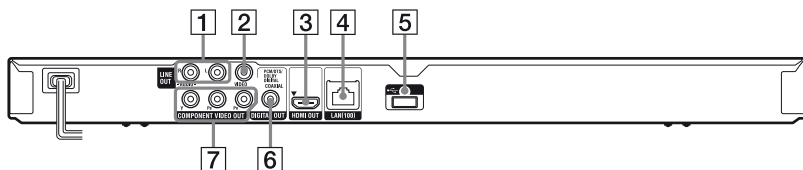

1 LINE OUT (R-AUDIO-L) jacks

2 LINE OUT (VIDEO) jack

3 HDMI OUT jack

4 LAN (100) terminal

5 ↔ (USB) jack

6 DIGITAL OUT (COAXIAL) jack

7 COMPONENT VIDEO OUT (Y, P_B, P_R) jacks

Remote

The available functions of the remote differ depending on the disc or the situation.

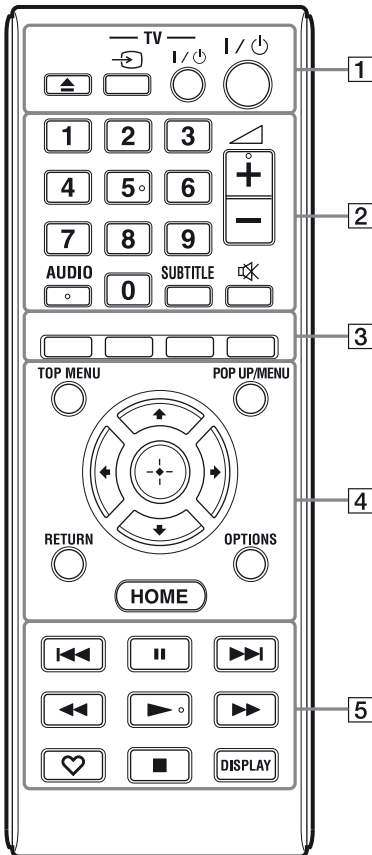

Number 5, AUDIO, \triangleleft +, and \blacktriangleright buttons have a tactile dot. Use the tactile dot as a reference when operating the player.

1 \triangle (open/close)

Opens or closes the disc tray.

-TV- \rightarrow (TV input select)

Switches between TV and other input sources.

-TV- I/O (TV on/standby)

Turns on the TV, or sets to standby mode.

I/O (on/standby)

Turns on the player, or sets to standby mode.

2 Number buttons (0 - 9)

Enters the title/chapter numbers, etc.

\triangleleft (volume) +/-

Adjusts the TV volume.

AUDIO (page 17)

Selects the language track when multilingual tracks are recorded on BD-ROMs/DVD VIDEOS.

Selects the sound track on CDs.

SUBTITLE (page 17)

Selects the subtitle language when multilingual subtitles are recorded on BD-ROMs/DVD VIDEOS.

\boxtimes (muting)

Turns off the sound temporarily.

3 Colour buttons (red/green/yellow/blue)

Shortcut keys for interactive functions.

4 TOP MENU

Opens or closes the BD's or DVD's Top Menu.

POP UP/MENU

Opens or closes the BD-ROM's Pop-up Menu, or the DVD's menu.

OPTIONS (page 14)

The options menu that can be selected appears on the screen.

HOME

Enters the player's home menu.

Displays the wall paper when pressed on the category icon of the home menu.

RETURN

Returns to the previous display.



Moves the highlight to select a displayed item.

Centre button (ENTER)

Enters the selected item.

5 ◀◀/▶▶ (previous/next)

Skips to the previous/next chapter, track, or file.

II (pause)

Pauses or re-starts playback.

◀◀/▶▶ (fast reverse/fast forward)

- Fast reverses/fast forwards the disc when pressed during playback. Each time you press the button during playback of videos, the search speed changes.
- Plays in slow motion, when pressed for more than one second in pause mode.
- Plays one frame at a time, when pressed briefly in pause mode.

▶ (play)

Starts or re-starts playback.

♥ (favourites) (page 14)

Displays the Internet content added to the Favourites List. You can save up to 18 of your favourite Internet content programmes.

■ (stop)

Stops playback and remembers the stop point (resume point).

The resume point for a title/track is the last point you played or the last photo for a photo folder.

DISPLAY (page 12)

Displays the playback information on the screen.

Home menu display

The home menu appears when you press HOME. Select a category using ◀/▶. Select an item using ↑/↓, and press ENTER.

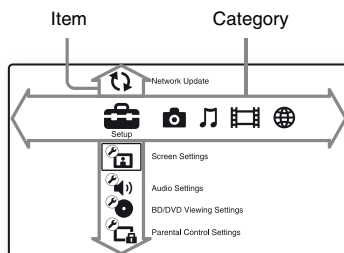

- [Setup]: Adjusts the player settings.
- [Photo]: Displays photos.
- [Music]: Plays music.
- [Video]: Plays videos.
- [Network]: Displays network items.









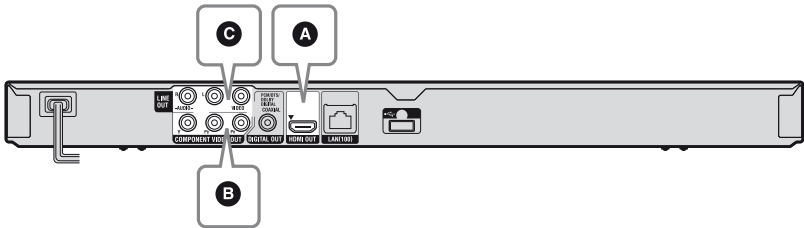

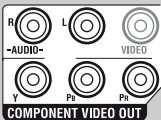

Step 1: Connecting the Player

Do not connect the mains lead until you have made all the connections.
For supplied accessories, see “Supplied accessories” (page 23).

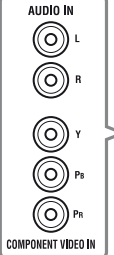
Connecting to your TV

Select one of the following connection methods according to the input jacks on your TV.
Match the colour of the plug to that of the jack when connecting.

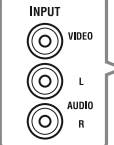

<p>A</p> 	<p>HDMI cable (not supplied)</p> 	<p>High quality</p>  
<p>B</p> 	<p>Audio/video cable (not supplied)</p>  <p>Component video cable* (not supplied)</p> 	 
<p>C</p> 	<p>Audio/video cable (not supplied)</p> 	  <p>Standard quality</p>





* Protected content on BD-ROMs is output at 480i/576i resolution from the COMPONENT VIDEO OUT jack (page 4).

⚡ Do not connect the player through a VCR. Video signals fed through VCRs may be affected by copyright protection systems and the picture will be distorted on the television.

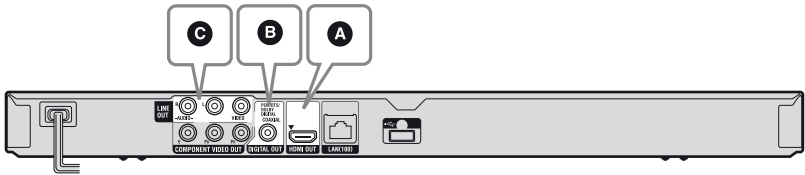
Connecting to your AV amplifier (receiver)

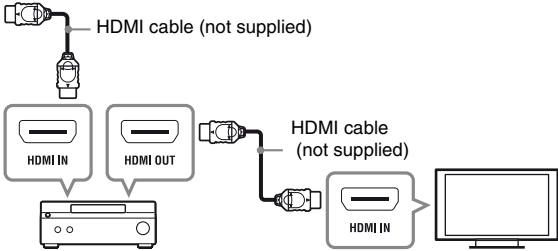
Select one of the following connection methods according to the input jacks on your AV amplifier (receiver). When you select **A** or **B**, make the appropriate settings in the [Audio Settings] setup (page 16).

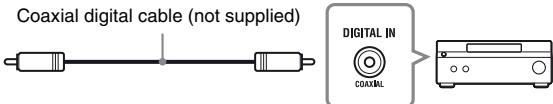

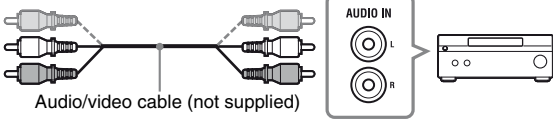
<p>A</p>  <p>HDMI OUT</p>	 <p>HDMI cable (not supplied)</p> <p>HDMI cable (not supplied)</p> <p>→ Set [BD Audio MIX Setting] (page 16).</p>
<p>B</p>  <p>DIGITAL OUT</p>	 <p>Coaxial digital cable (not supplied)</p> <p>→ Set [Dolby Digital^{*1}] (page 16) and [DTS^{*2}] (page 16).</p>
<p>C</p>  <p>AUDIO/VIDEO OUT</p>	 <p>Audio/video cable (not supplied)</p>

^{*1} Manufactured under license from Dolby Laboratories.
Dolby, Pro Logic, and the double-D symbol are trademarks of Dolby Laboratories.

^{*2} Manufactured under license under U.S. Patent #'s: 5,451,942; 5,956,674; 5,974,380; 5,978,762; 6,226,616; 6,487,535; 7,212,872; 7,333,929; 7,392,195; 7,272,567 & other U.S. and worldwide patents issued & pending. DTS and the Symbol are registered trademarks, & DTS-HD, DTS-HD Master Audio, and the DTS logos are trademarks of DTS, Inc. Product includes software. © DTS, Inc. All Rights Reserved.

Step 2: Easy Setup

When turned on for the first time
 Wait for a short while before the player turns on and starts [Easy Setup].

- 1 Insert two R6 (size AA) batteries by matching the ⊕ and ⊖ ends on the batteries to the markings inside the battery compartment.**

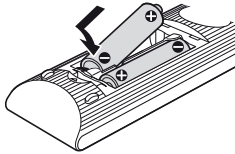

- 2 Plug the player into the mains.**

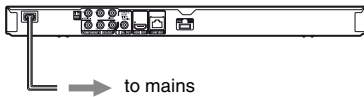

- 3 Press I/⏻ to turn on the player.**

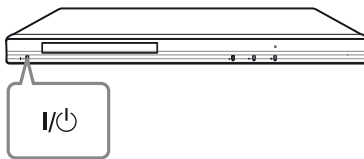

- 4 Turn on the TV, then switch the input selector on your TV so that the signal from the player appears on your TV screen.**

- 5 Perform [Easy Setup].**

Follow the on-screen instructions to make the basic settings using ←/↑/↓/→ and ENTER on the remote.

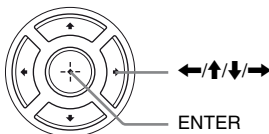

Connecting to the Network

Wired Setup

Use a LAN cable to connect to the LAN (100) terminal on the player.

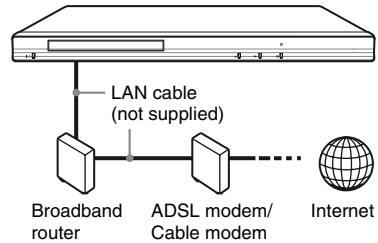

Using a shielded interface cable (LAN cable), straight or crossing, is recommended.

To set the network settings

Select [Network Settings], [Internet Settings], then [Wired Setup] (page 18), and follow the on-screen instructions to complete the setup.

USB Wireless Setup

Turn off the player, then connect the USB Wireless LAN Adapter (UWA-BR100 only available as of October 2010) to the USB jack on the player.

The USB Wireless LAN Adapter may not be available in some regions/countries.

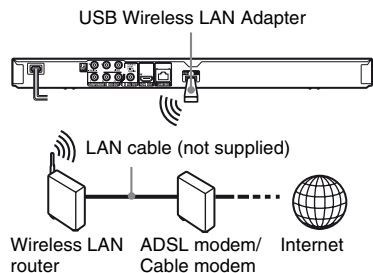

To set the network settings

Select [Network Settings], [Internet Settings], then [USB Wireless Setup] (page 18), and follow the on-screen instructions to complete the setup.

Playing a Disc

For playable discs, see “Playable discs” (page 24).

- 1 **Switch the input selector on your TV so that the signal from the player appears on your TV screen.**
- 2 **Press \blacktriangle , and place a disc on the disc tray.**

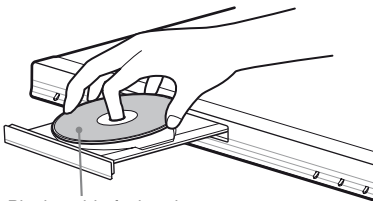

Playing side facing down

- 3 **Press \blacktriangle to close the disc tray.**

Playback starts.

If playback does not start automatically, select \blacksquare in the \blacksquare [Video], ♪ [Music], or 📷 [Photo] category, and press ENTER.

Enjoying BONUSVIEW/BD-LIVE

Some BD-ROMs with the “BD-LIVE” logo* have bonus content and other data that can be downloaded for enjoyment.

* BD-LIVE™

- 1 **Connect a USB memory to the USB jack on the rear of the player (page 6).**
As your local storage, use a 1 GB or larger USB memory.
- 2 **Prepare for BD-LIVE (BD-LIVE only).**
 - Connect the player to a network (page 11).
 - Set [BD Internet Connection] to [Allow] (page 17).

3 Insert a BD-ROM with BONUSVIEW/BD-LIVE.

The operation method differs depending on the disc. Refer to the instruction manual supplied with the disc.



To delete data in the USB memory, select [Erase BD Data] in the \blacksquare [Video], and press ENTER. All data stored in the buda folder will be erased.

Displaying the play information

You can check the playback information, etc., by pressing DISPLAY. The displayed information differs depending on the disc type and player status. Example: when playing a BD-ROM

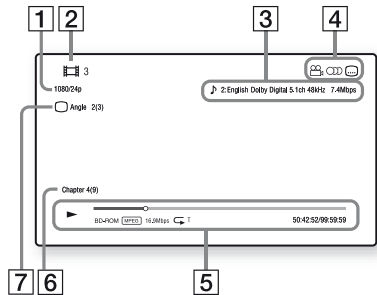

- 1 Output resolution/Video frequency
- 2 Title number or name
- 3 The currently selected audio setting
- 4 Available functions (📷 angle, 🔊 audio, 🗨️ subtitle)
- 5 Playback information
Displays the Play mode, Playing status bar, Disc type, Video codec, Bitrate, Repeat type, Elapsed time, and Total playing time.
- 6 Chapter number
- 7 The currently selected angle

Playing from a USB Device

You can play video/music/photo files on the connected USB device.

For playable USB devices, see “Playable types of files” (page 24).

1 Connect the USB device to the USB jack on the player.

Refer to the instruction manual supplied with the USB device before connecting.

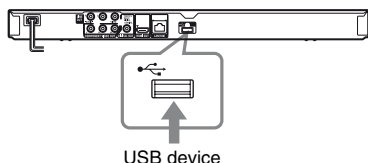

2 Select [Video], [Music], or [Photo] on the home menu using ←/→.

3 Select [USB device] using ↑/↓, and press ENTER.

Playing via a Network

Streaming BRAVIA Internet Video

Serves as a gateway delivering the selected Internet content and a variety of on-demand entertainment straight to your player.



Some Internet content requires registration via a PC before it can be played.

1 Prepare for BRAVIA Internet Video.

Connect the player to a network (page 11).

2 Select [Video], [Music], or [Photo] on the home menu using ←/→.

3 Select an Internet content provider icon using ↑/↓, and press ENTER.

When an Internet content list has not been acquired, an unacquired icon or a new icon is displayed.

To use the control panel

The control panel appears when the video file starts playing. The displayed items may differ depending on Internet content providers.

To display again, press DISPLAY.

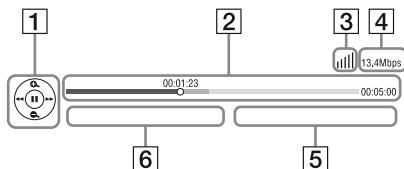

- 1 Control display**
Press ←/↑/↓/→ or ENTER for playback operations.
- 2 Playing status bar**
Status bar, Cursor indicating the current position, Playing time, Duration of the video file
- 3 Network condition**
[Signal strength icon] indicates the signal strength for wireless connection.
[Wired connection icon] indicates a wired connection.
- 4 Network transmission speed**
- 5 The next video file name**
- 6 The currently selected video file name**

Available Options

Various settings and playback operations are available by pressing **OPTIONS**. The available items differ depending on the situation.

Common options

Items	Details
[Repeat Setting]	Sets the repeat mode.
[Favourites List]	Displays the Favourites List.
[Play/Stop]	Starts or stops the playback.
[Play from start]	Plays the item from the beginning.
[Add to Favourites]	Adds Internet content to the Favourites List.
[Remove from Favourites]	Removes Internet content from the Favourites List.

⏏ [Video] only

Items	Details
[A/V SYNC]	Adjusts the gap between picture and sound, by delaying the sound output in relation to the picture output (0 to 120 milliseconds).
[Video Settings]	<ul style="list-style-type: none"> • [Picture Quality Mode]: Selects the picture settings for different lighting environments. • [BNR]: Reduces the mosaic-like block noise in the picture. • [MNR]: Reduces minor noise around the picture outlines (mosquito noise).
[Pause]	Pauses the playback.
[Top Menu]	Displays the BD's or DVD's Top Menu.
[Menu/Popup Menu]	Displays the BD-ROM's Pop-up Menu or DVD's menu.
[Title Search]	Searches for a title on BD-ROMs/DVD VIDEOS and starts playback from the beginning.
[Chapter Search]	Searches for a chapter and starts playback from the beginning.
[Angle]	Switches to other viewing angles when multi-angles are recorded on BD-ROMs/ DVD VIDEOS.

Items	Details
[IP Content Noise Reduction]	Adjusts the picture quality of Internet content.

🎵 [Music] only



Items	Details
[Add Slideshow BGM]	Registers music files in the USB memory as slideshow background music (BGM).









📷 [Photo] only

Items	Details
[Slideshow Speed]	Changes the slideshow speed.
[Slideshow Effect]	Sets the effect for slideshows.
[Slideshow BGM]	<ul style="list-style-type: none"> • [Off]: Turns off the function. • [My Music from USB]: Sets the music files registered in [Add Slideshow BGM]. If no music file is registered, [(Not registered)] is displayed. • [Play from Music CD]: Sets the tracks in CD-DAs.
[Slideshow]	Plays a slideshow.
[Rotate Left]	Rotates the photo counterclockwise by 90 degrees.
[Rotate Right]	Rotates the photo clockwise by 90 degrees.

Using the Settings Displays

Select  [Setup] on the home menu when you need to change the settings of the player. The default settings are underlined.

- 1 Select  [Setup] on the home menu using .
- 2 Select the setup category icon using , and press ENTER.

Icon	Explanation
	[Network Update] (page 15) Updates the software of the player.
	[Screen Settings] (page 15) Makes the video settings according to the type of connecting jacks.
	[Audio Settings] (page 16) Makes the audio settings according to the type of connecting jacks.
	[BD/DVD Viewing Settings] (page 17) Makes detailed settings for BD/DVD playback.
	[Parental Control Settings] (page 17) Makes detailed settings for the Parental Control function.
	[System Settings] (page 18) Makes the player-related settings.
	[Network Settings] (page 18) Makes detailed settings for the Internet and network.
	[Easy Setup] (page 19) Re-runs the Easy Setup to make the basic settings.
	[Resetting] (page 19) Resets the player to the factory settings.

[Network Update]

Select [OK] to update the player's software via the network.



- We recommend the network update every 2 months or so.
- For information about update functions, visit the following website:
<http://support.sony-europe.com/>

[Screen Settings]

■ [TV Type]

[16:9]: Select this when connecting to a wide-screen TV or a TV with a wide mode function.

[4:3]: Select this when connecting to a 4:3 screen TV without a wide mode function.

■ [Screen Format]

[Original]: Select this when connecting to a TV with a wide mode function. Displays a 4:3 screen picture in 16:9 aspect ratio even on a wide-screen TV.

[Fixed Aspect Ratio]: Changes the picture size to fit the screen size with the original picture aspect ratio.

■ [DVD Aspect Ratio]

[Letter Box]: Displays a wide picture with black bands on the top and bottom.



[Pan & Scan]: Displays a full-height picture on the entire screen, with trimmed sides.

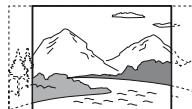

■ [Cinema Conversion Mode]

[Auto]: Normally select this. The player automatically detects whether the material is video-based or film-based, and switches to the appropriate conversion method.

[Video]: The conversion method suited for video-based material will always be selected regardless of the material.

■ [Output Video Format]

[HDMI]: Normally select [Auto].

Select [Original Resolution] to output the resolution recorded on the disc. When the resolution is lower than the SD resolution, it is scaled up to the SD resolution.

[Component Video]: Select the resolution that suits your TV.

[Video]: Automatically sets the lowest resolution.



- When connecting the HDMI OUT jack and other video output jacks at the same time, select [Component Video].
- If no picture appears when setting [HDMI] or [Component Video] resolution, try another resolution setting.
- When connecting via the COMPONENT VIDEO OUT jack and [Component Video] is selected, BD-ROM playback of protected content is only supported at 480i/576i output resolution (page 4).

■ [BD/DVD-ROM 1080/24p Output]

[Auto]: Outputs 1920 × 1080p/24 Hz video signals only when connecting a 1080/24p-compatible TV using the HDMI OUT jack.

[Off]: Select this when your TV is not compatible with 1080/24p video signals.

■ [YCbCr/RGB (HDMI)]

[Auto]: Automatically detects the connected TV type, and switches to the matching colour setting.

[YCbCr (4:2:2)]: Outputs YCbCr 4:2:2 video signals.

[YCbCr (4:4:4)]: Outputs YCbCr 4:4:4 video signals.

[RGB]: Outputs RGB video signals.

■ [HDMI Deep Colour Output]

[Auto]: Normally select this.

[16bit], [12bit], [10bit]: Outputs 16bit/12bit/10bit video signals when the connected TV is compatible with Deep Colour.

[Off]: Select this when the picture is unstable or colours appear unnatural.

■ [Pause Mode]

[Auto]: Normally select this. Dynamic moving pictures appear without blurring.

[Frame]: Displays static pictures at high resolution.



[Audio Settings]

■ [Audio (HDMI)]

[Auto]: Normally select this. Outputs audio signals according to the status of the connected HDMI device.

[PCM]: Outputs PCM signals from the HDMI OUT jack.

■ [BD Audio MIX Setting]

[On]: Outputs the audio obtained by mixing the interactive and secondary audio to the primary audio.

[Off]: Outputs the primary audio only. Select this to output HD audio signals to an AV amplifier (receiver).

■ [Dolby Digital]

[Downmix PCM]: Converts to output Linear PCM signals. Select this when connecting an audio device without a built-in Dolby Digital decoder.

[Dolby Digital]: Select this when connecting an audio device with a built-in Dolby Digital decoder.

■ [DTS]

[Downmix PCM]: Converts to output Linear PCM signals. Select this when connecting to an audio device without a built-in DTS decoder.

[DTS]: Select this when connecting to an audio device with a built-in DTS decoder.

■ [DTS Neo:6]

[Cinema]: Outputs simulated multichannel sound from 2 channel sources via the HDMI OUT jack according to the capability of the connected device using DTS Neo:6 Cinema mode.

[Music]: Outputs simulated multichannel sound from 2 channel sources via the HDMI OUT jack according to the capability of the connected device using DTS Neo:6 Music mode.

[Off]: Outputs sound with its original number of channels via the HDMI OUT jack.

■ [Audio DRC]

[Auto]: Performs playback at the dynamic range specified by the disc (BD-ROM only). Other discs are played back at the [On] level.
 [On]: Performs playback at a standard compression level.
 [Off]: No compression works. A more dynamic sound is produced.

■ [Downmix]

[Surround]: Outputs audio signals with surround effects. Select this when connecting an audio device that supports Dolby Surround (Pro Logic) or DTS Neo:6.
 [Stereo]: Outputs audio signals without surround effects. Select this when connecting an audio device that does not support Dolby Surround (Pro Logic) or DTS Neo:6.



BD/DVD Viewing Settings

■ [BD/DVD Menu]

Selects the default menu language for BD-ROMs or DVD VIDEOS.
 When you select [Select Language Code], the display for entering the language code appears. Enter the code for your language by referring to “Language code list” (page 26).

■ [Audio]

Selects the default track language for BD-ROMs or DVD VIDEOS.
 When you select [Original], the language given priority in the disc is selected.
 When you select [Select Language Code], the display for entering the language code appears. Enter the code for your language by referring to “Language code list” (page 26).

■ [Subtitle]

Selects the default subtitle language for BD-ROMs or DVD VIDEOS.
 When you select [Select Language Code], the display for entering the language code appears. Enter the code for your language by referring to “Language code list” (page 26).

■ [BD Hybrid Disc Playback Layer]

[BD]: Plays BD layer.
 [DVD/CD]: Plays DVD or CD layer.

■ [BD Internet Connection]

[Allow]: Normally select this.
 [Do not allow]: Prohibits Internet connection.



Parental Control Settings

■ [Password]

Sets or changes the password for the Parental Control function. A password allows you to set a restriction on BD-ROM or DVD VIDEO, and Internet video playback. If necessary, you can differentiate the restriction levels for BD-ROMs, DVD VIDEOS, and Internet videos.

■ [Parental Control Area Code]

Playback of some BD-ROMs, DVD VIDEOS, or Internet videos can be limited according to the geographic area. Scenes may be blocked or replaced with different scenes. Follow the on-screen instructions and enter your four-digit password.

■ [BD Parental Control]

Playback of some BD-ROMs can be limited according to the age of the users. Scenes may be blocked or replaced with different scenes. Follow the on-screen instructions and enter your four-digit password.

■ [DVD Parental Control]

Playback of some DVD VIDEOS can be limited according to the age of the users. Scenes may be blocked or replaced with different scenes. Follow the on-screen instructions and enter your four-digit password.

■ [Internet Video Parental Control]

Playback of some Internet videos can be limited according to the age of the users. Scenes may be blocked or replaced with different scenes. Follow the on-screen instructions and enter your four-digit password.

■ [Internet Video Unrated]

[Allow]: Allows the playback of unrated Internet videos.
 [Block]: Blocks the playback of unrated Internet videos.



[System Settings]

■ [OSD]

Selects your language for the player on-screen displays.

■ [Dimmer]

[Bright]: Bright lighting.

[Dark]: Low lighting.

[Off]: Turns off the lighting during playback. Low lighting other than during playback.

■ [Control for HDMI]

[On]: The following BRAVIA Sync features are available:

–One-Touch Play

–System Power-Off

–Language Follow

[Off]: Turns off the function.



For details, refer to the instruction manual supplied with the TV or components.

■ [HDMI: Linked to TV-off]

[On]: Automatically turns off the player and HDMI-compatible components when the connected TV enters standby mode (BRAVIA Sync).

[Off]: Turns off the function.

■ [Quick Start Mode]

[On]: Shortens the startup time when turning on the player.

[Off]: Reduces standby power consumption.

■ [Auto Standby]

[On]: Turns on the [Auto Standby] function. Automatically returns to standby mode if any button on the player or remote is not pressed for more than 30 minutes.

[Off]: Turns off the function.

■ [Auto Display]

[On]: Automatically displays information on the screen when changing the viewing titles, picture modes, audio signals, etc.

[Off]: Displays information only when you press DISPLAY.

■ [Screen Saver]

[On]: Turns on the screen saver function. The screen saver image appears when you do not use the player for more than 10 minutes while an on-screen display is displayed.

[Off]: Turns off the function.

■ [Software Update Notification]

[On]: Sets the player to inform you of newer software version information (page 15).

[Off]: Turns off the function.

■ [System Information]

Displays the player's software version information and the MAC address.



[Network Settings]

■ [Internet Settings]

Connect the player to the network beforehand. For details, see “Connecting to the Network” (page 11).

[View Network Status]: Displays the current network status.

[Wired Setup]: Select this when you connect to a broadband router using a LAN cable.

[USB Wireless Setup]: Select this when you use a USB Wireless LAN Adapter.



For further details, visit the following website and check the FAQ contents:

<http://support.sony-europe.com/>

■ [Network Connection Diagnostics]

You can run the network diagnostic to check if the network connection has been made properly.



[Easy Setup]

Re-runs the [Easy Setup] to make the basic settings. Follow the on-screen instructions.



[Resetting]

■ [Reset to Factory Default Settings]

You can reset the player settings to the factory default by selecting the group of settings. All the settings within the group will be reset.

■ [Initialize Personal Information]

You can erase your personal information stored in the player.

Troubleshooting

If you experience any of the following difficulties while using the player, use this troubleshooting guide to help remedy the problem before requesting repairs. Should any problem persist, consult your nearest Sony dealer.

Picture

There is no picture or the picture is not output correctly.

- ➔ Check that all the connecting cables are securely connected (page 9).
- ➔ Switch the input selector on your TV to display the signal from the player.
- ➔ Reset the video output resolution to the lowest resolution by pressing ■ on the player for more than 10 seconds.
- ➔ For HDMI connections, try the following:
 - ① Turn the player off and on again.
 - ② Turn the connected equipment off and on again.
 - ③ Disconnect and then reconnect the HDMI cable.
- ➔ The HDMI OUT jack is connected to a DVI device that does not support copyright protection technology.
- ➔ For HDMI connections, check the [Output Video Format] settings in the [Screen Settings] setup (page 16).
- ➔ When the analogue signals are also output, set [BD/DVD-ROM 1080/24p Output] to [Off] in the [Screen Settings] setup (page 16).
- ➔ For BD-ROMs, check the [BD/DVD-ROM 1080/24p Output] setting in the [Screen Settings] setup (page 16).

The display language on the screen switches automatically when connected to the HDMI OUT jack.

- ➔ When [Control for HDMI] is set to [On] (page 18), the display language on the screen automatically switches according to the language setting of the connected TV (if you change the setting on your TV, etc.).

Sound

There is no sound or the sound is not output correctly.

- ➔ Check that all the connecting cables are securely connected (page 9).
- ➔ Switch the input selector on your AV amplifier (receiver) so that the audio signals of the player are output from your AV amplifier (receiver).
- ➔ If the audio signal does not come through the DIGITAL OUT (COAXIAL)/HDMI OUT jack, check the audio settings (page 16).
- ➔ For HDMI connections, try the following:
 - ① Turn the player off and on again.
 - ② Turn the connected equipment off and on again.
 - ③ Disconnect and then reconnect the HDMI cable.
- ➔ For HDMI connections, if the player is connected to a TV through an AV amplifier (receiver), try connecting the HDMI cable directly to the TV. Refer also to the instruction manual supplied with the AV amplifier (receiver).
- ➔ The HDMI OUT jack is connected to a DVI device (DVI jacks do not accept audio signals).
- ➔ The device connected to the HDMI OUT jack does not support the audio format of the player. Check the audio settings (page 16).

The HD Audio (Dolby Digital Plus, Dolby TrueHD, DTS-HD High Resolution Audio, and DTS-HD Master Audio) is not output by bitstream.

- ➔ Set [BD Audio MIX Setting] to [Off] in the [Audio Settings] setup (page 16).
- ➔ Check that the connected AV amplifier (receiver) is compatible with each HD Audio format.

The interactive audio is not output.

- ➔ Set [BD Audio MIX Setting] to [On] in the [Audio Settings] setup (page 16).

Disc

The disc does not play.

- ➔ The disc is dirty or skewed.
- ➔ The disc is upside down. Insert the disc with the playback side facing down.
- ➔ The disc has a format that cannot be played back by this player (page 24).
- ➔ The player cannot play a recorded disc that is not correctly finalised.
- ➔ The region code on the BD or DVD does not match the player.

USB device

The player does not detect a USB device connected to the player.

- ➔ Make sure that the USB device is securely connected to the USB jack.
- ➔ Check if the USB device or a cable is damaged.
- ➔ Check if the USB device is on.
- ➔ If the USB device is connected via a USB hub, connect the USB device directly to the player.

BRAVIA Internet Video

The picture/sound is poor/certain programmes display a loss of detail, especially during fast-motion or dark scenes.

- ➔ Picture/sound quality may be poor depending on Internet content providers.
- ➔ Picture/sound quality may be improved by changing the connection speed. We recommend a connection speed of at least 2.5 Mbps for standard definition video (10 Mbps for high definition video).
- ➔ Not all videos will contain sound.

The picture is small.

- ➔ Press **↑** to zoom in.

Network connection

The player cannot connect to the network.

- ➔ Check the network connection (page 11) and the network settings (page 18).

The message [A new software version is available. Please go to the “Setup” section of the menu and select “Network update” to perform the update.] appears on the screen when turning the player on.

- ➔ See [Network Update] (page 15) to update the player to a newer software version.

Control for HDMI (BRAVIA Sync)

The [Control for HDMI] function does not work (BRAVIA Sync).

- ➔ Check that [Control for HDMI] is set to [On] (page 18).
- ➔ If you change the HDMI connection, turn the player off and on again.
- ➔ If power failure occurs, set [Control for HDMI] to [Off], then set [Control for HDMI] to [On] (page 18).
- ➔ Check the following and refer to the instruction manual supplied with the component.
 - the connected component is compatible with the [Control for HDMI] function.
 - the connected component’s setting for the [Control for HDMI] function is correct.
- ➔ When you connect the player to a TV through an AV amplifier (receiver),
 - if the AV amplifier (receiver) is not compatible with the [Control for HDMI] function, you may be unable to control the TV from the player.
 - if you change the HDMI connection, disconnect and reconnect the mains lead, or a power failure occurs, try the following:
 - ① Switch the input selector of the AV amplifier (receiver) so that the picture from the player appears on the TV screen.
 - ② Set [Control for HDMI] to [Off], then set [Control for HDMI] to [On] (page 18). Refer to the instruction manual supplied with the AV amplifier (receiver).

The System Power-Off function does not work (BRAVIA Sync).

- ➔ Check that [Control for HDMI] and [HDMI: Linked to TV-off] are set to [On] (page 18).

Others

Playback does not start from the beginning of content.

- ➔ Press **OPTIONS**, and select [Play from start].

Playback does not start from the resume point where you last stopped playing.

- ➔ The resume point may be cleared from memory depending on the disc when
 - you open the disc tray.
 - you disconnect the USB device.
 - you play other content.
 - you turn off the player.

The disc tray does not open and “LOCKED” or “TLK ON” appears on the front panel display.

- ➔ When “LOCKED” appears, the player is locked. To cancel the Child Lock, hold down **▶** on the player until “UNLOCK” appears on the front panel display (page 6).
- ➔ When “TLK ON” appears, contact your Sony dealer or local authorised Sony service facility.

The disc tray does not open and you cannot remove the disc even after you press **▲.**

- ➔ Try the following: ①Turn the player off, and disconnect the mains lead. ②Reconnect the mains lead while pressing down **▲** on the player. ③Keep pressing down **▲** on the player until the tray opens. ④Remove the disc. ⑤When “OPEN” appears on the front panel display, hold down **I/⏻** on the player for more than 10 seconds until the player turns off.

“Exxxx” or “TEM ERR” appears on the front panel display.

- ➔ When “Exxxx” appears, contact your nearest Sony dealer or local authorised Sony service facility and give the error code.
- ➔ When “TEM ERR” appears, place the player in a location with adequate ventilation to prevent heat build-up in the player.

The player does not respond to any button.

- ➔ Moisture has condensed inside the player (page 3).
- ➔ Hold down **I/⏻** on the player for more than 10 seconds until the player enters standby mode.
If the player still does not respond to any button, disconnect then reconnect the mains lead.

Specifications

System

Laser: Semiconductor laser

Inputs and outputs

(Jack name:

Jack type/Output level/Load impedance)

LINE OUT R-AUDIO-L:

Phono jack/2 V_{rms}/10 kilohms

DIGITAL OUT (COAXIAL):

Phono jack/0.5 V_{p-p}/75 ohms

HDMI OUT:

HDMI 19-pin standard connector

COMPONENT VIDEO OUT (Y, P_B, P_R):

Phono jack/Y: 1.0 V_{p-p}/

P_B, P_R: 0.7 V_{p-p}/75 ohms

LINE OUT VIDEO:

Phono jack/1.0 V_{p-p}/75 ohms

LAN (100):

100BASE-TX Terminal

USB:

USB jack Type A (For connecting a USB memory, memory card reader, digital still camera, and digital video camera)

General

Power requirements:

220–240V AC, 50/60Hz

Power consumption:

16 W

Dimensions (approx.):

430 mm × 199 mm × 36 mm
(width/depth/height) incl. projecting parts

Mass (approx.):

1.6 kg

Operating temperature:

5 °C to 35 °C

Operating humidity:

25 % to 80 %

Supplied accessories

- Remote commander (remote) (1)
- R6 (size AA) batteries (2)

Specifications and design are subject to change without notice.

Notes About the Discs

- To keep the disc clean, handle the disc by its edge. Do not touch the surface. Dust, fingerprints, or scratches on the disc may cause it to malfunction.



- Do not expose the disc to direct sunlight or heat sources such as hot air ducts, or leave it in a car parked in direct sunlight as the temperature may rise considerably inside the car.
- After playing, store the disc in its case.
- Clean the disc with a cleaning cloth. Wipe the disc from the centre out.



- Do not use solvents such as benzene, thinner, commercially available disc/lens cleaners, or anti-static spray intended for vinyl LPs.
- If you have printed the disc's label, dry the label before playing.
- Do not use the following discs.
 - A lens cleaning disc.
 - A disc that has a non-standard shape (e.g., card, heart).
 - A disc with a label or sticker on it.
 - A disc that has cellophane tape or sticker adhesive on it.
- Do not resurface the playing side of a disc to remove surface scratches.

Playable discs

Blu-ray Disc *1	BD-ROM BD-R*2/BD-RE*2
DVD *3	DVD-ROM DVD-R/DVD-RW DVD+R/DVD+RW
CD *3	CD-DA (Music CD) CD-ROM CD-R/CD-RW

*1 Since the Blu-ray Disc specifications are new and evolving, some discs may not be playable depending on the disc type and the version. The audio output differs depending on the source, connected output jack, and selected audio settings.

*2 BD-RE: Ver.2.1

BD-R: Ver.1.1, 1.2, 1.3 including organic pigment type BD-R (LTH type)

The BD-Rs recorded on a PC cannot be played if postscripts are recordable.

*3 A CD or DVD disc will not play if it has not been correctly finalised. For more information, refer to the instruction manual supplied with the recording device.

Discs that cannot be played

- BDs with cartridge
- BDXLs
- DVD-RAMs
- HD DVDs
- DVD Audio discs
- PHOTO CDs
- Data part of CD-Extras
- VCDs/Super VCDs
- Audio material side on DualDiscs

Note on Discs

This product is designed to playback discs that conform to the Compact Disc (CD) standard. DualDiscs and some of the music discs encoded with copyright protection technologies do not conform to the Compact Disc (CD) standard, therefore, these discs may not be playable by this product.

Note on playback operations of BDs/DVDs

Some playback operations of BDs/DVDs may be intentionally set by software producers. Since this player plays BDs/DVDs according to the disc contents the software producers designed, some playback features may not be available.

Note about double-layer BDs/DVDs

The playback pictures and sound may be momentarily interrupted when the layers switch.

Region code (BD-ROM/DVD VIDEO only)

Your player has a region code printed on the rear of the unit and will only play BD-ROMs/DVD VIDEOS labelled with identical region codes or .

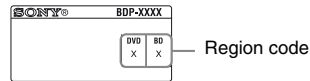

Playable types of files

Video

File format	Extensions
MPEG-1 Video/PS*1	“.mpg,” “.mpeg,”
MPEG-2 Video/PS, TS*1	“.m2ts,” “.mts”
MPEG-4 AVC*1	“.mkv,” “.mp4,” “.m4v,” “.m2ts,” “.mts”
WMV9*1	“.wmv,” “.asf”
AVCHD	*2
Xvid	“.avi”

Music

File format	Extensions
MP3 (MPEG-1 Audio Layer III)	“.mp3”
AAC*1*3	“.m4a”
WMA9 Standard*1*3	“.wma”
LPCM	“.wav”

Photo

File format	Extensions
JPEG	“.jpg,” “.jpeg”

*1 The player does not play coded files such as DRM.

*2 The player plays AVCHD format files that are recorded on a digital video camera, etc. The AVCHD format disc will not play if it has not been correctly finalised.

*3 The player does not play coded files such as Lossless.



- Some files may not play depending on the format, the encoding, or recording condition.
- Some files edited on a PC may not play.
- The player can recognise the following files or folders in BDs, DVDs, CDs and USB devices:
 - up to folders in the 5th tree
 - up to 500 files in a single tree
- Some USB devices may not work with this player.
- The player can recognise Mass Storage Class (MSC) devices (such as flash memory or an HDD) and Still Image Capture Device (SICD) class devices.
- To avoid data corruption or damage to the USB memory or devices, turn the player off when connecting or removing the USB memory or devices.
- The player may not play high bit rate video files on DATA CDs smoothly. You are recommended to play such files using DATA DVDs.

About wireless LAN security

Since communication via the wireless LAN function is established by radio waves, the wireless signal may be susceptible to interception. To protect wireless communication, this player supports various security functions. Be sure to correctly configure the security settings in accordance with your network environment.

◆ No Security

Although you can easily make settings, anyone can intercept wireless communication or intrude into your wireless network, even without any sophisticated tools. Keep in mind that there is a risk of unauthorised access or interception of data.

◆ WEP

WEP applies security to communications to prevent outsiders from intercepting communications or intruding into your wireless network. WEP is a legacy security technology that enables older devices, which do not support TKIP/AES, to be connected.

◆ WPA-PSK (TKIP), WPA2-PSK (TKIP)

TKIP is a security technology developed to correct for the deficiencies of WEP. TKIP assures a higher security level than WEP.

◆ WPA-PSK (AES), WPA2-PSK (AES)

AES is a security technology that uses an advanced security method that is distinct from WEP and TKIP.

AES assures a higher security level than WEP or TKIP.

Code numbers of controllable TVs

While holding down **-TV- I/O**, enter the TV manufacturer's code using the number buttons.

If more than one code number is listed, try entering them one at a time until you find the one that works with your TV.

Manufacturer	Code number
Sony	01 (default)
Hitachi	24
LG/Goldstar	76
Loewe	45
Panasonic	17, 49
Philips	06, 08, 72
Samsung	71
Sharp	29
Toshiba	38

Language code list

For details, see [BD/DVD Viewing Settings] (page 17).

The language spellings conform to the ISO 639: 1988 (E/F) standard.

Code Language

1027	Afar	1261	Japanese
1028	Abkhazian	1269	Yiddish
1032	Afrikaans	1283	Javanese
1039	Amharic	1287	Georgian
1044	Arabic	1297	Kazakh
1045	Assamese	1298	Greenlandic;
1051	Aymara		Kalaallisut
1052	Azerbaijani	1299	Cambodian;
1053	Bashkir		Khmer
1057	Byelorussian	1300	Kannada
1059	Bulgarian	1301	Korean
1060	Bihari	1305	Kashmiri
1061	Bislama	1307	Kurdish
1066	Bengali	1311	Kirghiz
1067	Tibetan	1313	Latin
1070	Breton	1326	Lingala
1079	Catalan	1327	Laothian; Lao
1093	Corsican	1332	Lithuanian
1097	Czech	1334	Latvian
1103	Welsh	1345	Malagasy
1105	Danish	1347	Maori
1109	German	1349	Macedonian
1130	Bhutani;	1350	Malayalam
	Dzongkha	1352	Mongolian
1142	Greek	1353	Moldavian
1144	English	1356	Marathi
1145	Esperanto	1357	Malay
1149	Spanish	1358	Maltese;
1150	Estonian		Maltese
1151	Basque	1363	Burmese
1157	Persian	1365	Nauru
1165	Finnish	1369	Nepali
1166	Fiji	1376	Dutch
1171	Faroese	1379	Norwegian
1174	French	1393	Occitan
1181	Frisian	1403	Oromo
1183	Irish	1408	Oriya
1186	Scots Gaelic	1417	Punjabi;
1194	Galician		Panjabi
1196	Guarani	1428	Polish
1203	Gujarati	1435	Pashto; Pushto
1209	Hausa	1436	Portuguese
1217	Hindi	1463	Quechua
1226	Croatian	1481	Rhaeto-
1229	Hungarian		Romance
1233	Armenian	1482	Kirundi; Rundi
1235	Interlingua	1483	Romanian
1239	Interlingue	1489	Russian
1245	Inupiak	1491	Kinyarwanda
1248	Indonesian	1495	Sanskrit
1253	Icelandic	1498	Sindhi
1254	Italian	1501	Sangho;
1257	Hebrew		Sango

Code Language

1502	Serbo-	1531	Turkmen
	Croatian	1532	Tagalog
1503	Singhalese;	1534	Setswana;
	Sinhalese		Tswana
1505	Slovak	1535	Tonga; Tonga
1506	Slovenian		islands
1507	Samoan	1538	Turkish
1508	Shona	1539	Tsonga
1509	Somali	1540	Tatar
1511	Albanian	1543	Twí
1512	Serbian	1557	Ukrainian
1513	Siswati; Swati	1564	Urdu
1514	Sesotho;	1572	Uzbek
	Sotho southern	1581	Vietnamese
1515	Sundanese	1587	Volapük
1516	Swedish	1613	Wolof
1517	Swahili	1632	Xhosa
1521	Tamil	1665	Yoruba
1525	Telugu	1684	Chinese
1527	Tajik	1697	Zulu
1528	Thai	1703	Not specified
1529	Tigrinya		

Parental control/area code

For details, see [Parental Control Area Code] (page 17).

Code Area

2044, Argentina	2333, Luxembourg
2047, Australia	2363, Malaysia
2046, Austria	2362, Mexico
2057, Belgium	2376, Netherlands
2070, Brazil	2390, New Zealand
2090, Chile	2379, Norway
2092, China	2427, Pakistan
2093, Colombia	2424, Philippines
2115, Denmark	2428, Poland
2165, Finland	2436, Portugal
2174, France	2489, Russia
2109, Germany	2501, Singapore
2200, Greece	2149, Spain
2219, Hong Kong	2499, Sweden
2248, India	2086, Switzerland
2238, Indonesia	2543, Taiwan
2239, Ireland	2528, Thailand
2254, Italy	2184, United
2276, Japan	Kingdom
2304, Korea	

Index

Symbols

♡ (favourites) 8

A

AUDIO 7
Audio Settings 16
Auto Standby 18

B

BD/DVD Viewing
Settings 17
BD-LIVE 12
BD-R 24
BD-RE 24
Bitstream 20
Blu-ray Disc 24
BONUSVIEW 12
BRAVIA Internet Video
13
BRAVIA Sync 21

C

Child Lock 6, 22
Colour buttons 7
Connecting
AV amplifier
(Receiver) 10
Network 11
TV 9
Control for HDMI 18, 21

D

Deep Colour 16
Dimmer 18
DISPLAY 8
Dolby Digital 16
DTS 16

E

Easy Setup 11, 19

H

HDMI 16
HDMI: Linked to TV-off
18, 22
HOME 7
Home menu 15

I

Internet content 8, 13
IP Content Noise
Reduction 14

L

Language Follow 18

M

MAC address 18

N

Network Settings 18
Network Update 15

O

One-Touch Play 18
OPTIONS 7
OSD 18

P

Parental Control 17
Parental Control Settings
17
Play information 12
Playable discs 24
POP UP/MENU 7

Q

Quick Start Mode 18

R

Region code 24
Remote 7
Resetting 19
Resetting the player 19
Resume 8, 22

S

Screen Settings 15
Setup 15
Software update 15, 18
SUBTITLE 7
System Power-Off 18
System Settings 18

T

TOP MENU 7
Troubleshooting 20
TV Type 15

U

Update 15
USB 13

W

WEP 25
WPA2-PSK (AES) 25
WPA2-PSK (TKIP) 25
WPA-PSK (AES) 25
WPA-PSK (TKIP) 25

Free Manuals Download Website

<http://myh66.com>

<http://usermanuals.us>

<http://www.somanuals.com>

<http://www.4manuals.cc>

<http://www.manual-lib.com>

<http://www.404manual.com>

<http://www.luxmanual.com>

<http://aubethermostatmanual.com>

Golf course search by state

<http://golfingnear.com>

Email search by domain

<http://emailbydomain.com>

Auto manuals search

<http://auto.somanuals.com>

TV manuals search

<http://tv.somanuals.com>