

# ***DVD Home Theatre System***

---

Operating Instructions



*Digital Audio Broadcasting*

***MP3***



***DAV-DZ210D***

## WARNING

**To reduce the risk of fire or electric shock, do not expose this apparatus to rain or moisture.**

Do not install the appliance in a confined space, such as a bookcase or built-in cabinet.

To prevent fire, do not cover the ventilation of the apparatus with news papers, table-cloths, curtains, etc. And don't place lighted candles on the apparatus.

To prevent fire or shock hazard, do not place objects filled with liquids, such as vases, on the apparatus.



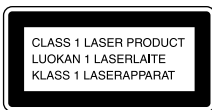

Don't throw away the battery with general house waste, dispose of it correctly as chemical waste.



This appliance is classified as a CLASS 1 LASER product. This marking is located on the rear or bottom exterior.

### NOTICE FOR THE CUSTOMERS IN THE UNITED KINGDOM

A moulded plug complying with BS1363 is fitted to this equipment for your safety and convenience.

Should the fuse in the plug supplied need to be replaced, a fuse of the same rating as the supplied one and approved by ASTA or BSI to BS1362, (i.e., marked with mark  or  mark) must be used.

If the plug supplied with this equipment has a detachable fuse cover, be sure to attach the fuse cover after you change the fuse. Never use the plug without the fuse cover.

If you should lose the fuse cover, please contact your nearest Sony service station.

## Precautions

### Safety

- If anything falls into the cabinet, unplug the unit and have it checked by qualified personnel before operating it any further.
- The unit is not disconnected from the AC power source (mains) as long as it is connected to the wall outlet (mains), even if the unit itself has been turned off.
- Unplug the unit from the wall outlet if you do not intend to use it for an extended period of time. To disconnect the cord, pull it out by the plug, never by the cord.

## Installing

- Allow adequate air circulation to prevent internal heat buildup.
- Do not place the unit on surfaces (rugs, blankets, etc.) or near materials (curtains, draperies) that may block the ventilation slots.
- Do not install the unit near heat sources such as radiators, or air ducts, or in a place subject to direct sunlight, excessive dust, mechanical vibration, or shock.
- Do not install the unit in an inclined position. It is designed to be operated in a horizontal position only.
- Keep the unit and discs away from equipment with strong magnets, such as microwave ovens, or large loudspeakers.
- Do not place heavy objects on the unit.
- If the unit is brought directly from a cold to a warm location, moisture may condense inside the DVD Home Theatre System and cause damage to the lenses. When you first install the unit, or when you move it from a cold to a warm location, wait for about 30 minutes before operating the unit.



### Disposal of Old Electrical & Electronic Equipment (Applicable in the European Union and other European countries with separate collection systems)

This symbol on the product or on its packaging indicates that this product shall not be treated as household waste. Instead it shall be handed over to the applicable collection point for the recycling of electrical and electronic equipment. By ensuring this product is disposed of correctly, you will help prevent potential negative consequences for the environment and human health, which could otherwise be caused by inappropriate waste handling of this product. The recycling of materials will help to conserve natural resources. For more detailed information about recycling of this product, please contact your local city office, your household waste disposal service or the shop where you purchased the product.

## Welcome!

Thank you for purchasing Sony DVD Home Theatre System. Before operating this system, please read this manual thoroughly and retain it for future reference.

# Table of Contents

Welcome! .....	2	Playing in Random Order .....	36
About This Manual .....	5	(Shuffle Play)	
Overview of DAB .....	5	Playing Repeatedly .....	37
This System Can Play the Following		(Repeat Play)	
Discs .....	6	Using the DVD's Menu .....	38
<b>Getting Started – BASIC –</b>		Changing the Sound.....	38
<b>Step 1: Connecting the System and</b>		Selecting [ORIGINAL] or [PLAY LIST]	
<b>TV .....</b>	<b>10</b>	on a DVD-R/DVD-RW .....	40
<b>Step 2: Positioning the System... 15</b>		Viewing Information About	
<b>Step 3: Performing the Quick</b>		the Disc.....	40
<b>Setup.....</b>	<b>16</b>	Changing the Angles .....	42
<b>Getting Started – ADVANCED –</b>		Displaying the Subtitles.....	43
Turning off the Demonstration .....	19	Adjusting the Delay Between the Picture	
Installing the Speakers on a Wall.....	20	and Sound.....	43
TV Hookup (Advanced) .....	21	(A/V SYNC)	
Other Component Hookup.....	24	About MP3 Audio Tracks and JPEG	
<b>Basic Operations</b>		Image Files .....	44
<b>Playing Discs .....</b>	<b>25</b>	Playing DATA CDs or DATA DVDs with	
<b>Enjoying the Radio or Other</b>		MP3 Audio Tracks and JPEG Image	
<b>Components.....</b>	<b>26</b>	Files .....	45
<b>Enjoying TV Sound from All</b>		Playing Audio Tracks and Images as a	
<b>Speakers.....</b>	<b>27</b>	Slide Show with Sound .....	47
<b>Selecting the Movie or Music</b>		Playing VIDEO CDs with PBC Functions	
<b>Mode .....</b>	<b>28</b>	(Ver.2.0) .....	49
<b>Sound Adjustments</b>		(PBC Playback)	
Enjoying Surround Sound by Using Sound		<b>Tuner Functions</b>	
Field .....	29	Presetting Radio Stations.....	50
<b>Various Functions for Playing</b>		Listening to the Radio.....	50
<b>Discs</b>		Using the Radio Data System (RDS) ...	52
Searching for a Particular Point		Receiving DAB Stations.....	52
on a Disc .....	31	<b>Other Operations</b>	
(Scan, Slow-motion Play, Freeze		Controlling the TV with the Supplied	
Frame)		Remote .....	55
Searching for a Title/Chapter/Track/		Using the THEATRE SYNC	
Scene, etc. ....	32	Function.....	55
Searching by Scene .....	33	Using the Sound Effect.....	56
(Picture Navigation)		Using the Sleep Timer .....	57
Resuming Playback from the Point Where		Changing the Brightness of the Front	
You Stopped the Disc .....	33	Panel Display.....	57
(Resume Play)			
Creating Your Own Program .....	34		
(Program Play)			

# Advanced Settings and Adjustments

- Locking Discs ..... 58  
(CUSTOM PARENTAL CONTROL, PARENTAL CONTROL)
- Getting Optimal Surround Sound for a Room ..... 61  
(SPEAKER FORMATION)
- Calibrating the Appropriate Settings Automatically ..... 63  
(AUTO CALIBRATION)
- Using the Setup Display..... 65
- Setting the Display or Sound Track Language ..... 67  
[LANGUAGE SETUP]
- Settings for the Display ..... 67  
[SCREEN SETUP]
- Custom Settings ..... 69  
[CUSTOM SETUP]
- Settings for the Speakers..... 70  
[SPEAKER SETUP]
- Returning to the Default Settings..... 72

## Additional Information

- Precautions ..... 73
- Notes about the Discs..... 74
- Troubleshooting ..... 74
- Self-diagnosis Function ..... 78  
(When letters/numbers appear in the display)
- Specifications ..... 78
- Glossary ..... 80
- Language Code List ..... 83
- Index to Parts and Controls ..... 84
- Guide to the Control Menu Display ..... 86
- DVD Setup Display List ..... 89
- AMP Menu List ..... 90
- Index ..... 91

## About This Manual

- The instructions in this manual describe the controls on the remote. You can also use the controls on the system if they have the same or similar names as those on the remote.
- The Control Menu items may be different depending on the area.
- “DVD” may be used as a general term for DVD VIDEOS, DVD+RWs/DVD+Rs, and DVD-RWs/DVD-Rs.
- Measurements are expressed in feet (ft) for North American models.
- The following symbols are used in this manual.

Symbol	Meaning
<b>DVD-V</b>	Functions available for DVD VIDEOS, DVD-Rs/DVD-RWs in video mode, and DVD+Rs/DVD+RWs
<b>DVD-VR</b>	Functions available for DVD-Rs/DVD-RWs in VR (Video Recording) mode
<b>VIDEO CD</b>	Functions available for VIDEO CDs (including Super VCDs or CD-Rs/CD-RWs in video CD format or Super VCD format)
<b>CD</b>	Functions available for music CDs or CD-Rs/CD-RWs in music CD format
<b>DATA-CD</b>	Functions available for DATA CDs (CD-ROMs/CD-Rs/CD-RWs) containing MP3* audio tracks and JPEG image files
<b>DATA DVD</b>	Functions available for DATA DVDs (DVD-ROMs/DVD-Rs/DVD-RWs/DVD+Rs/DVD+RWs) containing MP3* audio tracks, JPEG image files

- \* MP3 (MPEG1 Audio Layer 3) is a standard format defined by ISO/MPEG which compresses audio data.

## Overview of DAB

DAB (Digital Audio Broadcasting) is a new multimedia broadcasting system that replaces the current FM/AM broadcast to transmit audio programs with a quality comparable to that of CDs\*.

Each DAB multiplex radio station converts programs (services) into an ensemble, which it then broadcasts. Each service contains one or more components. All services and components are identified by name, so you can access any of them without having to know their frequencies. Furthermore, additional information (called program associated data) can be broadcast along with the services in the form of text.

### With DAB digital radio, you can enjoy:

- CD sound quality without any hiss or crackle to spoil the sound\*
- both music and data services from a single tuner (this tuner does not support data services)
- the same radio stations of the same frequency from anywhere in the country
- multiple programs (services) from a single frequency

\* Some service components may not match CD quality sound.

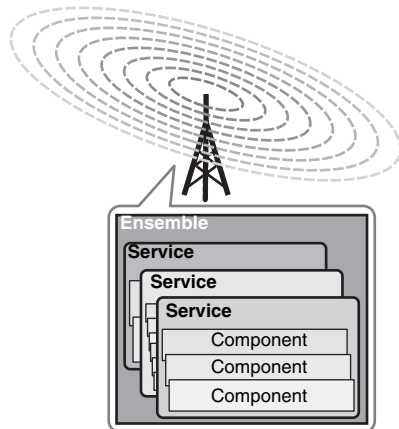





### Note

- The status of the DAB broadcast depends on your country or region. It may not be broadcasted or may be in test phase.

continued

- DAB programs are broadcast in Band-III (174 to 240 MHz) and/or L-Band (1452 to 1491 MHz), with each band divided into channels. Each of these channels has its own channel label. For details on the channel labels and frequencies that this tuner supports, see the Frequency Table on page 79.
- This tuner supports Band-III only.
- This tuner does not support data services.
- This tuner supports reception in the United Kingdom and Scandinavian countries.
- This system cannot display certain characters in the front panel display.

## This System Can Play the Following Discs

Format of discs	Disc logo
DVD VIDEO	
DVD-RW/ DVD-R	
DVD+RW/ DVD+R	
VIDEO CD (Ver. 1.1 and 2.0 discs)/ Audio CD	
CD-RW/CD-R (audio data) (MP3 files) (JPEG files)	

“DVD+RW,” “DVD-RW,” “DVD+R,”  
“DVD VIDEO,” and the “CD” logos are trademarks.

### Note about CDs/DVDs

The system can play CD-ROMs/CD-Rs/CD-RWs recorded in the following formats:

- audio CD format
- video CD format
- MP3 audio tracks and JPEG image files of format conforming to ISO 9660 Level 1/ Level 2, or its extended format, Joliet

The system can play DVD-ROMs/DVD+RWs/DVD-RWs/DVD+Rs/DVD-Rs recorded in the following formats:

- MP3 audio tracks, JPEG image files of format conforming to UDF (Universal Disc Format)

---

## Example of discs that the system cannot play

The system cannot play the following discs:

- CD-ROMs/CD-Rs/CD-RWs other than those recorded in the formats listed on page 6
- CD-ROMs recorded in PHOTO CD format
- Data part of CD-Extras
- DVD Audios
- Super Audio CD
- DATA DVDs that do not contain MP3 audio tracks or JPEG image files.
- DVD-RAMs

Also, the system cannot play the following discs:

- A DVD VIDEO with a different region code (page 7, 81)
- A disc that has a non-standard shape (e.g., card, heart)
- A disc with paper or stickers on it
- A disc that has the adhesive of cellophane tape or a sticker still left on it

## Notes about CD-R/CD-RW/DVD-R/DVD-RW/DVD+R/DVD+RW

In some cases, CD-R/CD-RW/DVD-R/DVD-RW/DVD+R/DVD+RW cannot be played on this system due to the recording quality or physical condition of the disc, or the characteristics of the recording device and authoring software.

The disc will not play if it has not been correctly finalized. For more information, see the operating instructions for the recording device. Note that some playback functions may not work with some DVD+RWs/DVD+Rs, even if they have been correctly finalized. In this case, view the disc by normal playback. Also some DATA CDs/DATA DVDs created in Packet Write format cannot be played.

## Music discs encoded with copyright protection technologies

This product is designed to play back discs that conform to the Compact Disc (CD) standard. Recently, various music discs encoded with copyright protection technologies are marketed by some record companies. Please be aware that among those discs, there are some that do not conform to the CD standard and may not be playable by this product.

### Note on DualDisc

A DualDisc is a two sided disc product which mates DVD recorded material on one side with digital audio material on the other side. However, since the audio material side does not conform to the Compact Disc (CD) standard, playback on this product is not guaranteed.

---

## About Multi Session CD

- This system can play Multi Session CDs when an MP3 audio track is contained in the first session. Any subsequent MP3 audio tracks recorded in later sessions can also be played back.
- This system can play Multi Session CDs when a JPEG image file is contained in the first session. Any subsequent JPEG image files recorded in later sessions can also be played back.
- If audio tracks and images in music CD format or video CD format are recorded in the first session, only the first session will be played back.

---

## Region code

Your system has a region code printed on the bottom exterior and will only play DVDs labeled with the same region code.

DVD VIDEOS labeled  will also play on this system.

If you try to play any other DVD VIDEO, the message [Playback prohibited by area limitations.] will appear on the TV screen. Depending on the DVD VIDEO, no region code

*continued*

indication may be given even though playing the DVD VIDEO is prohibited by area restrictions.

---

## **Note on playback operations of DVDs and VIDEO CDs**

Some playback operations of DVDs and VIDEO CDs may be intentionally set by software producers. Since this system plays DVDs and VIDEO CDs according to the disc contents the software producers designed, some playback features may not be available. Also, refer to the instructions supplied with the DVDs or VIDEO CDs.

---

## **Copyrights**

This product incorporates copyright protection technology that is protected by U.S. patents and other intellectual property rights. Use of this copyright protection technology must be authorized by Macrovision, and is intended for home and other limited viewing uses only unless otherwise authorized by Macrovision. Reverse engineering or disassembly is prohibited.

This system incorporates with Dolby\* Digital and Dolby Pro Logic (II) adaptive matrix surround decoder and the DTS\*\* Digital Surround System.

- \* Manufactured under license from Dolby Laboratories.  
“Dolby”, “Pro Logic”, and the double-D symbol are trademarks of Dolby Laboratories.
- \*\* Manufactured under license from Digital Theater Systems, Inc.  
“DTS” and “DTS Digital Surround” are registered trademarks of Digital Theater Systems, Inc.



See Unpacking in Specifications, page 78.

### Inserting batteries into the remote

You can control the system using the supplied remote. Insert two R6 (size AA) batteries by matching the ⊕ and ⊖ ends on the batteries to the markings inside the compartment. When using the remote, point it at the remote sensor  on the system.

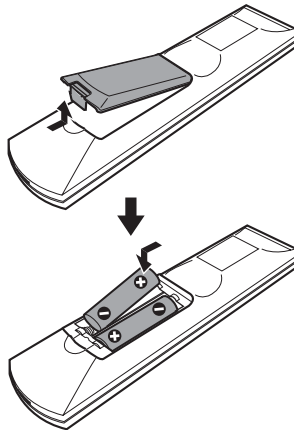

#### Note

- Do not leave the remote in an extremely hot or humid place.
- Do not use a new battery with an old one.
- Do not drop any foreign object into the remote casing, particularly when replacing the batteries.
- Do not expose the remote sensor to direct light from the sun or lighting apparatus. Doing so may cause a malfunction.
- If you do not intend to use the remote for an extended period of time, remove the batteries to avoid possible damage from battery leakage and corrosion.

### Attaching the foot pads to the subwoofer

Attach the supplied foot pads to the bottom of the subwoofer to stabilize the subwoofer and prevent it from slipping.

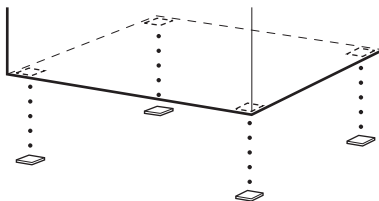

## Step 1: Connecting the System and TV

This hookup is the basic connection of the system to the speakers and TV. For other TV connections, see page 21. For other component connection, see page 24.

To accept progressive signals, see page 22.

Refer to the connection diagram below, and read the additional information from ① to ④ on the following pages.

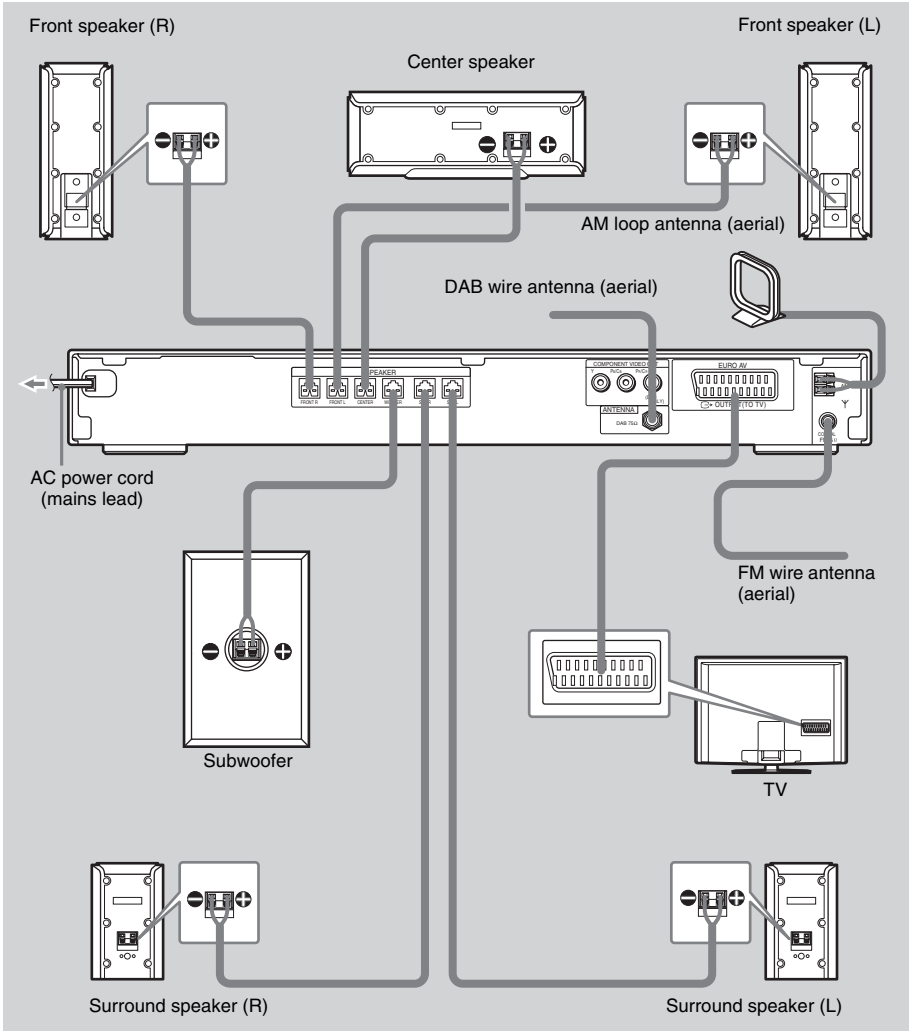

## ① Connecting the Speakers

### Required cords

The connector and color tube of the speaker cords are the same color as the label of the jacks to be connected.

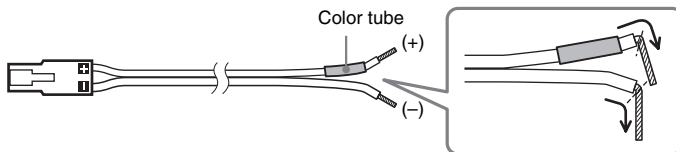

#### Note

- Do not catch the speaker cord insulation in the SPEAKER jack.

### To avoid short-circuiting the speakers

Short-circuiting of the speakers may damage the system. To prevent this, be sure to follow these precautions when connecting the speakers. Make sure the bare wire of each speaker cord does not touch another speaker terminal or the bare wire of another speaker cord, such as shown below.

Stripped speaker cord is touching another speaker terminal.

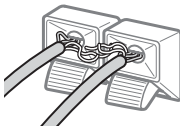

Stripped cords are touching each other due to excessive removal of insulation.

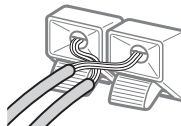

After connecting all the components, speakers, and AC power cord (mains lead), output a test tone to check that all the speakers are connected correctly. For details on outputting a test tone, see page 71. If no sound is heard from a speaker while outputting a test tone, or a test tone is output from a speaker other than the one currently displayed on the Setup Display, the speaker may be short-circuited. If this happens, check the speaker connection again.

#### Note

- Be sure to match the speaker cord to the appropriate terminal on the components: ⊕ to ⊕, and ⊖ to ⊖. If the cords are reversed, the sound will lack bass and may be distorted.

## ② Connecting the TV

### Required cords

#### SCART (EURO AV) cord (not supplied)

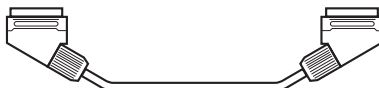

Be sure to connect the SCART (EURO AV) cord to the EURO AV  $\rightarrow$  OUTPUT (TO TV) jack on the system.

When you connect using the SCART (EURO AV) cord, check that the TV conforms to S video or RGB signals. If the TV conforms to S video, change the input mode of the TV to RGB signals. Refer to the operating instructions supplied with the TV to be connected.

**continued**

**Tip**

- When you want to output the TV sound or stereo sound of a 2 channel source from the 6 speakers, select the “Dolby Pro Logic,” “Dolby Pro Logic II MOVIE,” or “Dolby Pro Logic II MUSIC” sound field (page 29).

### ③ Connecting the Antenna (Aerial)

#### To connect the AM antenna (aerial)

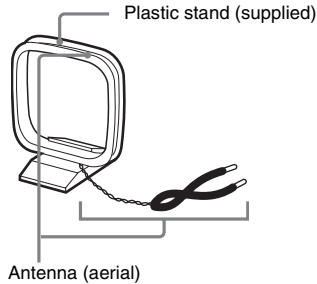

The shape and the length of the antenna (aerial) is designed to receive AM signals. Do not dismantle or roll up the antenna (aerial).

- 1 Remove only the loop part from the plastic stand.**
- 2 Set up the AM loop antenna (aerial).**

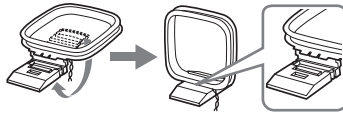

- 3 Connect the cords to the AM antenna (aerial) terminals.**

Cord (A) or cord (B) can be connected to either terminal.

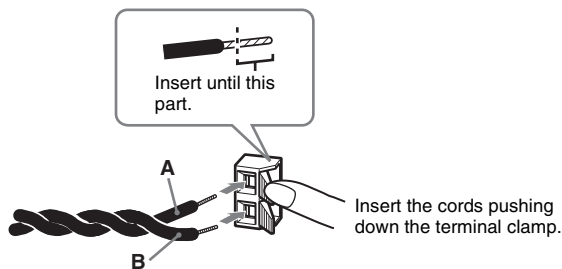
**Note**

- Do not place the AM loop antenna (aerial) near the system or other AV equipment, as noise may result.

**Tip**

- Adjust the direction of the AM loop antenna (aerial) for best AM broadcast sound.

- 4 Make sure the AM loop antenna (aerial) is connected firmly by pulling softly.**

## To connect the FM wire antenna (aerial)

Connect the FM wire antenna (aerial) to the COAXIAL FM 75  $\Omega$  jack.

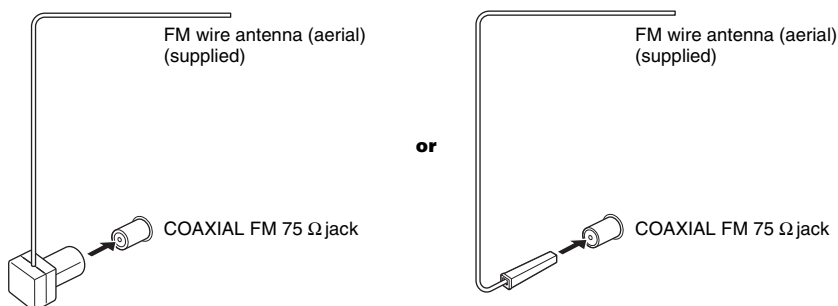

### Note

- Be sure to fully extend the FM wire antenna (aerial).
- After connecting the FM wire antenna (aerial), keep it as horizontal as possible.

### Tip

- If you have poor FM reception, use a 75-ohm coaxial cable (not supplied) to connect the system to an outdoor FM antenna (aerial) as shown below.

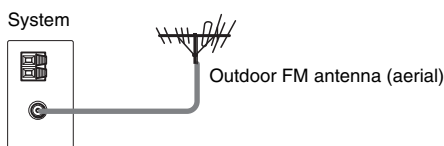

## To connect the DAB wire antenna (aerial)

With a DAB external antenna (aerial), you can obtain higher DAB sound quality. We recommend that you use the supplied DAB wire antenna (aerial) only temporarily until you install a DAB external antenna (aerial).

Connect the supplied DAB wire antenna (aerial) to the ANTENNA DAB 75  $\Omega$  jack on the rear of the unit horizontally. Then turn the supplied DAB wire antenna (aerial) vertically.

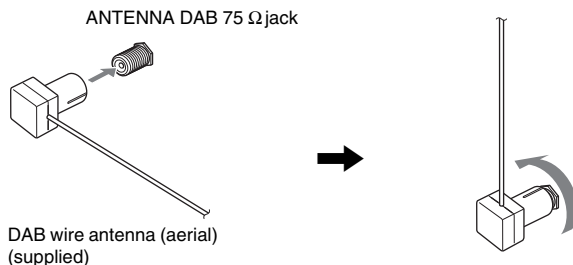

*continued*

13<sup>GB</sup>

Connect a DAB external antenna (aerial) (not supplied) to the ANTENNA DAB 75  $\Omega$  jack on the rear of the unit.

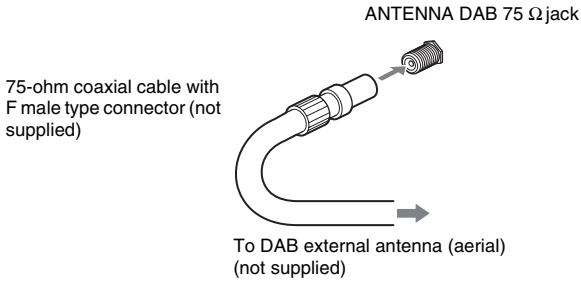
**Tip**

- To install the DAB external antenna (aerial) (not supplied), 75-ohm coaxial cable with F male type connector (not supplied) will be needed.

#### ④ Connecting the AC power cord (mains lead)

Before connecting the AC power cord (mains lead) of this system to a wall outlet (mains), connect the speakers to the system.

Install this system so that the power cord can be unplugged from the wall socket immediately in the event of trouble.

## Step 2: Positioning the System

### Positioning the speakers

For the best possible surround sound, all the speakers other than the subwoofer should be the same distance from the listening position (A). However, this system allows you to place the center speaker up to 1.6 meters (5 ft) closer (B) and the surround speakers up to 5.0 meters (16 ft) closer (C) to the listening position. The front speakers can be placed from 1.0 to 7.0 meters (3 to 23 ft) (A) from the listening position.

Place speakers as illustrated below.

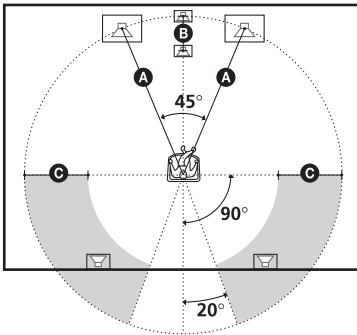

#### Note

- Do not set the speakers in an inclined position.
- Do not place the speakers in locations that are:
  - Extremely hot or cold
  - Dusty or dirty
  - Very humid
  - Subject to vibrations
  - Subject to direct sunlight
- Use caution when placing the speakers and/or speaker stands (not supplied) that are attached with the speakers on a specially treated (waxed, oiled, polished, etc.) floor, as staining or discoloration may result.
- When cleaning, use a soft cloth such as a cleaning cloth for glasses.
- Do not use any type of abrasive pad, scouring powder, or solvent such as alcohol or benzene.

#### Tip

- When you change the positions of the speakers, it is recommended that you change the settings. For details, see “Getting Optimal Surround Sound for a Room” (page 61) and “Calibrating the Appropriate Settings Automatically” (page 63).

## Step 3: Performing the Quick Setup

Follow the steps below to make the minimum number of basic adjustments for using the system.

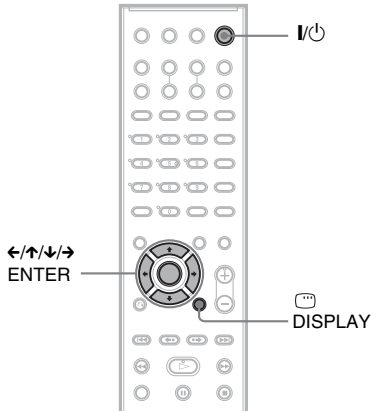

**1** Turn on the TV.

**2** Press I/O.

**Note**

- Disconnect the headphones when you perform the Quick Setup. You cannot operate steps after 12 with the headphones connected.
- Make sure that the function is set to “DVD.”

**3** Switch the input selector on your TV so that the signal from the system appears on the TV screen.

[Press [ENTER] to run QUICK SETUP.] appears at the bottom of the screen. If this message does not appear, display the Quick Setup and perform again (page 18).

**4** Press ENTER without inserting a disc.

The Setup Display for selecting the language used in the on-screen display appears.

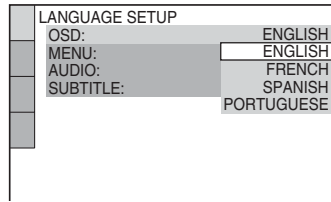

**5** Press ↑/↓ to select a language.

The system displays the menu and subtitles in the selected language.

**6** Press ENTER.

The Setup Display for selecting the aspect ratio of the TV to be connected appears.

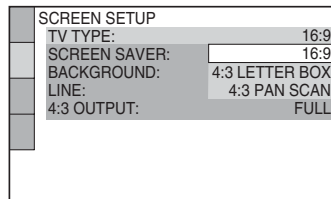

**7** Press ↑/↓ to select the setting that matches your TV type.

■ If you have a 4:3 standard TV [4:3 LETTER BOX] or [4:3 PAN SCAN] (page 67)

■ If you have a wide-screen TV or a 4:3 standard TV with a wide-screen mode [16:9] (page 67)

**8** Press ENTER.

The Setup Display for selecting the output method for video signals from the EURO AV OUTPUT (TO TV) jack on the rear panel of the system appears.

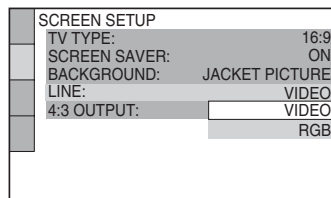

**9** Press ↑/↓ to select the output method for video signals.

- [VIDEO]: outputs video signals.



- [RGB]: outputs RGB signals.

**Note**

- If your TV does not accept RGB signals, no picture appears on the TV screen even if you select [RGB]. Refer to the instructions supplied with your TV.

**10** Press **ENTER**.

The Setup Display for selecting the speaker formation appears.

**11** Press **←/→** to select the speaker formation image as the speakers are actually positioned, then press **ENTER**.

For details, see “Getting Optimal Surround Sound for a Room” (page 61).

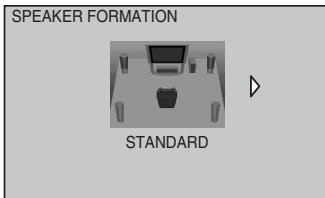
**12** Connect the calibration mic to the **A.CAL MIC** jack on the front panel and press **↑/↓** to select **[YES]**, then press **ENTER**.

Set up the calibration mic at the ear level using a tripod, etc. (not supplied). The front of each speaker should face the calibration mic, and there should be no obstruction between the speakers and the calibration mic. Be quiet during the measurement.

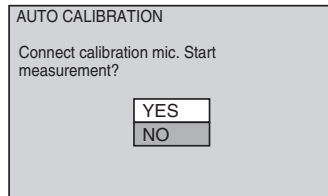
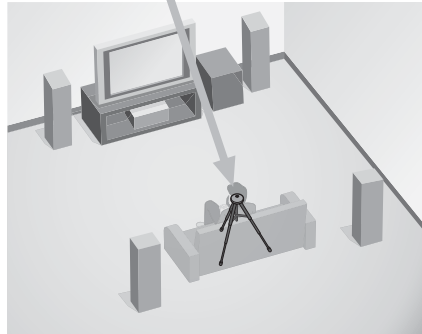
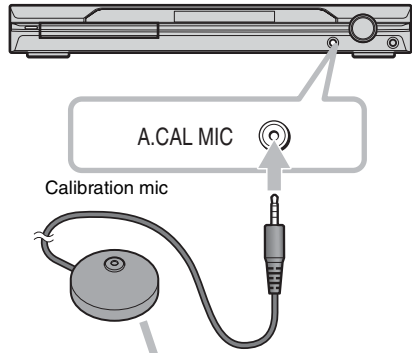

Auto Calibration starts.

**Note**

- Loud test sound is output when [AUTO CALIBRATION] starts. You cannot turn the volume down. Give consideration to children and neighbor.
- Avoid being in the measurement area and making noise during the measurement (which takes about 3 minutes), as it may interfere with measurement.

*continued*

### 13 Unplug the calibration mic and press ←/→ to select [YES].

Quick Setup is finished. All connections and setup operations are complete.

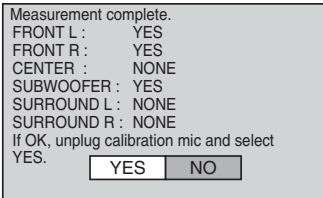

#### Note

- If measurement fails, follow the message then retry [AUTO CALIBRATION].

### To quit the Quick Setup

Press DISPLAY in any Step.

#### Tip

- If you change the position of the speakers, reset the speaker settings. See “Getting Optimal Surround Sound for a Room” (page 61) and “Calibrating the Appropriate Settings Automatically” (page 63).
- If you want to change any of the settings, see “Using the Setup Display” (page 65).

### To recall the Quick Setup display

- 1 Press DISPLAY when the system is in stop mode.

The Control Menu appears.

- 2 Press to select [SETUP], then press ENTER.

The options for [SETUP] appear.

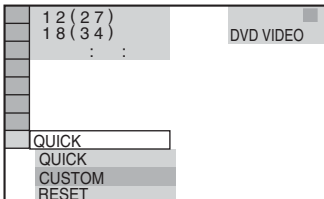

- 3 Press to select [QUICK], then press ENTER.

The Quick Setup display appears.

## Getting Started – ADVANCED –

# Turning off the Demonstration

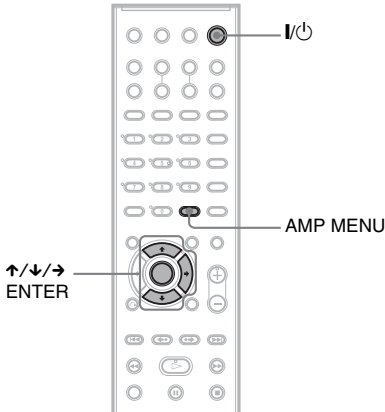

After connecting the AC power cord (mains lead), the demonstration appears in the front panel display. When you press I/⏻ on the remote, the demonstration turns off.

### Note

- When you press I/⏻ on the system, the demonstration does not turn off.
- When you set the demonstration mode in the AMP menu to on, the demonstration does not turn off even though you press I/⏻ on the remote. To turn off the demonstration, set the demonstration mode to off, then press I/⏻ on the remote. When the demonstration mode is set to off, the system saves power in standby mode.

## Setting the demonstration mode on/off

- 1 Press AMP MENU.**
- 2 Press ↑/↓ repeatedly until “DEMO” appears in the front panel display, then press ENTER or →.**
- 3 Press ↑/↓ to select the setting.**
  - DEMO ON: sets the demonstration mode on.

- DEMO OFF: sets the demonstration mode off.

- 4 Press ENTER.**  
The setting is reflected.

- 5 Press AMP MENU.**  
The AMP menu turns off.

# Installing the Speakers on a Wall

- 1 Prepare screws (not supplied) that are suitable for the hole on the back of each speaker. See the illustrations below.**

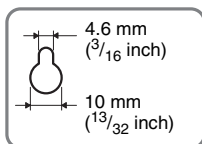
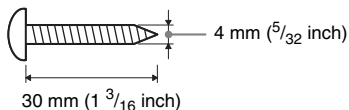

Hole on the back of the speaker

- 2 Fasten the screws to the wall.**

**For the center speaker**

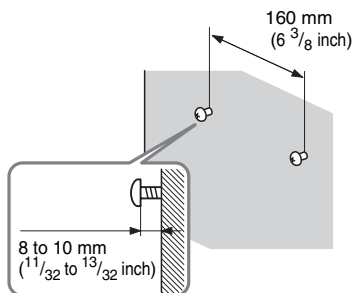

**For the other speakers**

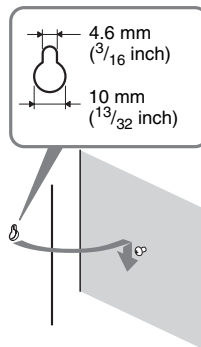
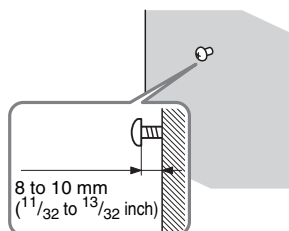

### Note

- Use screws that are suitable for the wall material and strength. As a plaster board wall is especially fragile, attach the screws securely to a beam and fasten them to the wall. Install the speakers on a vertical and flat wall where reinforcement is applied.
- Contact a screw shop or installer regarding the wall material or screws to be used.
- Sony is not responsible for accident or damage caused by improper installation, insufficient wall strength or improper screw installation, natural calamity, etc.

- 3 Hang the speakers on the screws.**

# TV Hookup (Advanced)

Select a hookup suitable for the jacks on your TV.

## Connecting the video cords

Sends a played back DVD image to a TV.

Check the jacks of your TV, and choose connection method **A** or **B**. Picture quality improves in order from **A** (standard) to **B** (component).

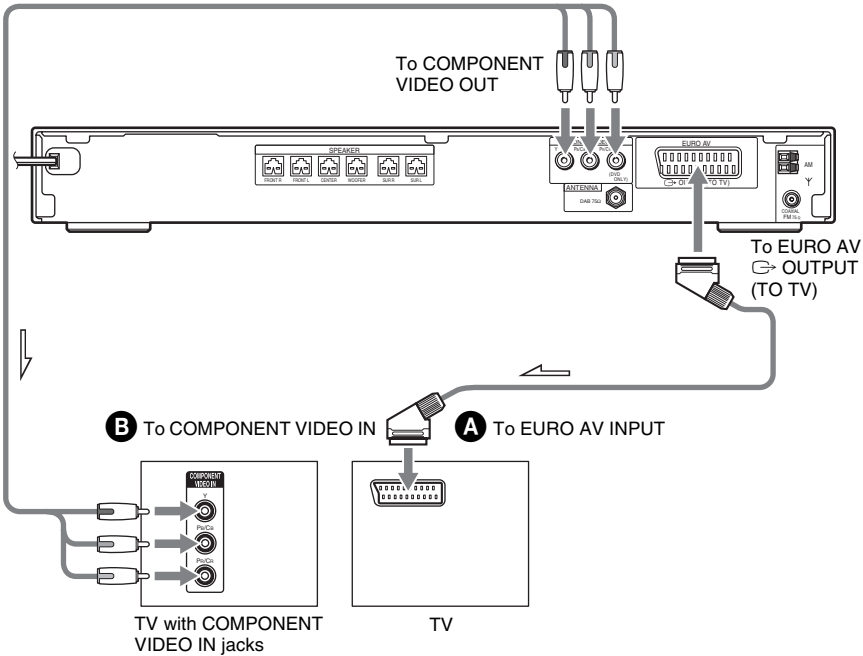

### **A** To connect to a TV with the SCART (EURO AV) cord (not supplied)



Be sure to connect the SCART (EURO AV) cord to the EURO AV  $\rightarrow$  OUTPUT (TO TV) jack on the system.

When you connect using the SCART (EURO AV) cord, check that the TV conforms to S video or RGB signals. If the TV conforms to S video, change the input mode of the TV to RGB signals. Refer to the operating instructions supplied with the TV to be connected.

### **B** To connect to a TV with the COMPONENT VIDEO IN jacks

Connect a component video cord (not supplied). To use the COMPONENT VIDEO OUT jacks (Y, PB/CB, PR/CR), your TV monitor must be equipped with via COMPONENT VIDEO IN jacks (Y, PB/CB,

*continued*

Pr/Cr). If your TV accepts progressive format signals, you must use this connection and set the output channel of the system to progressive format (page 22).



### When connecting to a standard 4:3 screen TV

Depending on the disc, the image may not fit your TV screen.  
To change the aspect ratio, see page 67.

---

## Does your TV accept progressive signals?

Progressive is the method for displaying TV images which reduces flickering, and sharpens the image. To display using this method, you need to connect to a TV that accepts progressive signals.

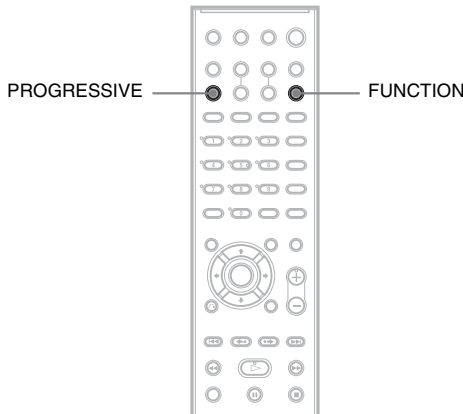

“PROGRE” lights up in the front panel display when the system outputs progressive signals.

- 1 Press FUNCTION repeatedly to select “DVD.”**
- 2 Press PROGRESSIVE.**

Each time you press PROGRESSIVE, the display changes as follows:

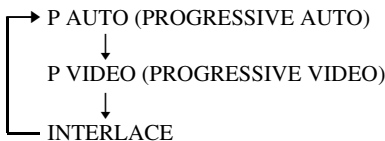

#### ■ P AUTO (PROGRESSIVE AUTO)

Select this setting when:

- your TV accepts progressive signals, and,
- the TV is connected to the COMPONENT VIDEO OUT jacks.

Normally select this under the above condition. This automatically detects the software type, and selects the appropriate conversion method.

Note that the picture will not be clear or no picture will appear if you select these settings when either of the above conditions are not met.

### ■ P VIDEO (PROGRESSIVE VIDEO)

Select this setting when:

- your TV accepts progressive signals, and,
  - the TV is connected to the COMPONENT VIDEO OUT jacks, and,
  - you want to fix the conversion method to PROGRESSIVE VIDEO for video-based software.
- Select this if the image is not clear when you select PROGRESSIVE AUTO.

Note that the picture will not be clear or no picture will appear if you select these settings when either of the above conditions are not met.

### ■ INTERLACE

Select this setting when:

- your TV does not accept progressive signals, or,
- your TV is connected to jacks other than the COMPONENT VIDEO OUT jacks (EURO AV ⇄ OUTPUT (TO TV)).

## About DVD software types and the conversion method

DVD software can be divided into 2 types: film-based software and video-based software.

Video-based software is derived from TV, such as dramas and sit-coms, and displays images at 30 frames/60 fields per second. Film-based software is derived from film and displays images at 24 frames per second. Some DVD software contains both video and film.

In order for these images to appear natural on your screen when output in progressive format, the progressive signals need to be converted to match the type of DVD software that you are watching.

#### Note

- When you play video-based software in progressive signal format, sections of some types of images may appear unnatural due to the conversion process when output through the COMPONENT VIDEO OUT jacks. Even though you set to “PROGRESSIVE AUTO” or “PROGRESSIVE VIDEO,” images from the EURO AV ⇄ OUTPUT (TO TV) jack are unaffected as they are output in the interlace format.
- If you set [LINE] in [SCREEN SETUP] to [RGB] (page 68), the system switches to “INTERLACE.” This will happen even though you select “PROGRESSIVE AUTO” or “PROGRESSIVE VIDEO.”
- If you set [LINE] in [SCREEN SETUP] to [RGB] (page 68), the system outputs no component video signals.

## Other Component Hookup

### Connecting the system and the other component

Outputs the other component through the speakers of this system.

#### To listen to the portable audio source sound through the system

Connect the audio output jacks of the portable audio source to the AUDIO IN jack on the front panel of the system with the stereo mini-plug cord (not supplied).



#### Tip

- When listening to MP3 format recordings using a portable audio source, you can enhance the sound. Press FUNCTION to select "AUDIO." Connect the portable audio source. Press SOUND FIELD repeatedly until "A.F.D. STD" appears in the front panel display. To cancel, select other than "A.F.D. STD."

#### Note

- Be sure to make connections securely to avoid hum and noise.
- When you connect another component with a volume control, turn up the volume of the other component to a level where sound is not distorted.



## Basic Operations

### Playing Discs

DVD-V

DVD-VR

VIDEO CD

C D

DATA-CD

DATA DVD

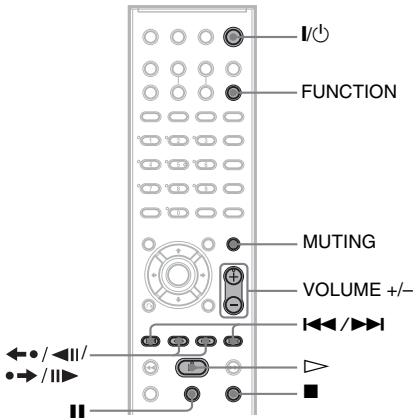
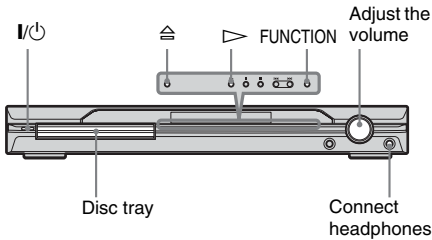

Depending on the DVD VIDEO or VIDEO CD, some operations may be different or restricted. Refer to the operation details supplied with your disc.

- 1 Turn on your TV.**
- 2 Switch the input selector on the TV to this system.**
- 3 Press I/⏻.**  
The system turns on.  
Unless the system is set to "DVD," press FUNCTION to select "DVD."
- 4 Press ⏻.**
- 5 Load a disc.**

Place one disc on the tray, and then press ⏻.

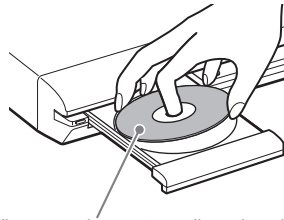

When you play an 8 cm disc, place it on the inner circle of the tray. Be careful that the disc is not skewed on the inner circle of the tray.

#### Note

- Do not forcibly press the disc tray closed with your finger, as this may cause malfunction.
- Do not place more than one disc on the tray.

## 6 Press ▷.

The system starts playback (continuous play).

Adjust the volume on the system.

The volume level appears on the TV screen and in the front panel display.

#### Note

- Depending on the system status, the volume level may not appear on the TV screen.

## To save the power in standby mode

Press I/⏻ while the system turns on. To cancel standby mode, press I/⏻ once.

## Additional operations

To	Press
Stop	■
Pause	⏻
Resume play after pause	⏻ or ▷
Go to the next chapter, track, or scene	▶▶ (except for JPEG)
Go back to the preceding chapter, track, or scene	◀◀ (except for JPEG)
Mute the sound	MUTING. To cancel muting, press it again or VOLUME + to adjust the sound volume.
Stop play and remove the disc	⏻

continued

25 GB

To	Press
Replay the previous scene*	◀•/◀II (instant replay) during playback.
Briefly fast forward the current scene**	•➡/II▶ (instant advance) during playback.

\* DVD VIDEOS/DVD-RWs/DVD-Rs only.

\*\* DVD VIDEOS/DVD-RWs/DVD-Rs/DVD+RWs/DVD+Rs only.

**Note**

- You may not be able to use the Instant Replay or Instant Advance function with some scenes.

## Enjoying the Radio or Other Components

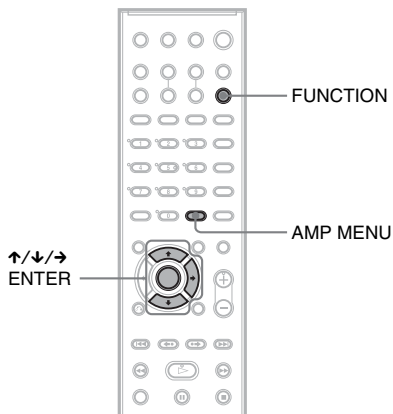

### Selecting the connected component

Each time you press FUNCTION, the mode of the system changes in the following sequence.

DVD → TUNER FM → TUNER AM → DAB  
→ TV → AUDIO → ...

### Changing the input level of the sound from connected components

Distortion may occur when listening to a component connected to the AUDIO IN jack on the front panel. This is not a malfunction and will depend on the component connected. To prevent this, you can change the input level from the sound of the other components.

- 1** Press **FUNCTION** repeatedly until “AUDIO” appears in the front panel display.
- 2** Press **AMP MENU**.
- 3** Press **↑/↓** repeatedly until “ATTENUATE” appears in the front panel display, then press **ENTER** or **→**.

- 4 Press  $\uparrow/\downarrow$  to select a setting.**
- ATT ON: attenuates the input level. The output level is changed.
  - ATT OFF: normal input level.
- 5 Press ENTER.**  
The setting is reflected.
- 6 Press AMP MENU.**  
The AMP menu turns off.

## Enjoying TV Sound from All Speakers

You can enjoy TV sound from all the speakers in this system.

For details, see “TV Hookup (Advanced)” (page 21) and “Other Component Hookup” (page 24).

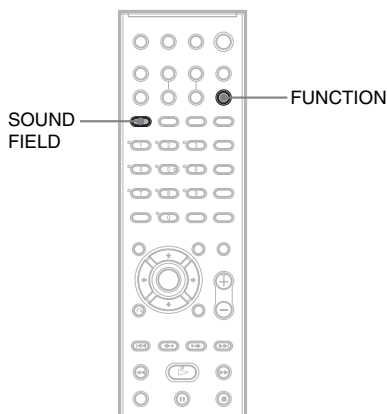

- 1 Press FUNCTION repeatedly until “TV” appears in the front panel display.**
- 2 Press SOUND FIELD repeatedly until the sound field you want appears in the front panel display.**

When you want to output the TV sound or stereo sound of a 2 channel source from the 6 speakers, select the “PRO LOGIC,” “PLII MOVIE,” or “PLII MUSIC” sound field. For details of sound field, see page 29.

## Selecting the Movie or Music Mode

DVD-V

DVD-VR

VIDEO CD

C D

DATA-CD

DATA DVD

You can choose a suitable sound mode for movies or music.

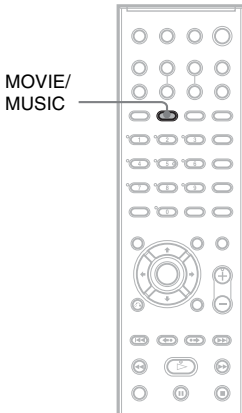

### Press MOVIE/MUSIC during playback.

Press MOVIE/MUSIC repeatedly until the mode you want lights up in the front panel display. The default setting is underlined.

- AUTO: selects the mode automatically to produce the sound effect depending on the disc.
- MOVIE: provides the sound for movies.
- MUSIC: provides the sound for music.

#### Tip

- When the movie or music mode is selected, “MOVIE” or “MUSIC” is displayed in the front panel display.

#### Note

- You cannot operate these setup items when you connect headphones to the system.

## Sound Adjustments

# Enjoying Surround Sound by Using Sound Field

DVD-V

DVD-VR

VIDEO CD

C D

DATA-CD

DATA DVD

You can take advantage of surround sound simply by selecting one of system's pre-programmed sound fields. They bring the exciting and powerful sound of movie theaters into your home.

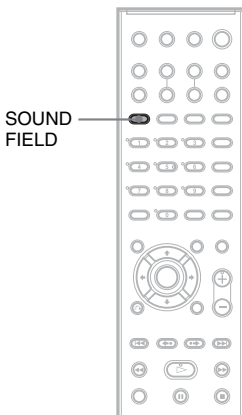

### Press SOUND FIELD.

Press SOUND FIELD repeatedly until the sound field you want appears in the front panel display.

### All sound field

Sound field	Display
AUTO FORMAT DIRECT STANDARD	A.F.D. STD
AUTO FORMAT DIRECT MULTI	A.F.D. MULTI
Dolby Pro Logic	PRO LOGIC
Dolby Pro Logic II MOVIE	PLII MOVIE
Dolby Pro Logic II MUSIC	PLII MUSIC
2 CHANNEL STEREO	2CH STEREO
HEADPHONE	HP 2CH
2 CHANNEL STEREO	
HEADPHONE VIRTUAL	HP VIRTUAL

## Automatic outputting of the original sound

### ■ AUTO FORMAT DIRECT STANDARD

The auto decoding function automatically detects the type of audio signal being input (Dolby Digital, DTS, or standard 2 channel stereo) and performs the proper decoding if necessary. This mode presents the sound as it was recorded/encoded, without adding any effects (e.g. reverberation).

However, if there are no low frequency signals (Dolby Digital LFE, etc.), it will generate a low frequency signal for output to the subwoofer.

## Outputting the sound from multiple speakers

### ■ AUTO FORMAT DIRECT MULTI

This mode lets you enjoy audio playback of all types of discs from multiple speakers.

## Outputting 2 channel sources like CDs by 5.1 channel

### ■ Dolby Pro Logic

Dolby Pro Logic produces five output channels from 2 channel sources. This mode performs Pro Logic decoding to the input signal and output to front, center, and surround speakers.

Meanwhile, the surround channel becomes monaural.

### ■ Dolby Pro Logic II MOVIE/MUSIC

Dolby Pro Logic II produces five full-bandwidth output channels from 2 channel sources. This is done using an advanced, high-purity matrix surround decoder that extracts the spatial properties of the original recording without adding any new sounds or tonal colorations.

#### Note

- When the input signal is multi channel source, Dolby Pro Logic and Dolby Pro Logic II MOVIE/MUSIC are canceled and the multi channel source is output directly.
- When the bilingual broadcast sound is input, Dolby Pro Logic and Dolby Pro Logic II MOVIE/MUSIC are not effective.

continued

---

## **Using only the front speaker and subwoofer**

### **■ 2 CHANNEL STEREO**

This mode outputs the sound from the front left and right speakers and subwoofer. Standard 2 channel (stereo) sources completely bypass the sound field processing. Multi channel surround formats are downmixed to two channels.

This allows you to play any source using only the front left and right speakers and subwoofer.

---

## **Enjoying the surround sound by headphones**

### **■ HEADPHONE 2 CHANNEL STEREO**

This mode outputs the sound from headphone L/R. Standard 2 channel (stereo) sources completely bypass the sound field processing. Multi channel surround formats are downmixed to two channels.

### **■ HEADPHONE VIRTUAL**

This mode outputs the sound as surround from headphone L/R. This mode is effective only when a multi channel source is played.

### **To turn the surround effect off**

Press SOUND FIELD repeatedly until “A.F.D. STD” or “2CH STEREO” appears in the front panel display.

## Various Functions for Playing Discs

### Searching for a Particular Point on a Disc

*(Scan, Slow-motion Play, Freeze Frame)*

**DVD-V   DVD-VR   VIDEO CD   C D   DATA-CD**

**DATA DVD**

You can quickly locate a particular point on a disc by monitoring the picture or playing back slowly.

**Note**

- Depending on the DVD/VIDEO CD, you may not be able to do some of the operations described.

### Locating a point quickly by playing a disc in fast forward or fast reverse (Scan) (except for JPEG)

Press **◀|/◀◀** or **▶▶/▶|** while playing a disc. When you find the point you want, press **▷** to return to normal speed. Each time you press **◀|/◀◀** or **▶▶/▶|** during scan, the playback speed changes. With each press the indication changes as shown below. Actual speeds may differ with some discs.

Playback direction

×2▶ → 1▶▶ → 2▶▶▶ → 3▶▶▶▶



3▶▶▶▶ (DVD VIDEO/DVD-VR mode/VIDEO CD only)  
 ×2▶▶▶▶ (DVD VIDEO/CD only)

Opposite direction

×2◀ → 1◀◀ → 2◀◀◀ → 3◀◀◀◀



3◀◀◀◀ (DVD VIDEO/DVD-VR mode/VIDEO CD only)  
 ×2◀◀◀◀ (DVD VIDEO only)

With each press, playback speed becomes faster.

### Watching frame by frame (Slow-motion Play)

**(DVD VIDEO, DVD-R, DVD-RW, VIDEO CD only)**

Press **◀|/◀◀** or **▶▶/▶|** when the system is in pause mode. To return to the normal playback speed, press **▷**. Each time you press **◀|/◀◀** or **▶▶/▶|** during Slow-motion Play, the playback speed changes. Two speeds are available. With each press the indication changes as follows:

Playback direction

2▶▶ ↔ 1▶▶

Opposite direction (DVD VIDEO only)

2◀◀ ↔ 1◀◀

### Playing one frame at a time (Freeze Frame) (except for CD, MP3, and JPEG)

When the system is in the pause mode, press **•→/▶|** (step) to go to the next frame. Press **◀•/◀|** (step) to go to the preceding frame (DVD VIDEO/DVD-R/DVD-RW only). To return to normal playback, press **▷**.

**Note**

- You cannot search for a still picture on a DVD-R/ DVD-RW in VR mode.

# Searching for a Title/ Chapter/Track/Scene, etc.

DVD-V   DVD-VR   VIDEO CD   CD   DATA-CD  
DATA DVD

You can search a DVD by title or chapter, and you can search a VIDEO CD/CD/DATA CD/DATA DVD by track, index, or scene. As titles and tracks are assigned unique numbers on the disc, you can select the desired one by entering its number. Or, you can search for a scene using the time code.

- 1 Press **DISPLAY**. (When playing a DATA CD/DATA DVD with JPEG image files, press **DISPLAY** twice.)  
The Control Menu appears.
- 2 Press **↑/↓** to select the search method.

The display will show different items depending on the disc.

[TITLE], [TRACK], [SCENE]

[CHAPTER], [INDEX]

[TIME/TEXT]

Select [TIME/TEXT] to search for a starting point by inputting the time code.

[TRACK]

[ALBUM]

[FILE]

Example: when you select [CHAPTER]

[\*\* (\*\*)] is selected (\*\* refers to a number).

The number in parentheses indicates the total number of titles, chapters, tracks, indexes, scenes, albums or files.

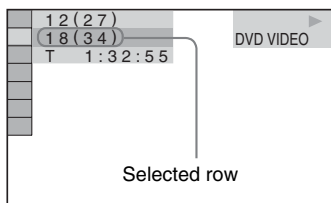

- 3 Press **ENTER**.

[\*\* (\*\*)] changes to [-- (\*\*)].

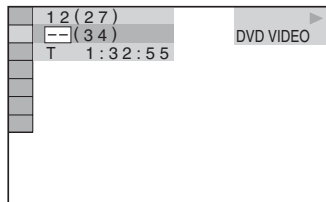

- 4 Press **↑/↓** or the number buttons to select the title, chapter, track, index, scene, etc., number you want to search for.

## If you make a mistake

Cancel the number by pressing **CLEAR**, then select another number.

- 5 Press **ENTER**.

The system starts playback from the selected number.

## To search for a scene using the time code (DVD VIDEO and DVD-VR mode only)

- 1 In Step 2, select [TIME/TEXT].  
[T \*\*: \*\*: \*\*] (playing time of the current title) is selected.
- 2 Press **ENTER**.  
[T \*\*: \*\*: \*\*] changes to [T --:--:--].
- 3 Input the time code using the number buttons, then press **ENTER**.

For example, to find the scene at 2 hours, 10 minutes, and 20 seconds after the beginning, just enter [2:10:20].

### Tip

- When the Control Menu display is turned off, you can search for a chapter (DVD VIDEO/DVD-R/DVD-RW) or track (VIDEO CD/CD) by pressing the number buttons and **ENTER**.

### Note

- You cannot search for a scene on a DVD+RW/DVD+R using the time code.



# Searching by Scene

## (Picture Navigation)

DVD-V VIDEO CD

You can divide the screen into 9 subscreens and find the desired scene quickly.

- 1 Press **PICTURE NAVI** during playback. The following display appears.

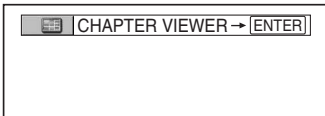

- 2 Press **PICTURE NAVI** repeatedly to select an item.
  - [TITLE VIEWER] (DVD VIDEO only)
  - [CHAPTER VIEWER] (DVD VIDEO only)
  - [TRACK VIEWER] (VIDEO CD/ Super VCD only)

- 3 Press **ENTER**.

The first scene of each title, chapter, or track appears as follows.

1	2	3
4	5	6
7	8	9

- 4 Press **←/↑/↓/→** to select a title, chapter, or track, and press **ENTER**.

Playback starts from the selected scene.

## To return to normal play during setting

Press **↶** RETURN or **⏏** DISPLAY.

### Note

- Depending on the disc, you may not be able to select some items.

# Resuming Playback from the Point Where You Stopped the Disc

## (Resume Play)

DVD-V DVD-VR VIDEO CD C D DATA-CD

DATA DVD

When you stop the disc, the system remembers the point where you pressed **■** and “RESUME” appears in the front panel display. As long as you do not remove the disc, Resume Play will work even if the system enters standby mode by pressing **I/⏏**.

- 1 While playing a disc, press **■** to stop playback.

“RESUME” appears in the front panel display.

If “RESUME” does not appear, Resume Play is not available.

- 2 Press **▷**.

The system starts playback from the point where you stopped the disc in Step 1.

### Note

- Depending on where you stop the disc, the system may not resume playback from exactly the same point.
- The point where you stopped playing may be cleared when:
  - you eject the disc.
  - the system enters standby mode (DATA CD/ DATA DVD only).
  - you change or reset the settings on the Setup Display.
  - you change the function by pressing **FUNCTION**.
  - you disconnect the AC power cord (mains lead).
- For DVD-Rs/DVD-RWs in VR mode, VIDEO CDs, CDs, DATA CDs, and DATA DVDs, the system remembers the resume playback point for the current disc.
- Resume Play does not work during Program Play and Shuffle Play.
- This function may not work properly with some discs.

### Tip

- To play from the beginning of the disc, press **■** twice, then press **▷**.

continued

**To enjoy a disc that is played before by resume playback (Multi-disc Resume) (DVD VIDEO, VIDEO CD only)**

This system stores the point where you stopped the disc for up to 40 discs and resumes playback the next time you insert the same disc. If you store a resume playback point for the 41st disc, the resume playback point for the first disc is deleted.

To activate this function, set [MULTI-DISC RESUME] in [CUSTOM SETUP] to [ON]. For details, see “[MULTI-DISC RESUME] (DVD VIDEO/VIDEO CD only)” (page 69).

**Tip**

- To play from the beginning of the disc, press **■** twice, then press **▷**.

**Note**

- If [MULTI-DISC RESUME] in [CUSTOM SETUP] is set to [OFF] (page 69), the resume point is cleared when you change the function by pressing FUNCTION.

# Creating Your Own Program

*(Program Play)*

**VIDEO CD** **CD**

You can play the contents of a disc in the order you want by arranging the order of the tracks on the disc to create your own program. You can program up to 99 tracks.

**1 Press **DISP** DISPLAY.**

The Control Menu appears.

**2 Press **↑/↓** to select **PROGRAM**, then press **ENTER**.**

The options for [PROGRAM] appear.

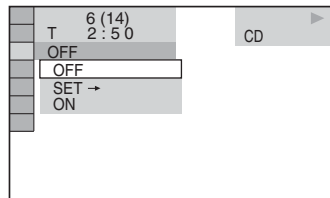

**3 Press **↑/↓** to select **[SET →]**, then press **ENTER**.**

[TRACK] is displayed when you play a VIDEO CD or CD.

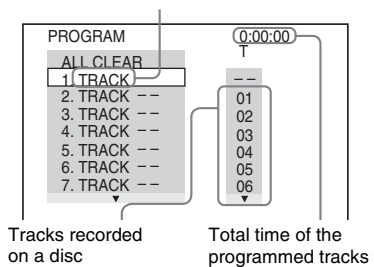

**4 Press **→**.**

The cursor moves to the track row [T] (in this case, [01]).

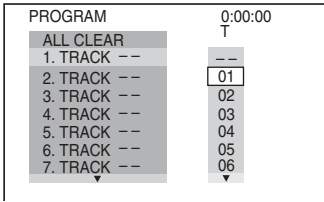

**5 Select the track you want to program.**

For example, select track [02].

Press  $\uparrow/\downarrow$  to select [02] under [T], then press ENTER.

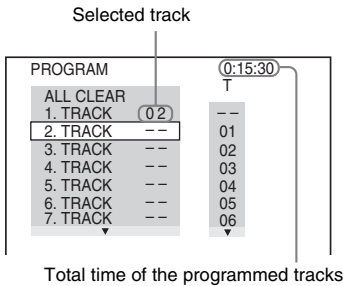

**6 To program other tracks, repeat steps 4 to 5.**

The programmed tracks are displayed in the selected order.

**7 Press  $\triangleright$  to start Program Play.**

Program Play starts.

When the program ends, you can restart the same program again by pressing  $\triangleright$ .

**To return to normal play**

Press CLEAR, or select [OFF] in Step 3. To play the same program again, select [ON] in Step 3 and press ENTER.

**To turn off the Control Menu**

Press  $\square$  DISPLAY repeatedly until the Control Menu is turned off.

**To change or cancel a program**

**1** Follow steps 1 to 3 of “Creating Your Own Program.”

**2** Select the program number of the track you want to change or cancel using  $\uparrow/\downarrow$ . If you want to delete the track from the program, press CLEAR.

**3** Follow Step 5 for new programming. To cancel a program, select [-] under [T], then press ENTER.

**To cancel all of the tracks in the programmed order**

**1** Follow steps 1 to 3 of “Creating Your Own Program.”

**2** Press  $\uparrow$  and select [ALL CLEAR].

**3** Press ENTER.

## Playing in Random Order

### (Shuffle Play)

VIDEO CD   C D   DATA-CD   DATA DVD

You can have the system “shuffle” tracks. Subsequent “shuffling” may produce a different playing order.

#### Note

- Same song may be played repeatedly during MP3 playback.

### 1 Press DISPLAY during playback.

The Control Menu appears.

### 2 Press to select [SHUFFLE], then press ENTER.

The options for [SHUFFLE] appear.

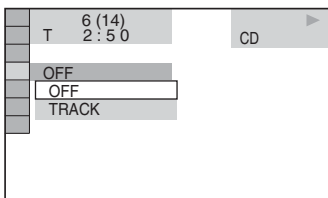

### 3 Press to select the item to be shuffled.

#### ■ When playing a VIDEO CD or CD

- [TRACK]: shuffles tracks on the disc.

#### ■ When Program Play is activated

- [ON]: shuffles tracks selected in Program Play.

#### ■ When playing a DATA CD or DATA DVD

- [ON]: shuffles MP3 audio tracks in the album on the current disc. When no album is selected, the first album will play in random order.

#### Note

- A track already played is also selected in random order.

### 4 Press ENTER.

Shuffle Play starts.

### To return to normal play

Press CLEAR, or select [OFF] in Step 3.

### To turn off the Control Menu

Press  DISPLAY repeatedly until the Control Menu is turned off.

#### Note

- You cannot use this function with VIDEO CDs and Super VCDs with PBC playback.

# Playing Repeatedly

## (Repeat Play)

**DVD-V**   **DVD-VR**   **VIDEO CD**   **C D**   **DATA-CD**  
**DATA DVD**

You can play all the titles, tracks or albums on a disc or a single title, chapter, track, or album repeatedly.

You can use a combination of Shuffle or Program Play modes.

### 1 Press **DISPLAY** during playback.

The Control Menu appears.

### 2 Press **↑/↓** to select **[REPEAT]**, then press **ENTER**.

The options for [REPEAT] appear.

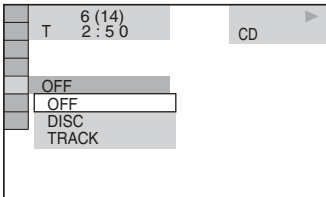

### 3 Press **↑/↓** to select the item to be repeated.

The default setting is underlined.

#### ■ When playing a DVD VIDEO or DVD-VR

- [OFF]: does not play repeatedly.
- [DISC]: repeats all of the titles on the disc.
- [TITLE]: repeats the current title on a disc.
- [CHAPTER]: repeats the current chapter.

#### ■ When playing a VIDEO CD or CD

- [OFF]: does not play repeatedly.
- [DISC]: repeats all of the tracks on the disc.
- [TRACK]: repeats the current track.

#### ■ When playing a DATA CD or DATA DVD

- [OFF]: does not play repeatedly.
- [DISC]: repeats all of the albums on the disc.
- [ALBUM]: repeats the current album.

- [TRACK] (MP3 audio tracks only): repeats the current track.

### 4 Press **ENTER**.

The item is selected.

To return to normal play, press **CLEAR**, or select **[OFF]** in Step 3.

### To turn off the Control Menu

Press **DISPLAY** repeatedly until the Control Menu is turned off.

#### Note

- You cannot use this function with VIDEO CDs and Super VCDs with PBC playback.
- When playing a DATA CD/DATA DVD which contains MP3 audio track and JPEG image files, and their playing time are not the same, the audio sound will not match the image.
- When [MODE (MP3, JPEG)] is set to [IMAGE (JPEG)] (page 47), you cannot select [TRACK].

## Using the DVD's Menu

### DVD-V

A DVD is divided into a lot of sections, which make up a picture or music feature. These sections are called "titles." When you play a DVD which contains several titles, you can select the title you want using TOP MENU. When you play DVDs that allow you to select items such as the language for the subtitles and the language for the sound, select these items using MENU.

#### 1 Press TOP MENU or MENU.

The disc's menu appears on the TV screen. The contents of the menu vary from disc to disc.

#### 2 Press ←/↑/↓/→ or the number buttons to select the item you want to play or change.

#### 3 Press ENTER.

## Changing the Sound

### DVD-V

### DVD-VR

### VIDEO CD

### C D

### DATA-CD

### DATA DVD

When playing a DVD VIDEO recorded in multiple audio formats (PCM, Dolby Digital, MPEG audio, or DTS), you can change the audio format. If the DVD VIDEO is recorded with multilingual tracks, you can also change the language.

With VIDEO CDs, CDs, DATA CDs, or DATA DVDs, you can select the sound from the right or left channel and listen to the sound of the selected channel through both the right and left speakers.

#### 1 Press AUDIO during playback.

The following display appears.

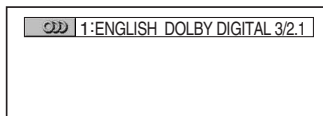

#### 2 Press AUDIO repeatedly to select the desired audio signal.

##### ■ When playing a DVD VIDEO

Depending on the DVD VIDEO, the choice of language varies.

When 4 digits are displayed, they indicate a language code. Refer to "Language Code List" (page 83) to see which language the code represents. When the same language is displayed two or more times, the DVD VIDEO is recorded in multiple audio formats.

##### ■ When playing a DVD-VR

The types of sound tracks recorded on a disc are displayed. The default setting is underlined.

Example:

- [1: MAIN] (main sound)
- [1: SUB] (sub sound)
- [1: MAIN+SUB] (main and sub sound)
- [2: MAIN]
- [2: SUB]
- [2: MAIN+SUB]

**Note**

- [2: MAIN], [2: SUB], and [2: MAIN+SUB] do not appear when one audio stream is recorded on the disc.

**■ When playing a VIDEO CD, CD, DATA CD (MP3 audio), or DATA DVD (MP3 audio)**

The default setting is underlined.

- [STEREO]: the standard stereo sound
- [1/L]: the sound of the left channel (monaural)
- [2/R]: the sound of the right channel (monaural)

**■ When playing a Super VCD**

The default setting is underlined.

- [1:STEREO]: the stereo sound of the audio track 1
- [1:1/L]: the sound of the left channel of the audio track 1 (monaural)
- [1:2/R]: the sound of the right channel of the audio track 1 (monaural)
- [2:STEREO]: the stereo sound of the audio track 2
- [2:1/L]: the sound of the left channel of the audio track 2 (monaural)
- [2:2/R]: the sound of the right channel of the audio track 2 (monaural)

**Note**

- While playing a Super VCD on which the audio track 2 is not recorded, no sound will come out when you select [2:STEREO], [2:1/L], or [2:2/R].

**Checking the audio signal format**

**(DVD only)**

If you press AUDIO repeatedly during playback, the format of the current audio signal (PCM, Dolby Digital, DTS, etc.) appears as shown below.

**■ When playing a DVD**

**Example:**

Dolby Digital 5.1 ch

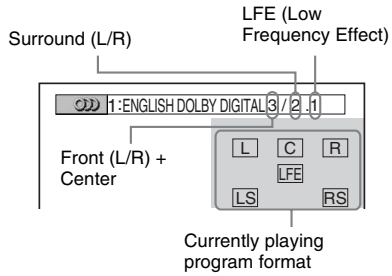

**Example:**

Dolby Digital 3 ch

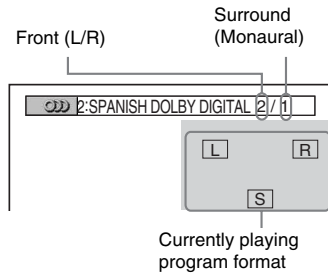

**About audio signals**

Audio signals recorded in a disc contain the sound elements (channels) shown below. Each channel is output from a separate speaker.

- Front (L)
- Front (R)
- Center
- Surround (L)
- Surround (R)
- Surround (Monaural): This signal can be either the Dolby Surround Sound processed signals or the Dolby Digital sound's monaural Surround audio signals.
- LFE (Low Frequency Effect) signal

## Selecting [ORIGINAL] or [PLAY LIST] on a DVD-R/DVD-RW

### DVD-VR

Some DVD-Rs/DVD-RWs in VR (Video Recording) mode have two types of titles for playback: originally recorded titles ([ORIGINAL]) and titles that can be created on recordable DVD players for editing ([PLAY LIST]). You can select the type of title to be played.

**1** Press **DISPLAY** when the system is in stop mode.

The Control Menu appears.

**2** Press **↑/↓** to select **[ORIGINAL/PLAY LIST]**, then press **ENTER**.

The options for [ORIGINAL/PLAY LIST] appear.

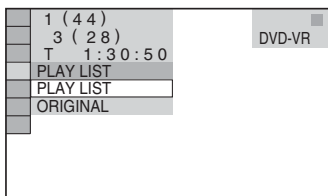

**3** Press **↑/↓** to select a setting.

The default setting is underlined.

- [PLAY LIST]: plays the titles created from [ORIGINAL] for editing.
- [ORIGINAL]: plays the titles originally recorded.

**4** Press **ENTER**.

## Viewing Information About the Disc

### DVD-V

### DVD-VR

### VIDEO CD

### C D

### DATA-CD

### DATA DVD

### Viewing the playing time and remaining time in the front panel display

You can check disc information, such as the remaining time, total number of titles in a DVD, tracks in a VIDEO CD, CD, or MP3 using the front panel display (page 85).

Press **DISPLAY**.

Each time you press **DISPLAY** while playing the disc, the display changes ① → ② → ... → ① → ...

Some displayed items may disappear after a few seconds.

### When playing a DVD VIDEO or DVD-R/DVD-RW

- ① Playing time and number of the current title
- ② Remaining time of the current title
- ③ Playing time and number of the current chapter
- ④ Remaining time of the current chapter
- ⑤ Disc name
- ⑥ Title and chapter

### When playing a VIDEO CD (without PBC functions) or CD

- ① Playing time of the current track
- ② Remaining time of the current track
- ③ Playing time of the disc
- ④ Remaining time of the disc
- ⑤ Disc name
- ⑥ Track and index\*

\* VIDEO CD only.

### When playing a DATA CD (MP3 audio) or DATA DVD (MP3 audio)

- ① Playing time and current track number
- ② Track (file) name



**Tip**

- When playing VIDEO CDs with PBC functions, the playing time is displayed.

**Note**

- The system can only display the first level of the DVD/CD text, such as the Disc name or title.
- If an MP3 file name cannot be displayed, “\*” will appear in the front panel display instead.
- The disc name or track name may not be displayed depending on the text.
- Playing time of MP3 audio tracks may not be displayed correctly.

**■ When playing a VIDEO CD (without PBC functions) or CD**

- T \*\*: \*\*: \*\*  
Playing time of the current track
- T\_ \*\*: \*\*: \*\*  
Remaining time of the current track
- D \*\*: \*\*: \*\*  
Playing time of the current disc
- D\_ \*\*: \*\*: \*\*  
Remaining time of the current disc

**■ When playing a DATA CD (MP3 audio) or DATA DVD (MP3 audio)**

- T \*\*: \*\*: \*\*  
Playing time of the current track

**Note**

- Only alphabetical letters and numbers can be displayed.
- Depending on the type of disc being played, the system can only display a limited number of characters. Also, depending on the disc, not all text characters will be displayed.

**Checking the playing time and remaining time**

You can check the playing time and remaining time of the current title, chapter, or track, and the total playing time or remaining time of the disc. You can also check the DVD text and MP3 folder name/file name recorded on the disc.

**1 Press DISPLAY during playback.**

The following display appears.

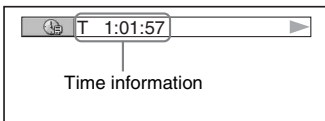

**2 Press DISPLAY repeatedly to change the time information.**

The display and the kinds of time that you can check depend on the disc you are playing.

**■ When playing a DVD VIDEO or DVD-RW**

- T \*\*: \*\*: \*\*: \*\*  
Playing time of the current title
- T\_ \*\*: \*\*: \*\*: \*\*  
Remaining time of the current title
- C \*\*: \*\*: \*\*: \*\*  
Playing time of the current chapter
- C\_ \*\*: \*\*: \*\*: \*\*  
Remaining time of the current chapter

**■ When playing a VIDEO CD (with PBC functions)**

- \*\*: \*\*: \*\*  
Playing time of the current scene

**Checking the play information of the disc**

**To check DVD/CD text**

Press DISPLAY repeatedly in Step 2 to display text recorded on the DVD/CD.

The DVD/CD text appears only when text is recorded in the disc. You cannot change the text. If the disc does not contain text, “NO TEXT” appears.



**To check DATA CD/DATA DVD (MP3 audio) text**

By pressing DISPLAY while playing MP3 audio tracks on a DATA CD/DATA DVD, you can display the name of the album/track, and the audio bit rate (the amount of data per second of the current audio) on your TV screen.

*continued*

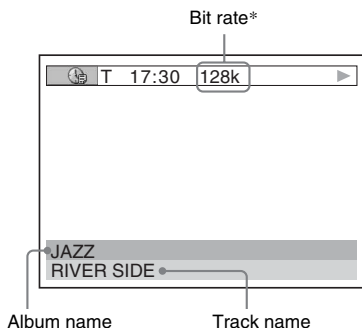

- \* Appears when:
  - playing an MP3 audio track on DATA CDs/DATA DVDs.

## Checking the date information (JPEG only)

You can check the date information during playback when the Exif\* tag is recorded in the JPEG image data.

Press **DISPLAY** twice during playback.

The Control Menu appears.

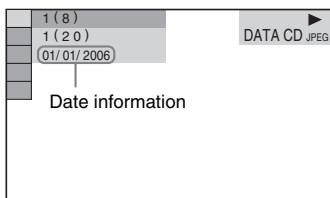

- \* “Exchangeable Image File Format” is a digital camera image format defined by the Japan Electronics and Information Technology Industries Association (JEITA).

### Tip

- Date information is [DD/MM/YYYY].  
 DD: Day  
 MM: Month  
 YYYY: Year

## Changing the Angles

### DVD-V

If various angles (multi-angles) for a scene are recorded on a DVD VIDEO, you can change the viewing angle.

**Press ANGLE during playback.**

Each time you press ANGLE, the angle changes.

### Note

- Depending on the DVD VIDEO, you may not be able to change the angle even if multi-angles are recorded on the DVD VIDEO.

## Displaying the Subtitles

DVD-V DVD-VR

If subtitles are recorded on a disc, you can turn the subtitles on or off while playing. If multilingual subtitles are recorded on the disc, you can change the subtitle language while playing, or turn the subtitles on or off whenever you want.

### Press SUBTITLE during playback.

Each time you press SUBTITLE, the subtitle language changes.

#### Note

- Depending on the DVD VIDEO, you may not be able to change the subtitles even if multilingual subtitles are recorded on it. You also may not be able to turn them off.

## Adjusting the Delay Between the Picture and Sound

### (A/V SYNC)

DVD-V DVD-VR VIDEO CD

When the sound does not match the pictures on the screen, you can adjust the delay between the picture and sound.

### 1 Press DISPLAY when the system is in stop mode.

The Control Menu appears.

### 2 Press to select [A/V SYNC], then press ENTER.

The options for [A/V SYNC] appear.

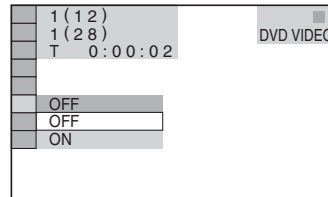

### 3 Press to select the setting you want and press ENTER.

The default setting is underlined.

- [OFF]: does not adjust.
- [ON]: adjusts the difference between picture and sound.

The selected setting takes effect.

#### Note

- Depending on the input stream, this function may not be effective.

# About MP3 Audio Tracks and JPEG Image Files

DATA-CD DATA DVD

## What is MP3/JPEG?

MP3 is audio compression technology that satisfies the ISO/MPEG regulations. JPEG is image compression technology.

## Discs that the system can play

You can play back DATA CDs (CD-ROMs/CD-Rs/CD-RWs) or DATA DVDs (DVD-Rs/DVD-RWs/DVD+Rs/DVD+RWs/DVD-ROMs) recorded in MP3 (MPEG1 Audio Layer 3) or JPEG format. However, the DATA CDs must be recorded according to ISO 9660 Level 1, Level 2 or Joliet format and DATA DVDs of Universal Disk Format (UDF) for the system to recognize the tracks (or files). You can also play discs recorded in Multi Session.

See the instructions supplied with the CD-R/CD-RW or DVD-R/DVD-RW drives and the recording software (not supplied) for details on the recording format.

## About the Multi-Session disc

If MP3 audio tracks or JPEG image files are recorded in the first session, the system will also play MP3 audio tracks or JPEG image files in other sessions. If audio tracks and images in audio CD format or video CD format are recorded in the first session, only the first session will be played back.

### Note

- The system may not be able to play some DATA CDs/DATA DVDs created in the Packet Write format.

## MP3 audio track or JPEG image file that the system can play

The system can play the MP3 audio tracks or JPEG image files:

- which have the extension “.MP3” (MP3 audio track) or “.JPG”/“.JPEG” (JPEG image file)
- which conform to the DCF\* image file format
- \* “Design rule for Camera File system”: Image standards for digital cameras regulated by Japan Electronics and Information Technology Industries Association (JEITA).

### Note

- The system will play any data with the extension “.MP3,” “.JPG,” or “.JPEG” even if they are not in MP3 or JPEG format. Playing this data may generate a loud noise which could damage your speaker system.
- The system does not conform to audio in MP3PRO format.

## Playback order of MP3 audio tracks or JPEG image files

The playback order of MP3 audio tracks or JPEG image files recorded on a DATA CD or DATA DVD is as follows:

### ■ Structure of disc contents

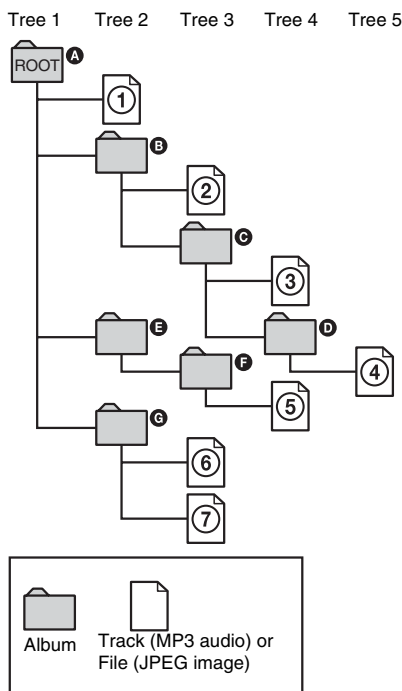

When you insert a DATA CD or DATA DVD and press  $\triangleright$ , the numbered tracks (or files) are played sequentially, from ① through ⑦. Any sub-albums/tracks (or files) contained within a currently selected album take priority over the next album in the same tree. (Example: **C** contains **D** so ④ is played before ⑤.)

When you press MENU and the list of album names appears (page 45), the album names are arranged in the following order:

**A** → **B** → **C** → **D** → **F** → **G**. Albums that do not contain tracks (or files) (such as album **E**) do not appear in the list.

**Tip**

- If you add numbers (01, 02, 03, etc.) to the front of the track (or file) names when you store the tracks (or files) in a disc, the tracks (or files) will be played in that order.
- A disc with many trees takes longer to start playback.

**Note**

- Playback order may differ from the illustration depending on the software you use to create the DATA CD or DATA DVD, or if there are more than 200 albums and 300 files in each album.
- The system can recognize up to 200 albums, and will not play any albums beyond the 200th.
- The system may take longer time to playback, when progressing to the following album or jump to other album.
- Some type of JPEG files cannot be played.

# Playing DATA CDs or DATA DVDs with MP3 Audio Tracks and JPEG Image Files

**DATA-CD** **DATA DVD**

## Selecting an MP3 audio track or album

### 1 Load a DATA CD or DATA DVD.

The albums recorded on the DATA CD or DATA DVD appear. When an album is being played, its title is shaded.



### 2 Press $\uparrow/\downarrow$ to select an album.

■ **When selecting an album**

Press  $\triangleright$  to start playing the selected album.

■ **When selecting a track**

Press ENTER.

The list of tracks contained in the album appears.

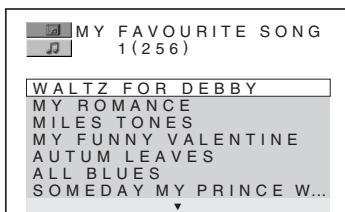

Press  $\uparrow/\downarrow$  to select a track and press ENTER.

The selected track starts playing. You can turn the track list off by pressing MENU.

*continued*

Pressing MENU again will display the album list.

## To stop playback

Press ■.

## To play the next or previous MP3 audio track

Press ◀◀/▶▶. Note that you can select the next album by continuing to press ▶▶ after the last track on the current album, but that you cannot return to the previous album by pressing ◀◀. To return to the previous album, select the album from the album list.

## To return to the previous display

Press ↶ RETURN.

## To turn off the display

Press MENU.

1	2	3	4
5	6	7	8
9	10	11	12
13	14	15	16

Press ◀/↑/↓/▶ to select the image you want to view and press ENTER.

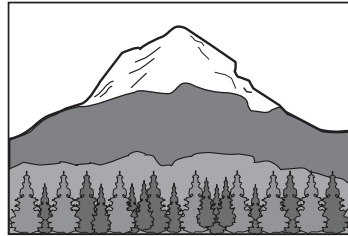

## Selecting a JPEG image file or album

### 1 Load a DATA CD or DATA DVD.

The albums recorded on the DATA CD or DATA DVD appear. When an album is being played, its title is shaded.

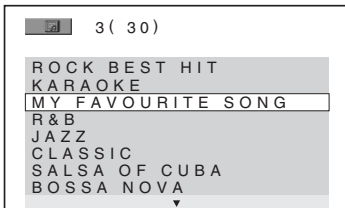

### 2 Press ↑/↓ to select an album.

#### ■ When selecting an album

Press ▷ to start playing the selected album.

#### ■ When selecting an image

Press PICTURE NAVI.

Images of files in the album appear in 16 subscreens.

## To play the next or previous JPEG image file

Press ◀/▶ when the Control Menu is not displayed. Note that you can select the next album by continuing to press ▶ after the last image on the current album, but that you cannot return to the previous album by pressing ◀. To return to the previous album, select the album from the album list.

## To rotate a JPEG image

When a JPEG image file is displayed on the screen, you can rotate the image by 90 degrees. Press ↑/↓ while viewing an image. Each time you press ↑, the image rotates counterclockwise by 90 degrees.

Example of when you press ↑ once:

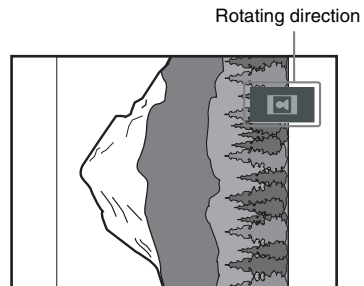

Press CLEAR to return to normal view.

## To stop playback

Press ■.

### Tip

- A scroll box is displayed at the right side of the screen. To display the additional image files, select the bottom image and press ↓. To return to the previous image, select the top image and press ↑.

## Playing Audio Tracks and Images as a Slide Show with Sound

**DATA-CD** **DATA DVD**

You can play a slide show with sound by first placing both MP3 and JPEG files in the same album on a DATA CD or DATA DVD. When you play back the DATA CD or DATA DVD, select [AUTO] mode as explained below.

- 1 Load a DATA CD or DATA DVD.**
- 2 Press  DISPLAY when the system is in stop mode.**

The Control Menu appears.

- 3 Press ↑/↓ to select  [MODE (MP3, JPEG)], then press ENTER.**

The options for [MODE (MP3, JPEG)] appear.

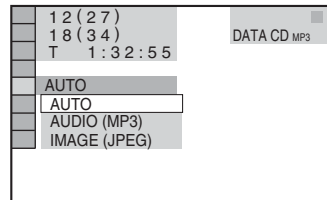

- 4 Press ↑/↓ to select the setting you want and press ENTER.**

The default setting is underlined.

- [AUTO]: plays both the JPEG image files and MP3 audio tracks in the same album as a slide show.
- [AUDIO (MP3)]: plays only MP3 audio tracks continuously.
- [IMAGE (JPEG)]: plays only JPEG image files as a slide show.

- 5 Press MENU.**

The list of albums recorded on the DATA CD or DATA DVD appears.

- 6 Press ↑/↓ to select the album you want and press .**

The system starts playing the selected album.

*continued*

You can turn the album list on and off by pressing MENU repeatedly.

**Tip**

- When you select [AUTO], the system can recognize up to 300 MP3 tracks and 300 JPEG files in a single album. When you select [AUDIO (MP3)] or [IMAGE (JPEG)], the system can recognize up to 600 MP3 and 600 JPEG files in a single album. A maximum of 200 albums can be recognized regardless of the selected mode.

**Note**

- If you set [MODE (MP3, JPEG)] to [IMAGE (JPEG)] on a disc that contains MP3 tracks only or [AUDIO (MP3)] on a disc that contains JPEG files only, you may not be able to change the [MODE (MP3, JPEG)] setting.
- PICTURE NAVI does not work when [AUDIO (MP3)] is selected.
- If you play large MP3 track data and JPEG image data at the same time, the sound may skip. It is recommended that you set the MP3 bit rate to 128 kbps or lower when creating the file. If the sound still skips, then reduce the size of the JPEG file.

## Specifying the slide show duration

### (JPEG only)

When you play JPEG image files using slide show, you can specify the duration for slides to appear on the screen.

#### 1 Press DISPLAY twice.

The Control Menu for JPEG appears.

#### 2 Press to select [INTERVAL], then press ENTER.

The options for [INTERVAL] appear.

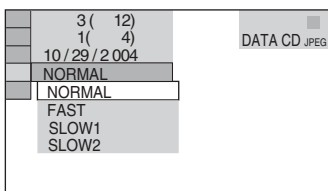

#### 3 Press to select the setting you want.

The default setting is underlined.

- [NORMAL]: sets the duration to about 6 to 9 seconds. (Images that are four million pixels or more will lengthen the duration.)
- [FAST]: sets the duration shorter than [NORMAL].
- [SLOW1]: sets the duration longer than [NORMAL].
- [SLOW2]: sets the duration longer than [SLOW1].

## 4 Press ENTER.

The selected setting takes effect.

**Note**

- Some JPEG files may take longer to display than others, which may make the duration seems longer than the option you selected. Especially progressive JPEG files or JPEG files of 3,000,000 pixels or more.

## Selecting an effect for image files in the slide show (JPEG only)

When you play a JPEG image file, you can select the effect to be used when viewing the slide show.

#### 1 Press DISPLAY twice.

The Control Menu for JPEG appears.

#### 2 Press to select [EFFECT], then press ENTER.

The options for [EFFECT] appear.

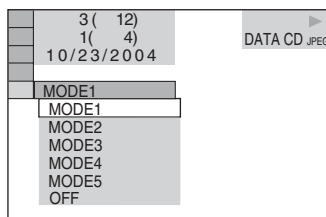

#### 3 Press to select the setting you want.

The default setting is underlined.

- [MODE1]: The image sweeps in from top to bottom.
- [MODE2]: The image stretches out from left to right of the screen.
- [MODE3]: The image stretches out from the center of the screen.



- [MODE4]: The images randomly cycle through the effects.
- [MODE5]: The next image slides over the previous image.
- [OFF]: turns off this function.

#### 4 Press ENTER.

The selected setting takes effect.

## Playing VIDEO CDs with PBC Functions (Ver.2.0)

### (PBC Playback)

#### VIDEO CD

With PBC (Playback Control) functions, you can enjoy simple interactive operations, search functions, and other such operations. PBC playback allows you to play VIDEO CDs interactively by following the menu on the TV screen.

#### 1 Start playing a VIDEO CD with PBC functions.

The menu for your selection appears.

#### 2 Select the item number you want by the number buttons.

#### 3 Press ENTER.

#### 4 Follow the instructions in the menu for interactive operations.

Refer to the operation details supplied with the disc, as the operating procedure may differ depending on the VIDEO CD.





### To go back to the menu

Press  RETURN.

#### Note

- Depending on the VIDEO CD, [Press ENTER] in Step 3 may appear as [Press SELECT] in the instructions supplied with the disc. In this case, press .

#### Tip

- To play without using PBC, press /  or the number buttons while the system is stopped to select a track, then press  or ENTER. The system starts continuous play. You cannot play still pictures such as a menu. To return to PBC playback, press  twice, then press .

## Tuner Functions

### Presetting Radio Stations

You can preset 20 FM stations, and 10 AM stations. Before tuning, make sure to turn down the volume to minimum.

**1 Press FUNCTION repeatedly until “TUNER FM” or “TUNER AM” appears in the front panel display.**

**2 Press and hold TUNING + or – until the auto scanning starts.**

Scanning stops when the system tunes in a station. “TUNED” and “ST” (for stereo program) appear in the front panel display.

**3 Press MENU.**

**4 Press  $\uparrow/\downarrow$  repeatedly until “MEMORY” appears in the front panel display.**

**5 Press ENTER.**

A preset number appears in the front panel display.

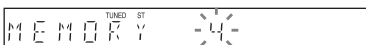

**6 Press  $\uparrow/\downarrow$  to select the preset number you want.**



**7 Press ENTER.**

The station is stored.



**8 Repeat 1 to 7 to store other stations.**

### To change the preset number

Restart from Step 1.

## Listening to the Radio

Preset radio stations in the system's memory first (see "Presetting Radio Stations" (page 50)).

**1 Press FUNCTION repeatedly until “TUNER FM” or “TUNER AM” appears in the front panel display.**

The last received station is tuned in.

**2 Press PRESET + or – repeatedly to select the preset station you want.**

Each time you press the button, the system tunes in one preset station.

**3 Adjust the volume by pressing VOLUME +/-.**

### To turn off the radio

Press I/⏻.

### To listen to non-preset radio stations

Use manual or automatic tuning in Step 2. For manual tuning, press TUNING + or – repeatedly.

For automatic tuning, press and hold TUNING + or –. The automatic tuning stops automatically when the system receives the radio station. To stop the automatic tuning manually, press TUNING + or –.

### To listen to radio stations when you know the frequencies

Use direct tuning in Step 2.

**1 Press D.TUNING.**

**2 Press the number buttons to select the frequency number you want to listen to.**

**3 Press ENTER.**

#### Tip

- If an FM program is noisy, press MENU, and select “FM MODE” by pressing  $\uparrow/\downarrow$ , then press ENTER. Press  $\uparrow/\downarrow$  to select “MONO,” then press ENTER. There will be no stereo effect, but the reception will improve. To restore the stereo effect, select “STEREO.”
- To improve reception, reorient the supplied antennas (aerials).

## Naming preset stations

You can enter a name for preset stations. These names (for example, “XYZ”) appear in the system’s front panel display when a station is selected.

Note that no more than one name can be entered for each preset station.

### Note

- You cannot enter a name for preset stations of the Radio Data System (RDS) (page 52).

### 1 Press FUNCTION repeatedly until “TUNER FM” or “TUNER AM” appears in the front panel display.

The last received station is tuned in.

### 2 Press PRESET + or – repeatedly to select the preset station you want to create an index name for.

### 3 Press MENU.

### 4 Press $\uparrow/\downarrow$ repeatedly until “NAME IN” appears in the front panel display.

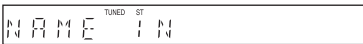

### 5 Press ENTER.

### 6 Create a name by using the cursor buttons.

Press  $\uparrow/\downarrow$  to select a character, then press  $\rightarrow$  to move the cursor to the next position.

Letters, numbers, and other symbols can be input for a radio station name.

### If you make a mistake

Press  $\leftarrow/\rightarrow$  repeatedly until the character to be changed flashes, then press  $\uparrow/\downarrow$  to select the desired character.

To erase the character, press  $\leftarrow/\rightarrow$  repeatedly until the character to be erased flashes, then press CLEAR.

### 7 Press ENTER.

“COMPLETE” appears in the front panel display, and the station name is stored.

### Tip

- You can check the frequency by pressing DISPLAY repeatedly (page 51).

## Viewing the station name or frequency in the front panel display

When the system is set to “TUNER AM” or “TUNER FM,” you can check the frequency using the front panel display.

### Press DISPLAY.

Each time you press DISPLAY, the display changes as shown.

- ① Station name\*
- ② Frequency\*\*

\* This is displayed if you have entered a name for a preset station.

\*\* Returns to the original display when several seconds has elapsed.



## Using the Radio Data System (RDS)

### What is the Radio Data System?

The Radio Data System (RDS) is a broadcasting service that allows radio stations to send additional information along with the regular program signal. This tuner offers convenient RDS features, such as station name display. RDS is available only for FM stations.\*

#### Note

- RDS may not work properly if the station you are tuned to is not transmitting the RDS signal properly, or if the signal strength is weak.
- \* Not all FM stations provide RDS service, nor do they provide the same type of services. If you are not familiar with the RDS system, check with your local radio stations for details on RDS services in your area.

### Receiving RDS broadcasts

#### Simply select a station from the FM band.

When you tune in a station that provides RDS services, the station name\* appears in the front panel display.

- \* If an RDS broadcast is not received, the station name may not appear in the front panel display.

## Receiving DAB Stations

Before you can receive DAB, you must register the contents of broadcasts (service components) so that they can be received by the DAB tuner using the DAB INITIAL SCAN procedure.

### Before receiving DAB stations (DAB INITIAL SCAN)

DAB INITIAL SCAN starts automatically when you select the “DAB” function for the first time after you purchase the system or after you cancel DAB INITIAL SCAN while scanning.

- 1 Make sure that the DAB wire antenna (aerial) is connected to the ANTENNA DAB 75Ω jack on the rear of the unit (page 13).**
- 2 Make sure that the system turns on, and then select the “DAB” function.**

DAB INITIAL SCAN starts automatically. When scanning is complete, “COMPLETE” appears in the front panel display momentarily and an available service component list is created.

#### Note

- Before the DAB INITIAL SCAN procedure, make sure to turn the volume to minimum.

If you move to another area, do the following to perform DAB INITIAL SCAN again in order to store the stations for your new area.

- 1 Press FUNCTION repeatedly until “DAB” appears in the front panel display.**
- 2 Press MENU.**
- 3 Press  $\uparrow/\downarrow$  repeatedly until “INIT SCAN” appears in the front panel display.**
- 4 Press ENTER.**
- 5 Press  $\uparrow/\downarrow$  repeatedly until “SCAN YES” appears in the front panel display.**
- 6 Press ENTER.**

When scanning begins, “SCAN \*\*\*” appears in the front panel display (\*\* refers to a number of percent complete by 10%,

but “%” does not appear in the front panel display). Depending on the DAB services available in your area, this may take a few minutes.

When scanning is complete, “COMPLETE” appears in the front panel display momentarily and an available service component list is created.

**Note**

- If your country or region does not support DAB broadcast, “NO SERVICE” appears.
- Do not press any button on the unit or remote during DAB INITIAL SCAN. Scanning is interrupted and service component list may not be created properly. In this case, perform DAB INITIAL SCAN again.
- If you move to another area, repeat this procedure to store the stations for your new area.
- This procedure clears all previously stored presets.
- This procedure does not create any presets.

## Listening to a DAB station

- 1 Press FUNCTION repeatedly until “DAB” appears in the front panel display.**

The last received station is tuned in.

- 2 Press TUNING + or – repeatedly to select a station you want.**

For continuous tuning, press and hold TUNING + or –, then to release the button to select the station you want.

When the system tunes in a station, “TUNED” and “ST” (for stereo program or joint (intensity) stereo program) appear in the front panel display.

- 3 Adjust the volume by pressing VOLUME +/-.**

**Note**

- You cannot select a DAB station by the D.TUNING button and number buttons (direct tuning).
- When tuning in a DAB station, it may take a few seconds before you hear any sound.
- Primary service is automatically received when secondary service ends.

## Presetting DAB stations

You can preset 30 DAB stations.

- 1 Press FUNCTION repeatedly until “DAB” appears in the front panel display.**  
The last received station is tuned in.
- 2 Tune in the station you want to preset.**
- 3 Press MENU.**
- 4 Press ↑/↓ repeatedly until “MEMORY” appears in the front panel display.**
- 5 Press ENTER.**

A preset number appears in the front panel display.



- 6 Press ↑/↓ to select the preset number you want.**



- 7 Press ENTER.**

The station is stored.

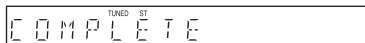

- 8 Repeat 1 to 7 to store other stations.**

### To change the preset number

Restart from Step 1.

**Note**

- You cannot preset the service component while “TUNED” is not displayed.

---

## Listening to a DAB station by using a preset number

Preset DAB radio stations in the system's memory first (see "Presetting DAB stations" (page 53)).

### 1 Press FUNCTION repeatedly until "DAB" appears in the front panel display.

The last received station is tuned in.

### 2 Press PRESET + or – repeatedly to select the preset station you want.

Each time you press the button, the system tunes in one preset station. You can also select the number by pressing the number buttons. Press the number buttons, and then press ENTER.

### 3 Adjust the volume by pressing VOLUME +/-.

#### Note

- If there is no stored preset station, or no registered preset number, "NO PRESET" appears in the front panel display.
- Primary service is automatically received when secondary service ends.

---

## Viewing the DAB station information in the front panel display

Press DISPLAY repeatedly.

Each time you press DISPLAY while tuning in a DAB station, the display changes ① → ② → ... → ① → ...

- ① Service component label
- ② Dynamic label segment<sup>1)</sup>
- ③ Channel label and frequency<sup>2)</sup>
- ④ Preset number<sup>2)3)</sup>

<sup>1)</sup>If a station does not provide the Dynamic label segment, "NO TEXT" is displayed.

<sup>2)</sup>Returns to the service component label after about 4 seconds.

<sup>3)</sup>If the currently received station is not preset, this is skipped.

#### Note

- If tuning a DAB station, the following appears in the front panel display:

- "OTHER LANG" is displayed when the system does not support the language.
- All text is displayed in capital letters.
- A character which cannot be displayed is replaced by a blank space.
- When "ST" appears in the front panel display, the current program is broadcasted in the stereo/joint (intensity) stereo mode.

## Other Operations

### Controlling the TV with the Supplied Remote

You can control your TV (SONY only) with the supplied remote.

### Controlling TVs with the remote

#### To control the TV

You can control the TV by using following buttons.

By pressing	You can
TV I/⏻	Turn the TV on or off.
TV/VIDEO	Switch the TV's input source between the TV and other input sources.
TV VOL +/-	Adjust the TV volume.
TV CH +/-	Select the TV channel.
Number buttons while pressing the TV button	Select the TV channel.

-/- is for selecting a channel number greater than 10. (For example, for channel 25, press -/-, then 2 and 5.)

#### Note

- Depending on the TV, you may not be able to control your TV or to use some of the buttons above.

## Using the THEATRE SYNC Function

THEATRE SYNC allows you to turn on your SONY TV and this system, changes the system mode to "DVD," and then switches the TV's input source you set with one button push.

### Preparing for the THEATRE SYNC function

Register the TV's input source connected to this system.

**Press and hold TV/VIDEO while entering the code for the TV's input source connected to this system (see the table) using the number buttons.**

The TV's input source is selected.

Set your TV's input to the input you used to connect the system. For details, see the instructions of your TV.

By pressing	Number	TV's input source
TV/VIDEO	0	No input source (Default)
	1	VIDEO1
	2	VIDEO2
	3	VIDEO3
	4	VIDEO4
	5	VIDEO5
	6	VIDEO6
	7	VIDEO7
	8	VIDEO8
	9*	COMPONENT 1
	CLEAR*	COMPONENT 2
	AMP MENU*	COMPONENT 3
	PICTURE NAVI*	COMPONENT 4

\* Except for North American models.

---

## Operating for the THEATRE SYNC function

Point the remote to the direction of TV and this system, then press THEATRE SYNC once.

If this function does not work, change the transmit time. The transmit time varies depending on the TV.

### To change the transmit time

Press and hold TV CH + while entering the code for transmit time (see the table) using the number buttons.

The transmit time from the remote is selected.

By pressing	Number	Transmit time
TV CH +	1	0.5 (Default)
	2	1
	3	1.5
	4	2
	5	2.5
	6	3
	7	3.5
	8	4

#### Note

- This function is only for SONY TVs. (This function may not work on some SONY TVs.)
- If distance between TV and this system is too far, this function may not work. Install the system near the TV.
- Keep the remote pointed in the direction of the TV and this system while entering the code.

---

## Using the Sound Effect

---

### Reinforcing bass frequencies

You can reinforce bass frequencies.

Press DYNAMIC BASS.

Bass frequencies are effectively reinforced.

### To turn off the sound effect

Press DYNAMIC BASS again.





## Advanced Settings and Adjustments

### Locking Discs

#### (CUSTOM PARENTAL CONTROL, PARENTAL CONTROL)

DVD-V

VIDEO CD

C D

You can set 2 kinds of playback restrictions for the desired disc.

- Custom Parental Control

You can set playback restrictions so that the system will not play inappropriate discs.

- Parental Control

Playback of some DVD VIDEOS can be limited according to a predetermined level such as the age of the users. Scenes may be blocked or replaced with different scenes.

The same password is used for both Custom Parental Control and Parental Control.

#### Preventing playback of specific discs [CUSTOM PARENTAL CONTROL]

You can set the same Custom Parental Control password for up to 40 discs. When you set the 41st-disc, the first disc is canceled.

#### 1 Insert the disc you want to lock.

If the disc is playing, press ■ to stop playback.

#### 2 Press DISPLAY while the system is in stop mode.

The Control Menu appears.

#### 3 Press $\uparrow/\downarrow$ to select [PARENTAL CONTROL], then press ENTER.

The options for [PARENTAL CONTROL] appear.

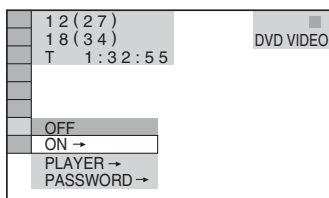

#### 4 Press $\uparrow/\downarrow$ to select [ON →], then press ENTER.

- If you have not entered a password

The display for registering a new password appears.

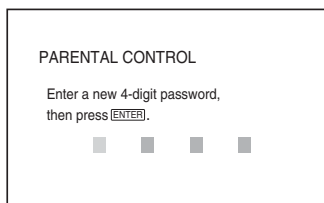

Enter a 4-digit password using the number buttons, then press ENTER.

The display for confirming the password appears.

- When you have already registered a password

The display for entering the password appears.

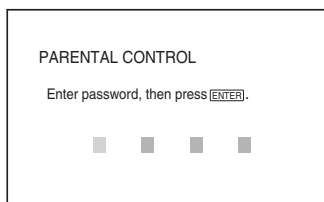

#### 5 Enter or re-enter your 4-digit password using the number buttons, then press ENTER.

[Custom parental control is set.] appears and the screen returns to the Control Menu.

#### To turn off the Custom Parental Control function

1 Follow steps 1 through 3 of "Preventing playback of specific discs [CUSTOM PARENTAL CONTROL]."

2 Press  $\uparrow/\downarrow$  to select [OFF →], then press ENTER.

3 Enter your 4-digit password using the number buttons, then press ENTER.

## To play a disc for which Custom Parental Control is set

1 Insert the disc for which Custom Parental Control is set.

The [CUSTOM PARENTAL CONTROL] display appears.

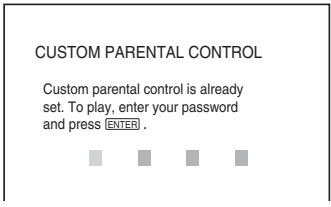

2 Enter your 4-digit password using the number buttons, then press ENTER.

The system is ready for playback.

**Tip**

- If you forget your password, enter the 6-digit number "199703" using the number buttons when the [CUSTOM PARENTAL CONTROL] display asks you for your password, then press ENTER. The display will ask you to enter a new 4-digit password.

## Limiting playback for children [PARENTAL CONTROL] (DVD only)

Playback of some DVD VIDEOS can be limited according to a predetermined level such as the age of the users. The [PARENTAL CONTROL] function allows you to set a playback limitation level.

1 Press  **DISPLAY** while the system is in stop mode.

The Control Menu appears.

2 Press  $\uparrow/\downarrow$  to select  [PARENTAL CONTROL], then press ENTER.

The options for [PARENTAL CONTROL] appear.

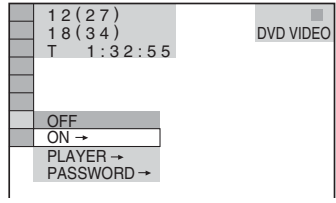

3 Press  $\uparrow/\downarrow$  to select [PLAYER  $\rightarrow$ ], then press ENTER.

■ If you have not entered a password  
The display for registering a new password appears.

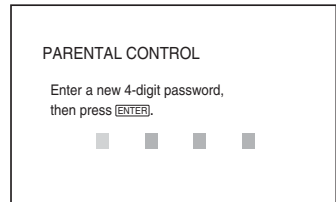

Enter a 4-digit password using the number buttons, then press ENTER.

The display for confirming the password appears.

■ When you have already registered a password

The display for entering the password appears.

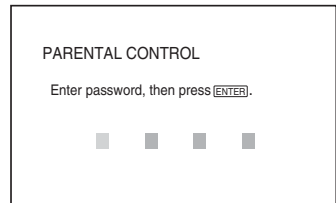

- 4** Enter or re-enter your 4-digit password using the number buttons, then press **ENTER**.

The display for setting the playback limitation level appears.

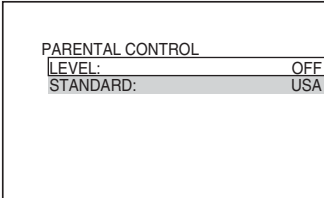

- 5** Press **↑/↓** to select [STANDARD], then press **ENTER**.

The selection items for [STANDARD] are displayed.

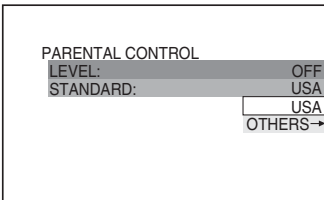

- 6** Press **↑/↓** to select a geographic area as the playback limitation level, then press **ENTER**.

The area is selected.

When you select [OTHERS →], select and enter a standard code in the table of “Parental Control Area Code List” (page 83) using the number buttons.

- 7** Press **↑/↓** to select [LEVEL], then press **ENTER**.

The selection items for [LEVEL] are displayed.

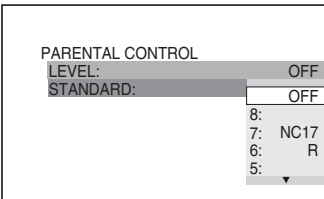

- 8** Press **↑/↓** to select the level you want, then press **ENTER**.

Parental Control setting is complete.

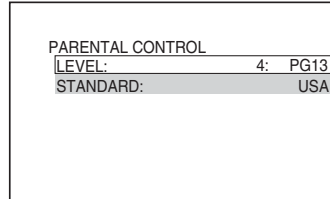

The lower the value, the stricter the limitation.

### To turn off the Parental Control function

Set [LEVEL] to [OFF] in Step 8.

### To play a disc for which Parental Control is set

- 1** Insert the disc and press **▷**.

The display for entering your password appears.

- 2** Enter your 4-digit password using the number buttons, then press **ENTER**.

The system starts playback.

#### Tip

- If you forget your password, remove the disc and repeat steps 1 to 3 of “Preventing playback of specific discs [CUSTOM PARENTAL CONTROL].” When you are asked to enter your password, enter “199703” using the number buttons, then press **ENTER**. The display will ask you to enter a new 4-digit password. After you enter a new 4-digit password, replace the disc in the system and press **▷**. When the display for entering your password appears, enter your new password.

#### Note

- When you play discs which do not have the Parental Control function, playback cannot be limited on this system.
- Depending on the disc, you may be asked to change the parental control level while playing the disc. In this case, enter your password, then change the level. If the Resume Play mode is canceled, the level returns to the previous level.

## Changing the password

- 1 Press  DISPLAY while the system is in stop mode.

The Control Menu appears.

- 2 Press  $\uparrow/\downarrow$  to select  [PARENTAL CONTROL], then press ENTER.

The options for [PARENTAL CONTROL] appear.

- 3 Press  $\uparrow/\downarrow$  to select [PASSWORD  $\rightarrow$ ], then press ENTER.

The display for entering the password appears.

- 4 Enter your 4-digit password using the number buttons, then press ENTER.

- 5 Enter a new 4-digit password using the number buttons, then press ENTER.

- 6 To confirm your password, re-enter it using the number buttons, then press ENTER.

### If you make a mistake entering your password

Press  $\leftarrow$  before you press ENTER and input the correct number.

## Getting Optimal Surround Sound for a Room

### (SPEAKER FORMATION)

Depending on the shape of the room, there will be some speakers you cannot install. For the better surround sound, it is recommended that first you decide the position of the speakers.

- 1 Press FUNCTION repeatedly until "DVD" appears in the front panel display.

- 2 Press  DISPLAY when the system is in stop mode.

The Control Menu appears.

- 3 Press  $\uparrow/\downarrow$  to select  [SPEAKER FORMATION], then press ENTER.

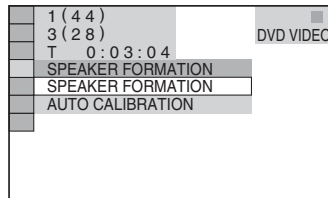

- 4 Press  $\uparrow/\downarrow$  to select [SPEAKER FORMATION], then press ENTER.

The options for [SPEAKER FORMATION] appear.

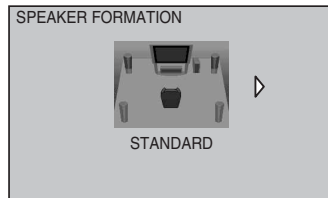

continued

## 5 Press ←/→ to select a setting.

- [STANDARD]: when installing all the speakers normally.

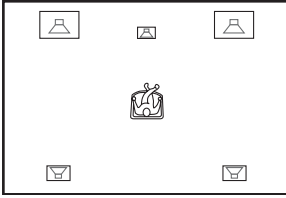

- [NO CENTER]: when installing the front and surround speakers.

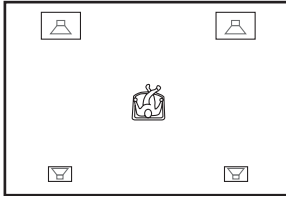

- [NO SURROUND]: when installing the center and front speakers.

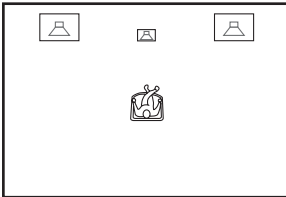

- [FRONT ONLY]: when installing the front speakers.

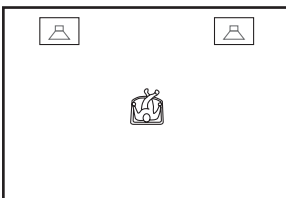

- [ALL FRONT]: when installing all the speakers in front of the listening position.



- [ALL FRONT - NO CENTER]: when installing the front and surround speakers in front of the listening position.

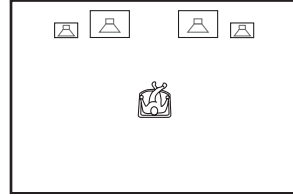

- [SECOND ROOM]: when installing the front speakers in one room and surround speakers in another.

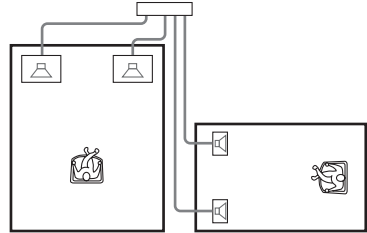

## 6 Press ENTER.

The selected setting takes effect.

## 7 Press ↑/↓ to select [YES] or [NO], then press ENTER.

- [YES]: continue with [AUTO CALIBRATION], see Step 5 of “Calibrating the Appropriate Settings Automatically” (page 63).
- [NO]: exit [SPEAKER FORMATION].

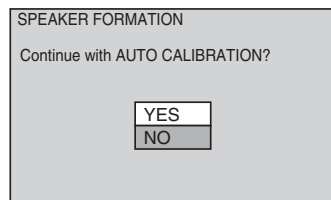

**Note**

- In order to enjoy the surround sound after you change the position of the speakers, it is recommended you set [SPEAKER FORMATION], and then set [AUTO CALIBRATION].
- To set [AUTO CALIBRATION], you need to connect the supplied calibration mic.
- The front panel display indicates the selected [SPEAKER FORMATION]. It does not indicate the speakers which output sound.
- When you change the [SIZE] setting in [SPEAKER SETUP], the [SPEAKER FORMATION] setting returns to [STANDARD].



## Calibrating the Appropriate Settings Automatically

### (AUTO CALIBRATION)

D. C. A. C. (Digital Cinema Auto Calibration) can set the appropriate surround sound automatically.

**Note**

- Loud test sound is output when [AUTO CALIBRATION] starts. You cannot turn the volume down. Give consideration to children and neighbor.

- 1 Press FUNCTION repeatedly until "DVD" appears in the front panel display.**
- 2 Press  DISPLAY when the system is in stop mode.**  
The Control Menu appears.
- 3 Press  to select  [SPEAKER FORMATION], then press ENTER.**

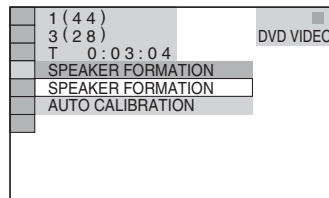

- 4 Press  to select [AUTO CALIBRATION], then press ENTER.**  
The options for [AUTO CALIBRATION] appear.

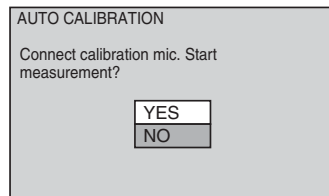

Connect the calibration mic to the A.CAL MIC jack on the front panel, and set it up at the ear level using a tripod, etc. (not

supplied). The front of each speaker should face the calibration mic, and there should be no obstruction between the speakers and the calibration mic. Be quiet during the measurement.

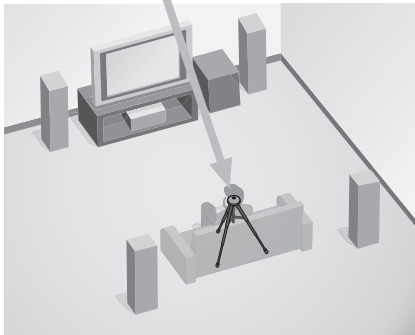
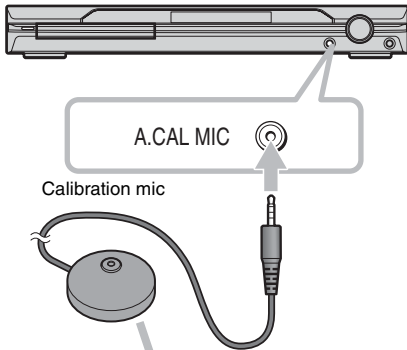

## 5 Press $\uparrow/\downarrow$ to select [YES], then press ENTER.

Calibration starts.



### Note

- Avoid being in the measurement area and making noise during the measurement (about 3 minutes), to avoid measurement failure. During the measurement, test signals are output from the speakers.

- Reflections from walls or the floor may affect measurements.
- If an error message appears, follow the message, then select [YES].  
An error message appears when:
  - the headphones are connected.
  - the calibration mic is not connected.
  - front speakers are not correctly connected.
  - surround speakers are not correctly connected.
  - front and surround speakers are not correctly connected.
  - there is excessive noise around the calibration mic.
  - the calibration mic is overloaded.

## 6 Press $\leftarrow/\rightarrow$ to select [YES] or [NO], then press ENTER.

### ■ The measurement is OK.

Disconnect the calibration mic, then select [YES]. The result is implemented.

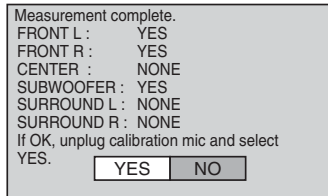

### ■ The measurement is not OK.

Follow the message, then select [YES] to retry.

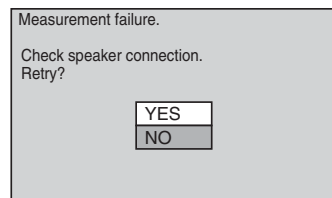

### Tip

- You can check the distance between the listening position and each speaker. See page 70.



**Note**

- While the Auto Calibration function works:
  - do not turn off the power.
  - do not press any button.
  - do not change the volume.
  - do not change the function.
  - do not change the disc.
  - do not insert or eject a disc.
  - do not connect the headphones.
  - do not disconnect the calibration mic.

## Using the Setup Display

By using the Setup Display, you can make various adjustments to items such as picture and sound.

For an overall list of Setup Display items, see page 89.

Displayed items differ depending on the country model.

**Note**

- Playback settings stored in the disc take priority over the Setup Display settings and not all the functions described may work.

### 1 Press DISPLAY when the system is in stop mode.

The Control Menu appears.

### 2 Press $\uparrow/\downarrow$ to select [SETUP], then press ENTER.

The options for [SETUP] appear.

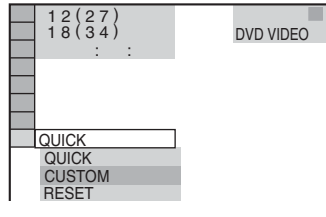

### 3 Press $\uparrow/\downarrow$ to select [CUSTOM], then press ENTER.

The Setup Display appears.

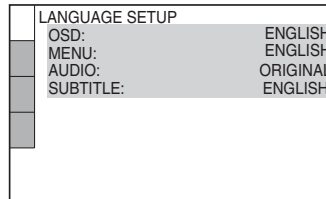

- 4** Press  $\uparrow/\downarrow$  to select the setup item from the displayed list: [LANGUAGE SETUP], [SCREEN SETUP], [CUSTOM SETUP], or [SPEAKER SETUP]. Then press ENTER.

The Setup item is selected.

Example: [SCREEN SETUP]

Selected item

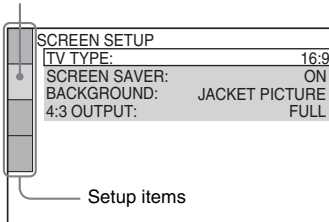

- 5** Select an item using  $\uparrow/\downarrow$ , then press ENTER.

The options for the selected item appear.

Example: [TV TYPE]

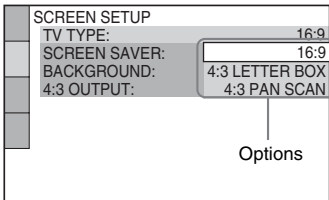

- 6** Select a setting using  $\uparrow/\downarrow$ , then press ENTER.

The setting is selected and setup is complete.

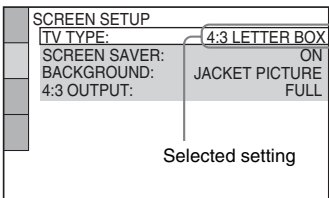

## To reset all of the [SETUP] settings

- 1 Select [RESET] in Step 3 and press ENTER.
- 2 Select [YES] using  $\uparrow/\downarrow$ .  
You can also quit the process and return to the Control Menu by selecting [NO] here.
- 3 Press ENTER.

All the settings explained on pages 67 to 72 return to the default settings. Do not press  $\mathbb{I}/\mathbb{O}$  while resetting the system as it takes a few seconds to complete.

### Note

- When you turn the system on after resetting and no disc is in the system, the guide message appears on the TV screen. To perform the Quick Setup (page 16), press ENTER, to return to normal screen, press CLEAR.

## Setting the Display or Sound Track Language

### [LANGUAGE SETUP]

[LANGUAGE SETUP] allows you to set various languages for the on-screen display or sound track.

Select [LANGUAGE SETUP] in the Setup Display. To use the display, see “Using the Setup Display” (page 65).

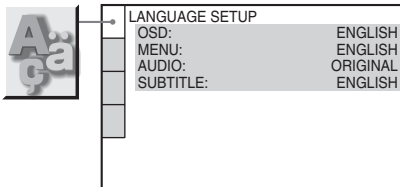

#### ■ [OSD] (On-Screen Display)

Switches the display language on the screen.

#### ■ [MENU] (DVD VIDEO only)

You can select the desired language for the disc's menu.

#### ■ [AUDIO] (DVD VIDEO only)

Switches the language of the sound track.

When you select [ORIGINAL], the language given priority in the disc is selected.

#### ■ [SUBTITLE] (DVD VIDEO only)

Switches the language of the subtitle recorded on the DVD VIDEO.

When you select [AUDIO FOLLOW], the language for the subtitles changes according to the language you selected for the sound track.

#### Tip

• If you select [OTHERS →] in [MENU], [AUDIO], and [SUBTITLE], select and enter a language code from “Language Code List” (page 83) using the number buttons.

#### Note

• When you select a language in [MENU], [AUDIO], or [SUBTITLE] that is not recorded on the DVD VIDEO, one of the recorded languages will be automatically selected (depending on the disc, the language may not be selected automatically).

## Settings for the Display

### [SCREEN SETUP]

Choose settings according to the TV to be connected.

Select [SCREEN SETUP] in the Setup Display. To use the display, see “Using the Setup Display” (page 65).

The default settings are underlined.

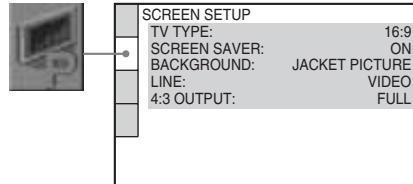

#### ■ [TV TYPE]

Selects the aspect ratio of the connected TV (4:3 standard or wide).

The default setting varies, depending on the country model.

---

#### [4:3 LETTER BOX]

Select this when you connect a 4:3 screen TV. Displays a wide picture with bands on the upper and lower portions of the screen.

---

#### [4:3 PAN SCAN]

Select this when you connect a 4:3 screen TV. Automatically displays the wide picture on the entire screen and cuts off the portions that do not fit.

---

#### [16:9]

Select this when you connect a wide-screen TV or a TV with a wide mode function.

---

[4:3 LETTER BOX]



[4:3 PAN SCAN]

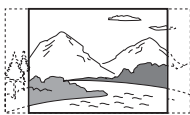

[16:9]

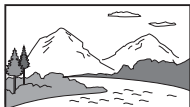

**Note**

- Depending on the DVD, [4:3 LETTER BOX] may be selected automatically instead of [4:3 PAN SCAN] or vice versa.

**■ [SCREEN SAVER]**

The screen saver image appears when you leave the system in pause or stop mode for 15 minutes, or when you play back a CD, DATA CD (MP3 audio), or DATA DVD for more than 15 minutes. The screen saver will help prevent your display device from becoming damaged (ghosting). Press any button (e.g.,  $\triangleright$  button) to cancel the screen saver.

<b>[ON]</b>	Turns on the screen saver.
<b>[OFF]</b>	Turns off the screen saver.

**■ [BACKGROUND]**

Selects the background color or picture on the TV screen in stop mode or while playing a CD, DATA CD (MP3 audio), or DATA DVD.

<b>[JACKET PICTURE]</b>	The jacket picture (still picture) appears, but only when the jacket picture is already recorded on the disc (CD-EXTRA, etc.). If the disc does not contain a jacket picture, the [GRAPHICS] picture appears.
<b>[GRAPHICS]</b>	A preset picture stored in the system appears.
<b>[BLUE]</b>	The background color is blue.
<b>[BLACK]</b>	The background color is black.

**■ [LINE]**

Selects the output method for video signals from the EURO AV  $\leftrightarrow$  OUTPUT (TO TV) jack on the rear panel of the system.

<b>[VIDEO]</b>	Outputs video signals.
<b>[RGB]</b>	Outputs RGB signals.

**Note**

- If your TV does not accept RGB signals, no picture appears on the TV screen even if you select [RGB]. Refer to the instructions supplied with your TV.

**■ [4:3 OUTPUT]**

This setting is effective only when you set [TV TYPE] in [SCREEN SETUP] to [16:9] (page 67). Adjust this to watch 4:3 aspect ratio progressive signals. If you can change the aspect ratio on your progressive format (525p/625p) compatible TV, change the setting on your TV, not the system.

**Note**

- This setting is effective only when "P AUTO (PROGRESSIVE AUTO)" or "P VIDEO (PROGRESSIVE VIDEO)" is selected by using PROGRESSIVE (page 22).

<b>[FULL]</b>	Select this when you can change the aspect ratio on your TV.
<b>[NORMAL]</b>	Select this when you cannot change the aspect ratio on your TV. Shows a 16:9 aspect ratio signal with black bands on left and right sides of the image.

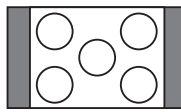

16:9 aspect ratio TV

# Custom Settings

## [CUSTOM SETUP]

Use this to set up playback related and other settings.

Select [CUSTOM SETUP] in the Setup Display. To use the display, see “Using the Setup Display” (page 65).

The default settings are underlined.

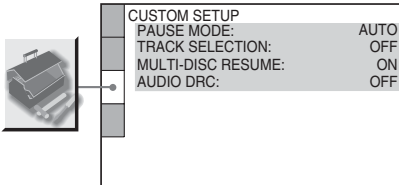

### ■ [PAUSE MODE] (DVD VIDEO/DVD-R/ DVD-RW only)

Selects the picture in pause mode.

---

**[AUTO]** The picture, including subjects that move dynamically, is output with no jitter. Normally select this position.

---

**[FRAME]** The picture, including subjects that do not move dynamically, is output in high resolution.

---

### ■ [TRACK SELECTION] (DVD VIDEO only)

Gives the sound track which contains the highest number of channels priority when you play a DVD VIDEO on which multiple audio formats (PCM, DTS, MPEG audio, or Dolby Digital format) are recorded.

---

**[OFF]** No priority given.

---

**[AUTO]** Priority given.

---

#### Note

- When you set the item to [AUTO], the language may change. The [TRACK SELECTION] setting has higher priority than the [AUDIO] settings in [LANGUAGE SETUP] (page 67). (Depending on the disc, this function may not work.)
- If PCM, DTS, Dolby Digital sound, and MPEG audio tracks have the same number of channels, the system selects PCM, DTS, Dolby Digital sound, and MPEG audio tracks in this order.

### ■ [MULTI-DISC RESUME] (DVD VIDEO/ VIDEO CD only)

Switches the Multi-disc Resume setting on or off.

---

**[ON]** Stores the resume settings in memory for up to 40 discs.

---

**[OFF]** Does not store the resume settings in memory. Playback restarts at the resume point only for the current disc in the system.

---

### ■ [AUDIO DRC] (DVD VIDEO only)

Narrows the dynamic range of the sound track. Useful for watching movies at low volume late at night.

---

**[OFF]** No compression of dynamic range.

---

**[STANDARD]** Reproduces the sound track with the kind of dynamic range that the recording engineer intended.

---

**[MAX]** Compresses dynamic range fully.

---

# Settings for the Speakers

## [SPEAKER SETUP]

To obtain the best possible surround sound, set for the size of the speakers you have connected and their distance from your listening position. Then use the test tone to adjust the level and the balance of the speakers to the same level.

Select [SPEAKER SETUP] in the Setup Display. For details, see “Using the Setup Display” (page 65).

The default settings are underlined.

### Note

- You cannot operate these setup items when you connect headphones to the system.

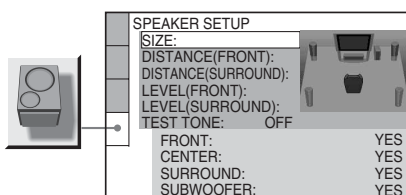

## To return to the default setting when changing a setting

Select the item, then press CLEAR. Note that only the [SIZE] setting does not return to the default setting.

### ■ [SIZE]

If you do not connect center or surround speakers, set the parameters for [CENTER] and [SURROUND]. Since the front speaker and subwoofer setting is fixed, you cannot change them.

[FRONT]	<u>[YES]</u>
[CENTER]	<u>[YES]</u> : Normally select this. [NONE]: Select this if no center speaker is used.
[SURROUND]	<u>[YES]</u> : Normally select this. [NONE]: Select this if no surround speaker is used.
[SUBWOOFER]	<u>[YES]</u>

### Note

- When you change the [SIZE] setting, the [SPEAKER FORMATION] setting returns to [STANDARD].

### ■ [DISTANCE (FRONT)]

The default distance setting for the speakers in relation to the listening position is shown below. When you set the distance using the Quick Setup (page 16), the settings is automatically displayed.

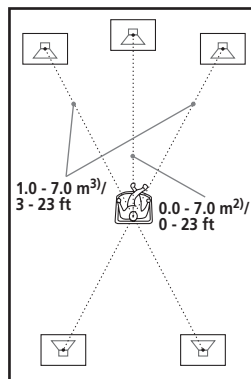

Be sure to change the value in the Setup Display when you move the speakers.

---

**[L/R]**  
**3.0 m/10 ft<sup>1)</sup>** Front speaker distance from the listening position can be set in 0.2 meter (1 ft) increments from 1.0 to 7.0 meters<sup>3)</sup> (3 to 23 ft).

---

**[CENTER]**  
**3.0 m/10 ft<sup>1)</sup>** (appears when you set [CENTER] to [YES] in the [SIZE] setting.) Center speaker distance can be moved up to 1.6 meters (5 ft) closer to the listening position from the front speaker distance, in 0.2 meter (1 ft) increments.

<sup>1)</sup>When you perform the Quick Setup (page 16), the default settings are changed.

<sup>2)</sup>0.0 to 6.9 meters for North American models.

<sup>3)</sup>0.9 to 6.9 meters for North American models.

### ■ [DISTANCE (SURROUND)]

The default distance setting for the speakers in relation to the listening position is shown below. When you set the distance using the Quick Setup (page 16), the settings is automatically displayed.

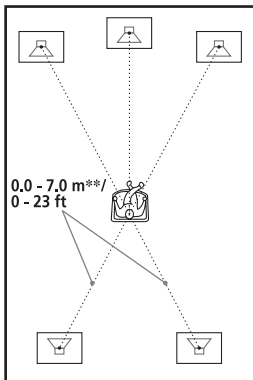

Be sure to change the value in the Setup Display when you move the speakers.

<b>[L/R]</b> <b>3.0 m/10 ft*</b> (appears when you set [SURROUND] to [YES] in the [SIZE] setting.)	Surround speaker distance from the listening position can be set in 0.2 meter (1 ft) increments from 0.0 to 7.0 meters** (0 to 23 ft).
--	--

\* When you perform the Quick Setup (page 16), the default settings are changed.

\*\* 0.0 to 6.9 meters for North American models.

**Note**

- If all front and surround speakers are not placed at an equal distance from your listening position, set the distance according to the closest speaker.
- Do not place the surround speakers farther away from your listening position than the front speakers.
- Depending on the input stream, the [DISTANCE] setting may not be effective.

■ **[LEVEL (FRONT)]**

You can vary the level of front speakers as follows. Be sure to set [TEST TONE] to [ON] for easy adjustment.

<b>[L/R]</b> <b>0.0 dB</b>	Set this between -6.0 dB and 0.0 dB in 1.0 dB increments.
-------------------------------	---

<b>[CENTER]</b> <b>0.0 dB</b> (appears when you set [CENTER] to [YES] in the [SIZE] setting.)	Set this between -6.0 dB and +6.0 dB in 1.0 dB increments.
---	--

<b>[SUBWOOFER]</b> <b>0.0 dB</b>	Set this between -6.0 dB and +6.0 dB in 1.0 dB increments.
-------------------------------------	--

■ **[LEVEL (SURROUND)]**

You can vary the level of surround speakers as follows. Be sure to set [TEST TONE] to [ON] for easy adjustment.

<b>[L/R]</b> <b>0.0 dB</b> (appears when you set [SURROUND] to [YES] in the [SIZE] setting.)	Set this between -6.0 dB and +6.0 dB in 1.0 dB increments.
--	--

**To adjust the volume of all the speakers at one time**

Turn the VOLUME control on the system, or press VOLUME +/- on the remote.

■ **[TEST TONE]**

The speakers will emit a test tone to adjust [LEVEL (FRONT)] and [LEVEL (SURROUND)].

<b>[OFF]</b>	The test tone is not emitted from the speakers.
--------------	---

<b>[ON]</b>	The test tone is emitted from each speaker in sequence while adjusting level. When you select one of the [SPEAKER SETUP] items, the test tone is emitted from each speaker in sequence.
-------------	---

**Adjusting the speaker level by using the test tone**

- 1 Press **DISPLAY** when the system is in stop mode.  
The Control Menu appears.
- 2 Press to select [SETUP], then press **ENTER**.  
The options for [SETUP] appear.
- 3 Press to select [CUSTOM], then press **ENTER**.  
The Setup Display appears.
- 4 Press repeatedly to select [SPEAKER SETUP], then press **ENTER** or **→**.
- 5 Press repeatedly to select [TEST TONE], then press **ENTER** or **→**.

continued

- 6** Press **↑/↓** repeatedly to select [ON], then press **ENTER**.

You will hear the test tone from each speaker in sequence.

- 7** From your listening position, adjust the value of [LEVEL (FRONT)] or [LEVEL (SURROUND)] using **←/↑/↓/→**.

The test tone is emitted from only the speaker which you are adjusting.

- 8** Press **ENTER** when you have finished making adjustments.

- 9** Press **↑/↓** repeatedly to select [TEST TONE], then press **ENTER**.

- 10** Press **↑/↓** repeatedly to select [OFF], then press **ENTER**.

## Returning to the Default Settings

You can return the system parameters, such as preset stations, to the default settings.

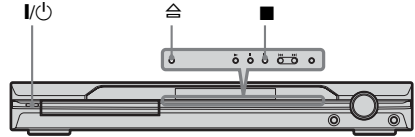

- 1** Press **I/⏻** to turn on the system.
- 2** Press **■, ▲, and I/⏻** on the system at the same time.

“COLD RESET” appears in the front panel display and the default settings are returned.



## Additional Information

### Precautions

#### On power sources

- AC power cord (mains lead) must be changed only at the qualified service shop.
- The unit is not disconnected from the AC power source (mains) as long as it is connected to the wall outlet (mains), even if the unit itself has been turned off.

#### On placement

- Place the system in a location with adequate ventilation to prevent heat build-up in the system.
- At high volume, over long periods of time, the cabinet becomes hot to the touch. This is not a malfunction. However, touching the cabinet should be avoided. Do not place the unit in a confined space where ventilation is poor as this may cause overheating.
- Do not block the ventilation slots by putting anything on the system. The system is equipped with a high power amplifier. If the ventilation slots are blocked, the unit can overheat and malfunction.
- Do not place the system on a soft surface such as a rug and do not block the ventilation holes.
- Do not place the system in a location near heat sources, or in a place subject to direct sunlight, excessive dust, or mechanical shock.

#### On operation

- If the system is brought directly from a cold to a warm location, or is placed in a very damp room, moisture may condense on the lenses inside the system. Should this occur, the system may not operate properly. In this case, remove the disc and leave the system turned on for about half an hour until the moisture evaporates.
- When you move the system, take out any disc. If you don't, the disc may be damaged.

#### On adjusting volume

- Do not turn up the volume while listening to a section with very low level inputs or no audio signals. If you do, the speakers may be damaged when a peak level section is suddenly played.

#### On cleaning

- Clean the cabinet, panel, and controls with a soft cloth slightly moistened with a mild detergent solution. Do not use any type of abrasive pad, scouring powder or solvent such as alcohol or benzene.

If you have any questions or problems concerning your system, please consult your nearest Sony dealer.

#### On cleaning discs, disc/lens cleaner

- Do not use a commercially available cleaning disc or disc/lens cleaner (wet or spray type). These may cause apparatus to malfunction.

#### On your TV's color

- If the speakers should cause the TV screen to have color irregularity, turn off the TV then turn it on after 15 to 30 minutes. If color irregularity should persist, place the speakers farther away from the set.

#### IMPORTANT NOTICE

Caution: This system is capable of holding a still video image or on-screen display image on your television screen indefinitely. If you leave the still video image or on-screen display image displayed on your TV for an extended period of time you risk permanent damage to your television screen. Projection televisions are especially susceptible to this.

The nameplate is located on the bottom exterior.

#### On moving the system

Before moving the system, make sure that there is no disc inserted, and remove the AC power cord (mains lead) from the wall outlet (mains).

## Notes about the Discs

### On handling discs

- To keep the disc clean, handle the disc by its edge. Do not touch the surface.
- Do not stick paper or tape on the disc.



- Do not expose the disc to direct sunlight or heat sources such as hot air ducts, or leave it in a car parked in direct sunlight as the temperature may rise considerably inside the car.
- After playing, store the disc in its case.

### On cleaning

- Before playing, clean the disc with a cleaning cloth. Wipe the disc from the center out.



- Do not use solvents such as benzine, thinner, commercially available cleaners, or anti-static spray intended for vinyl LPs.

This system can only play back a standard circular disc. Using neither standard nor circular discs (e.g., card, heart, or star shape) may cause a malfunction.

Do not use a disc that has a commercially available accessory attached, such as a label or ring.

## Troubleshooting

If you experience any of the following difficulties while using the system, use this troubleshooting guide to help remedy the problem before requesting repairs. Should any problem persist, consult your nearest Sony dealer.

Note that if service personnel changes some parts during repair, these parts may be retained.

### Power

#### The power is not turned on.

- Check that the AC power cord (mains lead) is connected securely.

#### If “PROTECTOR” and “PUSH POWER” appears alternately in the front panel display.

Press I/⏻ to turn off the system, and check the following items after “STANDBY” disappears.

- Are the + and – speaker cords short-circuited?
- Are you using only the specified speakers?
- Is anything blocking the ventilation holes of the system?

After checking the above items and fixing any problems, turn on the system. If the cause of the problem cannot be found even after checking all the above items, consult your nearest Sony dealer.

### Picture

#### There is no picture.

- The SCART (EURO AV) cord is not connected securely.
- The SCART (EURO AV) cord is damaged.
- The system is not connected to the correct EURO AV  INPUT jack (page 10, 21).
- The video input on the TV is not set so that you can view pictures from the system.
- Check the output method on your system (page 68).
- You have set progressive format but your TV cannot accept the signal in progressive format. In this case, return the setting to interlace format (the default setting) (page 22).
- Even if your TV is compatible with progressive format (525p/625p) signals, the image may be affected when you set progressive format. In this case, return the setting to interlace format (the default setting) (page 22).

#### Picture noise appears.

- The disc is dirty or flawed.

---

**Even though you set the aspect ratio in [TV TYPE] of [SCREEN SETUP], the picture does not fill the screen.**

- The aspect ratio on the disc is fixed.

---

**Color irregularity occurs on the TV screen.**

The subwoofer and the front speakers in this system are magnetically shielded to prevent magnetic leakage. However, some leakage may occur, as a high-strength magnet is employed. If this happens, check the following items:

- If the speakers are used with a CRT-based TV or projector, install the speakers at least 0.3 m (1.0 ft) from the TV set.
- If the color irregularity persists, turn off the TV set once, then turn it on after 15 to 30 minutes.
- If howling occurs, reposition the speakers farther away from the TV set.
- Make sure that no magnetic object (magnetic latch on a TV stand, health care device, toy, etc.) is placed near the speakers.

---

## Sound

---

**There is no sound.**

- The speaker cord is not connected securely.
- Press **MUTING** on the remote if “**MUTING ON**” is displayed in the front panel display.
- The system is in pause mode or in Slow-motion Play mode. Press **▷** to return to normal play mode.
- Fast forward or fast reverse is performed. Press **▷** to return to normal play mode.
- Check the speaker settings (page 70).

---

**The left and right sounds are unbalanced or reversed.**

- Check that the speakers and components are connected correctly and securely.

---

**There is no sound from the subwoofer.**

- Check the speaker connections and settings (page 10, 70).
- Set the sound field to “**A.F.D. STD**” (page 29).

---

**Severe hum or noise is heard.**

- Check that the speakers and components are connected securely.
- Check that the connecting cords are away from a transformer or motor, and at least 3 meters (10 ft) away from your TV set or a fluorescent light.
- Move your TV away from the audio components.
- The plugs and jacks are dirty. Wipe them with a cloth slightly moistened with alcohol.
- Clean the disc.

---

**The sound loses stereo effect when you play a VIDEO CD, a CD, or an MP3.**

- Set [AUDIO] to [STEREO] by pressing **AUDIO** (page 38).
- Make sure the system is connected properly.

---

**The surround effect is difficult to hear when you are playing a Dolby Digital, DTS, or MPEG audio sound track.**

- Make sure the sound field function is on (page 29).
- Check the speaker connections and settings (page 10, 70).
- Depending on the DVD, the output signal may not be the entire 5.1 channel. It may be monaural or stereo even if the sound track is recorded in Dolby Digital or MPEG audio format.

---

**The sound comes from the center speaker only.**

- Depending on the disc, the sound may come from the center speaker only.

---

**No sound is heard from the center speaker.**

- Check the speaker connections and settings.
- Make sure the sound field function is on (page 29).
- Depending on the source, the effect of the center speaker may be less noticeable.

---

**No sound or only a very low-level sound is heard from the surround speakers.**

- Check the speaker connections and settings.
- Make sure the sound field function is on (page 29).
- Depending on the source, the effect of the surround speakers may be less noticeable.

---

**There is no sound from the speakers that are indicated in the front panel display.**

- The front panel display indicates the selected [SPEAKER FORMATION]. It does not indicate the speakers which output sound (page 29, 61).

---

## Operation

---

**Radio stations cannot be tuned in.**

- Check that the antenna (aerial) is connected securely. Adjust the antenna (aerial) or connect an external antenna (aerial) if necessary.
- The signal strength of the stations is too weak (when tuning in with automatic tuning). Use direct tuning.
- No stations have been preset or the preset stations have been cleared (when tuning by scanning preset stations). Preset the stations (page 50).
- Press **DISPLAY** so that the frequency appears in the front panel display.

---

**“TUNED” does not appear in the front panel display (DAB only).**

- Check the DAB wire antenna (aerial) connection and adjust the DAB wire antenna (aerial) angle, and then perform DAB INITIAL SCAN (page 52).
- The current DAB service is not available. Press TUNING + or – to select a different service.
- If you have moved to another area, some services/frequencies may have changed and you may not be able to tune into your usual broadcasts. Perform DAB INITIAL SCAN procedure to re-register broadcast content. (Performing this procedure clears all previously stored presets.)
- Connect a DAB external antenna (aerial) (not supplied) on page 13.

---

**“NO SERVICE” is displayed (DAB only).**

- Check the DAB wire antenna (aerial) connection and adjust the DAB wire antenna (aerial) angle, and then perform DAB INITIAL SCAN (page 52).
- Connect a DAB external antenna (aerial) (not supplied) on page 13, and then perform DAB INITIAL SCAN.

---

**“SCAN” does not disappear (DAB only).**

- Depending on the DAB services available in your area, scanning may take a few minutes (page 52).

---

**The remote does not function.**

- There are obstacles between the remote and the system.
- The distance between the remote and the system is too far.
- The remote is not pointed at the remote sensor on the system.
- The batteries in the remote are weak.

---

**The disc does not play.**

- There is no disc inserted.
- The disc is upside down.  
Insert the disc with the playback side facing down.
- The disc is skewed on the disc tray.
- The system cannot play CD-ROMs, etc. (page 6).
- The region code on the DVD does not match the system.
- Moisture has condensed inside the system and may cause damage to the lenses. Remove the disc and leave the system turned on for about half an hour.

---

**The MP3 audio track cannot be played.**

- The DATA CD is not recorded in the MP3 format that conforms to ISO 9660 Level 1/Level 2, or Joliet.
- The DATA DVD is not recorded in an MP3 format that conforms to UDF (Universal Disk Format).
- The MP3 audio track does not have the extension “.MP3.”
- The data is not formatted in MP3 even though it has the extension “.MP3.”
- The data is not MPEG1 Audio Layer 3 data.
- The system cannot play audio tracks in MP3PRO format.
- The [MODE (MP3, JPEG)] setting has been set to [IMAGE (JPEG)] (page 47).
- If you cannot change the [MODE (MP3, JPEG)] setting, re-load the disc or turn the system off, then on.

---

**The JPEG image file cannot be played.**

- The DATA CD is not recorded in a JPEG format that conforms to ISO 9660 Level 1/Level 2, or Joliet.
- The DATA DVD is not recorded in a JPEG format that conforms to UDF (Universal Disk Format).
- It has an extension other than “.JPEG” or “.JPG.”
- It is larger than 3,072 (width) × 2,048 (height) in normal mode, or more than 2,000,000 pixels in Progressive JPEG which is mainly used on the Internet WEB site.
- It does not fit the screen (those images are reduced).
- The [MODE (MP3, JPEG)] setting has been set to [AUDIO (MP3)] (page 47).
- If you cannot change the [MODE (MP3, JPEG)] setting, re-load the disc or turn the system off, then on.

---

**The MP3 audio tracks and JPEG image file starts playing simultaneously.**

- [AUTO] has been selected in [MODE (MP3, JPEG)] (page 47).

---

**The titles of album/track/file name are not displayed correctly.**

- The system can only display numbers and letters of the alphabets. Other characters are displayed as [\*].

---

**A disc does not start playing from the beginning.**

- Program Play, Shuffle Play, or Repeat Play has been selected.  
Press CLEAR to cancel these functions before playing a disc.

- Resume Play has been selected.  
During stop, press ■ on the system or the remote and then start playback (page 33).
- The title, DVD or PBC menu automatically appears on the TV screen.

---

**The system starts playing the disc automatically.**

- The DVD features an auto playback function.

---

**Playback stops automatically.**

- Some discs may contain an auto pause signal.  
While playing such a disc, the system stops playback at the auto pause signal.

---

**You cannot perform some functions such as Stop, Search, Slow-motion Play, or Repeat Play.**

- Depending on the disc, you may not be able to perform some of the operations above. See the operating manual that came with the disc.

---

**Messages do not appear on the screen in the language you want.**

- In the Setup Display, select the desired language for the on-screen display in [OSD] under [LANGUAGE SETUP] (page 67).

---

**The language for the sound track cannot be changed.**

- Multilingual tracks are not recorded on the DVD being played.
- The DVD prohibits changing the language for the sound track.

---

**The subtitle language cannot be changed.**

- Multilingual subtitles are not recorded on the DVD being played.
- The DVD prohibits changing the subtitles.

---

**The subtitle cannot be turned off.**

- The DVD prohibits turning off subtitles.

---

**The angles cannot be changed.**

- Multi-angles are not recorded on the DVD being played (page 42).
- The DVD prohibits changing the angles.

---

**A disc cannot be ejected and “LOCKED” appears in the front panel display.**

- Contact your Sony dealer or local authorized Sony service facility.

---

**[Data error] appears on the TV screen when playing a DATA CD or DATA DVD.**

- The MP3 audio track/JPEG image file you want to play is broken.
- The data is not MPEG1 Audio Layer 3 data.
- The JPEG image file format does not conform to DCF.

- The JPEG image file has the extension “.JPG” or “.JPEG,” but is not in JPEG format.

---

**The system does not work normally.**

- Disconnect the AC power cord (mains lead) from the wall outlet (mains), then reconnect after several minutes.

## Self-diagnosis Function

*(When letters/numbers appear in the display)*

When the self-diagnosis function is activated to prevent the system from malfunctioning, a 5-character service number (e.g., C 13 50) with a combination of a letter and 4 digits appears on the screen and the front panel display. In this case, check the following table.

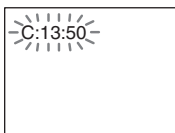

First 3 characters of the service number	Cause and/or corrective action
C 13	The disc is dirty. ➔ Clean the disc with a soft cloth (page 74).
C 31	The disc is not inserted correctly. ➔ Restart the system, then re-insert the disc correctly.
E XX (xx is a number)	To prevent a malfunction, the system has performed the self-diagnosis function. ➔ Contact your nearest Sony dealer or local authorized Sony service facility and give the 5-character service number. Example: E 61 10

### When displaying the version number on the screen

When you turn on the system, the version number [VER.X.XX] (X is a number) may appear on the screen. Although this is not a malfunction and for Sony service use only, normal system operation will not be possible. Turn off the system, and then turn on the system again to operate.



## Specifications

### Amplifier section

Stereo mode (rated)	108 W + 108 W (3 ohms at 1 kHz, 1 % THD)
Surround mode (reference)	RMS output power, 10 % THD Front: 142 W + 142 W (with SS-TS52) Center*: 142 W (with SS-CT51) Surround*: 142 W + 142 W (with SS-TS51) Subwoofer*: 140 W (with SS-WS51)

\* Depending on the sound field settings and the source, there may be no sound output.

Inputs (Analog)	
AUDIO IN	Sensitivity: 250/125 mV
Outputs (Analog)	
Phones	Accepts low-and high-impedance headphones.

### DVD system

Laser	Semiconductor laser (DVD: $\lambda = 650 \text{ nm}$ ) (CD: $\lambda = 790 \text{ nm}$ ) Emission duration: continuous
Signal format system	PAL

### Tuner section

System	PLL quartz-locked digital synthesizer system
DAB tuner section	
Frequency range	
Band-III:	174.928 (5A) – 239.200 (13F) MHz For details, see “DAB frequency table” below.
Antenna (aerial) terminal	75-ohm, F female
FM tuner section	
Tuning range	87.5 – 108.0 MHz (50 kHz step)
Antenna (aerial)	FM wire antenna (aerial)
Antenna (aerial) terminals	75 ohms, unbalanced
Intermediate frequency	10.7 MHz
AM tuner section	
Tuning range	531 – 1,602 kHz (with the interval set at 9 kHz)
Antenna (aerial)	AM loop antenna (aerial)
Intermediate frequency	450 kHz

# DAB frequency table

## Band-III (174 to 240 MHz)

Frequency	Label	Frequency	Label
174.928 MHz	5A	209.936 MHz	10A
176.640 MHz	5B	211.648 MHz	10B
178.352 MHz	5C	213.360 MHz	10C
180.064 MHz	5D	215.072 MHz	10D
181.936 MHz	6A	216.928 MHz	11A
183.648 MHz	6B	218.640 MHz	11B
185.360 MHz	6C	220.352 MHz	11C
187.072 MHz	6D	222.064 MHz	11D
188.928 MHz	7A	223.936 MHz	12A
190.640 MHz	7B	225.648 MHz	12B
192.352 MHz	7C	227.360 MHz	12C
194.064 MHz	7D	229.072 MHz	12D
195.936 MHz	8A	230.784 MHz	13A
197.648 MHz	8B	232.496 MHz	13B
199.360 MHz	8C	234.208 MHz	13C
201.072 MHz	8D	235.776 MHz	13D
202.928 MHz	9A	237.488 MHz	13E
204.640 MHz	9B	239.200 MHz	13F
206.352 MHz	9C		
208.064 MHz	9D		

### Note

- Frequencies are displayed to two places of decimals on this system.
- This tuner does not support L-Band reception.

## Video section

Outputs	VIDEO: 1 V <sub>p-p</sub> 75 ohms COMPONENT: Y: 1 V <sub>p-p</sub> 75 ohms P <sub>B</sub> /C <sub>B</sub> , P <sub>R</sub> /C <sub>R</sub> : 0.7 V <sub>p-p</sub> 75 ohms R/G/B: 0.7 V <sub>p-p</sub> 75 ohms
---------	--

## Speakers

### Front

Speaker system	Bass reflex, magnetically shielded
Speaker unit	65 mm dia. cone type
Rated impedance	3 ohms
Dimensions (approx.)	92 × 220 × 83 mm (w/h/d)
Mass (approx.)	0.7 kg

### Center

Speaker system	Bass reflex, magnetically shielded
----------------	------------------------------------

Speaker unit	65 mm dia. cone type
Rated impedance	3 ohms
Dimensions (approx.)	260 × 95 × 86 mm (w/h/d)
Mass (approx.)	0.7 kg

## Surround

Speaker system	Bass reflex, magnetically shielded
Speaker unit	65 mm dia. cone type
Rated impedance	3 ohms
Dimensions (approx.)	92 × 151 × 83 mm (w/h/d)
Mass (approx.)	0.6 kg

## Subwoofer

Speaker system	Bass reflex, magnetically shielded
Speaker unit	160 mm cone type
Rated impedance	3 ohms
Dimensions (approx.)	200 × 312 × 360 mm (w/h/d)
Mass (approx.)	5.6 kg

## General

Power requirements	220 – 240 V AC, 50/60 Hz
Power consumption	On: 150 W Standby: 0.3 W (at the Power Saving mode)
Dimensions (approx.)	430 × 55 × 365 mm (w/h/d) incl. projecting parts
Mass (approx.)	3.8 kg

Design and specifications are subject to change without notice.

## Unpacking

- Speakers (5)
- Subwoofer (1)
- DAB wire antenna (aerial) (1)
- AM loop antenna (aerial) (1)
- FM wire antenna (aerial) (1)
- Speaker cords (5 m × 4, 15 m × 2)
- Remote Commander (remote) (1)
- R6 (size AA) batteries (2)
- Calibration mic (1)
- Foot pads (1 set)
- Operating Instructions
- Speaker and TV connections (card) (1)

# Glossary

## **Album**

Section of a music piece or an image on a data CD containing MP3 audio tracks or JPEG files.

## **Chapter**

Subdivision of a title on a DVD. A title is composed of several chapters.

## **Digital Cinema Auto Calibration**

Digital Cinema Auto Calibration was developed by Sony to automatically measure and adjust the speaker settings to your listening environment in a short period of time.

## **Dolby Digital**

This movie theater sound format is more advanced than Dolby Surround Pro Logic. In this format, the surround speakers output stereo sound with an expanded frequency range, and a subwoofer channel for deep bass is independently provided. This format is also called "5.1" with the subwoofer channel designed as the 0.1 channel (since it functions only when a deep bass effect is needed). All six channels in this format are recorded separately for superior channel separation. Furthermore, since all the signals are processed digitally, less signal degradation occurs.

## **Dolby Pro Logic II**

Dolby Pro Logic II creates five full-bandwidth output channels from 2 channel sources. This is done using an advanced, high-purity matrix surround decoder that extracts the spatial properties of the original recording without adding any new sounds or tonal colorations.

### **■ Movie mode**

The Movie mode is for use with stereo television shows and all programs encoded in Dolby Surround. The result is enhanced soundfield directionality that approaches the quality of discrete 5.1-channel sound.

### **■ Music mode**

The Music mode is for use with any stereo music recordings, and provides a wide and deep sound space.

## **Dolby Surround Pro Logic**

As one method of decoding Dolby Surround, Dolby Surround Pro Logic produces four channels from 2 channel sound. Compared with the former Dolby Surround system, Dolby Surround Pro Logic reproduces left-to-right panning more naturally and localizes sounds more precisely. To take full advantage of Dolby Surround Pro Logic, you should have one pair of surround speakers and a center speaker. The surround speakers output monaural sound.

## **DTS**

Digital audio compression technology developed by Digital Theater Systems, Inc. This technology conforms to 5.1-channel surround. This format comprises of stereo rear channel and there is discrete subwoofer channel in this format. DTS provides the same 5.1 discrete channels of high quality digital audio. The good channel separation is realized due to the all channel data being recorded discretely and processed in digitally.

## **DVD**

A disc that contains up to 8 hours of moving pictures even though its diameter is the same as a CD.

The data capacity of a single-layer and single-sided DVD, at 4.7 GB (Giga Byte), is 7 times that of a CD. Furthermore, the data capacity of a dual-layer and single-sided DVD is 8.5 GB, a single-layer and double-sided DVD 9.4 GB, and a dual-layer and double-sided DVD 17 GB.

The picture data uses the MPEG 2 format, one of a worldwide standard of digital compression technology. The picture data is compressed to about 1/40 of its original size. The DVD also uses the variable rate coding technology that processes allocated data according to the status of the picture.

The audio data is recorded in Dolby Digital as well as in PCM, allowing you to enjoy more realistic audio presence.

Furthermore, various advanced functions such as the multi-angle, multilingual, and Parental Control functions are provided with the DVD.

## **DVD-RW**

A DVD-RW is a recordable and rewritable disc that is the same size as a DVD VIDEO. The DVD-RW has two different modes: VR mode



and Video mode. DVD-RWs created in Video mode have the same format as a DVD VIDEO, while discs created in VR (Video Recording) mode allow the contents to be programmed or edited.

### **DVD+RW**

A DVD+RW (plus RW) is a recordable and rewritable disc. DVD+RWs use a recording format that is comparable to the DVD VIDEO format.

### **File**

A JPEG image recorded on a DATA CD/DATA DVD. ("File" is an exclusive definition for this system.) A single file consists of a single image or movie.

### **Film based software, Video based software**

DVDs can be classified as Film based or Video based software. Film based DVDs contain the same images (24 frames per second) that are shown at movie theaters. Video based DVDs, such as television dramas or sit-coms, displays images at 30 frames (or 60 fields) per second.

### **Multi-angle function**

Various angles of a scene, or viewpoints of the video camera are recorded on some DVDs.

### **Multilingual function**

Several languages for the sound or subtitles in a picture are recorded on some DVDs.

### **Parental Control**

A function of the DVD to limit playback of the disc by the age of the users according to the limitation level in each country. The limitation varies from disc to disc; when it is activated, playback is completely prohibited, violent scenes are skipped or replaced with other scenes and so on.

### **Playback Control (PBC)**

Signals encoded on VIDEO CDs (Version 2.0) to control playback.

By using menu screens recorded on VIDEO CDs with PBC functions, you can enjoy playing simple interactive programs, programs with search functions, and so on.

### **Progressive format (sequential scanning)**

In contrast to the Interlace format, the progressive format can reproduce 50 - 60 frames per second by reproducing all scanning lines (525 lines for the NTSC system, 625 lines for the PAL system). The overall picture quality increases and still images, text and horizontal lines appear sharper. This format is compatible with the 525 or 625 progressive format.

### **Region Code**

This system is used to protect copyrights. A region number is allocated on each DVD system or DVD disc according to the sales region. Each region code is shown on the system as well as on the disc packaging. The system can play discs that match its region code. The system can also play discs with the "Ⓜ" mark. Even when the region code is not shown on the DVD, the region limit may still apply.

### **Scene**

On a VIDEO CD with PBC (playback control) functions, the menu screens, moving pictures and still pictures are divided into sections called "scenes."

### **Title**

The longest section of a picture or music feature on a DVD, movie, etc., in video software, or the entire album in audio software.

### **Track**

Section of a picture or a music piece on a VIDEO CD, CD, or MP3. An album is composed of several tracks (MP3 only).

### **VIDEO CD**

A compact disc that contains moving pictures. The picture data uses the MPEG 1 format, one of a worldwide standard of digital compression technology. The picture data is compressed to about 1/140 of its original size. Consequently, a 12 cm VIDEO CD can contain up to 74 minutes of moving pictures.

VIDEO CDs also contain compact audio data. Sounds outside the range of human hearing are compressed while sounds we can hear are not compressed. VIDEO CDs can hold 6 times the audio information of conventional audio CDs. There are 2 versions of VIDEO CDs.

- Version 1.1: You can play only moving pictures and sounds.
- Version 2.0: You can play high-resolution still pictures and enjoy PBC functions.

This system conforms to both versions.

# Language Code List

The language spellings conform to the ISO 639: 1988 (E/F) standard.

Code Language	Code Language	Code Language	Code Language
1027 Afar	1183 Irish	1347 Maori	1507 Samoan
1028 Abkhazian	1186 Scots Gaelic	1349 Macedonian	1508 Shona
1032 Afrikaans	1194 Galician	1350 Malayalam	1509 Somali
1039 Amharic	1196 Guarani	1352 Mongolian	1511 Albanian
1044 Arabic	1203 Gujarati	1353 Moldavian	1512 Serbian
1045 Assamese	1209 Hausa	1356 Marathi	1513 Siswati
1051 Aymara	1217 Hindi	1357 Malay	1514 Sesotho
1052 Azerbaijani	1226 Croatian	1358 Maltese	1515 Sundanese
1053 Bashkir	1229 Hungarian	1363 Burmese	1516 Swedish
1057 Byelorussian	1233 Armenian	1365 Nauru	1517 Swahili
1059 Bulgarian	1235 Interlingua	1369 Nepali	1521 Tamil
1060 Bihari	1239 Interlingue	1376 Dutch	1525 Telugu
1061 Bislama	1245 Inupiak	1379 Norwegian	1527 Tajik
1066 Bengali; Bangla	1248 Indonesian	1393 Occitan	1528 Thai
1067 Tibetan	1253 Icelandic	1403 (Afan)Oromo	1529 Tigrinya
1070 Breton	1254 Italian	1408 Oriya	1531 Turkmen
1079 Catalan	1257 Hebrew	1417 Punjabi	1532 Tagalog
1093 Corsican	1261 Japanese	1428 Polish	1534 Setswana
1097 Czech	1269 Yiddish	1435 Pashto;	1535 Tonga
1103 Welsh	1283 Javanese	Pushto	1538 Turkish
1105 Danish	1287 Georgian	1436 Portuguese	1539 Tsonga
1109 German	1297 Kazakh	1463 Quechua	1540 Tatar
1130 Bhutani	1298 Greenlandic	1481 Rhaeto-	1543 Twi
1142 Greek	1299 Cambodian	Romance	1557 Ukrainian
1144 English	1300 Kannada	1482 Kirundi	1564 Urdu
1145 Esperanto	1301 Korean	1483 Romanian	1572 Uzbek
1149 Spanish	1305 Kashmiri	1489 Russian	1581 Vietnamese
1150 Estonian	1307 Kurdish	1491 Kinyarwanda	1587 Volapük
1151 Basque	1311 Kirghiz	1495 Sanskrit	1613 Wolof
1157 Persian	1313 Latin	1498 Sindhi	1632 Xhosa
1165 Finnish	1326 Lingala	1501 Sangho	1665 Yoruba
1166 Fiji	1327 Laothian	1502 Serbo-	1684 Chinese
1171 Faroese	1332 Lithuanian	Croatian	1697 Zulu
1174 French	1334 Latvian;	1503 Singhalese	
1181 Frisian	Lettish	1505 Slovak	
	1345 Malagasy	1506 Slovenian	1703 Not specified

## Parental Control Area Code List



Code Area	Code Area	Code Area	Code Area
2044 Argentina	2165 Finland	2362 Mexico	2149 Spain
2047 Australia	2174 France	2376 Netherlands	2499 Sweden
2046 Austria	2109 Germany	2390 New Zealand	2086 Switzerland
2057 Belgium	2248 India	2379 Norway	2528 Thailand
2070 Brazil	2238 Indonesia	2427 Pakistan	2184 United Kingdom
2079 Canada	2254 Italy	2424 Philippines	
2090 Chile	2276 Japan	2436 Portugal	
2092 China	2304 Korea	2489 Russia	
2115 Denmark	2363 Malaysia	2501 Singapore	

# Index to Parts and Controls

For more information, refer to the pages indicated in parentheses.

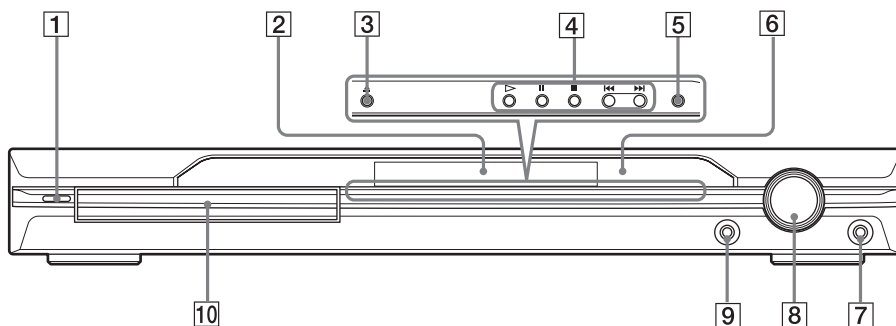
## Front panel



- |   |   |
|---|---|
| 1 I/⏻ (on/standby) (25)   | 6  (remote sensor) (9) |
| 2 Front panel display (85)  | 7 PHONES jack (25)  |
| 3  (open/close) (25) | 8 VOLUME control (25)   |
| 4 Disc operation (25)   | 9 AUDIO IN/A.CAL MIC jack (16, 26)  |
| 5 FUNCTION (25)   | 10 Disc tray (25)   |

## Rear panel

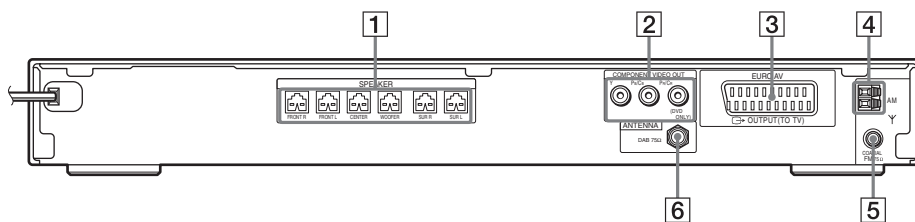

- |  |                             |
|--|-----------------------------|
| 1 SPEAKER jacks (10)   | 4 AM terminal (10)          |
| 2 COMPONENT VIDEO OUT jacks (21)   | 5 COAXIAL FM 75Ω jack (10)  |
| 3 EURO AV  OUTPUT (TO TV) jack (10, 21) | 6 ANTENNA DAB 75Ω jack (10) |

## Front panel display

### About the indications in the front panel display

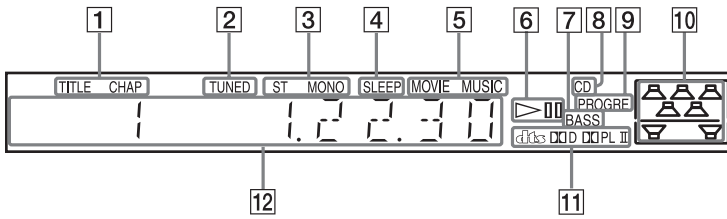

- 1 Lights up when the time information of a title or chapter appears in the front panel display. (DVD only) (40)
- 2 Lights up when a station is received. (Radio only) (50)
- 3 Monaural/Stereo effect (Radio only) (50)
- 4 Lights up when the sleep timer is set. (57)
- 5 Lights up when the music or movie mode is selected. (28)
- 6 Playing status (DVD function only)
- 7 Lights up when the DYNAMIC BASS is selected. (56)
- 8 Lights up when CD is loaded.
- 9 Lights up when the system outputs progressive signals (DVD function only). (22)
- 10 Indicates the selected [SPEAKER FORMATION]. (61)
- 11 Current surround format (Except for JPEG)
- 12 Displays system's status such as chapter, title, or track number, time information, radio frequency, playing status, sound field, etc.

## Guide to the Control Menu Display

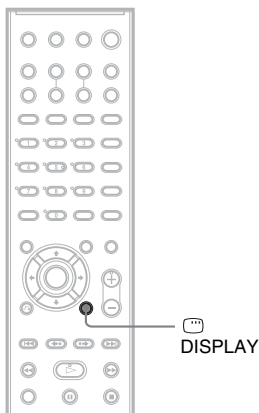

Use the Control Menu to select a function and to view related information. Press  DISPLAY repeatedly to turn on or change the Control Menu display as follows:

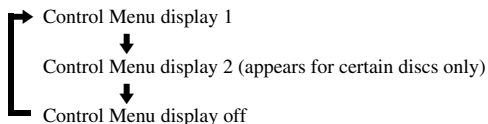

---

### Control Menu display

The Control Menu display 1 and 2 will show different items depending on the disc type. For details about each item, see the pages in parentheses.

Example: Control Menu display 1 when playing a DVD VIDEO.

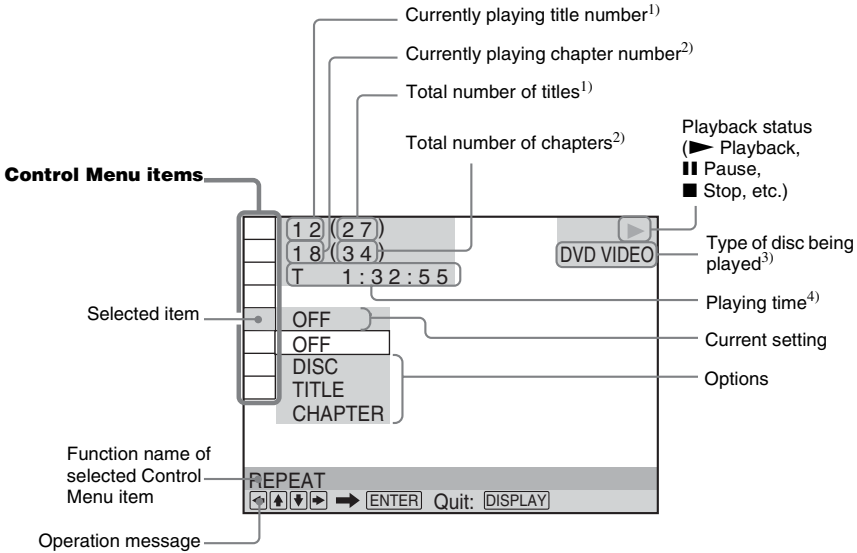

<sup>1)</sup>Displays the scene number for VIDEO CDs (PBC is on), track number for VIDEO CDs/CDs, album number for DATA CDs/DATA DVDs.

<sup>2)</sup>Displays the index number for VIDEO CDs, MP3 audio track number, or JPEG image file number for DATA CDs/DATA DVDs.

<sup>3)</sup>Displays Super VCD as "SVCD." Displays "MP3" in the Control Menu display 1 or "JPEG" in the Control Menu 2 for DATA CDs/DATA DVDs.

<sup>4)</sup>Displays the date for JPEG files.













## To turn off the display

Press DISPLAY.



## List of Control Menu items

Item	Item Name, Function, Relevant Disc Type
	[TITLE] (page 32)/[SCENE] (page 32)/[TRACK] (page 32) Selects the title, scene, or track to be played. <span style="float: right;">DVD-V DVD-VR VIDEO CD</span>
	[CHAPTER] (page 32)/[INDEX] (page 32) Selects the chapter or index to be played. <span style="float: right;">DVD-V DVD-VR VIDEO CD</span>
	[TRACK] (page 32) Selects the track to be played. <span style="float: right;">C D DATA-CD DATA DVD</span>
	[ORIGINAL/PLAY LIST] (page 40) Selects the type of titles (DVD-RW/DVD-R) to be played, the [ORIGINAL] one, or an edited [PLAY LIST]. <span style="float: right;">DVD-VR</span>
	[TIME/TEXT] (page 32) Checks the elapsed time and the remaining playback time. Input the time code for picture and music searching. Displays the DVD/CD text or the MP3 track name. <span style="float: right;">DVD-V DVD-VR VIDEO CD C D DATA-CD DATA DVD</span>

continued

	<p><b>[SPEAKER FORMATION] (pages 61, 63)</b> Sets the speaker formation./Adjust the level of each speaker automatically.</p> <p>DVD-V DVD-VR VIDEO CD C D DATA-CD DATA DVD</p>
	<p><b>[PROGRAM] (page 34)</b> Selects the track to play in the order you want.</p> <p>VIDEO CD C D</p>
	<p><b>[SHUFFLE] (page 36)</b> Plays the track in random order.</p> <p>VIDEO CD C D DATA-CD DATA DVD</p>
	<p><b>[REPEAT] (page 37)</b> Plays the entire disc (all titles/all tracks/all albums) repeatedly or one title/chapter/track/album repeatedly.</p> <p>DVD-V DVD-VR VIDEO CD C D DATA-CD DATA DVD</p>
	<p><b>[A/V SYNC] (page 43)</b> Adjusts the delay between the picture and sound.</p> <p>DVD-V DVD-VR VIDEO CD</p>
	<p><b>[PARENTAL CONTROL] (page 58)</b> Sets to prohibit playback on this system.</p> <p>DVD-V DVD-VR VIDEO CD C D DATA-CD DATA DVD</p>
	<p><b>[SETUP] (page 65)</b> [QUICK] Setup (page 16) Use Quick Setup to choose the desired language of the on-screen display, the aspect ratio of the TV, speaker formation, and choose yes or no to start the Auto Calibration. [CUSTOM] Setup In addition to the Quick Setup setting, you can adjust various other settings. [RESET] Returns the settings in [SETUP] to the default setting.</p> <p>DVD-V DVD-VR VIDEO CD C D DATA-CD DATA DVD</p>
	<p><b>[ALBUM] (page 32)</b> Selects the album to be played.</p> <p>DATA-CD DATA DVD</p>
	<p><b>[FILE] (page 32)</b> Selects the JPEG image file to be played.</p> <p>DATA-CD DATA DVD</p>
	<p><b>[DATE] (page 42)</b> Displays the date the picture was taken by a digital camera.</p> <p>DATA-CD DATA DVD</p>
	<p><b>[INTERVAL] (page 47)</b> Specifies the duration for which the slides are displayed on the screen.</p> <p>DATA-CD DATA DVD</p>
	<p><b>[EFFECT] (page 47)</b> Selects the effects to be used for changing slides during a slide show.</p> <p>DATA-CD DATA DVD</p>
	<p><b>[MODE (MP3, JPEG)] (page 47)</b> Selects the data type; MP3 audio track (AUDIO), JPEG image file (IMAGE) or both (AUTO) to be played when playing a DATA CD/DATA DVD.</p> <p>DATA-CD DATA DVD</p>

**Tip**

- The Control Menu icon indicator lights up in green  →  when you select any item except [OFF] ([PROGRAM], [SHUFFLE], [REPEAT], and [A/V SYNC] only). The [ORIGINAL/PLAY LIST] indicator lights up in green when you select [PLAY LIST] (default setting).



# DVD Setup Display List

You can set the following items with the DVD Setup Display.

The order of the displayed items may be different from the actual display.

## LANGUAGE SETUP

- OSD\*
- MENU\*
- AUDIO\*
- SUBTITLE\*

## CUSTOM SETUP

- PAUSE MODE
  - AUTO
  - FRAME
- TRACK SELECTION
  - OFF
  - AUTO
- MULTI-DISC RESUME
  - ON
  - OFF
- AUDIO DRC
  - OFF
  - STANDARD
  - MAX

## SCREEN SETUP

- TV TYPE
  - 16:9
  - 4:3 LETTER BOX
  - 4:3 PAN SCAN
- SCREEN SAVER
  - ON
  - OFF
- BACKGROUND
  - JACKET
  - PICTURE
  - GRAPHICS
  - BLUE
  - BLACK
- LINE
  - VIDEO
  - RGB
- 4:3 OUTPUT
  - FULL
  - NORMAL

## SPEAKER SETUP

- SIZE
  - FRONT
    - YES
    - CENTER
      - YES
      - NONE
    - SURROUND
      - YES
      - NONE
    - SUBWOOFER — YES
- DISTANCE (FRONT)
  - L ———— 1.0 m – 7.0 m
  - R ———— 1.0 m – 7.0 m
  - CENTER — 0.0 m – 7.0 m
- DISTANCE (SURROUND)
  - L ———— 0.0 m – 7.0 m
  - R ———— 0.0 m – 7.0 m
- LEVEL (FRONT)
  - L ———— -6.0 dB – 0.0 dB
  - R ———— -6.0 dB – 0.0 dB
  - CENTER — -6.0 dB – +6.0 dB
  - SUBWOOFER — -6.0 dB – +6.0 dB
- LEVEL (SURROUND)
  - L ———— -6.0 dB – +6.0 dB
  - R ———— -6.0 dB – +6.0 dB
- TEST TONE
  - OFF
  - ON

\* Select the language you want to use from the displayed language list.

## AMP Menu List

You can set the following items with AMP MENU on the remote.

### AMP menu

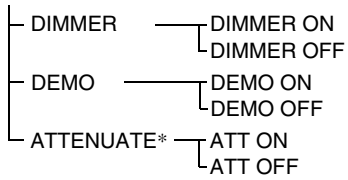

\* “ATTENUATE” may not appear depending on the selected function.

## Numerics

- 16:9 67
- 4:3 LETTER BOX 67
- 4:3 OUTPUT 68
- 4:3 PAN SCAN 67
- 5.1 Channel Surround 39

## A

- A/V SYNC 43
- ALBUM 32
  - Album 80
- AMP MENU 19, 26, 57
- AMP menu list 90
- ANGLE 42
- ATTENUATE 26
- AUDIO 67
- AUDIO DRC 69
- Auto Calibration 63, 80

## B

- BACKGROUND 68
- Batteries 9

## C

- CHAPTER 32
  - Chapter 80
- COLD RESET 72
- COMPONENT VIDEO OUT 22
  - Continuous play 25
  - Control Menu Display 86
  - Controlling the TV 55
- CUSTOM 65
- CUSTOM PARENTAL CONTROL 58
- CUSTOM SETUP 69

## D

- D. C. A. C. 63, 80
- DAB (Digital Audio Broadcasting)
  - DAB INICIAL SCAN 52
  - Frequency table 79
  - Overview 5
- DATA CD 45
- DATA DVD 45
- DEMO 19
- Demonstration 19
- Digital Cinema Auto
  - Calibration 63, 80
- DIMMER 57

- DISPLAY 51
  - Dolby Digital 38, 80
  - Dolby Pro Logic II 80
  - Dolby Surround Pro Logic 80
- DTS 38, 80
- DVD 80
- DVD+RW 81
- DVD's menu 38
- DVD-RW 40, 80
- DYNAMIC BASS 56

## E

- EFFECT 48

## F

- Fast forward 31
- Fast reverse 31
- FILE 32
  - File 81
- Film based software 81
- Freeze Frame 31
- Front panel 84
- Front panel display 40, 84

## H

- Handling discs 74

## I

- INDEX 32
  - Installing the speakers on a wall 20
  - Instant Advance 25
  - Instant Replay 25
- INTERLACE 23
- INTERVAL 48

## J

- JPEG 44, 45

## L

- Language Code List 83
- LANGUAGE SETUP 67
- LINE 68
- Listening to other components 26
- Listening to TV sound 27
- Locating a specific point by watching the TV screen 31

## M

- MENU 67

- MODE (MP3, JPEG) 47
- MOVIE/MUSIC 28
- MP3 44, 45
- Multi Session CD 7
- Multi-angle function 42, 81
- MULTI-DISC RESUME 69
- Multilingual function 81
- MUTING 25

## N

- Naming preset stations 51

## O

- ORIGINAL 40
- OSD 67
- Other Component Hookup 24

## P

- PARENTAL CONTROL 59
  - Parental Control 81
- PAUSE MODE 69
- PBC Playback 49
- PICTURE NAVI 33, 46
- PLAY LIST 40
- Playback Control (PBC) 81
- Program Play 34
- PROGRESSIVE AUTO 22
- Progressive format 22, 81
- PROGRESSIVE VIDEO 23

## R

- Radio 50
- Radio Stations 50
- RDS 52
- Rear Panel 84
- Region Code 7, 81
- Remote 9, 55
- Repeat Play 37
- RESET 66
- Resume Play 33

## S

- Scan 31
- SCENE 32
- Scene 81
- SCREEN SAVER 68
- SCREEN SETUP 67
- Searching 31
- Selecting 28
- SETUP 65
  - Setup Display 65, 89
  - Shuffle Play 36

SLEEP 57  
Slide Show 47  
Slow-motion Play 31  
Sound Field 29  
SPEAKER FORMATION 61  
SPEAKER SETUP 70  
    DISTANCE 70  
    LEVEL 71  
    SIZE 70  
SUBTITLE 43, 67

## **T**

TEST TONE 71  
THEATRE SYNC 55  
TIME/TEXT 32  
TITLE 32  
Title 81  
TRACK 32  
Track 81  
TRACK SELECTION 69  
Troubleshooting 74  
TV Hookup 21  
TV TYPE 67

## **U**

Unpacking 79  
Usable discs 6

## **V**

VIDEO CD 81







# Remote control

## ALPHABETICAL ORDER

### A - O

- AMP MENU **25** (19, 26, 55, 57, 90)
- ANGLE **5** (42)
- AUDIO **4** (38)
- CLEAR **34** (32, 55, 66)
- D.TUNING **24** (50)
- DISC SKIP\* **18**
- DISPLAY **3** (40, 51)
- DYNAMIC BASS **23** (56)
- ENTER **13** (16, 19, 26, 32, 50, 58)
- FUNCTION **22** (22, 25, 26, 33, 50, 61)
- MENU **26** (38, 50)
- MOVIE/MUSIC **17** (28)
- MUTING **7** (25)
- Number buttons\*\* **15** (32, 50, 55, 58)

### P - Z

- PICTURE NAVI **6** (33, 55)
- PRESET +/- **28** **32** (50, 54)
- PROGRESSIVE **35** (22)
- SLEEP **19** (57)
- SOUND FIELD **16** (29)
- SUBTITLE **24** (43)
- THEATRE SYNC **20** (56)
- TOP MENU **14** (38)
- TUNING +/- **10** **12** (50, 53)
- TV **30** (55)
- TV CH +/- **21** (55)
- TV VOL +/- **36** (55)
- TV/VIDEO **2** (55)
- VOLUME +/-\*\* **8** (25, 50, 71)

## BUTTON DESCRIPTIONS

- 1** (on/standby) **1** (16, 19, 25, 33, 50)
- TV **1** (on/standby) **37** (55)
- 2** (16, 19, 26, 32, 50, 58)
- 3** REPLAY/  
ADVANCE **9** (25)
- 4** **32** **28** (25)
- 5** **12** **10** (31)
- 6** SLOW **12** **10** (31)
- 7** (play)\*\* **31** (25, 33, 59)
- 8** STEP **9** (31)
- 9** (stop) **29** (25, 33, 58)
- 10** (pause) **11** (25)
- 11** DISPLAY **27** (18, 32, 58, 86)
- 12** RETURN **33** (33)
- 13** (55)

\* The DISC SKIP button is not available for this model.

\*\* The **7**, number **5**, and VOLUME + buttons have tactile dots. Use the tactile dots as references when operating the system.

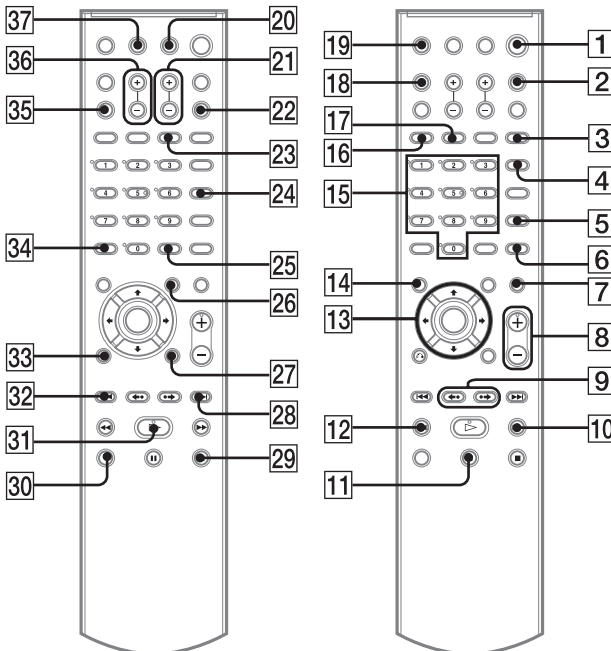



## Free Manuals Download Website

<http://myh66.com>

<http://usermanuals.us>

<http://www.somanuals.com>

<http://www.4manuals.cc>

<http://www.manual-lib.com>

<http://www.404manual.com>

<http://www.luxmanual.com>

<http://aubethermostatmanual.com>

Golf course search by state

<http://golfingnear.com>

Email search by domain

<http://emailbydomain.com>

Auto manuals search

<http://auto.somanuals.com>

TV manuals search

<http://tv.somanuals.com>