

DVD Home Theatre System

Operating Instructions

WARNING

Caution – The use of optical instruments with this product will increase eye hazard.

Do not install the appliance in a confined space, such as a bookcase or built-in cabinet.

To reduce the risk of fire, do not cover the ventilation opening of the apparatus with newspapers, tablecloths, curtains, etc. Do not place the naked flame sources such as lighted candles on the apparatus. To reduce the risk of fire or electric shock, do not expose this apparatus to dripping or splashing, and do not place objects filled with liquids, such as vases, on the apparatus.

Do not expose batteries or apparatus with battery-installed to excessive heat such as sunshine, fire or the like.

To prevent injury, this apparatus must be securely attached to the floor/wall in accordance with the installation instructions.

Indoor use only.

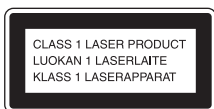

This appliance is classified as a CLASS 1 LASER product. This marking is located on the rear exterior.



Disposal of Old Electrical & Electronic Equipment (Applicable in the European Union and other European countries with separate collection systems)

This symbol on the product or on its packaging indicates that this

product shall not be treated as household waste. Instead it shall be handed over to the applicable collection point for the recycling of electrical and electronic equipment. By ensuring this product is disposed of correctly, you will help prevent potential negative consequences for the environment and human health, which could otherwise be caused by inappropriate waste handling of this product. The recycling of materials will help to conserve natural resources. For more detailed information about recycling of this product, please contact your local Civic Office, your household waste disposal service or the shop where you purchased the product.



Disposal of waste batteries (applicable in the European Union and other European countries with separate collection systems)

This symbol on the battery or on the packaging indicates that the battery provided with this product shall not be treated as household waste. On certain batteries this symbol might be used in combination with a chemical symbol. The chemical symbols for mercury (Hg) or lead (Pb) are added if the battery contains more than 0.0005% mercury or 0.004% lead. By ensuring these batteries are disposed of correctly, you will help prevent potentially negative consequences for the environment and human health which could otherwise be caused by inappropriate waste handling of the battery. The recycling of the materials will help to conserve natural resources. In case of products that for safety,

performance or data integrity reasons require a permanent connection with an incorporated battery, this battery should be replaced by qualified service staff only. To ensure that the battery will be treated properly, hand over the product at end-of-life to the applicable collection point for the recycling of electrical and electronic equipment. For all other batteries, please view the section on how to remove the battery from the product safely. Hand the battery over to the applicable collection point for the recycling of waste batteries. For more detailed information about recycling of this product or battery, please contact your local Civic Office, your household waste disposal service or the shop where you purchased the product.

Notice for customers: the following information is only applicable to equipment sold in countries applying EU directives.

The manufacturer of this product is Sony Corporation, 1-7-1 Konan Minato-ku Tokyo, 108-0075 Japan. The Authorized Representative for EMC and product safety is Sony Deutschland GmbH, Hedelfinger Strasse 61, 70327 Stuttgart, Germany. For any service or guarantee matters, please refer to the addresses given in separate service or guarantee documents.

Precautions

On power sources

- The unit is not disconnected from the mains as long as it is connected to the AC outlet, even if the unit itself has been turned off.
- As the main plug is used to disconnect the unit from the mains, connect the unit to an easily accessible AC outlet. Should you notice an abnormality in the unit, disconnect the main plug from the AC outlet immediately.

Copyrights

This system incorporates with Dolby* Digital and Dolby Pro Logic adaptive matrix surround decoder and the DTS** Digital Surround System.

- * Manufactured under license from Dolby Laboratories. Dolby, Pro Logic, and the double-D symbol are trademarks of Dolby Laboratories.
- ** Manufactured under license under U.S. Patent #'s: 5,451,942; 5,956,674; 5,974,380; 5,978,762; 6,487,535 & other U.S. and worldwide patents issued & pending. DTS and the Symbol are registered trademarks & DTS Digital Surround and the DTS logos are trademarks of DTS, Inc. Product includes software. © DTS, Inc. All Rights Reserved.

This system incorporates High-Definition Multimedia Interface (HDMI™) technology. HDMI, the HDMI logo and High-Definition Multimedia Interface are trademarks or registered trademarks of HDMI

Licensing LLC in the United States and other countries.

“DVD-RW,” “DVD-R,” “DVD+RW,” “DVD+R,” “DVD VIDEO,” and the “CD” logos are trademarks.

“BRAVIA” is a trademark of Sony Corporation.

“PLAYSTATION” is a trademark of Sony Computer Entertainment Inc.

MPEG Layer-3 audio coding technology and patents licensed from Fraunhofer IIS and Thomson.

Windows Media is either a registered trademark or trademark of Microsoft Corporation in the United States and/or other countries.

This product contains technology subject to certain intellectual property rights of Microsoft. Use or distribution of this technology outside of this product is prohibited without the appropriate license(s) from Microsoft.

About MPEG-4 Visual

THIS PRODUCT IS LICENSED UNDER THE MPEG-4 VISUAL PATENT PORTFOLIO LICENSE FOR THE PERSONAL AND NON-COMMERCIAL USE OF A CONSUMER FOR DECODING VIDEO IN COMPLIANCE WITH THE MPEG-4 VISUAL STANDARD (“MPEG-4 VIDEO”) THAT WAS ENCODED BY A CONSUMER ENGAGED IN A PERSONAL AND NON-

COMMERCIAL ACTIVITY AND/OR WAS OBTAINED FROM A VIDEO PROVIDER LICENSED BY MPEG LA TO PROVIDE MPEG-4 VIDEO. NO LICENSE IS GRANTED OR SHALL BE IMPLIED FOR ANY OTHER USE. ADDITIONAL INFORMATION INCLUDING THAT RELATING TO PROMOTIONAL, INTERNAL AND COMMERCIAL USES AND LICENSING MAY BE OBTAINED FROM MPEG LA, LLC. SEE [HTTP://WWW.MPEGLA.COM](http://WWW.MPEGLA.COM)

All other trademarks are trademarks of their respective owners.

About These Operating Instructions

- The instructions in these Operating Instructions describe the controls on the remote. You can also use the controls on the unit if they have the same or similar names as those on the remote.
- The Control Menu items may vary depending on the area.
- “DVD” may be used as a general term for a DVD VIDEO, DVD+RW/ DVD+R, and DVD-RW/ DVD-R.
- The default setting for menus is underlined.

Table of Contents

Precautions	3
About These Operating Instructions	3
Playable Discs/Files on a USB Device.....	5
Package Contents	9
Index to Parts and Controls	10
Guide to the Control Menu	14

Getting Started

Step 1: Installing the System	17
Step 2: Connecting the System ...	20
Step 3: Setting up the System	25

Playback

Playing a Disc	28
Playing Files on a Disc/USB Device	28
Other Playback Operations	30
Selecting the Playback Mode.....	33
Displaying the Information of a Disc/ USB Device	36
Enjoying the Audio/Video of the Connected Component	38

Tuner

Presetting Radio Stations	39
Listening to the Radio	39
Using the Radio Data System (RDS).....	40

Sound Effect

Selecting the Effect to Suit the Source	41
--	----

Convenient Functions

Using the Control for HDMI Function for “BRAVIA” Sync	42
Transferring Songs onto a USB Device.....	44
Using the Sleep Timer	46
Adjusting the Delay Between the Picture and Sound	47
Enjoying Multiplex Broadcast Sound	47
Changing the Input Level of the Sound from Connected Components	47











Settings

Changing the Brightness of the Front Panel Display.....	48
Setting the Demonstration Mode to On/Off	48
Reperforming the Quick Setup	48
Setting the System to Standby Mode Automatically	48
Performing Further Settings	49

Additional Information

Precautions	55
Troubleshooting	57
Specifications	64
Index	68

Playable Discs/Files on a USB Device

Type	Disc logo	Characteristics	Icon
DVD VIDEO	     	<ul style="list-style-type: none"> • DVD VIDEO • DVD-R/DVD-RW in DVD VIDEO format or video mode • DVD+R/DVD+RW in DVD VIDEO format 	DVD-V
DVD VIDEO in VR (Video Recording) mode	 	<ul style="list-style-type: none"> • DVD-R/DVD-RW in VR (Video Recording) mode (except for DVD-R DL) 	DVD-VR
VIDEO CD		<ul style="list-style-type: none"> • VIDEO CD (Ver. 1.1 and 2.0 discs) • Super VCD • CD-R/CD-RW/CD-ROM in video CD format or Super VCD format 	VIDEO CD
CD		<ul style="list-style-type: none"> • Audio CD • CD-R/CD-RW in audio CD format 	CD
DATA CD	–	<ul style="list-style-type: none"> • CD-R/CD-RW/CD-ROM in DATA CD format that contains the following kinds of files and conforms to ISO 9660¹⁾ Level 1/Level 2, or Joliet (extended format): <ul style="list-style-type: none"> – MP3 files²⁾³⁾ – JPEG image files⁴⁾ – Xvid/MPEG4 video files 	DATA CD
DATA DVD	–	<ul style="list-style-type: none"> • DVD-ROM/DVD-R/DVD-RW/DVD+R/DVD+RW in DATA DVD format that contains the following kinds of files and conforms to UDF (Universal Disk Format): <ul style="list-style-type: none"> – MP3 files²⁾³⁾ – JPEG image files⁴⁾ – Xvid/MPEG4 video files 	DATA DVD
USB device	–	<ul style="list-style-type: none"> • USB device that contains the following kinds of files: <ul style="list-style-type: none"> – MP3 files²⁾³⁾ or WMA/AAC files³⁾ – JPEG image files⁴⁾ – Xvid/MPEG4 video files 	USB

- ¹) A logical format of files and folders on CD-ROMs, defined by ISO (International Organization for Standardization).
- ²) MP3 (MPEG1 Audio Layer 3) is a standard format defined by ISO/MPEG for compressed audio data. MP3 files must be in MPEG1 Audio Layer 3 format.
- ³) Files with copyright protection (Digital Rights Management) cannot be played by the system.
- ⁴) JPEG image files must conform to the DCF image file format. (DCF “Design rule for Camera File system”: Image standards for digital cameras regulated by Japan Electronics and Information Technology Industries Association (JEITA).)

Notes on discs

This product is designed to playback discs that conform to the Compact Disc (CD) standard. DualDiscs and some music discs encoded with copyright protection technologies do not conform to the Compact Disc (CD) standard. Therefore, these discs may not be compatible with this product.

Example of discs that the system cannot play

The system cannot play the following discs:

- CD-ROM/CD-R/CD-RW other than those recorded in the formats listed on page 5
- CD-ROM recorded in PHOTO CD format
- Data part of CD-Extra
- CD Graphics disc
- DVD Audio
- Super Audio CD
- DATA CD/DATA DVD that does not contain MP3 files, JPEG image files, Xvid video files, or MPEG4 video files
- DATA CD/DATA DVD that is created in Packet Write format
- DVD-RAM
- Blu-ray Disc

Also, the system cannot play the following discs:

- A DVD VIDEO with a different region code (page 7)
- A disc that has a non-standard shape (e.g., card, heart)
- A disc with paper or stickers on it
- A disc that has the adhesive of cellophane tape or a sticker stuck on it

Notes about CD-R/CD-RW/DVD-R/DVD-RW/DVD+R/DVD+RW

In some cases, CD-R/CD-RW/DVD-R/DVD-RW/DVD+R/DVD+RW cannot be played on this system due to the recording quality or physical condition of the disc, or the characteristics of the recording device and authoring software.

The disc will not play if it has not been correctly finalized. For more information, refer to the operating instructions of the recording device.

Note that some playback functions may not work with some DVD+RWs/DVD+Rs, even if they have been correctly finalized. In this case, view the disc by normal playback. Also, some DATA CDs/DATA DVDs created in Packet Write format cannot be played.

Notes about Multi Session CD

- This system can play a Multi Session CD when an MP3 file is contained in the first session. Any subsequent MP3 files recorded in later sessions can also be played.
- This system can play a Multi Session CD when a JPEG image file is contained in the first session. Any subsequent JPEG image files recorded in later sessions can also be played.
- If MP3 files and JPEG image files in music CD format or video CD format are recorded in the first session, only the first session will be played.

Region code

Your system has a region code printed on the rear of the unit and will only play a DVD labeled with the same region code.

A DVD VIDEO labeled  will also play on this system.

If you try to play any other DVD VIDEO, the message [Playback prohibited by area limitations.] will appear on the TV screen. Depending on the DVD VIDEO, no region code indication may be given even though playing the DVD VIDEO is prohibited by area restrictions.

Notes about playback operations of a DVD or VIDEO CD

Some playback operations on a DVD or VIDEO CD may be intentionally set by software producers. Since this system will play a DVD or VIDEO CD according to the disc contents the software producers designed, some playback features may not be available. Be sure to read the operating instructions of the DVD or VIDEO CD.

Notes about playable files

- The system can recognize up to 200 folders, including albums (folders) that do not contain audio files, JPEG image files, or video files. When more than 200 folders are on the DATA CD/DATA DVD/USB device or more than 150 files are in a folder, folders/files that are recognized by the system differ depending on the folder configuration.
- The system can play the following files:

File	Extension of the file
MP3 file	“.mp3”
WMA file*	“.wma”
AAC file*	“.m4a”
JPEG image file	“.jpg” or “.jpeg”
Xvid video file	“.avi”
MPEG4 video file	“.mp4” or “.m4v”

* USB device only.

The system will attempt to play any data with the extensions above, even if it is not in MP3/WMA/AAC/JPEG/Xvid/MPEG4 format. Playing this data may generate a loud noise which could damage your speaker system.

- The following can increase the time it takes to start playback:
 - when a DATA CD/DATA DVD/USB device is recorded with a complicated tree structure.
 - when the audio files, JPEG image files, or video files in another folder have just been played.
- Some files on DATA CDs/DATA DVDs/USB devices cannot be played by the system depending on the file format.
- The system can play to a depth of 8 folders only.
- The system may not be able to play an audio file, JPEG image file, or video file depending on the file type.
- Files recorded by a device such as a computer may not be played in the order in which they were recorded.
- Folders that have no audio files, JPEG image files, or video files are skipped.
- Compatibility with all MP3/WMA/AAC encoding/writing software, recording devices, and recording media cannot be guaranteed.
- Compatibility with all MPEG4 video encoding/writing software, recording devices, and recording media cannot be guaranteed.
- The playback order may not be applicable depending on the software used for creating the audio file, JPEG image file, or video file, or if there are more than 200 folders or 150 files in each folder.

Notes about USB devices

- This system supports Mass Storage Class (MSC) devices.
- This system is not guaranteed to operate with all USB devices or memories.
- Although there are variety of complex functions for USB devices, the playable contents of USB devices connected to the system are music, photo, and video contents only. For details, refer to the operating instructions of the USB device.
- When a USB device is inserted, the system reads all the files on the USB device. If there are many folders or files on the USB device, it may take a long time to finish reading the USB device.
- Do not connect the system and a USB device through a USB hub.
- With some connected USB devices, there may be a delay before an operation is performed by this system.
- The playback order for the system may differ from the playback order of the connected USB device.
- Always turn off the system before removing a USB device. Removing the USB device while the system is on may corrupt the data on the USB device.
- Before using a USB device, make sure that no virus-ridden files are on the USB device.

Package Contents

Main unit

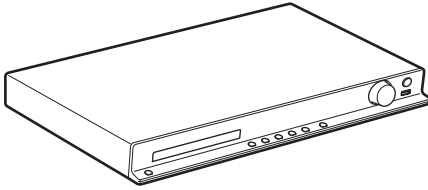

Speaker packages

- DAV-DZ340

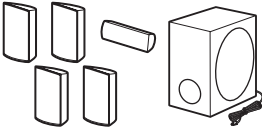

- DAV-DZ740

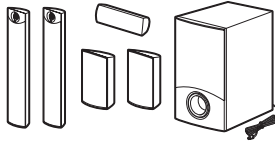

- Speaker cords (1 set)
(red/white/green/gray/blue)



- Foot pads (1 set)



- Speaker assembly parts for the tall speakers
For DAV-DZ740



Accessories

- Remote commander
(remote) (1)



- R6 (size AA) batteries (2)



- Operating Instructions
- Quick Setup Guide
- Speaker Installation Guide
(DAV-DZ740 only)

- FM wire antenna (aerial) (1)



or



Index to Parts and Controls

For more information, refer to the pages indicated in parentheses.

Front panel

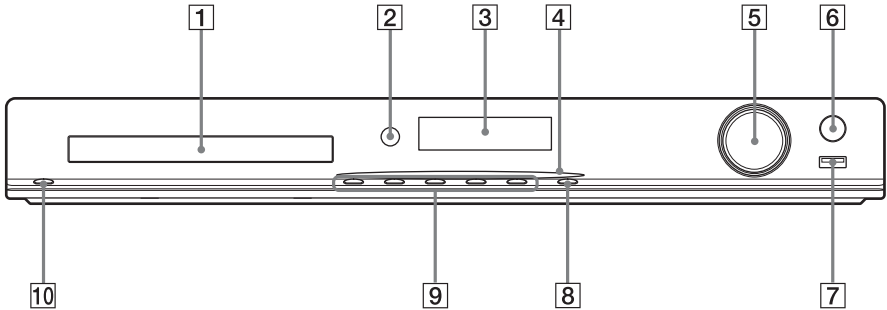

- 1 Disc tray**
- 2 Remote sensor**
Receives the remote signal. Point the remote toward here when using the remote.
- 3 Front panel display**
- 4 Power indicator (DAV-DZ740 only)**
Lights up while the system is turned on.
- 5 VOLUME control**
Adjusts the system's volume.
- 6 REC TO USB (page 44)**
Transfers tracks/MP3 files/radio programs onto a USB device.
Lights up during transfer of tracks/MP3 files/radio programs.
- 7 ↔ (USB) port (page 28)**
Used for connecting a USB device.
- 8 FUNCTION**
Selects the playback source.
- 9 Play operation buttons**
 - ▲ (open/close)**
Opens or closes the disc tray.
 - ▶ (play)**
Starts or restarts playback.
 - (stop)**
Stops playback and remembers the stop point (resume point).
 - ◀◀/▶▶ (previous/next)**
Skip to the previous/next chapter, track, or file.
- 10 I/⏻ (on/standby)**
Turns on the unit, or sets it to standby mode.

Rear panel

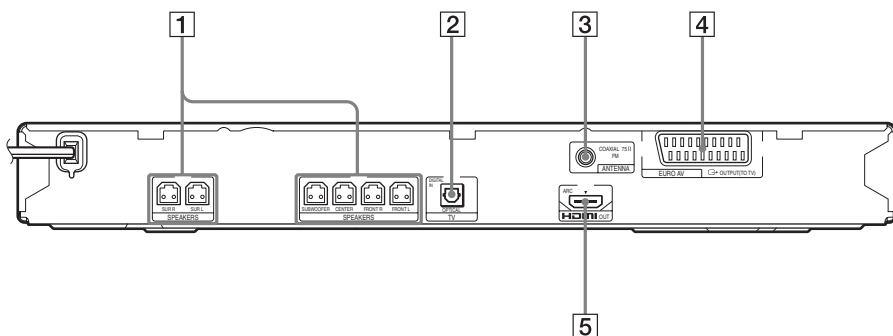

- 1 **SPEAKERS** jacks (page 20)
- 2 **TV (DIGITAL IN OPTICAL)** jack (page 21)
- 3 **ANTENNA (COAXIAL 75Ω FM)** jack (page 23)
- 4 **EURO AV**  **OUTPUT (TO TV)** jack (page 21)
- 5 **HDMI OUT** jack (page 21)

Remote control

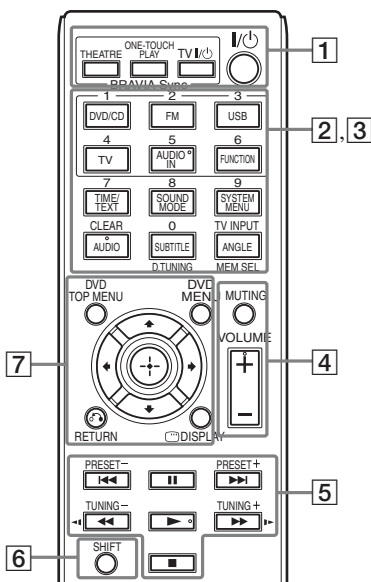

The number 5/AUDIO IN, VOLUME +, AUDIO, and ► buttons have a tactile dot. Use the tactile dot as a reference when operating the remote.

1 THEATRE (page 42)

Switches to the optimum video mode for watching movies automatically.

Depending on your TV, this function may not work.

ONE-TOUCH PLAY (page 42)

Activates One-Touch Play.

TV I/⏻ (on/standby)*

Turns on your TV or sets it to standby mode.

I/⏻ (on/standby) (page 25)

Turns on the system or sets it to standby mode.

2 The following buttons have black/white text labels:

Function selection buttons (pages 28, 38, 39)

Select the playback source.

The system is turned on automatically when you press the function selection button while the system is turned off.

DVD/CD

FM

USB

TV

FUNCTION

Selects the functions in sequence.

TIME/TEXT (page 36)

Changes the information in the front panel display.

SOUND MODE (page 41)

Selects the sound mode.

SYSTEM MENU (pages 39, 46, 48)

Enters the system menu.

AUDIO (page 32)

Selects the audio format/track.

SUBTITLE (page 32)

Selects the subtitle language when multilingual subtitles are recorded on a DVD VIDEO.

ANGLE (page 32)

Switches to other viewing angles when multi-angles are recorded on a DVD VIDEO.

D.TUNING (page 39)

Selects the radio frequencies.

MEM SEL (pages 28, 44)

Selects the USB device's memory number for playback or transfer.

- 3** The following buttons have pink text labels, and function when you press and hold SHIFT ([6]):

Number buttons (pages 31, 39)

Enters the title/chapter numbers, radio frequencies, etc.

CLEAR (pages 30, 33, 46)

Clears the entry field.

TV INPUT*

Switches your TV's input source.

- 4** **MUTING**

Turns off the sound temporarily.

VOLUME +/- (page 28)

Adjusts the volume.

- 5** **Playback operation buttons**

See "Other Playback Operations" (page 30).

◀◀/▶▶ (previous/next)

◀◀/▶▶ (fast reverse/fast forward)

◀|/▶ (slow)

▶ (play)

|| (pause)

■ (stop)

Radio operation buttons

See "Listening to the Radio" (page 39).

PRESET +/-

TUNING +/-

- 6** **SHIFT**

Press and hold this button to use buttons with pink text labels ([3]).

- 7** **DVD TOP MENU (page 32)**

Opens or closes the DVD's Top Menu.

DVD MENU (page 32)

Opens or closes the DVD's menu.

←/↑/↓/→

Moves the highlight to a displayed item.

⊕ (ENTER)

Enters the selected item.

↶ RETURN (page 29)

Returns to the previous display.

☑ DISPLAY (pages 14, 25, 28, 30, 33, 42, 44, 49)

Displays playback information on the TV screen.

* Works with Sony TVs only. Depending on your TV, you may not be able to use some of the buttons.

Note

- The AUDIO IN button does not work for this model.

To insert the batteries

Insert two R6 (size AA) batteries (supplied) by matching the ⊕ and ⊖ ends on the batteries to the markings inside the compartment.

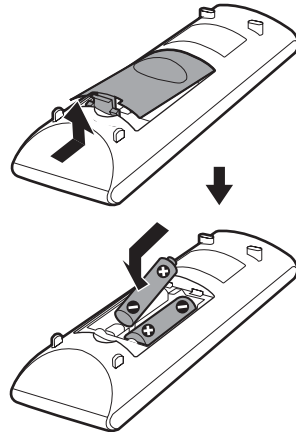



Note

- Do not leave the remote in an extremely hot or humid place.
- Do not use a new battery with an old one.
- Do not drop any foreign object into the remote casing, particularly when replacing the batteries.
- If you do not intend to use the remote for an extended period of time, remove the batteries to avoid possible damage from battery leakage and corrosion.

Guide to the Control Menu

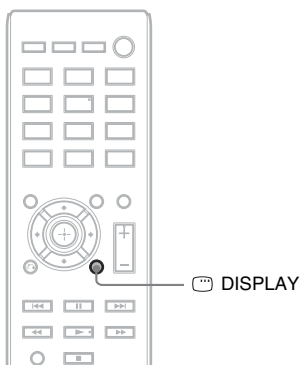
You can use the Control Menu to select a function and to view related information.



Press  DISPLAY while using the “DVD/CD” or “USB” function.

Each time you press  DISPLAY, the Control Menu changes:

① → ② → ③ → ① → ...

- ① Control Menu 1
- ② Control Menu 2 (appears when available)
- ③ Control Menu off

Control Menu



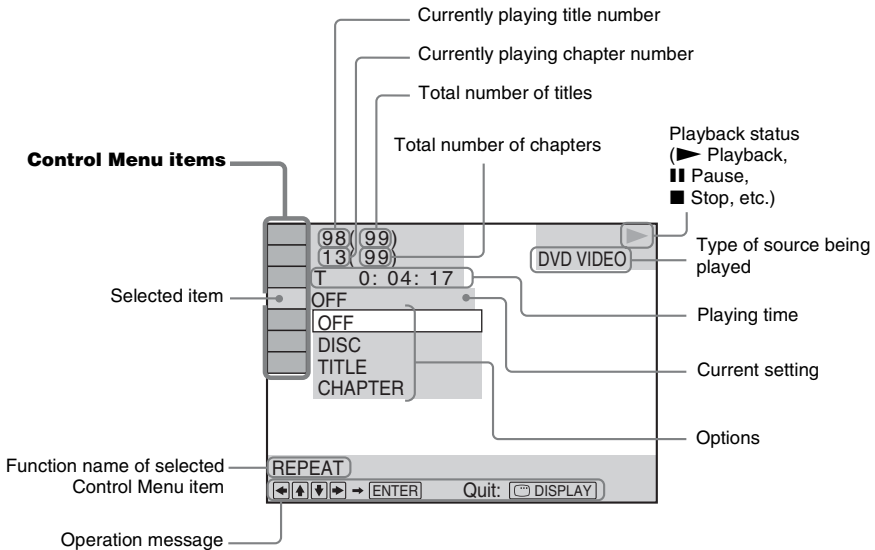





















































Example: Control Menu 1 when playing a DVD VIDEO.



List of Control Menu items

The Control Menus 1 and 2 will show different items depending on the source. For details, see the pages in parentheses in the chart below.

Item	Item Name, Function, Relevant Source
	[TITLE] (page 31)/[SCENE] (page 31)/[TRACK] (page 31) You can select the title, scene, or track to be played. DVD-V DVD-VR VIDEO CD
	[CHAPTER] (page 31)/[INDEX] (page 31) You can select the chapter or index to be played. DVD-V DVD-VR VIDEO CD
	[TRACK] (page 31) You can select the track to be played. CD DATA CD DATA DVD USB
	[ORIGINAL/PLAY LIST] (page 33) When using a DVD-RW/DVD-R, you can select the playback order ([ORIGINAL] or [PLAY LIST]). DVD-VR
	[TIME] (page 31) You can check the elapsed time and the remaining playback time. You can play from a desired point by inputting the time code (DVD VIDEO/DVD-VR only). DVD-V DVD-VR VIDEO CD CD DATA CD DATA DVD USB
	[PROGRAM] (page 33) You can select the track to play in the order you want. VIDEO CD CD
	[SHUFFLE] (page 34) You can play the tracks/files in random order. VIDEO CD CD DATA CD DATA DVD USB



	[REPEAT] (page 35) You can play the entire disc/USB device (all titles/all tracks/all folders/all files) repeatedly or one title/chapter/track/folder/file repeatedly.       
	[A/V SYNC] (page 47) You can adjust the delay between the picture and sound.      
	[DISC MENU] (page 32) You can display the DVD's menu. 
	[BROWSING] (page 29) You can display the list of folders/JPEG image files.   
	[SETUP] (page 49) [CUSTOM] In addition to the Quick Setup setting, you can adjust various other settings. [QUICK] (page 25) You can make basic adjustments.       
	[FOLDER] (page 31) You can select the folder to be played.   
	[FILE] (page 31) You can select the JPEG image file or video file to be played.   
 1)	[DATE] (page 38) You can display the date the picture was taken by a digital camera.   
 1)	[INTERVAL] (page 36) You can select the duration for which the slides are displayed on the TV screen.   
 1)	[EFFECT] (page 35) You can select the effects to be used for changing slides during a slide show.   
	[MEDIA] (page 30) You can select the playback priority of file types (MP3/AAC ² /WMA ²) files, JPEG image files, video files, or both MP3 and JPEG image files ³) to be played on a DATA CD/DATA DVD/USB device.   
	[USB TRANSFER] (page 44) You can transfer tracks on an audio CD or MP3 files on a DATA CD/DATA DVD onto a USB device.   

¹)These items are not displayed when playing a DATA CD/DATA DVD/USB device with video files.

²)USB device only.

³)DATA CD/DATA DVD only.

Tip

- The Control Menu icon indicator lights up yellow  →  when you select any item except [OFF] ([PROGRAM], [SHUFFLE], [REPEAT], and [A/V SYNC] only). The [ORIGINAL/PLAY LIST] indicator lights up yellow when you select [PLAY LIST] (default setting).

Step 1: Installing the System

How to position the system

Install the system by referring to the illustration below.

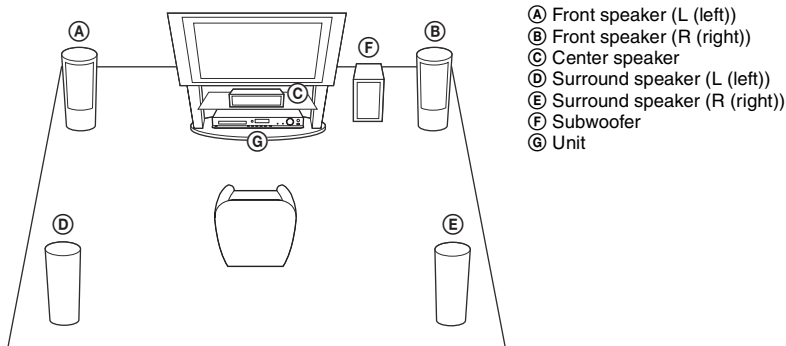

To attach the foot pads to the subwoofer

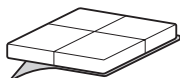

Remove the foot pads from the protective cover.

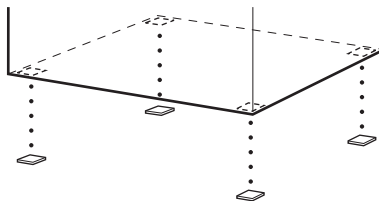

Note

- Use caution when placing the speakers and/or speaker stands attached to the speakers on a specially treated (waxed, oiled, polished, etc.) floor, as staining or discoloration may result.

Assembling the speakers

(DAV-DZ740 only)

For assembling the speakers refer to the supplied “Speaker Installation Guide.”

When installing the speakers on a wall

Caution

- Contact a screw shop or installer for information regarding the wall material or screws to be used.
- Use screws that are suitable for the wall material and strength. As a plaster board wall is especially fragile, attach the screws securely to a beam. Install the speakers on a vertical and flat wall where reinforcement is applied.
- Sony is not responsible for accidents or damage caused by improper installation, insufficient wall strength or improper screw installation, natural calamity, etc.

- 1 Connect the speaker cord with the color tube to \oplus , and the speaker cord without the color tube to \ominus .**

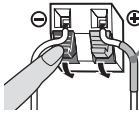

Color tube
 Front left speaker (L): White
 Front right speaker (R): Red
 Center speaker: Green
 Surround left speaker (L): Blue
 Surround right speaker (R): Gray

- 2 Prepare screws (not supplied) that are suitable for the hole on the back of each speaker. See the illustrations below.**

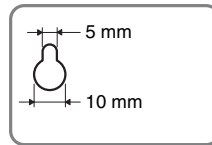
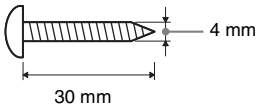

Hole on the back of the speaker

3 Fasten the screws to the wall, then hang the speaker on the wall.

Depth of fastened screw

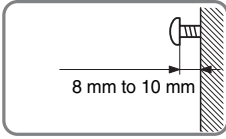

For the center speaker

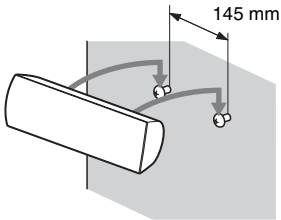

For the tall speakers (DAV-DZ740 only)

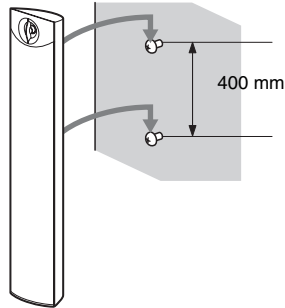

For the small speakers

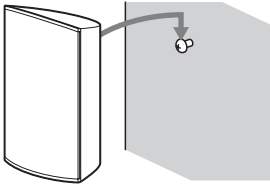

Step 2: Connecting the System

Connecting the speakers

- 1 Connect the speaker cord with the color tube to \oplus , and the speaker cord without the color tube to \ominus .

The subwoofer speaker cord is fixed to the subwoofer.

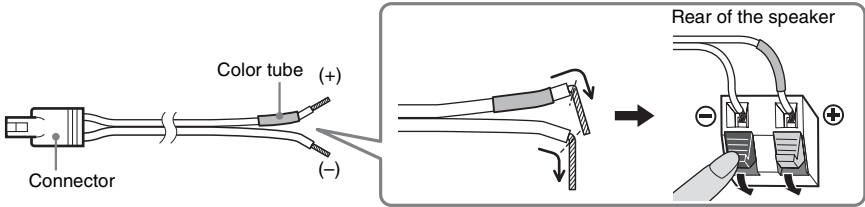

Note

- Do not catch the speaker cord insulation (rubber covering) in the speaker terminals.

- 2 Insert the connectors of the speaker cords to match the color of the **SPEAKERS** jacks of the unit until they click.

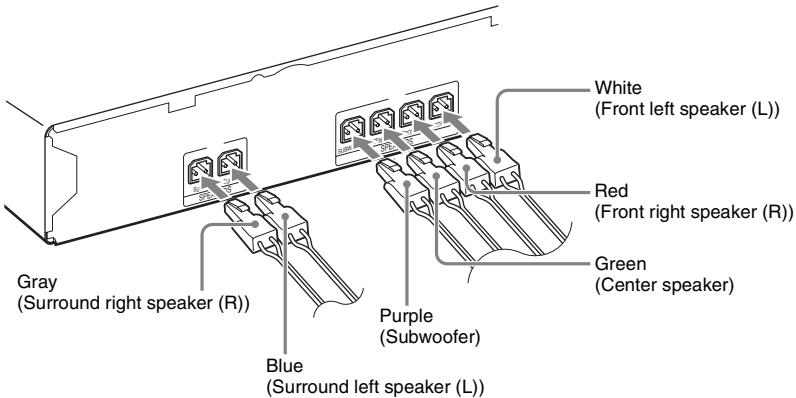

Connecting your TV/set-top box

When connecting to a TV only

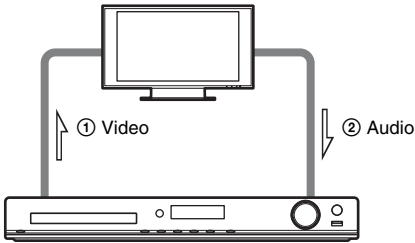

When connecting to a TV and set-top box

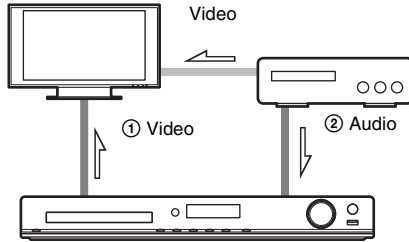

① Connecting the video to your TV

Depending on the jacks on your TV, select one of the connection methods.

■ Method 1: SCART (EURO AV) cable (not supplied) connection

This is the basic connection and sends both video and audio signals (analog stereo).

■ Method 2: HDMI cable (not supplied) connection

Picture quality will be improved compared to Method 1.

If your TV is compatible with the Audio Return Channel function, this connection also sends a digital audio signal from the TV. You do not need to make a separate audio connection for listening to TV sound. For details of the Audio Return Channel function, see “Receiving the digital audio signal of your TV” (page 43).

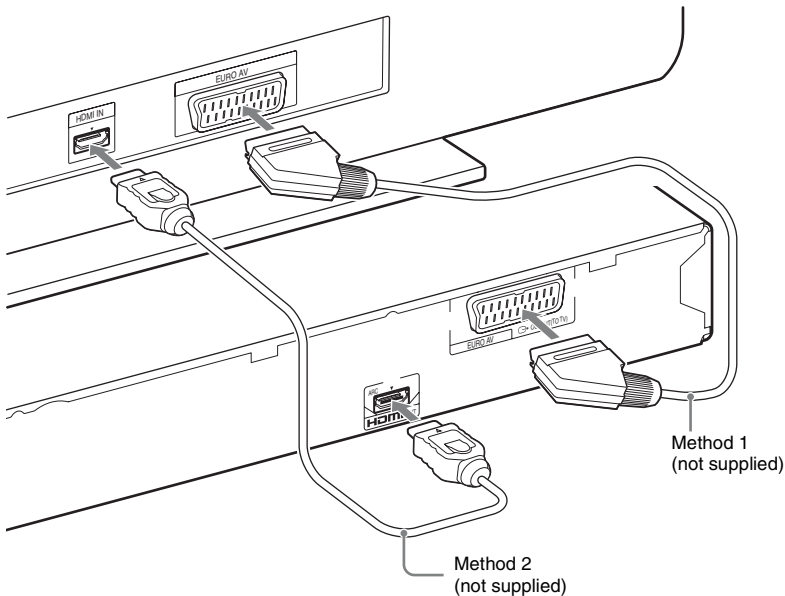

② Connecting the audio from your TV/set-top box

To listen to TV or set-top box sound via the system, select one of the connection methods.

■ Method 1: SCART (EURO AV) cable (not supplied) connection (for TV connection only)

For this connection, see Method 1 of “① Connecting the video to your TV.”

■ Method 2: Digital optical cord (not supplied) connection

This connection sends a digital audio signal from your TV/set-top box. To enjoy multi-channel audio, make this connection in addition to Method 1.

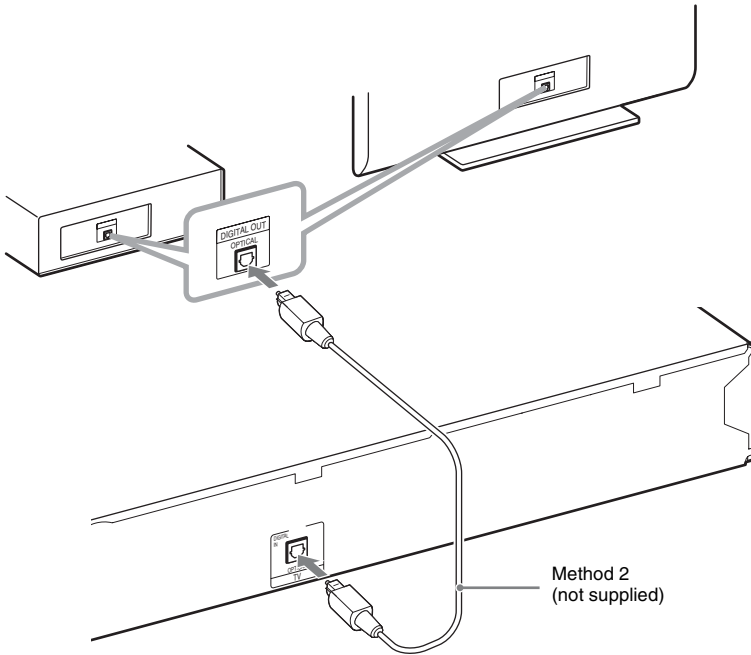

Note

- The system can accept both digital and analog signals. Digital signals have priority over analog signals. If the digital signal ceases, the analog signal will be processed after a few seconds.

Tip

- You can connect another component, such as a VCR, digital satellite receiver, or PlayStation, to the TV jack instead of your TV.

Connecting the antenna (aerial)

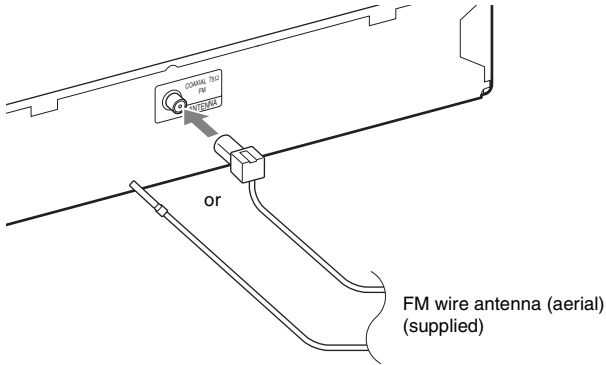
**Note**

- After connecting the FM wire antenna (aerial), extend and keep it as horizontal as possible.

Connecting the AC power cord (mains lead)

1 Connect the AC power cord (mains lead).

The demonstration appears in the front panel display.

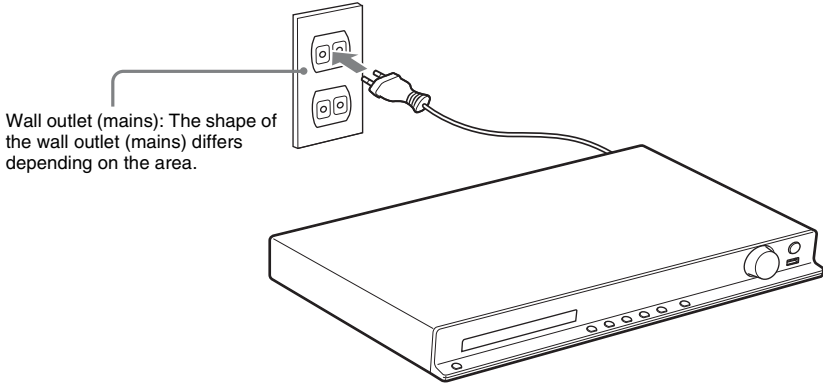

2 Press I/⏻ on the remote to turn the system on, then press I/⏻ again to turn off the demonstration.

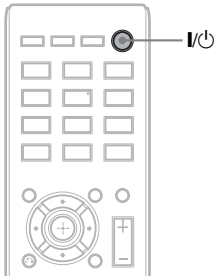

Step 3: Setting up the System

Performing the Quick Setup

Displayed items vary depending on the area and model.

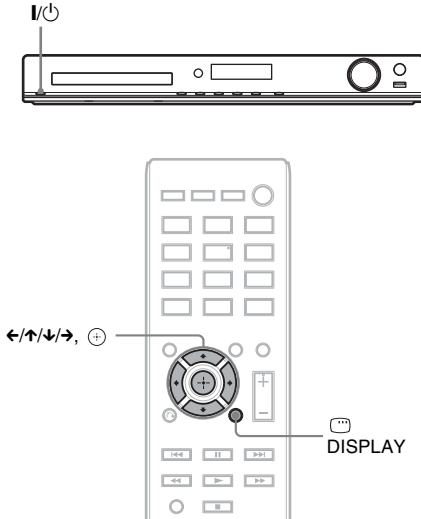

- 1** Turn on your TV.
- 2** Switch the input selector on your TV so that the signal from the system appears on the TV screen.
- 3** Press I/O to turn the system on.
- 4** Press ⊕ without inserting a disc or connecting a USB device.

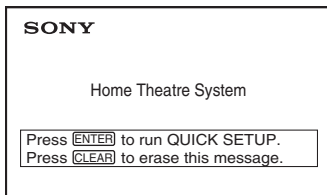

Note

- If this message does not appear, press DVD/CD. If this message still does not appear, recall the Quick Setup display (page 48).

- 5** Press ↑/↓ to select a language, then press ⊕.

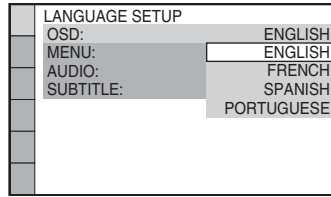

- 6** Press ↑/↓ to select the setting that matches your TV type, then press ⊕.

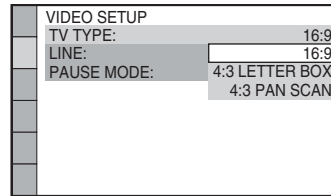

- [16:9]: This aspect ratio is for a wide-screen TV or a 4:3 standard TV with a wide-screen mode (page 50).
- [4:3 LETTER BOX] or [4:3 PAN SCAN]: This aspect ratio is for a 4:3 standard TV (page 50).

- 7** Press ↑/↓ to select the output method for video signals, then press ⊕.

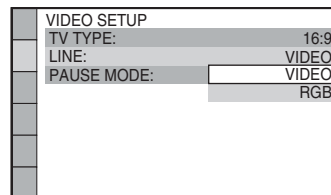

- [VIDEO]: Outputs video signals.
- [RGB]: Outputs RGB signals.

- 8** Press \uparrow/\downarrow to select the Control for HDMI setting, then press \oplus .

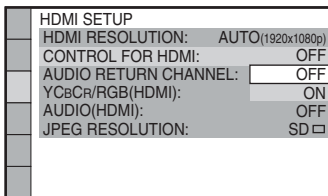

- [OFF]: The Control for HDMI function is set to off.
- [ON]: The Control for HDMI function is set to on.

To quit the Quick Setup

Press \square DISPLAY in any Step.

Setting the type of video output to match your TV

Depending on the connection of your TV (page 21), select the type of video output of the system.

To select the type of video signal output from the HDMI OUT jack

When you connect the unit and your TV with an HDMI cable, select the type of video signals output from the HDMI OUT jack.

- 1** Press DVD/CD.

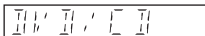

- 2** Press \square DISPLAY while the system is in stop mode.

- 3** Press \uparrow/\downarrow to select \square [SETUP], then press \oplus .

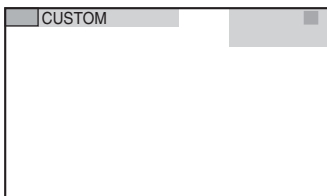

- 4** Press \uparrow/\downarrow to select [CUSTOM], then press \oplus .

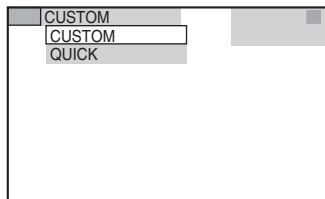

- 5** Press \uparrow/\downarrow to select [HDMI SETUP], then press \oplus .

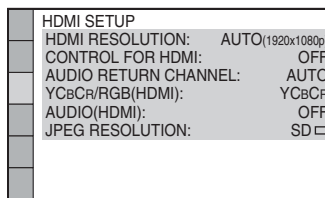

- 6** Press \uparrow/\downarrow to select [HDMI RESOLUTION], then press \oplus .

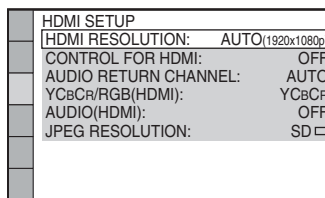

- 7** Press \uparrow/\downarrow to select the desired setting, then press \oplus .

HDMI SETUP	
HDMI RESOLUTION:	AUTO [1920x1080p]
CONTROL FOR HDMI	AUTO [1920x1080p]
AUDIO RETURN CH	1920x1080i
YCbCr/RGB(HDMI):	1280x720p
AUDIO(HDMI):	720x480p
JPEG RESOLUTION:	SD <input type="checkbox"/>

- **[AUTO (1920 × 1080p)]**: The system outputs the optimal video signal for the connected TV.
- **[1920 × 1080i]**: The system outputs 1920 × 1080i* video signals.
- **[1280 × 720p]**: The system outputs 1280 × 720p* video signals.
- **[720 × 480p]****: The system outputs 720 × 480p* video signals.

* i: interlace, p: progressive

** Depending on the area, [720 × 480/576p] may appear and the system may output 720 × 576p video signals.

Playing a Disc

DVD-V DVD-VR VIDEO CD CD

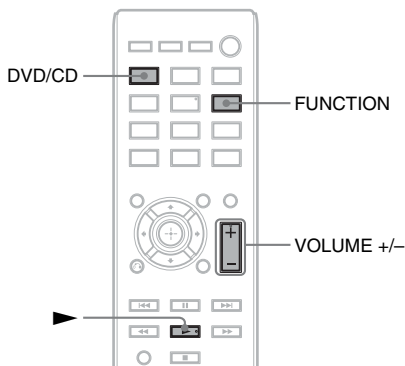
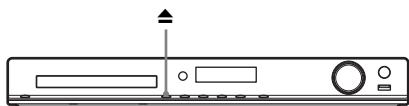

- 1** Press **DVD/CD**.
You can also select this function by pressing **FUNCTION** repeatedly.
- 2** Press **▲** to open the disc tray.
- 3** Place a disc on the tray, then press **▲**.

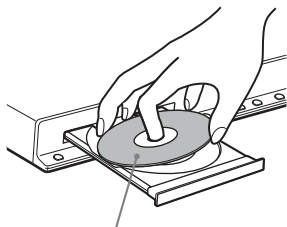

With the label side up

- 4** Press **▶** to start playback.
- 5** Press **VOLUME +/-** to adjust the volume.

Playing Files on a Disc/USB Device

DATA CD DATA DVD USB

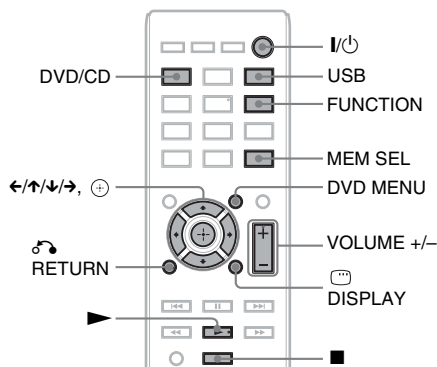
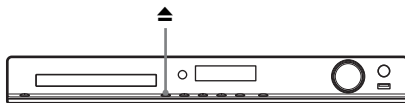

- 1** Press **DVD/CD** or **USB**.
 - **DVD/CD**: For a disc.
 - **USB**: For a USB device.
 You can also select the function by pressing **FUNCTION** repeatedly.
- 2** Load the source.
 - **For a disc**
Place a disc on the tray by pressing **▲** to open/close the disc tray.
 - **For a USB device**
Connect a USB device to the **↔** (USB) port.

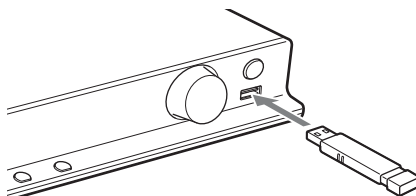

USB device

Note

- It may take about 10 seconds before “READING” appears in the front panel display depending on the type of USB device.

[FOLDER LIST] appears on the TV screen. If [FOLDER LIST] does not appear, press DVD MENU.

3 Press \uparrow/\downarrow to select a folder.

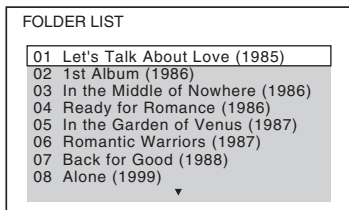

4 Press \blacktriangleright to start playback.

■ For video or audio files

The system starts playback of files in the selected folder.

■ For JPEG image files

The system starts a slide show of files in the selected folder.

5 Press VOLUME +/- to adjust the volume.

To select the playback source of the USB device

You can select the memory number for playback depending on the USB device.

Press MEM SEL.

Selected memory number

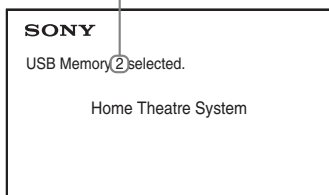
**Note**

- When the memory cannot be selected, [Operation not possible.] appears on the TV screen.
- The memory number changes depending on the USB device.

To remove the USB device

- 1 Press \blacksquare to stop playback.
- 2 Press I/power to turn off the system.
- 3 Remove the USB device.

Playing a specific file

DATA CD DATA DVD USB

1 Select a folder by following Steps in “Playing Files on a Disc/USB Device” (page 28).

2 Press \oplus to display the file list.

3 Select a file.

To return to the folder list, press RETURN .

■ For video or audio files

Press \uparrow/\downarrow to select a file.



■ For JPEG files

Press $\leftarrow/\uparrow/\downarrow/\rightarrow$ to select an image.

1	2	3	4
5	6	7	8
9	10	11	12
13	14	15	16

4 Start playback.

■ For video or audio files

Press \blacktriangleright to start playback from the selected file.

■ For JPEG image files

Press \blacktriangleright to start a slide show beginning with the selected file. Press \oplus to display only the selected file.

To turn on/off the list of folders/files

Press DVD MENU.

To display the list of folders/files using the Control Menu

- 1 Press DISPLAY.
- 2 Press \uparrow/\downarrow to select [BROWSING], then press \oplus .
- 3 Press \uparrow/\downarrow to select the desired list, then press \oplus .
 - [FOLDER LIST]: A list of folders appears. To display a list of files, press \uparrow/\downarrow to select a folder, then press \oplus .
 - [PICTURE LIST] (JPEG image files only): A thumbnail list of the JPEG image files in the folder appears.

When different file types are on a disc/USB device

DATA CD DATA DVD USB

You can select the file type that is played with priority when mixed media (audio files, JPEG image files, or video files) are on the disc/USB device.

- 1 Press DISPLAY.
- 2 Press \uparrow/\downarrow to select [MEDIA], then press \oplus .
- 3 Press \uparrow/\downarrow to select a setting, then press \oplus .
 - [MUSIC/PHOTO] (DATA CD/DATA DVD only): You can play both JPEG image files and MP3 files in the same folder as a slide show.
 - [MUSIC]: Audio file playback has priority.
 - [VIDEO]: Video file playback has priority.
 - [PHOTO]: JPEG image file playback has priority. You can play JPEG image files as a slide show.

The default setting differs depending on the source.

For details of the playback priority of file types under the [MEDIA] setting, see “Playback Priority of File Types” (page 66).

Other Playback Operations

Playback operation buttons on the remote

DVD-V DVD-VR VIDEO CD C D DATA CD
DATA DVD USB

Depending on the type of disc/file, the function may not work.

To	Press
Stop	
Pause	
Return to normal playback or resume playback after pause	
Cancel the resume point	twice.
Skip the current chapter, track, file, or scene	or • : go to the beginning. • Press twice in a second to go to the previous item. • : go to the next item.
Skip the current JPEG image file	or during playback. • : go to the previous file. • : go to the next item.
Locate a point quickly	or while playing a disc. • : fast reverse scan. • : fast forward scan. Each time you press or during scanning, the scan speed changes.

To	Press
Watch frame by frame	<p>II, then press ◀II/◀◀ or ▶▶/▶▶.</p> <ul style="list-style-type: none"> ◀II/◀◀: slow-motion play (reverse). ▶▶/▶▶: slow-motion play (forward). <p>Each time you press ◀II/◀◀ or ▶▶/▶▶ during slow-motion play, the playback speed changes.</p>
Rotate a JPEG image file	<p>↑/↓ while viewing a JPEG image file.</p> <p>Press CLEAR while holding down SHIFT to return to normal view.</p>

Tip

- When playing files, you can select the next folder by continuing to press **▶▶I** (→ for JPEG image files) after the last file on the current folder, but you cannot return to the previous folder by pressing **I◀◀** (← for JPEG image files). To return to the previous folder, select the folder from the folder list.
- You cannot rotate JPEG image files when you set [JPEG RESOLUTION] in [HDMI SETUP] to [(1920 × 1080i) HD □] or [(1920 × 1080i) HD] (page 51).

Playing a specific title/ chapter/track/scene, etc.

To select the title/chapter/track/ scene/index/folder/file number for playback

- DVD-V DVD-VR VIDEO CD C D DATA CD
DATA DVD USB

- Press **DISPLAY**.
- Press **↑/↓** to select the search method, then press **+**.
 - [TITLE/SCENE/TRACK]
 - [CHAPTER/INDEX]
 - [TRACK]
 - [FOLDER]
 - [FILE]

Example: [CHAPTER]
 [** (**)] is selected (** refers to a number).

The number in parentheses indicates the total number of titles, chapters, tracks, indexes, scenes, folders, or files.

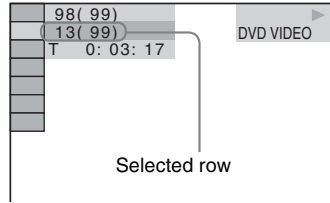

Note

- If [MEDIA] is set to [MUSIC/PHOTO] and [FILE] does not appear, press **DISPLAY** again.

- Press **↑/↓** to select the desired number of the title, chapter, track, scene, etc., then press **+**.

You can also select the number by pressing the number buttons while holding down **SHIFT**.

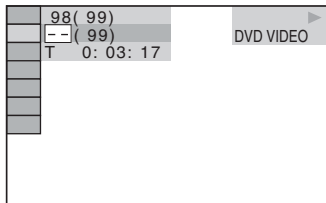

If you make a mistake, press **CLEAR** while holding down **SHIFT** to cancel the number.

To select a scene using the time code

- Press **DISPLAY**.
- Press **↑/↓** to select [TIME], then press **+**.
- Input the time code using the number buttons while holding down **SHIFT**, then press **+**.

For example, to find a scene at 2 hours, 10 minutes, and 20 seconds after the beginning: press 2, 1, 0, 2, 0 ([2:10:20]) while holding down **SHIFT**.

Note

- You cannot search for a scene on a DVD+RW using the time code.

Changing angles

DVD-V

Press **ANGLE** during playback to select the desired angle.

Displaying subtitles

DVD-V **DVD-VR**

Press **SUBTITLE** during playback to select the desired subtitle language.

Changing the audio

DVD-V **DVD-VR** **VIDEO CD** **C D** **DATA CD**
DATA DVD **USB**

Press **AUDIO** repeatedly during playback to select the sound.

■ DVD VIDEO

You can toggle audio format or language when the source contains multiple audio formats or multilingual audio.

When 4 digits are displayed, they indicate a language code. See “Language Code List” (page 67) to confirm which language the code represents.

When the same language is displayed two or more times, the DVD VIDEO is recorded in multiple audio formats.

Example:

Dolby Digital 5.1 channel

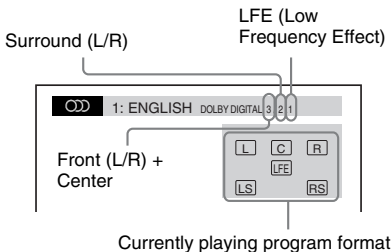
**■ DVD-VR**

You can toggle audio tracks when a disc contains multiple audio tracks.

■ VIDEO CD/CD/DATA CD (MP3 file)/DATA DVD (MP3 file)/USB device (audio file)

You can change the sound track.

- [**STEREO**]: The stereo sound.
- [**1/L**]: The sound of the left channel (monaural).
- [**2/R**]: The sound of the right channel (monaural).

■ DATA CD (Xvid video file)/DATA DVD (Xvid video file)/USB device (Xvid video file)

You can toggle audio tracks when a video file contains multiple audio tracks.

■ Super VCD

You can change the sound track.

- [**1:STEREO**]: The stereo sound of audio track 1.
- [**1:1/L**]: The sound of the left channel of audio track 1 (monaural).
- [**1:2/R**]: The sound of the right channel of audio track 1 (monaural).
- [**2:STEREO**]: The stereo sound of audio track 2.
- [**2:1/L**]: The sound of the left channel of audio track 2 (monaural).
- [**2:2/R**]: The sound of the right channel of audio track 2 (monaural).

Using the DVD's menu

DVD-V

When you play a DVD which contains several titles, you can select the title you want using **DVD TOP MENU**.

When you play a DVD that allows you to select items such as the language for the subtitles and the language for the sound, select these items using **DVD MENU**.

1 Press **DVD TOP MENU** or **DVD MENU**.

- Press $\leftarrow/\uparrow/\downarrow/\rightarrow$ to select the item you want to play or change, then press \oplus .
You can also select the number by pressing the number buttons while holding down SHIFT.

To display the DVD's menu on the Control Menu

- Press DISPLAY .
- Press \uparrow/\downarrow to select DISC MENU , then press \oplus .
- Press \uparrow/\downarrow to select MENU or TOP MENU , then press \oplus .

Selecting an original title or edited title on a DVD-VR

DVD-VR

This function is only available for DVD-VRs with a playlist created.

- Press DISPLAY while the system is in stop mode.
- Press \uparrow/\downarrow to select $\text{ORIGINAL/PLAY LIST}$, then press \oplus .
- Press \uparrow/\downarrow to select a setting, then press \oplus .
 - [PLAY LIST]:** You can play the titles in the order of the existing playlist.
 - [ORIGINAL]:** You can play the titles as they were originally recorded.

Selecting the Playback Mode

Playing in programmed order

(Program Play)

VIDEO CD **CD**

You can play the contents of a disc in the order you want by arranging the order of the tracks on the disc to create your own program. You can program up to 99 tracks.

- Press DISPLAY .
- Press \uparrow/\downarrow to select PROGRAM , then press \oplus .
- Press \uparrow/\downarrow to select SET , then press \oplus .

Total time of the programmed tracks

PROGRAM		0: 00:00
ALL CLEAR		T
1. TRACK	--	--
2. TRACK	--	01
3. TRACK	--	02
4. TRACK	--	03
5. TRACK	--	04
6. TRACK	--	05
7. TRACK	--	06

Tracks recorded on a disc

- Press \rightarrow .

The cursor moves to the track row [T] (in this case, [01]).

PROGRAM		0: 00:00
ALL CLEAR		T
1. TRACK	--	--
2. TRACK	--	01
3. TRACK	--	02
4. TRACK	--	03
5. TRACK	--	04
6. TRACK	--	05
7. TRACK	--	06

5 Select the track you want to program.

Ex. To set track 2 as the first programmed track

Press \uparrow/\downarrow to select [02] under [T], then press \oplus .

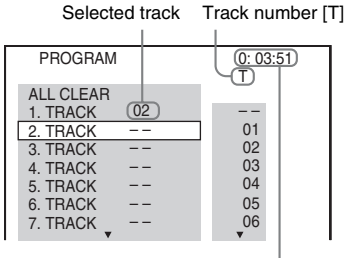

Total time of the programmed tracks

6 To program other tracks, repeat Steps 4 to 5.

7 Press \blacktriangleright to start Program Play.

To return to normal playback

Press CLEAR while holding down SHIFT when the display for the program setting is not displayed on the TV screen, or select [OFF] in Step 3. To play the same program again, select [ON] in Step 3 and press \oplus .

To change or cancel a program

1 Follow Steps 1 to 3 of "Playing in programmed order."

2 Press \uparrow/\downarrow to select the program number of the track you want to change or cancel.

If you want to delete the track from the program, press CLEAR while holding down SHIFT.

3 Follow Step 5 of "Playing in programmed order" for new programming.

To cancel a program, select [--] under [T], then press \oplus .

To cancel all of the tracks in the program

1 Follow Steps 1 to 3 of "Playing in programmed order."

2 Press \uparrow and select [ALL CLEAR], then press \oplus .

Playing in random order

(Shuffle Play)

VIDEO CD C D DATA CD DATA DVD USB

Note

- The same song may be played repeatedly when you are playing MP3 files.

1 Press DISP DISPLAY during playback.

2 Press \uparrow/\downarrow to select SHUFFLE [SHUFFLE], then press \oplus .

3 Press \uparrow/\downarrow to select the item to be shuffled.

■ VIDEO CD/CD

- [OFF]: Off.
- [TRACK]: You can shuffle tracks on the disc.

■ During Program Play

- [OFF]: Off.
- [ON]: You can shuffle tracks selected in Program Play.

■ DATA CD (audio files only)/DATA DVD (audio files only)/USB device (audio files only)

- [OFF]: Off.
- [ON (MUSIC)]: You can shuffle audio files in the folder on the current disc/USB device. When no folder is selected, the audio files in the first folder are shuffled.

4 Press \oplus to start Shuffle Play.

To return to normal playback

Press CLEAR while holding down SHIFT, or select [OFF] in Step 3.

Note

- You cannot use Shuffle Play with a VIDEO CD or Super VCD with PBC playback.

Playing repeatedly

(Repeat Play)

DVD-V

DVD-VR



VIDEO CD

C D

DATA CD

DATA DVD

USB

- 1 Press  **DISPLAY** during playback.
- 2 Press \uparrow/\downarrow to select  [REPEAT], then press \oplus .
- 3 Press \uparrow/\downarrow to select the item to be repeated, then press \oplus .
 - **DVD VIDEO/DVD-VR**
 - [OFF]: Off.
 - [DISC]: You can repeat all of the titles on the disc.
 - [TITLE]: You can repeat the current title on a disc.
 - [CHAPTER]: You can repeat the current chapter on a disc.
 - **VIDEO CD/CD**
 - [OFF]: Off.
 - [DISC]: You can repeat all of the tracks on the disc.
 - [TRACK]: You can repeat the current track.
 - **DATA CD/DATA DVD/USB device**
 - [OFF]: Off.
 - [DISC] (DATA CD/DATA DVD only): You can repeat all of the folders on the disc.
 - [MEMORY] (USB device only): You can repeat all of the folders on the USB device.
 - [FOLDER]: You can repeat the current folder.
 - [TRACK] (audio files only): You can repeat the current file.
 - [FILE] (video files only): You can repeat the current file.
- 4 Press  to start Repeat Play.

To return to normal playback

Press CLEAR while holding down SHIFT, or select [OFF] in Step 3.

Note



- You cannot use Repeat Play with a VIDEO CD or Super VCD with PBC playback.

Selecting an effect for the slide show

DATA CD

DATA DVD

USB

- 1 Press  **DISPLAY** repeatedly until  [EFFECT] appears on the control menu.
- 2 Press \uparrow/\downarrow to select  [EFFECT], then press \oplus .
- 3 Press \uparrow/\downarrow to select a setting, then press \oplus .
 - [MODE 1]: The JPEG image file sweeps in from the top to the bottom of the TV screen.
 - [MODE 2]: The JPEG image file stretches out from the left to the right of the TV screen.
 - [MODE 3]: The JPEG image file stretches out from the center of the TV screen.
 - [MODE 4]: The JPEG image files randomly cycle through the effects.
 - [MODE 5]: The next JPEG image file slides over the previous image.
 - [OFF]: Off.

Note

- The [EFFECT] setting is not effective when you set [JPEG RESOLUTION] in [HDMI SETUP] to [(1920 × 1080i) HD ] or [(1920 × 1080i) HD] (page 51).
- The [EFFECT] setting cannot be selected when you are playing a disc that does not contain JPEG image files or a USB device, or when you set [MEDIA] to a setting that cannot play JPEG image files.

Selecting the slide show duration

DATA CD **DATA DVD** **USB**

- 1 Press **DISPLAY** repeatedly until **[INTERVAL]** appears on the control menu.
- 2 Press **↑/↓** to select **[INTERVAL]**, then press **+**.
- 3 Press **↑/↓** to select a setting, then press **+**.
 - **[NORMAL]**: Slide show images appear for the standard duration.
 - **[FAST]**: You can set the duration shorter than **[NORMAL]**.
 - **[SLOW 1]**: You can set the duration longer than **[NORMAL]**.
 - **[SLOW 2]**: You can set the duration longer than **[SLOW 1]**.

Note

- Some JPEG image files may take longer to display than the option you selected, especially progressive JPEG image files or JPEG image files of 3,000,000 pixels or more.
- The **[INTERVAL]** setting cannot be selected when you are playing a disc that does not contain JPEG image files or a USB device, or when you set **[MEDIA]** to a setting that cannot play JPEG image files.

Playing a slide show with sound

DATA CD **DATA DVD**

- 1 Prepare a folder on a disc which contains both MP3 files and JPEG image files.
The MP3 files and JPEG image files must not be in separate folders. For details of making the disc, refer to the instructions of your PC, software, etc.
- 2 Press **DISPLAY**.
- 3 Press **↑/↓** to select **[MEDIA]**, then press **+**.

- 4 When **[MUSIC/PHOTO]** is selected, go to Step 5. When other than **[MUSIC/PHOTO]** is selected, press **↑/↓** to select **[MUSIC/PHOTO]**, then press **+**.
- 5 If the folder list does not appear, press **DVD MENU**.
You can turn the folder list on/off by pressing **DVD MENU** repeatedly.
- 6 Press **↑/↓** to select the desired folder and press **▶**.

Note

- If you play a large MP3 file and JPEG image file at the same time, the sound may skip. Sony recommends that you set the MP3 bit rate to 128 kbps or lower when creating the file. If the sound still skips, reduce the size of the JPEG image file.

Displaying the Information of a Disc/USB Device

Viewing playback information

DVD-V **DVD-VR** **VIDEO CD** **C D** **DATA CD**
DATA DVD **USB**

Press **TIME/TEXT** repeatedly during playback.

Information on the TV screen

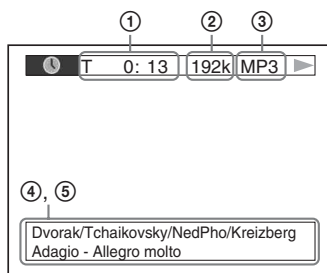

- 1 **[T **:**:*/C **:**:*/D **:**:**]**

Playing time of the current item
“T” stands for title/track, “C” stands for chapter, and “D” stands for disc.

[T-***:*/C-***:*/D-***:***]

Remaining time of the current item
 “T” stands for title/track, “C” stands for chapter, and “D” stands for disc.

[**:*:***]

Playing time of the current scene/video file

② **Bit rate**

Appears when playing an audio file.

③ **File type**

Appears when playing an audio/video file.

④ **Folder/file name**

Appears when playing an audio file/JPEG image file/video file.

If an MP3 file has an ID3 tag, the system will display an album name/title name from the ID3 tag information.

The system can support ID3 ver 1.0/1.1/2.2/2.3.

ID3 ver 2.2/2.3 tag information display has priority when both ID3 ver 1.0/1.1 and ver 2.2/2.3 tags are used for a single MP3 file.

⑤ **Text information**

The DVD/CD text appears only when text is recorded on the disc. You cannot change the text. If the disc does not contain text, “NO TEXT” appears.

Note

- Depending on the source being played, the system can only display a limited number of characters. Also, depending on the source, not all text characters will be displayed.

Information in the front panel display

Each time you press TIME/TEXT during playback, the following information appears. Some displayed items may disappear after a few seconds.

■ **DVD VIDEO/DVD-VR**

- ① Playing time of the current title
- ② Remaining time of the current title
- ③ Playing time of the current chapter
- ④ Remaining time of the current chapter
- ⑤ Disc name
- ⑥ Title and chapter

■ **VIDEO CD (with PBC functions)/Super VCD (with PBC functions)**

- ① Playing time of the current item
- ② Disc name
- ③ Scene number

■ **VIDEO CD (without PBC functions)/CD**

- ① Playing time of the current track
- ② Remaining time of the current track
- ③ Playing time of the disc
- ④ Remaining time of the disc
- ⑤ Track name
- ⑥ Track and index*

* VIDEO CD only.

■ **Super VCD (without PBC functions)**

- ① Playing time of the current track
- ② Track text
- ③ Track and index number

■ **DATA CD/DATA DVD/USB device (audio file)**

- ① Playing time and current track number
- ② Track (file) name*

* If an MP3 file has an ID3 tag, the system will display a title name from the ID3 tag information. The system can support ID3 ver 1.0/1.1/2.2/2.3. ID3 ver 2.2/2.3 tag information display has priority when both ID3 ver 1.0/1.1 and ver 2.2/2.3 tags are used for a single MP3 file.

■ **DATA CD (video file)/DATA DVD (video file)/USB device (video file)**

- ① Playing time of the current file
- ② Current file name
- ③ Current album and file number



Note

- The system can only display the first level of the DVD/CD text, such as the disc name or title.
- The disc name or track name may not be displayed depending on the text.
- Playing time of MP3 files and video files may not be displayed correctly.

Viewing the date information of a JPEG image file

DATA CD **DATA DVD** **USB**

You can check the date information during playback when the Exif* tag is recorded in the JPEG image file.

Press  **DISPLAY** repeatedly until  **[DATE]** appears on the control menu.

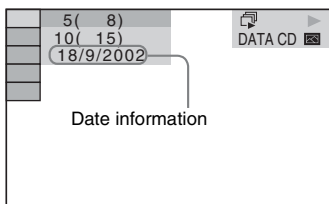

* “Exchangeable Image File Format” is a digital camera image format defined by the Japan Electronics and Information Technology Industries Association (JEITA).

Enjoying the Audio/Video of the Connected Component

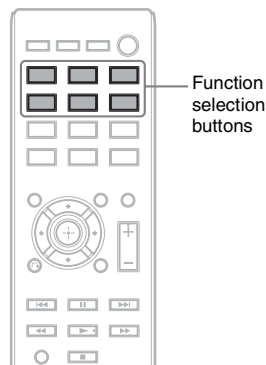

1 Use the function selection buttons to select the desired function.

The selected item appears in the front panel display.

Button	Source
DVD/CD	Disc that is played by the system
FM	FM radio
USB	USB device
TV	TV or set-top box

You can also select the desired function by pressing **FUNCTION** repeatedly.

2 Prepare the source.

- DVD/CD: Insert a disc into the unit (page 28).
- FM: Select a radio program (page 39).
- USB: Connect a USB device directly (page 28).
- TV: Select a channel on the TV or set-top box.

3 Operate the connected component.

To enjoy a set-top box, select the input of the set-top box via the TV to which it is connected.

Presetting Radio Stations

You can preset 20 FM stations.

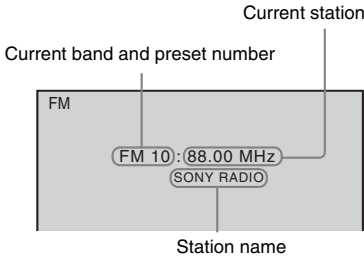

- 1 Press FM.**
- 2 Press and hold TUNING +/- until the auto scanning starts.**
Scanning stops when the system tunes in a station.
- 3 Press SYSTEM MENU.**
- 4 Press ↑/↓ to select "MEMORY."**
- 5 Press ⊕ or →.**
A preset number appears in the front panel display.

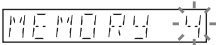

- 6 Press ↑/↓ to select the preset number you want.**
- 7 Press ⊕.**
"COMPLETE" appears in the front panel display, and the station is stored.
- 8 Repeat Steps 2 to 7 to store other stations.**
- 9 Press SYSTEM MENU.**

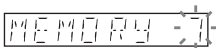

To change the preset number

Select the desired preset number by pressing PRESET +/- (page 39), then perform the procedure from Step 3.

Listening to the Radio

Preset radio stations in the system's memory first (see "Presetting Radio Stations" (page 39)).

- 1 Press FM.**
- 2 Press PRESET +/- repeatedly to select the preset station.**
- 3 Adjust the volume by pressing VOLUME +/-.**

To listen to radio stations when you know the frequencies

Press D.TUNING in Step 2, press the number buttons while holding down SHIFT to select the frequencies, then press ⊕.

To listen to non-preset radio stations

Use manual or automatic tuning in Step 2. For manual tuning, press TUNING +/- repeatedly.

For automatic tuning, press and hold TUNING +/- . The automatic tuning stops automatically when the system receives the radio station. To stop the automatic tuning manually, press TUNING +/- or ■.

If an FM program is noisy

If an FM program is noisy, you can select monaural reception. There will be no stereo effect, but reception will improve.

- 1 Press SYSTEM MENU.**
- 2 Press ↑/↓ to select "FM MODE."**

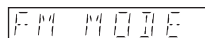

- 3 Press ⊕ or →.**
- 4 Press ↑/↓ to select "MONO."**
 - "STEREO": Stereo reception.
 - "MONO": Monaural reception.

5 Press \oplus .

6 Press SYSTEM MENU.

Viewing the station name or frequency in the front panel display

You can check the station name or frequency using the front panel display. The first 8 letters of the station name are displayed.

Press TIME/TEXT.

Each time you press TIME/TEXT, the display changes as follows.

When the station name is received via the RDS function

- ① Station name
Ex. "SONY FM"
- ② Frequency
Ex. "12 87.50"
- ③ The "FM MODE" setting
Ex. "STEREO"

When the station name is not set

- ① Frequency
Ex. "12 87.50"
- ② The "FM MODE" setting
Ex. "STEREO"

Using the Radio Data System (RDS)

What is the Radio Data System?

The Radio Data System (RDS) is a broadcasting service that allows radio stations to send additional information along with the regular program signal. This tuner offers convenient RDS features, such as station name display.

Receiving RDS broadcasts

Simply select a station.

When you tune in a station that provides RDS services, the station name* appears in the front panel display.

* If an RDS broadcast is not received, the station name does not appear in the front panel display.

Note

- Not all FM stations provide RDS service, nor do they provide the same type of services. If you are not familiar with RDS services, check with your local radio stations for details and availability in your area.

Selecting the Effect to Suit the Source

The system has six pre-programmed sound modes to suit the source or playback situation. You can achieve the maximum sound effect of the original source by simply selecting one of the sound modes.

Press SOUND MODE repeatedly until the desired mode appears in the front panel display.

- “STANDARD”: The system automatically selects a sound effect suitable for movies or music, depending on the source.
- “CLEAR VOICE”: The system outputs sound using dialog enhancement for voices that are easier to hear.
- “MOVIE”: The system outputs sound suitable for movies. If the original source is 2 channel, the system simulates surround sound by using the Dolby Pro Logic decoding system, and outputs the sound from all speakers.
- “HI-FI”: The system outputs sound suitable for music. You can enjoy the accurate sound of the original source.
- “BGM”: The system outputs the same sound across the entire room. You can enjoy this mode, for example, in the large party room.
- “2CH STEREO”: The system outputs sound from the front speakers and the subwoofer regardless of the original numbers of channels. If the original source is multi-channel, the system downmixes it to 2 channels.

Note

- Depending on the source, the sound mode may not be effective.

Using the Control for HDMI Function for “BRAVIA” Sync

This function is available on TVs with the “BRAVIA” Sync function.

By connecting Sony components that are compatible with the Control for HDMI function with an HDMI cable, operation is simplified as below:

- System Power Off (page 42)
- One-Touch Play (page 43)
- Theatre Mode (page 43)
- System Audio Control (page 43)
- Audio Return Channel (page 43)
- Remote Easy Control (page 43)
- Language Follow (page 43)

Control for HDMI is a mutual control function standard used by CEC (Consumer Electronics Control) for HDMI (High-Definition Multimedia Interface).

Note

- Depending on the connected component, the Control for HDMI function may not work. Refer to the operating instructions of the component.

Preparing the Control for HDMI function

(Control for HDMI - Easy Setting)

If your TV is compatible with the Control for HDMI - Easy Setting function, you can set the system's [CONTROL FOR HDMI] function automatically by setting your TV. For details, refer to the operating instructions of your TV.

If your TV is not compatible with the Control for HDMI - Easy Setting function, set the Control for HDMI function of the system and TV manually.

- 1** Make sure that the system and your TV are connected with an HDMI cable.
- 2** Turn on your TV and press **I/⏻** to turn on the system.
- 3** Switch the input selector on your TV so that the signal from the system through the HDMI input appears on the TV screen.
- 4** Set the Control for HDMI function of your TV.
For details of the setting of your TV, refer to the operating instructions of your TV.
- 5** On the system, press **DVD/CD**.
- 6** Press **⏻** **DISPLAY** while the system is in stop mode.
- 7** Press **↑/↓** to select **⏻** **[SETUP]**, then press **+**.
- 8** Press **↑/↓** to select **[CUSTOM]**, then press **+**.
- 9** Press **↑/↓** to select **[HDMI SETUP]**, then press **+**.
- 10** Press **↑/↓** to select **[CONTROL FOR HDMI]**, then press **+**.
- 11** Press **↑/↓** to select **[ON]**, then press **+**.

Turning the system off in sync with your TV

(System Power Off)

When you turn your TV off by using the **POWER** button on your TV's remote or **TV I/⏻** on the system's remote, the system turns off automatically.

Note

- This function depends on the settings of your TV. For details, refer to the operating instructions of your TV.
- Depending on the status of the system (ex. while playing a CD or listening to the radio), the system may not turn off automatically.

Watching a DVD by a single button press

(One-Touch Play)

Press ONE-TOUCH PLAY

Your TV turns on, your TV's function is set to the HDMI input to which the system is connected, and the system starts playing a disc automatically.

The System Audio Control function is also activated automatically.

Using the Theatre Mode

(Theatre Mode)

If your TV is compatible with the Theatre Mode, you can enjoy optimal image and sound quality suited for movies, and the System Audio Control function is activated automatically.

Press THEATRE.

Note

- Depending on your TV, this function may not work.

Enjoying TV sound from the speakers by this system

(System Audio Control)

To use this function, connect the system and your TV with a SCART (EURO AV) cable and an HDMI cable (page 21).

Press I/O to turn on the system while your TV is turned on.

The System Audio Control function is activated. TV sound is output from the system speakers, and the volume of your TV's speakers is minimized automatically.

Note

- While your TV is in PAP (picture and picture) mode, the System Audio Control function will not work. When your TV exits PAP mode, the output method of your TV returns to the one before PAP mode.
- When you turn the system on by pressing the function selection button, video and sound may not match.
- Depending on the TV, when you adjust the system's volume, the volume level appears on the TV screen.

In this case, the volume levels that appear on the TV screen and the front panel display of the system may differ.

Tip

- You can also operate the System Audio Control function via the TV menu.
- You can operate the volume and mute control of the system via the TV remote.

Receiving the digital audio signal of your TV

(Audio Return Channel)

The system can receive the digital audio signal of your TV via an HDMI cable when your TV is compatible with the Audio Return Channel function. You can enjoy TV sound via the system by using just one HDMI cable. For details, see [AUDIO RETURN CHANNEL] (page 51).

Operating the system via the TV remote

(Remote Easy Control)

You can control the basic functions of the system via the TV remote when the system's video output is displayed on the TV screen. For details, refer to the operating instructions of the TV.

Changing the language for the system's on-screen display in sync with your TV

(Language Follow)

When you change the language for the on-screen display of your TV, the system's on-screen display language is also changed.

Note

- When the system's on-screen display is displayed, this function does not work.

Transferring Songs onto a USB Device

You can transfer songs on an audio CD or radio programs onto a USB device by encoding to MP3 format. You can also transfer MP3 files on a DATA CD/DATA DVD onto a USB device. For connecting the USB device, see “Playing Files on a Disc/USB Device” (page 28).

The transferred music is limited to private use only. Use of the music beyond this limit requires permission of the copyright holders.

Notes on USB transferring

- Do not connect the unit and the USB device through a USB hub.
- Make sure there is enough space in the USB device for transferring.
- Do not remove the USB device during transferring.
- When you are transferring tracks from an audio CD, the tracks are recorded as 128 kbps MP3 files.
- When you are transferring MP3 files from a DATA CD/DATA DVD, the MP3 files are transferred with the same bit rate as the original MP3 files.
- When you are transferring a radio program, the audio is recorded as a 128 kbps MP3 file.
- CD text information is not transferred in the created MP3 files.
- If you stop a transfer from an audio CD halfway, the MP3 file that was being created is deleted.
- Transferring stops automatically if:
 - the USB device runs out of space during transfer.
 - the number of folders on the USB device reaches the limit for the number that the system can recognize.
- You can store up to 150 files in a folder.
- You can store up to 199 folders in a single USB device.
- If a folder or file that you are trying to transfer already exists on the USB device with the same name, a sequential number is added after

the name without overwriting the original folder or file.

To select the transfer destination of the USB device

You can select the memory number for transfer depending on the USB device.

Press MEM SEL.

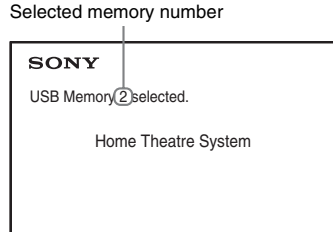

Note

- When the memory cannot be selected, [Operation not possible.] appears on the TV screen.
- The memory number changes depending on the USB device.
- Select a transfer destination before transfer.

Folder and file generation rules

When transferring onto a USB device, a “MUSIC” folder is created directly below the “ROOT”. Folders and files are generated within this “MUSIC” folder as follows according to the transferring method and source.

- When transferring multiple tracks on an audio CD or multiple MP3 files on a DATA CD/DATA DVD

Source	Folder name	File name
MP3	Same as the transferring source ¹⁾	
Audio CD	“FLDR001” ²⁾	“TRACK001” ³⁾

- When transferring a single track on an audio CD or a single MP3 file on a DATA CD/DATA DVD

Source	Folder name	File name
MP3	“REC1-MP3” ⁴⁾	Same as the transferring source ¹⁾
Audio CD	“REC1-CD” ⁴⁾	“TRACK001” ³⁾

- When transferring a radio program

Folder name	File name
"FM001" ⁴⁾	"TRACK001" ³⁾

- ¹⁾Up to 64 characters of the name are assigned (including the extension).
- ²⁾Folders are assigned in numeric order thereafter.
- ³⁾Files are assigned in numeric order thereafter.
- ⁴⁾A new file is transferred in the "REC1-MP3" or "REC1-CD" folder each time single-track transferring is performed.

Transferring tracks on an audio CD or MP3 files on a DATA CD/DATA DVD onto a USB device

- 1** Load an audio CD/DATA CD/DATA DVD.
- 2** Press **[DISP]** **DISPLAY** while the system is in stop mode.
- 3** Press **↑/↓** to select **[USB TRANSFER]**, then press **[+]**.

■ For an audio CD

Press **[+]** and skip to Step 5.

■ For a DATA CD/DATA DVD

Follow the next Step.

- 4** Press **↑/↓** to select **[TRACK]** or **[FOLDER]**, then press **[+]**.
 - **[TRACK]**: The folder list appears. Press **↑/↓** to select the desired folder, then press **[+]**.
 - **[FOLDER]**: The folders recorded on the DATA CD/DATA DVD appear. You can transfer all MP3 files in the folder.
- 5** Press **←/→** to select **[ALL]** (for an audio CD) or **[✓ ALL]** (for a DATA CD/DATA DVD), then press **[+]**.

To deselect all tracks, select **[□ ALL]**, then press **[+]**.

- 6** Press **←/→** to select **[START]**, then press **[+]**.

To cancel transferring, press **[■]**.

To select individual tracks/MP3 files/folders

Press **↑/↓** to highlight the track/MP3 file/folder, then press **[+]** to add a check in Step 5.

To cancel the selection, highlight the track/MP3 file/folder, then press **[+]** to remove the check.

■ For an audio CD

Remaining space of the USB device

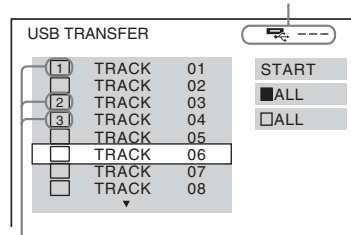

Tracks to be transferred

■ For a DATA CD/DATA DVD

Remaining space of the USB device

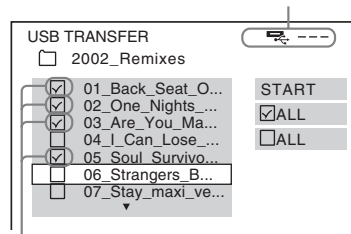

MP3 files/folders to be transferred

Transferring by single button press

You can transfer tracks/MP3 files simply onto a USB device by using REC TO USB.

- 1** Load an audio CD/DATA CD/DATA DVD.
- 2** Press **[■]**.
 - To transfer all tracks, skip to Step 4.
 - To transfer a single track, follow the next Step.
- 3** Select the desired track/MP3 file, then press **[▶]**.

4 Press REC TO USB on the unit.
REC TO USB lights up and “READING” appears in the front panel display. Then, “PUSH PLAY” and the remaining space of the USB device appear alternately in the front panel display.

5 Press ► to start transferring.
When transferring is completed, “COMPLETE” appears in the front panel display and playback of the disc and USB device stops automatically.
To cancel transferring, press ■.

Transferring a radio program

You can transfer a radio program you are listening to onto a USB device.

1 Press FM.
2 Select the radio station by pressing PRESET +/- or TUNING +/-.
3 Press REC TO USB on the unit.
REC TO USB lights up and “PLEASE WAIT” appears in the front panel display. Then, “PUSH PLAY” and the remaining space of the USB device appear alternately in the front panel display.

4 Press ► to start transferring.
5 Press ■ to stop transferring.

To create a new MP3 file while transferring

Press REC TO USB while transferring.
“NEW TRK” appears in the display and transferring continues in a new MP3 file right after you press REC TO USB.
If you press REC TO USB again within a few seconds, a new MP3 file cannot be created.

Note

- When a new MP3 file is created, transferring is temporarily disabled.

Tip

- A new MP3 file is created automatically after approximately 1 hour of transferring.

Erasing audio files on a USB device

You can erase audio files (“.mp3,” “.wma,” or “.m4a”) on the USB device.

1 Press USB.
2 Press ↑/↓ to select a folder.
3 Select the audio file(s).
■ **To erase all audio files in a folder**
Press CLEAR while holding down SHIFT.
■ **To erase an audio file**
Press ⊕ and press ↑/↓ to select the desired audio file, then press CLEAR while holding down SHIFT.
4 Press ←/→ to select [YES], then press ⊕.
To cancel, select [NO], then press ⊕.

Note

- Do not remove the USB device while erasing.
- If the folder to be erased contains non-audio format files or sub folders, these are erased from the list on the TV screen, but are not erased from the USB device.

Using the Sleep Timer

You can set the system to turn off at a preset time, so you can fall asleep listening to music.

1 Press SYSTEM MENU.
2 Press ↑/↓ to select “SLEEP,” then press ⊕ or →.
The selected item appears in the front panel display.
3 Press ↑/↓ to select a setting, then press ⊕.
The minutes display (the remaining time) changes by 10 minutes.
4 Press SYSTEM MENU.

Adjusting the Delay Between the Picture and Sound

[A/V SYNC]

DVD-V DVD-VR VIDEO CD DATA CD DATA DVD
USB

When the sound does not match the pictures on the TV screen, you can adjust the delay between the picture and sound.

- 1 Press DISPLAY.
- 2 Press \uparrow/\downarrow to select [A/V SYNC], then press \oplus .
- 3 Press \uparrow/\downarrow to select a setting, then press \oplus .
 - [OFF]: Off.
 - [ON]: You can adjust the delay between the picture and sound.

Note

- Depending on the input stream, [A/V SYNC] may not be effective.

Enjoying Multiplex Broadcast Sound

(DUAL MONO)

You can enjoy multiplex broadcast sound when the system receives or plays a Dolby Digital multiplex broadcast signal.

Note

- To receive a Dolby Digital signal, you need to connect a TV or other component to the unit with a digital optical cord (page 21). If your TV is compatible with the Audio Return Channel function (page 43), you can receive a Dolby Digital signal via an HDMI cable.

Press AUDIO repeatedly to select the audio signal.

The selected item appears in the front panel display.

- “MAIN”: Sound of the main language will be output.
- “SUB”: Sound of the sub language will be output.
- “MAIN+SUB”: Mixed sound of both the main and sub languages will be output.

Changing the Input Level of the Sound from Connected Components

The sound distortion of the connected component may be improved by reducing the input level.

- 1 Press TV.
- 2 Press SYSTEM MENU.
- 3 Press \uparrow/\downarrow to select “ATT,” then press \oplus or \rightarrow .
- 4 Press \uparrow/\downarrow to select a setting, then press \oplus .
 - “ON”: The input level is attenuated.
 - “OFF”: Normal input level.
- 5 Press SYSTEM MENU.

Changing the Brightness of the Front Panel Display

- 1** Press **SYSTEM MENU**.
- 2** Press **↑/↓** to select “DIMMER,” then press **⊕** or **→**.
The selected item appears in the front panel display.
- 3** Press **↑/↓** to select the brightness of the front panel display, then press **⊕**.
 - “OFF”: The front panel display is bright.
 - “ON”: The front panel display is dim.
- 4** Press **SYSTEM MENU**.

Tip

- For DAV-DZ740, the power indicator also becomes dim when you select “ON.”

Setting the Demonstration Mode to On/Off

You can turn on/off the demonstration in the front panel display while the system is in standby mode.

- 1** Press **SYSTEM MENU**.
- 2** Press **↑/↓** to select “DEMO,” then press **⊕** or **→**.
The selected item appears in the front panel display.
- 3** Press **↑/↓** to select a setting, then press **⊕**.
 - “ON”: On.
 - “OFF”: Off.
- 4** Press **SYSTEM MENU**.

Reperforming the Quick Setup

- 1** Press **DVD/CD**.
- 2** Press **DISPLAY** while the system is in stop mode.
- 3** Press **↑/↓** to select **[SETUP]**, then press **⊕**.
- 4** Press **↑/↓** to select **[QUICK]**, then press **⊕**.
Perform the Quick Setup following the procedure of “Performing the Quick Setup” (page 25).

Setting the System to Standby Mode Automatically

The system enters standby mode automatically when you do not operate the system for about 30 minutes and the system is not outputting sound for about 30 minutes. “AUTO.STBY” begins to flash in the front panel display about 2 minutes before the system enters standby mode.

You can turn the auto standby function on/off.

- 1** Press **SYSTEM MENU**.
- 2** Press **↑/↓** to select “AUTO.STBY,” then press **⊕** or **→**.
The selected item appears in the front panel display.
- 3** Press **↑/↓** to select the setting, then press **⊕**.
 - “ON”: On.
 - “OFF”: Off.
- 4** Press **SYSTEM MENU**.



Performing Further Settings

You can make various adjustments to items such as picture and sound.

Displayed items vary depending on the area and model.

Note

• Playback settings stored in the disc take priority over the Setup Display settings and not all the functions described may work.

- 1 Press DVD/CD.
- 2 Press  DISPLAY while the system is in stop mode.
- 3 Press \uparrow/\downarrow to select  [SETUP], then press \oplus .
- 4 Press \uparrow/\downarrow to select [CUSTOM], then press \oplus .
- 5 Press \uparrow/\downarrow to select the setup item, then press \oplus .
 - [LANGUAGE SETUP] (page 49)
 - [VIDEO SETUP] (page 50)
 - [HDMI SETUP] (page 50)
 - [AUDIO SETUP] (page 51)
 - [SYSTEM SETUP] (page 52)
 - [SPEAKER SETUP] (page 53)

Example: [VIDEO SETUP]

Selected item

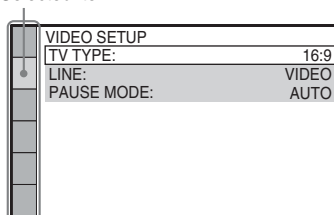

Setup items

- 6 Press \uparrow/\downarrow to select an item, then press \oplus .

The options for the selected item appear.

Example: [TV TYPE]

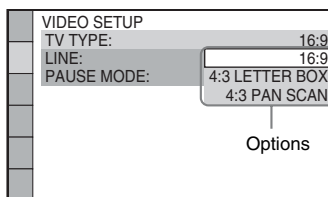

- 7 Press \uparrow/\downarrow to select a setting, then press \oplus .

The setting is selected and setup is complete.

Example: [4:3 LETTER BOX]

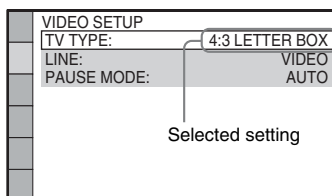

To reset all of the [SETUP] settings

To reset all of the [SETUP] settings, see [RESET] (page 53).

Setting the display or sound track language

[LANGUAGE SETUP]

Set various languages for the on-screen display or sound track.

■ [OSD] (On-Screen Display)

You can switch the display language on the TV screen.

■ [MENU]

You can switch the language for the disc's menu.

■ [AUDIO] DVD-V

You can switch the language of the sound track. When you select [ORIGINAL], the language given priority on the disc is selected.

■ [SUBTITLE] DVD-V

You can switch the language of the subtitles recorded on the DVD VIDEO. When you select [AUDIO FOLLOW], the language for the subtitles changes according to the language you selected for the sound track.

Note

• When you select a language in [MENU], [AUDIO], or [SUBTITLE] that is not recorded on the DVD VIDEO, one of the recorded languages will be automatically selected (depending on the disc, the language may not be selected automatically).

Tip

• If you select [OTHERS →] in [MENU], [AUDIO], and [SUBTITLE], select and enter a language code from “Language Code List” (page 67) using the number buttons.

Settings for the display

[VIDEO SETUP]

Select settings according to your TV.

■ [TV TYPE]

You can select the aspect ratio of the connected TV.

[16:9]: Select this when you connect a wide-screen TV or a TV with a wide-screen mode.



[4:3 LETTER BOX]: Select this when you connect a 4:3 standard TV. The system displays a wide picture with bands on the upper and lower portions of the TV screen.



[4:3 PAN SCAN]: Select this when you connect a 4:3 standard TV. The system automatically displays a wide picture on the entire screen and cuts off the portions that do not fit.



■ [LINE]

You can select the output method for video signals from the EURO AV ⇄ OUTPUT (TO TV) jack.

[VIDEO]: The system outputs video signals.

[RGB]: The system outputs RGB signals.

Note

- If your TV does not accept RGB signals, no picture appears on the TV screen even if you select [RGB]. Refer to the operating instructions of your TV.
- You cannot select [RGB] while any equipment is connected via HDMI. [RGB] automatically switches to [VIDEO] when you turn on any equipment connected via HDMI.

■ [PAUSE MODE] DVD-V

(DVD VIDEO/DVD-R/DVD-RW only)

You can select the picture in pause mode.

[AUTO]: The picture, including subjects that move dynamically, is output with no jitter. This setting is for normal usage.

[FRAME]: The picture, including subjects that do not move dynamically, is output in high resolution.

Settings for HDMI

[HDMI SETUP]

■ [HDMI RESOLUTION]

You can select the type of video signal that is output from the HDMI OUT jack.

[AUTO (1920 × 1080p)]: The system outputs the optimal video signal for the connected TV.

[1920 × 1080i]: The system outputs 1920 × 1080i* video signals.

[1280 × 720p]: The system outputs 1280 × 720p* video signals.

[720 × 480p]**: The system outputs 720 × 480p* video signals.

* i: interlace, p: progressive

** Depending on the area, [720 × 480/576p] may appear.

■ [CONTROL FOR HDMI]

This function is available when you connect the system and TV that is compatible with the Control for HDMI function with an HDMI cable.

[OFF]: Off.

[ON]: On. You can operate mutually between components that are connected with an HDMI cable.

■ [AUDIO RETURN CHANNEL]

This function is available when you connect the system and TV that is compatible with the Audio Return Channel function.

[AUTO]: The system can receive the digital audio signal of your TV via an HDMI cable automatically.

[Off]: Off.

Note

- This function is available only when [CONTROL FOR HDMI] is set to [ON].

■ [YCbCr/RGB (HDMI)]

You can select the type of HDMI signal output from the HDMI OUT jack.

[YCbCr]: The system outputs YCbCr signals.

[RGB]: The system outputs RGB signals.

■ [AUDIO (HDMI)]

You can select the audio output status from the HDMI OUT jack.

[OFF]: The system does not output sound from the HDMI OUT jack.

[ON]: The system outputs audio signals by converting Dolby Digital, DTS, or 96 kHz/24-bit PCM signals to 48 kHz/16-bit PCM.

Note

- When you set the function to other than “DVD/CD” or “USB,” the system does not output the sound from the HDMI OUT jack even if you set [AUDIO (HDMI)] to [ON].

■ [JPEG RESOLUTION]

You can select the resolution of JPEG image files output from the HDMI OUT jack.

[SD]: The system outputs standard resolution with a black frame.

[HD]: The system outputs HD resolution with a black frame.

[HD]: The system outputs the HD resolution without a black frame.

[(1920 × 1080i) HD]: The system outputs full size HD resolution with a black frame.

[(1920 × 1080i) HD]: The system outputs full size HD resolution without a black frame.

Note

- [JPEG RESOLUTION] is effective only when you set [TV TYPE] in [VIDEO SETUP] to [16:9], and you set [HDMI RESOLUTION] in [HDMI SETUP] to other than [720 × 480p] or [720 × 480/576p].
- You can select [(1920 × 1080i) HD] or [(1920 × 1080i) HD] only when you set [HDMI RESOLUTION] in [HDMI SETUP] to [1920 × 1080i].
- The HDMI signal will stop momentarily when:
 - the system is loading or unloading a DATA CD or DATA DVD.
 - you connect or remove a USB device.

Settings for the audio



[AUDIO SETUP]

■ [AUDIO DRC] DVD-V

You can compress the dynamic range of the sound track. [AUDIO DRC] is useful for watching movies at low volume late at night.

[OFF]: No compression of dynamic range.

[STANDARD]: The system reproduces the sound track with the kind of dynamic range that the recording engineer intended.

[MAX]: The system compresses dynamic range fully.

Note

- [AUDIO DRC] works only for Dolby Digital.

■ [TRACK SELECTION] DVD-V

You can give the sound track which contains the highest number of channels priority when multiple audio formats (PCM, DTS, Dolby Digital, or MPEG audio) are recorded.

[OFF]: Off.

[AUTO]: The system selects the sound track automatically according to the priority.

Note

- When you set the item to [AUTO], the language may change. The [TRACK SELECTION] setting has higher priority than the [AUDIO] settings in [LANGUAGE SETUP] (page 49). (Depending on the disc, this function may not work.)

Other Settings

🔧 [SYSTEM SETUP]**■ [SCREEN SAVER]**

You can reduce the damage to the display device (ghosting). Press any button (e.g., ►) to cancel the screen saver.

[ON]: The screen saver image appears if you do not operate the system for about 15 minutes.

[OFF]: Off.

■ [BACKGROUND]

You can select the background color or picture on the TV screen.

[JACKET PICTURE]: The jacket picture (still picture) appears, but only when the jacket picture is already recorded on the disc (CD-EXTRA, etc.). If the disc does not contain a jacket picture, a preset picture stored in the system appears.

[GRAPHICS]: A preset picture stored in the system appears.

[BLUE]: The background is blue.

[BLACK]: The background is black.

■ [PARENTAL CONTROL]

The [PARENTAL CONTROL] function allows you to restrict playback of DVDs that have ratings. Scenes may be blocked or replaced with different scenes.

1 Enter or re-enter your 4-digit password using the number buttons, then press ⊕.

2 Press ↑/↓ to select [STANDARD], then press ⊕.

3 Press ↑/↓ to select a geographic area as the playback limitation level, then press ⊕.

When you select [OTHERS →], select and enter a standard code from “Parental Control Area Code List” (page 67) using the number buttons.

4 Press ↑/↓ to select [LEVEL], then press ⊕.

5 Press ↑/↓ to select the desired level, then press ⊕.

The lower the value, the stricter the limitation.

To turn off the [PARENTAL CONTROL] function

Set [LEVEL] to [OFF] in Step 5.

To play a disc for which [PARENTAL CONTROL] is set

When you load the disc and press ►, the display for entering your password appears.

Enter your 4-digit password using the number buttons, then press ⊕.

Tip

- If you forget your password, enter “199703” using the number buttons, then press ⊕. The display will ask you to enter a new 4-digit password. After you enter a new 4-digit password, replace the disc in the unit and press ►. When the display for entering your password appears, enter your new password.

Changing the password

1 Enter your 4-digit password using the number buttons, then press ⊕.

2 Press ↑/↓ to select [CHANGE PASSWORD →], then press ⊕.

3 Enter a new 4-digit password using the number buttons, then press \oplus .

If you make a mistake entering your password, press \leftarrow before you press \oplus , then input the correct number.

4 To confirm your password, re-enter it using the number buttons, then press \oplus .

■ [MULTI-DISC RESUME] **DVD-V** **VIDEO CD**

This system recalls the point where you stopped the disc the last time it was played and resumes playback from that point the next time you insert the same disc.

[ON]: The system stores the resume points in memory for up to 10 discs.

[OFF]: The system does not store the resume points in memory. Playback restarts at the resume point only for the current disc in the unit.

Note

- When the resume playback memory is full, the resume playback point for the earliest disc is deleted.

■ [RESET]

You can return the [SETUP] settings other than [PARENTAL CONTROL] to the default settings.

Press \leftarrow/\rightarrow to select [YES], then press \oplus .

You can also quit the process and return to the Control Menu by selecting [NO] here. Do not press \mathbb{I}/\mathbb{C} while resetting the system as it takes a few seconds to complete.

Note

- The [MEDIA], [INTERVAL], and [EFFECT] settings also return to the default settings.

Settings for the speakers

B [SPEAKER SETUP]

You can adjust the speaker settings manually without performing the Quick Setup. Select the speakers you will use, set the speaker distance from your listening position, and then adjust the sound level for each speaker. You can adjust the sound level by using the [TEST TONE] function.

■ [CONNECTION]

[FRONT]

[YES]

[CENTER]

[YES]: Normally select this.

[NONE]: Select this if no center speaker is used.

[SURROUND]

[YES]: Normally select this.

[NONE]: Select this if no surround speakers are used.

[SUBWOOFER]

[YES]

■ [DISTANCE]

Set the distance of all the speakers from the listening position.

For the best possible surround sound, place all speakers at the same distance from the listening position. The distance can be between 1.0 to 7.0 meters for the front speakers, and 0.0 to 7.0 meters for the center speaker and surround speakers.

If you cannot place the center speaker at the same distance, you can move the center speaker up to 1.6 meters closer to the listening position. If you cannot place surround speakers at the same distance, you can move the surround speakers up to 5.0 meters closer to the listening position.

[FRONT] 3.0 m: Set the front speaker distance.

[CENTER] 3.0 m: Set the center speaker distance (up to 1.6 meters closer to the front speakers).

[SURROUND] 3.0 m: Set the surround speaker distance (up to 5.0 meters closer to the front speakers).

■ [LEVEL (FRONT)]

You can adjust the sound level of the front speakers, center speaker, and subwoofer. You can set the parameters from -6.0 dB to 0 dB for [L/R], and from -6.0 dB to $+6.0$ dB for [CENTER] and [SUBWOOFER]. Be sure to set [TEST TONE] to [ON] for easy adjustment.

[L/R] 0.0 dB: Set the front speaker level.

[CENTER] 0.0 dB: Set the center speaker level.

[SUBWOOFER] +2.0 dB: Set the subwoofer level.

■ [LEVEL (SURROUND)]

You can adjust the sound level of the surround speakers. You can set the parameter from -6.0 dB to +6.0 dB. Set [TEST TONE] to [ON] for easy adjustment.

[L/R] 0.0 dB: Set the surround speaker level.

■ [TEST TONE]

You can adjust the sound level of the speakers by using the [TEST TONE] function.

[OFF]: The test tone is not emitted from the speakers.

[ON]: The test tone is emitted from each speaker in sequence while adjusting the level.

Adjust the sound level as follows.

- 1** Set the [TEST TONE] to [ON].
- 2** Press </>/</>/</> repeatedly to select the desired speaker and the level, then press \oplus .
- 3** Repeat Step 2.
- 4** Press </>/</>/</> to set [TEST TONE] to [OFF] after adjusting the speaker level.

Precautions

On power sources

- Unplug the unit from the wall outlet (mains) if you do not intend to use it for an extended period of time. To disconnect the cord, pull it out by the plug, never by the cord.

On placement

- Place the system in a location with adequate ventilation to prevent heat build-up in the system.
- At high volume, over long periods of time, the cabinet becomes hot to the touch. This is not a malfunction. However, touching the cabinet should be avoided. Do not place the system in a confined space where ventilation is poor as this may cause overheating.
- Do not block the ventilation slots by putting anything on the system. The system is equipped with a high power amplifier. If the ventilation slots are blocked, the system can overheat and malfunction.
- Do not place the system on surfaces (rugs, blankets, etc.) or near materials (curtains, draperies) that may block the ventilation slots.
- Do not install the system near heat sources such as radiators, or air ducts, or in a place subject to direct sunlight, excessive dust, mechanical vibration, or shock.
- Do not install the system in an inclined position. It is designed to be operated in a horizontal position only.
- Keep the system and discs away from components with strong magnets, such as microwave ovens, or large loudspeakers.
- Do not place heavy objects on the system.

On operation

- If the system is brought directly from a cold to a warm location, or is placed in a very damp room, moisture may condense on the lenses inside the unit. Should this occur, the system may not operate properly. In this case, remove the disc and leave the system turned on for about half an hour until the moisture evaporates.
- If anything falls into the cabinet, unplug the unit and have it checked by qualified personnel before operating it any further.

On adjusting volume

- Do not turn up the volume while listening to a section with very low level inputs or no audio signals. If you do, the speakers may be damaged when a peak level section is suddenly played.

On cleaning

- Clean the cabinet, panel, and controls with a soft cloth slightly moistened with a mild detergent solution. Do not use any type of abrasive pad, scouring powder or solvent such as alcohol or benzene.
If you have any questions or problems concerning your system, please consult your nearest Sony dealer.

On cleaning discs, disc/lens cleaners

- **Do not use cleaning discs or disc/lens cleaners (including wet or spray types). These may cause the apparatus to malfunction.**

On your TV's color

- If the speakers should cause your TV screen to have color irregularity, turn off the TV then turn it on after 15 to 30 minutes. If color irregularity should persist, place the speakers further away from your TV set.

IMPORTANT NOTICE

Caution: This system is capable of holding a still video image or on-screen display image on your television screen indefinitely. If you leave the still video image or on-screen display image displayed on your TV for an extended period of time you risk permanent damage to your television screen. Projection televisions are especially susceptible to this.

On moving the system

- Before moving the system, make sure that there is no disc inserted, and remove the AC power cord (mains lead) from the wall outlet (mains).

Notes about the Discs

On handling discs

- To keep the disc clean, handle the disc by its edge. Do not touch the surface.
- Do not stick paper or tape on the disc.



- Do not expose the disc to direct sunlight or heat sources such as hot air ducts, or leave it in a car parked in direct sunlight as the temperature may rise considerably inside the car.
- After playing, store the disc in its case.

On cleaning

- Before playing, clean the disc with a cleaning cloth.
Wipe the disc from the center out.



- Do not use solvents such as benzine, thinner, commercially available cleaners, or anti-static spray intended for vinyl LPs.

This system can only play a standard circular disc. Using neither standard nor circular discs (e.g., card, heart, or star shape) may cause a malfunction.

Do not use a disc that has a commercially available accessory attached, such as a label or ring.

Troubleshooting

If you experience any of the following difficulties while using the system, use this troubleshooting guide to help remedy the problem before requesting repairs. Should any problem persist, consult your nearest Sony dealer.

Note that if service personnel changes some parts during repair, these parts may be retained.

General

Symptom	Problems and solutions
The power is not turned on.	<ul style="list-style-type: none"> • Check that the AC power cord (mains lead) is connected securely.
The remote does not function.	<ul style="list-style-type: none"> • The distance between the remote and the unit is too far. • The batteries in the remote are weak.
The system does not work normally.	<ul style="list-style-type: none"> • Disconnect the AC power cord (mains lead) from the wall outlet (mains), then reconnect after several minutes. • Perform the following procedure (noting that the system parameters, such as preset stations, return to the default settings): <ol style="list-style-type: none"> ① Press I/⏻ to turn on the system. ② Press ▶, FUNCTION, and I/⏻ on the unit at the same time. "RESET" appears in the front panel display.

Picture

Symptom	Problems and solutions
There is no picture.	<ul style="list-style-type: none"> • The video input on your TV is not set so that you can view pictures from the system. • Check the output method on your system.
There is no picture when you make an HDMI cable connection.	<ul style="list-style-type: none"> • The unit is connected to an input device that is not HDCP (High-bandwidth Digital Content Protection) compliant. • If the HDMI OUT jack is used for video output, change the type of video signal output from the HDMI OUT jack (page 50). Connect your TV and the unit using a video jack other than HDMI OUT, and switch your TV's input to the connected video input so that you can see the on-screen displays. Change the type of video signal output from the HDMI OUT jack, and switch your TV's input back to HDMI. If the picture still does not appear, repeat the Steps and try other options.
Picture noise appears.	<ul style="list-style-type: none"> • If the signal from the EURO AV  OUTPUT (TO TV) jack is distorted, change the type of video signal output from the HDMI OUT jack by setting [HDMI RESOLUTION] in [HDMI SETUP] to [720 × 480p]* (page 50). <ul style="list-style-type: none"> * Depending on the area, [720 × 480/576p] may appear.
An image is not displayed on the entire TV screen.	<ul style="list-style-type: none"> • Check the setting of [TV TYPE] in [VIDEO SETUP] (page 50). • The aspect ratio on the disc is fixed.
Color irregularity occurs on the TV screen.	<p>The system's speakers contain magnet parts, so magnetic distortion may occur. When color irregularity occurs on the TV screen, check the following items:</p> <ul style="list-style-type: none"> • Install the speakers at least 0.3 meters from your TV set. • If the color irregularity persists, turn off your TV set once, then turn it on after 15 to 30 minutes. • Make sure that no magnetic object (magnetic latch on a TV stand, health care device, toy, etc.) is placed near the speakers. • Reposition the speakers farther away from your TV set.

Symptom	Problems and solutions
Playback picture becomes distorted.	<ul style="list-style-type: none"> • Set [YCbCr] in [YCbCr/RGB (HDMI)] to [RGB] (page 51).
Sound	
Symptom	Problems and solutions
There is no sound.	<ul style="list-style-type: none"> • The speaker cord is not connected securely. • Check the speaker settings (page 53).
There is no sound when the component (digital satellite receiver, PlayStation 3, etc.) is connected directly to your TV via HDMI.	<ul style="list-style-type: none"> • Perform the following: <ul style="list-style-type: none"> – Connect the system and TV with a SCART (EURO AV) cable (page 21) and select the “TV” function. – Disable your TV’s speakers.
There is no sound from the DIGITAL IN OPTICAL jack.	<ul style="list-style-type: none"> • The sampling frequency of the input stream is more than 48 kHz.
There is no digital sound from the HDMI OUT jack when using the Audio Return Channel function.	<ul style="list-style-type: none"> • Set [AUDIO RETURN CHANNEL] in [HDMI SETUP] to [AUTO] (page 51). • Set [CONTROL FOR HDMI] in [HDMI SETUP] to [ON] (page 51). • Make sure that your TV is compatible with the Audio Return Channel function. • Make sure that an HDMI cable is connected to a jack on your TV that is compatible with the Audio Return Channel function. • The sampling frequency of the input stream is more than 48 kHz.
The system does not output sound correctly when connected to a set-top box.	<ul style="list-style-type: none"> • Set [AUDIO RETURN CHANNEL] in [HDMI SETUP] to [OFF] (page 51).
Severe hum or noise is heard.	<ul style="list-style-type: none"> • Move your TV away from the audio components. • Clean the disc.
The sound loses stereo effect when you play a VIDEO CD, a CD, or an audio file.	<ul style="list-style-type: none"> • Select stereo sound by pressing AUDIO (page 32).
There is no sound or the volume level is very low from a certain speaker or all the speakers.	<ul style="list-style-type: none"> • Check the sound mode (page 41). • Check the speaker connections and settings (pages 20, 53). • Depending on the DVD, the output signal may not be the entire 5.1 channel.
The sound comes from the center speaker only.	<ul style="list-style-type: none"> • Depending on the disc, the sound may come from the center speaker only.
There is no system sound from your TV.	<ul style="list-style-type: none"> • Set [AUDIO (HDMI)] in [HDMI SETUP] to [ON] (page 51). • Perform the following procedure: <ol style="list-style-type: none"> ① Turn the system off and on again. ② Turn the connected component off and on again. ③ Disconnect and then connect the HDMI cable again.
The sound of files played from a DATA CD/DATA DVD/USB device is distorted.	<ul style="list-style-type: none"> • The bit rate used when encoding the audio files was low. Transfer audio files encoded with higher bit rates onto the DATA CD/DATA DVD/USB device.
There is noise or the sound skips while playing a USB device.	<ul style="list-style-type: none"> • Copy the files to your computer, format the USB device in FAT12, FAT16, or FAT32 format, and transfer the files to the USB device again.

Disc playback

Symptom	Problems and solutions
A disc does not play.	<ul style="list-style-type: none"> • The region code on the DVD does not match the system. • Moisture has condensed inside the unit and may cause damage to the lenses. Remove the disc and leave the unit turned on for about half an hour.
The language for the sound track or subtitle cannot be changed.	<ul style="list-style-type: none"> • Set the language via the disc's menu.
A disc does not start playing from the beginning.	<ul style="list-style-type: none"> • While in stop mode, press ■ on the unit or the remote and then start playback (page 30).
A DATA CD/DATA DVD cannot be played.	<ul style="list-style-type: none"> • The DATA CD is not recorded in ISO 9660 Level 1/Level 2, or Joliet. • The DATA DVD is not recorded in UDF (Universal Disk Format).
A file cannot be played.	<ul style="list-style-type: none"> • The extension of the file name or file format is not correct. See "Playable Discs/Files on a USB Device" (page 5). • Check the [MEDIA] setting (page 30). • The system can play to a depth of 8 folders only. • Check that the number of folders is 200 or less. • Check that the number of audio files/JPEG image files in the folder is 150 or less.
A JPEG image file cannot be viewed.	<ul style="list-style-type: none"> • The JPEG image file is larger than 3,072 (width) × 2,048 (height) pixels in normal format, or more than 2,000,000 pixels in progressive format which is mainly used on Internet Web sites.
A video file cannot be played.	<ul style="list-style-type: none"> • The video file is larger than 720 (width) × 576 (height).
The titles of folders/files/file names are not displayed correctly.	<ul style="list-style-type: none"> • The system can only display numbers and letters of the alphabet. Other characters are not displayed correctly.

USB playback

Symptom	Problems and solutions
A USB device does not start playing from the beginning.	<ul style="list-style-type: none"> • While in stop mode, press ■ on the unit or the remote and then start playback (page 30).
A USB device cannot be played.	<ul style="list-style-type: none"> • USB devices formatted with file systems other than FAT12, FAT16, or FAT32 are unsupported.* * This system supports FAT12, FAT16, and FAT32, but some USB devices may not support all of these. For details, refer to the operating instructions of the USB device or contact the manufacturer. • If you use a partitioned USB device, only audio files on the first partition can be played.
A file cannot be played.	<ul style="list-style-type: none"> • The extension of the file name or file format is not correct. See "Playable Discs/Files on a USB Device" (page 5). • Check the [MEDIA] setting (page 30). • The system can play to a depth of 8 folders only. • Check that the number of folders is 200 or less. • Check that the number of audio files/JPEG image files in the folder is 150 or less. • Files that are encrypted or protected by passwords, etc. cannot be played.
A JPEG image file cannot be viewed.	<ul style="list-style-type: none"> • The JPEG image file is larger than 3,072 (width) × 2,048 (height) pixels in normal format, or more than 2,000,000 pixels in progressive format which is mainly used on Internet Web sites.
A video file cannot be played.	<ul style="list-style-type: none"> • The video file is larger than 720 (width) × 576 (height).

Symptom	Problems and solutions
A WMA file cannot be played.	<ul style="list-style-type: none"> • A WMA file that is in WMA DRM, WMA Lossless, or WMA PRO format cannot be played.
An AAC file cannot be played.	<ul style="list-style-type: none"> • An AAC file that is in AAC DRM or AAC Lossless format cannot be played.
The titles of folders/files/file names are not displayed correctly.	<ul style="list-style-type: none"> • The system can only display numbers and letters of the alphabet. Other characters are not displayed correctly.
It takes time until playback starts.	<ul style="list-style-type: none"> • After the system reads all files on the USB device, playback may take more time than usual if: <ul style="list-style-type: none"> – there are many folders or files on the USB device. – the folder or file organization structure is very complex. – the memory capacity is very large. – the file size is extremely large. – the internal memory is fragmented. • The system is playing an audio file in AAC format.
A USB device which has been used on another device does not work.	<ul style="list-style-type: none"> • It may be recorded in an unsupported format. If so, first take the precaution of backing up important files on the USB device by copying them to your computer hard disk. Next, format the USB device in FAT12, FAT16, or FAT32 format, and transfer the files to the USB device again.

Audio track/file transfer

Symptom	Problems and solutions
You cannot start transferring onto a USB device.	<ul style="list-style-type: none"> • The following problems may have occurred: <ul style="list-style-type: none"> – The USB device is full. – The number of audio files and folders on the USB device has reached the upper limit. – The USB device is write-protected.
Transferring stops before it is finished.	<ul style="list-style-type: none"> • The communication speed of the USB device is extremely slow. Connect a USB device that this system can play. • If the transferring and erasing operations are repeated multiple times, the file structure within the USB device becomes complex. Follow the procedure in the operating instructions of the USB device to format the USB device. If the problem persists, contact your nearest Sony dealer. • The USB device is full. • The number of audio files and folders on the USB device has reached the upper limit.
Transferring to a USB device results in an error.	<ul style="list-style-type: none"> • The USB device was disconnected or the power was turned off during erasing. Delete the partially-erased file. If this does not fix the problem, the USB device may be broken. Follow the procedure in the operating instructions of the USB device to format the USB device. If the problem persists, contact your nearest Sony dealer. • Check if the USB device is write-protected.
Audio files or folders on the USB device cannot be erased.	<ul style="list-style-type: none"> • Check if the USB device is write-protected.



Tuner

Symptom	Problems and solutions
Radio stations cannot be tuned in.	<ul style="list-style-type: none">• Check that the antenna (aerial) is connected securely. Adjust the antenna (aerial) or connect an external antenna (aerial) if necessary.• The signal strength of the stations is too weak (when tuning in with automatic tuning). Use direct tuning.
FM reception is poor.	<ul style="list-style-type: none">• Use a 75-ohm coaxial cable (not supplied) to connect the unit to an outdoor FM antenna (aerial).
RDS does not work properly.	<ul style="list-style-type: none">• The station you are tuned to is not transmitting the RDS signal properly, or the signal strength is weak.

Control for HDMI

Symptom	Problems and solutions
The Control for HDMI function does not work.	<ul style="list-style-type: none">• Set [CONTROL FOR HDMI] in [HDMI SETUP] to [ON] (page 51).• Make sure that the connected component is compatible with the [CONTROL FOR HDMI] function.• Check the connected component's setting for the Control for HDMI function. Refer to the operating instructions of the component.• If you change the HDMI connection, connect and disconnect the AC power cord (mains lead), or have a power failure, set [CONTROL FOR HDMI] in [HDMI SETUP] to [OFF], then set to [ON] (page 51).• For details, see "Using the Control for HDMI Function for "BRAVIA" Sync" (page 42).
No sound is output from the system and TV while using the System Audio Control function.	<ul style="list-style-type: none">• Make sure that the connected TV is compatible with the System Audio Control function.• For details, see "Using the Control for HDMI Function for "BRAVIA" Sync" (page 42).
Your TV's input select does not change automatically when you connect the system and TV with a SCART (EURO AV) cable.	<ul style="list-style-type: none">• Set [CONTROL FOR HDMI] in [HDMI SETUP] to [OFF] (page 51).

Messages

Symptom	Problems and solutions
“PROTECT” and “PUSH PWR” appear alternately.	<ul style="list-style-type: none">• Press I/⏻ to turn off the system, and check the following items after “STANDBY” disappears:<ul style="list-style-type: none">– Are the + and – speaker cords short-circuited?– Is anything blocking the ventilation holes of the system?– After checking the above items and fixing any problems, turn on the system. If the cause of the problem cannot be found even after checking all the above items, consult your nearest Sony dealer.
“OVERLOAD,” “REMOVE,” “USB,” then “PUSH PWR” appear.	<ul style="list-style-type: none">• A problem has been detected with the level of electrical current from the  (USB) port. Turn off the system and remove the USB device from the  (USB) port. Make sure there is no problem with the USB device. If this display pattern persists, contact your nearest Sony dealer.
“LOCKED” appears and a disc cannot be ejected.	<ul style="list-style-type: none">• Contact your Sony dealer or local authorized Sony service facility.
“DATA ERR” appears.	<ul style="list-style-type: none">• The file you want to play is broken.• The file format does not match the extension of the file name. See “Playable Discs/Files on a USB Device” (page 5).• The JPEG image file format does not conform to DCF.
“READING” is displayed for a long time while playing.	<ul style="list-style-type: none">• The reading process can take a long time if:<ul style="list-style-type: none">– there are many folders or files on the USB device.– the folder or file organization structure is very complex.– the memory capacity is very large.– the internal memory is fragmented.

Self-diagnosis Function

(When letters/numbers appear in the display)

When the self-diagnosis function is activated to prevent the system from malfunctioning, a 5-character service number (e.g., C 13 50) with a combination of a letter and 4 digits appears on the TV screen or front panel display. In this case, check the following table:

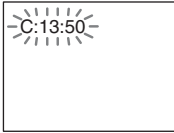

When the version number appears on the TV screen

When you turn on the system, the version number [VER.X.XX] (X is a number) may appear on the TV screen. Although this is not a malfunction and for Sony service use only, normal system operation will not be possible. Turn off the system, and then turn on the system again to operate.



First 3 characters of the service number	Cause and/or corrective action
--	--------------------------------

C 13	The disc is dirty. ➔Clean the disc with a soft cloth (page 56).
------	--

E XX (XX is a number)	To prevent a malfunction, the system has performed the self-diagnosis function. ➔Contact your nearest Sony dealer or local authorized Sony service facility and give the 5-character service number. Example: E 61 10
--------------------------	---

Specifications

Amplifier Section

POWER OUTPUT (rated): Front L/Front R/Center/
Surround L/Surround R:
108 W (per channel at 3
ohms, 1 kHz, 1% THD)

POWER OUTPUT (reference):
Front L/Front R/Center/
Surround L/Surround R:
167 W (per channel at 3
ohms, 1 kHz)
Subwoofer: 165 W
(at 3 ohms, 80 Hz)

Inputs (Analog)

TV (AUDIO IN) Sensitivity: 450/250 mV

Inputs (Digital)

TV (Audio Return Channel/OPTICAL IN)
Input Stream: Dolby
Digital 5.1ch/DTS 5.1ch/
Linear PCM 2ch
(Sampling Frequency: less
than 48 kHz)

CD/DVD System

Laser Diode Properties Emission Duration:
Continuous
Laser Output: Less than
44.6 μ W

* This output is the value measurement at a distance
of 200 mm from the objective lens surface on the
Optical Pick-up Block with 7 mm aperture.

Signal format system PAL/NTSC

USB Section

↔ (USB) port:

Maximum current: 500 mA

Tuner Section

System PLL quartz-locked digital
synthesizer
Tuning range 87.5 MHz - 108.0 MHz (50
kHz step)

Antenna (aerial) FM wire antenna (aerial)

Antenna (aerial) terminals 75 ohms, unbalanced

Video Section

Outputs VIDEO: 1 V_{p-p} 75 ohms
R/G/B: 0.7 V_{p-p} 75 ohms
HDMI OUT: Type A (19
pin)

Speakers

Front

DAV-DZ340 (SS-TS111)

Dimensions (approx.) 108 mm × 164 mm × 88
mm (w/h/d)

Mass (approx.) 0.5 kg

DAV-DZ740 (SS-TS113)

Dimensions (approx.) 108 mm × 595 mm × 79
mm (w/h/d) (wall-mounted
part)

260 mm × 1,005 mm × 260
mm (w/h/d) (whole
speaker)

Mass (approx.) 1.1 kg (wall-mounted part)
2.3 kg (whole speaker)

Center (SS-CT111)

Dimensions (approx.) 261 mm × 82 mm × 79 mm
(w/h/d)

Mass (approx.) 0.6 kg

Surround (SS-TS111)

Dimensions (approx.) 108 mm × 164 mm × 88
mm (w/h/d)

Mass (approx.) 0.5 kg

Subwoofer

DAV-DZ340 (SS-WS101)

Dimensions (approx.) 169 mm × 300 mm × 320
mm (w/h/d)

Mass (approx.) 5.3 kg

DAV-DZ740 (SS-WS111)

Dimensions (approx.) 230 mm × 400 mm × 305
mm (w/h/d)

Mass (approx.) 6.4 kg

General

Power requirements 220 V - 240 V AC,
50/60 Hz

Power consumption On: 160 W
Standby: 0.3 W*

* Valid when the system is in the following status:

– “DEMO” is set to “OFF.”

– [CONTROL FOR HDMI] is set to [OFF].

Dimensions (approx.) 430 mm × 55 mm × 350
mm (w/h/d) incl.
projecting parts

Mass (approx.) 3.5 kg

Supported file format

MP3 (MPEG 1 Audio Layer-3)

File Extension: mp3

Bitrate: 32 kbps - 320 kbps

Sampling frequencies: 32/44.1/48 kHz

WMA (USB device only)

File Extension: wma
Bitrate: 48 kbps - 192 kbps
Sampling frequencies: 44.1 kHz

AAC (USB device only)

File Extension: m4a
Bitrate: 48 kbps - 320 kbps
Sampling frequencies: 44.1 kHz

Xvid

File Extension: avi
Video codec: Xvid video
Bitrate: 4.854 Mbps (MAX)
Resolution/Frame rate: 720 × 480 30 fps
720 × 576 25 fps
Audio codec: MP3

MPEG4

File format: MP4 File Format
File Extension: mp4/m4v
Video codec: MPEG4 Simple Profile
(AVC is not compatible.)
Bitrate: 4 Mbps
Frame rate: 30 fps
Resolution: 720 × 576
Audio codec: AAC-LC (HE-AAC is not compatible.)
DRM: Not compatible

Design and specifications are subject to change without notice.

- Standby power consumption 0.3 W.
- Over 85% power efficiency of amplifier block is achieved with the full digital amplifier, S-Master.

Playback Priority of File Types

The table below describes the playback priority of file types under the [MEDIA] setting.

File type on a disc or USB device	[MEDIA] setting				
	[VIDEO]		[MUSIC/ PHOTO]	[PHOTO]	[MUSIC]
	Disc	USB device	Disc	Disc/USB device	Disc/USB device
Video files only	Video files	Video files	Video files	Video files	Video files
JPEG image files only	JPEG image files	JPEG image files	JPEG image files	JPEG image files	JPEG image files
Audio files only	MP3 files	Audio files	MP3 files	Audio files*	Audio files*
Video files and JPEG image files	Video files	Video files	JPEG image files	JPEG image files	Video files
Video files and audio files	Video files	Video files	MP3 files	Audio files*	Audio files*
Audio files and JPEG image files	MP3 files and JPEG image files with slide show	Audio files	MP3 files and JPEG image files with slide show	JPEG image files	Audio files*
Video files, audio files, and JPEG image files	Video files	Video files	MP3 files and JPEG image files with slide show	JPEG image files	Audio files*

* When using a disc, you can play MP3 files only.

Language Code List

The language spellings conform to the ISO 639: 1988 (E/F) standard.

Code Language	Code Language	Code Language	Code Language
1027	Afar	1183	Irish
1028	Abkhazian	1186	Scots Gaelic
1032	Afrikaans	1194	Galician
1039	Amharic	1196	Guarani
1044	Arabic	1203	Gujarati
1045	Assamese	1209	Hausa
1051	Aymara	1217	Hindi
1052	Azerbaijani	1226	Croatian
1053	Bashkir	1229	Hungarian
1057	Byelorussian	1233	Armenian
1059	Bulgarian	1235	Interlingua
1060	Bihari	1239	Interlingue
1061	Bislama	1245	Inupiak
1066	Bengali; Bangla	1248	Indonesian
1067	Tibetan	1253	Icelandic
1070	Breton	1254	Italian
1079	Catalan	1257	Hebrew
1093	Corsican	1261	Japanese
1097	Czech	1269	Yiddish
1103	Welsh	1283	Javanese
1105	Danish	1287	Georgian
1109	German	1297	Kazakh
1130	Bhutani	1298	Greenlandic
1142	Greek	1299	Cambodian
1144	English	1300	Kannada
1145	Esperanto	1301	Korean
1149	Spanish	1305	Kashmiri
1150	Estonian	1307	Kurdish
1151	Basque	1311	Kirghiz
1157	Persian	1313	Latin
1165	Finnish	1326	Lingala
1166	Fiji	1327	Laothian
1171	Faroese	1332	Lithuanian
1174	French	1334	Latvian; Lettish
1181	Frisian	1345	Malagasy
1347	Maori	1356	Marathi
1349	Macedonian	1357	Malay
1350	Malayalam	1358	Maltese
1352	Mongolian	1363	Burmese
1353	Moldavian	1365	Nauru
1356	Marathi	1369	Nepali
1357	Malay	1376	Dutch
1358	Maltese	1379	Norwegian
1363	Burmese	1393	Occitan
1365	Nauru	1403	(Afan)Oromo
1369	Nepali	1408	Oriya
1376	Dutch	1417	Punjabi
1379	Norwegian	1428	Polish
1393	Occitan	1435	Pashto; Pushto
1403	(Afan)Oromo	1436	Portuguese
1408	Oriya	1463	Quechua
1417	Punjabi	1481	Rhaeto- Romance
1428	Polish	1482	Kirundi
1435	Pashto; Pushto	1483	Romanian
1436	Portuguese	1489	Russian
1463	Quechua	1491	Kinyarwanda
1481	Rhaeto- Romance	1495	Sanskrit
1482	Kirundi	1498	Sindhi
1483	Romanian	1501	Sangho
1489	Russian	1502	Serbo-Croatian
1491	Kinyarwanda	1503	Singhalese
1495	Sanskrit	1505	Slovak
1498	Sindhi	1506	Slovenian
1501	Sangho		
1502	Serbo-Croatian		
1503	Singhalese		
1505	Slovak		
1506	Slovenian		
1507	Samoan	1527	Tajik
1508	Shona	1528	Thai
1509	Somali	1529	Tigrinya
1511	Albanian	1531	Turkmen
1512	Serbian	1532	Tagalog
1513	Siswati	1534	Setswana
1514	Sesotho	1535	Tonga
1515	Sundanese	1538	Turkish
1516	Swedish	1539	Tsonga
1517	Swahili	1540	Tatar
1521	Tamil	1543	Twi
1525	Telugu	1557	Ukrainian
1527	Tajik	1564	Urdu
1528	Thai	1572	Uzbek
1529	Tigrinya	1581	Vietnamese
1531	Turkmen	1587	Volapük
1532	Tagalog	1613	Wolof
1534	Setswana	1632	Xhosa
1535	Tonga	1665	Yoruba
1538	Turkish	1684	Chinese
1539	Tsonga	1697	Zulu
1540	Tatar		
1543	Twi		
1557	Ukrainian		
1564	Urdu		
1572	Uzbek		
1581	Vietnamese		
1587	Volapük		
1613	Wolof		
1632	Xhosa		
1665	Yoruba		
1684	Chinese		
1697	Zulu		
1703	Not specified		

Parental Control Area Code List

Code Area	Code Area	Code Area	Code Area
2044	Argentina	2165	Finland
2047	Australia	2174	France
2046	Austria	2109	Germany
2057	Belgium	2248	India
2070	Brazil	2238	Indonesia
2079	Canada	2254	Italy
2090	Chile	2276	Japan
2092	China	2304	Korea
2115	Denmark	2363	Malaysia
2362	Mexico	2427	Pakistan
2376	Netherlands	2424	Philippines
2390	New Zealand	2436	Portugal
2379	Norway	2489	Russia
2427	Pakistan	2501	Singapore
2424	Philippines		
2436	Portugal		
2489	Russia		
2501	Singapore		
2149	Spain		
2499	Sweden		
2086	Switzerland		
2528	Thailand		
2184	United Kingdom		

Index

A

A/V SYNC 47
ANGLE 32
AUDIO 50
AUDIO (HDMI) 51
AUDIO DRC 51
AUDIO RETURN CHANNEL
51
AUDIO SETUP 51
AUTO.STBY 48

B

BACKGROUND 52

C

CONTROL FOR HDMI 51
Control for HDMI 42
Control Menu 14
CUSTOM 49

D

DEMO 48
DIMMER 48
DUAL MONO 47
DVD's menu 32

E

EFFECT 35

F

FM MODE 39
Front panel 10

H

HDMI
YCBCR/RGB (HDMI) 51
HDMI RESOLUTION 50
HDMI SETUP 50

I

INTERVAL 36

J

JPEG RESOLUTION 51

L

Language Code List 67
LANGUAGE SETUP 49
LINE 50

M

MEDIA 30, 36
MENU 49
Multi Session CD 7
MULTI-DISC RESUME 53
Multiplex broadcast sound 47

O

OSD 49

P

PARENTAL CONTROL 52
PAUSE MODE 50
Playable discs 5
Program Play 33

Q

Quick Setup 25

R

RDS 40
Rear panel 11
Region code 7
Remote control 12
Repeat Play 35
RESET 53

S

SCREEN SAVER 52
SETUP 49
Shuffle Play 34
SLEEP 46
SOUND MODE 41
SPEAKER SETUP 53
CONNECTION 53
DISTANCE 53
LEVEL 53, 54
SUBTITLE 32, 50
SYSTEM MENU 39, 46, 47,
48
SYSTEM SETUP 52

T

TEST TONE 54
TIME 31
TRACK SELECTION 52
TV TYPE 50

V

VIDEO SETUP 50

HDMI  **R·D·S**

<http://www.sony.net/>

4-262-748-12(1)



Free Manuals Download Website

<http://myh66.com>

<http://usermanuals.us>

<http://www.somanuals.com>

<http://www.4manuals.cc>

<http://www.manual-lib.com>

<http://www.404manual.com>

<http://www.luxmanual.com>

<http://aubethermostatmanual.com>

Golf course search by state

<http://golfingnear.com>

Email search by domain

<http://emailbydomain.com>

Auto manuals search

<http://auto.somanuals.com>

TV manuals search

<http://tv.somanuals.com>