

SONY[®]

2-649-081-11(1)

Portable CD/DVD Player

Operating Instructions



DVP-FX705

© 2005 Sony Corporation

WARNING

To prevent fire or shock hazard, do not expose the unit to rain or moisture.
To avoid electrical shock, do not open the cabinet. Refer servicing to qualified personnel only.

CAUTION

The use of optical instruments with this product will increase eye hazard. As the laser beam used in this CD/DVD player is harmful to eyes, do not attempt to disassemble the cabinet.
Refer servicing to qualified personnel only.

CAUTION CLASS 1M VISIBLE AND INVISIBLE LASER RADIATION
WHEN OPEN AND INTERLOCKS DEFEATED.
DO NOT VIEW DIRECTLY WITH OPTICAL INSTRUMENTS.

This label is located on the bottom of the unit.

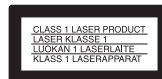

This CD/DVD player is **CLASS 1 LASER PRODUCT**.



This symbol is intended to alert the user to the presence of uninsulated “dangerous voltage” within the product’s enclosure that may be of sufficient magnitude to constitute a risk of electric shock to persons.



This symbol is intended to alert the user to the presence of important operating and maintenance (servicing) instructions in the literature accompanying the appliance.

Welcome!

Thank you for purchasing this Sony Portable CD/DVD Player. Before operating this player, please read this manual thoroughly and retain it for future reference.

Important Safety Instructions

1. Read these instructions.
 2. Keep these instructions.
 3. Heed all warnings.
 4. Follow all instructions.
 5. Do not use this apparatus near water.
 6. Clean only with dry cloth.
 7. Do not block any ventilation openings. Install in accordance with the manufacturer's instructions.
 8. Do not install near any heat sources such as radiators, heat registers, stoves, or other apparatus (including amplifiers) that produce heat.
 9. Do not defeat the safety purpose of the polarized or grounding-type plug. A polarized plug has two blades with one wider than the other. A grounding type plug has two blades and a third grounding prong. The wide blade or the third prong are provided for your safety. If the provided plug does not fit into your outlet, consult an electrician for replacement of the obsolete outlet.
 10. Protect the power cord from being walked on or pinched particularly at plugs, convenience receptacles, and the point where they exit from the apparatus.
 11. Only use attachments/accessories specified by the manufacturer.
 12. Use only with the cart, stand, tripod, bracket, or table specified by the manufacturer, or sold with the apparatus. When a cart is used, use caution when moving the cart/apparatus combination to avoid injury from tip-over.
-
13. Unplug this apparatus during lightning storms or when unused for long periods of time.
 14. Refer all servicing to qualified service personnel. Servicing is required when the apparatus has been damaged in any way, such as power-supply cord or plug is damaged, liquid has been spilled or objects have fallen into the apparatus, the apparatus has been exposed to rain or moisture, does not operate normally, or has been dropped.

Precautions

For Customers in the U.S.A

Owner's Record

The model and serial numbers are located on the bottom of the unit. Record the serial number in the space provided below. Refer to them whenever you call upon your Sony dealer regarding this product.

Model No. DVP-FX705

Serial No. _____

For Customers in Canada

If this product is not working properly, please call 1-877-602-2008 for Peace of Mind Warranty Replacement service. For other product related questions please contact our Customer Information Service Centre at 1-877-899-7669 or write to us at: Customer Information Service 115 Gordon Baker Road, Toronto, Ontario, M2H 3R6

CAUTION

You are cautioned that any changes or modifications not expressly approved in this manual could void your authority to operate this equipment.

NOTE

This equipment has been tested and found to comply with the limits for a Class B digital device, pursuant to Part 15 of the FCC Rules. These limits are designed to provide reasonable protection against harmful interference in a residential installation. This equipment generates, uses, and can radiate radio frequency energy and, if not installed and used in accordance with the instructions, may cause harmful interference to radio communications. However, there is no guarantee that interference will not occur in a particular installation. If this equipment does cause harmful interference to radio or television reception, which can be determined by turning the equipment off and on, the user is encouraged to try to correct the interference by one or more of the following measures:

- Reorient or relocate the receiving antenna.
- Increase the separation between the equipment and receiver.
- Connect the equipment into an outlet on a circuit different from that to which the receiver is connected.
- Consult the dealer or an experienced radio/TV technician for help.

Precautions (continued)

- The power requirements and power consumption of this unit are indicated on the AC adaptor. Check that the unit's operating voltage is identical with your local power supply.

On safety

- Caution – The use of optical instruments with this product will increase eye hazard.
- To prevent fire or shock hazard, do not place objects filled with liquids, such as vases, on the apparatus.
- Should any solid object or liquid fall into the cabinet, unplug the player and have it checked by qualified personnel before operating it any further.
- Do not put any foreign objects in the DC IN 9.8V (external power input) jack.
- This car adaptor is not intended to be serviced. Should the product cease to function in its intended manner, it should be returned to the manufacturer or to be discarded.

On temperature increases

- Heat may build up while charging or during extended use. This is not a malfunction.
- If the surrounding temperature is very high, the protective function will turn off the player automatically. Leave the player in a cool location for about 30 minutes before using it again.

On power sources

- Use only the supplied AC adaptor. Do not use any other AC adaptor. It may cause a malfunction.

Polarity of the plug

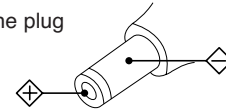

- If the AC adaptor causes interference to radio reception, move it away from the radio.
- Do not touch the AC adaptor with wet hands.
- Even when the player is turned off, it is still connected to the AC power source (mains) as long as it remains connected to the wall outlet.
- If you are not going to use the player for a long time, be sure to disconnect the player from the wall outlet. To disconnect the AC power cord (mains lead), grasp the plug itself; never pull the cord.
- Should the AC power cord need to be changed, have it done at a qualified service shop only.
- Use a commercially available AC plug adaptor, if necessary, depending on the design of the wall outlet.

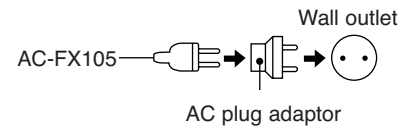

Precautions (continued)

CAUTION

Never expose the battery pack to temperatures above 140° F (60° C) such as in a car parked in the sun or under direct sunlight.

On the rechargeable battery

- Charge the battery before you start using it.
- Do not allow dust to come into contact with the battery terminals of the player and battery.
- Do not short the terminals.
- Do not open the terminal covers of the player.
- Do not leave the battery in a place subject to direct sunlight, or in a car with its windows closed.
- Keep the battery dry.
- Use only the battery(NP-FX105) supplied with this player(DVP-FX705). Other rechargeable batteries supplied with other models cannot be used with this player.
- Do not disassemble.
- Do not incinerate.
- Dispose of used batteries promptly.

To dispose of the rechargeable battery

- Certain countries may regulate disposal of the battery used to power this product. Please consult with your local authority.

To store the rechargeable battery

The battery is consumed gradually as time elapses even if is not used. In order to prevent the battery from deteriorating, store it as follows:

- Remove the battery from the player after use. (Even if the player is off, it still uses some power.)
- Use up the battery completely on the player before storing it.
- Keep the battery in a cool location to prevent it from deteriorating.
- Charge and use the battery at least once every 6 months.

On charging the rechargeable battery

- Heat may build up in the battery while charging. This is not a malfunction.
- When the battery life of a fully charged battery becomes about half the normal life, you may need to replace the battery with a new one.
- Disconnect the battery from the player as soon as it has been charged. Leaving it connected may result in reduced battery performance.

Precautions (continued)

On handling the player

- Keep the lens on the player clean and do not touch it. If you do so, the lens may be damaged, and the player will not operate properly.
- Place the player in a location with adequate ventilation to prevent heat build-up in the player.
- Do not put any heavy object on top of the player. The player and the discs may be damaged.
- Do not leave the player in a location near heat sources, or in a place subject to direct sunlight, excessive dust or sand, moisture, rain, mechanical shock, on an unlevel surface, or in a car with its windows closed.
- Do not wrap the player in a cloth or blanket during use as it may cause malfunction or serious accidents.
- If the player causes interference to radio or television reception, turn off the player or move it away from the radio or television.
- Keep the player and discs away from equipment with strong magnets, such as microwave ovens, or large loudspeakers.
- Do not install this equipment in a confined space such as a bookshelf or similar unit.

- If the player is brought directly from a cold to warm location, or is placed in a very damp place, moisture may condense on the lenses of the player. Should this occur, the player may not operate properly. In this case, remove the disc and leave the player for about half an hour until the moisture evaporates.

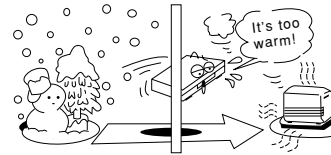

- Discs with non-standard shapes (e.g. heart, square, star) cannot be played on this player. Do not use such discs.
- While operating, do not move, shake or otherwise allow any shock to the player. It may cause a malfunction.
- Use this player in a stable, horizontal position where it is not subject to vibration.
- Do not touch the disc if it is still spinning when you open the lid.
- Before moving the player, remove any disc from it. If you don't, the disc may be damaged.

Precautions (continued)

On handling the LCD screen

- The LCD is manufactured using high-precision technology. You may, however, see tiny black points and/or bright points (red, blue, green) that continuously appear on the LCD. This is a normal result of the manufacturing process and does not indicate a malfunction.
- Do not scratch the LCD or exert pressure on it. This could cause a malfunction.
- Using the player in low temperature conditions may produce a residual image on the screen. This is not a malfunction. When the player returns to normal temperature, the screen returns to normal.
- A residual image may appear on the screen if the same image is displayed for a lengthy period of time. The residual image disappears in a while.
If you are going to leave the player for a long time, turn off the power.
- The screen becomes warm during operation.
This is normal and does not indicate a malfunction.

On headphones

Preventing hearing damage

Avoid using headphones at high volume. Hearing experts advise against continuous, loud, and extended play. If you experience a ringing in your ears, reduce the volume or discontinue use.

Showing consideration for others

Keep the volume at a moderate level. This will allow you to hear outside sounds and still be considerate to the people around you.

On adjusting the volume

Do not turn up the volume while listening to a section with very low level inputs or no audio signal. If you do, the speakers may be damaged when a peak-level section is played.

Road safety

Do not use the monitor unit and headphones while driving, cycling, or operating any motorized vehicle. It may create a traffic hazard and is illegal in some areas. It can also be potentially dangerous to play your headsets at high volume while walking, especially at pedestrian crossings. You should exercise extreme caution or discontinue use in potentially hazardous situations.

- Do not install the monitor display where viewable by the driver.
- Some states restrict the use of monitors and televisions in vehicles. Where use is permitted, the units should not be installed or operated so as to be viewable by the driver.

Precautions (continued)

On transportation

- When you transport this player, use the original carton box and packing materials.
- Before you move this player, make sure to remove any discs from it.

On cleaning

Clean the cabinet, panel, and controls with a soft cloth slightly moistened with a mild detergent solution. Do not use any type of abrasive pad, scouring powder, or solvent such as alcohol or benzene.

On cleaning discs

Do not use a commercially available cleaning disc. It may cause a malfunction.

IMPORTANT NOTICE

Caution: This player is capable of holding a still video image or on-screen display image on your television screen indefinitely. If you leave the still video image or on-screen display image displayed on your TV for an extended period of time you risk permanent damage to your television screen. Plasma Display Panel televisions and projection televisions are especially susceptible to this.

If you have any questions or problems concerning your player, please consult your nearest Sony dealer.

RECYCLING LITHIUM-ION BATTERIES

Lithium-ion batteries are recyclable. You can help preserve our environment by returning your used rechargeable batteries to the collection and recycling location nearest you.







For more information regarding recycling of rechargeable batteries, call toll free 1-800-822-8837, or visit <http://www.rbc.org/>

Caution:

- Do not handle damaged or leaking Lithium-ion batteries. Never expose the battery pack to temperatures above 140°F (60° C) such as in a car parked in the sun or under direct sunlight.
- **For the customers in the United States**
This product contains mercury. Disposal of this product may be regulated if sold in the United States. For disposal or recycling information, please contact your local authorities or the Electronics Industries Alliance.
(www.eiae.org <http://www.eiae.org>)

About This Manual

- Instructions in this manual describe the controls on the remote. You can also use the controls on the player if they have the same or similar names as those on the remote.
- The meanings of the icons used in this manual are described below:
- “” may appear on the LCD screen during operation. This icon means the function explained in this instruction manual is not available on that specific DVD video disc.

Icon	Meaning
	Functions available for DVD VIDEOS and DVD-RWs/ DVD-Rs or DVD+RWs / DVD+Rs in video mode
	Functions available for music CDs or CD-Rs/ CD-RWs in music CD format
 	Functions available for DATA CDs (CD-ROMs/ CD-Rs/ CD-RWs containing MP3* audio tracks and JPEG image files)

* MP3 (MPEG 1 Audio Layer 3) is a standard format defined by ISO(International Organization for Standardization)/ MPEG which compresses audio data.

This Player Can Play the Following Discs

Format of discs	
DVD VIDEO	
Music CD	

The “DVD VIDEO” is a trademark.

Disc-related terms

DVD ±R / DVD ±RW

DVD-R and DVD+R are two different standards for recordable DVD drives and discs.

This format allows information to be recorded onto the DVD disc only once. DVD +RW and DVD -RW are two standards for re-writable media, meaning the DVD content can be erased and re-recorded. Single-sided discs can hold 4.38 Gigabytes and double-sided discs can hold twice as much.

This Player Can Play the Following Discs (continued)

MP3

MP3 is a popular compression format used for digital audio files that yields very high, near-CD quality.

JPEG

Joint Pictures Expert Group. JPEG is a compressed file format that allows you to save images with no limit on the number of colors.

Title (DVD video discs only)

A title is generally a distinct section of a DVD disc. For example the main feature could be title 1, a documentary describing how the film was made could be title 2, and cast interviews could be title 3. Each title is assigned a reference number enabling you to locate it easily.

Manufactured under license from Dolby Laboratories. "Dolby", "Pro Logic", and the double-D symbol are trademarks of Dolby Laboratories.

NOTE:

Depending on the conditions of the recording equipment or the CD-R/RW (or DVD±R/±RW) disc itself, some CD-R/RW (or DVD±R/±RW) discs cannot be played on the unit.

This Player Can Play the Following Discs (continued)

Region code

Your player has a region code printed on the back of the unit and only will play DVD VIDEO discs (playback only) labeled with identical region codes. This system is used to protect copyrights.

DVD VIDEOS labeled  will also play on this player.

If you try to play any other DVD VIDEO, the message “Check Regional Code” will appear on the LCD screen. Depending on the DVD VIDEO, no region code indication may be labeled even though playing the DVD VIDEO is prohibited by area restrictions.

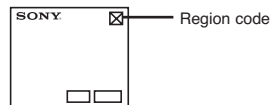

Note on DualDiscs

A DualDisc is a two sided disc product which mates DVD recorded material on one side with digital audio material on the other side. However, since the audio material does not conform to the Compact Disc (CD) standard, playback on this product is not guaranteed.

Note on playback operations of DVDs

Some playback operations of DVDs may be intentionally set by software producers. Since this player plays DVDs according to the disc contents the software producers designed, some playback features may not be available. Also, refer to the instructions supplied with the DVDs.

Copyrights

This product incorporates copyright protection technology that is protected by U.S. patents and other intellectual property rights. Use of this copyright protection technology must be authorized by Macrovision, and is intended for home and other limited viewing uses only unless otherwise authorized by Macrovision. Reverse engineering or disassembly is prohibited.

Notes about the Discs

On handling discs

- To keep the disc clean, handle the disc by its edge. Do not touch the surface.
- Do not stick paper or tape on the disc.



On storing discs

- Do not expose the disc to direct sunlight or heat sources such as air ducts, or leave it in a car parked in direct sunlight as the temperature may rise considerably inside the car.
- After playing, store the disc in its case.

On cleaning discs

- Fingerprints or dust on a disc may cause the image or sound quality to deteriorate. Use clean discs.
- Wipe the disc with a soft cloth from the center out.



- If the disc is very dirty, first wipe it with a damp cloth, then wipe it again with a dry cloth.
- Do not use solvents such as benzene, thinner, commercially available cleaners, or anti-static spray intended for vinyl LPs.

Table of Contents

Introductions	
❑ WARNING	.2
❑ Welcome!	.2
❑ Important Safety Instructions	.3
❑ Precautions	.4-9
❑ About This Manual	.10
❑ This Player Can Play the Following Discs	.10-12
❑ Notes on playback operations of DVDs	.13
❑ Copyrights	.13
❑ Notes about the Discs	.13
❑ Table of Contents	.14
❑ Identification of Controls	.15-20
Main Unit	.15-16
Remote Control	.17-19
❑ Power Connections	.20-22
AC Adaptor	.21
Battery Pack	.21-22
Basic Operations	
❑ Playing a Disc	.23-27
Basic Playback	.23-25
Stopping Play	.26
Resume Play	.26
Screen Saver	.26
Pause	.27
Search	.27
Slow Motion	.27
❑ On-Screen Display	.28-29
Advanced Operations	
❑ General Features	.30-32
Title Menu	.30
DVD Menu	.30
Moving to another TITLE	.30
Moving to another CHAPTER/TRACK	.30
Time Search	.31
Changing the Audio Language	.31
Changing the Audio Channel	.31
Subtitles	.31
Camera Angle	.31
Repeat A-B	.32
Repeat	.32
❑ Playing an Audio CD or MP3 Disc	.33-35
❑ Programmed Playback	.36-37
❑ Random Play	.38
❑ Viewing a JPEG Disc	.39-40
Initial Settings	
❑ Initial Settings	.41-46
General Operation	.41
LANGUAGE SET UP	.41
SCREEN SET UP	.42
AUDIO SET UP	.42-43
PARENTAL CONTROL	.44-45
CUSTOM SET UP	.46
Connections	
❑ Setting up the Player	.47-48
DVD Player Connections	.47
Audio Connection to Optional Equipment	.48
❑ To use the player with car battery adaptor	.49-50
Reference	
❑ Troubleshooting	.51
❑ Language Code List	.52
❑ Country Code List	.53
❑ Specifications	.54

Identification of Controls

Main Unit

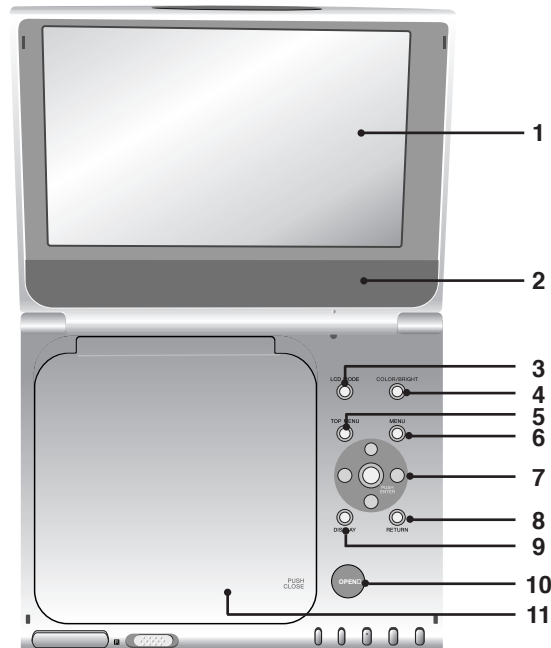

1. LCD screen
 2. Speaker
 3. LCD MODE (page 25)
 4. COLOR/BRIGHT (page 24)
Brightness → Color → OFF
 5. TOP MENU (page 30)
displays the title menu.
 6. MENU (page 30)
displays menu programs.
 7. ←/↑/↓/→ button, ENTER button
 8. RETURN button
 9. DISPLAY (page 28-29)
operation mode display.
 10. OPEN button (page 23)
Push this button to open the Disc lid.
 11. Disc Lid (page 23)
- NOTE:**
Place a disc with the playback side down on the spindle, and push gently on the center of the disc so it goes into position.

Identification of Controls (continued)

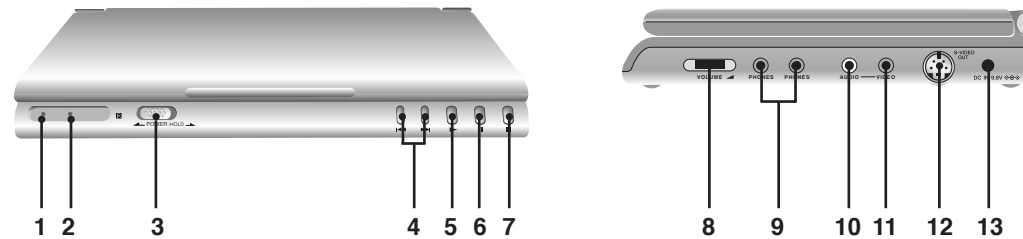

1. Power indicator (page 23)

POWER ON: Green ON
POWER OFF: Green OFF

2. CHARGE indicator (page 22)

During recharging: Orange ON

3. POWER and HOLD switch

To turn off the power, you need to press the POWER switch for at least one second. This is to prevent the player from being accidentally turned off.

HOLD switch

- The hold function locks the buttons on the DVD player so that they will not work if accidentally touched.
- To enable, slide the HOLD switch on the right side of the DVD player to the HOLD position.
- To disable, slide the switch back to its original position.

4. PREV/NEXT buttons (page 30)

5. PLAY button (page 23)

6. PAUSE button (page 27)

7. STOP button

8. VOLUME dial (page 23)

9. PHONES connector

10. AUDIO OUT connector (page 47)

11. VIDEO OUT connector (page 47)

12. S-VIDEO OUT connector (page 47)

13. DC IN 9.8V connector (page 20)

Connect the AC adaptor.

Identification of Controls (continued)

Remote Control

Inserting batteries into the remote

You can control the player using the supplied remote. Insert two size AA(R6) batteries (supplied) by matching the **+** and **-** ends on the batteries to the markings inside the compartment. When using the remote, point it at the remote sensor **R** on the player.

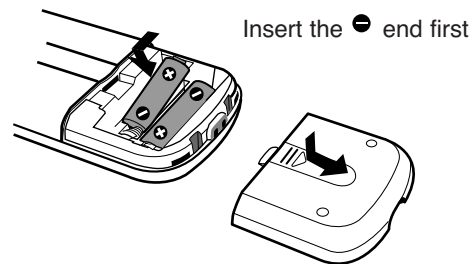

NOTES:

- Do not leave the remote in an extremely hot or humid place.
- Do not drop any foreign object into the remote casing, particularly when replacing the batteries.
- Do not expose the remote sensor to direct light from the sun or lighting apparatus. Doing so may cause a malfunction.
- If you do not use the remote for an extended period of time, remove the batteries to avoid possible damage from battery leakage and corrosion.

Identification of Controls (continued)

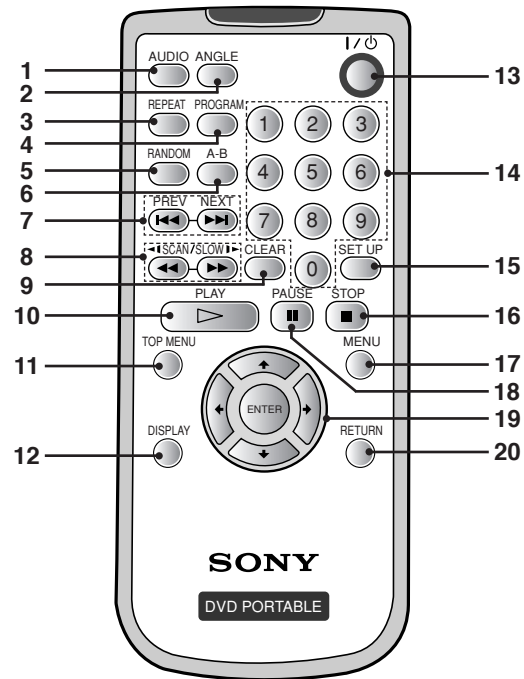

1. AUDIO button (page 31)
2. ANGLE button (page 31)
3. REPEAT button (page 32)
4. PROGRAM button (page 36-37)
5. RANDOM button (page 38)
6. A-B button (page 32)
7. PREVIOUS button (page 30)
8. SCAN/SLOW button (page 27)
9. CLEAR button
10. PLAY button
11. * TOP MENU button (page 30)
12. DISPLAY button (page 28-29)
13. POWER button
14. NUMBER buttons
15. SET UP button (page 41)

Identification of Controls (continued)

16. STOP button

17. MENU button

Use the MENU button to display the menu screen included on a DVD disc. To operate a menu screen, follow the instructions in "Using a DVD Menu" (page 30).

18. PAUSE button

19. ←/↑/▼/→ button, ENTER button

(up, down, left, right) for use in highlighting a selection on a GUI menu screen, TOP MENU and MENU screen.

20. RETURN button

* TOP MENU button:

Use the TOP MENU button to display the title screen included on DVD video discs. To operate a menu screen, follow the instructions in "Using a Title Menu" (page 30).

Power Connections

AC Adaptor

Follow steps 1 to 3 to connect.
When disconnecting, reverse the order.

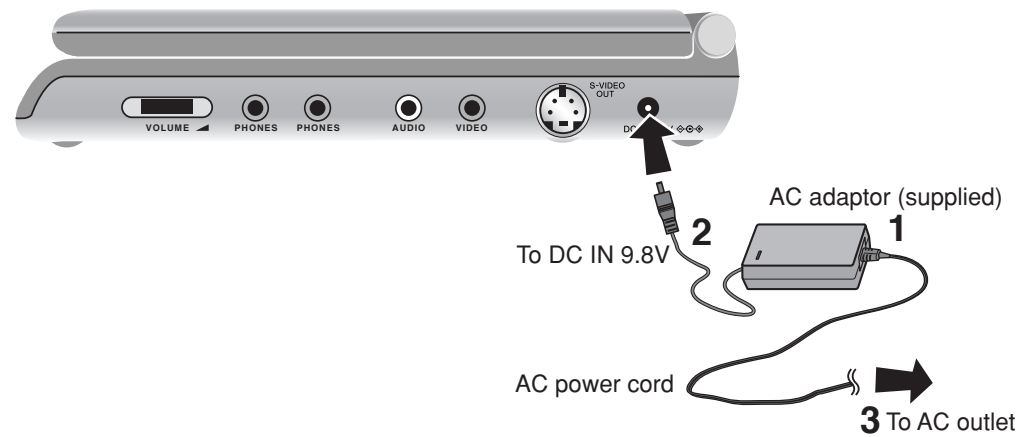

NOTES:

- When you disconnect the AC power cord, be sure to stop playback.
- Disconnecting the AC power cord during playback may cause a malfunction.

Power Connections (continued)

Battery Pack

You can use the NP-FX105 rechargeable battery pack (supplied) to enjoy the player when an AC outlet is not available.

- Charge the battery pack before using it for the first time.

■ Attaching the battery pack (supplied)

1. Match the hooks of the battery pack into the holes on the bottom of the player.
2. Press and slide the battery pack until the hooks click.

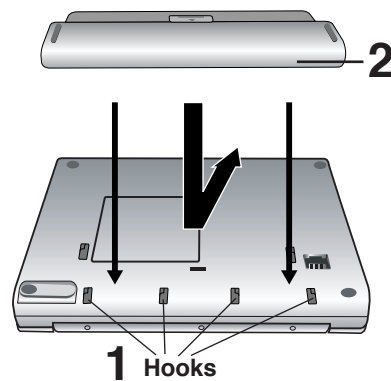

NOTES:

- Do not detach the battery pack during playback.
- Be careful not to drop the battery pack.

■ Detaching the battery pack

1. Press the **RELEASE** knob.
2. Slide the battery pack until the hooks click.

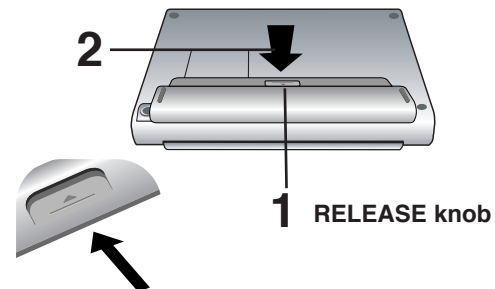

NOTE:

If you use the main unit without the battery pack, use the tab on the player to keep it from tipping over.

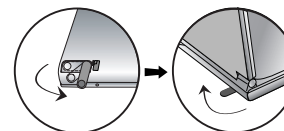

Power Connections (continued)

■ Charging the battery pack

1. Attach the battery pack to the player.
2. Connect the AC adaptor to the player and then plug into an AC outlet.

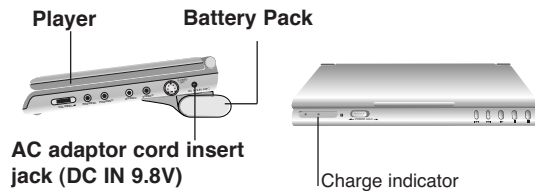

AC adaptor cord insert jack (DC IN 9.8V)

When charging starts, the charge indicator lights up in orange.

3. During recharging, the charge indicator lights up in orange. When recharging is complete, the indicator turns off.
4. Disconnect the AC adaptor from the player and pull out the plug from the AC outlet after charging.

- Confirm the battery charge on the LCD screen during stop or playback. When “” appears, the charge indicator flashes in orange. The battery mark does not appear during DVD or JPEG playback. To check the battery charge, stop playback

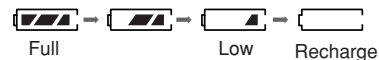

- If using the AC adaptor, battery display does not appear.

■ Recharging and play times

Recharging	Play time (DVD-VIDEO)
with player	LCD On
Approx. 4 hours	Approx. 3 hours*

- * When Brightness control is set to “”(minimum).
- using the headphones.
- at room temperature (25°C)

NOTES:

- Recharging times shown above depend on operating conditions.
- When the power is ON, you cannot charge the battery.
- Charge the battery at a temperature of +5°C (+41°F) to +35°C (+95°F). The charging time may vary, depending on the surrounding temperature.
- The battery will not be charged when it is naturally or purposely discharged. Because the unit cannot perceive battery voltage, even if you attached the battery. When you are in this situation, power on the unit and then power off again. Then battery charging will proceed.

Playing a Disc

Basic Playback

- Prepare the power supply.

1. Open the outer cover and slide the **POWER switch to the left to turn the unit on.**

The power indicator lights up in green.

2. Press **OPEN** to open the disc lid and insert a disc onto the side you want to play, label up. Close the disc lid by hand.

- If the disc is placed in upside down (and it is a single-sided disc), "NO DISC" or "Disc Error" appears on the LCD screen.

3. Press **PLAY** to start play.

- After playing back all of the chapters in the title, the DVD player automatically stops and returns to the menu screen.

4. Adjust the volume.

- Reduce the volume before playback, then gradually increase it.

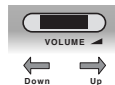

After operation

When the unit is not in use, remove the disc and slide the **POWER** switch to the left and hold it there to turn off the DVD player.

The power indicator turns off.

When a menu screen appears on the LCD screen.

DVD

In case of interactive DVDs with control, a menu screen appears on the LCD screen.

Press **←/↑/↓/→** and press **ENTER**, or press the number buttons, to select the desired item.

Playback of the selected item begins.

For further information, also refer to the jacket or case of the disc you are playing.

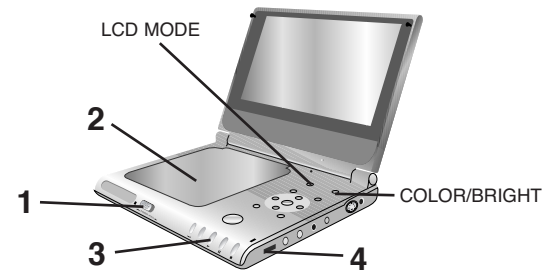

Playing a Disc (continued)

NOTES:

- Place a disc with the playback side down on the spindle, and push gently on the center of the disc so it goes into position.
- Confirm LCD MODE position by pressing LCD MODE button.
- If parental control is set and the disc is not within the rating settings you must input the password. (See "PARENTAL CONTROL" on page 44-45.)
- DVDs may have a region code. Your player does not play discs that have a region code different from your player.

Adjusting the brightness and color intensity

Use the COLOR/BRIGHT button to adjusting the brightness and color intensity.

Each time you press the button, the adjustment mode changes as follows.

Brightness → Color → OFF
↑

Adjusting the brightness

Select "Brightness" and then press ◀▶ to adjust the brightness.

- ◀ ; dark
- ▶ ; light

Adjusting color intensity

Select "Color" and then press ◀▶ to adjust the color intensity.

- ◀ ; darker colors
- ▶ ; lighter colors

NOTES:

- This COLOR/BRIGHT button adjusts only the image on the LCD screen.
- Power consumption increases with the level of brightness.

Playing a Disc (continued)

■ Changing the size of the picture

Use the LCD MODE button to change the picture mode.

DVD disc

NORMAL → FULL → ZOOM → LCD OFF



Audio CD/ MP3 disc/ JPEG disc (Menu)

FULL → LCD OFF



JPEG disc (Slide show)

NORMAL → FULL → LCD OFF



NOTES:

- The picture mode will appear differently for different kinds of discs.
- If you play back an image that was recorded in Widescreen (16:9) mode and “TV Aspect” in “SET UP” is set to “16:9 Wide”, then the LCD MODE button will only switch between FULL, ZOOM and LCD OFF.

■ The picture mode and size

The picture shown on the LCD depends on the display mode and the size recorded on the disc.

NOTES:

- If you are not using the LCD on this unit, select OFF to conserve power.
- The LCD is turned off if you close the unit.
- Horizontal lines may appear in the picture when the mode is switched to ZOOM, but this is not an indication of a malfunction.

Playing a Disc (continued)

Stopping Play

Press STOP during playback.

NOTE:

Do not touch the disc if it is still spinning when you open the lid.

Resume Play

When play is stopped, the unit records the point where STOP was pressed (RESUME function). Press PLAY and play will resume from this point.

NOTES:

- When you press the STOP button, RESUME ■ (stop) appears on the LCD screen and the player enters the resume mode.
- For MP3/JPEG data no information may be displayed depending upon the condition of the disc. .

Screen Saver

The screen saver appears when you leave the player in Stop mode for about 15 minutes. If the Screen Saver is displayed for 15 minutes, the Player automatically turns itself off.

Playing a Disc (continued)

Pause **DVD**

1. Press PAUSE during playback.
2. To exit still motion mode, press PLAY.

Search **DVD**

1. Press SCAN/SLOW ◀◀ or ▶▶ during playback.
The player will now go into SEARCH mode.
2. Press SCAN/SLOW ◀◀ or ▶▶ repeatedly to select the required speed: X2◀, 1◀◀, 2◀◀, 3◀◀ (backward) or X2▶, 1▶▶, 2▶▶, 3▶▶ (forward).
3. To exit SEARCH mode, press PLAY.

NOTE:

The DVD player does not play back sound during the high speed reverse and forward playback of DVD video discs.

Slow Motion **DVD**

1. Press PAUSE(⏸) during playback.
The player will now go into PAUSE mode.
2. Use the SCAN/SLOW ◀◀ or ▶▶ to select the required speed:
4◀, 3◀, 2◀, 1◀ (backward),
or 4▶, 3▶, 2▶, 1▶ (forward).
3. To exit slow motion mode, press PLAY.

On-Screen Display

You can display the general playback status on the screen. Some items can be changed using the menu. To use the on-screen display:

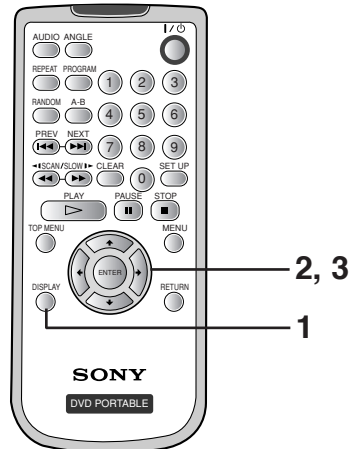



1. Press DISPLAY during playback.
2. Press \uparrow/\downarrow to select an item.
The selected item is highlighted.
3. Press \leftarrow/\rightarrow to change the setting. You can also use the number buttons if appropriate (e.g. inputting the title number).
For some functions, press ENTER to execute the setting.

NOTES:

- Some discs may not provide all of the features shown next page.
- If no button is pressed for 10 seconds, the on-screen display disappears.

On-Screen Display (continued)

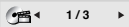
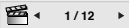
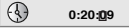
Example: On-Screen Display during playing of DVD Video

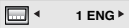
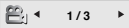
Items		Selection Method
Title Number		←/→, Numbers ENTER
Chapter Number		←/→, Numbers ENTER
Time search		Numbers, ENTER
Audio language and Digital Audio Output mode		←/→ or AUDIO
Subtitle language		←/→
Angle		←/→ or ANGLE

General Features

Title Menu **DVD**

Checking the contents of DVD discs: Menus DVDs may offer menus that allow you to access special features. To use the disc menu, press TOP MENU. Input the corresponding number or use the **←/↑/↓/→** buttons to highlight your selection. Then press ENTER.

DVD Menu **DVD**

1. Press MENU. If the current title has a menu, the menu appears on the screen. Otherwise, the disc menu may appear.
2. The menu offers features such as camera angles, spoken language and subtitle options, and chapters for the title.
Press **←/↑/↓/→** and ENTER, or press the numeric button(s), to select desired item.

Unless stated otherwise, all operations described use the remote control. Some features may also be available on the Setup menu.

Moving to another TITLE **DVD**

When a disc has more than one title, you can move to another title. Press DISPLAY while playback is stopped then the appropriate number (0-9) or use **←/→** to move to another title. You can play any title by inputting its number while playback is stopped.

Moving to another CHAPTER

DVD

When a title on a disc has more than one chapter, you can move to another chapter as follows:

- Press PREV/NEXT **⏪** or **⏩** briefly during playback to select the next chapter or to return to the beginning of the current chapter.
- Press PREV **⏪** twice briefly to step back to the previous chapter.
- To go directly to any chapter during DVD playback, press DISPLAY and press **↑/↓** to select the chapter icon. Then, input the chapter number or use **←/→**.

General Features (continued)

Time Search **DVD**

To start playing at any chosen time on the disc:

1. Press DISPLAY during playback. The time search box shows the elapsed playing time.
2. Press $\blacktriangle/\blacktriangledown$ to select the time clock icon and “-:-:-” appears.
3. Input the required start time in hours, minutes, and seconds from left to right. If you enter the wrong numbers, press CLEAR to remove the numbers you entered. Then input the correct numbers.
4. Press ENTER to confirm. Playback starts from the selected time.

NOTE:

The Time Search function may not be available on some DVD discs.

Changing the Audio Language **DVD**

Press AUDIO repeatedly during playback to hear a different audio language or audio track.

This operation works only with discs on which multiple audio soundtrack languages are recorded.

Subtitles **DVD**

It is possible to change the subtitle language to a different language from the one selected at the initial settings. (See page 41 for further info.)

This operation works only with discs on which multiple subtitle languages are recorded.

1. Press DISPLAY during playback.
2. Press $\blacktriangle/\blacktriangledown$ to select the subtitle item.
3. Press $\blacktriangle/\blacktriangledown$ repeatedly until the desired Subtitle is selected. Each time this button is pressed, the LCD screen display changes.

Camera Angle **DVD**

If the disc contains scenes recorded at different camera angles, you can change to a different camera angle during playback.

1. Press ANGLE during playback.
2. Press $\blacktriangle/\blacktriangledown$ repeatedly until the desired Angle is selected.

NOTE:

You cannot change the angle during slow playback.

TIP:

The angle indicator will blink on the screen during scenes recorded at different angles as an indication that angle switching is possible.

General Features (continued)

Repeat A-B **DVD**

To repeat a sequence.

1. Press A-B during playback at your chosen starting point. "A * " appears briefly on the screen.
2. Press A-B again at your chosen end point. "A B" appears briefly on the screen and the repeat sequence begins.
3. Press A-B again to cancel.

NOTE:

A-B repeat can only be used within a single title.

Repeat **DVD**

Each time this button is pressed, the LCD screen changes as shown below and the disc will repeat a chapter or title (DVD).

DVD Video Discs - Repeat Chapter/Title/Off

- Chapter : repeats the current chapter.
- Title : repeats the current title.
- Off : does not play repeatedly.

NOTES:

- If you press NEXT (▶▶) once during Repeat Chapter playback, the repeat playback cancels.
- Repeat play may not work correctly with some DVDs .

Playing an Audio CD or MP3 Disc

This player can play MP3 formatted recordings on CD-ROM, CD-R, or CD-RW discs.

Audio CD

Once you insert an audio CD a menu appears on the screen. Press $\blacktriangle/\blacktriangledown$ to select a track then press PLAY or ENTER and playback starts.



MP3

1. Press $\blacktriangle/\blacktriangledown$ to select a folder, and press ENTER to see the folder contents.
2. Press $\blacktriangle/\blacktriangledown$ to select a track then press PLAY or ENTER. Playback starts.



ID3 TAG (Version 1)

- When playing a file containing information such as track titles, you can see the information by pressing DISPLAY.
[Title, Artist, Album, Year, Comment]
- If there is no information, “No ID3 TAG” appears on the display.

TIPS:

- If you are in a file list on the AUDIO menu and want to return to the Folder list, use the $\blacktriangle/\blacktriangledown$ to highlight  and press ENTER.
- Press MENU to move to the next page.
- On a CD with MP3 and JPEG you can switch MP3 and JPEG. Press TOP MENU and AUDIO or IMAGE word on top of the menu is highlighted.

Playing an Audio CD or MP3 Disc (continued)

Audio CD and MP3 Disc Features

Pause **CD** **MP3**

1. Press PAUSE during playback.
2. To return to playback, press PLAY, ENTER or press PAUSE again.

Moving to another Track **CD** **MP3**

1. Press PREV/NEXT (◀◀ or ▶▶) briefly during playback to go to the next track or to return to the beginning of the current track.
2. Press PREV ◀◀ twice briefly to go back to the previous track.
3. You can play any track by inputting its number.

Search **CD** **MP3**

1. Press SCAN/SLOW (◀◀ or ▶▶) during playback. The player will now go into SEARCH mode.
2. Press SCAN/SLOW (◀◀ or ▶▶) repeatedly to select the required speed: 1◀◀, 2◀◀, 3◀◀ (backward) or 1▶▶, 2▶▶, 3▶▶ (forward). Search speed and direction are indicated on the menu screen.
3. To exit SEARCH mode, press PLAY.

Repeat Track/All/Off **CD** **MP3**

You can play a track/all on a disc.

1. Press REPEAT when playing a disc. The repeat icon appears.
2. Press REPEAT to select a desired repeat mode.
 - Track : repeats the current track
 - All : CD: repeats all the tracks on a disc.
MP3 : repeats all the tracks in a folder.
 - Off(No display) : does not play repeatedly.

NOTE:

If you press NEXT (▶▶) once during Repeat Track playback, the repeat playback cancels.

Repeat A-B **CD**

1. To repeat a sequence during disc playback, press A-B at your chosen starting point. The Repeat icon and "A" appear on the menu screen.
2. Press A-B again at your chosen end point. The Repeat icon and "A-B" appear on the menu screen, and the sequence begins to play repeatedly.
3. To exit the sequence and return to normal play, press A-B again. The Repeat icon disappears from the menu screen.

Playing an Audio CD or MP3 Disc (continued)

MP3 disc compatibility with this player is limited as follows:

- Sampling frequency: within 8 - 48 kHz (MP3)
- Bit rate: within 8 - 320kbps (MP3)
- The player cannot read an MP3 file that has a file extension other than “.mp3”.
- CD-R physical format should be ISO 9660.
- If you record MP3 files using software that cannot create a file system (eg. Direct-CD), it is impossible to playback MP3 files. We recommend that you use Easy-CD Creator, which creates an ISO 9660 file system.
- File names should have a maximum of 8 letters and must incorporate an .mp3 extension.
- They should not contain special letters such as / ? * : “ < > | etc.
- The total number of files on the disc should be about 600.

This DVD player requires discs and recordings to meet certain technical standards in order to achieve optimal playback quality. Pre-recorded DVDs are automatically set to these standards. There are many different types of recordable disc formats (including CD-R containing MP3 files) and these require certain pre-existing conditions (see above) to ensure compatible playback.

A Multi-session recording is not ensured.

Customers should note that permission is required in order to download MP3 files and music from the Internet. Our company has no right to grant such permission. Permission should always be sought from the copyright owner.

Programmed Playback

The program function enables you to store the playback order of your favorite tracks from any disc in the player memory.

A program can contain 30 tracks.

1. Insert a disc.

Audio CD or MP3 Discs:

AUDIO CD or AUDIO menu appears.

2. Press PROGRAM.

The  mark will appear to the right of the word "Program" on the right side of the menu screen.

NOTE:

Press PROGRAM. again, then the  mark will disappear to exit the Program Edit mode.

3. Select a track on the "List", then press ENTER to place the selected track on the "Program" list. Repeat to place additional tracks on the list.
4. Press .
Select the track you want to start playing on the "Program" list.
5. Press PLAY or ENTER to start. Playback begins in the order in which you programmed the tracks. Playback stops after all of the tracks on the "Program" list have played once.
6. To resume normal playback from programmed playback, select any track from the AUDIO list and then press PLAY.



Audio CD Menu



MP3 Menu

Programmed Playback (continued)

Repeat Programmed Tracks

1. Press REPEAT when playing a disc. The repeat icon appears.
2. Press REPEAT to select a desired repeat mode.
 - Track: repeats the current track
 - All: repeats all the tracks on programmed list.
 - Off(No display): does not play repeatedly.

NOTE:

If you press ►► once during Repeat Track playback, the repeat playback cancels.

Erasing a Track from Program List

1. Press PROGRAM.
2. Use ▲/▼/▶ to select the track that you wish to erase from the Program list.
3. Press CLEAR. Repeat to erase additional tracks on the list.

Erasing the Complete Program List

1. Press PROGRAM.
2. Press ▶ to move to the "Program" list.
3. Use ▲/▼ to select "Clear All", then press ENTER.

NOTE:

The programs are also cleared when the disc is removed.

Random Play

Random play (Karaoke DVD, CD, MP3)
You can playback titles or tracks in random order.
(Random playback)

NOTE:

Random does not work with DVD movie discs.

1. Press RANDOM during playback.
This player automatically starts random playback and the RANDOM indicator appears on the LCD screen.
2. To return to normal play.
Press RANDOM again.

NOTES:

- RANDOM playback may not be possible on certain discs.
- If you press the ►► or ◀◀ button during random playback, the DVD player goes to another track randomly and starts playback.

Viewing a JPEG Disc

Using this DVD Player you can view discs with JPEG files.

1. Insert a disc and close the tray.
The IMAGE menu appears on the screen.

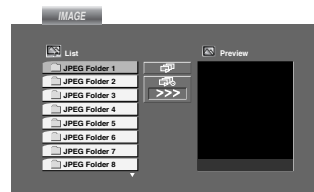

2. Press **▲/▼** to select a folder, and press ENTER.
A list of files in the folder appears. If you are in a file list and want to return to the previous Folder list, use the **▲/▼** buttons on the remote to highlight **⏪** and press ENTER.
3. If you want to view a particular file, press **▲/▼** to highlight a file and press ENTER or PLAY.
Viewing of the file starts.
While viewing a file, you can press STOP to move to the previous menu (IMAGE menu).

TIPS:

- Press MENU to move to the next page.
- There are three Slide Speed options **⏮** : >>> (Fast), >> (Normal), and > (Slow).
Use **◀/▶/⏮/⏭** to highlight the Speed. Then use **◀/▶** to select the option you want to use and press ENTER.
- On a disc with MP3 and JPEG you can switch MP3 and JPEG. Press TOP MENU and AUDIO or IMAGE word on top of the menu is highlighted.

Slide Show **JPEG**

Use **◀/▶/⏮/⏭** to highlight the **⏮** (Slide Show) then press ENTER.

Still Picture **JPEG**

1. Press PAUSE during slide show.
The player will now go into PAUSE mode.
2. To return to the slide show, press PLAY or press PAUSE again.

Viewing a JPEG Disc (continued)

Moving to another File **JPEG**

Press PREV/NEXT (◀◀ or ▶▶) or cursor (← or →) once while viewing a picture to advance to the next or previous file.

To rotate picture

Press ▲/▼ while showing a picture to rotate the picture clockwise or counterclockwise.

To listen to MP3 music while watching a picture

JPEG

You can display files while listening to MP3 music files recorded on the same disc.

1. Insert the disc containing the two types of files in the player.
2. Press TOP MENU to display IMAGE menu.
3. Press ▲/▼ to select a photo file.
4. Use → to select  icon then press ENTER. Playback starts. When the JPEG file display ends, MP3 playback will stop as well.

TIP:

To listen to only the desired music watching a picture, program the desired tracks from the "AUDIO" menu and then proceed as above.

JPEG disc compatibility with this player is limited as follows:

- Depending upon the size and number of JPEG files, it could take a long time for the DVD player to read the disc's contents. If you don't see an on-screen display after several minutes, some of the files may be too large — reduce the resolution of the JPEG files to less than 2M pixels as 2760 x 2048 pixels.
- The total number of files and folders on the disc should be about 600.
- Some discs may be incompatible due to a different recording format or the condition of disc.
- Ensure that all the selected files have the ".jpg" extensions when copying into the CD layout.
- If the files have ".jpe" or ".jpeg" extensions, please rename them as ".jpg" files.
- File names without ".jpg" extension will not be able to be read by this DVD player. Even though the files are shown as JPEG image files in Windows Explorer.

Initial Settings

By using the Setup menu, you can make various adjustments to items such as picture and sound. You can also set a language for the subtitles and the Setup menu, among other things. For details on each Setup menu item, see pages 41 to 46.

To display and exit the Menu:

Press SETUP to display the menu. A second press of SETUP will take you back to initial screen.

To go to the next level:

Press \blacktriangleright on the remote control.

To go back to the previous level:

Press \blacktriangleleft on the remote control.

General Operation

1. Press SETUP. The Setup menu appears.
2. Use $\blacktriangleup/\blacktriangledown$ to select the desired option then press \blacktriangleright to move to the second level. The screen shows the current setting for the selected item, as well as alternate setting(s).
3. Use $\blacktriangleup/\blacktriangledown$ to select the second desired option then press \blacktriangleright to move to the third level.
4. Use $\blacktriangleup/\blacktriangledown$ to select the desired setting then press ENTER to confirm your selection. Some items require additional steps.
5. Press SETUP or PLAY to exit the Setup menu.

LANGUAGE SET UP

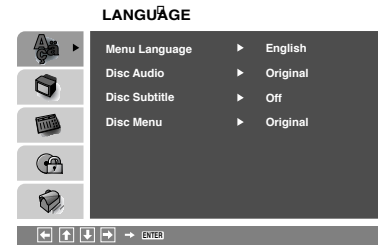

Menu Language

Select a language for the Setup menu and on-screen display.

Disc Audio / Subtitle / Menu **DVD**

Select the language you prefer for the audio track (disc audio), subtitles, and the disc menu.

Original: Refers to the original language in which the disc was recorded.

Other: To select another language, press number buttons then ENTER to enter the corresponding 4-digit number according to the language code list in the reference chapter. If you enter the wrong language code, press CLEAR.

(See "Language Code List", page53.)

Initial Settings (continued)

SCREEN SET UP

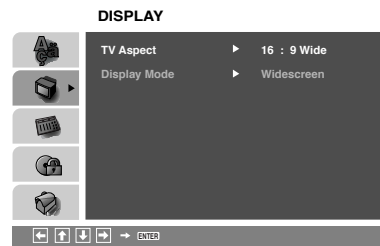

TV Aspect **DVD**

4:3: Select when a standard 4:3 TV is connected.

16:9 Wide: Select when a 16:9 wide TV is connected.

Display Mode **DVD**

Display Mode setting works only when the TV Aspect mode is set to "4:3".

LetterBox: Displays a wide picture with bands on the upper and lower portions of the screen.

Panscan: Automatically displays the wide picture on the entire screen and cuts off the portions that do not fit.

Initial Settings (continued)

AUDIO SET UP

Each DVD disc has a variety of audio output options. Set the player's AUDIO SET UP options according to the type of audio system you use.

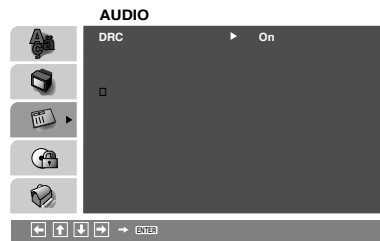

Dynamic Range Control (DRC) **DVD**

With the DVD format, you can hear a program's soundtrack in the most accurate and realistic presentation possible, thanks to digital audio technology. However, you may wish to compress the dynamic range of the audio output (the difference between the loudest sounds and the quietest ones). This allows you to listen to a movie at a lower volume without losing clarity of sound. Set DRC to On for this effect.

NOTE:

- The DRC function works only during playback of Dolby Digital recorded discs.
- The Level of Dynamic Range Compression may differ depending on the DVD disc.

Initial Settings (continued)

PARENTAL CONTROL

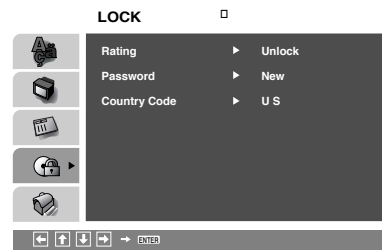

Rating **DVD**

Some movies contain scenes that may not be suitable for children to view. Many of these discs contain parental control information that applies to the complete disc or to certain scenes on the disc. Movies and scenes are rated from 1 to 8, depending on the country. Some discs offer more suitable scenes as an alternative.

The parental control feature allows you to block access to scenes below the rating you input, thereby preventing your children from being able to view material you believe is unsuitable.

1. Select "Rating" on the PARENTAL CONTROL menu then press ➔.

2. To access the Rating, Password, and Country Code features, you must input the 4-digit security code you created. If you have not yet entered a security code you are prompted to do so.

Input a 4-digit code and press ENTER. Enter it again and press ENTER to verify. If you make a mistake before pressing ENTER, press CLEAR.

3. Select a rating from 1 to 8 using the ⬆/⬇ buttons.

Rating 1-8: Rating one (1) has the most restrictions and rating eight (8) is the least restrictive.

Unlock

If you select unlock, parental control is not active and the disc plays in full.

NOTE:

If you set a rating for the player, all disc scenes with the same rating or higher are played. Lower rated scenes are not played unless alternate scenes are available on the disc. The alternatives must have the same or a higher rating. If no suitable alternative is found, playback stops. You must enter the 4-digit password or change the rating level in order to play the disc.

4. Press ENTER to confirm your rating selection, then press SETUP to exit the menu.

Initial Settings (continued)

Password (Security Code)

You can enter or change password.

1. Select Password on the PARENTAL CONTROL menu then press **➤**.
2. Follow step 2 as shown left (Rating). "Change" or "New" is highlighted.
3. Enter the new 4-digit code, then press ENTER. Input it again to verify.
4. Press SETUP to exit the menu.

If you forget your Security Code

If you forget your security code you can clear it using the following steps:

1. Open disc lid.
2. Press SETUP to display the Setup menu.
3. Input the 6-digit number "210499" and the security code is cleared.
4. Enter a new code as described above.

Country Code **DVD**

Enter the code of the country/area whose standards were used to rate the DVD video disc, based on the list in the reference chapter.
(See "Country Code List", page 54.)

1. Select "Country Code" on the PARENTAL CONTROL menu then press **➤**.
2. Follow step 2 as shown left (Rating).
3. Select the first character using **▲/▼** buttons.
4. Press ENTER and select the second character using **▲/▼** buttons.
5. Press ENTER to confirm your country code selection.

Initial Settings (continued)

CUSTOM SETUP

The BLACK LEVEL settings can be changed.

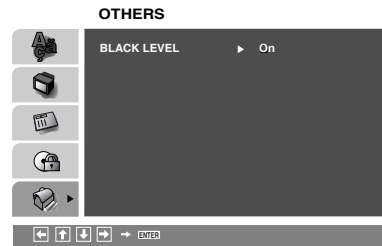

BLACK LEVEL

Selects the black level(setup level) for the video signals output from the jacks (Video output and S-video output) and LCD screen.

On: Sets the black level of the output signal to the standard level.

Off: Lowers the standard black level.
Use when the picture becomes too white.

Setting up the Player

The picture and sound of a nearby TV, VCR, or radio may be distorted during playback. If this occurs, position the player away from the TV, VCR, or radio, or turn off the unit after removing the disc.

DVD Player Connections

Depending on your TV and other equipment, there are various ways you can connect the player. Please refer to the manuals of your TV, stereo system, or other devices as necessary for additional connection information.

Video and Audio Connections to Your TV

Make sure the DVD player is connected directly to the TV and not to a VCR, otherwise the DVD image could be distorted by the copy protection system.

Video: Connect the VIDEO OUT jack on the DVD player to the VIDEO INPUT jack on the TV using the video cable.

S-Video: Connect the S-VIDEO OUT jack on the DVD Player to the S-VIDEO INPUT jack on the TV using the S-Video cable.

Audio Connection to Your TV:

Connect the AUDIO OUT jack of the DVD Player to the AUDIO L and R INPUT jacks on the TV using the audio cables. Do not connect the DVD Player's AUDIO OUT jack to the PHONES jack (record deck) of your audio system.

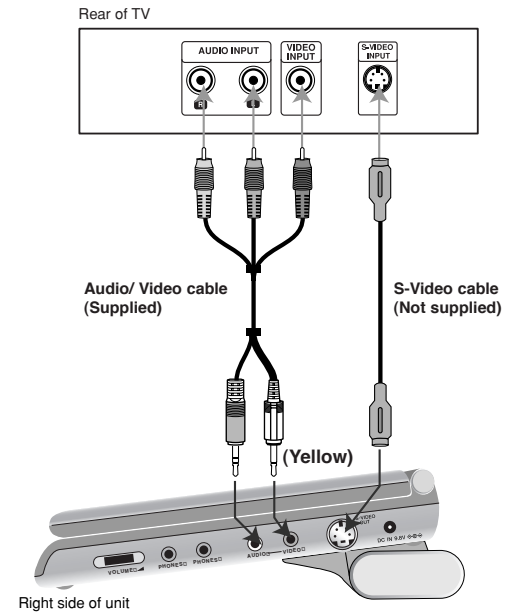

Connections

Setting up the Player (continued)

Audio Connection to Optional Equipment

Connect the DVD player to your optional equipment for audio output.

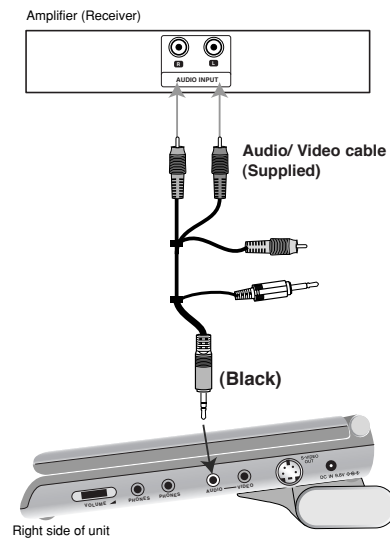

Amplifier equipped with 2-channel analog stereo or Dolby Pro Logic II / Pro Logic: Connect the AUDIO OUT jacks on the DVD player to the audio left and right IN jacks on your amplifier, receiver, or stereo system, using the audio cables.

NOTES:

To see the audio format of the current DVD in the on-screen display, press AUDIO.

To use the player with car battery adaptor

Connect the player to the cigarette lighter socket using the supplied car battery adaptor (DCC-FX105). This adaptor can only be used 12V electrical currents. It will not work with 24V electrical currents.

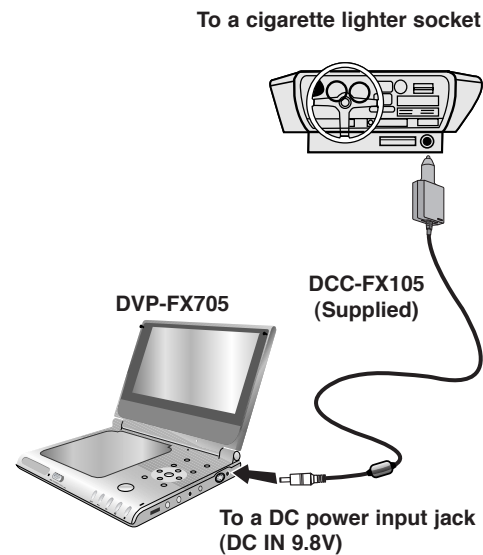

NOTES:

- Route the cords so that they will not interfere with driver.
- Turn off the player by Power switch. If you turn off the player by turning off the ignition key of the car when the rechargeable battery is not attached, the settings may be cleared.
- Do not install the monitor display where viewable by the driver.
- Some states restrict the use of monitors and televisions in vehicles. Where use is permitted, the units should not be installed or operated so as to be viewable by the driver.
- Keep this unit away from Sony DVP-FX705 if the picture is disturbed.

To use the player with car battery adaptor (continued)

Others

- Use this car battery adaptor only for cars which use a 12 volt battery.

Do not use this with a car that has a 24 volt battery.

- There are cars which are negatively grounded and there are others which are positively grounded.

This car battery adaptor is for negatively grounded cars only.

- Use the unit with the car engine running. If you use the unit with the car engine stopped, the car battery may become unusable.
 - This unit is not disconnected from the power source as long as it is connected to the cigarette lighter socket of a car.
 - Unplug the car battery cord from the cigarette lighter socket when not in use. To disconnect the cord, pull it out by the plug. Never pull the cord itself.
 - Do not operate the unit if it has been dropped or damaged.
 - Be sure that nothing metallic comes into contact with the metal parts of the unit. If it does, a short may occur and the unit may be damaged.
- Always keep the metal contacts clean.
 - If the car's cigarette lighter socket is dirty with ash, etc., the plug part will become hot due to a poor connection. Be sure to clean it before using.
 - Do not disassemble or convert the unit.
 - Do not apply mechanical shock or drop the unit.
 - Heat may build up while charging or during extended use. This is not a malfunction.
 - While listening to the car radio, keep the plug of the Car Battery Cord out of the cigarette lighter socket or keep the radio away from the unit to avoid static.
 - Avoid placing it where it would be subject to vibration.
 - Avoid leaving the unit where it would be subject to high temperatures, such as direct sunlight e.g. on the dashboard or hot air from the heater.

Troubleshooting

Symptom	Cause	Correction
No power.	• The power cord is disconnected.	• Plug the power cord into the wall outlet securely.
	• The battery is discharged.	• Recharge the battery.
No picture on the LCD or TV (including video from another unit).	• The video cable is not connected securely.	• Connect the video cable into the jacks securely.
	• LCD mode is set to OFF.	• Select an LCD mode other than OFF.
	• Check that Brightness control is set to "◀" (minimum).	• Adjust the brightness.
	• The TV is not set to receive DVD signal output.	• Select the appropriate video input mode on the TV so the picture from the DVD player appears on the screen.
No sound.	• The equipment connected with the audio cable is not set to receive DVD signal output.	• Select the correct input mode of the audio receiver so you can listen to the sound from the DVD player.
	• The audio cables are not connected securely.	• Connect the audio cable into the jacks securely.
The DVD player does not start playback.	• An unplayable disc is inserted.	• Insert a playable disc. (Check the disc type, color system, and Regional code.)
	• The Rating level is set.	• Cancel the Rating function or change the rating level.
No response when buttons are pressed.	• Some discs prohibit certain operations.	• "⊘" may appear on the screen during operation.
The remote control does not work properly.	• The remote control is too far from the DVD player.	• Point the remote at the remote sensor and operate it within close proximity of the player.
	• Direct sunlight or light from a fluorescent light source is hitting the remote sensor.	• Move the player away from direct sunlight or the fluorescent light source.
	• The battery are weak.	• Replace all batteries in the remote with new ones.
	• The signals are not reaching the player.	• Remove any obstacles between the remote and the player.

Language Code List

Use this list to input your desired language for the following initial settings:
Disc Audio, Disc Subtitle, Disc Menu.

Language	Code	Language	Code	Language	Code	Language	Code
Abkhazian	6566	Fiji	7074	Lingala	7678	Singhalese	8373
Afar	6565	Finnish	7073	Lithuanian	7684	Slovak	8375
Afrikaans	6570	French	7082	Macedonian	7775	Slovenian	8376
Albanian	8381	Frisian	7089	Malagasy	7771	Somali	8379
Ameharic	6577	Galician	7176	Malay	7783	Spanish	6983
Arabic	6582	Georgian	7565	Malayalam	7776	Sudanese	8385
Armenian	7289	German	6869	Maltese	7784	Swahili	8387
Assamese	6583	Greek	6976	Maori	7773	Swedish	8386
Aymara	6588	Greenlandic	7576	Marathi	7782	Tagalog	8476
Azerbaijani	6590	Guarani	7178	Moldavian	7779	Tajik	8471
Bashkir	6665	Gujarati	7185	Mongolian	7778	Tamil	8465
Basque	6985	Hausa	7265	Nauru	7865	Tatar	8484
Bengali; Bangla	6678	Hebrew	7387	Nepali	7869	Telugu	8469
Bhutani	6890	Hindi	7273	Norwegian	7879	Thai	8472
Bihari	6672	Hungarian	7285	Oriya	7982	Tibetan	6679
Breton	6682	Icelandic	7383	Panjabi	8065	Tigrinya	8473
Bulgarian	6671	Indonesian	7378	Pashto, Pushto	8083	Tonga	8479
Burmese	7789	Interlingua	7365	Persian	7065	Turkish	8482
Byelorussian	6669	Irish	7165	Polish	8076	Turkmen	8475
Cambodian	7577	Italian	7384	Portuguese	8084	Twi	8487
Catalan	6765	Japanese	7465	Quechua	8185	Ukrainian	8575
Chinese	9072	Javanese	7487	Rhaeto-Romance	8277	Urdu	8582
Corsican	6779	Kannada	7578	Romanian	8279	Uzbek	8590
Croatian	7282	Kashmiri	7583	Russian	8285	Vietnamese	8673
Czech	6783	Kazakh	7575	Samoan	8377	Volapük	8679
Danish	6865	Kirghiz	7589	Sanskrit	8365	Welsh	6789
Dutch	7876	Korean	7579	Scots Gaelic	7168	Wolof	8779
English	6978	Kurdish	7585	Serbian	8382	Xhosa	8872
Esperanto	6979	Laothian	7679	Serbo-Croatian	8372	Yiddish	7473
Estonian	6984	Latin	7665	Shona	8378	Yoruba	8979
Faroese	7079	Latvian, Lettish	7686	Sindhi	8368	Zulu	9085

Country Code List

Choose a country code from this list.

Country	Code	Country	Code	Country	Code	Country	Code
Afghanistan	AF	Ethiopia	ET	Malaysia	MY	Saudi Arabia	SA
Argentina	AR	Fiji	FJ	Maldives	MV	Senegal	SN
Australia	AU	Finland	FI	Mexico	MX	Singapore	SG
Austria	AT	France	FR	Monaco	MC	Slovak Republic	SK
Belgium	BE	Germany	DE	Mongolia	MN	Slovenia	SI
Bhutan	BT	Great Britain	GB	Morocco	MA	South Africa	ZA
Bolivia	BO	Greece	GR	Nepal	NP	South Korea	KR
Brazil	BR	Greenland	GL	Netherlands	NL	Spain	ES
Cambodia	KH	Islands	HM	Netherlands Antilles	AN	Sri Lanka	LK
Canada	CA	Hungary	HU	New Zealand	NZ	Sweden	SE
Chile	CL	India	IN	Nigeria	NG	Switzerland	CH
China	CN	Indonesia	ID	Norway	NO	Thailand	TH
Colombia	CO	Israel	IL	Oman	OM	Turkey	TR
Congo	CG	Italy	IT	Pakistan	PK	Uganda	UG
Costa Rica	CR	Jamaica	JM	Panama	PA	Ukraine	UA
Croatia	HR	Japan	JP	Paraguay	PY	United States	US
Czech Republic	CZ	Kenya	KE	Philippines	PH	Uruguay	UY
Denmark	DK	Kuwait	KW	Poland	PL	Uzbekistan	UZ
Ecuador	EC	Libya	LY	Portugal	PT	Vietnam	VN
Egypt	EG	Luxembourg	LU	Romania	RO	Zimbabwe	ZW
El Salvador	SV			Russian Federation	RU		

Reference

Specifications

DVD Player

Power supply:

DC 9.8V (AC adaptor/ Car Battery Adaptor terminal),
DC 7.6V (Battery)

Power consumption: 13W

(DVD VIDEO Playback with the LCD screen turned on.)

Weight: 1.536 lbs (697g) (without battery pack)

External dimensions (W x H x D):

7.48 x 6.1 x 1.3 inches (190 x 155 x 32.8 mm)

Signal system: NTSC

Laser:

DVD Laser wavelength 662+25 / 662-15 nm

CD Laser wavelength 785+25 / 785-15 nm

Frequency range (audio):

DVD linear sound: 48kHz sampling 8 Hz to 20 kHz

96kHz sampling 8 Hz to 44 kHz

Signal-to-noise ratio (audio): More than 95 dB

Dynamic range (audio): More than 95 dB

Harmonic distortion (audio): 0.008 %

Operating conditions:

Temperature: 41°F to 95°F, Operation status: Horizontal

Connectors

Video output (VIDEO Out):

1.0 V (p-p), 75 Ω, negative sync., ø3.5mm mini jack x 1

Audio output (AUDIO Out, analog audio):

2.0 Vrms(1 KHz, 0 dB), ø3.5mm mini jack x 1

Earphone terminal: ø3.5mm stereo mini jack x 2

Liquid Crystal Display

Panel size: 7 inches wide (diagonal)

Projection system: R.G.B

Driving system: TFT active matrix

Resolution: 480 x 234

(effective pixel rate: more than 99.99%)

Supplied Accessories

- RCA Audio/Video cable 1
- AC Adaptor (AC-FX105) 1
- AC Power Cord 1
- Car Battery Adaptor (DCC-FX105) 1
- Battery Pack (NP-FX105) 1
- Remote control (RMT-D163A) 1
- Battery for Remote control (Size : AA(R6)) 1

- **Design and specifications are subject to change without notice.**

Sony Corporation Printed in China

<http://www.sony.net/>

Free Manuals Download Website

<http://myh66.com>

<http://usermanuals.us>

<http://www.somanuals.com>

<http://www.4manuals.cc>

<http://www.manual-lib.com>

<http://www.404manual.com>

<http://www.luxmanual.com>

<http://aubethermostatmanual.com>

Golf course search by state

<http://golfingnear.com>

Email search by domain

<http://emailbydomain.com>

Auto manuals search

<http://auto.somanuals.com>

TV manuals search

<http://tv.somanuals.com>