

# CD/DVD Player

## Operating Instructions

### For customers in the U.S.A Owner's Record

The model and serial numbers are located at the rear of the unit. Record the serial number in the space provided below. Refer to them whenever you call upon your Sony dealer regarding this product.

Model No. DVP-NC665P

Serial No. \_\_\_\_\_

### For Customers in Canada

If this product is not working properly, please call 1-877-602-2008 for **Peace of Mind Warranty Replacement service.**

For other product related questions please contact our **Customer Information Service Centre** at 1-877-899-7669 or write to us at: Customer Information Service 115 Gordon Baker Road, Toronto, Ontario, M2H 3R6



## DVP-NC665P

© 2003 Sony Corporation

# WARNING

To prevent fire or shock hazard, do not expose the unit to rain or moisture. To avoid electrical shock, do not open the cabinet. Refer servicing to qualified personnel only.

## CAUTION

The use of optical instruments with this product will increase eye hazard. As the laser beam used in this CD/DVD player is harmful to eyes, do not attempt to disassemble the cabinet.

Refer servicing to qualified personnel only.

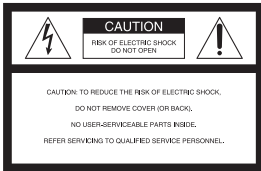

This symbol is intended to alert the user to the presence of uninsulated “dangerous voltage”

within the product’s enclosure that may be of sufficient magnitude to constitute a risk of electric shock to persons.



This symbol is intended to alert the user to the presence of important operating and

maintenance (servicing) instructions in the literature accompanying the appliance.

## CAUTION :

TO PREVENT ELECTRIC SHOCK, MATCH WIDE BLADE OF PLUG TO WIDE SLOT, FULLY INSERT.

## CAUTION

You are cautioned that any change or modifications not expressly approved in this manual could void your authority to operate this equipment.

## Note

This equipment has been tested and found to comply with the limits for a Class B digital device, pursuant to Part 15 of the FCC Rules. These limits are designed to provide reasonable protection against harmful interference in a residential installation. This equipment generates, uses, and can radiate radio frequency energy and, if not installed and used in accordance with the instructions, may cause harmful interference to radio communications. However, there is no guarantee that interference will not occur in a particular installation. If this equipment does cause harmful interference to radio or television reception, which can be determined by turning the equipment off and on, the user is encouraged to try to correct the interference by one or more of the following measures:

- Reorient or relocate the receiving antenna.
- Increase the separation between the equipment and receiver.
- Connect the equipment into an outlet on a circuit different from that to which the receiver is connected.
- Consult the dealer or an experienced radio/TV technician for help.

# Welcome!

Thank you for purchasing this Sony CD/DVD Player. Before operating this player, please read this manual thoroughly and retain it for future reference.

# Precautions

## On safety

- Caution – The use of optical instruments with this product will increase eye hazard.
- To prevent fire or shock hazard, do not place objects filled with liquids, such as vases, on the apparatus.
- Should any solid object or liquid fall into the cabinet, unplug the player and have it checked by qualified personnel before operating it any further.

## On power sources

- The player is not disconnected from the AC power source as long as it is connected to the wall outlet, even if the player itself has been turned off.
- If you are not going to use the player for a long time, be sure to disconnect the player from the wall outlet. To disconnect the AC power cord, grasp the plug itself; never pull the cord.

## On placement

- Place the player in a location with adequate ventilation to prevent heat build-up in the player.
- Do not place the player on a soft surface such as a rug that might block the ventilation holes.
- Do not place the player in a location near heat sources, or in a place subject to direct sunlight, excessive dust, or mechanical shock.
- Do not install the player in an inclined position. It is designed to be operated in a horizontal position only.
- Do not place heavy objects on the player.

## On operation

- If the player is brought directly from a cold to a warm location, or is placed in a very damp room, moisture may condense on the lenses inside the player. Should this occur, the player may not operate properly. In this case, remove the disc and leave the player turned on for about half an hour until the moisture evaporates.
- When you move the player, take out any discs. If you don't, the disc may be damaged.

## On adjusting volume

Do not turn up the volume while listening to a section with very low level inputs or no audio signals. If you do, the speakers may be damaged when a peak level section is played.

## On cleaning

Clean the cabinet, panel, and controls with a soft cloth slightly moistened with a mild detergent solution. Do not use any type of abrasive pad, scouring powder or solvent such as alcohol or benzine.

## On cleaning discs



Do not use a commercially available cleaning disc. It may cause a malfunction.

### IMPORTANT NOTICE

Caution: This player is capable of holding a still video image or on-screen display image on your television screen indefinitely. If you leave the still video image or on-screen display image displayed on your TV for an extended period of time you risk permanent damage to your television screen. Plasma Display Panel television and projection televisions are especially susceptible to this.

## On transporting the player

Before transporting the player, follow the procedure below to return the internal mechanisms to their original positions.

- 1 Remove all the discs from the disc tray.
- 2 Press  to close the disc tray. Make sure that "NO DISC" appears on the front panel display.
- 3 Press  to turn off the player. The player enters standby mode.
- 4 Disconnect the AC power cord.

If you have any questions or problems concerning your player, please consult your nearest Sony dealer.

# Table of Contents

WARNING .....	2
Welcome! .....	2
Precautions .....	3
About this Manual .....	6
This Player Can Play the Following Discs .....	6
Notes about the Discs .....	7
Index to Parts and Controls .....	8
Guide to the Control Menu Display .....	12
<hr/>	
<b>Hookups .....</b>	<b>15</b>
Hooking Up the Player .....	15
Step 1: Unpacking .....	15
Step 2: Inserting Batteries into the Remote .....	15
Step 3: Connecting the Video Cords .....	16
Step 4: Connecting the Audio Cords .....	19
Step 5: Connecting the Power Cord .....	24
Step 6: Quick Setup .....	24
<hr/>	
<b>Playing Discs .....</b>	<b>27</b>
Playing Discs .....	27
Resuming Playback from the Point Where You Stopped the Disc (Resume Play/Multi-disc Resume) .....	30
Using the DVD's Menu .....	31
Selecting "ORIGINAL" or "PLAY LIST" on a DVD-RW Disc .....	31
Playing VIDEO CDs with PBC Functions (PBC Playback) .....	32
Playing an MP3 Audio Track .....	33
Various Play Mode Functions (Program Play, Shuffle Play, Repeat Play, A-B Repeat Play) .....	36
<hr/>	
<b>Searching for a Scene .....</b>	<b>41</b>
Searching for a Particular Point on a Disc (Scan, Slow-motion Play, Search, Freeze Frame) .....	41
Searching for a Title/Chapter/Track/Scene, etc. ....	42
Searching by Scene (PICTURE NAVIGATION) .....	44
<hr/>	
<b>Viewing Information About the Disc .....</b>	<b>45</b>
Checking the Playing Time and Remaining Time .....	45
Checking the Play Information .....	47
<hr/>	
<b>Sound Adjustments .....</b>	<b>49</b>
Changing the Sound .....	49
TV Virtual Surround Settings (TVS) .....	51

---

<b>Enjoying Movies</b> .....	<b>53</b>
Changing the Angles .....	53
Displaying the Subtitles .....	53
Adjusting the Picture Quality (BNR) .....	54
Adjusting the Playback Picture (CUSTOM PICTURE MODE) .....	55
Enhancing the Playback Picture (DIGITAL VIDEO ENHANCER) .....	56

---

<b>Using Various Additional Functions</b> .....	<b>58</b>
Locking Discs (CUSTOM PARENTAL CONTROL, PARENTAL CONTROL) .....	58
Controlling Your TV with the Supplied Remote .....	62

---





<b>Settings and Adjustments</b> .....	<b>63</b>
Using the Setup Display .....	63
Setting the Display or Sound Track Language (LANGUAGE SETUP) .....	64
Settings for the Display (SCREEN SETUP) .....	65
Custom Settings (CUSTOM SETUP) .....	66
Settings for the Sound (AUDIO SETUP) .....	67

---

<b>Additional Information</b> .....	<b>69</b>
Troubleshooting .....	69
Self-diagnosis Function (When letters/numbers appear in the display) .....	71
Glossary .....	72
Specifications .....	74
Language Code List .....	75
Index .....	76





## About this Manual

- Instructions in this manual describe the controls on the remote. You can also use the controls on the player if they have the same or similar names as those on the remote.
- “DVD” may be used as a general term for DVD VIDEOS, DVD-RWs, DVD-Rs and DVD+RWs/DVD+Rs.
- The meaning of the icons used in this manual is described below:

Icon	Meaning
	Functions available for DVD VIDEOS and DVD-RWs/ DVD-Rs in video mode or DVD+RWs/DVD+Rs
	Functions available for DVD-RWs in VR (Video Recording) mode
	Functions available for VIDEO CDs, Super VCDs or CD-Rs/ CD-RWs in video CD format or Super VCD format
	Functions available for DATA CDs (CD-ROMs/CD-Rs/CD-RWs containing MP3* audio tracks)
	Functions available for music CDs or CD-Rs/CD-RWs in music CD format

\* MP3 (MPEG1 Audio Layer 3) is a standard format defined by ISO (International Standard Organization)/MPEG which compresses audio data.

## This Player Can Play the Following Discs

Format of discs	
DVD VIDEO (page 72)	
DVD-RW (page 72)	
VIDEO CD	
Music CD	

“DVD VIDEO” and “DVD-RW” are trademarks.

### Region code

Your player has a region code printed on the back of the unit and only will play DVD VIDEO discs (playback only) labeled with identical region codes. This system is used to protect copyrights.

DVD VIDEOS labeled  will also play on this player.

If you try to play any other DVD VIDEO, the message “Playback prohibited by area limitations.” will appear on the TV screen. Depending on the DVD VIDEO, no region code indication may be labeled even though playing the DVD VIDEO is prohibited by area restrictions.



### Example of discs that the player cannot play

- The player cannot play the following discs:
- All CD-ROMs (including PHOTO CDs)/ CD-Rs/CD-RWs other than those recorded in the following formats:
    - music CD format
    - video CD format

–MP3 format that conforms to ISO9660\*  
Level 1/Level 2, or its extended format,  
Joliet

- Data part of CD-Extras
- DVD-ROMs
- DVD Audio discs
- HD layer on Super Audio CDs

\* A logical format of files and folders on CD-ROMs defined by ISO (International Standard Organization).

Also, the player cannot play the following discs:

- A DVD VIDEO with a different region code.
- A disc recorded in a color system other than NTSC, such as PAL or SECAM (this player conforms to the NTSC color system).
- A disc that has a non-standard shape (e.g., card, heart).
- A disc with paper or stickers on it.
- A disc that has the adhesive of cellophane tape or a sticker still left on it.

## Notes

### • Notes about DVD-RWs/DVD-Rs, DVD+RWs/DVD+Rs or CD-Rs/CD-RWs

Some DVD-RWs/DVD-Rs, DVD+RWs/DVD+Rs, or CD-Rs/CD-RWs cannot be played on this player due to the recording quality or physical condition of the disc, or the characteristics of the recording device and authoring software.

The disc will not play if it has not been correctly finalized. Also, images in DVD-RW discs with CPRM\* protection may not be played if they contain a copy protection signal. "Copyright lock" appears on the screen. For more information, see the operating instructions for the recording device.

Note that discs created in the Packet Write format cannot be played.

\* CPRM (Content Protection for Recordable Media) is a coding technology that protects copyright for images.

### • Music discs encoded with copyright protection technologies

This product is designed to playback discs that conform to the Compact Disc (CD) standard. Recently, various music discs encoded with copyright protection technologies are marketed by some record companies. Please be aware that among those discs, there are some that do not conform to the CD standard and may not be playable by this product.

## Note on playback operations of DVDs and VIDEO CDs

Some playback operations of DVDs and VIDEO CDs may be intentionally set by software producers. Since this player plays DVDs and VIDEO CDs according to the disc contents the software producers designed, some playback features may not be available. Also, refer to the instructions supplied with the DVDs or VIDEO CDs.

## Copyrights

This product incorporates copyright protection technology that is protected by method claims of certain U.S. patents, other intellectual property rights owned by Macrovision Corporation, and other rights owners. Use of this copyright protection technology must be authorized by Macrovision Corporation, and is intended for home and other limited viewing uses only unless otherwise authorized by Macrovision Corporation. Reverse engineering or disassembly is prohibited.

## Notes about the Discs

- To keep the disc clean, handle the disc by its edge. Do not touch the surface.



- Do not expose the disc to direct sunlight or heat sources such as hot air ducts, or leave it in a car parked in direct sunlight as the temperature may rise considerably inside the car.
- After playing, store the disc in its case.
- Clean the disc with a cleaning cloth. Wipe the disc from the center out.



- Do not use solvents such as benzene, thinner, commercially available cleaners, or anti-static spray intended for vinyl LPs.

# Index to Parts and Controls

For more information, refer to the pages indicated in parentheses.

## Front panel

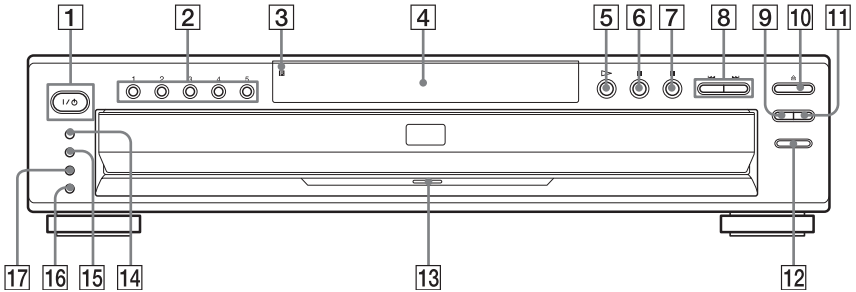

- 1** (on/standby) button (27)
- 2** DISC SELECT 1 – 5 buttons (28)
- 3** (remote sensor) (15)
- 4** Front panel display (9)
- 5** (playback) button (27)  
The button has a tactile dot.\*
- 6** (pause) button (28)
- 7** (stop) button (28)
- 8** (previous/next) buttons (28)
- 9** EXCHANGE button (29)

- 10** (open/close) button (27)
- 11** DISC SKIP button (27)
- 12** PROGRESSIVE button (18, 24)
- 13** PROGRESSIVE indicator (18)
- 14** PICTURE MODE button (55)
- 15** SURROUND button (51)
- 16** ONE/ALL button (36)
- 17** LOAD button (28)

\* Use the tactile dot as a reference when operating the player.



# Front panel display

## When playing back a DVD VIDEO/DVD-RW

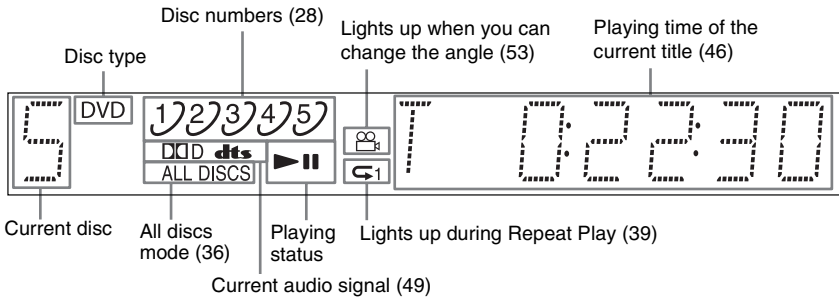

## When playing back a VIDEO CD with Playback Control (PBC) (32)

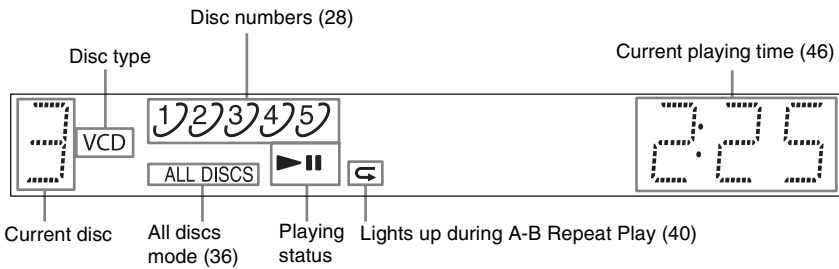

## When playing back a CD, DATA CD (MP3 audio), or VIDEO CD (without PBC)

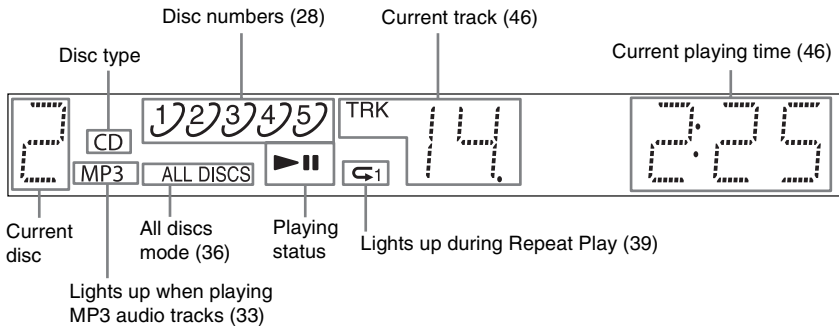

## Rear panel

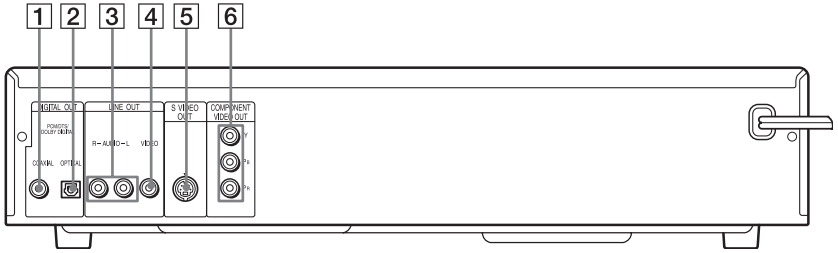

- 1** DIGITAL OUT (COAXIAL) jack (21)  
(22) (23)
- 2** DIGITAL OUT (OPTICAL) jack (21)  
(22) (23)
- 3** LINE OUT L/R (AUDIO) jack (20)  
(21) (22)
- 4** LINE OUT (VIDEO) jack (16)
- 5** S VIDEO OUT jack (16)
- 6** COMPONENT VIDEO OUT (Y, PB,  
PR) jacks (16)

# Remote

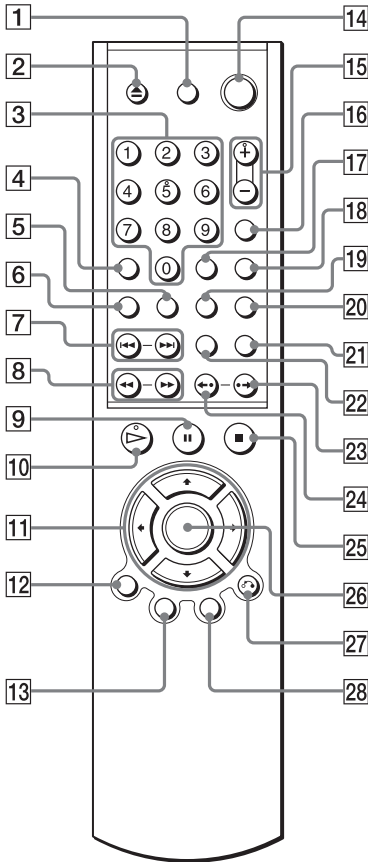

- 1** TV  $\mathbb{I}/\mathbb{O}$  (on/standby) button (62)
- 2**  $\blacktriangle$  OPEN/CLOSE button (27)
- 3** Number buttons (31)  
The number 5 button has a tactile dot.\*
- 4** CLEAR button (36)
- 5** SUBTITLE button (53)
- 6** AUDIO button (49)
- 7**  $\mathbb{I}\mathbb{I}\mathbb{I}\mathbb{I}$  /  $\mathbb{I}\mathbb{I}\mathbb{I}\mathbb{I}$  PREV (previous) /NEXT buttons (28)
- 8**  $\mathbb{I}\mathbb{I}$  /  $\mathbb{I}\mathbb{I}$  /  $\mathbb{I}\mathbb{I}$  /  $\mathbb{I}\mathbb{I}$  SCAN/SLOW buttons (41)
- 9**  $\mathbb{I}\mathbb{I}$  PAUSE button (28)
- 10**  $\mathbb{I}$  PLAY button (27)  
The  $\mathbb{I}$  button has a tactile dot.\*
- 11**  $\mathbb{I}$  /  $\mathbb{I}$  /  $\mathbb{I}$  /  $\mathbb{I}$  buttons (31)
- 12** DISPLAY button (12)
- 13** TOP MENU button (31)
- 14**  $\mathbb{I}/\mathbb{O}$  (on/standby) button (27)
- 15** VOL (volume) +/- buttons (62)  
The + button has a tactile dot.\*
- 16** TV/VIDEO button (62)
- 17** TIME/TEXT button (45)
- 18** DISC SKIP button (27)
- 19** ANGLE button (53)
- 20** SUR (surround) button (51)
- 21** PICTURE NAVI (picture navigation) button (44)
- 22** REPEAT button (39)
- 23**  $\bullet \rightarrow$  /  $\mathbb{I}\mathbb{I}$   $\rightarrow$  INSTANT SEARCH/STEP button (28, 41)
- 24**  $\leftarrow$  /  $\bullet$  /  $\mathbb{I}\mathbb{I}$   $\leftarrow$  INSTANT REPLAY/STEP button (28, 41)
- 25**  $\blacksquare$  STOP button (28)
- 26** ENTER button (24)
- 27**  $\hookrightarrow$  RETURN button (29)
- 28** MENU button (31) (33)

\* Use the tactile dot as a reference when operating the player.

# Guide to the Control Menu Display

Use the Control Menu to select a function and to view related information. Press DISPLAY repeatedly to turn on or change the Control Menu display as follows:

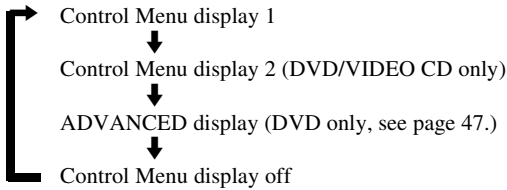

## Hint

You can skip the ADVANCED display by setting "OFF" under "ADVANCED" in the Control Menu (page 47).

## Control Menu

The Control Menu display 1 and 2 will show different items depending on the disc type. For details, please refer to the pages in parentheses.



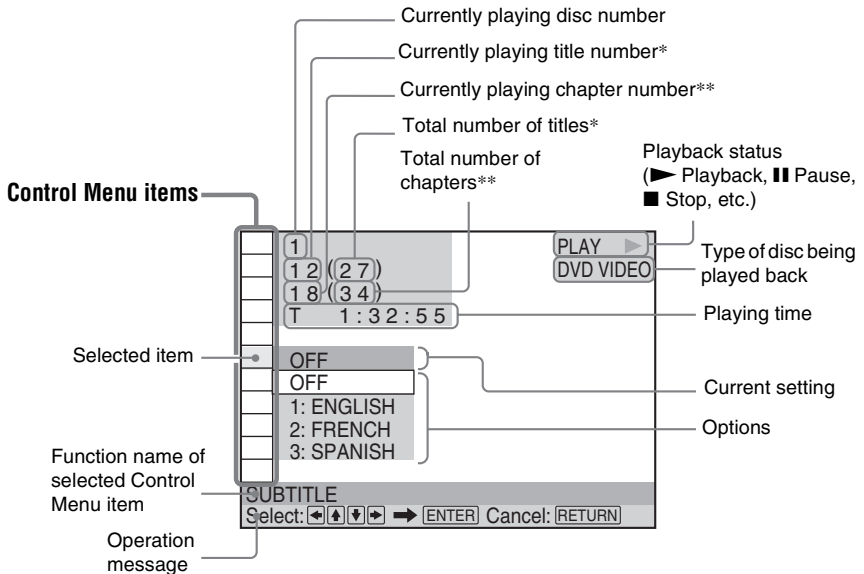











Example: Control Menu display 1 when playing a DVD VIDEO



\* Displays the scene number for VIDEO CDs (PBC is on), track number for VIDEO CDs/CDs, album number for DATA CDs.



\*\* Displays the index number for VIDEO CDs/CDs, MP3 audio track number for DATA CDs.

## List of Control Menu Items

Item	Item Name, Function, Relevant Disc Type
	<b>DISC (page 42)</b> Selects the disc to be played. <b>DVD-V DVD-RW VCD CD DATA CD</b>
	<b>TITLE (page 42)/SCENE (page 42)/TRACK (page 42)</b> Selects the title, scene, or track to be played. <b>DVD-V DVD-RW VCD</b>
	<b>CHAPTER (page 42)/INDEX (page 42)</b> Selects the chapter or index to be played. <b>DVD-V DVD-RW VCD</b>
	<b>ALBUM (page 42)</b> Selects the album to be played. <b>DATA CD</b>
	<b>TRACK (page 42)</b> Selects the track to be played. <b>CD DATA CD</b>
	<b>INDEX (page 42)</b> Selects the index to be played. <b>CD</b>
	<b>ORIGINAL/PLAY LIST (page 31)</b> Selects the type of titles (DVD-RW) to be played, the ORIGINAL one, or an edited PLAY LIST. <b>DVD-RW</b>
	<b>TIME/TEXT (page 42)</b> Checks the elapsed time and the remaining playback time. Input the time code for picture and music searching. Displays the DVD/CD text or the DATA CD's track name. <b>DVD-V DVD-RW VCD CD DATA CD</b>
	<b>AUDIO (page 49)</b> Changes the audio setting. <b>DVD-V DVD-RW VCD CD DATA CD</b>
	<b>SUBTITLE (page 53)</b> Displays the subtitles. Changes the subtitle language. <b>DVD-V DVD-RW</b>
	<b>ANGLE (page 53)</b> Changes the angle. <b>DVD-V</b>
	<b>TVS (TV Virtual Surround) (page 51)</b> Selects the surround functions. <b>DVD-V</b>
	<b>ADVANCED (page 47)</b> Displays the information (bit rate or layer) of the disc currently playing. <b>DVD-V DVD-RW</b>
	<b>PARENTAL CONTROL (page 58)</b> Set to prohibit playback on this player. <b>DVD-V VCD CD</b>
	<b>SETUP (page 63)</b> QUICK Setup (page 24) Use Quick Setup to choose the desired language of the on-screen display, the aspect ratio of the TV and the audio output signals. CUSTOM Setup In addition to the Quick Setup setting, you can adjust other various settings. RESET Returns the settings in "SETUP" to the default setting. <b>DVD-V DVD-RW VCD CD DATA CD</b>

	<b>ALL DISCS/ONE DISC (page 36)</b> Selects All Discs or One Disc mode.	<b>DVD-V DVD-RW VCD CD DATA CD</b>
	<b>PROGRAM (page 36)</b> Selects the disc, title, chapter, or track to play in the order you want.	<b>DVD-V VCD CD</b>
	<b>SHUFFLE (page 38)</b> Plays the disc, title, chapter, or track in random order.	<b>DVD-V DVD-RW VCD CD DATA CD</b>
	<b>REPEAT (page 39)</b> Plays the entire disc (all titles/all tracks/all albums) repeatedly or one title/chapter/track/album repeatedly.	<b>DVD-V DVD-RW VCD CD DATA CD</b>
	<b>A-B REPEAT (page 40)</b> Specifies the parts you want to play repeatedly.	<b>DVD-V DVD-RW VCD CD</b>
	<b>BNR (page 54)</b> Adjusts the picture quality by reducing the “block noise” or mosaic like patterns that appear on your TV screen.	<b>DVD-V DVD-RW VCD</b>
	<b>CUSTOM PICTURE MODE (page 55)</b> Adjusts the video signal from the player. You can select the picture quality that best suits the program you are watching.	<b>DVD-V DVD-RW VCD</b>
	<b>DIGITAL VIDEO ENHANCER (page 56)</b> Exaggerates the outline of the image to produce a sharper picture.	<b>DVD-V DVD-RW VCD</b>
	<b>PICTURE NAVIGATION (page 44)</b> Divides the screen into 9 subscreens to help you find the scene you want quickly.	<b>DVD-V VCD</b>

#### Hint

The Control Menu icon indicator lights up in green  →  when you select any item except “OFF.” (“TVS,” “PROGRAM,” “SHUFFLE,” “REPEAT,” “A-B REPEAT,” “BNR,” “DIGITAL VIDEO ENHANCER” only). The “ANGLE” indicator lights up in green only when the angles can be changed. The “CUSTOM PICTURE MODE” indicator lights up in green when any setting other than “STANDARD” is selected.

## Hooking Up the Player

Follow Steps 1 to 6 to hook up and adjust the settings of the player.

### Notes

- Plug cords securely to prevent unwanted noise.
- Refer to the instructions supplied with the components to be connected.
- You cannot connect this player to a TV that does not have a video input jack.
- Be sure to disconnect the power of each component before connecting.

## Step 1: Unpacking

Check that you have the following items:

- Audio/video cord (pinplug × 3 ↔ pinplug × 3) (1)
- Remote commander (remote) (1)
- Size AA (R6) batteries (2)

## Step 2: Inserting Batteries into the Remote

You can control the player using the supplied remote. Insert two Size AA (R6) batteries by matching the ⊕ and ⊖ ends on the batteries to the markings inside the compartment. When using the remote, point it at the remote sensor  on the player.

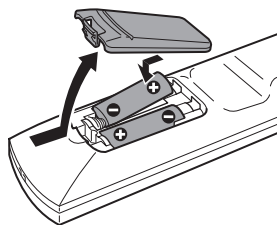

### Notes

- Do not leave the remote in an extremely hot or humid place.
- Do not drop any foreign object into the remote casing, particularly when replacing the batteries.
- Do not expose the remote sensor to direct light from the sun or a lighting apparatus. Doing so may cause a malfunction.
- If you do not use the remote for an extended period of time, remove the batteries to avoid possible damage from battery leakage and corrosion.

# Step 3: Connecting the Video Cords

Connect this player to your TV monitor, projector, or AV amplifier (receiver) using a video cord. Select one of the patterns **A** through **C**, according to the input jack on your TV monitor, projector, or AV amplifier (receiver).

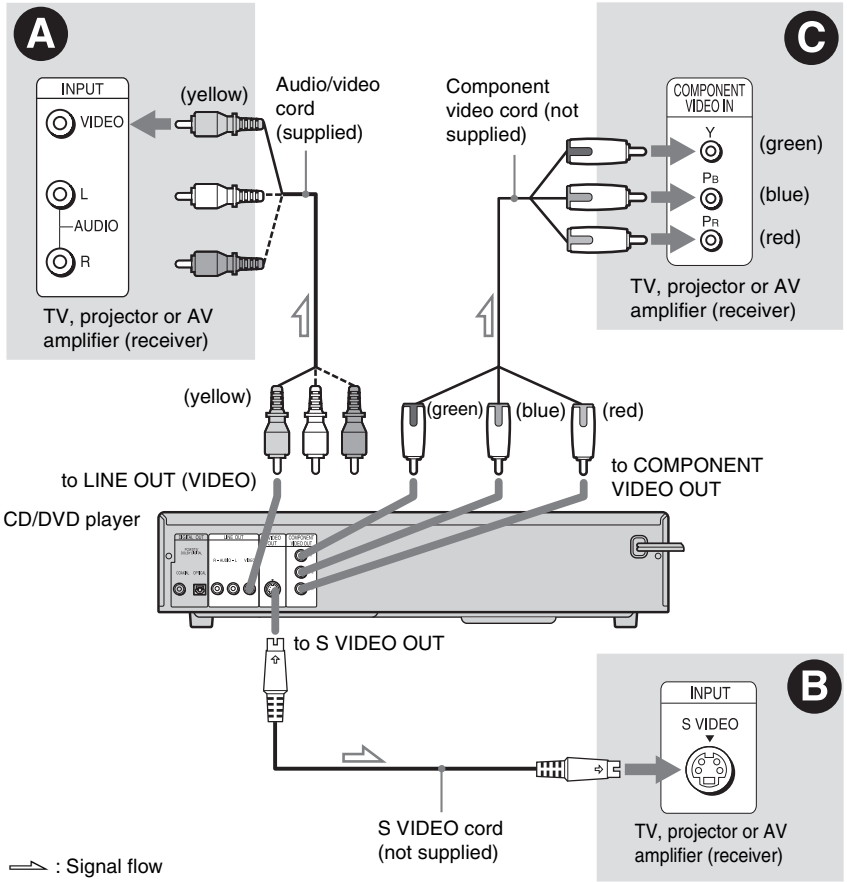

## **A** If you are connecting to a video input jack

Connect the yellow plug of the audio/video cord (supplied) to the yellow (video) jacks. You will enjoy standard quality images.

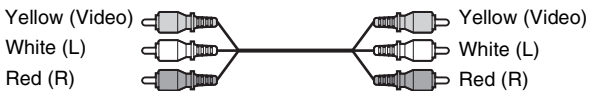

Use the red and white plugs to connect to the audio input jacks (page 20). (Do this if you are connecting to a TV only.)



## **B** If you are connecting to an S VIDEO input jack

Connect an S VIDEO cord (not supplied). You will enjoy high quality images.



## **C** If you are connecting to a monitor, projector, or AV amplifier (receiver) having component video input jacks (Y/P<sub>B</sub>/P<sub>R</sub>)

Connect the component via the COMPONENT VIDEO OUT jacks using a component video cord (not supplied) or three video cords (not supplied) of the same kind and length. You will enjoy accurate color reproduction and high quality images. If your TV accepts progressive (480p) format signals, you must use this connection and then press PROGRESSIVE on the front panel to accept progressive video signals. See “Using the PROGRESSIVE button” on the next page for more information.



### **When connecting to a wide screen TV**

Depending on the disc, the image of some discs may not fit your TV screen. If you want to change the aspect ratio, please refer to page 65.

#### **Notes**

- Connect the player directly to the TV. If you pass the player signals via the VCR, you may not receive a clear image on the TV screen.

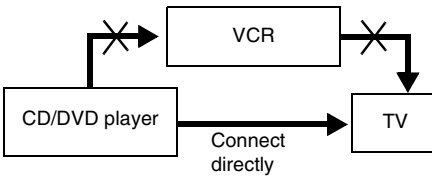

- Consumers should note that not all high definition television sets are fully compatible with this product and may cause artifacts to be displayed in the picture. In the case of 480 progressive scan picture problems, it is recommended that you switches the connection to the standard definition output. If there are questions regarding your Sony TV set's compatibility with this model 480p DVD player, please contact our customer service center.

---

## Using the PROGRESSIVE button

You can fine-tune the Progressive 480p video signal output when you press PROGRESSIVE on the front panel (the PROGRESSIVE indicator lights up in blue) and connect the player using the COMPONENT VIDEO OUT jacks to a TV that is able to accept the video signal in progressive format.

### ◆ Conversion Modes

DVD software can be divided into two types: film based software and video based software. Video based software is derived from the TV, such as dramas and sit-coms, and displays images at 30 frames/60 fields per second. Film based software is derived from film and displays images at 24 frames per second. Some DVD software contains both Video and Film.

In order for these images to appear natural on your screen when output in PROGRESSIVE mode (60 frames per second), the progressive video signal needs to be converted to match the type of DVD software that you are watching.

Press PROGRESSIVE repeatedly to turn or change the displays as follows:

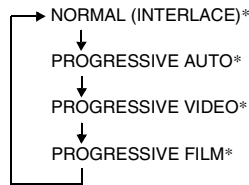

\* Appears as NORMAL, P AUTO, P VIDEO, or P FILM on the front panel display

- **NORMAL (INTERLACE)**

Select this when you are connected to a standard (Interlace format) TV.

- **PROGRESSIVE AUTO**

Select this when you are connected to a progressive TV. This will automatically detect if you are playing Film based or Video based software and convert the signal to the appropriate conversion mode. Normally select this position when you are connected to a progressive TV.

- **PROGRESSIVE VIDEO**

Select this when you are connected to a progressive TV. This will set the conversion mode for Video based software, regardless of the type of software that you are playing.

- **PROGRESSIVE FILM**

Select this when you are connected to a progressive TV. This will set the conversion mode for Film based software, regardless of the type of software that you are playing.

### Notes

- When you select PROGRESSIVE FILM, the progressive format images may become unclear or unnatural. If this happens, select PROGRESSIVE VIDEO.
- When you play video based software with progressive signals, sections of some types of images may appear unnatural due to the conversion process when output through the COMPONENT VIDEO OUT jacks. Images from the S VIDEO OUT and LINE OUT (VIDEO) jacks are unaffected as they are output in the normal (interlace) format.

# Step 4: Connecting the Audio Cords

Refer to the chart below to select the connection that best suits your system. Be sure to also read the instructions for the components you wish to connect.

## Select a connection

Select one of the following connections, **A** through **D**.

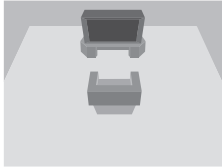
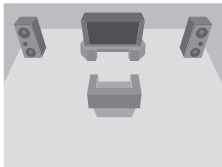
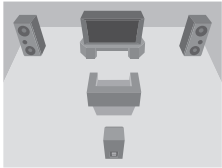
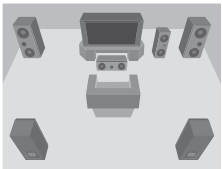
Components to be connected	Connection	Your setup
<p><b>TV</b></p> <ul style="list-style-type: none"> <li>Surround effects: TVS DYNAMIC (page 51), TVS WIDE (page 51)</li> </ul>	<b>A</b> (page 20)	<p>Example</p> 
<p><b>Stereo amplifier (receiver) and two speakers</b></p> <ul style="list-style-type: none"> <li>Surround effects: TVS STANDARD (page 52) or <b>MD deck/DAT deck</b></li> <li>Surround effects: TVS STANDARD (page 52)</li> </ul>	<b>B</b> (page 21)	<p>Example</p> 
<p><b>AV amplifier (receiver) having a Dolby* Surround (Pro Logic) decoder and 3 to 6 speakers</b></p> <ul style="list-style-type: none"> <li>Surround effects: Dolby Surround (Pro Logic) (page 68)</li> </ul>	<b>C</b> (page 22)	<p>Example</p> 
<p><b>AV amplifier (receiver) with a digital input jack having a Dolby Digital or DTS** decoder and 6 speakers</b></p> <ul style="list-style-type: none"> <li>Surround effects: Dolby Digital (5.1ch) (page 68), DTS (5.1ch) (page 68)</li> </ul>	<b>D</b> (page 23)	<p>Example</p> 

\* Manufactured under license from Dolby Laboratories. "Dolby," "Pro Logic," and the double-D symbol are trademarks of Dolby Laboratories.

\*\* "DTS" and "DTS Digital Out" are trademarks of Digital Theater Systems, Inc.

## A Connecting to your TV

This connection will use your TV speakers for sound.

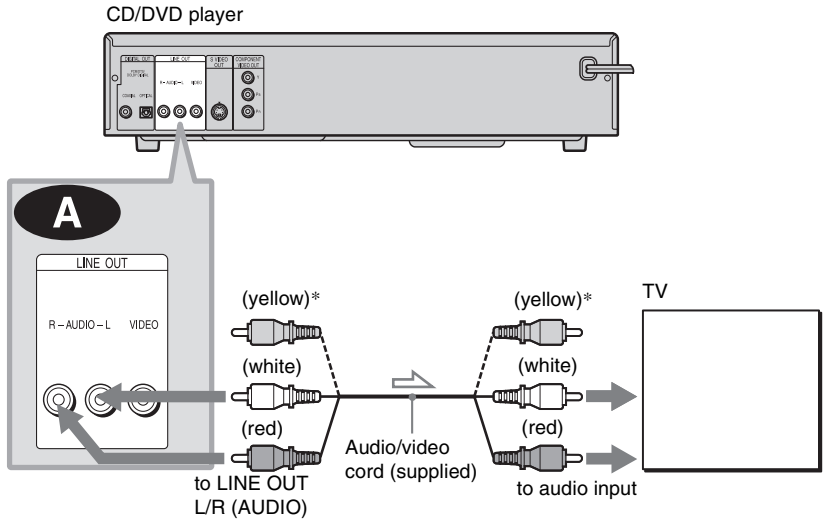

\* The yellow plug is used for video signals (page 16).

### Hint

When connecting to a monaural TV, use a stereo-mono conversion cord (not supplied). Connect the LINE OUT L/R (AUDIO) jacks to the TV's audio input jack.

## **B** Connecting to a stereo amplifier (receiver) and 2 speakers/Connecting to an MD deck or DAT deck

If the stereo amplifier (receiver) has audio input jacks L and R only, use **B-1**. If the amplifier (receiver) has a digital input jack, or when connecting to an MD deck or DAT deck, use **B-2**. In this case, you can also connect the player directly to the MD deck or DAT deck without using your stereo amplifier (receiver).

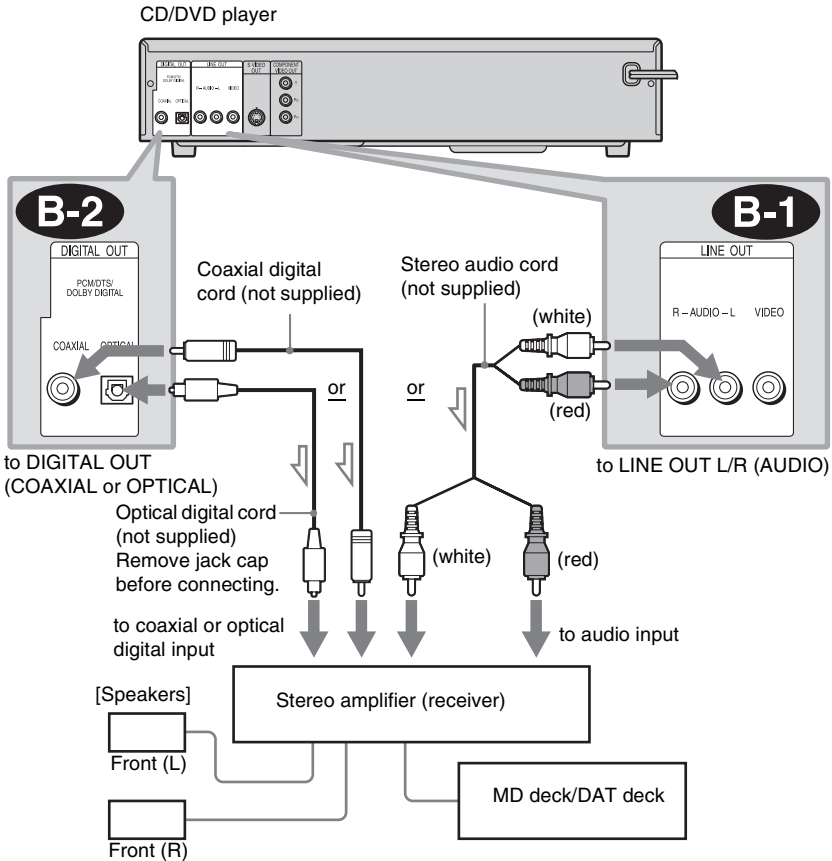

→: Signal flow

## C Connecting to an AV amplifier (receiver) having a Dolby Surround (Pro Logic) decoder and 3 to 6 speakers

You can enjoy the Dolby Surround effects only when playing Dolby Surround audio or multi-channel audio (Dolby Digital) discs.

If your amplifier (receiver) has L and R audio input jacks only, use **C-1**. If your amplifier (receiver) has a digital input jack, use **C-2**.

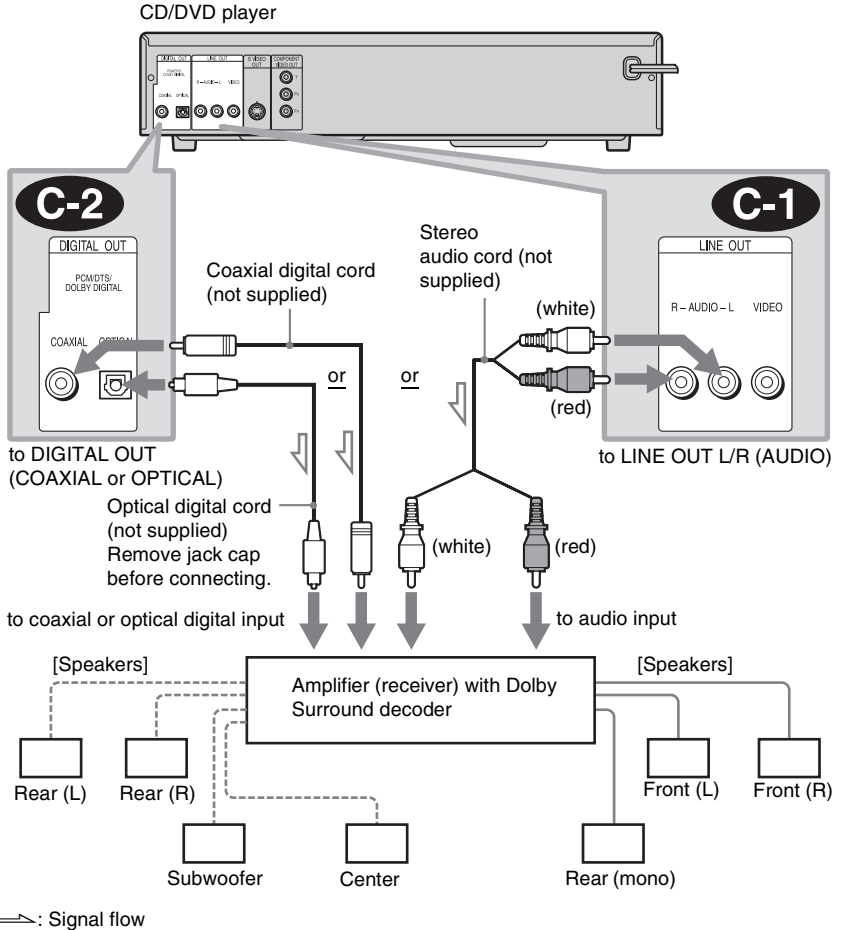

### Note

When connecting 6 speakers, replace the monaural rear speaker with a center speaker, 2 rear speakers and a subwoofer.

# D Connecting to an AV amplifier (receiver) with a digital input jack having a Dolby Digital, or DTS decoder and 6 speakers

This connection will allow you to use the Dolby Digital, or DTS decoder function of your AV amplifier (receiver).

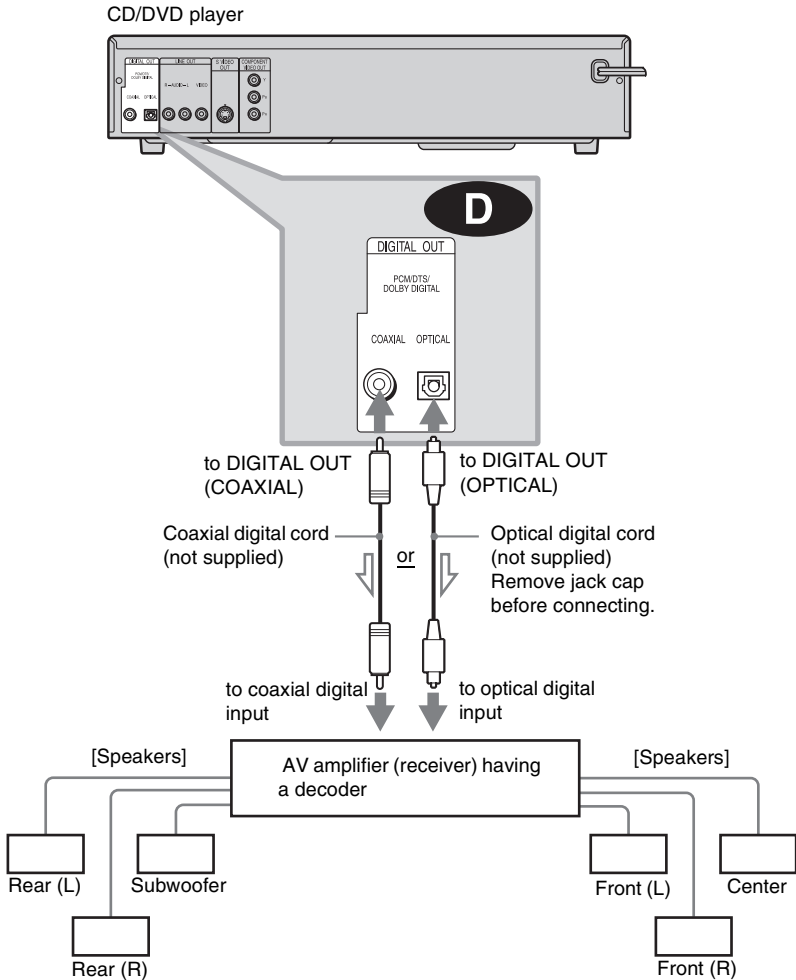

⇒ : Signal flow

## Note

After you have completed the connection, be sure to set "DOLBY DIGITAL" to "DOLBY DIGITAL" and "DTS" to "ON" in Quick Setup (page 24).

## Step 5: Connecting the Power Cord

Plug the player and TV power cords into an AC outlet.

## Step 6: Quick Setup

Follow the steps below to make the minimum number of basic adjustments for using the player. To skip an adjustment, press **▶▶**. To return to the previous adjustment, press **◀◀**.

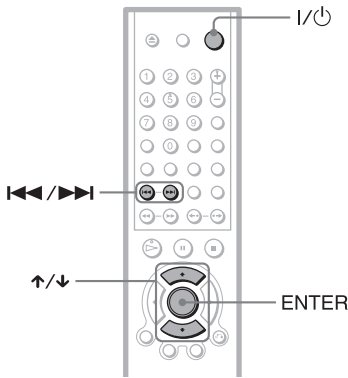

### 1 Turn on the TV.

### 2 Press I/⏻.

Press PROGRESSIVE on the front panel only if you have made video connection **C** (page 16) and wish to view progressive video signals. The PROGRESSIVE indicator lights up in blue when the player outputs progressive signal.

### 3 Switch the input selector on your TV so that the signal from the player appears on the TV screen.

“Press [ENTER] to run QUICK SETUP.” appears at the bottom of the screen. If this message does not appear, select “QUICK” under “SETUP” in the Control Menu to run Quick Setup (page 64).

### 4 Press ENTER without inserting a disc.

The Setup Display for selecting the language used in the on-screen display appears.

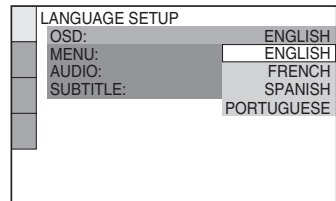

### 5 Press ⬆/⬇ to select a language.

The player uses the language selected here to display the menu and subtitles as well.

### 6 Press ENTER.

The Setup Display for selecting the aspect ratio of the TV to be connected appears.

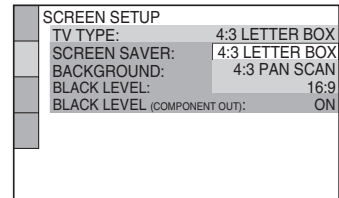



## 7 Press $\uparrow/\downarrow$ to select the setting that matches your TV type.

### ◆ If you have a 4:3 standard TV

- 4:3 LETTER BOX or 4:3 PAN SCAN (page 65)

### ◆ If you have a wide-screen TV or a 4:3 standard TV with a wide-screen mode

- 16:9 (page 65)

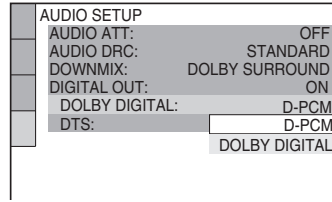

- **B-2** **C-2**
- D-PCM (page 68)

- **D**
- DOLBY DIGITAL (only if the amplifier (receiver) has a Dolby Digital decoder) (page 68)

## 8 Press ENTER.

The Setup Display for selecting the type of jack used to connect your amplifier (receiver) appears.

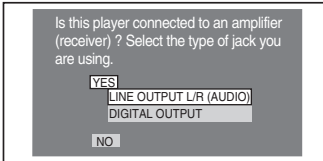

## 9 Press $\uparrow/\downarrow$ to select the type of jack (if any) you are using to connect to an amplifier (receiver), then press ENTER.

Choose the item that matches the audio connection you selected on pages 20 to 23 ( **A** through **D** ).

- **A**
- If you connect just a TV and nothing else, select "NO." Quick Setup is finished and connections are complete.

- **B-1** **C-1**
- Select "LINE OUTPUT L/R (AUDIO)." Quick Setup is finished and connections are complete.

- **B-2** **C-2** **D**
- Select "DIGITAL OUTPUT." The Setup Display for "DOLBY DIGITAL" appears.

## 10 Press $\uparrow/\downarrow$ to select the type of Dolby Digital signal you wish to send to your amplifier (receiver).

Choose the signal that matches the audio connection you selected on pages 21 to 23 ( **B** through **D** ).

## 11 Press ENTER.

"DTS" is selected.

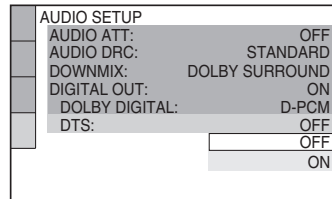

## 12 Press $\uparrow/\downarrow$ to select whether or not you wish to send a DTS signal to your amplifier (receiver).

Choose the item that matches the audio connection you selected on pages 21 to 23 ( **B** through **D** ).

- **B-2** **C-2**
- OFF (page 68)
- **D**
- ON (only if the amplifier (receiver) has a DTS decoder) (page 68)

## 13 Press ENTER.

Quick Setup is finished. All connections and setup operations are complete.

---

## Enjoying the surround sound effects

To enjoy the surround sound effects of this player or your amplifier (receiver), set the following items as described below for the audio connection you selected on pages 21 to 23 ( **B** through **D** ). Each of these is the default setting and does not need to be adjusted when you first connect the player. Refer to page 63 for using the Setup Display.

### Audio Connection (pages 20 to 23)

- A**
  - No additional settings are needed.
- B-1 C-1**
  - Set “DOWNMIX” to “DOLBY SURROUND” (page 68).
  - If the sound distorts even when the volume is turned down, set “AUDIO ATT” to “ON” (page 67).
- B-2 C-2 D**
  - Set “DOWNMIX” to “DOLBY SURROUND” (page 68).
  - Set “DIGITAL OUT” to “ON” (page 68).

## Playing Discs

### Playing Discs **DVD-V**

**DVD-RW VCD CD DATA CD**

Depending on the DVD or VIDEO CD, some operations may be different or restricted. Refer to the operating instructions supplied with your disc.

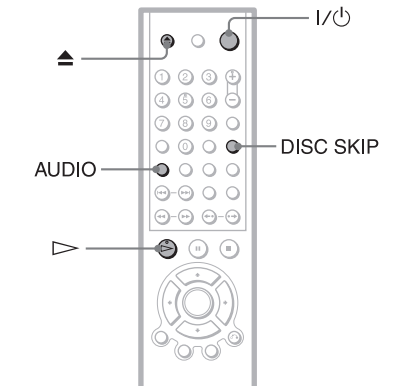
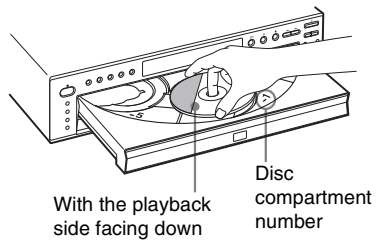
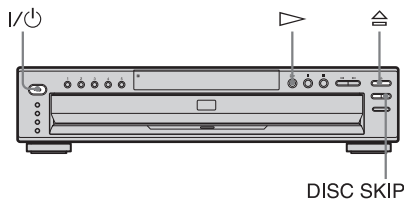

**1 Turn on your TV.**

**2 Press I/O.**

The player turns on.

**3 Switch the input selector on your TV so that the signal from the player appears on the TV screen.**

◆ **When using an amplifier (receiver)**

Turn on the amplifier (receiver) and select the appropriate channel so that you can hear sound from the player.

**4 Press  on the player, and place a disc on the disc tray.**

To place other discs on the tray, press DISC SKIP and place the discs in the order you want to play them. Each time you press DISC SKIP, the disc tray turns so you can place the discs on the empty compartments. The player plays from the last disc placed on the tray.

**5 Press .**

The disc tray closes, and the player starts playback (continuous play). Adjust the volume on the TV or the amplifier (receiver).

Depending on the disc, a menu may appear on the TV screen. For DVD VIDEOS, see page 31. For VIDEO CDs, see page 32.

**To turn off the player**

Press I/O. The player enters standby mode.

 **Hint**

You can have the player turn off automatically whenever you leave it in stop mode for more than 30 minutes. To turn on this function, set "AUTO POWER OFF" in "CUSTOM SETUP" to "ON" (page 66).

**Notes on playing DTS sound tracks on a CD**

- When playing DTS-encoded CDs, excessive noise will be heard from the analog stereo jacks. To avoid possible damage to the audio system, the consumer should take proper precautions when the analog stereo jacks of the player are connected to an amplification system. To enjoy DTS Digital Surround™ playback, an external 5.1-channel decoder system must be connected to the digital jack of the player.

- Set the sound to “STEREO” using the AUDIO button when you play DTS sound tracks on a CD (page 49).
- Do not play DTS sound tracks without first connecting the player to an audio component having a built-in DTS decoder. The player outputs the DTS signal via the DIGITAL OUT (COAXIAL or OPTICAL) jack even if “DTS” in “AUDIO SETUP” is set to “OFF” in the Setup Display (page 68), and may affect your ears or cause your speakers to be damaged.

### Notes on playing DTS sound tracks on a DVD

- DTS audio signals are output only through the DIGITAL OUT (COAXIAL or OPTICAL) jack.
- When you play a DVD VIDEO with DTS sound tracks, set “DTS” to “ON” in “AUDIO SETUP” (page 68).
- If you connect the player to audio equipment without a DTS decoder, do not set “DTS” to “ON” in “AUDIO SETUP” (page 68). A loud noise may come out from the speakers, affecting your ears or causing the speakers to be damaged.

## Additional operations

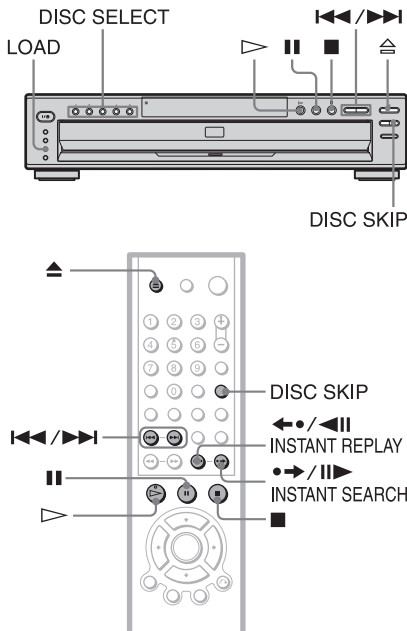

To	Operation
Select a disc	Press DISC SELECT 1-5 on the player
Stop	Press ■
Pause	Press ■■
Resume play after pause	Press ■■ or ▷
Go to the next disc	Press DISC SKIP
Go to the next chapter, track, or scene in continuous play mode	Press ►►
Go back to the previous chapter, track, or scene in continuous play mode	Press ◀◀
Stop play and remove the disc	Press ▲
Replay the previous scene*	Press ◀●/◀■ INSTANT REPLAY during playback
Briefly fast forward the current scene**	Press ●●/▶■ INSTANT SEARCH during playback
Check if a disc is in the disc compartment	Press LOAD on the player. The disc number indicators on the front panel display (1-5) light up.

\* For DVD VIDEOS and DVD-RWs/DVD-Rs only.

\*\*For DVD VIDEOS and DVD-RWs/DVD-Rs or DVD+RWs only.

### Hints

- The Instant Replay function is useful when you want to review a scene or dialog that you missed.
- The Instant Search function is useful when you want to pass over a scene that you don't want to watch.
- Before loading the discs, a disc number indicator of an empty compartment may be lit.

### Note

You may not be able to use the Replay function with some scenes.

## Replacing discs while playing a disc (EXCHANGE)

You can open the disc tray while playing a disc so that you can check which discs are to be played next and replace discs without interrupting playback of the current disc.

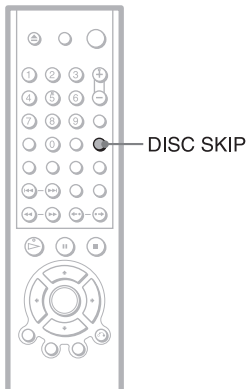
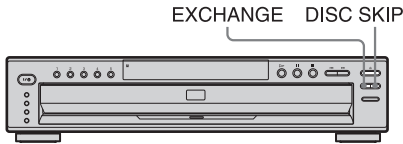

### 1 Press EXCHANGE.

The disc tray opens and two disc compartments appear. Even if the player is playing a disc, it doesn't stop playing.

### 2 Replace the discs in the compartments with new ones.

### 3 Press DISC SKIP.

The disc tray turns and another two disc compartments appear.

### 4 Replace the discs in the compartments with new ones.

### 5 Press EXCHANGE.

The disc tray closes.

#### Hint

While the disc tray is open,  
– If the playback of the current disc ends, the player stops playing. If the disc is played in One Disc

Repeat Play mode (page 39), the current disc starts playing again.

- In All Discs Shuffle Play mode (page 38), titles/tracks/chapters are reshuffled only on the current disc.
- In Program Play mode (page 36), the titles/tracks/chapters only on the current disc are played.

#### Note

Do not push the disc tray to close in Step 5, as you may damage the player.

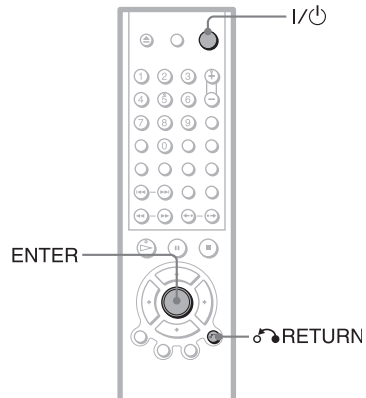

## Locking the disc tray (Child Lock)

You can lock the disc tray to prevent children from opening it.



**When the player is in standby mode, press  RETURN, ENTER, and then I/O on the remote.**

The player turns on and "LOCKED" appears on the front panel display.

The  and EXCHANGE buttons on the player and the  button on the remote do not work while the Child Lock is set.

### To unlock the disc tray

When the player is in standby mode, press  RETURN, ENTER, and then I/O again.

#### Note

Even if you select "RESET" under "SETUP" in the Control Menu (page 64), the disc tray remains locked.

# Resuming Playback from the Point Where You Stopped the Disc (Resume Play/Multi-disc Resume)

The player remembers the point where you stopped the disc.

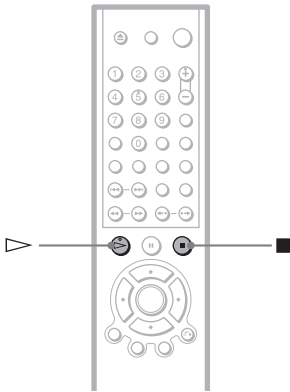

## Resuming playback for the current disc (Resume Play)

DVD-V DVD-RW VCD CD DATA CD

The player remembers the point where you stopped the disc even if the player enters standby mode by pressing **I/⏻**.

### 1 While playing a disc, press **■** to stop playback.

“RESUME” appears on the front panel display.

### 2 Press **▷**.

The player starts playback from the point where you stopped the disc in step 1.

#### Hint

To play from the beginning of the disc, press **■** twice, then press **▷**.

## Notes

- The point where you stopped playing is cleared when:
  - you change the play mode.
  - you do Program Play or Shuffle Play.
  - you change the settings on the Setup Display.
- When playing a CD and DVD-RW (VR mode), the point where you stopped is cleared when:
  - you press DISC SKIP or DISC SELECT.
  - you opened the disc tray.
  - you disconnect the power cord.
- When playing a DATA CD, the point where you stopped playing is cleared when the player enters standby mode, the disc tray is opened, or the power cord is disconnected.
- This function may not work with some discs.

## Storing the point where you stopped the disc (Multi-disc Resume) DVD-V VCD

The player stores the point where you stopped the disc and resumes playback from the same point the next time you insert the same disc. The player remembers the stopped point of the disc even after you play other discs in the disc tray.

Resume playback points for up to 6 different DVD VIDEO/VIDEO CD discs remain in memory even if you disconnect the power cord. When you store a resume playback point for the 7th disc, the resume playback point for the first disc is deleted.

#### Hints

- To play from the beginning of the disc, press **■** twice, then press **▷**.
- To turn off the Multi-disc Resume function, set “MULTI-DISC RESUME” in “CUSTOM SETUP” to “OFF” (page 67). Playback restarts at the resume point only for the current disc in the player.

## Notes

- “MULTI-DISC RESUME” in “CUSTOM SETUP” must be set to “ON” (default) for this function to work (page 67).
- This function may not work with some discs.
- If “MULTI-DISC RESUME” in “CUSTOM SETUP” is set to “ON” and you playback a recorded disc such as DVD-RW, the player may playback other recorded discs from the same resume point. To play from the beginning, press **■** twice and then press **▷**.

# Using the DVD's Menu

## DVD-V

A DVD is divided into long sections of a picture or a music feature called "titles." When you play a DVD which contains several titles, you can select the title you want using the TOP MENU button. When you play DVDs that allow you to select items such as the language for the subtitles and the language for the sound, select these items using the MENU button.

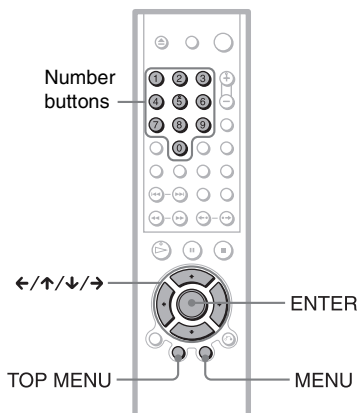

### 1 Press TOP MENU or MENU.

The disc's menu appears on the TV screen. The contents of the menu vary from disc to disc.

### 2 Press ←/↑/↓/→ or the number buttons to select the item you want to play or change.

If you press the number buttons, the following display appears. Press the number buttons to select the item you want.

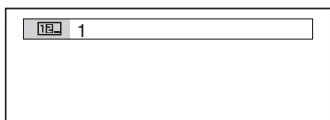

### 3 Press ENTER.

# Selecting "ORIGINAL" or "PLAY LIST" on a DVD-RW Disc

## DVD-RW

Some DVD-RW discs in VR (Video Recording) mode have two types of titles for playback: originally recorded titles (ORIGINAL) and titles that can be created on recordable DVD players for editing (PLAY LIST). You can select the type of titles to be played.

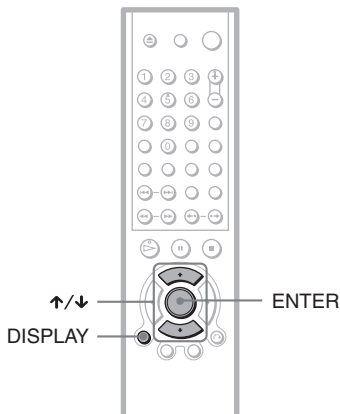

### 1 Press DISPLAY in stop mode.

The Control Menu appears.

### 2 Press ↑/↓ to select (ORIGINAL/PLAY LIST), then press ENTER.

The options for "ORIGINAL/PLAY LIST" appear.

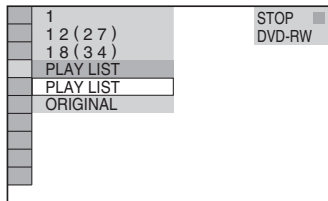

### 3 Press $\uparrow/\downarrow$ to select the setting.

- PLAY LIST: plays the titles created from "ORIGINAL" for editing.
- ORIGINAL: plays the titles originally recorded.

### 4 Press ENTER.

#### To turn off the Control Menu

Press DISPLAY repeatedly until the Control Menu is turned off.

## Playing VIDEO CDs with PBC Functions (PBC Playback)

### VCD

PBC (Playback Control) allows you to play VIDEO CDs interactively by following the menu on the TV screen.

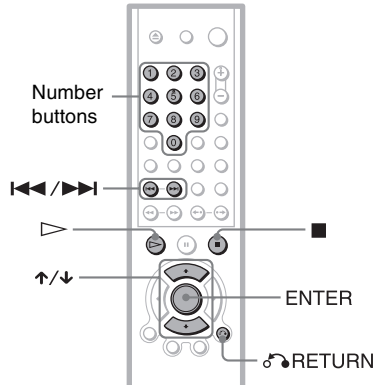

### 1 Start playing a VIDEO CD with PBC functions.

The menu for your selection appears.

### 2 Select the item number and track you want using $\uparrow/\downarrow$ or the number buttons.

### 3 Press ENTER.

### 4 Follow the instructions in the menu for interactive operations.

Refer to the instructions supplied with the disc, as the operating procedure may differ depending on the VIDEO CD.

#### To return to the menu

Press  $\hookrightarrow$  RETURN.



### Hint

To play without using PBC, press **◀◀/▶▶** while the player is stopped to select a track, then press **▷** or ENTER.

“Play without PBC.” appears on the TV screen and the player starts continuous play. You cannot play still pictures such as a menu.

To return to PBC playback, press **■** twice then press **▷**.

### Notes

- Depending on the VIDEO CD, “Press ENTER” in step 3 may appear as “Press SELECT” in the instructions supplied with the disc. In this case, press **▷**.
- The PBC functions of Super VCDs do not work with this player. Super VCDs are played in continuous play mode only.

## Playing an MP3 Audio Track **DATA CD**

You can play back DATA CDs (CD-ROMs/CD-Rs/CD-RWs) recorded in MP3 (MPEG1 Audio Layer 3) format.

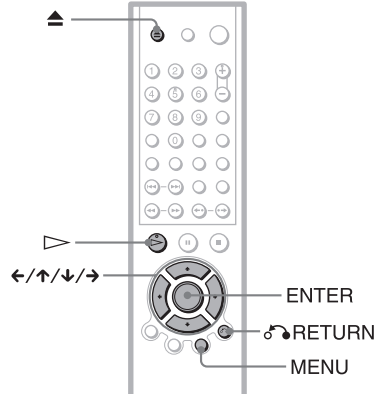

**1** Press **▲** and place a DATA CD on the disc tray.

**2** Press **▷**.

The disc tray closes, and the player starts to play the first MP3 audio track in the first album on the disc.

### Notes

- This player can play MP3 audio tracks recorded in the following sampling frequencies: 32 kHz, 44.1 kHz, 48 kHz.
- The playback order may be different from the edited order. See “The playback order of MP3 audio tracks” (page 35) for details.

---

## Selecting an album and track

### 1 Press MENU.

The list of MP3 albums recorded on the DATA CD appears.

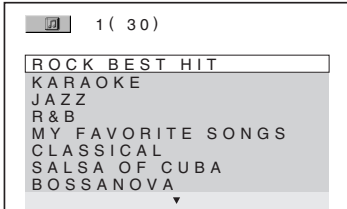

### 2 Select an album using ↑/↓ and press ENTER.

The list of tracks contained in the album appears.

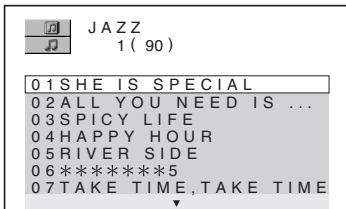

### 3 Select a track using ↑/↓ and press ENTER.

The selected track starts playing.  
When a track or album is being played, its title is shaded.

---

### To go to the next or previous page

Press → or ←.

### To return to the previous display

Press ↶ RETURN.

### To turn off the display

Press MENU.

#### Notes

- Only the letters in the alphabet and numbers can be used for album or track names. Anything else is displayed as “\*”.
- ID3 tags cannot be displayed.

---

## About MP3 audio tracks

You can play MP3 audio tracks on CD-ROMs or CD-Rs/CD-RWs. However, the discs must be recorded according to ISO9660 level 1, level 2, or Joliet format for the player to recognize the tracks.

You can also play discs recorded in Multi Session.

See the instructions of the CD-R/CD-RW device or recording software (not supplied) for details on the recording format.

### To play a Multi Session CD

This player can play Multi Session CDs when an MP3 audio track is located in the first session. Any subsequent MP3 audio tracks, recorded in the later sessions, can also be played back.

When audio tracks and images in music CD format or Video CD format are recorded in the first session, only the first session will be played back.

#### Notes

- If you put the extension “.MP3” to data not in MP3 format, the player cannot recognize the data properly and will generate a loud noise which could damage your speaker system.
- The player cannot play audio tracks in MP3PRO format.

## The playback order of MP3 audio tracks

The playback order of albums and tracks recorded on a DATA CD is as follows.

### ◆ Structure of disc contents

Tree 1    Tree 2    Tree 3    Tree 4    Tree 5

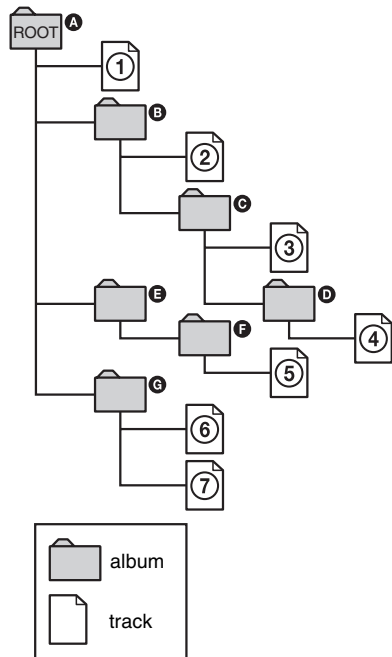

When you insert a DATA CD and press  $\blacktriangleright$ , the numbered tracks are played sequentially, from ① through ⑦. Any sub-albums/tracks contained within a currently selected album take priority over the next album in the same tree. (Example: C contains D so ④ is played before ⑤.)

When you press MENU and the list of MP3 albums appears (page 34), the albums are arranged in the following order: A → B → C → D → F → G. Albums that do not contain tracks (such as album E) do not appear in the list.

### 💡 Hints

- If you add numbers (01, 02, 03, etc.) to the front of the track names, the tracks will be played in that order.
- Since a disc with many trees takes longer to start playback, it is recommended that you create the albums no more than two trees.

## Notes

- Depending on the software you use to create the DATA CD, the playback order may differ from the illustration above.
- The playback order above may not be applicable if there are more than a total of 999 albums and tracks in the DATA CD.
- The player can recognize up to 499 albums (the player will count just albums, including albums that do not contain MP3 audio tracks). The player will not play any albums beyond the first 499 albums. Of the first 499 albums, the player will play no more than a combined total of 999 albums and tracks.

# Various Play Mode Functions (Program Play, Shuffle Play, Repeat Play, A-B Repeat Play)

## Various Play Mode Functions (Program Play, Shuffle Play, Repeat Play, A-B Repeat Play)

You can set the following play modes:

- Program Play (page 36)
- Shuffle Play (page 38)
- Repeat Play (page 39)
- A-B Repeat Play (page 40)

### Note

The play mode is canceled when:

- you open the disc tray.
- the player enters standby mode by pressing **I/⏻**.

## Selecting the disc mode (One Disc or All Discs)

**DVD-V DVD-RW VCD CD DATA CD**

You can play one disc or all of the discs in the player. Before setting Program Play, Shuffle Play, or Repeat Play, you must select whether to set those play mode on one disc or all of the discs.

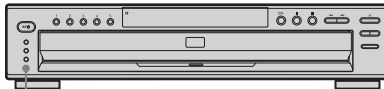

ONE/ALL

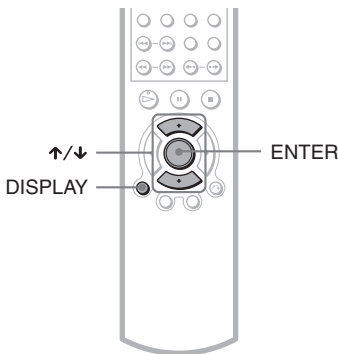

↑/↓ ENTER  
DISPLAY

- 1 Press DISPLAY once or twice.**  
The following Control Menu appears.

- 2 Press ↑/↓ to select  (One Disc/ All Discs) and press ENTER.**

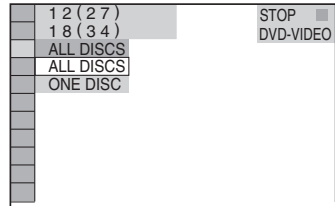

### Hint

You can select "ALL DISCS" or "ONE DISC" by pressing ONE/ALL button on the player. Each time you press the button, the disc mode changes alternately.

## Creating your own program (Program Play) **DVD-V VCD CD**

You can play the contents of a disc in the order you want by arranging the order of the titles, chapters, or tracks on the disc to create your own program.

You can program up to 99 items. By selecting All Discs mode (page 36), you can create a program for all of the discs in the player.

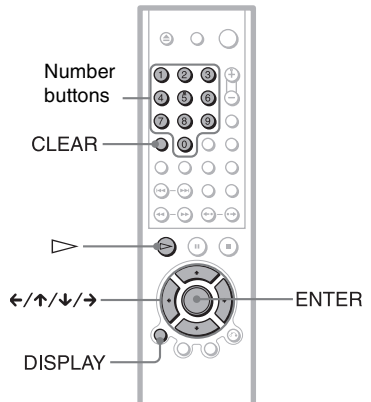

- 1 Press DISPLAY twice.**  
The Control Menu appears.
- 2 Press ↑/↓ to select  (PROGRAM), then press ENTER.**  
The options for "PROGRAM" appear.

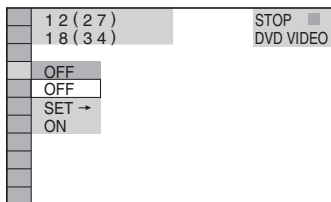

**3 Press  $\uparrow/\downarrow$  to select "SET ->" then press ENTER.**

The display for programming appears.

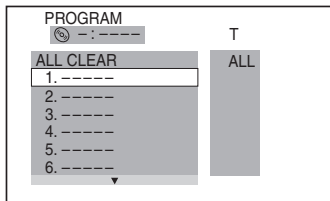

**4 Press  $\rightarrow$ .**

The player is ready to program the first disc.

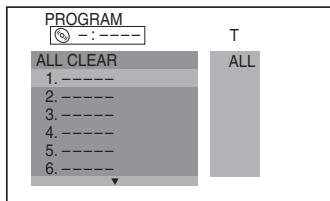

**5 Select the disc you want to program using the number buttons or  $\uparrow/\downarrow$ , then press ENTER.**

The cursor moves to the title or track row "T" (in this case, "01").

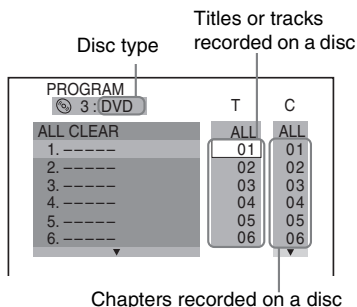

"?" appears when the player has not played the disc.

**6 Select the title, chapter, or track you want to program.**

**◆ When playing a DVD VIDEO**

For example, select chapter "03" of title "02."

Press  $\uparrow/\downarrow$  or the number buttons to select "02" under "T," then press ENTER.

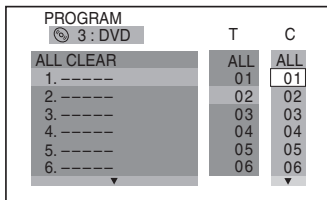

Next, press  $\uparrow/\downarrow$  or the number buttons to select "03" under "C," then press ENTER.

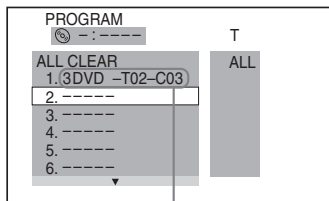

Selected disc, title and chapter

**◆ When playing a VIDEO CD or CD**

For example, select track "02."

Press  $\uparrow/\downarrow$  or the number buttons to select "02" under "T," then press ENTER.

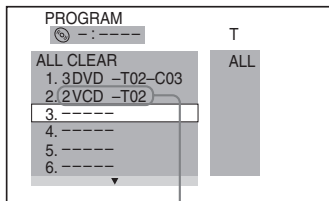

Selected disc and track

**7 To program other discs, titles, chapters, or tracks, repeat steps 4 to 6.**

The programmed discs, titles, chapters, and tracks are displayed in the selected order.

## 8 Press $\triangleright$ to start Program Play.

Program Play begins.

When the program ends, you can restart the same program again by pressing  $\triangleright$ .

### To stop Program Play

Press CLEAR or select "OFF" in Step 3.

### To turn off the display

Press DISPLAY repeatedly until the display is turned off.

### To cancel or change a program

- 1 Follow steps 1 and 2 of "Creating your own program (Program Play)."
- 2 Select the program number of the disc, title, chapter, or track you want to cancel or change using  $\uparrow/\downarrow$  or the number buttons, and press  $\rightarrow$ .
- 3 To cancel the program, press  $\leftarrow$  then CLEAR.  
To change the program, follow step 4 for new programming.

### To cancel all the discs, titles, chapters, or tracks in the program

- 1 Follow steps 1 and 2 of "Creating your own program (Program Play)."
- 2 Press  $\uparrow$  and select "ALL CLEAR."
- 3 Press ENTER.

#### Hint

You can do Repeat Play or Shuffle Play of the programmed titles, chapters, or tracks. During Program Play, follow the steps of "Repeat Play" (page 39) or "Shuffle Play" (page 38).

#### Notes

- You cannot use this function with VIDEO CDs with PBC playback.
- When playing Super VCDs, the total time of the programmed tracks does not appear on the screen.

## Playing in random order (Shuffle Play) **DVD-V** **DVD-RW** **VCD** **CD** **DATA CD**

You can have the player "shuffle" titles, chapters, or tracks. Subsequent "shuffling" may produce a different playing order. By selecting All Discs mode (page 36), you can shuffle all of the discs in the player.

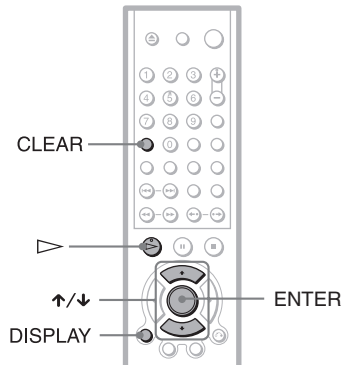

- 1 Press DISPLAY twice during playback (when playing a DATA CD, press once).  
The Control Menu appears.
- 2 Press  $\uparrow/\downarrow$  to select  (SHUFFLE), then press ENTER.  
The options for "SHUFFLE" appear.

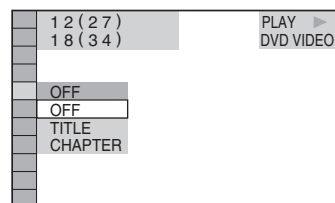

- 3 Press  $\uparrow/\downarrow$  to select the item to be shuffled.
  - ◆ When playing a DVD VIDEO
    - DISC\*
    - TITLE
    - CHAPTER
  - ◆ When playing a VIDEO CD or CD
    - DISC\*
    - TRACK
  - ◆ When playing a DVD-RW or DATA CD
    - DISC\*
  - ◆ When Program Play is activated
    - ON: shuffles titles, chapters, or tracks selected in Program Play.

## 4 Press ENTER.

Shuffle Play starts.

\* You can select "DISC" in All Discs mode only.

### To return to normal play

Press CLEAR, or select "OFF" in step 2.

### To turn off the control menu

Press DISPLAY repeatedly until the Control Menu is turned off.

#### Hints

- You can set Shuffle Play while the player is stopped. After selecting the "SHUFFLE" option, press . Shuffle Play starts.
- Up to 96 chapters in a disc can be played in random order when "CHAPTER" is selected.

#### Note

You cannot use this function with VIDEO CDs with PBC playback.

## Playing repeatedly (Repeat Play)

**DVD-V   DVD-RW   VCD   CD   DATA CD**

You can play all of the titles, albums or tracks on a disc or a single title, chapter, album, or track repeatedly.

You can use a combination of Shuffle or Program Play modes. By selecting All Discs mode (page 36), you can repeat all of the discs in the player.

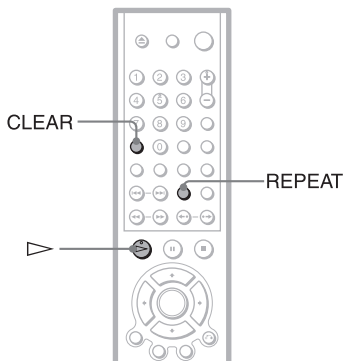

## 1 Press REPEAT during playback.

The following display appears.

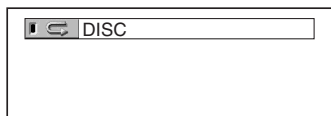

## 2 Press REPEAT repeatedly to select the item to be repeated.

#### ◆ When playing a DVD VIDEO

- DISC: repeats all of the titles on the current disc in One Disc mode, or all of the discs in All Discs mode.
- TITLE: repeats the current title on a disc.
- CHAPTER: repeats the current chapter.

#### ◆ When playing a DVD-RW

- DISC: repeats all of the titles on the selected type in One Disc mode, or all of the discs in All Discs mode.
- TITLE: repeats the current title on a disc.
- CHAPTER: repeats the current chapter.

#### ◆ When playing a VIDEO CD or CD

- DISC: repeats all of the tracks on the current disc in One Disc mode, or all of the discs in All Discs mode.
- TRACK: repeats the current track.

#### ◆ When playing a DATA CD (MP3 audio)

- DISC: repeats all of the albums on the current disc in One Disc mode, or all of the discs in All Discs mode.
- ALBUM: repeats the current album.
- TRACK: repeats the current track.

#### ◆ When Program Play or Shuffle Play is activated

- ON: repeats Program Play or Shuffle Play.

### To return to normal play

Press CLEAR, or select "OFF" in step 2.

#### Hints

- You can set Repeat Play while the player is stopped. After selecting the "REPEAT" option, press . Repeat Play starts.
- You can also select "REPEAT" from the Control Menu (page 12).

#### Note

You cannot use this function with VIDEO CDs with PBC playback.

## Repeating a specific portion (A-B Repeat Play) DVD-V DVD-RW VCD

**CD**

You can play a specific portion of a title, chapter or track repeatedly. (This function is useful when you want to memorize lyrics, etc.)

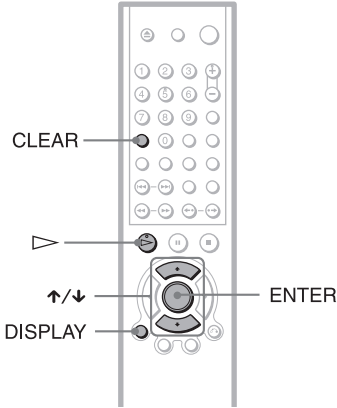

### 1 Press DISPLAY twice during playback.

The Control Menu appears.

### 2 Press $\uparrow/\downarrow$ to select **A-B REPEAT**, then press ENTER.

The options for "A-B REPEAT" appear.

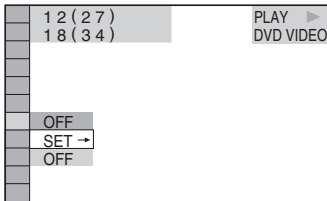

### 3 Press $\uparrow/\downarrow$ to select "SET $\rightarrow$ ," then press ENTER.

The "A-B REPEAT" setting display appears.

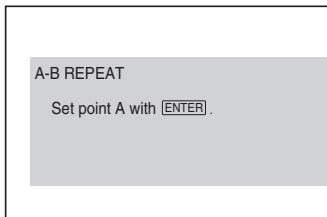

### 4 During playback, when you find the starting point (point A) of the portion to be played repeatedly, press ENTER.

The starting point (point A) is set.

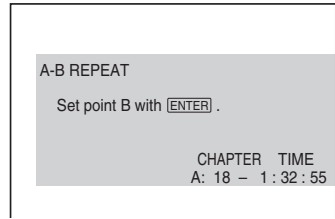

### 5 When you reach the ending point (point B), press ENTER again.

The set points are displayed and the player starts repeating this specific portion.

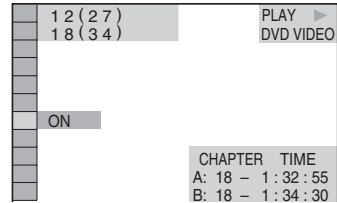

### To return to normal play

Press CLEAR.

### To turn off the Control Menu

Press DISPLAY repeatedly until the Control Menu is turned off.

### Notes

- When you set A-B Repeat Play, the settings for Shuffle Play, Repeat Play, and Program Play are canceled.
- A-B Repeat Play does not work for titles containing still pictures on a DVD-RW in VR mode.
- A-B Repeat Play does not work across multiple titles ("ORIGINAL" or "PLAY LIST") on a DVD-RW in VR mode.



## Searching for a Scene

### Searching for a Particular Point on a Disc (Scan, Slow-motion Play, Search, Freeze Frame)

You can quickly locate a particular point on a disc by monitoring the picture or playing back slowly.

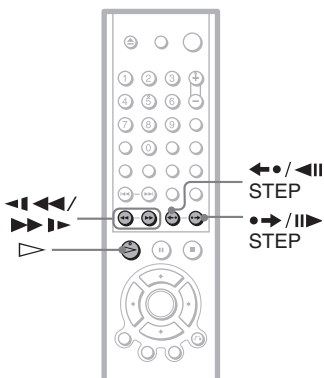
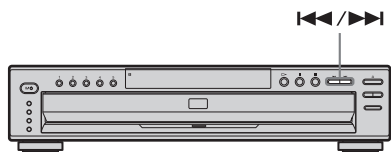

#### Note

Depending on the DVD/VIDEO CD, you may not be able to do some of the operations described.

### Locating a point quickly by playing a disc in fast forward or fast reverse (Scan) DVD-V DVD-RW VCD CD DATA CD

Press **◀◀** or **▶▶** while playing a disc. When you find the point you want, press **▷** to return to normal speed. Each time you press **◀◀** or **▶▶** during scan, the playback speed changes. With each press the indication changes as shown below. Actual speeds may differ with some discs.

#### Playback direction

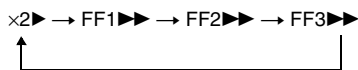

FF3▶▶▶▶▶ (DVD VIDEO/DVD-RW/VIDEO CD only)

×2▶▶ (DVD VIDEO/CD only)

#### Opposite direction

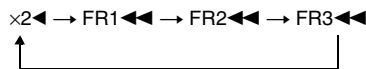

FR3◀◀◀◀◀ (DVD VIDEO/DVD-RW/VIDEO CD only)

×2◀◀ (DVD VIDEO only)

The “×2▶▶”/“×2◀◀” playback speed is about twice the normal speed. The “FF3▶▶▶▶▶”/“FR3◀◀◀◀◀” playback speed is faster than the “FF2▶▶▶▶▶”/“FR2◀◀◀◀◀” and the “FF2▶▶▶▶▶”/“FR2◀◀◀◀◀” playback speed is faster than “FF1▶▶▶▶▶”/“FR1◀◀◀◀◀”.

### Watching frame by frame (Slow-motion play) DVD-V DVD-RW VCD

Press **◀◀** or **▶▶** when the player is in pause mode. To return to the normal speed, press **▷**.

Each time you press **◀◀** or **▶▶** during Slow-motion play, the playback speed changes. Two speeds are available. With each press the indication changes as follows:

#### Playback direction

SLOW2▶▶ ↔ SLOW1▶▶

#### Opposite direction (DVD only)

SLOW2◀◀ ↔ SLOW1◀◀

The “SLOW2▶▶”/“SLOW2◀◀” playback speed is slower than “SLOW1▶▶”/“SLOW1◀◀”.

### To locate a point quickly using the PREV (previous) / Next (next) button (Search) DVD-V DVD-RW VCD CD DATA CD

You can search for a particular point on a disc using **◀◀** / **▶▶** on the player. During playback, press and hold **▶▶** on the player to locate a point in the playback direction, or press and hold **◀◀** to locate a point in the opposite direction. When you find the point you want, release the button to return to normal playback speed.

## Playing one frame at a time

(Freeze Frame) **DVD-V** **DVD-RW** **VCD**

When the player is in the pause mode, press **•→/II▶** to go to the next frame. Press **←•/◀II** to go to the preceding frame (DVD only). If you hold the button down, you can view the frames in succession. To return to normal playback, press **▷**.

## Searching for a Title/Chapter/Track/Scene, etc.

**DVD-V** **DVD-RW** **VCD** **CD**

**DATA CD**

You can search a DVD by title or chapter, and you can search a VIDEO CD/CD by track, index, or scene. As titles and DATA CD tracks are assigned unique numbers on the disc, you can select the desired one by entering its number. Or, you can search for a scene using the time code.

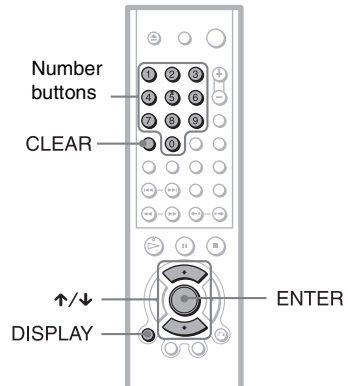





### 1 Press DISPLAY.

The Control Menu appears.



### 2 Press **↑/↓** to select the search method.

#### ◆ When playing a DVD VIDEO/DVD-RW

-  DISC
-  TITLE
-  CHAPTER
-  TIME/TEXT

Select "TIME/TEXT" to search for a starting point by inputting the time code.

#### ◆ When playing a VIDEO CD without PBC Playback

-  DISC
-  TRACK
-  INDEX

### ◆ When playing a VIDEO CD with PBC Playback



### ◆ When playing a CD



### ◆ When playing a DATA CD (MP3 audio)



Example: when you select  CHAPTER

“\*\* (\*\*)” is selected (\*\* refers to a number). The number in parentheses indicates the total number of titles, chapters, tracks, indexes or scenes.

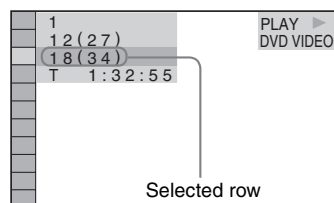

### 3 Press ENTER.

“\*\* (\*\*)” changes to “-- (\*\*).”

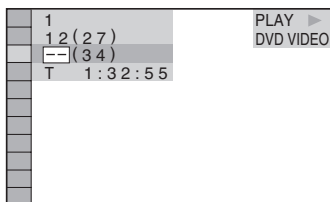

### 4 Press ↑/↓ or the number buttons to select the title, chapter, track, index, or scene number you want to search.

#### If you make a mistake

Cancel the number by pressing CLEAR, then select another number.

#### If you make a mistake

Cancel the number by pressing CLEAR, then select another number.

### 5 Press ENTER.

The player starts playback from the selected number.

### To search for a scene using the time code (DVD VIDEO/DVD-RW only)

- In Step 2, select  TIME/TEXT. “T \*\*:\*\*:\*\*” (playing time of the current title) is selected.
- Press ENTER. “T \*\*:\*\*:\*\*” changes to “T --:--:--”.
- Input the time code using the number buttons, then press ENTER. For example, to find the scene at 2 hours, 10 minutes, and 20 seconds after the beginning, just enter “2:10:20.”

#### 🔧 Hints

- When the display is turned off you can search for a chapter (DVD VIDEO/DVD-RW) or track (CD) by pressing the number buttons and ENTER.
- You can display the first scene of titles, chapters or tracks recorded on the disc on a screen divided into 9 sections. You can start playback directly by selecting one of the scenes. For details, see “Searching by Scene (PICTURE NAVIGATION)” (page 44).

#### Notes

- You cannot search for a scene on a DVD+RW using the time code.
- The title, chapter or track number displayed is the same number recorded on the disc.
- You cannot search for a still picture on a DVD-RW in VR mode.

# Searching by Scene

(PICTURE NAVIGATION) **DVD-V** **VCD**

You can divide the screen into 9 subscreens and find the desired scene quickly.

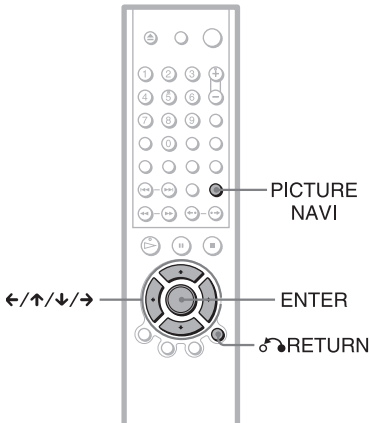

## 1 Press PICTURE NAVI during playback.

The following display appears.

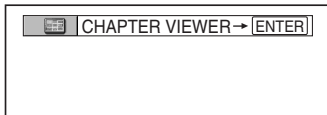

## 2 Press PICTURE NAVI repeatedly to select the item.

- Refer to the explanations given for each item in the following sections.
- CHAPTER VIEWER (for DVD VIDEO only)
- TITLE VIEWER (for DVD VIDEO only)
- TRACK VIEWER (for VIDEO CD only)

## 3 Press ENTER.

**To return to normal play**

Press RETURN.

### Hint

You can also select "PICTURE NAVIGATION" from the Control Menu (page 12).

### Notes

- The "PICTURE NAVIGATION" is not available when playing Super VCDs.
- Depending on the disc, you may not be able to select all functions.
- The sound is muted when using this function.

## Scanning the title, chapter, or track (TITLE VIEWER, CHAPTER VIEWER, TRACK VIEWER)

**DVD-V** **VCD**

You can divide the screen into 9 subscreens and display the first scene of titles, chapters, or tracks.

You can also play back from the selected title, chapter, or track. After performing step 3 of "Searching by Scene (PICTURE NAVIGATION)" above, select the scene using ←/↑/↓/→ and press ENTER.

### Hint

If there are more than 9 titles, chapters, or tracks, ▼ is displayed at the bottom right.

To display the additional titles, chapters, or tracks, select the bottom right scene (the position 9) and press ↓. To return to the previous scene, select the top left scene (the position 1) and press ↑.

1	2	3	
4	5	6	
7	8	9	▼

## Viewing Information About the Disc

## Checking the Playing Time and Remaining Time

**Time** DVD-V DVD-RW VCD CD

## DATA CD

You can check the playing time and remaining time of the current title, chapter, or track. Also, you can check the DVD/CD text or track name (MP3 audio) recorded on the disc.

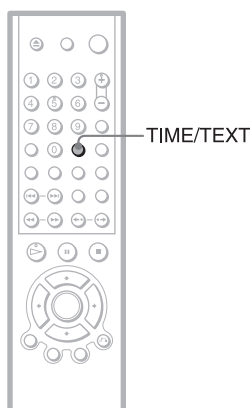

## 1 Press TIME/TEXT during playback.

The following display appears.

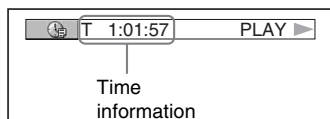

## 2 Press TIME/TEXT repeatedly to change the time information.

The display and the kinds of time that you can change depend on the disc you are playing.

### ◆ When playing a DVD VIDEO or DVD-RW

- T \*\*:\*: Playing time of the current title
- T- \*\*:\*: Remaining time of the current title
- C \*\*:\*: Playing time of the current chapter
- C- \*\*:\*: Remaining time of the current chapter

### ◆ When playing a VIDEO CD (with PBC functions)

- \*\*:\*( minutes : seconds) Playing time of the current scene

### ◆ When playing a VIDEO CD (without PBC functions) or CD

- T \*\*:\*( minutes : seconds) Playing time of the current track
- T- \*\*:\*( minutes : seconds) Remaining time of the current track
- D \*\*:\*( minutes : seconds) Playing time of the current disc
- D- \*\*:\*( minutes : seconds) Remaining time of the current disc

### ◆ When playing a DATA CD (MP3 audio)

- \*\*:\*( minutes : seconds) Playing time of the current track

### ◆ When playing a Super VCD

- T \*\*:\*( minutes : seconds) Playing time of the current track

### To check the DVD/CD text or track and album names (MP3 audio)

Press TIME/TEXT repeatedly in step 2 to display text recorded on the DVD VIDEO/CD/DATA CD.

The DVD/CD text appears only when text is recorded in the disc. You cannot change the text. If the disc does not contain text, "NO TEXT" appears.

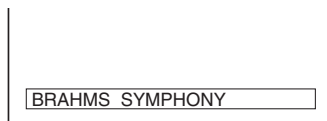

For DATA CDs, the track and album names of the MP3 audio track appears (page 48).

## Checking the information on the front panel display

You can view the time information and text displayed on the TV screen also on the front panel display. The information on the front panel display changes as follows when you change the time information on your TV screen.

### When playing a DVD VIDEO or DVD-RW

Playing time of the current title

5 DVD { T 10324



Remaining time of the current title

5 DVD { T- 11536



Playing time of the current chapter

5 DVD { C 02230



Remaining time of the current chapter

5 DVD { C-0 1320



Text

5 DVD { BRAHMS



Current title and chapter number

5 DVD { T 16 8

(returns to top automatically)

### When playing a DATA CD (MP3 audio)

Track playing time and number of current disc track

4 CD MP3 { 50 225



Track time

4 CD MP3 { ROCK 17

### When playing a VIDEO CD (without PBC functions) or CD

Track playing time and current disc track number

3 VCD { 2 225



Remaining time of the current track

3 VCD { 2 - 150



Playing time of the current disc

3 VCD { 32:12



Remaining time of the disc

3 VCD { -20:18



Text

3 VCD { BRAHMS

### Hints

- When playing VIDEO CDs with PBC functions, the disc number, scene number and the playing time are displayed.
- Long text that does not fit in a single line will scroll across the front panel display.
- You can also check the time information and text using the Control Menu (page 12).

### Notes

- Depending on the type of disc being played, the DVD/CD text or track name may not be displayed.
- The player can only display the first level of the DVD/CD text, such as the disc name or title.
- Playing time of MP3 audio tracks may not be displayed correctly.

# Checking the Play Information

You can check information such as the bit rate or the disc layer that is being played.

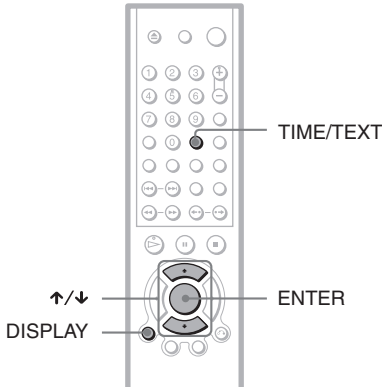

## Checking the play information of DVD (ADVANCED) **DVD-V** **DVD-RW**

- 1 Press DISPLAY during playback.**  
The Control Menu is displayed.
- 2 Press ↑/↓ to select [ ] (ADVANCED), then press ENTER.**  
The options for "ADVANCED" appear.

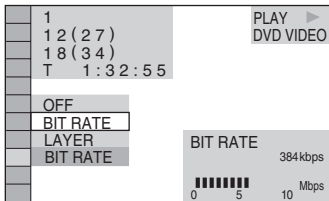

- 3 Press ↑/↓ to select items.**  
For each item, please refer to "Displays of each item."  
  - BIT RATE: displays the bit rate.
  - LAYER: displays the layer and the pick-up point.

- 4 Press ENTER.**

### To close the ADVANCED window

Select "OFF" in step 3.

### To turn off the Control Menu

Press DISPLAY repeatedly until the Control Menu is turned off.

### Display of each item

By pressing DISPLAY repeatedly, you can display either "BIT RATE" or "LAYER," whichever was selected in "ADVANCED."

#### ◆BIT RATE

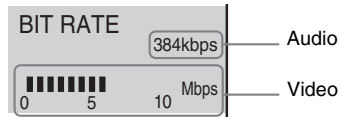

Bit rate refers to the amount of video/audio data per second in a disc. While playing a disc, an approximate bit rate of the playback picture is displayed as Mbps (Mega bit per second) and the audio as kbps (kilo bit per second). The higher the bit rate, the larger the amount of data. However, this does not always mean that you can get higher quality pictures or sounds.

#### ◆LAYER

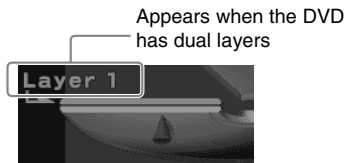

Indicates the approximate point where the disc is playing.  
If it is a dual-layer DVD, the player indicates which layer is being read ("Layer 0" or "Layer 1").  
For details on the layers, see page 72 (DVD VIDEO).

## Checking the play information of DATA CD

By pressing TIME/TEXT while playing MP3 audio track on a DATA CD, you can display the audio bit rate (the amount of data per second of the current audio).

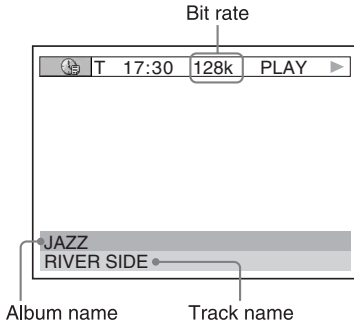



## Sound Adjustments

Changing the Sound **DVD-V****DVD-RW** **VCD** **CD** **DATA CD**

When playing a DVD recorded in multiple audio formats (PCM, Dolby Digital or DTS), you can change the audio format. If the DVD is recorded with multilingual tracks, you can also change the language.

With CDs, DATA CDs, or VIDEO CDs, you can select the sound from the right or left channel and listen to the sound of the selected channel through both the right and left speakers. For example, when playing a disc containing a song with the vocals on the right channel and the instruments on the left channel, you can hear the instruments from both speakers by selecting the left channel.

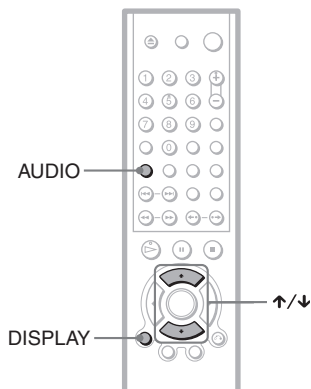

## 1 Press AUDIO during playback.

The following display appears.

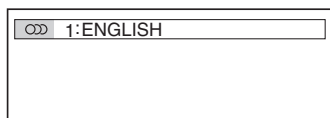

## 2 Press AUDIO repeatedly to select the desired audio signal.

### ◆ When playing a DVD VIDEO

Depending on the DVD VIDEO, the choice of language varies.

When 4 digits are displayed, they indicate a language code. Refer to "Language Code List" on page 75 to see which language the code represents. When the same language is displayed two or more times, the DVD VIDEO is recorded in multiple audio formats.

### ◆ When playing a DVD-RW

The types of sound tracks recorded on a disc are displayed. The default setting is underlined.

Example:

- 1: MAIN (main sound)
- 1: SUB (sub sound)
- 1: MAIN+SUB (main and sub sound)

### ◆ When playing a VIDEO CD, CD, or DATA CD (MP3 audio)

The default setting is underlined.

- STEREO: The standard stereo sound
- 1/L: The sound of the left channel (monaural)
- 2/R: The sound of the right channel (monaural)

### ◆ When playing a Super VCD

The default setting is underlined.

- 1:STEREO: The stereo sound of the audio track 1
- 1:1/L: The sound of the left channel of the audio track 1 (monaural)
- 1:2/R: The sound of the right channel of the audio track 1 (monaural)
- 2:STEREO: The stereo sound of the audio track 2
- 2:1/L: The sound of the left channel of the audio track 2 (monaural)
- 2:2/R: The sound of the right channel of the audio track 2 (monaural)

### 💡 Hint

You can also select "AUDIO" from the Control Menu (page 12).

### Note

While playing a Super VCD on which the audio track 2 is not recorded, no sound will come out when you select "2:STEREO", "2:1/L" or "2:2/R".

## Displaying the audio information of the disc **DVD-V**

Press DISPLAY during playback to display the Control Menu. Select "AUDIO" using  $\uparrow/\downarrow$ . The channels being played are displayed on the screen.

For example, in Dolby Digital format, multiple signals ranging from monaural to 5.1 channel signals can be recorded on a DVD VIDEO. Depending on the DVD VIDEO, the number of the recorded channels may differ.

Current audio format\*

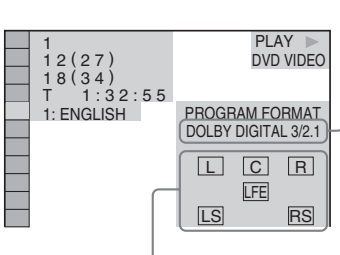

Currently playing program format\*\*

\*"PCM," "DTS," or "DOLBY DIGITAL" is displayed.

In the case of "DOLBY DIGITAL," the channels in the playing track are displayed by numbers as follows:

For Dolby Digital 5.1 ch:

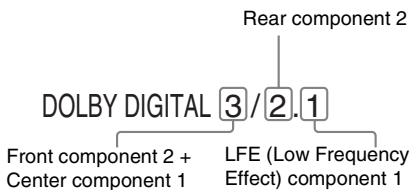

\*\*The letters in the program format display mean the following sound component:

- L: Front (left)
- R: Front (right)
- C: Center
- LS: Rear (left)
- RS: Rear (right)
- S: Rear (monaural): The rear component of the Dolby Surround processed signal and the Dolby Digital signal
- LFE: Low Frequency Effect signal

### Hint

For Dolby Digital and DTS, "LFE" is always enclosed in a solid line regardless of the LFE signal component being output.

### **Note**

If "DTS" is set to "OFF" in "AUDIO SETUP" (page 68), the DTS track selection option will not appear on the screen even if the disc contains DTS tracks.

# TV Virtual Surround Settings (TVS) **DVD-V**

When you connect a stereo TV or 2 front speakers, TVS (TV Virtual Surround) lets you enjoy surround sound effects by using sound imaging to create virtual rear speakers from the sound of the front speakers (L: left, R: right) without using actual rear speakers. TVS was developed by Sony to produce surround sound for home use using just a stereo TV.

If the player is set up to output the signal from the DIGITAL OUT (COAXIAL or OPTICAL) jack, the surround effect will only be heard when "DOLBY DIGITAL" is set to "D-PCM" (page 68).

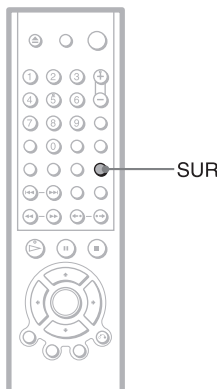

## 1 Press SUR during playback.

The following display appears.

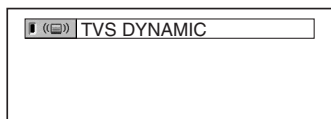

## 2 Press SUR repeatedly to select one of the TVS sounds.

Refer to the following explanations given for each item.

- TVS DYNAMIC
- TVS WIDE
- TVS NIGHT
- TVS STANDARD

### To cancel the setting

Select "OFF" in step 2.

#### ◆TVS DYNAMIC

Creates virtual rear speakers from the sound of the front speakers (L, R) without using actual rear speakers (shown below).

This mode is effective when the distance between the front L and R speakers is short, such as with built-in speakers on a stereo TV.

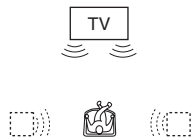

#### ◆TVS WIDE

Creates virtual rear speakers from the sound of the front speakers (L, R) without using actual rear speakers. The virtual speakers are reproduced as shown in the illustration below.

This mode is effective when the distance between the front L and R speakers is short, such as with built-in speakers on a stereo TV.

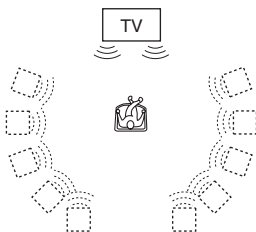

#### ◆TVS NIGHT

Large sounds, such as explosions, are suppressed, but the quieter sounds are unaffected. This feature is useful when you want to hear the dialog and enjoy the surround sound effects of "TVS WIDE" at low volume.

## ◆TVS STANDARD

Creates virtual rear speakers from the sound of the front speakers (L, R) without using actual rear speakers. The virtual speakers are reproduced as shown in the illustration below. Use this setting when you want to use TVS with 2 separate speakers.

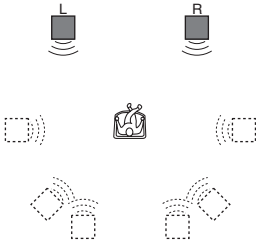

L : Front speaker (left)  
R : Front speaker (right)  
□ : Virtual speaker

### 💡 Hints

- You can also select “TVS” by pressing the SURROUND button on the player.
- You can also select “TVS” from the Control Menu (page 12).

### Notes

- When the playing signal does not contain a signal for the rear speakers, the surround effects cannot be heard.
- When you select one of the TVS modes, turn off the surround setting of the connected TV or amplifier (receiver).
- Make sure that your listening position is between and at an equal distance from your speakers, and that the speakers are located in similar surroundings.
- Not all discs will respond to the “TVS NIGHT” function in the same way.

## Changing the Angles

### DVD-V

If various angles (multi-angles) for a scene are recorded on the DVD VIDEO, “” appears in the front panel display. This means that you can change the viewing angle.

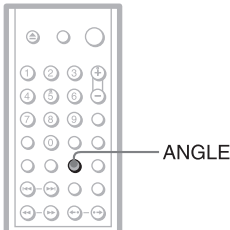

### 1 Press ANGLE during playback.

The number of the angle appears on the display.



### 2 Press ANGLE repeatedly to select the angle number.

The scene changes to the selected angle.

#### Hint

You can also select “ANGLE” from the Control Menu (page 12).

#### Note

Depending on the DVD VIDEO, you may not be able to change the angles even if multi-angles are recorded on the DVD VIDEO.

## Displaying the Subtitles

### DVD-V DVD-RW

If subtitles are recorded on the discs, you can change the subtitles or turn them on and off whenever you want while playing a DVD.

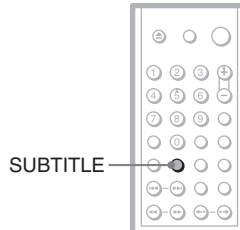

### 1 Press SUBTITLE during playback.

The following display appears.

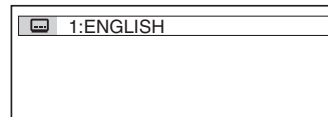

### 2 Press SUBTITLE repeatedly to select the language.

#### ◆ When playing a DVD VIDEO

Select the language.

Depending on the DVD VIDEO, the choice of language varies.

When 4 digits are displayed, they indicate a language code. Refer to “Language Code List” on page 75 to see which language the code represents.

#### ◆ When playing a DVD-RW

Select “ON.”

### To turn off the subtitles

Select “OFF” in step 2.

#### Hint

You can also select “SUBTITLE” from the Control Menu (page 12).

#### Note

Depending on the DVD VIDEO, you may not be able to change the subtitles even if multilingual subtitles are recorded on it. You also may not be able to turn them off.

# Adjusting the Picture Quality (BNR) **DVD-V** **DVD-RW**

## **VCD**

The Block Noise Reduction (BNR) function adjusts the picture quality by reducing the “block noise” or mosaic like patterns that appear on your TV screen.

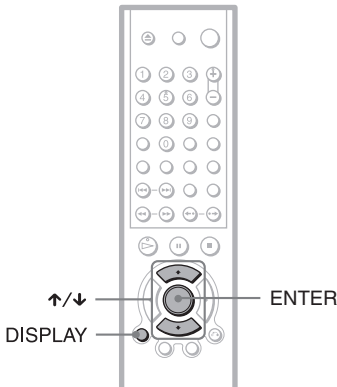

### **1 Press DISPLAY twice during playback.**

The Control Menu appear.

### **2 Press ↑/↓ to select (BNR), then press ENTER.**

The options for “BNR” appears.

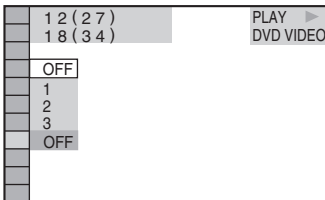

### **3 Press ↑/↓ to select a level.**

- 1: reduces the “block noise.”
- 2: reduces the “block noise” more than 1.
- 3: reduces the “block noise” more than 2.

### **4 Press ENTER.**

The disc plays with the setting you selected.

#### **To cancel the “BNR” setting**

Select “OFF” in step 3.

#### **To turn off the Control Menu**

Press DISPLAY repeatedly until the Control Menu is turned off.

#### **Notes**

- If the outlines of the images on your screen should become blurred, set “BNR” to “OFF.”
- Depending on the disc or the scene being played, there may be no “BNR” effect, or it may be hard to discern.

# Adjusting the Playback Picture (CUSTOM PICTURE MODE)

**DVD-V DVD-RW VCD**

You can adjust the video signal of the DVD or VIDEO CD from the player to obtain the picture quality you want. Choose the setting that best suits the program you are watching. When you select “MEMORY,” you can make further adjustments to each element of the picture (color, brightness, etc.).

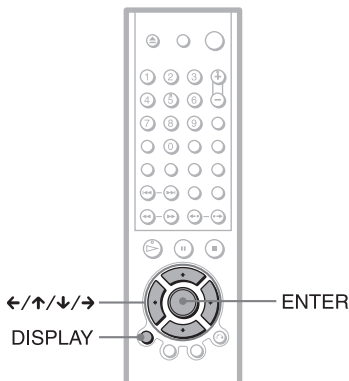

## 1 Press DISPLAY twice during playback.

The Control Menu appears.

## 2 Press </>/</> to select , then press ENTER.

The options for “CUSTOM PICTURE MODE” appears.

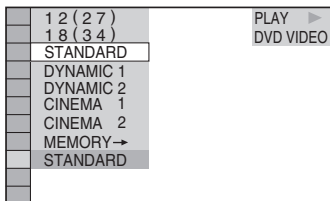

## 3 Press </>/</> to select the setting you want, then press ENTER.

The default setting is underlined.

- **STANDARD**: displays a standard picture.
- **DYNAMIC 1**: produces a bold dynamic picture by increasing the picture contrast and the color intensity.
- **DYNAMIC 2**: produces a more dynamic picture than DYNAMIC 1 by further increasing the picture contrast and the color intensity.
- **CINEMA 1**: enhances details in dark areas by increasing the black level.
- **CINEMA 2**: White colors become brighter and black colors become richer, and the color contrast is increased.
- **MEMORY**: adjusts the picture in greater detail.

### Hints

- When you watch a movie, “CINEMA 1” or “CINEMA 2” is recommended.
- The picture can be adjusted by pressing the PICTURE MODE button on the player as well.

## Adjusting the picture items in “MEMORY”

You can adjust each element of the picture individually.

- **PICTURE:** changes the contrast
- **BRIGHTNESS:** changes the overall brightness
- **COLOR:** makes the colors deeper or lighter
- **HUE:** changes the color balance

### 1 Press **↑/↓** to select “MEMORY” then press **ENTER**.

The “PICTURE” adjustment bar appears.



### 2 Press **←/→** to adjust the picture contrast, then press **ENTER**.

The adjustment is saved, and “BRIGHTNESS” adjustment bar appears.

### 3 Repeat step 2 to adjust “BRIGHTNESS,” “COLOR,” and “HUE.”

The Custom Picture Mode display appears. You can check each adjustment.

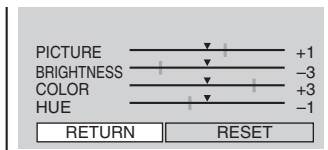

## To turn off the display

Press **↶** RETURN, or select “RETURN” in step 3 and press **ENTER**.

### Hints

- To reset the picture items to the default values, press **→** after step 3 to select “RESET” and press **ENTER**.
- If you do not want to save your adjustment in step 2, you can go to the next picture adjustment item by pressing **↑/↓** without saving.

## Enhancing the Playback Picture (DIGITAL VIDEO

### ENHANCER) DVD-V DVD-RW VCD

The Digital Video Enhancer (DVE) function makes the picture appear clear and crisp by enhancing the outlines of images on your TV screen. Also, this function can soften the images on the screen.

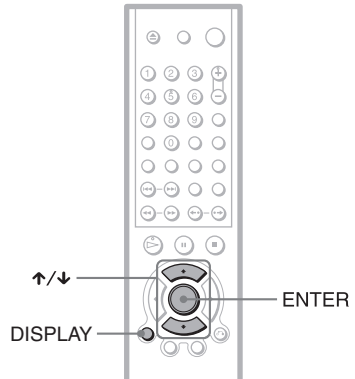

### 1 Press **DISPLAY** twice during playback.

The Control Menu appears.

### 2 Press **↑/↓** to select (DIGITAL VIDEO ENHANCER), then press **ENTER**.

The options for “DIGITAL VIDEO ENHANCER” appear.

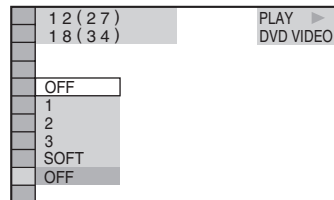

### 3 Press **↑/↓** to select a level.

- 1: enhances the outline.
- 2: enhances the outline more than 1.
- 3: enhances the outline more than 2.
- SOFT: softens the image (DVD only)



## **4** Press ENTER.

The disc plays with the setting you selected.

---

### **To cancel the “DIGITAL VIDEO ENHANCER” setting**

Select “OFF” in step 3.

### **To turn off the Control Menu**

Press DISPLAY repeatedly until the Control Menu is turned off.

#### **Note**

Depending on the disc or the scene being played, noise found in the disc may become more apparent. If this happens, it is recommended that you use the BNR function (page 54) with the DVE function. If the condition still does not improve, reduce the Digital Video Enhancer level, or select “SOFT” (DVD only) in step 3 above.

## Locking Discs (CUSTOM PARENTAL CONTROL, PARENTAL CONTROL)

You can set two kinds of playback restrictions for the desired disc.

- Custom Parental Control  
You can set playback restrictions so that the player will not play inappropriate discs.
- Parental Control  
Playback of some DVD VIDEOS can be limited according to a predetermined level such as the age of the users. Scenes may be blocked or replaced with different scenes. The same password is used for both Parental Control and Custom Parental Control.

### Custom Parental Control

DVD-V VCD CD

You can set the same Custom Parental Control password for up to 40 discs. When you set the 41st-disc, the first disc is canceled.

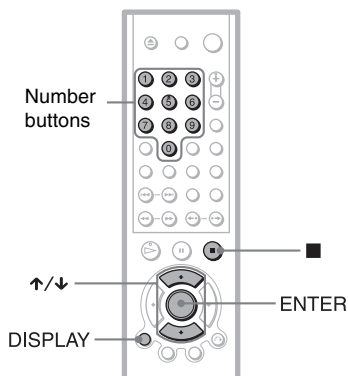

- 1 Insert the disc you want to lock.**  
If the disc is playing, press ■ to stop playback.
- 2 Press DISPLAY while the player is in stop mode.**  
The Control Menu appears.

- 3 Press ↑/↓ to select (PARENTAL CONTROL), then press ENTER.**

The options for "PARENTAL CONTROL" appear.

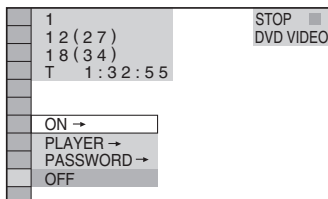

- 4 Press ↑/↓ to select "ON →," then press ENTER.**

◆ **If you have not entered a password**  
The display for registering a new password appears.

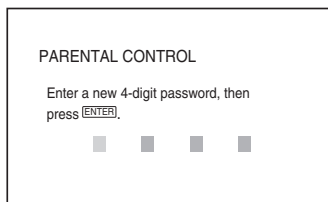

Enter a 4-digit password using the number buttons, then press ENTER. The display for confirming the password appears.

◆ **When you have already registered a password**  
The display for entering the password appears.

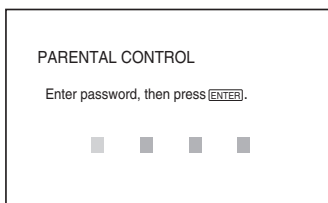

- 5 Enter or re-enter your 4-digit password using the number buttons, then press ENTER.**

"Custom parental control is set." appears and the screen returns to the Control Menu.

## To turn off the Custom Parental Control function

- 1 Follow steps 1 through 3 of “Custom Parental Control.”
- 2 Press  $\uparrow/\downarrow$  to select “OFF  $\rightarrow$ ,” then press ENTER.
- 3 Enter your 4-digit password using the number buttons, then press ENTER.

## To play a disc for which Custom Parental Control is set

- 1 Insert the disc for which Custom Parental Control is set. The “CUSTOM PARENTAL CONTROL” display appears.

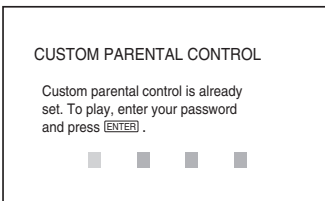

- 2 Enter your 4-digit password using the number buttons, then press ENTER. The player is ready for playback.

### Hint

If you forget your password, enter the 6-digit number “199703” using the number buttons when the “CUSTOM PARENTAL CONTROL” display asks you for your password, then press ENTER. The display will ask you to enter a new 4-digit password.

### Note

Once you set Custom Parental Control with a recorded disc such as a DVD-RW, the display for entering the password may appear again when you insert a different recorded disc. Input the password to play the disc.

## Parental Control (limited playback) **DVD-V**

Playback of some DVD VIDEOS can be limited according to a predetermined level such as the age of the users. The “PARENTAL CONTROL” function allows you to set a playback limitation level.

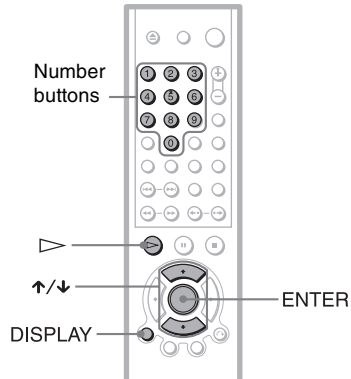

- 1 Press DISPLAY while the player is in stop mode. The Control Menu appears.

- 2 Press  $\uparrow/\downarrow$  to select (PARENTAL CONTROL), then press ENTER.

The options for “PARENTAL CONTROL” appear.

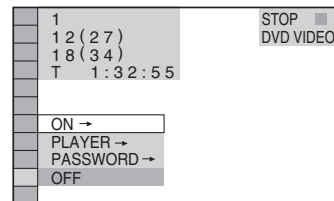

- 3 Press  $\uparrow/\downarrow$  to select “PLAYER  $\rightarrow$ ,” then press ENTER.

◆ If you have not entered a password  
The display for registering a new password appears.

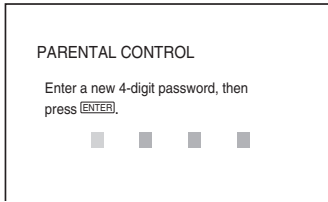

Enter a 4-digit password using the number buttons, then press ENTER. The display for confirming the password appears.

◆ **When you have already registered a password**

The display for entering the password appears.

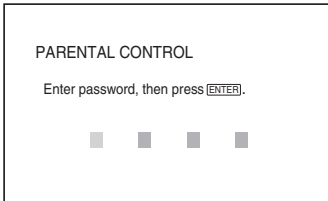

**4 Enter or re-enter your 4-digit password using the number buttons, then press ENTER.**

The display for setting the playback limitation level appears.

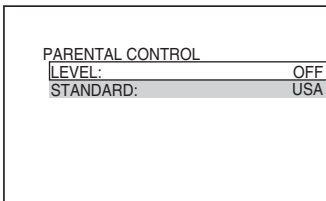

**5 Press ↑/↓ to select “STANDARD,” then press ENTER.**

The selection items for “STANDARD” are displayed.

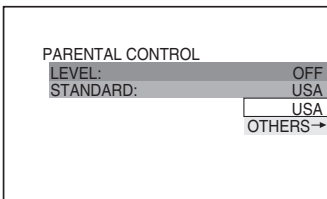

**6 Press ↑/↓ to select a geographic area as the playback limitation level, then press ENTER.**

The area is selected.

When you select “OTHERS →,” select and enter a standard code in the table on page 61.

**7 Press ↑/↓ to select “LEVEL,” then press ENTER.**

The selection items for “LEVEL” are displayed.

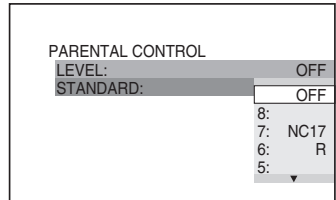

**8 Select the level you want using ↑/↓, then press ENTER.**

Parental Control setting is complete.

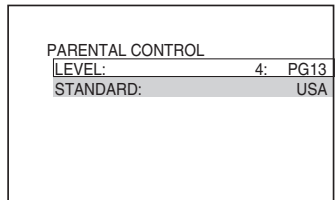

The lower the value, the stricter the limitation.

**To turn off the Parental Control function**

Set “LEVEL” to “OFF” in step 8.

**To play a disc for which Parental Control is set**

- 1** Insert the disc and press ▷. The display for entering your password appears.
- 2** Enter your 4-digit password using the number buttons, then press ENTER. The player starts playback.

## Hint

If you forget your password, remove the disc and repeat steps 1 to 3 of “Parental Control (limited playback).” When you are asked to enter your password, enter “199703” using the number buttons, then press ENTER. The display will ask you to enter a new 4-digit password. After you enter a new 4-digit password, replace the disc in the player and press  $\triangleright$ . When the display for entering your password appears, enter your new password.

## Notes

- When you play discs which do not have the Parental Control function, playback cannot be limited on this player.
- Depending on the disc, you may be asked to change the parental control level while playing the disc. In this case, enter your password, then change the level. If the Resume Play mode is canceled, the level returns to the previous level.

## Area Code

Standard	Code number	Standard	Code number
Argentina	2044	Malaysia	2363
Australia	2047	Mexico	2362
Austria	2046	Netherlands	2376
Belgium	2057	New Zealand	2390
Brazil	2070	Norway	2379
Canada	2079	Pakistan	2427
Chile	2090	Philippines	2424
China	2092	Portugal	2436
Denmark	2115	Russia	2489
Finland	2165	Singapore	2501
France	2174	Spain	2149
Germany	2109	Sweden	2499
India	2248	Switzerland	2086
Indonesia	2238	Thailand	2528
Italy	2254	United Kingdom	2184
Japan	2276		
Korea	2304		

## Changing the password

- 1 Press DISPLAY while the player is in stop mode.**

The Control Menu appears.

- 2 Press  $\uparrow/\downarrow$  to select  (PARENTAL CONTROL), then press ENTER.**

The options for “PARENTAL CONTROL” appear.

- 3 Press  $\uparrow/\downarrow$  to select “PASSWORD  $\rightarrow$ ,” then press ENTER.**

The display for entering the password appears.

- 4 Enter your 4-digit password using the number buttons, then press ENTER.**

- 5 Enter a new 4-digit password using the number buttons, then press ENTER.**

- 6 To confirm your password, re-enter it using the number buttons, then press ENTER.**

### If you make a mistake entering your password

Press  $\leftarrow$  before you press ENTER and input the correct number.

### If you make a mistake

Press  $\rightarrow$  RETURN.

### To turn off the display

Press DISPLAY repeatedly until the display is turned off.

## Controlling Your TV with the Supplied Remote

You can control the sound level, input source, and power switch of your Sony TV with the supplied remote.

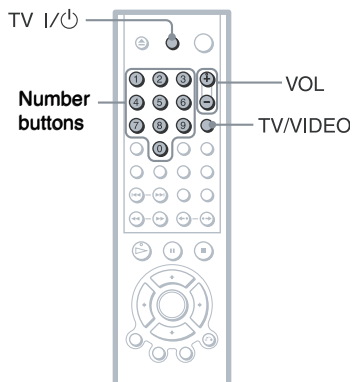

You can control the following items with the supplied remote.

By pressing	You can
TV I/⏻	Turn the TV on or off
VOL +/-	Adjust the volume of the TV
TV/VIDEO	Switch the TV's input source between the TV and other input sources

### Note

Depending on the unit being connected, you may not be able to control your TV using some of the buttons.

## Controlling other TVs with the remote

You can control the sound level, input source, and power switch of non-Sony TVs as well. If your TV is listed in the table below, set the appropriate manufacturing code.

- 1 While holding down TV I/⏻, press the number buttons to select your TV's manufacturer's code (see the table below).
- 2 Release TV I/⏻.

### Code numbers of controllable TVs

Manufacturer	Code number
Sony (default)	01
Aiwa (default)	01
JVC	09
Panasonic	19
Philips	21
RCA	10
Samsung	20
Sanyo	11
Sharp	18
Toshiba	07
Zenith	15

### Notes

- If you enter a new code number, the code number previously entered will be erased.
- When you replace the batteries of the remote, the code number you have set may be reset to the default setting. Set the appropriate code number again.

## Using the Setup Display

By using the Setup Display, you can make various adjustments to items such as picture and sound. You can also set a language for the subtitles and the Setup Display, among other things. For details on each Setup Display item, see pages from 64 to 68.

### Note

Playback settings stored in the disc take priority over the Setup Display settings and not all the functions described may work.

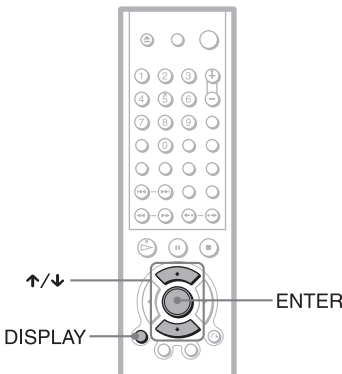

- 1 Press **DISPLAY** when the player is in stop mode.

The Control Menu appears.

- 2 Press **↑/↓** to select  (**SETUP**), then press **ENTER**.

The options for "SETUP" appear.

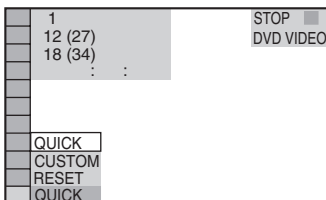

- 3 Press **↑/↓** to select "CUSTOM," then press **ENTER**.

The Setup Display appears.

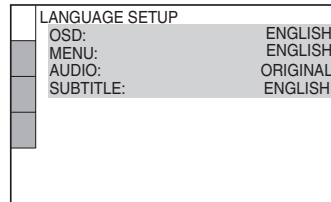

- 4 Press **↑/↓** to select the setup item from the displayed list: "LANGUAGE SETUP," "SCREEN SETUP," "CUSTOM SETUP," or "AUDIO SETUP." Then press **ENTER**.

The Setup item is selected.

Example: "SCREEN SETUP"

Selected item

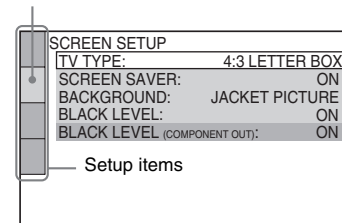

- 5 Select an item using **↑/↓**, then press **ENTER**.

The options for the selected item appear.

Example: "TV TYPE"

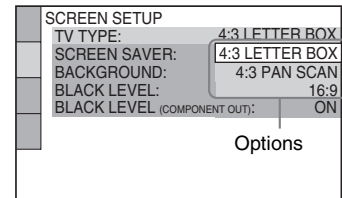

## 6 Select a setting using $\uparrow/\downarrow$ , then press ENTER.

The setting is selected and setup is complete.

Example: "16:9"

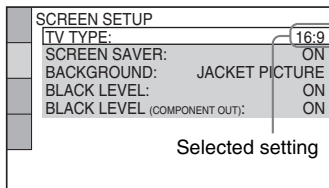

### To turn off the display

Press DISPLAY repeatedly until the display is turned off.

### To enter the Quick Setup mode

Select "QUICK" in step 3. Follow from step 5 of the Quick Setup explanation to make basic adjustments (page 24).

### To reset all of the "SETUP" settings

- 1 Select "RESET" in step 3 and press ENTER
- 2 Select "YES" using  $\uparrow/\downarrow$ .  
You can also quit the process and return to the Control Menu by selecting "NO" here.
- 3 Press ENTER.  
All the settings explained on pages 64 to 68 return to the default settings. Do not press  $\mathbb{I}/\mathbb{O}$  while resetting the player as it takes a few seconds to complete.

## Setting the Display or Sound Track Language (LANGUAGE SETUP)

"LANGUAGE SETUP" allows you to set various languages for the on-screen display or sound track.

Select "LANGUAGE SETUP" in the Setup Display. To use the display, see "Using the Setup Display" (page 63).

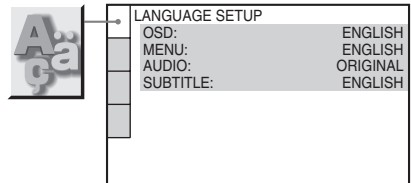

### ◆ OSD (On-Screen Display)

Switches the display language on the screen.

### ◆ MENU (DVD VIDEO only)

You can select the desired language for the disc's menu.

### ◆ AUDIO (DVD VIDEO only)

Switches the language of the sound track. When you select "ORIGINAL," the language given priority in the disc is selected.

### ◆ SUBTITLE (DVD VIDEO only)

Switches the language of the subtitle recorded on the DVD VIDEO.

When you select "AUDIO FOLLOW," the language for the subtitles changes according to the language you selected for the sound track.

### 💡 Hint

If you select "OTHERS  $\rightarrow$ " in "MENU," "SUBTITLE," and "AUDIO," select and enter a language code from "Language Code List" on page 75 using the number buttons.

### Note

When you select a language in "MENU," "SUBTITLE," or "AUDIO" that is not recorded on the DVD VIDEO, one of the recorded languages will be automatically selected.



# Settings for the Display

## (SCREEN SETUP)

Choose settings according to the TV to be connected.

Select "SCREEN SETUP" in the Setup Display. To use the display, see "Using the Setup Display" on page 63.

The default settings are underlined.

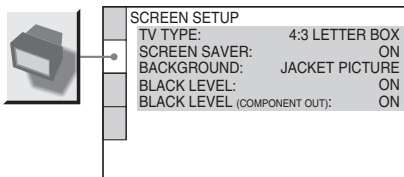

### ◆ TV TYPE

Selects the aspect ratio of the connected TV (4:3 standard or wide).

<u>4:3 LETTER BOX</u>	Select this when you connect a 4:3 screen TV. Displays a wide picture with bands on the upper and lower portions of the screen.
4:3 PAN SCAN	Select this when you connect a 4:3 screen TV. Automatically displays the wide picture on the entire screen and cuts off the portions that do not fit.
16:9	Select this when you connect a wide-screen TV or a TV with a wide mode function.

4:3 LETTER BOX



4:3 PAN SCAN

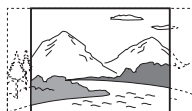

16:9



### Note

Depending on the DVD, "4:3 LETTER BOX" may be selected automatically instead of "4:3 PAN SCAN" or vice versa.

### ◆ SCREEN SAVER

The screen saver image appears when you leave the player in pause or stop mode for 15 minutes, or when you play back a CD or DATA CD (MP3 audio) for more than 15 minutes. The screen saver will help prevent your display device from becoming damaged (ghosting). Press  $\triangleright$  to turn off the screen saver.

<u>ON</u>	Turns on the screen saver.
OFF	Turns off the screen saver.

### ◆ BACKGROUND

Selects the background color or picture on the TV screen in stop mode or while playing a CD or DATA CD (MP3 audio).

<u>JACKET PICTURE</u>	The jacket picture (still picture) appears, but only when the jacket picture is already recorded on the disc (CD-EXTRA, etc.). If the disc does not contain a jacket picture, the "GRAPHICS" picture appears.
GRAPHICS	A preset picture stored in the player appears.
BLUE	The background color is blue.
BLACK	The background color is black.

### ◆ BLACK LEVEL

Selects the black level (setup level) for the video signals output from the jacks other than COMPONENT VIDEO OUT.

<u>ON</u>	Sets the black level of the output signal to the standard level.
OFF	Lowers the standard black level. Use this when the picture becomes too white.

### ◆ BLACK LEVEL (COMPONENT OUT)

Selects the black level (setup level) for the video signals output from the COMPONENT VIDEO OUT jacks.

You cannot select this when the player outputs progressive signal and the PROGRESSIVE indicator lights up in blue on the front panel.

<u>ON</u>	Sets the black level of the output signal to the standard level.
OFF	Lowers the standard black level. Use this when the picture becomes too white.

## Custom Settings (CUSTOM SETUP)

Use this to set up playback related and other settings.

Select "CUSTOM SETUP" in the Setup Display. To use the display, see "Using the Setup Display" (page 63).

The default settings are underlined.



CUSTOM SETUP	
<u>AUTO POWER OFF:</u>	OFF
AUTO PLAY:	OFF
<u>DIMMER:</u>	BRIGHT
PAUSE MODE:	AUTO
<u>TRACK SELECTION:</u>	OFF
MULTI-DISC RESUME:	ON

### ◆ AUTO POWER OFF

Switches the Auto Power Off setting on or off.

<u>OFF</u>	Switches this function off.
ON	The player enters standby mode when left in stop mode for more than 30 minutes.

### ◆ AUTO PLAY

Switches the Auto Play setting on or off. This function is useful when the player is connected to a timer (not supplied).

<u>OFF</u>	Switches this function off.
ON	Automatically starts playback when the player is turned on.

### ◆ DIMMER

Adjusts the lighting of the front panel display.

<u>BRIGHT</u>	Makes the lighting bright.
DARK	Makes the lighting dark.

### ◆ PAUSE MODE (DVD VIDEO/DVD-RW only)

Selects the picture in pause mode.

<u>AUTO</u>	The picture, including subjects that move dynamically, is output with no jitter. Normally select this position.
FRAME	The picture, including subjects that do not move dynamically, is output in high resolution.

### ◆ TRACK SELECTION (DVD VIDEO only)

Gives the sound track which contains the highest number of channels priority when you play a DVD VIDEO on which multiple audio formats (PCM, DTS, or Dolby Digital format) are recorded.

<u>OFF</u>	No priority given.
AUTO	Priority given.

### Notes

- When you set the item to "AUTO," the language may change. The "TRACK SELECTION" setting has higher priority than the "AUDIO" settings in "LANGUAGE SETUP" (page 64).
- If you set "DTS" to "OFF" (page 68), the DTS sound track is not played even if you set "TRACK SELECTION" to "AUTO."
- If PCM, DTS, and Dolby Digital sound tracks have the same number of channels, the player selects PCM, DTS, and Dolby Digital sound tracks in this order.

### ◆ MULTI-DISC RESUME (DVD VIDEO/VIDEO CD only)

Switches the Multi-disc Resume setting on or off. Resume playback point can be stored in memory for up to 6 different DVD VIDEO/VIDEO CD discs (page 30).

<u>ON</u>	Stores the resume settings in memory for up to six discs (The settings remain in memory even if you select "OFF.")
OFF	Does not store the resume settings in memory. Playback restarts at the resume point only for the current disc in the player.

## Settings for the Sound

### (AUDIO SETUP)

"AUDIO SETUP" allows you to set the sound according to the playback and connection conditions.

Select "AUDIO SETUP" in the Setup Display. To use the display, see "Using the Setup Display" (page 63).

The default settings are underlined.

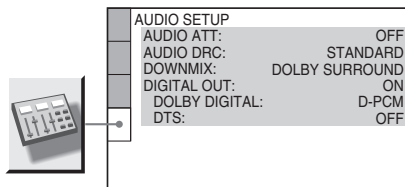

### ◆ AUDIO ATT (attenuation)

If the playback sound is distorted, set this item to "ON." The player reduces the audio output level.

This function affects the output of the LINE OUT L/R (AUDIO) jack.

<u>OFF</u>	Normally, select this position.
ON	Select this when the playback sound from the speakers is distorted.

### ◆ AUDIO DRC (Dynamic Range Control) (DVD VIDEO/DVD-RW only)

Makes the sound clear when the volume is turned down when playing a DVD that conforms to "AUDIO DRC." This affects the output from the following jacks:

- LINE OUT L/R (AUDIO) jack
- DIGITAL OUT (COAXIAL or OPTICAL) jack only when "DOLBY DIGITAL" is set to "D-PCM" (page 68).

<u>STANDARD</u>	Normally select this position.
TV MODE	Makes the low sounds clear even if you turn the volume down.
WIDE RANGE	Gives you the feeling of being at a live performance.

### ◆ DOWNMIX (DVD only)

Switches the method for mixing down to 2 channels when you play a DVD which has rear sound elements (channels) or is recorded in Dolby Digital format. For details on the rear signal components, see "Displaying the audio information of the disc" (page 50). This function affects the output of the following jacks:

- LINE OUT L/R (AUDIO) jack
- DIGITAL OUT (COAXIAL or OPTICAL) jack when "DOLBY DIGITAL" is set to "D-PCM" (page 68).

<u>DOLBY SURROUND</u>	Normally, select this position. Multi-channel audio signals are output to two channels for enjoying surround sounds.
NORMAL	Multi-channel audio signals are downmixed to two channels for use with your stereo.

### ◆ DIGITAL OUT

Selects if audio signals are output via the DIGITAL OUT (COAXIAL or OPTICAL) jack.

<u>ON</u>	Normally select this position. When you select "ON," see "Setting the digital output signal" for further settings.
OFF	The influence of the digital circuit upon the analog circuit is minimal.

## Setting the digital output signal

Switches the method of outputting audio signals when you connect a component such as an amplifier (receiver) or MD deck with a digital input jack.

For connection details, see page 19.

Select "DOLBY DIGITAL" and "DTS" after setting "DIGITAL OUT" to "ON."

AUDIO SETUP	
AUDIO ATT:	OFF
AUDIO DRC:	STANDARD
DOWNMIX:	DOLBY SURROUND
DIGITAL OUT:	ON
DOLBY DIGITAL:	D-PCM
DTS:	OFF

If you connect a component that does not conform to the selected audio signal, a loud noise (or no sound) will come out from the speakers, damaging your ears or speakers.

### ◆ DOLBY DIGITAL (DVD VIDEO/DVD-RW only)

Selects the type of Dolby Digital signal.

<u>D-PCM</u>	Select this when the player is connected to an audio component lacking a built-in Dolby Digital decoder. You can select whether the signals conform to Dolby Surround (Pro Logic) or not by making adjustments to the "DOWNMIX" item in "AUDIO SETUP" (page 68).
DOLBY DIGITAL	Select this when the player is connected to an audio component with a built-in Dolby Digital decoder.

### ◆ DTS (DVD VIDEO only)

Selects whether or not to output DTS signal.

<u>OFF</u>	Select this when the player is connected to an audio component lacking a built-in DTS decoder.
ON	Select this when the player is connected to an audio component with a built-in DTS decoder.

## Troubleshooting

If you experience any of the following difficulties while using the player, use this troubleshooting guide to help remedy the problem before requesting repairs. Should any problem persist, consult your nearest Sony dealer (for customers in the U.S.A only).

### Power

#### The power is not turned on.

- ➔ Check that the AC power cord is connected securely.

### Picture

#### There is no picture/picture noise appears.

- ➔ Re-connect the connecting cord securely.
- ➔ The connecting cord is damaged.
- ➔ Check the connection to your TV (page 16) and switch the input selector on your TV so that the signal from the player appears on the TV screen.
- ➔ The disc is dirty or flawed.
- ➔ If the picture output from your player goes through your VCR to get to your TV or if you are connected to a combination TV/VIDEO player, the copy-protection signal applied to some DVD programs could affect picture quality. If you still experience problems even when you connect your player directly to your TV, please try connecting your player to your TV's S VIDEO input (page 16).

#### Even though you set the aspect ratio in "TV TYPE" of "SCREEN SETUP," the picture does not fill the screen.

- ➔ The aspect ratio of the disc is fixed on your DVD.

### Sound

#### There is no sound.

- ➔ Re-connect the connecting cord securely.
- ➔ The connecting cord is damaged.
- ➔ The player is connected to the wrong input jack on the amplifier (receiver) (page 21, 22, 23).
- ➔ The amplifier (receiver) input is not correctly set.
- ➔ The player is in pause mode or in Slow-motion Play mode.
- ➔ The player is in fast forward or fast reverse mode.
- ➔ If the audio signal does not come through the DIGITAL OUT (COAXIAL or OPTICAL) jack, check the audio settings (page 68).
- ➔ While playing a Super VCD on which the audio track 2 is not recorded, no sound will come out when you select "2:STEREO", "2:1/L" or "2:2/R".

#### Sound is noisy.

- ➔ When playing a CD with DTS sound tracks, noise will come from the LINE OUT L/R (AUDIO) jack or DIGITAL OUT (COAXIAL or OPTICAL) jack (page 27).

#### Sound distortion occurs.

- ➔ Set "AUDIO ATT" in "AUDIO SETUP" to "ON" (page 67).

#### The sound volume is low.

- ➔ The sound volume is low on some DVDs. The sound volume may improve if you set "AUDIO DRC" to "TV MODE" (page 67).
- ➔ Set "AUDIO ATT" in "AUDIO SETUP" to "OFF" (page 67).

### Operation

#### The remote does not function.

- ➔ There are obstacles between the remote and the player.
- ➔ The distance between the remote and the player is too far.
- ➔ The remote is not pointed at the remote sensor on the player.
- ➔ The batteries in the remote are weak.

---

**The disc does not play.**

- ➔ The disc is turned over.  
Insert the disc with the playback side facing down on the disc tray.
- ➔ The disc is skewed.
- ➔ The player cannot play certain discs (page 6).
- ➔ The region code on the DVD does not match the player.
- ➔ Moisture has condensed inside the player (page 3).
- ➔ The player cannot play a recorded disc that is not correctly finalized (page 6).

---

**The MP3 audio track cannot be played (page 34).**

- ➔ The DATA CD is not recorded in the MP3 format that conforms to ISO9660 Level 1/ Level 2 or Joliet.
- ➔ The MP3 audio track does not have the extension “.MP3.”
- ➔ The data is not formatted in MP3 even though it has the extension “.MP3.”
- ➔ The data is not MPEG1 Audio Layer 3 data.
- ➔ The player cannot play audio tracks in MP3PRO format.

---

**“Copyright lock” appears and the screen turns blue when playing a DVD-RW disc.**

- ➔ Images taken from digital broadcasts, etc., may contain copy protection signals, such as complete copy protection signals, single copy signals, and restriction-free signals. When images that contain copy protection signals are played, a blue screen may appear instead of the images. It may take a while when looking for playable images.

---

**The title of the MP3 audio album or track is not correctly displayed.**

- ➔ The player can only display numbers and alphabet. Other characters are displayed as “\*?”.

---

**The disc does not start playing from the beginning.**

- ➔ Program Play, Shuffle Play, Repeat Play, or A-B Repeat Play has been selected (page 36).
- ➔ Resume play has taken effect (page 30).

---

**The player starts playing the disc automatically.**

- ➔ The disc features an auto playback function.

- ➔ “AUTO PLAY” in “CUSTOM SETUP” is set to “ON” (page 66).

---

**Playback stops automatically.**

- ➔ While playing discs with an auto pause signal, the player stops playback at the auto pause signal.

---

**You cannot perform some functions such as Stop, Search, Slow-motion Play, Repeat Play, Shuffle Play, or Program Play.**

- ➔ Depending on the disc, you may not be able to do some of the operations above. See the operating manual that comes with the disc.

---

**The language for the sound track cannot be changed.**

- ➔ Try using the DVD’s menu instead of the direct selection button on the remote (page 31).
- ➔ Multilingual tracks are not recorded on the DVD being played.
- ➔ The DVD prohibits the changing of the language for the sound track.

---

**The subtitle language cannot be changed or turned off.**

- ➔ Try using the DVD’s menu instead of the direct selection button on the remote (page 31).
- ➔ Multilingual subtitles are not recorded on the DVD being played.
- ➔ The DVD prohibits the changing of the subtitles.

---

**The angles cannot be changed.**

- ➔ Try using the DVD’s menu instead of the direct selection button on the remote (page 31).
- ➔ Multi-angles are not recorded on the DVD being played.
- ➔ The angle can only be changed when the “ANGLE” indicator lights up on the front panel display (page 9).
- ➔ The DVD prohibits changing of the angles.

---

**The player does not operate properly.**

- ➔ When static electricity, etc., causes the player to operate abnormally, unplug the player.

---

**5 numbers or letters are displayed on the screen and on the front panel display.**

- ➔ The self-diagnosis function was activated.  
(See the table on page 71.)

---

**The disc tray does not open and “LOCKED” appears on the front panel display.**

- ➔ Child Lock is set (page 29).

---

**The disc tray does not open and “TRAY LOCKED” appears on the front panel display.**

- ➔ Contact your Sony dealer or local authorized Sony service facility.

---

**“Data error” appears on the TV screen when playing a DATA CD.**

- ➔ The MP3 audio track you want to play is broken.  
➔ The data is not MPEG1 Audio Layer 3 data.

---

## Self-diagnosis Function

**(When letters/numbers appear in the display)**

When the self-diagnosis function is activated to prevent the player from malfunctioning, a five-character service number (e.g., C 13 50) with a combination of a letter and four digits appears on the screen and the front panel display. In this case, check the following table.

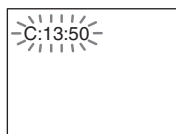

---

<b>First three characters of the service number</b>	<b>Cause and/or corrective action</b>
---	---------------------------------------

---

C 13	The disc is dirty. ➔ Clean the disc with a soft cloth (page 7).
C 31	The disc is not inserted correctly. ➔ Re-insert the disc correctly.
E XX (xx is a number)	To prevent a malfunction, the player has performed the self-diagnosis function. ➔ Contact your nearest Sony dealer or local authorized Sony service facility and give the 5-character service number. Example: E 61 10

---

---

# Glossary

## Chapter (page 46)

Sections of a picture or a music feature that are smaller than titles. A title is composed of several chapters. Depending on the disc, no chapters may be recorded.

---

## Dolby Digital (page 23, 68)

Digital audio compression technology developed by Dolby Laboratories. This technology conforms to 5.1-channel surround sound. The rear channel is stereo and there is a discrete subwoofer channel in this format. Dolby Digital provides the same 5.1 discrete channels of high quality digital audio found in "Dolby Digital" theater surround sound systems. Good channel separation is realized because all of the channel data are recorded discretely and little deterioration is realized because all channel data processing is digital.

---

## Dolby Surround (Pro Logic) (page 22)

Audio signal processing technology that Dolby Laboratories developed for surround sound. When the input signal contains a surround component, the Pro Logic process outputs the front, center and rear signals. The rear channel is monaural.

---

## DTS (page 23, 68)

Digital audio compression technology that Digital Theater Systems, Inc. developed. This technology conforms to 5.1-channel surround sound. The rear channel is stereo and there is a discrete subwoofer channel in this format. DTS provides the same 5.1 discrete channels of high quality digital audio.

Good channel separation is realized because all of the channel data is recorded discretely and little deterioration is realized because all channel data processing is digital.

---

## DVD VIDEO (page 6)

A disc that contains up to 8 hours of moving pictures even though its diameter is the same as a CD.

The data capacity of a single-layer and single-sided DVD is 4.7 GB (Giga Byte), which is 7 times that of a CD. The data capacity of a double-layer and single-sided DVD is 8.5 GB, a single-layer and double-sided DVD is 9.4 GB, and double-layer and double-sided DVD is 17 GB.

The picture data uses the MPEG 2 format, one of the worldwide standards of digital compression technology. The picture data is compressed to about 1/40 (average) of its original size. The DVD also uses a variable rate coding technology that changes the data to be allocated according to the status of the picture. Audio information is recorded in a multi-channel format, such as Dolby Digital, allowing you to enjoy a more real audio presence.

Furthermore, various advanced functions such as the multi-angle, multilingual, and Parental Control functions are provided with the DVD.

---

## DVD-RW (page 6)

A DVD-RW is a recordable and rewritable disc with the same size as the DVD VIDEO. The DVD-RW can be recorded in two different modes: VR mode and Video mode. VR (Video Recording) mode enables various programming and editing functions, some of which are limited in the case of Video mode. Video mode complies with DVD VIDEO format and can be played on other DVD players while a DVD-RW recorded in VR mode can only be played on DVD-RW compliant players. The "DVD-RW" appearing in this manual, and the on-screen displays refer to DVD-RWs in VR mode.

---

## DVD+RW (page 6)

A DVD+RW (plus RW) is a recordable and rewritable disc. DVD+RWs use a recording format that is comparable to the DVD VIDEO format.



---

**Film based software, Video based software (page 18)**

DVDs can be classified as Film based or Video based software. Film based DVDs contain the same images (24 frames per second) that are shown at movie theaters. Video based DVDs, such as television dramas or sit-coms, display images at 30 frames/60 fields (25 frames/50 fields) per second.

---

**Interlace format (page 18)**

Interlace format shows every other line of an image as a single “field” and is the standard method for displaying images on television. The even number field shows the even numbered lines of an image, and the odd numbered field shows the odd numbered lines of an image.

---

**Index (CD)/Video Index (VIDEO CD) (page 12)**

A number that divides a track into sections to easily locate the point you want on a CD or VIDEO CD. Depending on the disc, no index may be recorded.

---

**Progressive format (page 18)**

Compared to the Interlace format that alternately shows every other line of an image (field) to create one frame, the Progressive format shows the entire image at once as a single frame. This means that while the Interlace format can show 30 frames (60 fields) in one second, the Progressive format can show 60 frames in one second. The overall picture quality increases and still images, text, and horizontal lines appear sharper. This player is compatible with the 480 progressive format.

---

**Scene (page 46)**

On a VIDEO CD with PBC (playback control) functions, the menu screens, moving pictures and still pictures are divided into sections called “scenes.”

---

**Title (page 9)**

The longest section of a picture or music feature on a DVD, movie, etc., in video software, or the entire album in audio software.

---

**Track (page 9)**

Sections of a picture or a music feature on a CD or VIDEO CD (the length of a song).

# Specifications

## System

**Laser:** Semiconductor laser

**Signal format system:** NTSC

## Audio characteristics

**Frequency response:** DVD VIDEO (PCM 96 kHz): 2 Hz to 44 kHz ( $\pm 1.0$  dB)/DVD VIDEO (PCM 48 kHz): 2 Hz to 22 kHz ( $\pm 0.5$  dB)/CD: 2 Hz to 20 kHz ( $\pm 0.5$  dB)

**Signal-to-noise ratio (S/N ratio):** 115 dB (LINE OUT L/R (AUDIO) jack only)

**Harmonic distortion:** 0.003 %

**Dynamic range:** DVD VIDEO: 103 dB/CD: 99 dB

**Wow and flutter:** Less than detected value ( $\pm 0.001\%$  W PEAK)

The signals from LINE OUT L/R (AUDIO) jack are measured. When you play PCM sound tracks with a 96 kHz sampling frequency, the output signals from the DIGITAL OUT (COAXIAL or OPTICAL) jack are converted to 48 kHz sampling frequency.

## Outputs

**(Jack name):** Jack type/Output level/Load impedance)

**LINE OUT L/R (AUDIO) :** Phono jack/  
2 V<sub>rms</sub>/10 kilohms

**DIGITAL OUT (OPTICAL) :** Optical  
output jack/-18 dBm (wave length:  
660 nm)

**DIGITAL OUT (COAXIAL) :** Phono jack/  
0.5 V<sub>p-p</sub>/75 ohms

**COMPONENT VIDEO OUT (Y, P<sub>B</sub>, P<sub>R</sub>) :**  
Phono jack/Y: 1.0 V<sub>p-p</sub>/P<sub>B</sub>, P<sub>R</sub>:  
0.65 V<sub>p-p</sub>/75 ohms

**LINE OUT (VIDEO) :** Phono jack/  
1.0 V<sub>p-p</sub>/75 ohms

**S VIDEO OUT :** 4-pin mini DIN/  
Y: 1.0 V<sub>p-p</sub>/C: 0.286 V<sub>p-p</sub>/75 ohms

## General

**Power requirements:**

120 V AC, 60 Hz

**Power consumption:** 15 W

**Dimensions (approx.):** 430 × 95.5 × 409 mm  
(17 × 3 <sup>7</sup>/<sub>8</sub> × 16 <sup>1</sup>/<sub>8</sub> in.) (width/height/depth)  
incl. projecting parts

**Mass (approx.):** 5.1 kg (11 lb 4 oz)

**Operating temperature:** 5 °C to 35 °C  
(41 °F to 95 °F)

**Operating humidity:** 25 % to 80 %

## Supplied accessories

See page 15.

Specifications and design are subject to change without notice.

ENERGY STAR® is a U.S. registered mark. As an ENERGY STAR® Partner, Sony Corporation has determined that this product meets the ENERGY STAR® guidelines for energy efficiency.

# Language Code List

For details, see pages 49, 53, 64.

The language spellings conform to the ISO 639: 1988 (E/F) standard.

Code	Language	Code	Language	Code	Language	Code	Language
1027	Afar	1183	Irish	1347	Maori	1507	Samoa
1028	Abkhazian	1186	Scots Gaelic	1349	Macedonian	1508	Shona
1032	Afrikaans	1194	Galician	1350	Malayalam	1509	Somali
1039	Amharic	1196	Guarani	1352	Mongolian	1511	Albanian
1044	Arabic	1203	Gujarati	1353	Moldavian	1512	Serbian
1045	Assamese	1209	Hausa	1356	Marathi	1513	Siswati
1051	Aymara	1217	Hindi	1357	Malay	1514	Sesotho
1052	Azerbaijani	1226	Croatian	1358	Maltese	1515	Sundanese
1053	Bashkir	1229	Hungarian	1363	Burmese	1516	Swedish
1057	Byelorussian	1233	Armenian	1365	Nauru	1517	Swahili
1059	Bulgarian	1235	Interlingua	1369	Nepali	1521	Tamil
1060	Bihari	1239	Interlingue	1376	Dutch	1525	Telugu
1061	Bislama	1245	Inupiak	1379	Norwegian	1527	Tajik
1066	Bengali; Bangla	1248	Indonesian	1393	Occitan	1528	Thai
1067	Tibetan	1253	Icelandic	1403	(Afan)Oromo	1529	Tigrinya
1070	Breton	1254	Italian	1408	Oriya	1531	Turkmen
1079	Catalan	1257	Hebrew	1417	Punjabi	1532	Tagalog
1093	Corsican	1261	Japanese	1428	Polish	1534	Setswana
1097	Czech	1269	Yiddish	1435	Pashto; Pushto	1535	Tonga
1103	Welsh	1283	Javanese	1436	Portuguese	1538	Turkish
1105	Danish	1287	Georgian	1463	Quechua	1539	Tsonga
1109	German	1297	Kazakh	1463	Quechua	1540	Tatar
1130	Bhutani	1298	Greenlandic	1481	Rhaeto- Romance	1543	Twi
1142	Greek	1299	Cambodian	1482	Kirundi	1557	Ukrainian
1144	English	1300	Kannada	1483	Romanian	1564	Urdu
1145	Esperanto	1301	Korean	1483	Romanian	1572	Uzbek
1149	Spanish	1305	Kashmiri	1489	Russian	1581	Vietnamese
1150	Estonian	1307	Kurdish	1491	Kinyarwanda	1587	Volapük
1151	Basque	1311	Kirghiz	1495	Sanskrit	1613	Wolof
1157	Persian	1313	Latin	1498	Sindhi	1632	Xhosa
1165	Finnish	1326	Lingala	1501	Sangho	1665	Yoruba
1166	Fiji	1327	Laothian	1502	Serbo- Croatian	1684	Chinese
1171	Faroese	1332	Lithuanian	1503	Singhalese	1697	Zulu
1174	French	1334	Latvian; Lettish	1505	Slovak		
1181	Frisian	1345	Malagasy	1506	Slovenian	1703	Not specified

# Index

## Numerics

- 16:9 65
- 4:3 LETTER BOX 65
- 4:3 PAN SCAN 65
- 5.1 Channel Surround 19

## A

- A-B REPEAT 40
- ADVANCED 47
- ALBUM 43
- Album 34
- ANGLE 53
- AUDIO 49, 64
- AUDIO ATT 67
- AUDIO DRC 67
- AUDIO SETUP 68
- AUTO PLAY 66
- AUTO POWER OFF 66

## B

- BACKGROUND 65
- Batteries 15
- BIT RATE 47
- BNR 54

## C

- CD 6, 27
- CHAPTER 42
- Chapter 46, 72
- CHAPTER VIEWER 44
- Checking a disc loaded 28
- Child Lock 29
- Connecting 16
- Continuous play
  - CD/VIDEO CD 27
  - DATA CD 33
  - DVD 27
- Control Menu 12
- CUSTOM 63
- CUSTOM PARENTAL CONTROL 58
- CUSTOM PICTURE MODE 55
- CUSTOM SETUP 66

## D

- DATA CD 6, 33
- DIGITAL OUT 68
- Digital output 68
- DIGITAL VIDEO ENHANCER 56
- DIMMER 66
- DISC SKIP 27
- Display
  - Front panel display 9, 46
  - Setup Display 63
- Displaying the audio information of the disc 50
- DOLBY DIGITAL 19, 49,

- 68, 72
- DOWNMIX 68
- DTS 23, 49, 68, 72
- DVD VIDEO 6, 27, 72
- DVD+RW 6, 28, 72
- DVD/CD text 45
- DVD's menu 31
- DVD-RW 6, 31, 72

## F

- Fast forward 41
- Fast reverse 41
- Film based software 18, 73
- Freeze Frame 42
- Front panel display 9, 46

## H

- Handling discs 7
- Hooking up 15

## I

- INDEX 42
- Index 73
- INSTANT REPLAY 28
- INSTANT SEARCH 28
- INTERLACE 18, 73
- Interlace format 18, 73

## L

- LANGUAGE SETUP 64
- LAYER 47
- Locating
  - a specific point by watching the TV screen 41

## M

- MEMORY 56
- MENU 64
- MP3 6, 33
- MULTI-DISC RESUME 30, 67

## N

- NORMAL (INTERLACE) 18

## O

- On-screen display
  - Control Menu Display 12
  - Setup Display 63
- ORIGINAL 31
- ORIGINAL/PLAY LIST 31
- OSD 64

## P

- PARENTAL CONTROL 58
- PAUSE MODE 67
- PBC Playback 32
- PICTURE MODE 55
- PICTURE NAVIGATION 44

- PLAY LIST 31
- PRO LOGIC 22, 72
- PROGRAM 36
- Program Play 36
- PROGRESSIVE AUTO 18
- PROGRESSIVE FILM 18
- Progressive format 18, 73
- PROGRESSIVE VIDEO 18

## Q

- QUICK 64
- Quick Setup 24, 64

## R

- Remote 15, 62
- REPEAT 39
- Repeat Play 39
- Replacing discs while playing a disc 29
- RESET 64
- Resume Play 30

## S

- S VIDEO output 16
- Scan 41
- SCENE 42
- Scene 46, 73
- SCREEN SAVER 65
- SCREEN SETUP 65
- Searching 41
- Selecting a disc 28
- SETUP 63
- Setup Display 63
- SHUFFLE 38
- Shuffle Play 38
- Slow-motion Play 41
- Speakers
  - Hooking up 19
- STEP 41
- SUBTITLE 53, 64
- SURROUND 19, 51

## T

- TIME/TEXT 42, 45
- TITLE 42
- Title 9, 73
- TITLE VIEWER 44
- TOP MENU 31
- TRACK 42
- Track 9, 34, 73
- TRACK SELECTION 67
- TRACK VIEWER 44
- Troubleshooting 69
- TV TYPE 65
- TVS (TV Virtual Surround) 51

## U

- Usable discs 6

## **V**

Video based software 18, 73

VIDEO CD 6, 32



Printed on 100% recycled paper.

Printed using VOC (volatile organic compound)-free vegetable oil based ink.

## Free Manuals Download Website

<http://myh66.com>

<http://usermanuals.us>

<http://www.somanuals.com>

<http://www.4manuals.cc>

<http://www.manual-lib.com>

<http://www.404manual.com>

<http://www.luxmanual.com>

<http://aubethermostatmanual.com>

Golf course search by state

<http://golfingnear.com>

Email search by domain

<http://emailbydomain.com>

Auto manuals search

<http://auto.somanuals.com>

TV manuals search

<http://tv.somanuals.com>