

WARNING

To prevent fire or shock hazard, do not expose the unit to rain or moisture.

To avoid electrical shock, do not open the cabinet. Refer servicing to qualified personnel only.

Laser component in this product is capable of emitting radiation exceeding the limit for Class 1.

CLASS 1 LASER PRODUCT
LUOKAN 1 LASERLAITE
KLASS 1 LASERAPPARAT

This appliance is classified as a CLASS 1 LASER product. The CLASS 1 LASER PRODUCT MARKING is located on the rear exterior.

Precautions

On safety

- Caution – The use of optical instruments with this product will increase eye hazard.
- Should any solid object or liquid fall into the cabinet, unplug the player and have it checked by qualified personnel before operating it any further.

On power sources

- The unit is not disconnected from the AC power source (mains) as long as it is connected to the wall outlet, even if the unit itself has been turned off.
- If you are not going to use the player for a long time, be sure to disconnect the player from the wall outlet. To disconnect the AC power cord (mains lead), grasp the plug itself; never pull the cord.
- AC power cord must be changed only at the qualified service shop.

On placement

- Place the player in a location with adequate ventilation to prevent heat build-up in the player.
- Do not place the player on a soft surface such as a rug that might block the bottom.
- Do not place the player in a location near heat sources, or in a place subject to direct sunlight, excessive dust or mechanical shock.

On operation

- If the player is brought directly from a cold to a warm location, or is placed in a very damp room, moisture may condense on the lenses inside the player. Should this occur, the player may not operate properly. In this case, remove the disc and leave the player turned on for about an hour until the moisture evaporates.

On adjusting volume

- Do not turn up the volume while listening to a portion with very low level inputs or no audio signals. If you do, the speakers may be damaged when a peak level portion is played.

On cleaning

- Clean the cabinet, panel and controls with a soft cloth slightly moistened with a mild detergent solution. Do not use any type of abrasive pad, scouring powder or solvent such as alcohol or benzine.

On transportation

- To protect the inside of the player, be sure to remove the disc, and turn the power off after “no DISC” appears in the front panel display.

If you have any questions or problems concerning your player, please consult your nearest Sony dealer.

Welcome!

Thank you for purchasing the Sony Video Compact Disc (VIDEO CD) Player. Before operating the unit, please read this manual thoroughly and retain it for future reference.

About This Manual

The instructions in this manual are for model MCE-F88K.

Conventions

- Instructions in this manual describe the controls on the player.
You can also use the controls on the remote if they have the same or similar names as those on the player.
- The following icons are used in this manual:



Indicates that you can use only the remote to do the task.



Indicates tips and hints for making the task easier.

TABLE OF CONTENTS

This Player Can Play the Following Discs	4
---	---

Getting Started	
Unpacking	4
Hooking Up the System	5

Basic Operations	
Playing a VIDEO CD	8

Enjoying Karaoke	
Playing Karaoke	10

Locating a Scene or Track You Want	
Using the On-Screen Display	12
Using the Front Panel Display	13
Resuming Playback from the Point You Stopped a Disc (Resume Play)	14
Locating a Specific Track	15
Locating a Point by Elapsed Time (Time Search)	15
Locating a Particular Point in a Scene or Track	16
Locating by Observing Several Scenes at One Time (Digest Play)	17

Playing CDs in Various Modes	
Playing Repeatedly	19
Playing in Random Order (Shuffle Play)	20
Creating Your Own Program (Program Play)	20
Enjoying Picture Effects	22
Enjoying Sound Effects	22
Switching the Sound	23
Controlling the TV with the Supplied Remote	23



Enjoying Karaoke with Non-Karaoke Discs	
Playing Karaoke with Any Stereo Discs (Karaoke Pon)	24

Enjoying Playback Using the PBC Functions	
Playing VIDEO CDs with PBC Functions (PBC Playback)	25
Locating Scenes Directly Using the Scene Numbers (Scene Search)	26

Additional Information	
Notes on Discs	28
Troubleshooting	28
Specifications	29
Glossary	29

Index	30
--------------------	----

This Player Can Play the Following Discs

	VIDEO CDs	Audio CDs
Disc logo		
Contents	Audio + Video (moving pictures)	Audio
Disc size	12 cm/8 cm	12 cm/8 cm (CD single)
Play time	74 min./20 min.	74 min./20 min.

To play VIDEO CDs, see page 8.

To enjoy PBC Playback of VIDEO CDs with PBC functions, see page 25.

To play karaoke, see page 10.

Note on VIDEO CDs

This player conforms to Ver. 1.1 and Ver. 2.0 of VIDEO CD standards. You can enjoy two kinds of playback according to the disc type.

Disc type	You can
VIDEO CDs without PBC functions (Ver. 1.1 discs)	Enjoy video playback (moving pictures) as well as music.
VIDEO CDs with PBC functions (Ver. 2.0 discs)	Play interactive software using menu screens displayed on the TV screen (PBC Playback), in addition to the video playback functions of Ver 1.1 discs. Moreover, you can play high-resolution still pictures, if they are included on the disc.

Getting Started

Unpacking



Check that you received the following items:

- Audio and video connecting cord (3 phono plugs-3 phono plugs) (1)
- Remote commander (remote) RMT-F88V (1)
- Sony R6 (size AA) batteries (2)

Inserting batteries into the remote

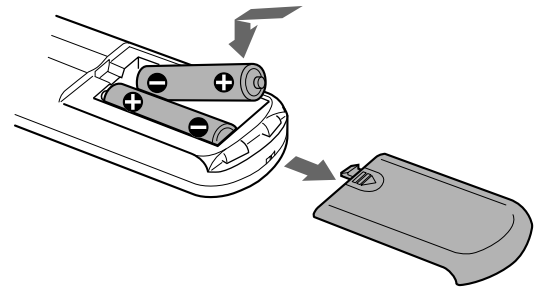
You can control the player using the supplied remote. Insert two R6 (size AA) batteries by matching the + and - on the batteries. When using the remote, point it at the remote sensor  on the player.



 You can control Sony TVs with the  mark using the supplied remote
See page 23.

 **When to replace batteries**
With normal use, the batteries should last for about six months. When the remote no longer operates the player, replace all the batteries with new ones.

Notes

- Do not leave the remote near an extremely hot or humid place.
- Do not drop any foreign object into the remote casing, particularly when replacing the batteries.
- Do not expose the remote sensor to direct sunlight or lighting apparatuses. Doing so may cause a malfunction.
- If you don't use the remote for an extended period of time, remove the batteries to avoid possible damage from battery leakage and corrosion.

Hooking Up the System

Overview

This section describes how to hook up the VIDEO CD player to a TV (with audio/video input jacks) and/or an amplifier. Be sure to turn off the power of each component before making the connections.

■ When listening to the sound through TV speakers

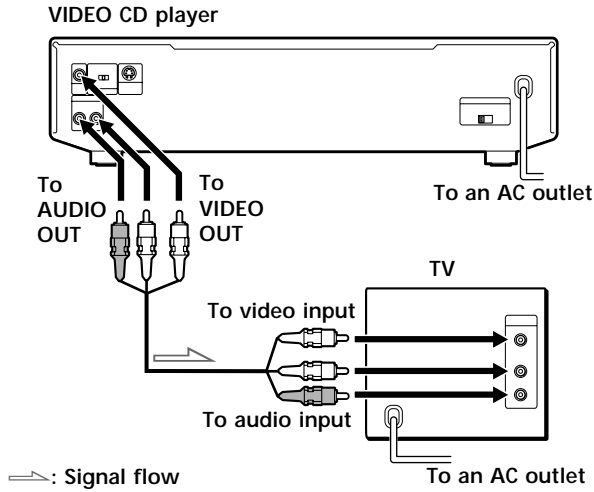

■ When listening to the sound through speakers connected to an amplifier

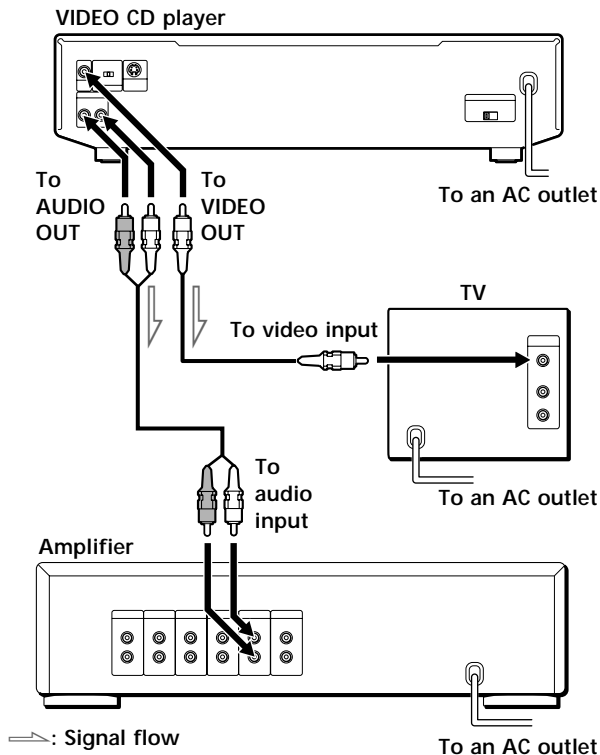

What cords will I need?

Audio and video connecting cord (supplied) (1)

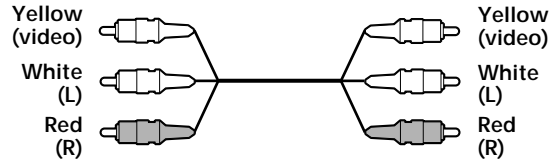

Video connecting cord (not supplied) (1)

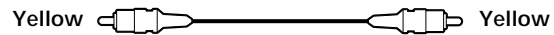

Audio connecting cord (not supplied) (1)

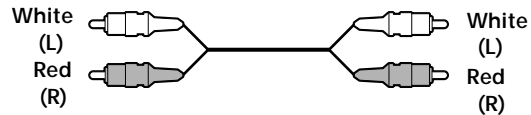

Hookups

When connecting the cord, be sure to match the color-coded cord to the appropriate jacks on the components: Yellow (video) to Yellow, Red (right) to Red and White (left) to White. Be sure to make connections firmly to avoid hum and noise.

■ When listening to the sound through TV speakers

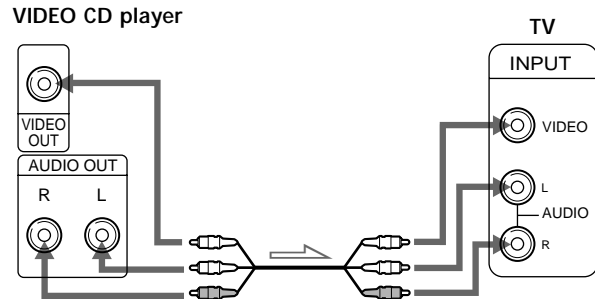

■ When listening to the sound through speakers connected to an amplifier

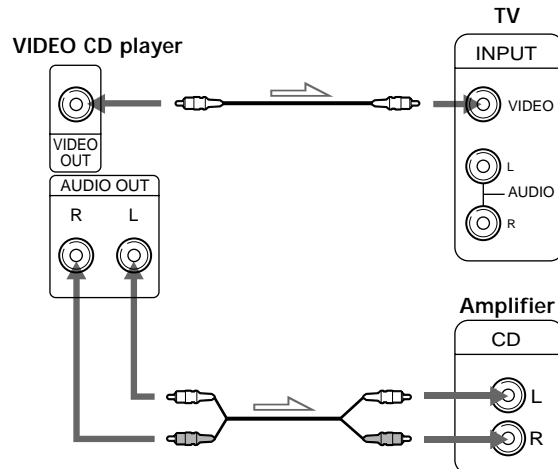

(Continued)

-  If your TV or VCR has an S video input connector Connect the component via the S VIDEO OUT connector using the S video cable (not supplied). You will get a better picture.

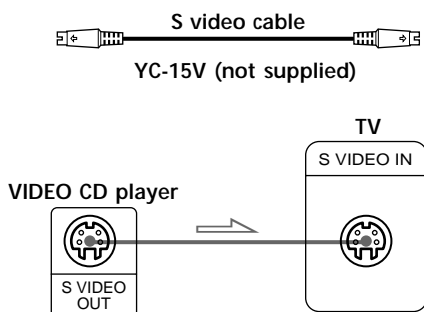

Important

Setting the color system switch

This player conforms to the NTSC and PAL color systems. Set the COLOR SYSTEM switch on the rear of the player to the appropriate position, according to your TV.

- If the color system of your TV is NTSC:
Set the COLOR SYSTEM switch to NTSC. Pictures will not be displayed if you set the switch to PAL. When you play a VIDEO CD recorded in the PAL color system, the picture will be stretched vertically and will be displayed with the lower part of the picture cut off.
- If the color system of your TV is PAL:
Set the COLOR SYSTEM switch to PAL. Pictures will not be displayed if you set the switch to NTSC. When you play a VIDEO CD recorded in the NTSC color system, the picture will be stretched horizontally and will be displayed with the upper and lower parts of the screen masked in black.
- If your TV automatically changes the color system according to the input signal:
Pictures will be displayed with the switch set to either NTSC or PAL.
If you set the COLOR SYSTEM switch to AUTO, the player automatically changes the color system of video output according to the color system of the VIDEO CD to be played. In this case, the color system selected remains until you unplug the player, or you play another VIDEO CD with a different color system. If you turn off the player, the color system will be set to PAL automatically when you turn on the player again.

Be sure to turn off and on the player when you change the setting.

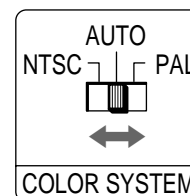

Setting the VOLTAGE SELECTOR (only on a model supplied with a voltage selector)

Check that the VOLTAGE SELECTOR on the rear panel of the player is set to the local power line voltage. If not, set the selector to the correct position using a screwdriver before connecting the AC power cord to a wall outlet.

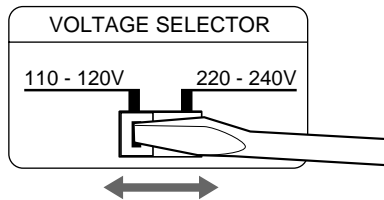

Connecting the AC power cord

Connect the AC power cord to a wall outlet.

Playing a VIDEO CD

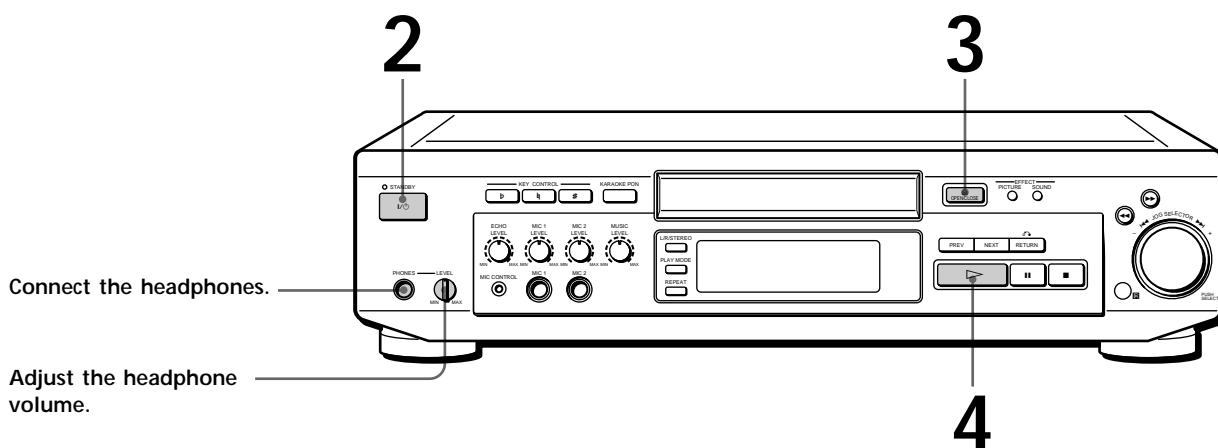

- See pages 5 – 7 for the hookup information.
- You can also play audio CDs just like VIDEO CDs.
- When you turn on the player, "SONY" logo appears on the TV screen. When you press any button, the logo disappears thereafter.

You can turn on or off the player using the remote. Press I/⏻ on the remote. You can also directly turn on the player by pressing the ⏻ OPEN/CLOSE or ▷ button on the player.

When playing VIDEO CDs with PBC functions
In Step 4, the menu screen appears on the TV screen. You can play the VIDEO CD interactively, following the instructions on the menu screen. (PBC Playback, see page 25.)

What is a VIDEO CD with PBC functions?
See page 25 or 29.

- 1** When using a TV
Turn on the TV and select the video input so that you can view the pictures from this player.
When using an amplifier
Turn on the amplifier and select the CD player position so that you can listen to the sound from this player.

- 2** Press I/⏻ to turn on the player.

- 3** Press ⏻ OPEN/CLOSE, and place the disc on the disc tray.

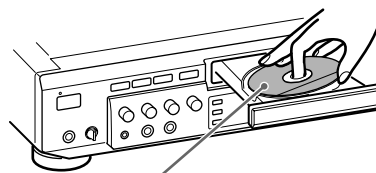

With the label side up

- 4** Press ▷.
The disc tray closes and the player plays all the tracks once (Continuous Play). Adjust the volume on the TV or the amplifier.

💡 When "RESUME" appears in the front panel display
You can resume playback from the point you stopped the VIDEO CD (Resume Play, see page 14).

💡 The player enters standby mode automatically (Sleep function)
When 20 minutes elapse after the player stops, it enters standby mode.

To stop playback

Press ■.

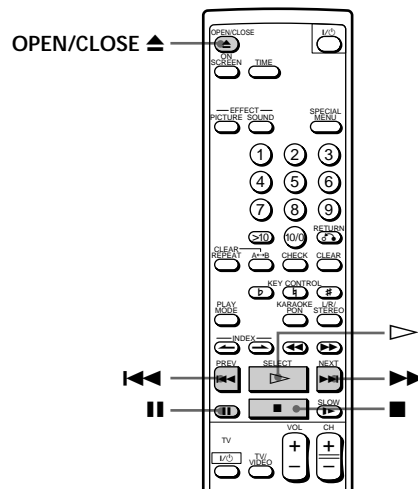
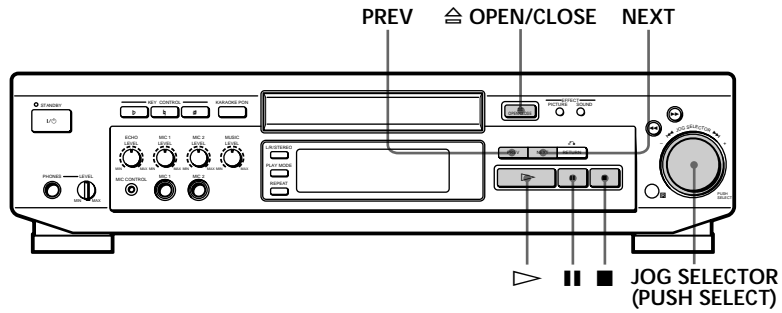

💡 What is a track?
A disc is divided into sections of a picture or a music piece called "tracks." Each track is assigned with a track number to locate the track you want.

To	Press
Pause	■
Start playing after pause	■ or ▷
Select the track (in Continuous Play mode)	<p>While playing, on the player:</p> <ul style="list-style-type: none"> • Turn JOG SELECTOR to select the track number • Press NEXT to go to the next scene or track • Press PREV to go back to the preceding scene or track <p>While playing, on the remote:</p> <ul style="list-style-type: none"> • Press ►► to go to the next scene or track • Press ◄◄ to go back to the preceding scene or track <p>Before you start playing: Turn JOG SELECTOR, or press NEXT, PREV, ◄◄ or ►► to select the track number, then press JOG SELECTOR or ▷</p>
Stop play and remove the CD	◻ OPEN/CLOSE

Playing Karaoke

You can play karaoke (singing along) with CDs. Be sure to set the on-screen display mode to ON SCREEN 1 or ON SCREEN 2 (see page 12). If you select ON SCREEN OFF display mode, no information is shown on the TV screen.

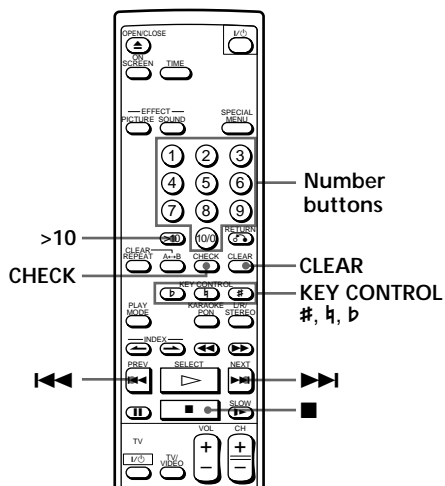
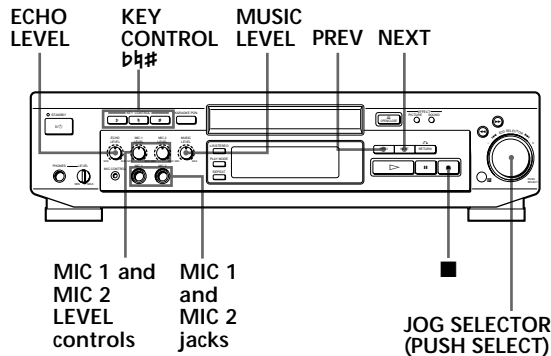

- 1 Set MIC 1 and MIC 2 LEVEL to MIN, then plug the microphone(s) into the MIC 1 and/or MIC 2 jacks.

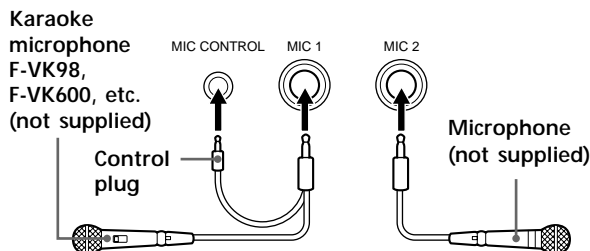

When using the karaoke microphone F-VK98, F-VK600, etc. (not supplied), plug the control plug into the MIC CONTROL jack. Note that the CHOI-MODOSHI function does not work when you plug a microphone with a control plug to this player.

- 2 Select the track you want to play.

On the player

Turn JOG SELECTOR until the track number you want to play appears in the front panel display, then press JOG SELECTOR.

On the remote

Press the number button of the track.

To select a track numbered over 10, use the >10 button (see page 15).

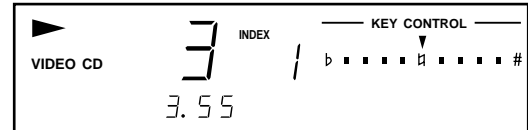

Example: when you select track 3

Play starts automatically.

- 3 Turn MIC 1 and/or MIC 2 LEVEL to adjust the microphone volume.

To stop playback

Press ■.

Notes

- If howling occurs:
 - Move the microphone(s) away from the TV or the speakers.
 - Lower the volume of the TV or the amplifier.
 - Lower the microphone volume or echo level.
- If the sound is distorted when the player is connected to a TV:
 - Lower the microphone volume and music level.
- The microphone volume will be turned off during the search operation.





When you don't use the microphone(s)

Unplug the microphone(s), switch the microphone(s) off and turn the MIC 1 and/or MIC 2 LEVEL control to MIN.

Reserving the next tracks to play

While playing a disc, you can reserve up to 24 tracks to play in any order so that you can enjoy non-stop play.

- 1 Do Steps 1 and 2 on “Creating Your Own Program (Program Play)” on pages 20 and 21.
- 2 Press \triangleright to start play.

When you want to	Press
Play the current track again	PREV or \lll
Go to the next specified track	NEXT or \ggg
Check the track order 	CHECK. The tracks appear in the order they were programmed on the front panel display.
Cancel the reservation 	CHECK repeatedly until the track number you want to cancel appears on the front panel display. Then press CLEAR.
Clear all the reservation	\blacksquare (stop) twice. Create a new reservation following the above procedure.

Changing the key (Key Control)

You can change the key to suit your vocal range.

While playing karaoke, press one of the KEY CONTROL buttons repeatedly to find the key that suits your vocal range.

To	Press
Raise the key	#
Lower the key	b
Return to the original key	h

You can adjust the key to 11 steps (5 steps higher, 5 steps lower and the original key).

The setting appears in the front panel display and on the TV screen.

 When you locate another track during playback
The key automatically returns to the original key.

 When a karaoke microphone (F-VK98, F-VK600, etc.) is connected
You can change the key with KEY CONTROL #/b on the microphone.

Note

While you're watching Slide Show, the KEY CONTROL buttons become inoperable.

Adjusting the echo level

You can give an echo effect to the sound from the microphones.

Turn ECHO LEVEL to adjust the strength of echo. The same echo level is applied to both microphones connected to the MIC 1 and MIC 2 jacks.

Note

If you don't want any echo effect, set the ECHO LEVEL control to MIN.

Adjusting the music level

If you want to reduce the music level, turn MUSIC LEVEL to MIN.

This has no effect on the settings of the MIC LEVEL 1/2 controls.

Note

When playing a CD as a general CD, turn the MUSIC LEVEL control to MAX.

Using the On-Screen Display

You can check the operating status of the player and the information about the disc with the on-screen display on the TV screen.

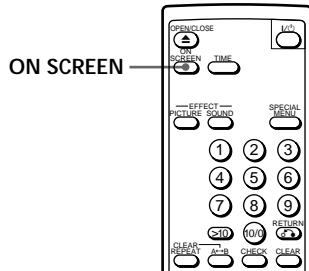

Press ON SCREEN.

Each time you press the button, the on-screen display changes as follows:

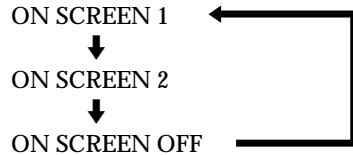

When using a VIDEO CD

■ Display information of ON SCREEN 1 mode

The track number is displayed for a few seconds when you start playing or select the track.
The operating status is displayed for a few seconds when you change the operating status.

Track number

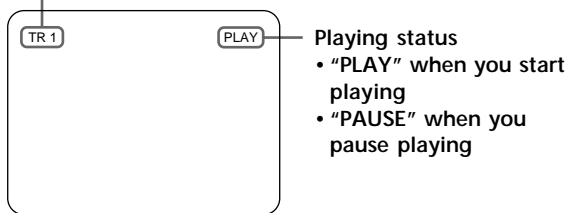

- Before you start playing (except for the Program Play mode)

When Resume Play is available

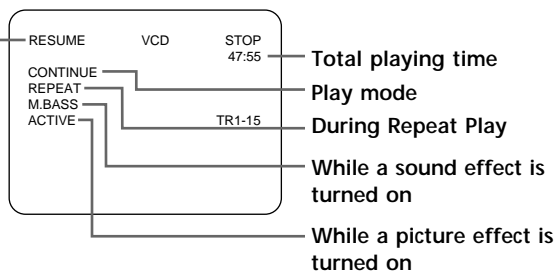

- Before you start playing in Program Play mode

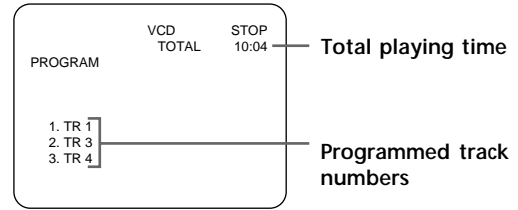

■ Display information of ON SCREEN 2 mode

While playing a disc, the current track number and the playing time are always displayed.
The operating status is displayed for a few seconds only when you change the operating status.
The same information as in ON SCREEN 1 is displayed before you start playing.

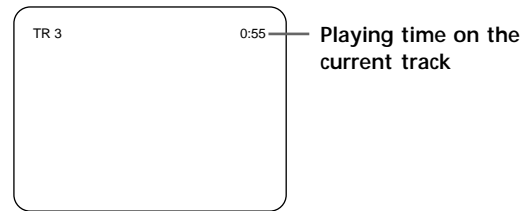

- During PBC Playback (page 25)

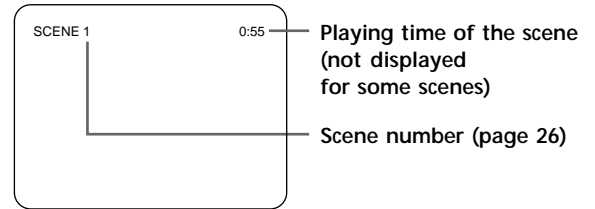

■ Display information of ON SCREEN OFF mode

No information is displayed.

When using an audio CD

The same information is displayed in ON SCREEN 1 mode and ON SCREEN 2 mode while playing an audio CD.

■ Display information of ON SCREEN 1 or ON SCREEN 2

- In Continuous or Shuffle Play mode

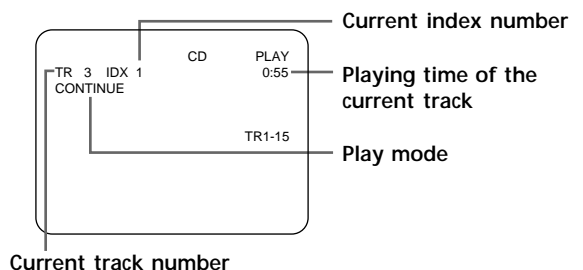

- In Program Play mode

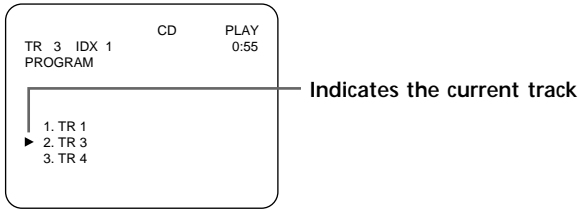

- Before you start playing (except for the Program Play mode)

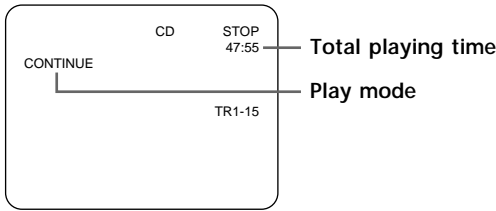

- Before you start playing in Program Play mode

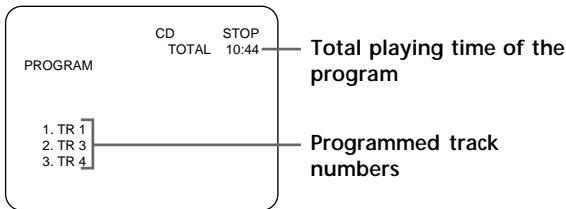

■ Display information of ON SCREEN OFF mode

No information is displayed.

Notes

- Select the display mode other than ON SCREEN OFF for normal operation. When you select ON SCREEN OFF, you cannot check the operating status while operating the player. In this case, check the information in the front panel display.
- When you record the playback picture of this player on another VCR, etc., be sure to select ON SCREEN OFF. Otherwise, the display information is also recorded on the VCR.

Using the Front Panel Display

You can check information about the disc using the front panel display.

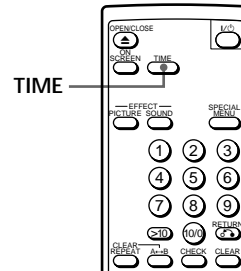

Checking the total number and playing time of the tracks

Press TIME before you start playing.

The front panel display shows the total number of tracks and total playing time.

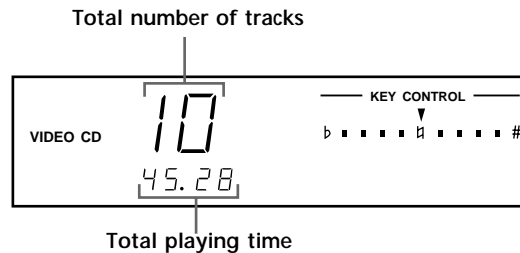

The information also appears when you press the OPEN/CLOSE  button to close the disc tray.

Display information while playing a disc

While playing an audio CD or a VIDEO CD without PBC functions, the front panel display shows the current track number, playing time of the track and index number (page 16).

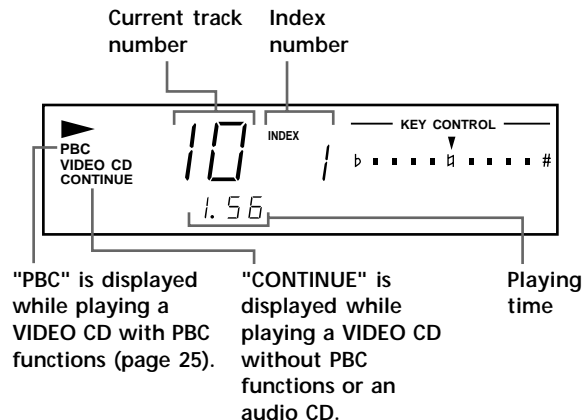

(Continued)

Checking the remaining time

Each time you press the TIME button while playing a disc, the display changes as shown in the chart below. Note that you cannot check the remaining time during PBC Playback (page 25).

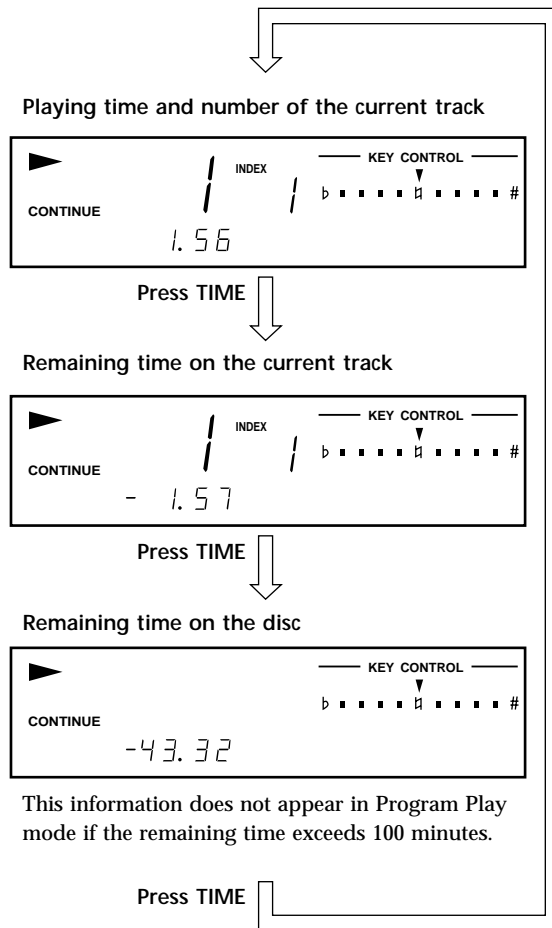

This information does not appear in Program Play mode if the remaining time exceeds 100 minutes.



What is a track?

A disc is divided into sections of a picture or a music piece called "tracks." Each track is assigned with a track number to locate the track you want.

Resuming Playback from the Point You Stopped a Disc (Resume Play)

The player memorizes the point you stopped a disc and you can resume playback from that point. Resume Play is canceled if you unplug the player.

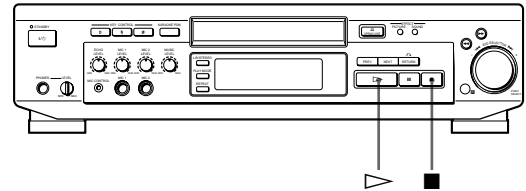

1 While playing a disc, press ■ to stop playback. "RESUME" appears in the front panel display and on the TV screen. If "RESUME" doesn't appear, Resume Play is not available.

2 Press ▷. The player starts playback from the point you stopped the disc in Step 1.



To view from the beginning of the VIDEO CD

When "RESUME" appears in the front panel display, press ■, then press ▷.

Notes

- Resume Play is not available in Digest, Shuffle, or Program Play mode.
- Depending on where you stopped the disc, the player may resume playback from a different point.
- If you play a CD audio track in a VIDEO CD with PBC function (see page 25) and resume playback, the background picture may change to blue. However, this is not a malfunction.

Locating a Specific Track

You can quickly locate any track while playing a disc using the JOG SELECTOR, ◀◀/▶▶ buttons (AMS: Automatic Music Sensor), PREV/NEXT buttons or number buttons.

Note that while playing a VIDEO CD with PBC functions, this function is available only during playback without PBC functions (PBC OFF, page 25).

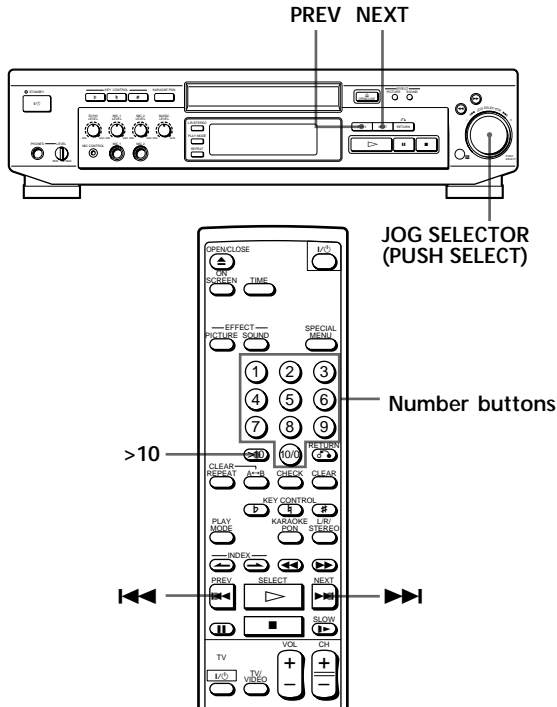

To locate	Press
The next or succeeding tracks (AMS)	NEXT or ▶▶ repeatedly, or turn JOG SELECTOR clockwise until you find the track
The current or preceding tracks (AMS)	PREV or ◀◀ repeatedly, or turn JOG SELECTOR counterclockwise until you find the track
A specific track directly	Number button of the track

- 💡 When you directly locate a track numbered over 10
 Press >10 first, then the corresponding number buttons. To enter "0," use button 10/0.
 Example: To play track number 30
 Press >10 first, then 3 and 10/0.

- 💡 What is a track?
 A disc is divided into sections of a picture or a music piece called "tracks." Each track is assigned with a track number to locate the track you want.

Note
 During PBC Playback, the JOG SELECTOR, PREV, NEXT, ◀◀ and ▶▶ buttons have different functions from the ones explained in the table above.

Locating a Point by Elapsed Time (Time Search)

This function lets you use elapsed time as a guide to find a certain point on a VIDEO CD. To use Time Search function with VIDEO CDs with PBC function (Ver. 2.0 discs), see the explanation below. "Elapsed" means the time from the beginning of the disc and is not the playing time of the current track.

Time Search function is especially useful when playing discs that have only a few track divisions.

This function cannot be used during Digest Play (see page 17).

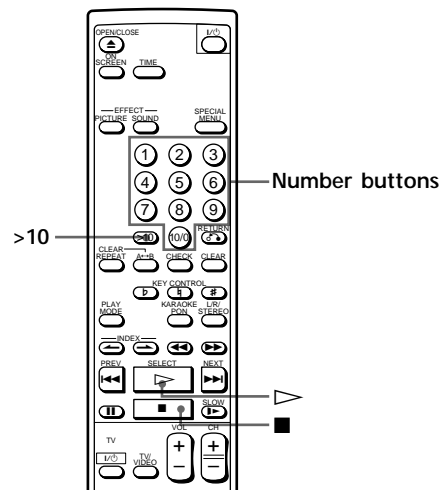

- 1 Press SPECIAL MENU while playing a disc or before you start playing.
 The following menu appears on the TV screen.

TV screen

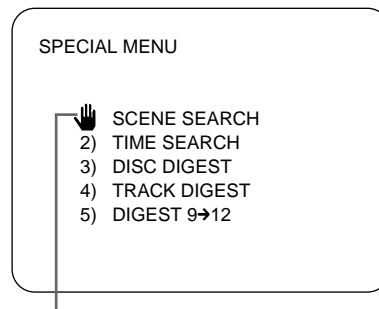

You cannot select the item with this mark.

- 2 Press button 2.
 - 3 Press the number buttons to to enter the time (in minutes) of the point that you want to locate. The entered time appears on the TV screen.
 - 4 Press ◻.
- Playback starts from the entered time.

To use Time Search function with VIDEO CDs with PBC function (Ver. 2.0 discs)

Do Steps 1 and 2 above before you start playing the VIDEO CD so that "PBC OFF" appears in the front panel display.

Locating a Particular Point in a Scene or Track

You can also locate a particular point in a scene or track while playing a disc.

During PBC Playback (page 25), this function is available only while playing moving pictures.

While playing an audio CD or a CD audio track in a VIDEO CD, changing the search speed while locating a point or Slow-motion Play is not available.

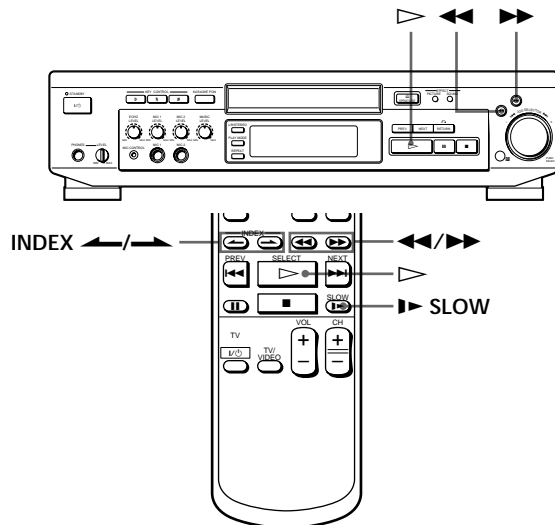

To locate a point	Press
While monitoring the picture or sound	▶▶ (forward) or ◀◀ (backward) repeatedly to select the speed (▶▶ or ◀◀ 1, ▶▶ or ◀◀ 2 or ▶▶ or ◀◀ 3). When you find the point, press ◀▶ to return to the normal speed. You will not hear the sound while playing a VIDEO CD. Note that you cannot change the search speed on audio CDs.
Slowly by observing the TV screen (Slow-motion Play)	▶▶ SLOW. You will not hear the sound during the operation. When you find the point, press ◀▶ to return to the normal speed.

💡 If you want to locate a particular point of a long track
It is convenient to use Track Digest (see page 18).

💡 If "⏮ ⏪" appears in the front panel display
The disc has reached the end after you pressed ▶▶. Press ◀◀ or ◀◀ to go back.

💡 If you want to change the playback speed during Slow-motion Play

Press ▶▶ SLOW repeatedly until you find the playback speed you want. Three speeds are available: SLOW 1, SLOW 2 and SLOW 3. Each time you press the button, the indication changes as follows.

→ SLOW 1 → SLOW 2 → SLOW 3

Notes

- While playing a VIDEO CD, the picture may be distorted during the search operation.
- While playing an audio CD or a CD audio track in a VIDEO CD, you can also locate a point as in the table in the left column.

Locating a point using the index (Index Search)

There are two kinds of indexes: one is for audio CDs and the other is for VIDEO CDs. You can locate a point you want using the index.

Note that this function is available only for indexed discs. Also note that you cannot search indexes in different tracks.

While playing a track, press INDEX ◀ or ▶ repeatedly.

- To locate the current or preceding index numbers, press INDEX ◀.
- To locate the next or subsequent index numbers, press INDEX ▶.

Front panel display

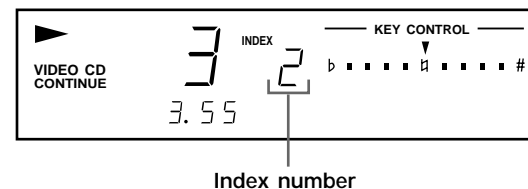

TV screen (when you press INDEX ◀ or ▶ while playing a VIDEO CD)
ON SCREEN 1 or 2 display mode

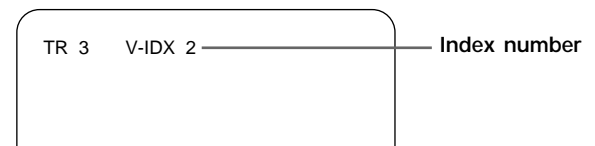

TV screen (while playing an audio CD)
ON SCREEN 1 or 2 display mode

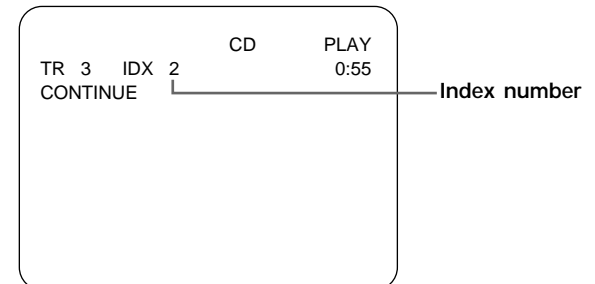

💡 What is an index?

It is a number that divides a track or a disc into some sections in order to easily locate the point you want. You may determine if a disc uses index by looking at the disc's packaging.

Note

If there are no more indexes while playing a VIDEO CD, "⏮ CANNOT OPERATE NOW" appears on the TV screen and the player continues playing.

Locating by Observing Several Scenes at One Time (Digest Play)

You can locate the track or scene you want by observing several still pictures at one time on the TV screen. You can also select the number of still pictures. Note that while playing a VIDEO CD with PBC functions, this function is available before you start playing or during playback without PBC functions (PBC OFF, page 25).

While playing a VIDEO CD, you will not hear the sound.

While playing an audio CD, you will only hear the sound.

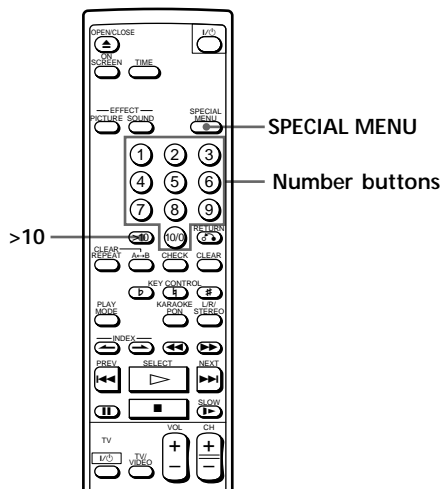

Specifying the number of still pictures

You can select either 9 or 12 of still pictures that appear on the TV screen during Disc Digest and Track Digest.

- 1 Press SPECIAL MENU while playing a disc or before you start playing. The following menu appears on the TV screen.

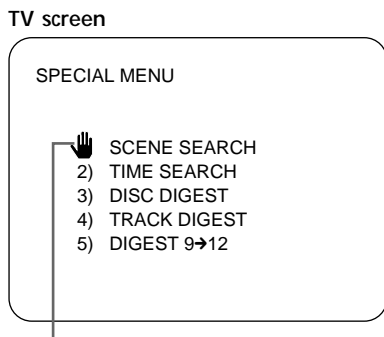

You cannot select the item with this mark.

- 2 Press button 5. Each time you press the button, the number toggles between 9 and 12. Select 9→12 for 9 still pictures; select 12→9 for 12 still pictures.

Locating the track you want on a disc (Disc Digest)

You can locate the track you want by observing the first picture of up to 9 or 12 tracks on the disc at one time on the TV screen.

- 1 Press SPECIAL MENU while playing a disc or before you start playing. The following menu appears on the TV screen.

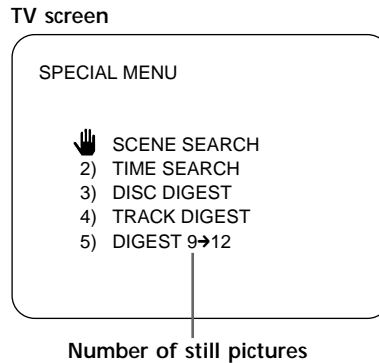

- 2 Press button 3. While playing a VIDEO CD, the TV screen shows still pictures of the first scenes of tracks 1 to 9 or 12 on the disc. While playing an audio CD, the beginnings of each track are played in sequence. → shows the track that the player is currently playing.

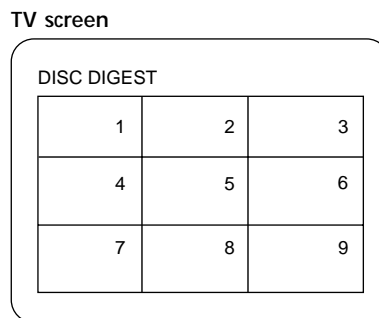

To view still pictures of the tracks numbered over 9 or 12

Press ►►. The TV screen shows still pictures of tracks 10 to 18 or 13 to 24.

If there are more tracks, "►►" is displayed on the upper right side of the TV screen.

To go back to the previous screen, press ◀◀.

(Continued)

Locating a Scene or Track You Want

- 3 Press the number button to select the track.
The player starts playing from the selected track.
To select tracks numbered over 10
Use the >10 button (see page 15).

To cancel Disc Digest

Press ■.

Notes

- The operable item of the special menu is different depending on discs or PBC function ON/OFF setting.
- If you start Disc Digest before you start playing a VIDEO CD with PBC functions, the player automatically starts playing without PBC functions (PBC OFF, page 25).
- When you start Disc Digest in Shuffle or Program Play mode, the player automatically enters Continuous Play mode (page 8).

Locating the point you want in a track (Track Digest)

You can have the player divide a track into 9 or 12 sections. You can locate the point you want by viewing the first picture of each section at one time on the TV screen. This might be useful when you play a disc which is divided into few tracks, such as a movie.

- 1 Press SPECIAL MENU while playing a disc or before you start playing.
The following menu appears on the TV screen.

TV screen

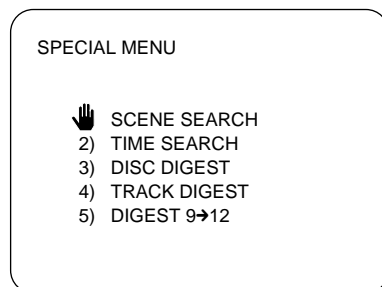

- 2 Press button 4.
While playing a VIDEO CD, the player divides the track into 9 or 12 sections and the TV screen shows still pictures of each section in order.
While playing an audio CD, the player divides the track into 9 or 12 sections and plays the beginnings of each section in sequence. → shows the section that the player is currently playing.

TV screen

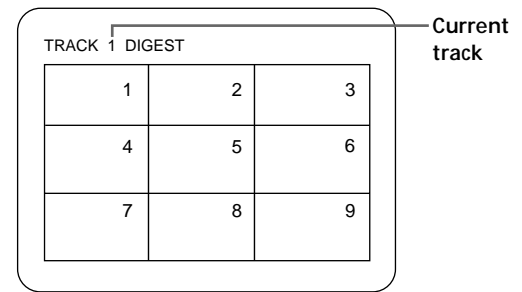

- 3 Press the corresponding number button to select the point you want.
The player starts playing from the selected point.
The player may start playing from a point which is a little different from the one displayed during Track Digest.

To cancel Track Digest

Press ■.

💡 You can select a point which isn't displayed yet on the TV screen in Step 2

💡 During Track Digest, you can start Track Digest on another track
Press ◀◀ or ▶▶.
Note that this function is not available in Shuffle or Program Play mode.

Notes

- If you start Track Digest before you start playing a VIDEO CD with PBC functions, the player automatically starts playing without PBC functions (PBC OFF, page 25).
- If you start Track Digest before you start playing in Shuffle or Program Play mode, the player automatically enters Continuous Play mode (page 8).
- When a track is shorter than about 40 seconds, the player may divide the track into less than 9 or 12 sections.

Playing Repeatedly

You can play all the tracks, a single track or a specific portion repeatedly.

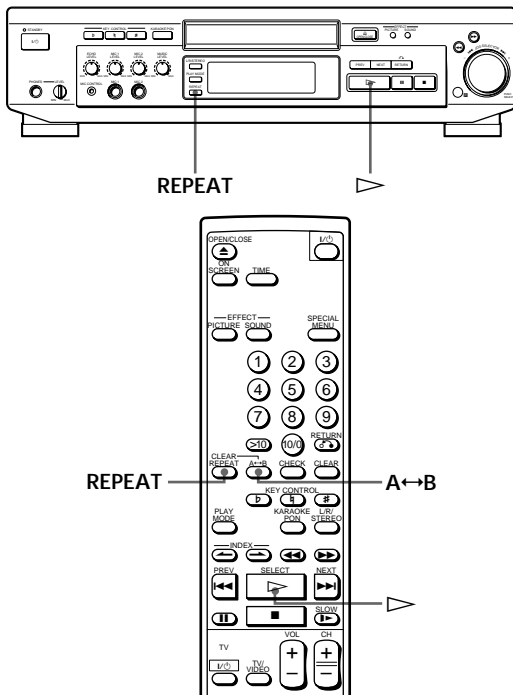

Repeating all the tracks on a disc

In Shuffle or Program Play mode, the player repeats the track in the shuffled or programmed order. You cannot do Repeat Play during PBC playback (page 25) or Digest Play (page 17).

Press REPEAT while playing a disc. "REPEAT" appears in the front panel display. The player repeats the tracks as follows:

When the disc is played in	The player repeats
Continuous Play (page 8)	All the tracks
Shuffle Play (page 20)	All the tracks in random order
Program Play (page 20)	The same program

To cancel Repeat Play

Press REPEAT repeatedly until "REPEAT" disappears from the front panel display.

Repeating the current track

You can repeat only the current track in Continuous Play mode (page 8).

While the track you want is being played, press REPEAT repeatedly until "REPEAT1" appears in the front panel display.

To cancel repeating the current track
Press REPEAT repeatedly until "REPEAT1" disappears from the front panel display.



Repeating a specific portion (A<->B Repeat)

You can play a specific portion in a track repeatedly. This might be useful when you want to memorize lyrics.

During PBC Playback (page 25), this function is available only while playing moving pictures.

- 1 While playing a disc, press A<->B when you find the starting point (point A) to be played repeatedly.
"A-" of "REPEAT A-" flashes in the front panel display.
- 2 When you reach the ending point (point B), press A<->B again.
"REPEAT A-B" appears. The player plays this specific portion repeatedly.

To cancel A<->B Repeat
Press REPEAT.

 When you want to restart from the starting point A
Press  during A<->B Repeat.

Note

If you start Slow-motion Play during A<->B Repeat, Slow-motion Play is canceled when the player returns to the point A.

Playing in Random Order (Shuffle Play)

You can have the player “shuffle” tracks and play in a random order.

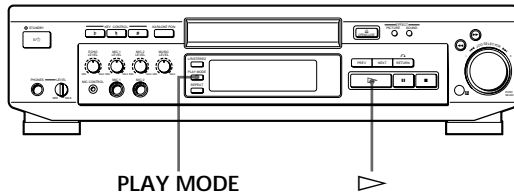

- 1 Press PLAY MODE repeatedly until “SHUFFLE” appears in the front panel display.

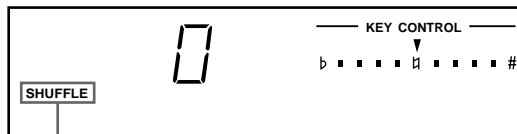

“SHUFFLE” is lit

- 2 Press to start Shuffle Play. The indication appears while the player is “shuffling” the tracks.

To cancel Shuffle Play

Press PLAY MODE repeatedly until “CONTINUE” appears in the front panel display. (When you want to play a VIDEO CD with PBC functions, be sure to press PLAY MODE repeatedly until “SHUFFLE” disappears from the front panel display.)

You can start Shuffle Play while playing in Continuous Play mode

Press PLAY MODE repeatedly until “SHUFFLE” appears in the front panel display. Shuffle Play starts from the current track.

Note

If you play a VIDEO CD with PBC functions in Shuffle Play mode, you cannot use the PBC functions.

Creating Your Own Program (Program Play)

You can arrange the order of the tracks on the discs and create your own program. The program can contain up to 24 tracks.

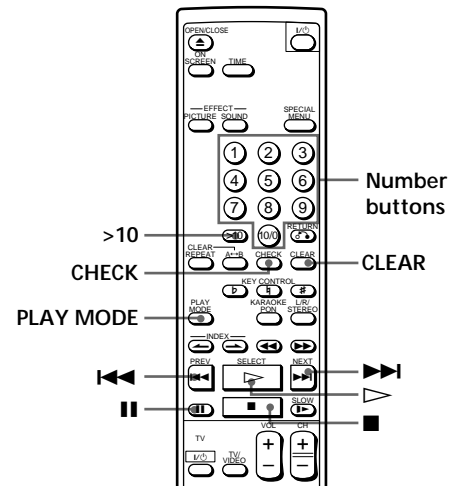
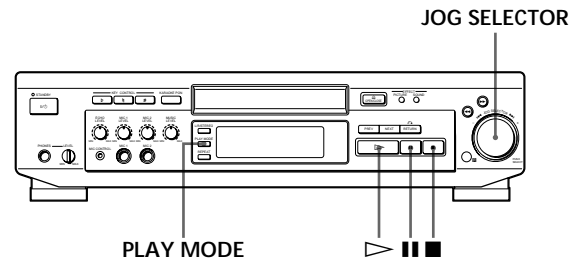

- 1 Press PLAY MODE repeatedly until “PROGRAM” appears in the front panel display.

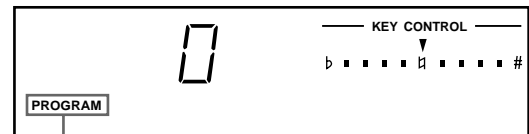

“PROGRAM” is lit

Enjoying Picture Effects

You will get a clear-cut picture by emphasizing the outline of the pictures without increasing noise on the picture or you can enjoy a picture which luminance is reduced just like the picture on the movie theater screen.

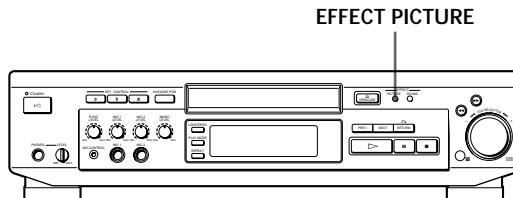

Getting a clear-cut picture (Active Picture)

Press EFFECT PICTURE repeatedly until "ACTIVE" appears in the front panel display.

Getting a movie-theater-like picture (Theater Picture)

Press EFFECT PICTURE repeatedly until "THEATER" appears in the front panel display.

To cancel the picture effect

Press EFFECT PICTURE repeatedly until "ACTIVE" or "THEATER" disappears from the front panel display.

Note

The Active Picture and Theater Picture functions are not available while playing an audio CD.

Enjoying Sound Effects

You can play a disc with one of two acoustic atmospheres: M(ega).BASS or EX(tra).WIDE.

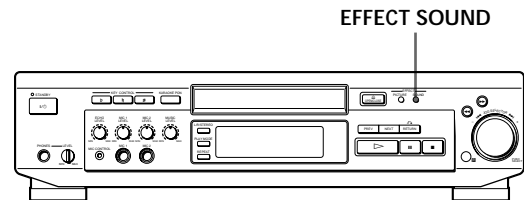

While playing a disc, press EFFECT SOUND repeatedly until the desired effect appears in the front panel display.

Effect mode	Atmosphere
M.BASS	Emphasizes the bass
EX.WIDE	Provides a greater sense of expanse

Switching the Sound

You can select the sound from the right or left channel and listen to the sound of the selected channel through both the right and left speakers. In this case, the sound loses the stereo effect.

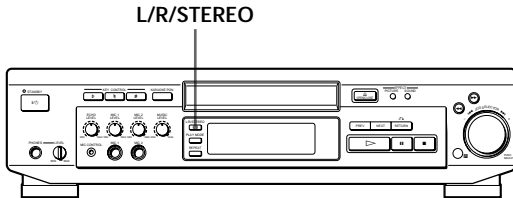

Press L/R/STEREO while playing a disc. Each time you press the button, the indication and the sound from the speakers change as follows:

Press	Indication*	You will hear
Once	MONO L	The sound of the left channel
Twice	MONO R	The sound of the right channel
Three times	STEREO**	The standard stereo sound

* When you select ON SCREEN OFF display mode, check the indication on the front panel display.

** This indication doesn't appear in the front panel display.

Controlling the TV with the Supplied Remote

You can control Sony TVs with the  mark using the supplied remote.

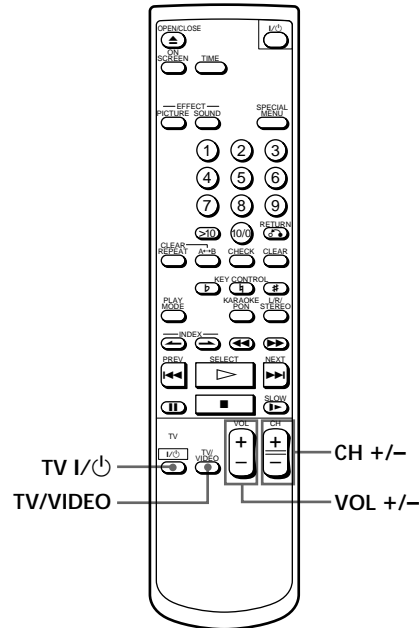

Press	You can
TV I/Power	Turn on or off the TV
TV/VIDEO	Select the input source to the TV
VOL +/-	Adjust the volume of the TV
CH +/-	Change the channel of the TV

Playing Karaoke with Any Stereo Discs (Karaoke Pon)

You can enjoy karaoke with a stereo-recorded disc, even if it is a non-karaoke disc, by reducing the singer's voice.

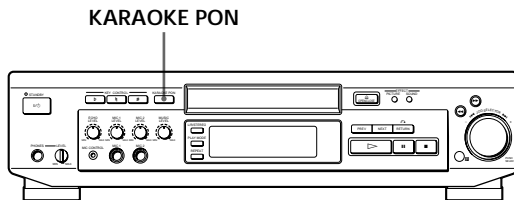

Press KARAOKE PON.

"K. PON" appears in the front panel display and on the TV screen.

This reduces the singer's voice so that you can enjoy karaoke. However, this also reduces the stereo effect.

To cancel Karaoke Pon

Press KARAOKE PON again. "K. PON" disappears from the front panel display.



When you use Karaoke Pon

Use stereo-recorded discs.

Notes

- Karaoke Pon may not work well for the following cases:
 - Monaural-recorded discs (The accompaniment is also reduced.)
 - Only a few instruments are playing in the stereo-recorded disc
 - A duet is being played
 - The disc has strong echoes or chorus
 - The singer's voice on the disc deviates from the center
 - Multiplex discs
- When you select ON SCREEN OFF display mode, no information is shown on the TV screen.
- When you turn on the Karaoke Pon function, EX.WIDE sound effect turns off automatically; when you turn off the function, EX.WIDE sound effect turns on automatically.

Playing VIDEO CDs with PBC Functions (PBC Playback)

When playing VIDEO CDs with PBC functions (Ver. 2.0 discs), you can enjoy playing simple interactive software, software with search functions, etc. PBC Playback allows you to play VIDEO CDs interactively, following the menu screen on the TV screen.

You can use the number buttons, JOG SELECTOR, SELECT, PREV, NEXT and RETURN during PBC Playback.

Also refer to the instructions supplied with the disc, as the operating procedure may differ according to the VIDEO CD.

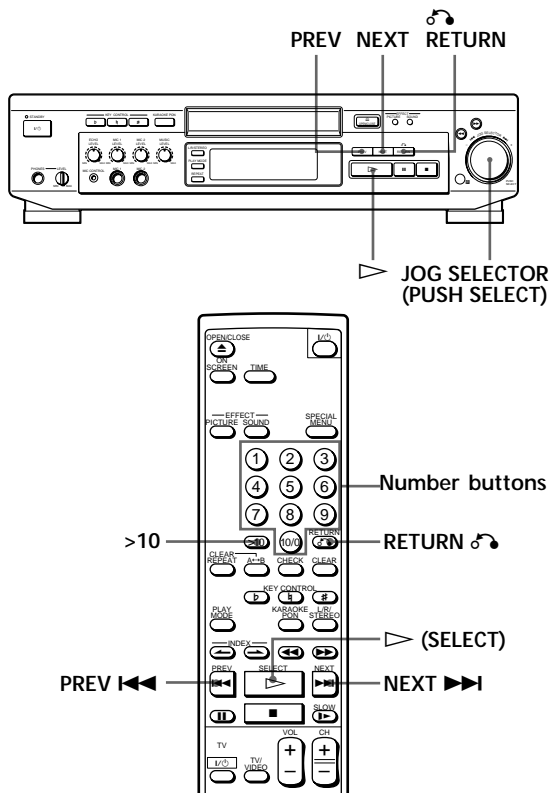

- 1 Start playing a VIDEO CD with PBC functions, following Steps 1 through 4 in "Playing a VIDEO CD" on page 8.

The menu screen appears on the TV screen and "SELECT" flashes.

- 2 Select the item number you want.

On the player

Turn JOG SELECTOR to select the item number, then press JOG SELECTOR.

On the remote

Press the number button of the item you want.

When you want to select an item number over 10, press >10 first, then the corresponding number buttons. To enter "0," use button 10/0.

Example: To select item number 30

Press >10 first, then 3 and 10/0.

- 3 Follow the instructions on the menu screen for interactive operations.

When	Do the following
Selecting the item	Turn JOG SELECTOR on the player to select the item number, then press JOG SELECTOR.
	Press the number button of the item you want on the remote.
"SELECT" is flashing on the TV screen while playing moving pictures	In this case, you can go to another scene even while playing moving pictures. Turn JOG SELECTOR then press JOG SELECTOR on the player, or press the number button of the item you want on the remote.
Going back to the menu screen	Press RETURN, PREV or NEXT. (Also refer to the instructions supplied with the disc, as the operating procedure may differ according to the VIDEO CD.)

When "CANNOT OPERATE NOW" appears on the TV screen

You've pressed an invalid button. Press the correct button, following the instructions on the menu screen.

To cancel PBC Playback of a VIDEO CD with PBC functions and play the disc in Continuous Play mode (PBC OFF)

There are two ways.

- Before you start playing, select the track you want with JOG SELECTOR, PREV, NEXT or <<</>>>, then press JOG SELECTOR or >.
- Before you start playing, select the track number using the number buttons on the remote.

"PBC OFF" and "CONTINUE" appear in the front panel display and the player starts Continuous Play. You cannot play still pictures such as a menu screen.

You can use > instead of JOG SELECTOR after turning JOG SELECTOR.

Note

When you scan the still pictures in the Slide Show, the last picture may not appear.

Example of PBC Playback

This is an example of PBC Playback. Also refer to the instructions supplied with the disc, as the operating procedure may differ according to the VIDEO CD.

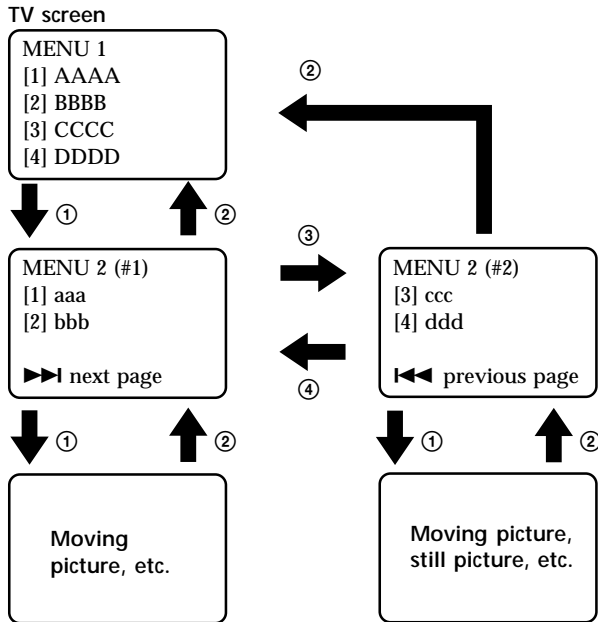

- ① To select the item:
Turn JOG SELECTOR to select the item number, then press JOG SELECTOR, or select the number button you want on the remote.
- ② To go to the preceding menu:
Press RETURN .
- ③ To go to the next page of the menu:
Press NEXT.
- ④ To go back to the preceding page of the menu:
Press PREV.

Locating Scenes Directly Using the Scene Numbers (Scene Search)

On VIDEO CDs with PBC functions, the menu screens, moving pictures and still pictures are divided into "scenes" and each scene is assigned with a scene number.

You can check the current scene number by displaying it on the TV screen during playback (see page 12). Be sure to memorize the scene number from which you want to start playing.

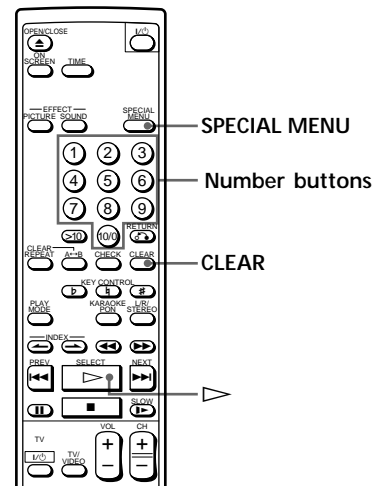

- 1 Press SPECIAL MENU before you start playing or while playing a disc.
The following menu appears on the TV screen while playing a disc.

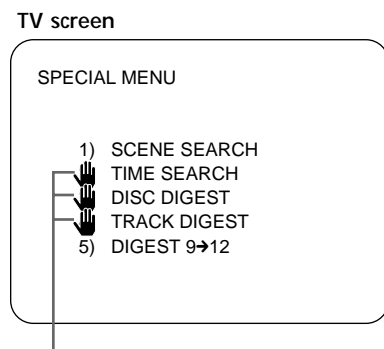

You cannot select the item with this mark.

- 2 Press button 1.
"SCENE -" and the scene numbers appear on the TV screen.

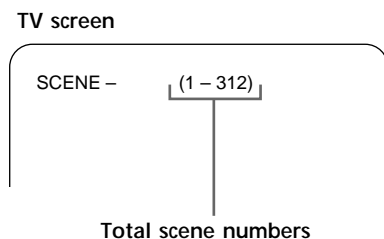

- 3** Press the number buttons (1 – 10/0) to select the scene.

To enter “0”, use the button 10/0.

Example: To select scene number 103

Press 1, then 10/0 and 3.

The selected scene number appears on the TV screen.

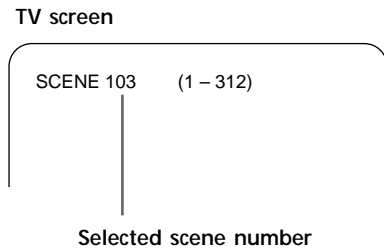

If you've made a mistake

Press CLEAR, then press the correct number button.

- 4** Press \triangleright to start playing from the selected scene. The player automatically starts PBC Playback (page 25).



You can check the scene number while playing a disc

Press ON SCREEN repeatedly to select ON SCREEN 2 display mode (see page 12). The scene numbers appear on the upper left side of the TV screen.

Notes

- Some discs don't allow you to start playing from a particular scene. In this case, when you do the task before you start playing, the player starts playing from scene 1. When you do the task while playing a disc, the player starts playing from the current scene.
- Some discs don't display the selected scene on the TV screen.
- When you select ON SCREEN OFF display mode, no information is shown on the TV screen.

Notes on Discs

On handling discs

- To keep the disc clean, handle the disc by its edge. Do not touch the surface.
- Do not stick paper or tape on the disc.
If there is glue (or a similar substance) on the disc, remove the glue completely before using the disc.

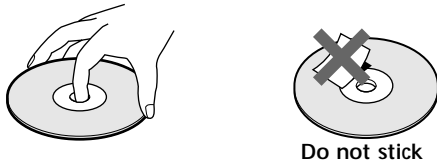

- Do not expose the disc to direct sunlight or heat sources such as hot air ducts, or leave it in a car parked in direct sunlight as there can be considerable rise in temperature inside the car.
- After playing, store the disc in its case.
- Only regular circular discs can be used in this VIDEO CD player. Irregularly shaped discs, such as star- or heart-shaped discs, may damage the player.

On cleaning

- Before playing, clean the disc with a cleaning cloth. Wipe the disc from the center out.

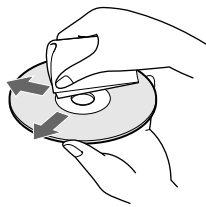

- Do not use solvents such as benzene, thinner, commercially available cleaners or anti-static spray intended for vinyl LPs.

Troubleshooting

If you experience any of the following difficulties while using the player, use this troubleshooting guide to help you remedy the problem. Should any problem persist, consult your nearest Sony dealer.

There's no sound.

- ➔ Check that the player is connected securely.
- ➔ Make sure you operate the TV or the amplifier correctly.
- ➔ Make sure you select the CD player position on the amplifier.

There's no picture.

- ➔ Check that the player is connected securely.
- ➔ Make sure you operate the TV correctly.
- ➔ Make sure you set the COLOR SYSTEM switch correctly, according to your TV.

The picture is distorted.

- ➔ Clean the disc (see page 28).

The disc doesn't play.

- ➔ There's no disc inside ("no DISC" appears).
Insert a disc.
- ➔ Insert the disc with the label side up on the disc tray correctly.
- ➔ Clean the disc (see page 28).
- ➔ Moisture has condensed inside the player.
Remove the disc and leave the player turned on for about an hour (see page 2).

The sound loses stereo effect.

- ➔ "MONO R" or "MONO L" appears in the front panel display (see page 23).

The remote doesn't function.

- ➔ Remove the obstacles in the path of the remote and the player.
- ➔ Point the remote at the remote sensor  on the player.
- ➔ Replace all the batteries in the remote with new ones if they are weak.

There's no sound from the microphone.

- ➔ Switch the microphone on.
- ➔ Turn the MIC 1 and/or MIC 2 LEVEL controls clockwise.

Howling occurs.

- ➔ Move the microphone away from the speakers.
- ➔ Lower the volume.
- ➔ Lower the microphone volume or echo level.

The player doesn't play from the first track when playing a VIDEO CD without PBC functions or an audio CD.

- ➔ Press PLAY MODE repeatedly until "CONTINUE" appears in the front panel display, then press .

Specifications

VIDEO CD player

Laser Semiconductor laser ($\lambda = 780 \text{ nm}$)
Emission duration: Continuous

Laser output Max 44.6 μW *
* This output is the value measured at a distance of 200 mm from the objective lens surface on the Optical Pick-up Block with 7 mm aperture.

Wavelength 780 – 790 nm

Signal format system NTSC, PAL

Frequency response 2 Hz to 20 kHz $\pm 1 \text{ dB}$

Outputs

	Jack type	Maximum output level	Load impedance
AUDIO OUT	Phono jacks	1.43 V (at 100 kilohms)	Over 10 kilohms
VIDEO OUT	Phono jack	1 Vp-p	75 ohms, unbalanced, sync negative, white peak
S VIDEO OUT	4-pin mini DIN	Y: 1 Vp-p C: 0.286 Vp-p	75 ohms, unbalanced, sync negative
PHONES	Phone jack	10mW	32 ohms

Inputs

	Jack type	Maximum input level	Load impedance
MIC 1, MIC 2	Phone jacks	100 mVp-p	600 ohms

General

Power requirements (model for Thai)
220 V AC, 50/60 Hz
(model for other countries)
110 – 120 V or 220 – 240 V AC, adjustable, 50/60 Hz

Power consumption 25 W

Dimensions (approx.) (w/h/d) 430 × 108 × 350 mm incl. projecting parts

Mass (approx.) 4.6 kg

Supplied accessories

- Audio and video connecting cord (1)
- Remote commander (remote) RMT-F88V (1)
- Sony R6 (size AA) batteries (2)

Design and specifications are subject to change without notice.

Glossary

Auto Pause

Automatic pause function that works according to the signal encoded on the disc during PBC playback. In this case, "AUTO II" appears in the front panel display. If the player doesn't resume play for a long time, press II or ▷ to resume play manually.

PBC Playback

Playback using the menu screens recorded on VIDEO CDs with PBC functions. You can enjoy simple interactive operations using the PBC Playback function.

Playback Control (PBC)

Signals encoded on VIDEO CDs (Version 2.0) to control playback.

By using menu screens recorded on VIDEO CDs with PBC functions, you can enjoy playing simple interactive software, software with search functions, and so on.

When you insert a VIDEO CD with PBC functions on this player, "PBC" appears in the front panel display.

Track

Sections of a picture or a music piece on a disc. Each track is assigned with a track number to locate the track you want.

VIDEO CD

A compact disc that contains moving pictures. The picture information uses the MPEG 1 format, one of the world wide standards of digital compact technology. The picture information is compressed about 120 times. Consequently, a 12 cm VIDEO CD can contain up to 74 minutes of moving pictures.

VIDEO CDs also contain compact audio information. Sounds outside the range of human hearing are compressed while the sounds we can hear aren't compressed. VIDEO CDs can hold 6 times the audio information of conventional audio CDs.

There are 2 versions of VIDEO CDs.

- Version 1.1: You can play only moving pictures and sounds.
- Version 2.0: You can play high-resolution still pictures and enjoy PBC functions.

This player conforms to both versions.

Index

A, B

- A-B repeat 19
- Active picture 22
- Adjusting
 - echo level 11
 - microphone volume 10
 - music level 11
 - volume 8
- AMS 15
- Auto Pause 29
- Automatic Music Sensor. *See* AMS

C

- Color system switch 6
- Connecting 5
- Continuous play 8

D, E

- Digest Play 17
- Disc Digest 17
- Display
 - front panel display 13
 - on-screen display 12
- Echo 11

F, G

- Front panel display 13

H

- Handling CDs 28
- Hooking up 5

I, J, K

- Index 16
- Index Search 16
- Karaoke Play 10
- Karaoke Pon 24
- Key control 11

L, M, N

- Locating
 - a specific point 16
 - a specific scene 26
 - a specific track 15
 - by monitoring 16
 - by observing the front panel display 16
 - directly 15
 - using AMS 15
 - using index 16

O

- On-screen display 12

P, Q

- PBC functions 25, 29
- PBC Playback 25, 29
- Playback
 - Continuous Play 8
 - Karaoke Play 10
 - Program Play 20
 - Repeat Play 19
 - Shuffle Play 20
- Program
 - changing 21
 - checking 21

R

- Remaining time 14
- Remote control 4
- Repeating 19
- Reserving the next tracks 11
- Resume Play 14

S

- Scene 26
- Scene Search 26
- Searching. *See* Locating
- Shuffle Play 20
- Slow-motion Play 16
- Specifying number of still pictures 17

T

- Theater picture 22
- Total playing time 13
- Track Digest 18
- Troubleshooting 28

U



- Unpacking 4

V, W, X, Y, Z

- VIDEO CDs 4, 8, 29

Names of controls

Buttons

- A↔B 19
- CH +/- 23
- CHECK 10, 20
- CLEAR 10, 20, 26
- EFFECT PICTURE 22
- EFFECT SOUND 22
- INDEX ◀/▶ 16
- KARAOKE PON 24
- KEY CONTROL  # 10
- L/R/STEREO 23
- Number 10, 15, 17, 20, 25, 26
- ON SCREEN 12
- ≡ OPEN/CLOSE 8, 9
- PLAY MODE 20
- PREV/NEXT 9, 10, 15, 25
- REPEAT 19
- RETURN  25
- ▶ SLOW 16
- SPECIAL MENU 17, 26
- TIME 13
- TV/VIDEO 23
- TV I/⏻ 23
- VOL +/- 23
- ▷ 8, 9, 14-16, 19, 20, 25, 26
- 9, 20
- 9, 10, 14, 15, 20
- ◀◀/▶▶ 9, 10, 15, 20, 25
- ◀◀/▶▶ 16
- >10 10, 15, 17, 20, 25

Switch

- I/⏻ (on/standby) 8

Control

- ECHO LEVEL 10
- JOG SELECTOR 9, 10, 15, 20, 25
- MIC 1, MIC 2 LEVEL 10
- MUSIC LEVEL 11
- PHONES LEVEL 8

Jack

- MIC CONTROL 10
- MIC 1, MIC 2 10
- PHONES 8

Others

- Disc tray 8
- Front panel display 13
-  4

Free Manuals Download Website

<http://myh66.com>

<http://usermanuals.us>

<http://www.somanuals.com>

<http://www.4manuals.cc>

<http://www.manual-lib.com>

<http://www.404manual.com>

<http://www.luxmanual.com>

<http://aubethermostatmanual.com>

Golf course search by state

<http://golfingnear.com>

Email search by domain

<http://emailbydomain.com>

Auto manuals search

<http://auto.somanuals.com>

TV manuals search

<http://tv.somanuals.com>