

DVD Recorder

Operating Instructions

RDR-GX257



WARNING

To reduce the risk of fire or electric shock, do not expose this apparatus to rain or moisture.

To avoid electrical shock, do not open the cabinet. Refer servicing to qualified personnel only.

Batteries or batteries installed apparatus shall not be exposed to excessive heat such as sunshine, fire or the like.

CAUTION

The use of optical instruments with this product will increase eye hazard. As the laser beam used in this DVD recorder is harmful to eyes, do not attempt to disassemble the cabinet. Refer servicing to qualified personnel only.

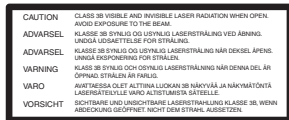

This label is located on the laser protective housing inside the enclosure.



This symbol is intended to alert the user to the presence of uninsulated "dangerous voltage" within the product's enclosure that may be of sufficient magnitude to constitute a risk of electric shock to persons.



This symbol is intended to alert the user to the presence of important operating and maintenance (servicing) instructions in the literature accompanying the appliance.

For customers in the U.S.A

Owner's Record

The model and serial numbers are located at the rear of the unit.

Record the serial number in the space provided below. Refer to them whenever you call upon your Sony dealer regarding this product.

Model No. RDR-GX257
Serial No. _____

CAUTION

You are cautioned that any change or modifications not expressly approved in this manual could void your authority to operate this equipment.

Note

This equipment has been tested and found to comply with the limits for a Class B digital device, pursuant to Part 15 of the FCC Rules. These limits are designed to provide reasonable protection against harmful interference in a residential installation. This equipment generates, uses, and can radiate radio frequency energy and, if not installed and used in accordance with the instructions, may cause harmful interference to radio communications. However, there is no guarantee that interference will not occur in a particular installation. If this equipment does cause harmful interference to radio or television reception, which can be determined by turning the equipment off and on, the user is encouraged to try to correct the interference by one or more of the following measures:

- Reorient or relocate the receiving antenna.
- Increase the separation between the equipment and receiver.
- Connect the equipment into an outlet on a circuit different from that to which the receiver is connected.
- Consult the dealer or an experienced radio/TV technician for help.

Precaution

Install this system so that the mains lead (the power cord) can be unplugged from the wall socket immediately in the event of trouble.

Precautions

On safety

Should any solid object or liquid fall into the cabinet, unplug the recorder and have it checked by qualified personnel before operating it any further.

On power sources

- The recorder is not disconnected from the AC power source (mains) as long as it is connected to the wall outlet, even if the recorder itself has been turned off.
- If you are not going to use the recorder for a long time, be sure to disconnect the recorder from the wall outlet. To disconnect the AC power cord (mains lead), grasp the plug itself; never pull the cord.

On placement

- Place the recorder in a location with adequate ventilation to prevent heat build-up in the recorder.
- Do not place the recorder on a soft surface such as a rug that might block the ventilation holes.
- Do not place the recorder in a confined space such as a bookshelf or similar unit.
- Do not place the recorder in a location near heat sources, or in a place subject to direct sunlight, excessive dust, or mechanical shock.
- Do not place the recorder in an inclined position. It is designed to be operated in a horizontal position only.
- Keep the recorder and discs away from equipment with strong magnets, such as microwave ovens, or large loudspeakers.
- Do not place heavy objects on the recorder.
- To prevent fire or shock hazard, do not place objects filled with liquids, such as vases, on the apparatus.

On recording

Make trial recordings before making the actual recording.

On compensation for lost recordings

Sony is not liable and will not compensate for any lost recordings or relevant losses, including when recordings are not made due to reasons including recorder failure, or when the contents of a recording are lost or damaged as a result of recorder failure or repair undertaken to the recorder. Sony will not restore, recover, or replicate the recorded contents under any circumstances.

Copyrights

- Television programs, films, video tapes, discs, and other materials may be copyrighted. Unauthorized recording of such material may be contrary to the provisions of the copyright laws. Also, use of this recorder with cable television transmission may require authorization from the cable television transmitter and/or program owner.
- Recording equipment should be used only for lawful copying and you are advised to check carefully what is lawful copying in the area in which you are making a copy. Copying of copyright material such as films or music is unlawful unless permitted by a legal exception or consented to by the rights owner.
- This product incorporates copyright protection technology that is protected by U.S. patents and other intellectual property rights. Use of this copyright protection technology must be authorized by Macrovision, and is intended for home and other limited viewing uses only unless otherwise authorized by Macrovision. Reverse engineering or disassembly is prohibited.

Copy guard function

Since the recorder has a copy guard function, programs received through an external tuner (not supplied) may contain copy protection signals (copy guard function) and as such may not be recordable, depending on the type of signal.

IMPORTANT NOTICE

Caution: This recorder is capable of holding a still video image or on-screen display image on your television screen indefinitely. If you leave the still video image or on-screen display image displayed on your TV for an extended period of time you risk permanent damage to your television screen. Plasma display panels and projection televisions are especially susceptible to this.

If you have any questions or problems concerning your recorder, please consult your nearest Sony dealer.

Important Safety Instructions

- 1) Read these instructions.
- 2) Keep these instructions.
- 3) Heed all warnings.
- 4) Follow all instructions.
- 5) Do not use this apparatus near water.
- 6) Clean only with dry cloth.
- 7) Do not block any ventilation openings. Install in accordance with the manufacturer's instructions.
- 8) Do not install near any heat sources such as radiators, heat registers, stoves, or other apparatus (including amplifiers) that produce heat.
- 9) Do not defeat the safety purpose of the polarized or grounding-type plug. A polarized plug has two blades with one wider than the other. A grounding type plug has two blades and a third grounding prong. The wide blade or the third prong are provided for your safety. If the provided plug does not fit into your outlet, consult an electrician for replacement of the obsolete outlet.
- 10) Protect the power cord from being walked on or pinched particularly at plugs, convenience receptacles, and the point where they exit from the apparatus.

- 11) Only use attachments/accessories specified by the manufacturer.
- 12) Use only with the cart, stand, tripod, bracket, or table specified by the manufacturer, or sold with the apparatus. When a cart is used, use caution when moving the cart/apparatus combination to avoid injury from tip-over.



- 13) Unplug this apparatus during lightning storms or when unused for long periods of time.
- 14) Refer all servicing to qualified service personnel. Servicing is required when the apparatus has been damaged in any way, such as power-supply cord or plug is damaged, liquid has been spilled or objects have fallen into the apparatus, the apparatus has been exposed to rain or moisture, does not operate normally, or has been dropped.

About this manual

- In this manual, "disc" is used as a general reference for DVDs or CDs unless otherwise specified by the text or illustrations.
- Icons, such as **DVD**, listed at the top of each explanation indicate what kind of media can be used with the function being explained. For details, see "Recordable and Playable Discs" on page 74.
- Instructions in this manual describe the controls on the remote. You can also use the controls on the recorder if they have the same or similar names as those on the remote.
- The on-screen display illustrations used in this manual may not match the graphics displayed on your TV screen.
- The explanations regarding DVDs in this manual refer to DVDs created on this recorder. The explanations do not apply to DVDs that are created on other recorders and played back on this recorder.

Table of Contents

WARNING	2
Precautions	2
Guide to Parts and Controls	6

Hookups and Settings	10
Hooking Up the Recorder	10
Step 1: Connecting the Cable Box/Satellite Receiver (Tuner)	10
Step 2: Connecting the Video Cords/HDMI Cord	12
Step 3: Connecting the Audio Cords/HDMI Cord	14
Step 4: Connecting the Mains Lead (Power Cord)	15
Step 5: Preparing the Remote	16
Step 6: Initial Setup	18
Connecting a VCR or Similar Device	21
Connecting to a Satellite or Digital Tuner	23
Connecting the USB Device	24

Basic Operation	25
Using the System Menu	25
Inserting and Formatting a Disc	26
Recording a Program to a Disc	27
Viewing the Recorded Program (Title List)	28
Checking the Playback Information and Playing Time	30
Changing the Name of a Recorded Program (Title Input)	31
Labeling and Protecting a Disc	32
Playing a DVD on Other Equipment (Finalize)	33

Recording	35
Before Recording	35
Timer Recording From Connected Equipment	36
Checking/Changing/Canceling Timer Settings (Timer List)	37
Recording Without the Timer	39
Recording From a VCR or Similar Device	41

Playback	42
Playing	42
Searching for a Title/Chapter/Track, etc.	46
Playing Music CDs and MP3 Audio Tracks	48
Playing JPEG Image Files	50

Erasing and Editing	51
Before Editing	51
Erasing and Editing Titles	52
Editing a Title by Chapter	55
Editing a Playlist	57

DV Dubbing	59
Before DV Dubbing	59
Connecting a Digital Video Camera to the DV IN Jack	59
Dubbing From a DV/Digital8 Format Tape to a DVD	60

Settings and Adjustments	62
Using the Setup Displays	62
Recorder Settings (General)	63
Language Settings	64
Audio Settings	65
Parental Control Settings (Lock)	66
Recording Settings (Video)	67
Disc Settings	68
Resetting the Recorder (Factory Set)	69

Additional Information	70
Troubleshooting	70
Recordable and Playable Discs	74
Playable Discs	76
Language Code List	78
Area Code List	78
Notes About This Recorder	79
Notes on MP3 Audio Tracks, JPEG Image Files, and i.Link	80
Specifications	81
Index	83

13 **SUBTITLE (44)**

Selects a subtitle language.

ANGLE (44)

Changes the angles or rotates an image during slideshow.

PLAY MODE (46, 49)

ZOOM (45)

Zooms an image during playback or pause mode.

14 **AUDIO (44)**

The AUDIO button has a tactile dot*.

15 **Number buttons (46)**

The number 5 button has a tactile dot*.

16 **⏏ OPEN/CLOSE (26)**

Opens or closes the disc tray.

* Use the tactile dot as a reference when operating the recorder.

Front panel

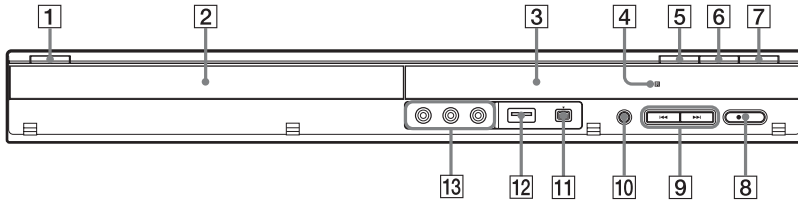

1 **I/⏻ (on/standby) (18)**

Turns the recorder on or off.

2 **Disc tray (26)**

3 **Front panel display**

Shows the current status of the recorder.
 REC: Indicates when recording is in progress.
 TV: Indicates when the recorder is in TV tuner mode.
 PM: Indicates afternoon.
 ☾ : Indicates when the recorder is in timer recording or a timer recording is programmed.
 8:8:8 : Shows the current status of the recorder (clock, channel, etc.).

4 **📡 (remote sensor) (16)**

5 **⏮ (open/close) (26)**

Opens or closes the disc tray.

6 **▶ (play) (42, 48, 50)**

The ▶ button has a tactile dot*.

7 **■ (stop) (42, 48, 50)**

8 **● REC (39)**

9 **⏮/▶ (previous/next) (44)**

10 **RESOLUTION button (13)**

Selects the resolution according to your TV.

11 **📹 DV IN jack (59)**

Connect a DV camcorder to this jack.

12 **📶 USB jack (type A) (24)**

Connect a USB device to this jack.

13 **LINE 2 IN (VIDEO/L(MONO) AUDIO R) jacks (21)**

Connect a VCR or similar recording device to these jacks.

* Use the tactile dot as a reference when operating the recorder.

Rear panel

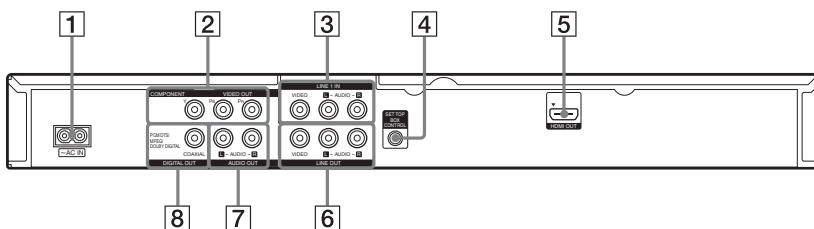

- | | |
|---|--|
| 1 AC IN terminal (15) | 5 HDMI OUT (high-definition multimedia interface out) jack (12) |
| 2 COMPONENT VIDEO OUT (Y, P _B , P _R) jacks (12) | 6 LINE OUT (VIDEO/AUDIO L/R) jacks (12, 14) |
| 3 LINE 1 IN (VIDEO/AUDIO L/R) jacks (11, 23) | 7 AUDIO OUT (L/R) jacks (14) |
| 4 SET TOP BOX CONTROL jack (11) | 8 DIGITAL OUT (COAXIAL) jack (14) |

Hooking Up the Recorder

Follow steps 1 to 5 to hook up the recorder, and step 6 to make the initial settings for the recorder (page 18). Do not connect the mains lead (the AC power cord) until you reach “Step 4: Connecting the Mains Lead (Power Cord)” on page 15.

🔌 Notes

- See “Specifications” (page 81) for a list of supplied accessories.
- Plug cords securely to prevent unwanted noise.
- Refer to the instructions supplied with the components to be connected.
- You cannot connect this recorder to a TV that does not have a video input jack.
- Be sure to disconnect the mains lead (the power cord) of each component before connecting.

Step 1: Connecting the Cable Box/Satellite Receiver (Tuner)

This recorder does not include a TV tuner.

To record TV programs on this recorder, you need to connect the recorder to a tuner that has audio/video output jacks.

If you have been using your VCR connected to an antenna, connect this recorder to your VCR using an audio/video cord. In this way, you will be able to record TV programs.

You cannot record on this recorder if you have:

- a cable box or satellite receiver without audio/video outputs.
- cable with no cable box.
- antenna only (no cable TV).

In the cases above, contact your cable service or satellite service company to see if they can provide you with a compatible cable box or satellite receiver.

Using the cable box/satellite receiver control function

This function allows the recorder to control a cable box or satellite receiver via the supplied set top box controller.

To use the cable box/satellite receiver control function, you need to connect the set top box controller (page 11).

After setting up the cable box/satellite receiver control, check that the recorder can correctly control the cable box or satellite receiver (page 19).

Connecting a cable box/satellite receiver and set top box controller

Connect the LINE 1 IN jacks using an audio/video cord.

With this hookup, you can record any channel on the cable box or satellite receiver. Be sure that the cable box or satellite receiver is turned on.

To record cable or satellite programs, you need to match the input source on the recorder (L1) to the input jack connected to the cable box or satellite receiver (LINE 1 IN).

Place the set top box controller near the remote sensor on the cable box/satellite receiver.

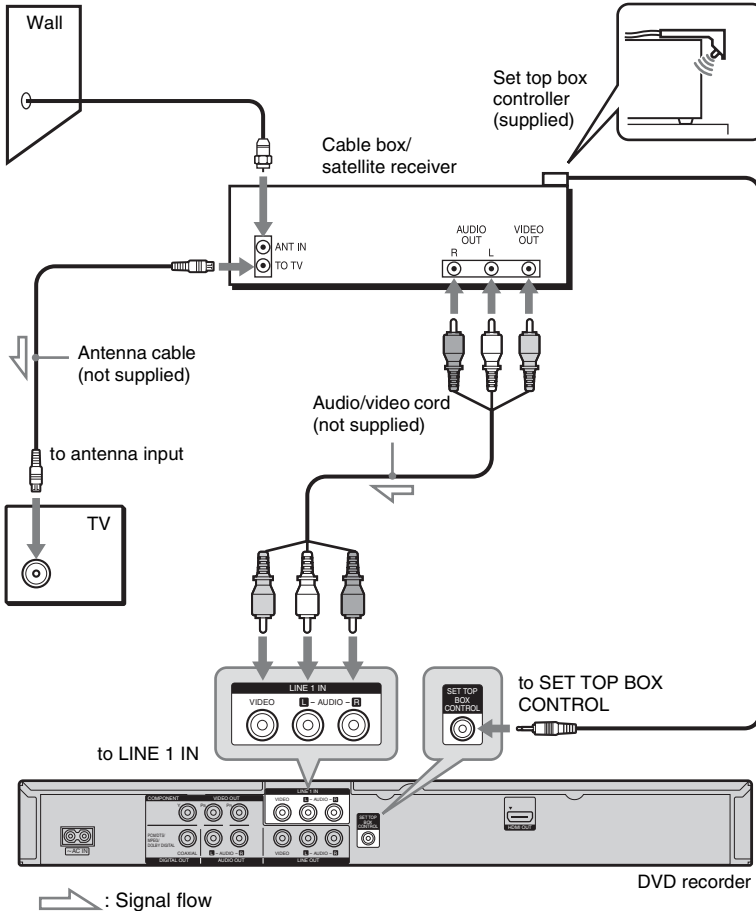

Step 2: Connecting the Video Cords/HDMI Cord

Select one of the following patterns, **A** through **C**, according to the input jack on your TV monitor, projector, or audio component such as an AV amplifier (receiver). This will enable you to view pictures.

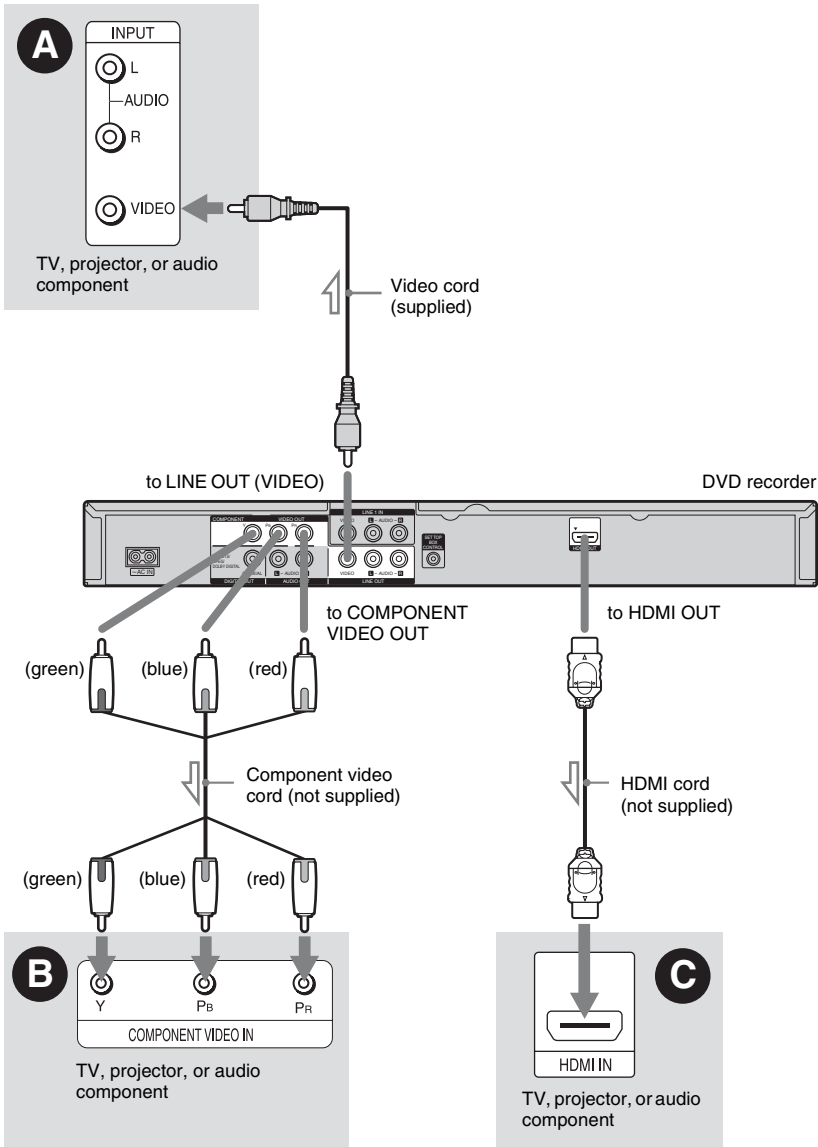

: Signal flow

A Video input jack

You will enjoy standard quality images.

B Component video input jacks (Y, P_B, P_R)

You will enjoy accurate color reproduction and high quality images.

If your TV accepts progressive 480p format signal, use this connection and set the RESOLUTION button on the front panel to “480p” (page 8).

C HDMI input jack

Use a certified HDMI cord (not supplied) to enjoy high quality digital picture and sound through the HDMI OUT jack. Then while watching the pictures, adjust the video output resolution by pressing the RESOLUTION button on the recorder. The indicator on the front panel display changes with each press:

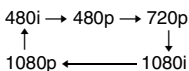

When connecting to the HDMI OUT jack

Follow the steps below. Improper handling may damage the HDMI OUT jack and the connector.

- Carefully align the HDMI OUT jack on the rear of the recorder and the HDMI connector by checking their shapes. Make sure the connector is not upside down or tilted.

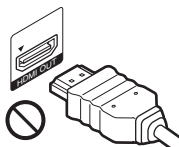

Connector is upside down

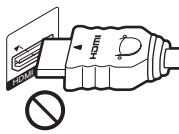

Not straight

- Insert the HDMI connector straight into the HDMI OUT jack. Do not bend or apply pressure to the HDMI connector.

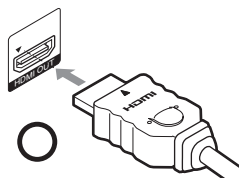

⚡ Notes

- Be sure to disconnect the HDMI cord when moving the recorder.
- Do not apply too much pressure to the cabinet wall, if you place the recorder on the cabinet with the HDMI cord connected. It may damage the HDMI OUT jack or the HDMI cord.
- Do not twist the HDMI connector while connecting to or disconnecting from the HDMI OUT jack to avoid damaging the HDMI OUT jack and connector.

When playing “wide screen” images

Some recorded images may not fit your TV screen. To change the picture size, see page 63.

If you are connecting to a VCR

Connect your VCR to the LINE 2 IN jacks on the recorder (page 21).

⚡ Notes

- Do not connect more than one type of video cord between the recorder and your TV at the same time.
- Do not make connections **A** and **C** at the same time.
- Consumers should note that not all High Definition television sets are fully compatible with this product and may cause artifacts to be displayed in the picture. In case of 525 progressive scan picture problems, it is recommended that the user switch the connection to the ‘Standard Definition’ output. If there are questions regarding our TV set compatibility with this model 525p DVD recorder, please contact our customer service center.
- You cannot connect the HDMI OUT jack (connection **C**) to DVI jacks that are not HDCP compliant (e.g., DVI jacks on PC displays).
- When your TV accepts progressive video signals, the COMPONENT VIDEO OUT jacks output progressive 480p format signals, even if 720p, 1080i or 1080p is selected by the RESOLUTION button.
- When connecting to the HDMI OUT jack with output resolution 720p, 1080i, or 1080p, aspect ratio is automatically set to 16:9. To watch the picture in 4:3, set the output resolution to 480i or 480p by pressing the RESOLUTION button on the recorder, and set the aspect ratio of the connected TV to 4:3.

* This DVD recorder incorporates High-Definition Multimedia Interface (HDMI™) technology.

HDMI, the HDMI logo and High-Definition Multimedia Interface are trademarks or registered trademarks of HDMI Licensing LLC.

Step 3: Connecting the Audio Cords/HDMI Cord

Select one of the following patterns, **A** or **B**, according to the input jack on your TV monitor, projector, or audio component such as an AV amplifier (receiver). This will enable you to listen to sound.

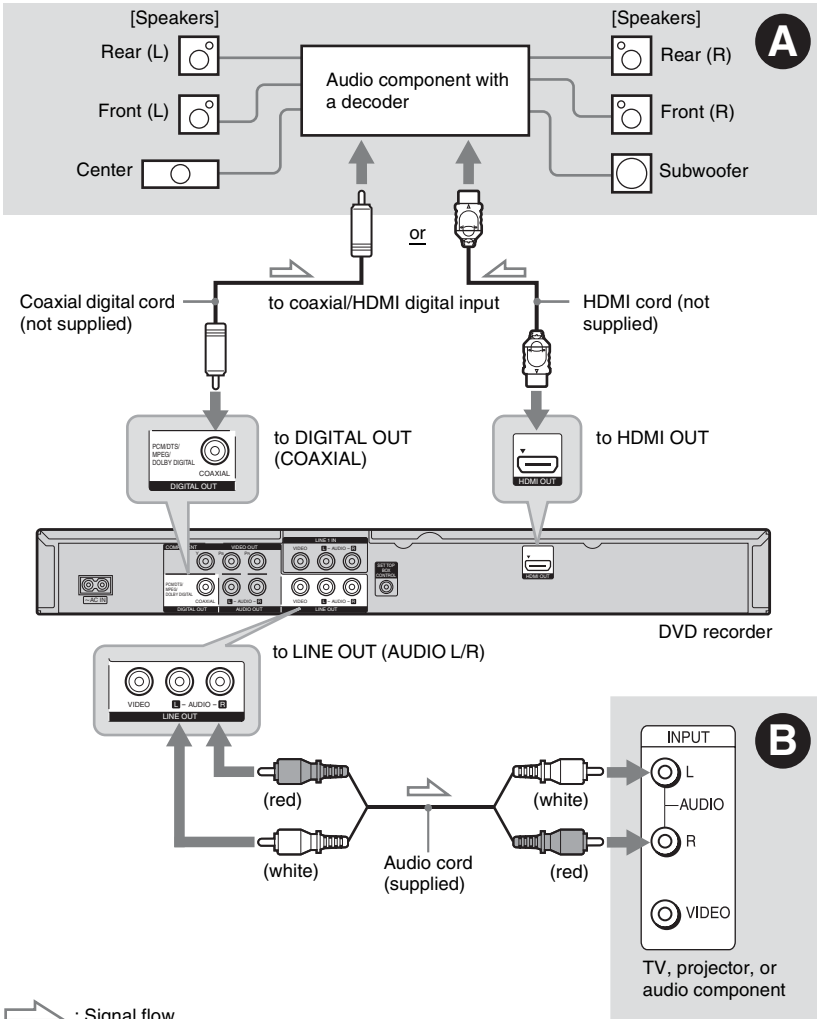

A Digital audio input jack

If your audio component has a Dolby[®] 1 Digital, DTS[®] 2, or MPEG audio decoder and a digital input jack, use this connection. You can enjoy Dolby Digital (5.1ch), DTS (5.1ch), and MPEG audio (5.1ch) surround effects.

B Audio L/R (left/right) input jacks

This connection will use your TV's or audio component's two speakers for sound.

Hint

For correct speaker location, refer to the operating instructions supplied with the connected components.

Notes

- Do not connect your TV's audio output jacks to the LINE 1 IN (AUDIO L/R) jacks at the same time. This will cause unwanted noise to come from your TV's speakers.
- With connection **B**, do not connect the LINE 1 IN (AUDIO L/R) and LINE OUT jacks to your TV's audio output jacks at the same time. This will cause unwanted noise to come from your TV's speakers.
- With connection **A**, after you have completed the connection, make the appropriate settings in the [Audio] setup (page 65). Otherwise, no sound or a loud noise will come from your speakers.
- When you connect the recorder to an audio component using an HDMI cord, you will need to do one of the following:
 - Connect the audio component to the TV with the HDMI cord, or
 - Connect the recorder to the TV with a component video cord.

*1 Manufactured under license from Dolby Laboratories.

Dolby and the double-D symbol are trademarks of Dolby Laboratories.

*2 Manufactured under license under U.S. Patent #: 5,451,942 & other U.S. and worldwide patents issued & pending. DTS and DTS Digital Out are registered trademarks and the DTS logos and Symbol are trademarks of DTS, Inc. © 1996-2007 DTS, Inc. All Rights Reserved.

Step 4: Connecting the Mains Lead (Power Cord)

Connect the supplied mains lead (the power cord) to the AC IN terminal of the recorder. Then plug the recorder and TV mains leads (AC power cords) into the AC outlet. After you connect the mains lead (the power cord), **you must wait for a short while before operating the recorder.** You can operate the recorder once the front panel display lights up and the recorder enters standby mode.

If you connect additional equipment to this recorder (page 21), be sure to connect the mains lead (the power cord) after all connections are complete.

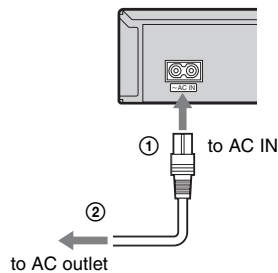

Step 5: Preparing the Remote

You can control the recorder using the supplied remote. Insert two size AA (R6) batteries by matching the ⊕ and ⊖ ends on the batteries to the markings inside the battery compartment. When using the remote, point it at the remote sensor  on the recorder.

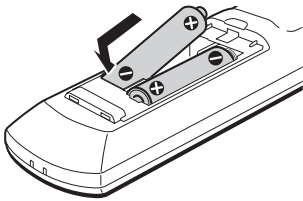

Notes

- If the supplied remote interferes with your other Sony DVD recorder or player, change the command mode number for this recorder (page 17).
- Use the batteries correctly to avoid possible leakage and corrosion. Should leakage occur, do not touch the liquid with bare hands. Observe the following:
 - Do not use a new battery with an old battery, or batteries of different manufacturers.
 - Do not attempt to recharge the batteries.
 - If you do not intend to use the remote for an extended period of time, remove the batteries.
 - If battery leakage occurs, wipe out any liquid inside the battery compartment, and insert new batteries.
- Do not expose the remote sensor (marked  on the front panel) to strong light, such as direct sunlight or a lighting apparatus. The recorder may not respond to the remote.
- When you replace the batteries of the remote, the code number and Command Mode may be reset to the default setting. Set the appropriate code number and Command Mode again.

Controlling TVs with the remote

You can adjust the remote's signal to control your TV.

Notes

- Depending on the connected unit, you may not be able to control your TV with some or all of the buttons below.
- If you enter a new code number, the code number previously entered will be erased.

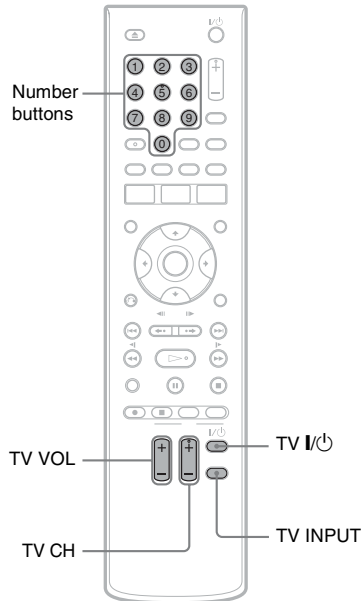

1 Hold down TV I/⏻ located at the bottom of the remote.

Do not press the I/⏻ button at the top of the remote.

2 With TV I/⏻ pressed down, enter the TV's manufacturer code using the number buttons.

For instance, to enter "09," press "0" then "9." After you enter the last number, release the TV I/⏻ button.

Code numbers of controllable TVs

If more than one code number is listed, try entering them one at a time until you find the one that works with your TV.

Manufacturer	Code number
Sony	01 (default)
Hitachi	02
LG/Goldstar/NEC	04
Mitsubishi/MGA	13
Panasonic	19
Philips	21
Pioneer	16
RCA	10
Samsung	20
Sharp	18
Toshiba	07

The remote performs the following:

Buttons	Operations
TV I/O	Turns your TV on or off.
TV VOL +/-	Adjusts the volume of your TV.
TV CH +/-	Selects the channel on your TV.
TV INPUT	Switches your TV's input source.

If you have a Sony DVD player or more than one Sony DVD recorder

If the supplied remote interferes with your other Sony DVD recorder or player, set the command mode number for this recorder and the supplied remote to one that differs from the other Sony DVD recorder or player after you have completed "Step 6: Initial Setup."

The default command mode setting for this recorder and the supplied remote is "3." The remote does not function if different command modes are set for the recorder and remote. Set the same command mode.

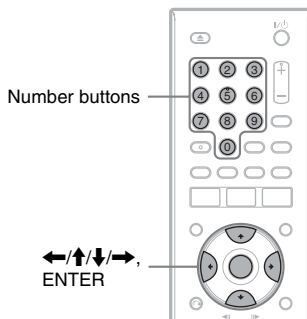
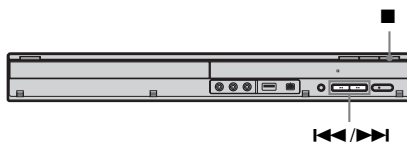

- 1** Turn off the recorder.
- 2** Hold down ■ (stop) on the recorder until "code" appears on the front panel display.
- 3** Press ⏮/⏭ on the recorder to select the command mode (1, 2, or 3).
The selected command mode appears on the front panel display.
- 4** Hold down the remote's ENTER and 1, 2, or 3 of the number buttons corresponding to the command mode selected in step 3, for more than three seconds.

Changing channels of the recorder using the remote

You can change channels of the recorder using the number buttons.

Example: for channel 50

Press “5,” “0,” then press ENTER.

Step 6: Initial Setup

Make the basic adjustments by following the on-screen instructions in “Initial Setup.”

Be careful not to disconnect the cables or exit the “Initial Setup” function during this procedure.

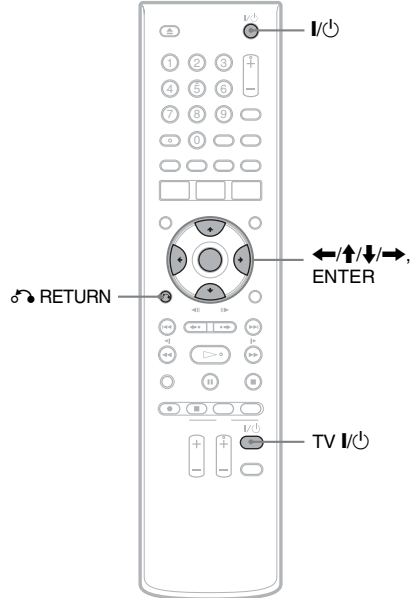

- 1 Turn on the recorder and your TV. Then switch the input selector on your TV so that the signal from the recorder appears on your TV screen.**
The [LANGUAGE] display appears.
- 2 Select a language for the on-screen displays using ↑/↓, and press ENTER.**
The [Clock Setting] display appears.
- 3 Set the date, year, and time using ←/↑/↓/→, and press ENTER to start the clock.**
You can also use the number buttons.
- 4 When the Initial Setup is completed, select [Exit] and press ENTER.**
If you use the cable box/satellite receiver control, make the necessary settings and check that the control works correctly (page 19).

To return to the previous step

Press RETURN or according to the display.

Hint

If you want to run “Initial Setup” again, select the relevant setup items from the Setup menu (page 62).

Setting up the cable box/satellite receiver control

- 1** Turn on the recorder and the cable box/satellite receiver.
- 2** Press SYSTEM MENU to turn on the System Menu.
- 3** Select [Setup] and press ENTER.
The Setup display appears.
- 4** Select [Video] and press .
- 5** Select [Set-Top Box Control] and press .

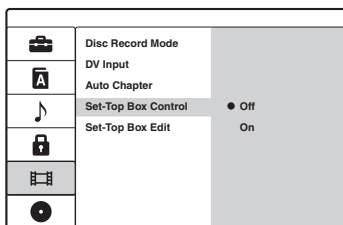

- 6** Select [On] and press ENTER.
The display shows the current setting for the cable box/satellite receiver control.
- 7** Select [Edit] and press ENTER.
The display for setting the cable box/satellite receiver control appears.

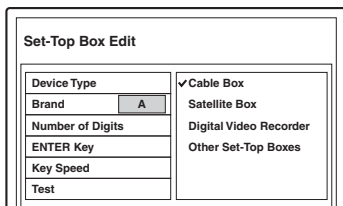

8 Select an option and press ENTER.

[Device Type]: Selects the type of cable box/satellite receiver.

[Brand]: Selects the brand name of cable box/satellite receiver. Press / to select the brand name initial and press ENTER. Then select the brand and press ENTER.

[Number of Digits]: Selects the number of digits for your cable box/satellite receiver’s channel.

[ENTER key]: Selects whether you need to press the ENTER button each time after entering the channel number.

[Key Speed]: Selects the speed to send commands to the cable box/satellite receiver.

[Test]: Checks that the control works correctly (see below).

Checking the cable box/satellite receiver control setting

- 1** Select [Test] in step 8 above and press ENTER.
- 2** Check the overall connection and press ENTER.
- 3** Check that the cable box/satellite receiver is turned on, and press ENTER.
- 4** Press / to select a code for the recorder’s remote and press ENTER.
- 5** Press / / / to enter a channel (any channel), select [OK], and press ENTER.
- 6** Check if the same channel is selected on the cable box/satellite receiver.
 - If the same channel is not selected, return to step 4 by pressing RETURN repeatedly and try one of the other code(s) until you find the one that works.
- 7** Select [Yes] and press ENTER.
- 8** Select [Exit] and press ENTER to close the display.

If you cannot get the recorder to control your cable box/satellite receiver

Check the settings at [Set-Top Box Control] in the [Video] setup (page 19).

Check the connection and place the set top box controller near the remote sensor on the cable box/satellite receiver (page 11).

If your cable box or satellite receiver still does not operate with this recorder, contact your cable or satellite company to see if they can provide you with a compatible cable box or satellite receiver.

To fix the set top box controller to your cable box/satellite receiver

Once you have confirmed that the set top box controller controls your cable box or satellite receiver, affix it in place.

- 1** Attach the supplied double-sided tape to the set top box controller. Remove the backings on the double-sided tape.

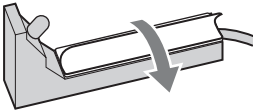

- 2** Affix it so that the set top box controller is near the remote control sensor on your cable box/satellite receiver.

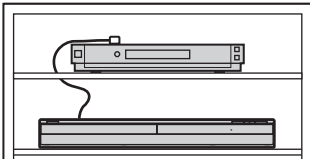

Connecting a VCR or Similar Device

After disconnecting the recorder's mains lead (the power cord) from the AC outlet, connect a VCR or similar recording device to the LINE IN jacks of this recorder.

Use the DV IN jack on the front panel if the equipment has a DV output jack (i.LINK jack) (page 59). See also the operating instructions supplied with the connected equipment.

Connecting to the LINE 2 IN jacks

Connect a VCR or similar recording device to the LINE 2 IN jacks of this recorder.

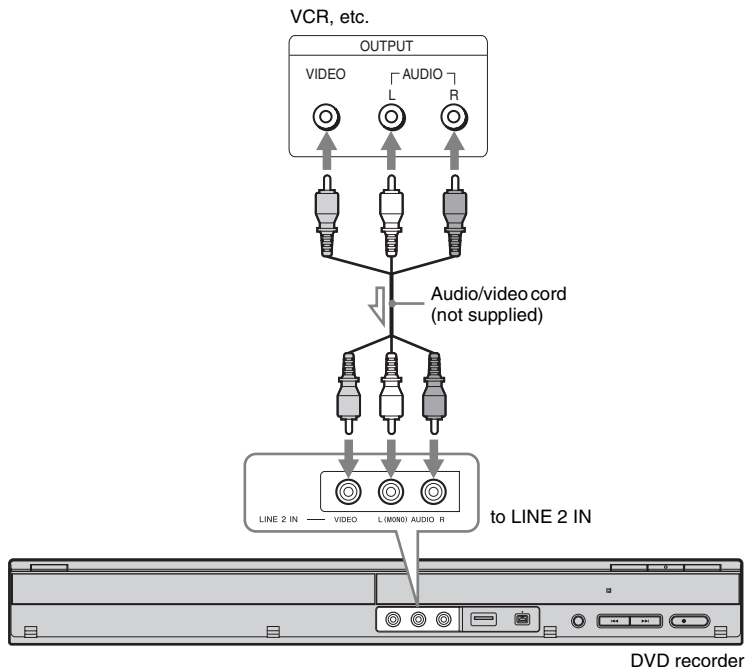

: Signal flow

Hint

When the connected equipment outputs only monaural sound, use audio cords that distribute monaural sounds to left/right channels (not supplied).

🔊 Notes

- Do not connect the output jack of this recorder to another equipment's input jack with the other equipment's output jack connected to the input jack of this recorder. This may cause noise (feedback).
- Do not connect more than one type of video cord between the recorder and your TV at the same time.
- Pictures containing copy protection signals that prohibit any copying cannot be recorded.
- If you pass the recorder signals via the VCR, you may not receive a clear image on your TV screen.



Be sure to connect your VCR to the DVD (digital video disc) recorder and your TV in the order shown below. To watch video tapes, watch the tapes through a second line input on your TV.

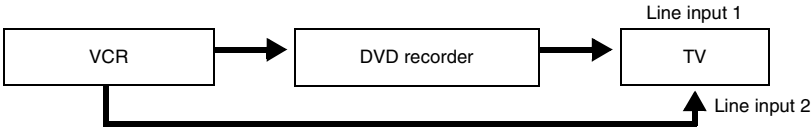

- To watch the connected VCR or similar device's pictures through the recorder while the recorder is in standby mode, set [Power Save] to [Off] (default) in the [General] setup (page 63).
- If you disconnect the recorder's mains lead (the power cord), you will not be able to view the signals from the connected VCR.

Connecting to a Satellite or Digital Tuner

Connect a satellite or digital tuner to this recorder using the LINE 1 IN jacks. Disconnect the recorder's mains lead (the power cord) from the AC outlet when connecting the tuner.

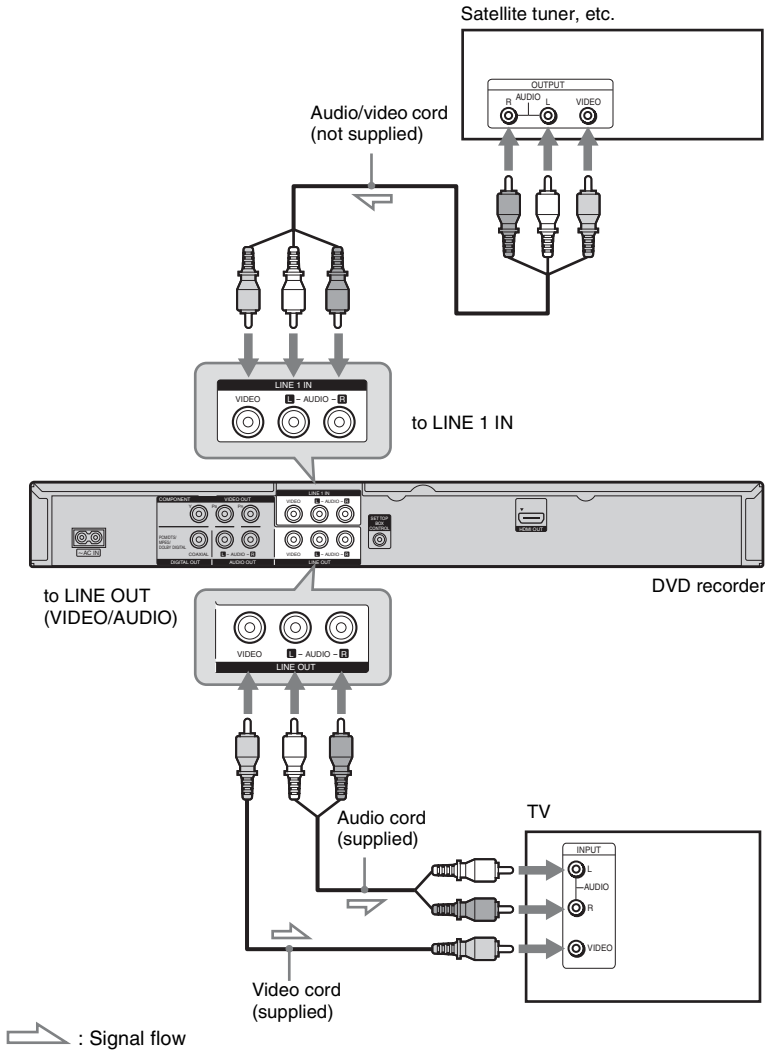

Hint

You do not need to turn on the recorder to view the signals from the connected tuner on your TV.

Note

If you disconnect the recorder's mains lead (the power cord), you will not be able to view the signals from the connected tuner.

Connecting the USB Device

You can connect a USB memory to the USB jack on the recorder to play the MP3 audio tracks or JPEG image files. Refer to the operating instructions supplied with the USB memory before connecting. For details about playing the inserted USB memory, see “Playing from the USB memory” on page 43.

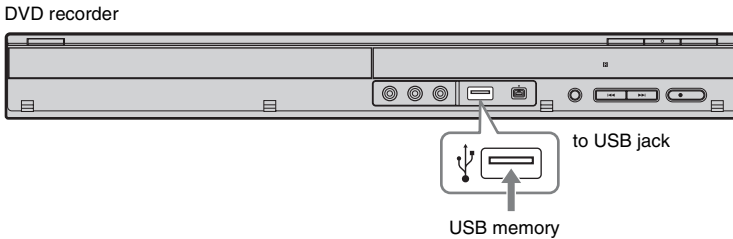

Notes

- This recorder supports only USB memory with FAT16 or FAT32 format.
- USB memory that requires additional program installation when you have connected it to a PC is not supported.
- This recorder is compatible with USB memory that supports USB 1.1.
- Some USB memory may not work with this recorder.

Using the System Menu

The System Menu appears when you press SYSTEM MENU, and provides entries to the recorder's functions.

Select an option by pressing **↑/↓** and ENTER. If necessary, select a sub option and press ENTER.

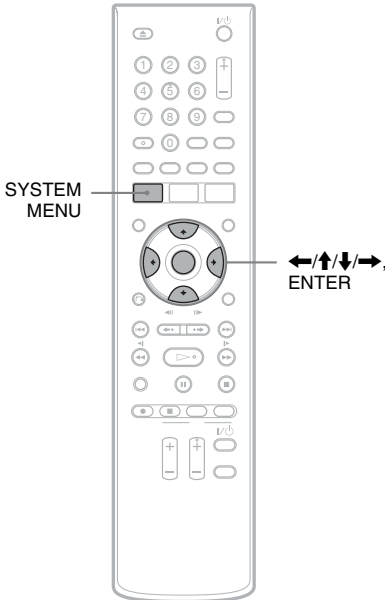

System Menu	
Media	Video(Title)
Timer Record	Photo
Setup	Music

Media (page 42)

Displays the contents of a disc or USB memory.

[Video (Title)]: Displays the Title List.

[Photo]: Displays the Photo Album on DATA DVD, DATA CD, or USB memory.

[Music]: Displays the Music Jukebox on DATA DVD, DATA CD, or USB memory.

You can select JPEG image files or MP3 audio tracks on a DATA CD/DATA DVD or USB memory.

Select a file type and press ENTER. Then select a media type, [Disc] or [USB].

Timer Record (page 36)

Displays the Timer List.

Used to set a new timer recording for a disc, as well as change or cancel timer recordings you set.

Setup (page 62)

Displays the Setup menu for setting up the recorder to suit your preferences.

Inserting and Formatting a Disc

+RW -RWVR -RWVideo +R -R

When you first insert a new disc, the recorder will ask you to format the disc. Follow the steps below to format the disc. You can also reformat a DVD+RW or DVD-RW to create a blank disc.

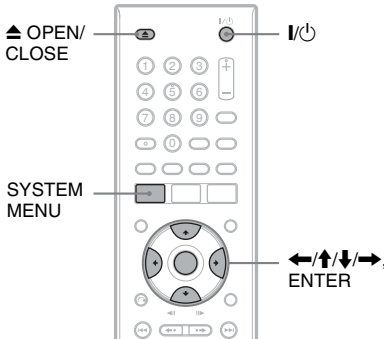

- 1 Turn on the TV.**
- 2 Press I/O.**
The recorder turns on.
- 3 Switch the input selector on your TV so that the signal from the recorder appears on the TV screen.**
- 4 Press \blacktriangle OPEN/CLOSE, and place a disc on the disc tray.**

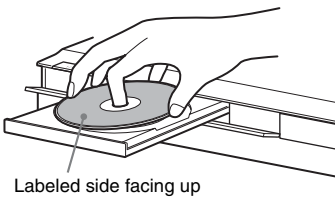

- 5 Press \blacktriangle OPEN/CLOSE to close the disc tray.**
After "READ" disappears from the front panel display, the display asks for confirmation.
 - For a DVD-R, the recorder automatically formats.

- 6 Press ENTER while [OK] is selected.**
The recorder starts formatting the disc. The display shows the approximate time required.
 - For a DVD-RW, the recorder automatically formats in Video mode. To format in VR mode, see "Reformatting a disc" below.

Hint
For a formatted disc, you can use the disc after "READ" disappears from the front panel display in step 5 above.

Reformatting a disc

+RW -RWVR -RWVideo

You can erase all contents of a disc to create a blank disc. To format a new DVD-RW in VR mode, reformat the disc.

- 1 Insert a disc.**
- 2 Press SYSTEM MENU to turn on the System Menu.**
- 3 Select [Setup] and press ENTER.**
The Setup display appears.
- 4 Select \bullet [Disc] and press ENTER.**
- 5 Select [Format DVD] and press ENTER.**

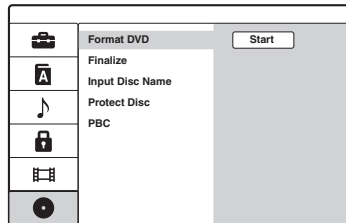

- 6 While [Start] is selected, press ENTER.**
The display asks for confirmation.
 - For DVD-RWs, select a recording format (VR mode or Video mode) and press ENTER.
- 7 Select [OK] and press ENTER.**
Formatting starts.

Recording a Program to a Disc

+RW **-RWVR** **-RW_{Video}** **+R** **-R**

This section introduces the basic operation to record the current TV program to a disc. For details about recording, see page 35.

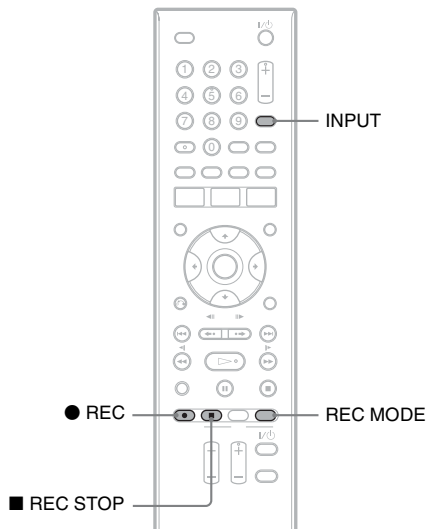

1 Turn on the recorder and the connected cable box/satellite receiver.

2 Insert a disc.

For details on how to insert and format a new disc, see “Inserting and Formatting a Disc” (page 26).

3 Press INPUT repeatedly to select the connected input (L1).

The front panel display changes as follows:

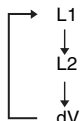

4 Select the channel on the cable box/satellite receiver's side.

5 Press REC MODE repeatedly to select the recording mode.

Each time you press the button, the display changes on the TV screen as follows:

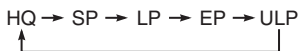

For details about the recording mode, see page 35.

6 Press ● REC.

Recording starts and “REC” (red) appears in the front panel display.

Recording continues until you stop the recording or the disc is full.

Leave the cable box/satellite receiver turned on and do not change the channel you are recording.

To stop recording

Press ■ REC STOP. Note that it may take a few seconds for recording to stop.

💡 Hint

This recorder can record on various discs. Select the disc type according to your needs (page 74).

Viewing the Recorded Program (Title List)

+RW -RWVR -RWVideo +R -R

The titles of programs recorded on a disc are displayed in the Title List, which also displays disc information, such as disc name, remaining time, etc. Follow the steps below to play the recorded program.

You can also edit individual titles from the Title List (page 52).

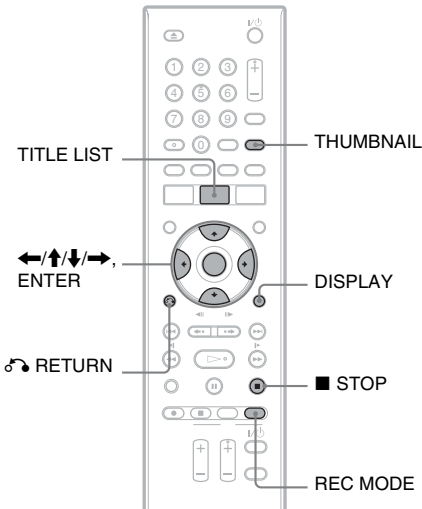

1 Insert a disc.

2 Press TITLE LIST.

The Title List menu appears with the contents of the disc.

Example: Title List (Original) on a DVD-RW (VR mode)

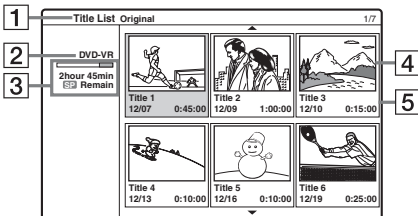

1 Title type (DVD-RW (VR mode) only): Displays the title type, original or Playlist.

2 Disc name (page 32): Displays the disc type.

3 Disc space bar/remaining time: Press REC MODE repeatedly to show the remaining time in each of the recording modes.

4 Title's thumbnail picture: Press ←/→ to select the previous/next title. If more than six titles are listed, press ↑/↓ to display titles on the previous/next pages row by row.

5 Title information: Displays the title name, recording date, and recording time. Press DISPLAY to show detailed information for the selected title (not available for a Playlist title).

3 Select a title and press ENTER.

The sub-menu appears with options applicable to the selected title. The options displayed differ depending on the situation and disc type.

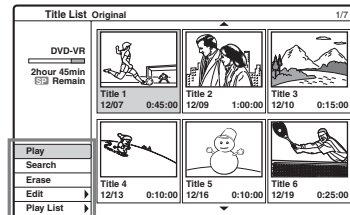

Options for the selected title

- If you want to turn off the sub-menu and re-select other title, press RETURN.

4 Select [Play] and press ENTER.

Playback starts from the selected title on the disc.

- To play a title including hidden chapters on a DVD+RW/DVD+R, select [Full Play]. For details about hidden chapters, see page 56.

About the Title List for DVD-RWs (VR mode)

Each time you press TITLE LIST, you can switch the Title List to show original or Playlist.

For details, see “Edits for Playlist titles” (page 51).

To search for a specific point of the title

Select [Search] and press ENTER in step 4. Select [Time] and press ENTER.

While watching the preview, press \leftarrow/\rightarrow to select the start point. Each press moves the point forward or backward one minute (or five minute if you hold). Then, press ENTER.

To stop playback

Press \blacksquare STOP.

To turn off the Title List

Press \hookrightarrow RETURN.

To change a title thumbnail picture (DVD-RWs in VR mode only)

You can select a favorite scene for the thumbnail picture shown in the Title List menu.

- 1 Play a title whose thumbnail picture you want to change.
- 2 Press THUMBNAIL at the scene you want to set for a thumbnail picture.
A thumbnail mark appears on the screen and the scene is set for the title's thumbnail picture.

Chapter List

+RW -RWVR -RWVideo +R -R

When you select [Chapter] in [Search] from the sub-menu for a title, the Chapter List menu appears with the title contents displayed as chapters.

You can play or edit individual chapters from the sub-menu, which appears when you select a chapter and press ENTER.

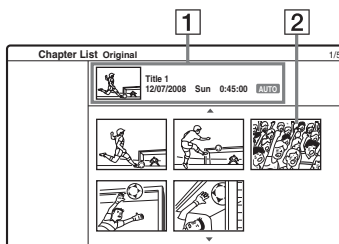

1 Title information

2 Chapter's thumbnail picture

Press \leftarrow/\rightarrow to select the previous/next chapter. If more than six chapters are listed, press \uparrow/\downarrow to display chapters on the previous/next pages row by row.

To return to the Title List

Select a chapter and press ENTER. Select [Title List] from the sub-menu and press ENTER.

Hint

After recording, the first scene of the recording (the title) is automatically set as the title thumbnail picture.

Notes

- The Title List may not appear for discs created on other DVD recorders.
- Letters that cannot be displayed appear as corrupt characters.
- Title thumbnail pictures are displayed only on this recorder.
- It may take a few seconds for the thumbnail pictures to be displayed.
- After editing, the title thumbnail picture may change to the first scene of the recording (title).
- Title thumbnails are set at a point approximate to where the THUMBNAIL button is pressed, and the result may be slightly different from the intended one.

Checking the Playback Information and Playing Time

+RW -RWVR -RWvideo +R -R DVD
VCD

You can check the playback information and remaining time displayed on the TV screen by pressing DISPLAY repeatedly. The items displayed differ depending on the disc type or playing status.

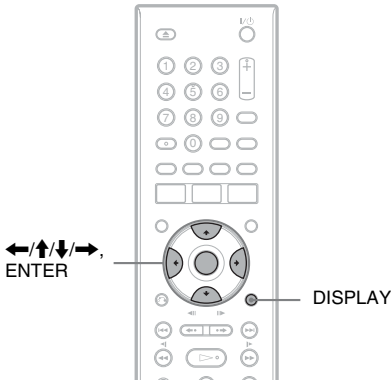

Press DISPLAY to show various playback information on the TV screen.

Example: When playing a DVD



- 1 Elapsed playing time/remaining time
- 2 Current title and chapter number/total number of titles and chapters

Note

When playing a title recorded over 12 hours by other DVD equipment, time display may not appear correctly.

To change or select the setting

Press DISPLAY twice.

For details about each item, see the pages in parentheses.

Example: When playing a DVD

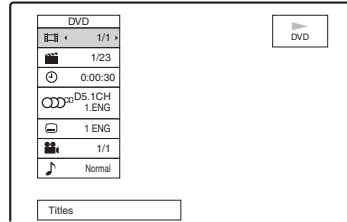

☰ (Titles): Current title (or track) number/total number of titles (or tracks) (page 46)

📖 (Chapters): Current chapter number/total number of chapters (page 46)

⌚ (Time): Elapsed playing time (page 46)

🔊 (Audio): Selected audio language (DVD VIDEO only) or audio channel (page 44)

🗣️ (Subtitle): Selected subtitle (page 44)

👤 (Angle): Selected angle/total number of angles (page 44)

🎵 (Sound): Selected sound mode. Select [3D SUR.] to enjoy virtual surround sound effects created from the front left and right speakers.

Notes

- If no button is pressed for ten seconds, the playback information display will turn off.
- Playing time of MP3 audio tracks may not be displayed correctly.
- If you create a Playlist title longer than “19:59:59,” the front panel counter is reset to “10:00:00” and restarts counting.

Notes on Surround effect

- The function may not work with some discs.
- When you turn on this function, turn off the surround settings of the connected TV or amplifier (receiver).
- Make sure that your listening position is between and at an equal distance from your speakers, and that the speakers are located in similar surroundings.
- The function does not work if you connect to an amplifier using the DIGITAL OUT (COAXIAL)/HDMI OUT jack.

Changing the Name of a Recorded Program (Title Input)

+RW **-RWVR** **-RW_{Video}** **+R** **-R**

The titles recorded on a disc are named sequentially ([Title 1], [Title 2], ...) by default. You can rename titles using the display for entering characters, which also appears for renaming a disc.

Up to 21 characters can be entered for a title or disc name, but the actual number of characters displayed in menus such as the Title List will vary.

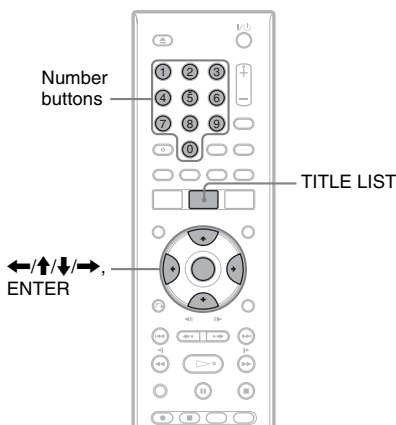

1 Press TITLE LIST to turn on the Title List.
For details about the Title List, see page 28.

2 Select a title and press ENTER.
The sub-menu appears.

For DVD-RWs (Video mode)/DVD-Rs, select [Title] and press ENTER. The display for entering characters in step 4 appears. Follow steps 4 to 8 below.

3 Select [Edit] and press ENTER.
Edit options for the selected title appear.

4 Select [Title Name] and press ENTER.
The display for entering characters appears.

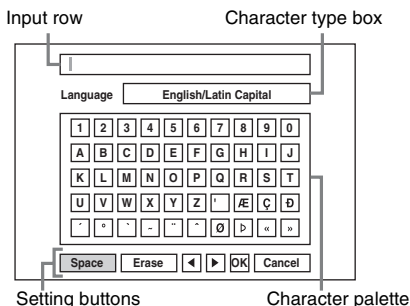

- Press **←/→** to move between the setting buttons. To move between the setting buttons, character palette, and character type box on the display, press **↑/↓**.
- To move the cursor to the left or right within the input row, select [**←**] or [**→**] and press ENTER.
- To erase a character, move the cursor to the right of the character in the input row. Select [**Erase**] and press ENTER.

5 Move to the character type box and press ←/→ to select a character type.

You can select [English/Latin Capital], [English/Latin Lowercase], or [Symbol].

The character palette switches according to the character type you select.

6 Move to the character palette, press ↑/↓/→ to select the character, and press ENTER.

The selected character appears in the input row.

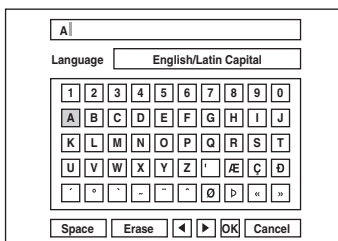

- To enter a letter with an accent mark, select the letter followed by an accent.
Example: Select "a" and then "¨" to enter "ä."
- To insert a space, select [**Space**] and press ENTER.

- To insert a character, move the cursor to the right of the position where you want to insert the character. Select the character from the character palette and press ENTER.

7 Repeat steps 5 and 6 to enter the remaining characters.

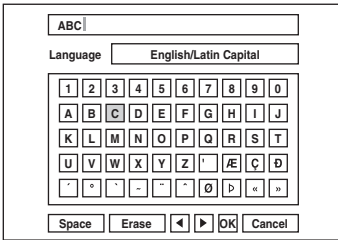

- If you want to return to the Title List without renaming the title, select [Cancel] and press ENTER.

8 Select [OK] and press ENTER.

To use the number buttons

You can also use the number buttons to enter characters.

- Select the row containing the character to be input and press a number button.

Example: To input “MT”
 Select the “K, L, M, N, O, P, Q, R, S, T” row.
 Press the number 3 button, followed by the number 0 button.

- Select [OK] and press ENTER.

Labeling and Protecting a Disc

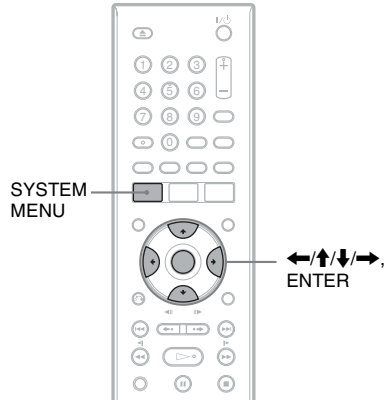

Labeling a disc



A disc is automatically labeled as its disc type. You can change the disc name (up to 21 characters).

- Insert a disc.
- Press **SYSTEM MENU** to turn on the System Menu.
- Select [Setup] and press **ENTER**.
The Setup display appears.
- Select **● [Disc]** and press **→**.
- Select **[Input Disc Name]** and press **→**.

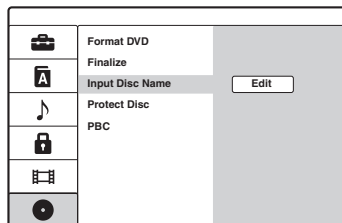

- While [Edit] is selected, press **ENTER**.
The display for entering characters appears. To enter characters, see page 31.

Note

Label the disc before you finalize it. Once a disc is finalized, you cannot change the disc name.

Protecting a Disc

-RWVR

You can protect all titles on the disc to prevent accidental recording, editing, or erasing.

- 1 Insert a disc.
- 2 Press **SYSTEM MENU** to turn on the System Menu.
- 3 Select **[Setup]** and press **ENTER**.
The Setup display appears.
- 4 Select **[Disc]** and press **→**.
- 5 Select **[Protect Disc]** and press **→**.

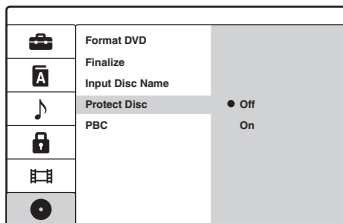

- 6 Select **[On]** and press **ENTER**.

To cancel the protection

Repeat the steps above, and select **[Off]** and press **ENTER** in step 6.

Hint

You can set protection for individual titles (page 54).

Playing a DVD on Other Equipment (Finalize)

+RW -RWVR -RWVideo +R -R

Finalizing is necessary when you play discs recorded with this recorder on other DVD equipment.

When you finalize a DVD+RW, DVD-RW (Video mode), DVD+R, or DVD-R, a DVD menu will be automatically created, which can be displayed on other DVD equipment.

Before finalizing, check the differences between the disc types in the table below.

Differences between the disc types

+RW

Discs are automatically finalized when removed from the recorder. However, you may need to finalize the disc for certain DVD equipment, or if the recording time is short. You can edit or record on the disc even after finalizing.

-RWVR

Finalizing is necessary when playing on any equipment other than this recorder. Playable only on VR mode compatible players. After finalizing, you cannot edit or record on the disc. If you want to edit or record on it again, unfinalize the disc.

-RWVideo

Finalizing is necessary when playing on any equipment other than this recorder. After finalizing, you cannot edit or record on the disc. If you want to edit or record on it again, unfinalize the disc.

+R

Finalizing is necessary when playing on any equipment other than this recorder.

-R

After finalizing, you cannot edit or record on the disc.

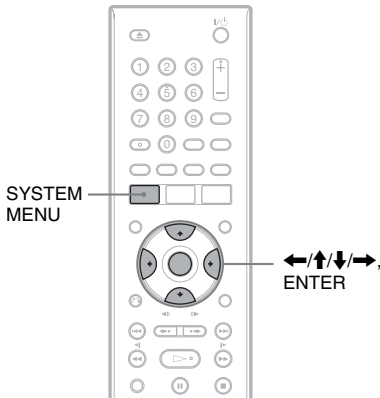

💡 Hint

You can check whether the disc has been finalized or not. If you cannot select [Finalize] in step 6 above, the disc has already been finalized.

🌀 Notes

- The time required for finalizing depends on the disc type, recording time, or the number of titles recorded on the disc.
- Depending on the condition of the disc, recording, or the DVD equipment, discs may not play even if the discs are finalized.
- The recorder may not be able to finalize the disc if it was recorded on another recorder.
- If the recording time is short, the disc may not be playable on some DVD players.

- 1 Insert a disc.**
- 2 Press SYSTEM MENU to turn on the System Menu.**
- 3 Select [Setup] and press ENTER.**
The Setup display appears
- 4 Select ● [Disc] and press →.**
- 5 Select [Finalize] and press →.**

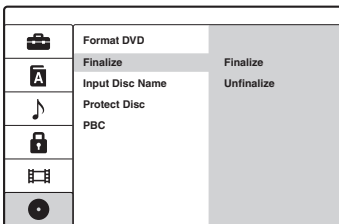

- 6 Select [Finalize] and press ENTER.**
The display asks for confirmation.
- 7 Select [OK] and press ENTER.**
The recorder starts finalizing the disc. Approximate remaining time for finalizing appears on the screen. Some discs may require more time than is indicated.
- 8 Press ENTER when [OK] appears.**

To unfinalize a DVD-RW

If you cannot record or edit on a DVD-RW that has been finalized (a message appears), unfinalize the disc by selecting [Unfinalize] in step 6 above.

Recording

Before Recording

Before you start recording...

- This recorder can record on various discs. Select the disc type according to your needs (page 74).
- Use the Title List to check the available recording time for the disc (page 28). For DVD+RWs and DVD-RWs, you can erase titles to free up disc space (page 51).
- Check that the recorder is connected to a tuner such as a cable box or satellite receiver (page 10). See also the tuner's instruction manual.

💡 Hints

- Up to 49 titles can be recorded on a DVD+RW or DVD+R. For other recordable discs, 99 titles.
- When using a DVD+RW, you can overwrite a previously recorded title (page 40).

Recording mode

Like the SP or LP recording mode of VCRs, this recorder has five different recording modes. Select a recording mode according to the time and picture quality you need. For example, if picture quality is your top priority, select the High Quality mode (HQ). If recording time is your priority, Ultra Long Play mode (ULP) can be a possible choice.

Press REC MODE repeatedly to switch the recording modes.

Note that the recording time in the following table is an approximate guide.

Recording mode	Recording time (minute)
HQ (High quality)	60
SP (Standard mode)	↑ 120
LP	↓ 240
EP	360
ULP (Long duration)	840

⚡ Notes

- Situations below may cause slight inaccuracies with the recording time.
 - Recording a program with poor reception, or a program or video source of low picture quality.
 - Recording on a disc that has already been edited.
 - Recording only a still picture or just sound.
- The available remaining recording time displayed is an estimate and the actual time may differ.
- When recording in ULP mode, the maximum continuous recording time is 720 minutes.

Unrecordable pictures

Pictures with copy protection cannot be recorded on this recorder.

When the recorder receives a copy guard signal, the recorder stops recording.

Copy control signals

Recordable discs

Copy-Free

+RW

-RWVR

-RWVideo

+R

-R

Copy-Once

-RWVR

Ver.1.1, Ver.1.2 with CPRM*

Copy-Never

None

* The recorded disc can be played only on CPRM compatible equipment.

⚡ Note

Even if you erase a scene that contains a copy protection signal, the recording restrictions on that title are retained.

Timer Recording From Connected Equipment

+RW -RWVR -RWvideo +R -R

You can set the timer for a total of 16 programs, up to one month in advance.

Note

While recording, you cannot set additional timer recordings.

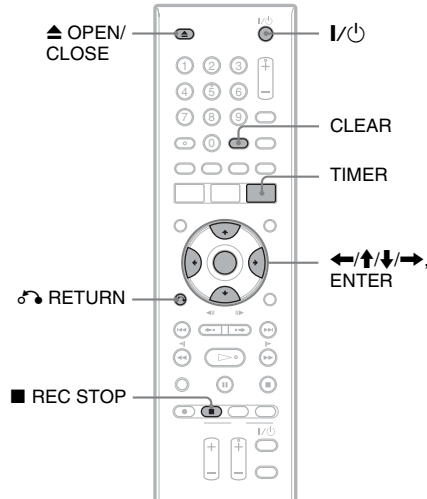

1 Press ▲ OPEN/CLOSE, and place a recordable disc on the disc tray.

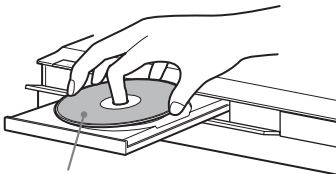

Labeled side facing up

2 Press ▲ OPEN/CLOSE to close the disc tray.

Wait until "READ" disappears from the front panel display.

For details on how to insert and format a new disc, see "Inserting and Formatting a Disc" (page 26).

3 Press **TIMER**.

The Timer List appears.

4 Select [NEW] and press **ENTER**.

The Timer Record menu appears.

Timer Record				100 min Remain	
Input	Date	Start	Stop	Mode	Set-Top Channel
L1	10/12 Sun	7:20 PM	7:50 PM	SP	OFF

5 Press ←/→ to select an item and press ↑/↓ to adjust the setting.

[Input]: Select the input source, L1 or L2.

[Date]: Sets the date up to one month in advance.

[Start]: Sets the start time.

[Stop]: Sets the stop time.

[Mode]: Selects the recording mode (page 35). If you select [AT], you can use the Rec Mode Adjust function. See "Rec Mode Adjust" on page 37.

[Set-Top Channel]: Selects the channel.

- When using the cable box/satellite receiver control, select the channel using ↑/↓ or the number buttons.

- When not using the cable box/satellite receiver control, select [OFF] by pressing CLEAR. Be sure to select the channel on the connected cable box/satellite receiver's side before the timer recording starts.

If you make a mistake, select the item and change the setting.

6 Press **ENTER**.

The Timer List appears with the timer setting you made.

Timer List							1/2
Input	Date	Start	Length	Mode	Set-Top Channel	Check	
NEW							
L1	10/12 Sun	7:20 PM	30min	SP	OFF	Rec. OK	

To make another timer setting, select [NEW] and press ENTER. Repeat steps 5 and 6.

7 Press RETURN to turn off the Timer List.

"⊙" lights up on the front panel display and the recorder is ready to start recording.

There is no need to turn off the recorder before the timer recording starts.

Leave the cable box/satellite receiver turned on. Do not change the channel selected on the cable box/satellite receiver during recording.

To stop recording during timer recording

Switch the input selector on your TV so that the confirmation appears on the TV screen.

Press **■ REC STOP**. Press **ENTER** before the confirmation message turns off. Note that it may take a few seconds for the recorder to stop recording.

Rec Mode Adjust

If there is not enough available disc space for the recording, the recorder automatically selects the recording mode that will record the entire program. To use this function, select **[AT]** (auto) for the recording mode.

If the timer settings overlap

If the timer settings overlap, **[Duplicate Date]** will appear in the Timer List. For details, see “When the timer settings overlap” (page 38).

To confirm, change, or cancel timer recording

See “Checking/Changing/Cancelling Timer Settings (Timer List)” (page 37).

Hint

You can play the recorded program by selecting the program title in the Title List menu.

Notes

- Check that the clock is correctly set before setting the timer recording. If not, the timer recording cannot be made.
- Even if the timer is set for the same daily or weekly program, the timer recording cannot be made if it overlaps with a program that has priority. **[Duplicate Date]** will appear for the overlapped setting in the Timer List. Check the priority order of the settings (page 38).
- Even if the timer is set, timer recordings cannot be made while recording a program that has priority.
- The Rec Mode Adjust function only works with a timer recording. It does not function with Quick Timer (page 39).
- If “” flashes on the front panel display, check that a recordable disc is inserted correctly and available recording time on the disc is enough.

Checking/Changing/ Canceling Timer Settings (Timer List)

+RW **-RWVR** **-RWVideo** **+R** **-R**

You can check, change, or cancel timer settings using the Timer List menu.

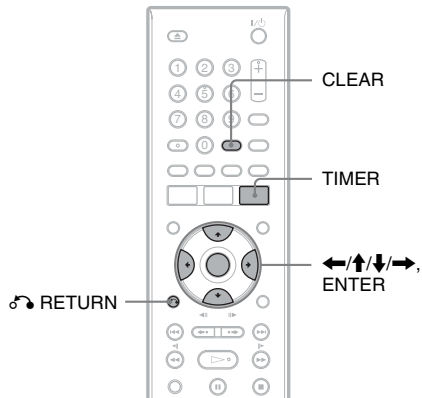

Recording

Changing the timer settings

The Timer List can contain up to 16 timer settings. You can select a timer setting and modify it before the recording starts.

1 Press **TIMER** to turn on the Timer List.

All the timer settings are listed. You can check information such as the recording date, time, recording mode, etc.

Timer List							
Input	Date	Start	Length	Mode	Set-Top Channel	Check	1/2
NEW							
L1	10/12 Sun	7:20 PM	30min	SP	OFF	Rec. OK	
L1	10/13 Mon	8:00 PM	30min	SP	OFF	Duplicate Date	
L1	10/13 Mon	8:15 PM	15min	SP	OFF	Duplicate Date	

- **[Rec. OK]** indicates that the timer recording will be made as you set. If the timer settings overlap, **[Duplicate Date]** will appear.

2 Select a timer setting and press ENTER.

The Timer Record menu in step 4 of “Timer Recording From Connected Equipment” (page 36) appears.

The input, date, start and stop times, recording mode, and channel for the selected timer setting appear.

3 Press ←/→ to select an item and press ↑/↓ to change the setting.

- If you want to return to the Timer List without changing, press TIMER.

4 Press ENTER.

The information for the selected timer setting is updated.

◆When the end time of one recording and the start time of another are the same

After finishing the previous recording, the other recording may be delayed.

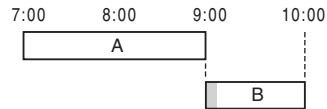

🔍 Notes

- While recording, you cannot change the timer setting for the current recording.
- Even if the timer is set, timer recordings cannot be made while recording a program that has priority.
- Even if the timer is set for the same daily or weekly program, the timer recording cannot be made if it overlaps with a program that has priority. [Duplicate Date] will appear for the overlapped setting in the Timer List. Check the priority order of the settings.

Canceling the timer settings

1 After step 1 above, select a timer setting and press CLEAR.

The display asks for confirmation.

2 Select [OK] and press ENTER.

The selected timer setting is deleted from the Timer List.

- If you want to cancel the deletion, select [Cancel] and press ENTER in step 2.

To turn off the Timer List

Press ⏪ RETURN.

When the timer settings overlap

If a timer setting overlaps with another timer setting (i.e., [Duplicate Date] appears in the Timer List), the program that starts first has priority and the second program starts recording only after the first program has finished.

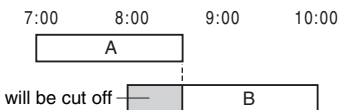

◆When the recordings start at the same time

The program that is set first has priority. In this example, timer setting A is set after B, so the first part of timer setting A will not be recorded.

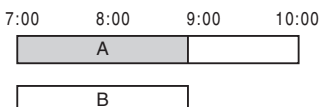

Recording Without the Timer

+RW -RWVR -RW_{Video} +R -R

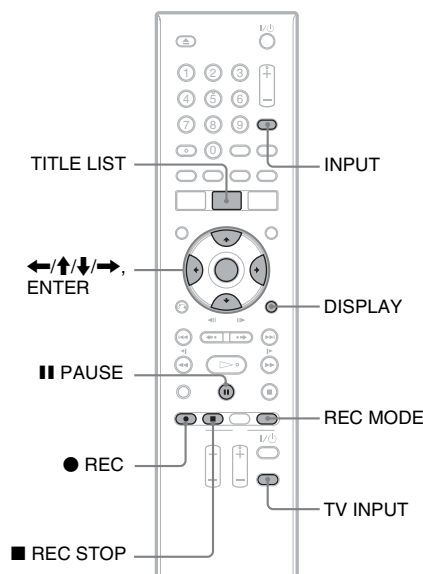

- 1 Insert a recordable disc.
- 2 Press INPUT repeatedly to select the connected input (L1).
- 3 Select the channel on the cable box/satellite receiver's side.
- 4 Press REC MODE repeatedly to select the recording mode.

Each time you press the button, the display changes on the TV screen as follows:

HQ → SP → LP → EP → ULP

For details about the recording mode, see page 35.

- 5 Press ● REC. Recording starts and "REC" (red) appears in the front panel display. Recording continues until you stop the recording or the disc is full.

Leave the cable box/satellite receiver turned on and do not change the channel you are recording.

To stop recording

Press ■ REC STOP. Note that it may take a few seconds for recording to stop.

To pause recording

Press || PAUSE. To restart recording, press the button again.

To watch another TV program while recording

Set your TV to the TV input using the TV INPUT button (page 16) and select the program you want to watch.

💡 Hint

If you do not want to watch TV while recording, you can turn off the TV.

⚡ Notes

- After pressing ● REC, it may take a short while to start recording.
- You cannot change the recording mode while recording or during recording pause.
- If there is a power failure, the program you are recording may be erased.
- You cannot change the input source during recording.

Using the Quick Timer function

You can set the recorder to record in 10-minute increments.

Press ● REC repeatedly to set the duration.

Recording starts after the first press. The Quick Timer starts from the third press, and then each additional press increases the recording time by 10 minutes within the available free space on the disc.

→ Continue → 10M → 20M → 30M → ...

The remaining recording time appears momentarily on the TV screen.

The time counter in the front panel display decreases to 0:00 (or when the disc is full), then the recorder stops recording (power turns off).

To check the Quick Timer

Press ● REC once while recording. The remaining recording time and other recording information (channel, recording mode, etc.) appear momentarily on the TV screen.

To cancel or stop the Quick Timer

To return the recorder to normal recording mode, press ● REC repeatedly while recording. [Continue] appears momentarily on the TV screen.

To stop recording, press ■ REC STOP. Note that it may take a few seconds for recording to stop.

To extend the Quick Timer

Press ● REC repeatedly while recording. After the recorder returns to normal recording mode, the recording time extends by 10 minutes (up to the capacity of the disc).

Checking status while recording

You can check recording information such as recording time or recording mode, etc.

Press DISPLAY during recording.

Recording information appears on the TV screen.

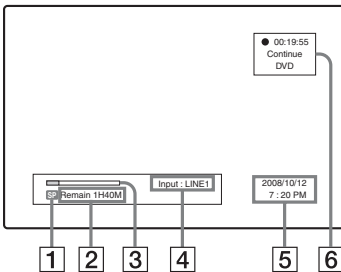

- 1 Recording mode
- 2 Available recording time for the disc
- 3 Recording status bar
- 4 Input source
- 5 Current date/time
- 6 Elapsed recording time

Press DISPLAY to turn off the display.

Creating chapters in a title

The recorder automatically divides a recording (a title) into chapters by inserting chapter marks at 5 or 10-minute intervals during recording. Select the interval, [5 minutes] or [10 minutes] for [Auto Chapter] in the [Video] setup (page 67).

💡 Hints

- You can create chapters manually when playing a DVD+RW, DVD-RW (VR mode), or DVD+R (page 56).
- When recording in ULP mode, chapter marks are inserted at 10-minute intervals.

Overwriting a recorded title

+RW

You can use the Title List to make a new recording over a title previously recorded on the disc. For details about the Title List, see page 28.

- 1 Insert a DVD+RW.
- 2 Select the input source (L1) and select the channel on the cable box/satellite receiver's side.
- 3 Press TITLE LIST to turn on the Title List.
- 4 Press ←/↑/↓/→ to select the title you want to overwrite.
- 5 Press ● REC.
Recording starts.

To stop recording

Press ■ REC STOP. Note that it may take a few seconds for recording to stop.

💡 Hint

If you erase a title from a DVD+RW, it appears as [Erase] in the Title List. This will not increase the remaining time on the disc. However, the remaining time will be increased when erasing the last title. You can select [Erase] from the Title List and make a new recording on top of it (page 53).

📌 Notes

- A protected title cannot be overwritten (page 54).
- If the selected title is shorter than the new recording, or less than ten seconds, the recorder automatically overwrites the next title in the Title List. If you do not want a title to be overwritten, protect the title (page 54).

Recording From a VCR or Similar Device

+RW -RWVCR -RW_{Video} +R -R

You can record from a connected VCR or similar device. To connect a VCR or similar device, see “Connecting a VCR or Similar Device” (page 21). Use the DV IN jack on the front panel if the equipment has a DV output jack (i.LINK jack).

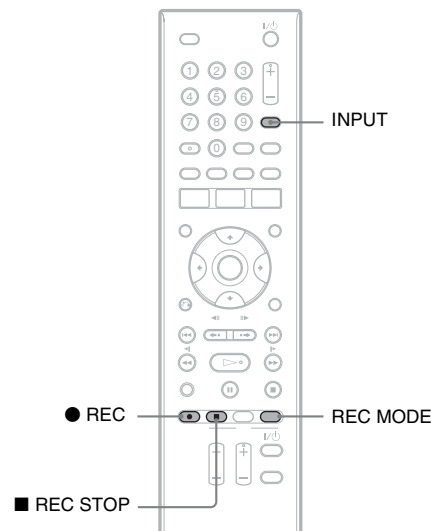

- 1 Insert a recordable disc.
- 2 Press **INPUT** repeatedly to select an input source according to the connection you made.

The front panel display changes as follows:

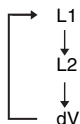

- 3 Press **REC MODE** repeatedly to select the recording mode.

The recording mode changes as follows:

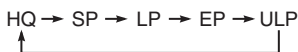

- 4 Insert the source tape into the connected equipment and set to playback pause.

- 5 Press **REC** on this recorder and the pause or play button on the connected equipment at the same time.

Recording starts.

To stop recording, press **REC STOP** on this recorder.

If you connect a digital video camera with a DV IN jack

See “DV Dubbing” (page 59) for an explanation of how to record from the DV IN jack.

Notes

- When recording a video game image, the screen may not be clear.
- Any program that contains a Copy-Never copy guard signal cannot be recorded. The recorder automatically stops recording after a few seconds.

Playing



To play from the USB memory, see page 43.

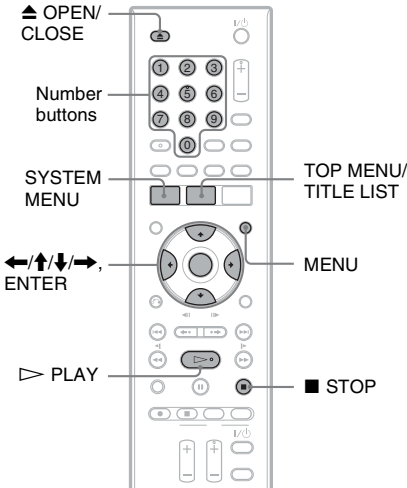

- 1 Press **▲ OPEN/CLOSE**, and place a disc on the disc tray.

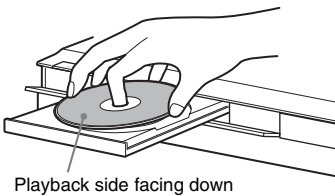

- 2 Press **▲ OPEN/CLOSE** to close the disc tray.

The disc's menu may appear when a DVD VIDEO or VIDEO CD was inserted. Select the title or chapter you want to play using **←/↑/↓/→**, etc, for DVDs; number buttons for VIDEO CDs.

- 3 Press **TITLE LIST**.

For details about the Title List, see "Viewing the Recorded Program (Title List)" (page 28).

Example: DVD-RW (VR mode)

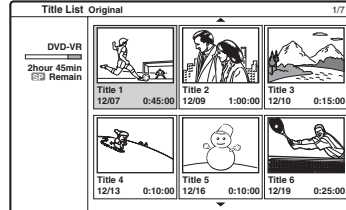

- 4 Select a title, and press **ENTER**.

The sub-menu appears.

- 5 Select **[Play]**, and press **ENTER**.

Playback starts from the selected title on the disc.

💡 Hints

- You can also use the **▷ PLAY** button to start playback. Playback starts automatically depending on the disc.
- To play a title including hidden chapters on a DVD+RW/DVD+R, select **[Full Play]** in step 5. For details about hidden chapters, see page 56.

To select a chapter from the Chapter List (DVD+RW, DVD-RW, DVD+R, and DVD-R only)

- 1 Select **[Search]** from the sub-menu in step 5 above and press **→**.
- 2 Select **[Chapter]** and press **ENTER**. The Chapter List of the selected title appears. For details about the Chapter List, see page 29.
- 3 Select the chapter you want to play and press **ENTER**. The sub-menu appears.
- 4 Select **[Play]** and press **ENTER**. Playback starts from the selected chapter.

To use the DVD's Menu

When you play a DVD VIDEO, or a finalized DVD+RW, DVD-RW (Video mode), DVD+R, or DVD-R, you can display the disc's menu by pressing **TOP MENU** or **MENU**.

To play VIDEO CDs with PBC functions

PBC (Playback Control) allows you to play VIDEO CDs interactively using the menu on your TV screen.

When you start playing a VIDEO CD with PBC functions, the menu appears.

Select an item using the number buttons and press ENTER. Then, follow the instructions in the menu (press ▷ PLAY when [Press SELECT] appears).

Hint

To play without PBC functions, set [PBC] to [Off] in the [Disc] setup (page 68). VIDEO CDs are played in continuous play mode only.

Note

For a Super VCD, you cannot set [PBC] to [Off] in the [Disc] setup (page 68).

To stop playback

Press ■ STOP.

To resume playback from the point where you stopped the disc (Resume Play)

The recorder stores the point where you stopped the disc.

Press ■ STOP once to stop playback. When you play the disc next time, the recorder resumes playback from the point where you stopped the disc.

To start from the beginning, press ■ STOP twice. Playback starts from the beginning of the title/track/scene.

The point where you stopped playing is cleared when:

- you open the disc tray.
- you turn off the recorder.
- you play another title.
- you switch the Title List to Original or Playlist.
- you edit the title after stopping playback.
- you change the settings on the recorder.
- you make a recording.
- you disconnect the mains lead (the power cord).

Hint

For DVD VIDEOS, the recorder stores the stop point even if you open the disc tray or turn off the recorder.

To play restricted DVDs (Parental Control)

If you play a restricted DVD, the message [Playback limited by Parental Control.] and the display for entering your password appear on the TV screen. Enter your four-digit password using the number buttons. The recorder starts playback.

To register or change the password, see “Parental Control Settings (Lock)” (page 66).

Playing from the USB memory

You can play JPEG image files or MP3 audio tracks in the inserted USB memory.

1 Insert an USB memory in the USB jack on the front panel (page 24).

2 Press SYSTEM MENU to turn on the System Menu.

3 Select [Media] and press ENTER.

4 Select [Photo] or [Music], and press ENTER.

5 Select [USB] and press ENTER.

The Photo Album or Music Jukebox display appears.

6 Select a track or file, and press ENTER.

7 Select [Play] for music; [Full Screen] for photos, and press ENTER.

For details about the Music Jukebox or Photo Album, see page 48 and 50.







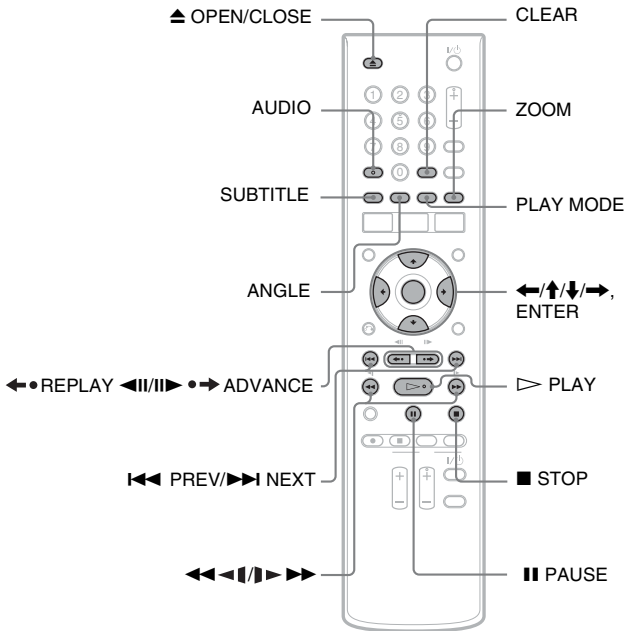

Note

Do not remove the USB memory during this operation. Stop playback and turn off the list menu beforehand.

Playback options



Buttons	Operations	Discs
▲ OPEN/CLOSE	Stops playing and opens the disc tray.	All discs
▬ PAUSE	Pauses playback.	All discs
◀◀ PREV/ ▶▶ NEXT	Goes to the beginning of the current or next title/ chapter/scene/track.	All discs
◀◀◀/▶▶▶ (fast reverse/fast forward)	Fast reverses/fast forwards the disc when repeatedly pressed during playback. Search speed changes as follows: Fast forward ▶▶▶ 1 → ▶▶▶ 2 → ▶▶▶ 3 → ▶▶▶ 4* → ▶▶▶ 5* Fast reverse ◀◀◀ (reverse play) → ◀◀◀ 1 → ◀◀◀ 2 → ◀◀◀ 3 → ◀◀◀ 4* → ◀◀◀ 5*	All discs * not available for VIDEO CDs.

Buttons	Operations	Discs
 (slow)	Plays in slow motion when pressed repeatedly in pause mode. Playback speed changes as follows: Forward slow ►► 1 → ►► 2 → ►► 3 → ►► 4** Reverse slow** ◄◄ 1 → ◄◄ 2 → ◄◄ 3 → ◄◄ 4	All discs ** not available for VIDEO CDs.
 REPLAY/ADVANCE	Replays the scene/briefly fast forwards the scene when pressed during playback.	
 (freeze frame)	Plays one frame at a time when pressed in pause mode (not available for DVD+R DL discs).	
AUDIO	Selects one of the audio tracks recorded on the disc when pressed repeatedly. DVD : Selects the language.  : Selects one of the recorded audio tracks.	All discs
SUBTITLE	Selects a subtitle language when pressed.	DVD
ANGLE	Selects an angle when pressed repeatedly. “  ” appears briefly at the scene where the angle to be changed. If various angles (multi-angles) for a scene are recorded on the disc, “  ” appears in the front panel display.	DVD

To resume normal playback, press  PLAY.

Notes

- If “” appears, the operation is not available on the disc.
- When playing the discs recorded on this recorder, angles and subtitles cannot be changed.
- For a Super VCD, you cannot select audio track 2 if one is recorded on the disc.

To enlarge a video image (Zoom)

Press ZOOM repeatedly during playback or pause mode. Magnification changes as follows:

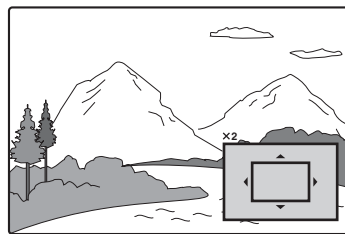
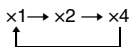

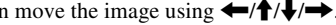
You can move the image using .
 To resume normal playback, press CLEAR.

Notes

- The zoom function may not work depending on the disc.
- The zoom function is not available for VIDEO CDs.

To play repeatedly

Press PLAY MODE repeatedly to select an item to be repeated.

[Chapter]: repeats the current chapter. (DVD only)

[Title]: repeats the current title. (DVD only)

[Track]: repeats the current track. (VIDEO CD only)

[All]: repeats all the tracks on the disc. (DVD-RW (VR mode)/VIDEO CD only)

[Off]: does not play repeatedly.

Notes

- For a VIDEO CD with PBC function, set [PBC] to [Off] in the [Disc] setup (page 68).
- If you press ■ STOP, or ◀• REPLAY during Repeat Play, Repeat Play is canceled.

To repeat a specific portion (A-B Repeat)

You can play a specific portion of a title, chapter, or track repeatedly.

- 1 During playback, when you find the starting point (point A) of the portion to be repeated, press PLAY MODE.
[A-] appears on the TV screen.
- 2 When you reach the ending point (point B), press ENTER.
[A-B] appears and the recorder starts repeating this specific portion.
To return to normal playback, press PLAY MODE repeatedly to select [Off].

Note

A-B Repeat Play may not work properly with some Super VCDs.

Note on playing DTS sound tracks on a CD

- When playing DTS-encoded CDs, excessive noise will be heard from the LINE OUT (AUDIO L/R)/AUDIO OUT (L/R) jacks. To avoid possible damage to the audio system, the user should take proper precautions when the LINE OUT (AUDIO L/R)/AUDIO OUT (L/R) jacks of the recorder are connected to an amplification system. To enjoy DTS Digital Surround™ playback, an external DTS decoder system must be connected to the DIGITAL OUT (COAXIAL) jack of the recorder.
- Set the sound to “Stereo” using the AUDIO button when you play DTS sound tracks on a CD (page 44).

Notes on playing DVDs with a DTS sound track

DTS audio signals are output only through the DIGITAL OUT (COAXIAL) jack.

When you play a DVD with DTS sound tracks, set [DTS Output] to [On] in the [Audio] setup (page 65).

Searching for a Title/Chapter/Track, etc.



You can start playing from the exact title, chapter, or the point you like.

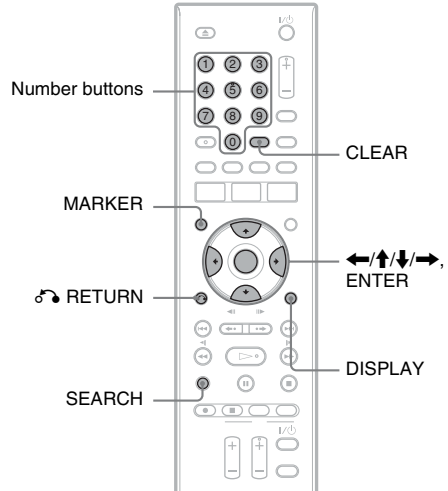

- 1 Press DISPLAY twice during playback.

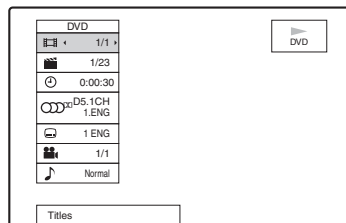

- 2 Select a search item, and press ENTER.
 - Title (for DVDs)
 - Chapter (for DVDs)
 - Track (for VIDEO CDs with PBC function off)
 - Time: Searches for the starting point of entered time code (not available for DVD+R DL discs)

3 Press the number buttons to select the number of the title, chapter, time code, etc., you want.

For example: Time search

To find a scene at 2 hours, 10 minutes, and 20 seconds, enter "21020" and press ENTER.

If you enter the wrong number, press ←/→ to select the number you want to cancel, then enter another number.

The recorder starts playback from the selected number or scene.

Hint

You can search for a specific point of the title using the Title List (page 29).

Marking a favorite scene

You can have the recorder store specific portions of the disc in memory and play immediately whenever you want. Up to six markings can be set.

To mark a scene

During playback, press MARKER when you find a scene you want to mark.

The marker number appears on the TV screen.

To search for the marked scene

- 1 Press SEARCH.
The marker search display appears.

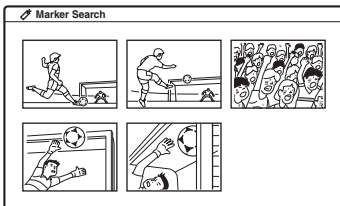

- 2 Press ←/↑/↓/→ to select the desired scene, and press ENTER.
Playback starts from the marked scene you selected.
- 3 Press ⏪ RETURN to turn off the display.

To erase the markings

- 1 Press SEARCH to turn on the marker search display.
- 2 Press ←/↑/↓/→ to select the marked scene, and press CLEAR.
The display asks for confirmation.
- 3 Select [OK], and press ENTER.
- 4 Press ⏪ RETURN to turn off the display.

Playing Music CDs and MP3 Audio Tracks

CD DATA DVD DATA CD

The recorder can play music CDs and MP3 audio tracks on DATA CDs/DATA DVDs and USB memory. For details about MP3 audio tracks, see page 80.

To play from the USB memory, see page 43.

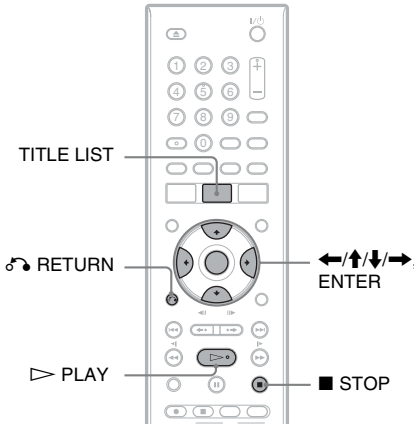

1 Insert a disc.

The Music Jukebox display appears on the TV screen.

Example: DATA CDs

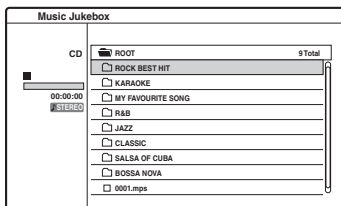

- If the Photo Album appears, press TITLE LIST to switch the lists.
- Some CDs automatically start playing from the beginning. When selecting a track, go to step 4.
- To play tracks listed on this layer, select the track and press ▷ PLAY.

2 Select an album and press ENTER.

The sub-menu appears.

3 Select [Open] and press ENTER.

The track list appears.

To return to the album list, select [⏪] and press ENTER.

4 Select a track and press ENTER.

The sub-menu appears.

5 Select [Play] and press ENTER.

Playback starts from the selected track.

- If you select [Random], you can play the tracks on the disc randomly.

To stop playback

Press ■ STOP.

When you start playback the next time, the recorder resumes playback from the point where you stopped the track.

Press ■ STOP twice to play from the beginning of the disc/track.

Hints

- For CDs, you can also select the track number by pressing the number buttons in step 4 above.
- Press ↑/↓ to go to the next/previous page of the list.
- If you press ↶ RETURN, playback stops and the list menu disappears. To turn on the list menu again, press TITLE LIST.
- Press DISPLAY to show detailed information for the selected track.

Note on playing DTS sound tracks on a CD

- When playing DTS-encoded CDs, excessive noise will be heard from the LINE OUT (AUDIO L/R)/AUDIO OUT (L/R) jacks. To avoid possible damage to the audio system, the user should take proper precautions when the LINE OUT (AUDIO L/R)/AUDIO OUT (L/R) jacks of the recorder are connected to an amplification system. To enjoy DTS Digital Surround™ playback, an external DTS decoder system must be connected to the DIGITAL OUT (COAXIAL) jack of the recorder.
- Set the sound to “Stereo” using the AUDIO button when you play DTS sound tracks on a CD (page 49).

Notes on playing DVDs with a DTS sound track

DTS audio signals are output only through the DIGITAL OUT (COAXIAL) jack.

When you play a DVD with DTS sound tracks, set [DTS Output] to [On] in the [Audio] setup (page 65).

Playback options

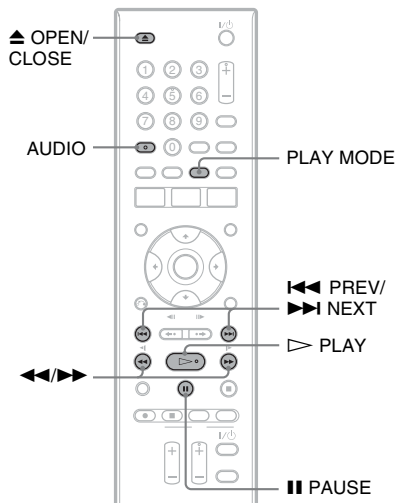

Buttons	Operations
▲ OPEN/CLOSE	Stops playing and opens the disc tray.
PAUSE	Pauses playback.
◀◀ PREV/ ▶▶ NEXT	Goes to the beginning of the current or next track.
◀◀/▶▶ (fast reverse/ fast forward) (not available for DATA CDs/DATA DVDs)	Fast reverses/fast forwards the disc when repeatedly pressed during playback. Search speed changes as follows: Fast forward ▶▶ → ▶▶1 → ▶▶2 Fast reverse ◀◀ → ◀◀1 → ◀◀2
AUDIO	Selects the audio track on the disc when pressed repeatedly.

To resume normal playback, press ▷ PLAY.

To play repeatedly

Press PLAY MODE repeatedly to select an item to be repeated.

[Track]: repeats the current track.

[Folder]: repeats the current folder (DATA CD/DATA DVD only).

[All]: repeats all the tracks on the disc (CD only).

[Off]: does not play repeatedly.

To repeat a specific portion (A-B Repeat) (CD only)

You can play a specific portion of a track repeatedly.

- 1 During playback, when you find the starting point (point A) of the portion to be repeated, press PLAY MODE.
[A-] appears on the TV screen.
- 2 When you reach the ending point (point B), press ENTER.
[A-B] appears and the recorder starts repeating this specific portion.
To return to normal playback, press PLAY MODE repeatedly to select [Off].

Playing JPEG Image Files

DATA DVD DATA CD

You can play JPEG image files on DATA CDs/ DATA DVDs and USB memory. For details about JPEG image files, see page 80.

To play from the USB memory, see page 43.

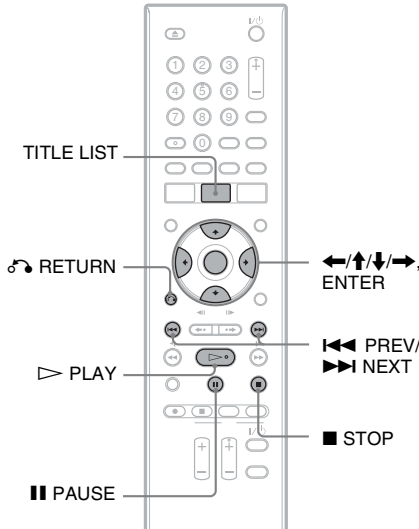

1 Insert a disc.

The Photo Album appears on the TV screen.

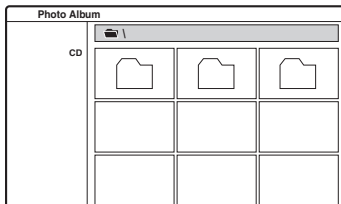

- If the Music Jukebox display appears, press TITLE LIST to switch the lists.
- To view a photo listed on this layer, select the file and press ▷ PLAY.

2 Select a folder, and press ENTER.

The sub-menu appears.

3 Select [Open] and press ENTER.

The file list appears.

To return to the folder list, select [⏪] and press ENTER.

4 Select the file you want to view and press ENTER.

The sub-menu appears.

To start a slide show, select [Slide Show] and press ENTER.

5 Select [Full Screen] and press ENTER.

The selected image is displayed full screen.

To rotate a image

Press ↑/↓ while viewing the image. Each press rotates the image clockwise or counterclockwise by 90 degrees.

To view the previous or next image

Press ◀◀ PREV/▶▶ NEXT or ◀/▶.

To return to the list menu

Press ■ STOP.

💡 Hints

- Press ↑/↓ to go to the next/previous page of the list.
- Press ↶ RETURN to turn off the list menu. To turn on the list menu, press TITLE LIST.
- Press ENTER or DISPLAY to turn on/off the button guide at the bottom of the screen.

Enjoying a slide show

1 After step 4 of "Playing JPEG Image Files" (page 50), select [Slide Show] and press ENTER.

A pop-up menu appears.

[Object] – [All] (fixed setting): Plays all photo files on the folder.

[Speed]: Select from [Normal], [Fast], and [Slow] by pressing ◀/▶.

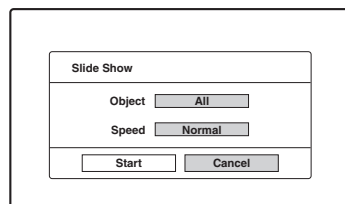

2 Select [Start] and press ENTER.

Slide show starts from the selected image file.

- To pause playback, press ■ PAUSE.
- To stop the slide show and return to the list menu, press ■ STOP or ↶ RETURN.

Erasing and Editing

Before Editing

This recorder offers various edit options for various disc and title types. Before you edit, check these types and select an available option.

Notes

- You may lose edited contents if you remove the disc while editing.
- Finish editing and recording before finalizing. No more editing or recording can be made on a finalized disc.
- If a message appears and indicates that the disc's control information is full, erase unnecessary titles.

Edits for Video mode titles/original titles

+RW -RWVR -RW_{Video} +R -R

For Video mode titles on DVD+RWs/DVD-RWs (Video mode)/DVD+Rs/ DVD-Rs, and original titles on DVD-RWs (VR mode), the recorder edits actual recordings on the disc. You cannot undo any edits you make, and the original contents will be consequently lost.

Hint

When using a DVD-RW (VR mode), you can keep the original contents by editing a Playlist (see "Edits for Playlist titles" below).

To free up disc space (DVD+RW/DVD-RW (VR mode)/DVD-RW (Video mode) only)

You can utilize disc capacity by erasing Video mode or original titles. The effect differs depending on the disc type and location of the title, as follows.

Disc type	To open up disc space
DVD+RW	Erase the last title on the disc. You can erase and overwrite titles other than the last one; however, the display will not show the resulting capacity increase. Erased titles are shown as deleted in the Title List menu.
DVD-RW (VR mode)	Erase original titles anywhere on the disc.
DVD-RW (Video mode)	Erase the last title on the disc.
DVD+R/ DVD-R	You cannot increase the disc capacity, as they are non-rewritable.

Note

For DVD+RWs and DVD-RWs (VR mode), the disc's available capacity may not display correctly. The recorder displays only the available capacity after the last title on the disc.

Edits for Playlist titles

-RWVR

For DVD-RWs (VR mode), you can edit a Playlist while retaining original titles (actual recordings on the disc). A Playlist is a group of Playlist titles created from the original title for editing purposes. When you create a Playlist, only the control information necessary for playback, such as the playback order, is stored on the disc. Since the original titles are left unaltered, Playlist titles can be re-edited.

Example: You have recorded the final few matches of a football tournament on a DVD-RW (VR mode). You want to create a digest with the goal scenes and other highlights, but you also want to keep the original recording.

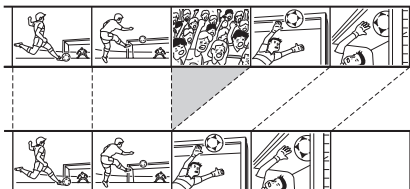

In this case, you can select a title or chapter and create a Playlist title. You can even rearrange the scene order within the Playlist title (page 58).

Hint

For DVD-RW (VR mode), you can display the disc's Playlist titles in Title List (Playlist), or the original titles in Title List (Original). Press TITLE LIST repeatedly to switch the two Title List menus.

List of edit options

Select from the following options and refer to the pages in parentheses. Title type and disc type that the option can be applied are indicated in each section.

- Labeling a title (page 53).
- Erasing a title (page 53).
- Erasing a section of a title (A-B Erase) (page 53).
- Protecting a title (page 54).
- Dividing a title (page 54).
- Hiding a title (page 55).
- Erasing a chapter (page 56).
- Combining chapters (page 56).
- Hiding a chapter (page 56).
- Creating chapters manually (page 56).
- Creating a Playlist title (page 57).
- Adding contents to an existing Playlist title (page 58).
- Rearranging chapters within a Playlist title (page 58).

Note

When selecting a title for editing, always note the above differences between the Video mode/original title edit and Playlist title edit.

Erasing and Editing Titles

This section explains the basic edit functions common to Video mode titles, original titles, and Playlist titles.

Note that editing on Video mode and original titles is irreversible as they are the actual recordings on the disc. If you want to edit a DVD-RW (VR mode) while retaining the original contents, create and edit a Playlist (page 57).

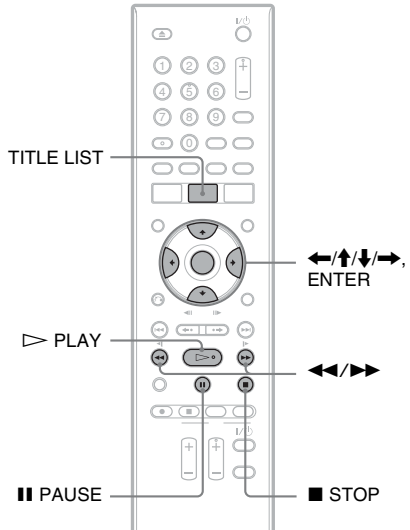

Note

If you edit an original title after creating a Playlist title, the edits may affect the derived Playlist title.

1 Press TITLE LIST to turn on the Title List.

The Title List menu appears and displays the disc contents.

When editing a DVD-RW (VR mode), press TITLE LIST repeatedly to switch the Title List (Original) and Title List (Playlist), if necessary.

Example: Title List (Original)

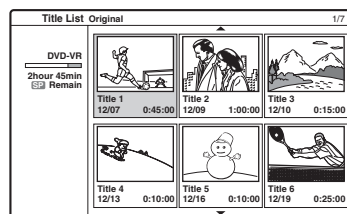

2 Select a title, and press ENTER.

The sub-menu appears with options available for the selected title.

[Search]: Displays the search options.

[Chapter]: Displays the Chapter List for playback and editing (page 55).

[Erase]: Erases the title (page 53). For effects on disc capacity, see page 51.

[Protect]: Protects the title from erasure or alteration (page 54).

[Edit]: Displays the following options.

[Title Name]: Allows you to label the title (page 53).

[Divide]: Divides the title in two (page 54).

[A-B Erase]: Erases a section of the title (page 53).

[Hide/Show]: Hides the title/Shows the hidden title (page 55).

[Playlist]: Allows you to create a new Playlist title, or add contents to an existing Playlist title (see “Editing a Playlist” on page 57).

3 Select an edit option, and press ENTER.

The selected option is applied to the title. See the pages in parentheses for the procedure.

Labeling a title

+RW -RWVr -RWVideo +R -R

1 Select [Edit] in step 3 of “Erasing and Editing Titles,” and press ENTER.

For DVD-RWs (Video mode) and DVD-Rs, select [Title] in step 1.

2 Select [Title Name], and press ENTER.

The display for entering characters appears. Follow the explanations of “Changing the Name of a Recorded Program (Title Input)” (page 31).

Hint

You can label or re-label DVDs (page 32).

Erasing a title

+RW -RWVr -RWVideo +R -R

1 Select [Erase] in step 3 of “Erasing and Editing Titles,” and press ENTER.

The display asks for confirmation.

2 Select [OK], and press ENTER.

The title is erased.

Hints

- When you want to erase all titles, reformat the disc (page 26).
- After erasing a title on a DVD+RW, the title name is displayed as erased in the Title List menu. You can select it to record over (page 40).

Erasing a section of a title (A-B Erase)

-RWVr

1 Select [Edit] in step 3 of “Erasing and Editing Titles,” and press ENTER.

2 Select [A-B Erase], and press ENTER.

The following display appears.

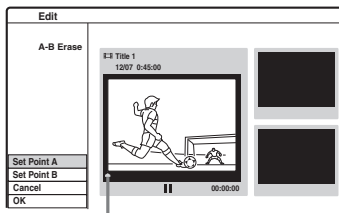

Current playback point

3 Press \blacktriangleright PLAY, and search for the scene you want to erase by pressing \blacksquare STOP, $\|\$ PAUSE, and \lll/\ggg .

- 4** Press **ENTER** at the start of the scene to be erased (point A).

Thumbnail of point A

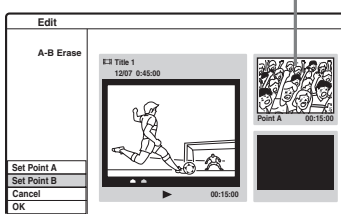

- 5** Press **▷** **PLAY**, and search for the scene you want to erase by pressing **■** **STOP**, **⏸** **PAUSE**, and **◀▶/▶▶**.

- 6** Press **ENTER** at the end of the scene (point B).

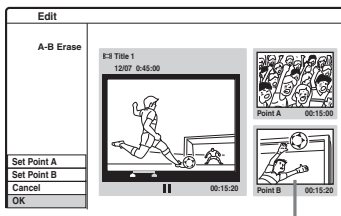

Thumbnail of point B

To reset either point A or B, select [Cancel] and repeat from step 3.

- 7** Select **[OK]**, and press **ENTER**.
The display asks for confirmation.
If you do not want to erase the scene, select [Cancel] and press **ENTER**.
- 8** Select **[OK]**, and press **ENTER**.
The scene is erased.

🔊 Notes

- Images or sound may be momentarily interrupted at the point where you erase the scene.
- Sections shorter than three seconds may not be erased.
- The erased section may be slightly different from the points you selected.
- A chapter mark will not be made at the A–B erase point.

Protecting a title from erasure or alteration

+RW **-RWVR** **+R**

- 1** Select **[Protect]** in step 3 of “Erasing and Editing Titles,” and press **ENTER**.

The title is protected and **[🔒]** (locked) appears in the Title List menu.

To cancel the protection, repeat the steps above and select [Unprotect].

Dividing a title

+RW

- 1** Select **[Edit]** in step 3 of “Erasing and Editing Titles,” and press **ENTER**.

- 2** Select **[Divide]**, and press **ENTER**.

The display for setting the dividing point appears.

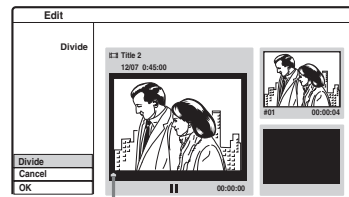

Current playback point

- 3** Press **▷** **PLAY**, and search for the point you want to divide by pressing **■** **STOP**, **⏸** **PAUSE**, and **◀▶/▶▶**.

- 4** Press **ENTER** at the 1st dividing point.

The 1st point is set.

To reset the point, select [Cancel] and repeat from step 3.

- 5** Press **▷** **PLAY**, and search for the point you want to divide by pressing **■** **STOP**, **⏸** **PAUSE**, and **◀▶/▶▶**.

- 6** Press **ENTER** at the 2nd dividing point.

The 2nd point is set.

- 7** Select **[OK]** from the sub-menu, and press **ENTER**.

The title is divided in two. If you want to rename the title, see page 53.

If you do not want to divide the title, select [Cancel] from the sub-menu, and press ENTER.

Hiding a title

+RW

You can skip playing titles without deleting them from the disc.

1 Select [Edit] in step 3 of “Erasing and Editing Titles,” and press ENTER.

2 Select [Hide], and press ENTER.

The title is displayed shaded in the Title List menu.

To show the hidden title

Repeat the steps above and select [Show].

Editing a Title by Chapter

You can make detailed editing to a title by using the Chapter List menu that displays title contents by chapter.

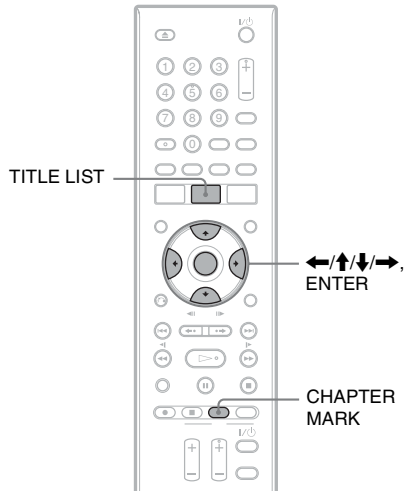

1 Press TITLE LIST to turn on the Title List.

When editing a DVD-RW (VR mode), press TITLE LIST repeatedly to switch the Title List (Original) and Title List (Playlist), if necessary.

2 Select a title, and press ENTER.

The sub-menu appears.

3 Select [Search], and press ENTER.

4 Select [Chapter], and press ENTER.

The Chapter List menu appears with contents of the selected title (displayed as chapters).

Example: Chapter List (Original)



5 Select a chapter, and press ENTER.

The sub-menu appears with options available for the selected chapter.

[Title]: Returns to the Title List menu (see “Erasing and Editing Titles” on page 52).

[Erase]: Erases the chapter (page 56).

[Combine]: Combines two chapters into one (page 56).

[Hide/Show]: Hides the chapter/Shows the hidden chapter (page 56).

[Move]: Allows you to change the chapter order within the Playlist title (see “Rearranging chapters within a Playlist title” on page 58).

[Playlist]: Allows you to create a new Playlist title, or add contents to an existing Playlist title (see “Editing a Playlist” on page 57).

6 Select an edit option, and press ENTER.

The selected option is applied to the chapter. See the pages in parentheses for the procedure.

Erasing a chapter

-RWVR

1 Select [Erase] in step 6 of “Editing a Title by Chapter,” and press ENTER.

The display asks for confirmation.

2 Select [OK], and press ENTER.

The chapter is erased.

Combining chapters

+RW -RWVR +R

Select [Combine] in step 6 of “Editing a Title by Chapter,” and press ENTER.

The selected chapter is combined with the next chapter in the Chapter List.

Note

If the next chapter on the DVD+RW/DVD+R is hidden, show the chapter in the Title List before combining. See “Hiding a chapter” (page 56).

Hiding a chapter

+RW +R

You can skip playing chapters without deleting from the disc.

Select [Hide] in step 6 of “Editing a Title by Chapter,” and press ENTER.

The chapter is displayed shaded in the Chapter List menu.

To play the title without skipping hidden chapters

Select a title in the Title List and press ENTER. Select [Full Play] from the sub menu, and press ENTER.

To show the hidden chapter

Repeat the steps above and select [Show].

Notes

- Images or sound may be momentarily interrupted at the point where you hide the chapter.
- On other Sony DVD equipment, hidden chapters will play without being skipped.

Creating chapters manually

+RW -RWVR +R

You can create chapters within a title by inserting chapter marks at the desired points.

During playback or recording, press CHAPTER MARK where you want to divide the title into chapters.

The following display appears at the dividing point. Title contents before and after this scene become separate chapters.



Hints

- You can combine two chapters into one (page 56).
- Titles are automatically divided into chapters during recording if [Auto Chapter] in the [Video] setup is set (page 67).

Note

If a message appears and indicates that no more chapter marks can be added, you may not be able to record or edit.

Editing a Playlist

-RWVR

Playlist edit allows you to edit or re-edit without changing the actual recordings.

This section explains edit options available only for Playlist titles. Edits explained in the previous sections are also applicable if so indicated.

Notes

- If you edit an original title after creating a Playlist title, the results may affect the derived Playlist title.
- The picture may pause when an edited scene is played.

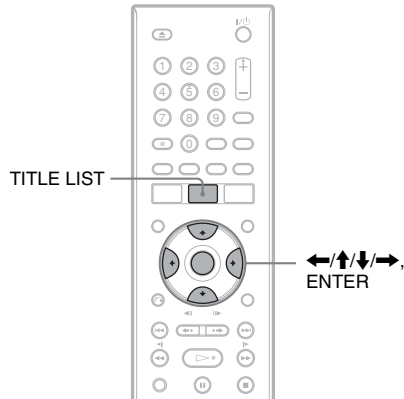

Creating a Playlist title

1 Press TITLE LIST to turn on the Title List (Original).

Press TITLE LIST again if the Title List (Playlist) appears.

2 Select a title, and press ENTER.

The sub-menu appears.

[Search]: Displays the search options.

[Chapter]: Displays the Chapter List (Original). When you want to add an original chapter as a Playlist title, select this and press ENTER. After the Chapter List (Original) appears, select the chapter and press ENTER, and then go to step 3.

[Playlist]: Allows you to create a new Playlist title, or add contents to an existing Playlist title.

3 Select [Playlist], and press ENTER.

4 Select [New Playlist], and press ENTER.

The title or chapter is added to the Playlist as a new Playlist title.

To create more Playlist titles, press TITLE LIST and repeat the steps above.

Adding contents to an existing Playlist title

1 Select a title or chapter in step 2 of “Creating a Playlist title” (page 57).

2 Select [Playlist], and press ENTER.

The disc’s Playlist title names appear (if any).

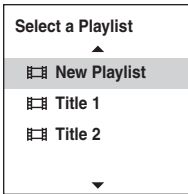

3 Select a Playlist title, and press ENTER.

The contents of original title or chapter selected in step 1 are added to the Playlist title. If you want to rename the title, see page 53.

Rearranging chapters within a Playlist title

You can move chapters in a Playlist title to create a different playback order.

1 Press TITLE LIST to turn on the Title List (Playlist).

Press TITLE LIST again if the Title List (Original) appears.

2 Select a title, and press ENTER.

The sub-menu appears.

3 Select [Search], and press ENTER.

4 Select [Chapter], and press ENTER.

The Chapter List menu appears with the title contents.



5 Select a chapter, and press ENTER.

The sub-menu appears.

6 Select [Move], and press ENTER.

7 Select a new location in the Chapter List, and press ENTER.

The chapter moves to the new location.

To change the scene order more, repeat the steps above.

If you want to rename the title, see page 53.

Note

Images or sound may be momentarily interrupted at the point where the chapters change.

Before DV Dubbing

This section explains dubbing with a digital video camera via the DV IN jack on the front panel. If you want to dub by way of the LINE IN jacks, see “Recording From a VCR or Similar Device” (page 41).

To record from the DV IN jack

The DV IN jack on this recorder conforms to the i.LINK standard. You can connect any other equipment that has an i.LINK (DV) jack, and record digital signals.

Follow the instructions in “Connecting a Digital Video Camera to the DV IN Jack,” and then move on to the section on dubbing. For more information about i.LINK, see “About i.LINK” (page 81).

Hint

If you plan to do additional editing on a disc after the initial dub, use the DV IN jack and record on a DVD-RW (VR mode).

Notes

- The DV IN jack is for input only. It will not output signals.
- You cannot use the DV IN jack when:
 - your digital video camera does not work with this recorder. Connect the camera to the LINE IN jack and follow the instructions of “Recording From a VCR or Similar Device” (page 41).
 - the input signal is not in DVC-SD format. Do not connect a MICRO MV format digital video camera even if it has an i.LINK jack.
 - the images on the tape contain copy protection signals, which limit recording.
- If you want to play the disc on other DVD equipment, finalize the disc (page 33).
- The recorder does not support HDV mode.

Connecting a Digital Video Camera to the DV IN Jack

You can connect a digital video camera to the DV IN jack on the recorder to record or edit from a DV/Digital8 format tape. Operation is straightforward because the recorder will fast forward and rewind the tape for you – you do not need to operate your digital video camera. Do the following to start using the “DV Edit” functions of this recorder.

See also the instruction manual supplied with the digital video camera before connecting.

Hookups

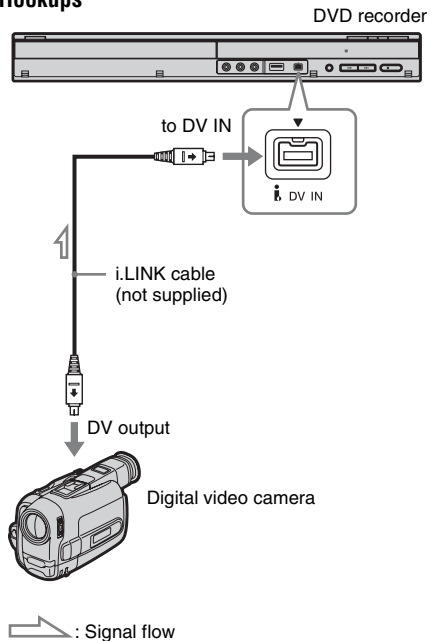

Dubbing From a DV/Digital8 Format Tape to a DVD

+RW -RWVR -RW_{Video} +R -R

You can record a DV/Digital8 format tape onto a disc. The recorder controls the digital video camera. You can fast forward, rewind, and stop the tape to select a scene using the recorder's remote control.

◆How chapters are created

The dubbed contents become one title, and the title is divided into chapters. The recorder divides the title into chapters according to the setting in [Video] Setup (5 or 10-minute intervals, or does not divide at all) (page 67).

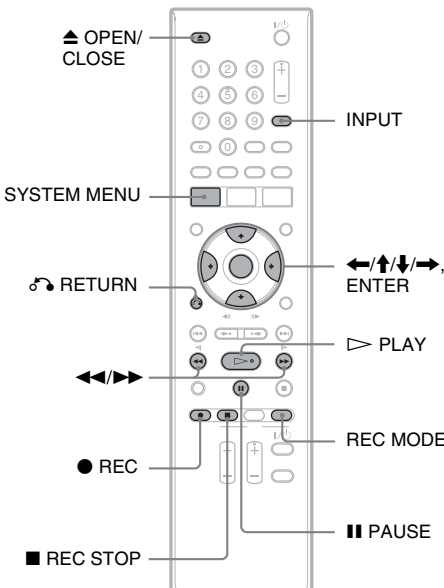

1 Press **OPEN/CLOSE**, and place a recordable disc on the disc tray.

Make sure that the disc has enough free space to record the contents of your tape.

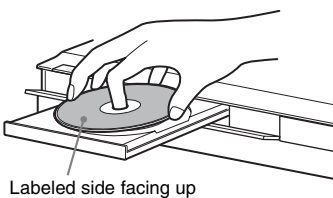

2 Press **OPEN/CLOSE** to close the disc tray.

Wait until "READ" disappears from the front panel display.

For details on how to insert and format a new disc, see "Inserting and Formatting a Disc" (page 26).

3 Insert the source DV/Digital8 format tape into your digital video camera.

For the recorder to record or edit, your digital video camera must be turned on and set to video playback mode.

4 Press **INPUT** on the remote repeatedly to select "dV."

The selected input changes as follows:

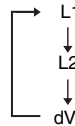

5 Press **REC MODE** on the remote repeatedly to select the recording mode.

The recording mode changes as follows:

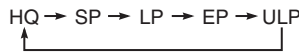

For details about the recording modes, see page 35.

6 Press **SYSTEM MENU** to turn on the System Menu.

7 Select [Setup] and press **ENTER**.

The Setup Display appears.

8 Select [Video] Setup and press **ENTER**.

9 Select [DV Input], and press **➡**.

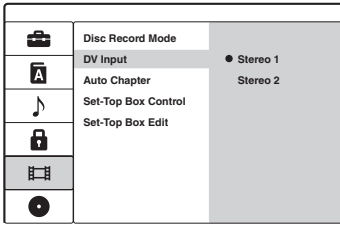

[Stereo 1] (default): Records original sound only. Normally select this when dubbing a DV format tape.

[Stereo 2]: Records additional audio only. Select this only if you have added a second audio channel when recording with your digital video camera.

10 Select an option, and press **ENTER**.

11 Press **↶** RETURN to turn off the Setup Display.

12 Press **▶** PLAY to start playing the DV/Digital8 format tape.

The playback picture appears on the screen.

13 While watching the screen, search for the point you want to start recording by pressing **◀◀/▶▶**.

14 When you find the point you want, press **■** PAUSE.

15 Press **●** REC.

Playback starts from the selected point, and the recorder starts recording.

To stop recording

Press **■** REC STOP. Note that it may take a few seconds for the recorder to stop recording.

⚡ Notes

- If you want to play the disc on other DVD equipment, finalize the disc (page 33).
- You cannot connect more than one piece of digital video equipment to the recorder.
- You cannot control the recorder using another device or another recorder of the same model.
- You cannot record date, time, or the contents of the cassette memory onto the disc.
- When dubbing from a DV/Digital8 format tape by way of the DV IN jack, the recorder starts recording about five seconds after the tape starts playing.
- If you dub a DV/Digital8 format tape that has been edited on a PC using the DV IN jack, any audio recorded on the Stereo 2 track may only be recorded as noise.
- If you record from a DV/Digital8 format tape with a sound track that is recorded in multiple sampling frequencies (48 kHz, 44.1 kHz, or 32 kHz), no sound or an unnatural sound will be output when playing back the sampling frequency switch point on the disc.
- The recorded picture may be momentarily affected if the picture size of the source image changes, or if there is nothing recorded on the tape.
- Noise may occur when you switch the audio sampling mode (e.g. 48 kHz/16 bits → 32 kHz/12 bits).
- The video or sound may drop out during the recording of start/stop points on the tape.
- If there is a blank space for one second or more on the tape, DV dubbing ends automatically.

Using the Setup Displays

By using the Setup Displays, you can make various adjustments to items such as picture and sound, as well as select a language for the subtitles.

The Setup Display consists of several levels to set up options. To select the next level, press **→**. To select a previous level, press **←**.

Note

Playback settings stored in the disc take priority over the Setup Display settings, and not all of the functions described may work.

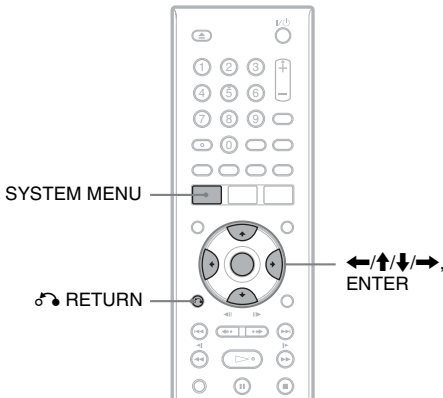

1 Press **SYSTEM MENU** to turn on the System Menu.

2 Select **[Setup]** and press **ENTER**.

The Setup Display appears.

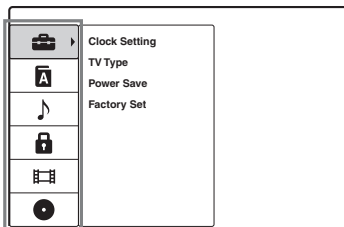

Setup options:
[General], [Language], [Audio], [Lock],
[Video], [Disc]

3 Press **↑/↓** to select the option you want to set up, and press **→**.

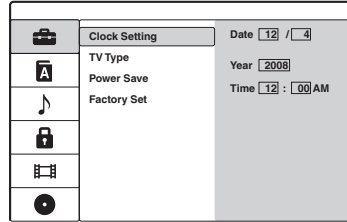

4 Press **↑/↓** to select the item you want to set up, and press **→**.

Available options for the item appear.
Example: [TV Type]

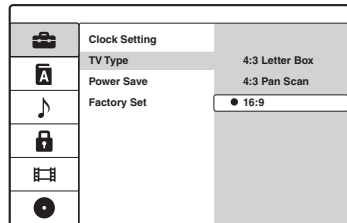

5 Press **↑/↓** to select the item you want to set up, and press **ENTER** to conform.

Some items require additional settings.

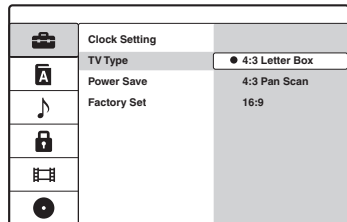

To turn off the Setup Display

Press **RETURN**.

Recorder Settings (General)

The [General] setup helps you to make clock and other settings for the recorder.

Select  [General] in the Setup Display. To use the display, see "Using the Setup Displays" (page 62).

The default settings are underlined.

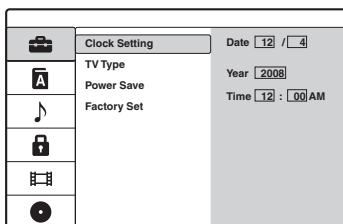

[Clock Setting]

1 Select [Clock Setting] and press →.

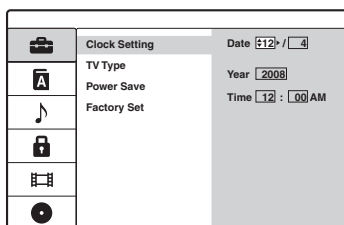

2 Press ↑/↓ to set the month, and press →. Set the day, year, hour, and minutes in sequence. Press ←/→ to select the item to be set, then press ↑/↓ to set the numbers.

To change the numbers, press ← to return to the item to be changed, and press ↑/↓.

3 Press ENTER to start the clock.

[TV Type]

Selects the aspect ratio of the connected TV (4:3 standard or wide).

[4:3 Letter Box] Select this when you connect a 4:3 screen TV. Displays a wide picture with bands on the upper and lower portions of the screen.

[4:3 Pan Scan] Select this when you connect a 4:3 screen TV. Automatically displays a wide picture on the entire screen and cuts off the portions that do not fit.

[16:9] Select this when you connect a wide-screen TV or a TV with a wide mode function.

[4:3 Letter Box]



[4:3 Pan Scan]



[16:9]



⚡ Notes

- Depending on the disc, [4:3 Letter Box] may be selected automatically instead of [4:3 Pan Scan] or vice versa.
- When connecting to the HDMI OUT jack with output resolution 720p, 1080i, or 1080p, the setting is fixed to [16:9].

[Power Save]

Selects whether to turn off the front panel display when the power is off.

[Off] The front panel display remains turned on.

[On] Turns off the front panel display.

[Factory Set]

Returns the recorder's settings to the factory defaults. See page 69 for procedures.

Note that Parental Control settings in the [Lock] setup remain unaffected.

Language Settings

The [Language] setup allows you to select a language for the recorder's display and discs.

Select A [Language] in the Setup Display. To use the display, see "Using the Setup Displays" (page 62).

The default settings are underlined.

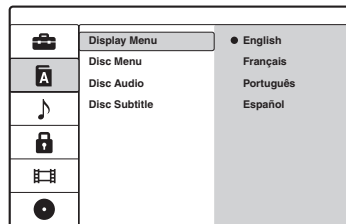

[Display Menu]

Switches the display language on the screen.

[Disc Menu] (DVD VIDEO only)

Switches the language for the DVD menu.

[Disc Audio] (DVD VIDEO only)

Switches the language of the sound track.

[Disc Subtitle] (DVD VIDEO only)

Switches the language of the subtitles recorded on the disc.

[Original] Selects the language given priority in the disc.

[Others] The display for entering a language code appears. Press the number buttons to enter a four-digit code number from "Language Code List" (page 78) and press ENTER.

[Off] Turns off the subtitles.

Note

If you select a language in [Disc Menu], [Disc Subtitle], or [Disc Audio] that is not recorded on the DVD VIDEO, one of the recorded languages will be automatically selected.

Audio Settings

The [Audio] setup allows you to adjust the sound according to the playback and connection conditions.

Select  [Audio] in the Setup Display. To use the display, see “Using the Setup Displays” (page 62). The default settings are underlined.

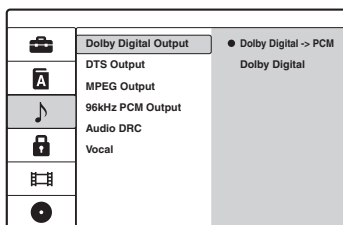

[Dolby Digital Output] (DVDs only)

Selects the type of Dolby Digital signal.

[Dolby Digital → PCM] Select this when the recorder is connected to an audio component without a built-in Dolby Digital decoder.

[Dolby Digital] Select this when the recorder is connected to an audio component with a built-in Dolby Digital decoder.

Note

This affects the output from the DIGITAL OUT (COAXIAL)/HDMI OUT jacks.

If the HDMI OUT jack is connected to equipment not compatible with Dolby Digital signals, select [Dolby Digital → PCM].

[DTS Output] (DVD VIDEO only)

Selects whether or not to output DTS signals.

[Off] Select this when the recorder is connected to an audio component without a built-in DTS decoder.

[On] Select this when the recorder is connected to an audio component with a built-in DTS decoder.

Note

This affects the output from the DIGITAL OUT (COAXIAL)/HDMI OUT jacks.

If the HDMI OUT jack is connected to equipment not compatible with DTS signals, select [Off].

[MPEG Output] (DVD VIDEO only)

Selects the type of MPEG audio signal.

[MPEG → PCM] Select this when the recorder is connected to an audio component without a built-in MPEG decoder. If you play MPEG audio sound tracks, the recorder outputs stereo signals.

[MPEG] Select this when the recorder is connected to an audio component with a built-in MPEG decoder.

Note

This affects the output from the DIGITAL OUT (COAXIAL)/HDMI OUT jacks.

If the HDMI OUT jack is connected to equipment not compatible with MPEG audio signals, select [MPEG → PCM].

[96kHz PCM Output] (DVD VIDEO only)

Selects the sampling frequency of the audio signal.

[96kHz → 48kHz] The audio signals of DVD VIDEOS are always converted to 48 kHz/16 bit.

[96kHz] All types of signals, including 96 kHz/24 bit, are output in their original format.

Note

This affects the output from the DIGITAL OUT (COAXIAL)/HDMI OUT jacks.

If the HDMI OUT jack is connected to equipment not compatible with 96 kHz signals, select [96kHz → 48kHz].

[Audio DRC] (Dynamic Range Control) (Dolby Digital DVDs only)

Makes the sound clear when the volume is turned down when playing a DVD that conforms to [Audio DRC]. This affects the output from the following jacks:

- AUDIO OUT (L/R) jacks
- LINE OUT (VIDEO/AUDIO L/R) jacks

–DIGITAL OUT (COAXIAL)/HDMI OUT jacks only when [Dolby Digital Output] is set to [Dolby Digital → PCM] (page 65).

[<u>Off</u>]	Normally select this.
[On]	Makes low sounds clear even if you turn the volume down.

[Vocal] (Karaoke DVD only)

Mixes karaoke channels into normal stereo. This function is effective for multi-channel karaoke DVDs only.

[<u>Off</u>]	Does not mix karaoke channels into normal stereo. You can turn off the guide vocal on a multi-channel DVD.
[On]	Normally select this.

Parental Control Settings (Lock)

Playback of some DVD VIDEOS can be limited according to a predetermined level, such as the age of the users. Scenes may be blocked or replaced with different scenes.

Select  [Lock] in the Setup Display. To use the display, see “Using the Setup Displays” (page 62).

[Parental Control]

Selects the rating level.

- 1 Select [Parental Control] and press .

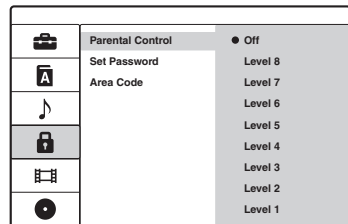

The display asks for the password.

- 2 Enter the four-digit password using the number buttons.
- 3 Select the level and press ENTER. The lower the level, the stricter the limitation. If you select [Off], the Parental Control function does not activate.

[Set Password]

Changes or deletes the password for the Parental Control function.

- 1 Select [Set Password] and press . If you have not entered a password, the display for entering a new password appears.

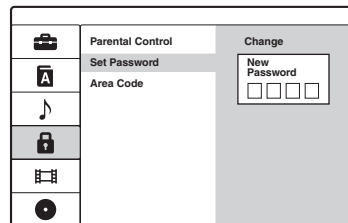

Enter a four-digit password using the number buttons. Enter the password again to confirm. The password is stored.

- If you make a mistake, press **←** repeatedly to delete numbers one by one, then re-enter it.
- 2 To change the password, press **ENTER** while [Change] is selected.
[Erase]: Erases the password. Enter the registered password.
 - 3 Enter the registered password.
 - 4 Enter a new four-digit password.
 - 5 Enter the password again to confirm.

Hint

If you forget your password, clear the password and register a new password.
Press **SYSTEM MENU** and select [Setup] to turn on the Setup Display. Enter the six-digit number 210499 using the number buttons. Select **[OK]** and press **ENTER**. The registered password is cleared.

[Area Code]

Selects a code for a geographic area as the playback rating level. See “Area Code List” (page 78).

- 1 Select [Area Code] and press **→**.
- 2 Enter the four-digit password using the number buttons.
- 3 Press **↑/↓** to enter the first character of the area and press **→**.
- 4 Press **↑/↓** to enter the second character and press **ENTER**.

Notes

- When you play discs which do not have the Parental Control function, playback cannot be limited on this recorder.
- Depending on the disc, you may be asked to change the Parental Control level while playing the disc. In this case, enter your password, then change the level.

Recording Settings (Video)

The [Video] setup allows you to adjust recording and set top box settings.

Select  [Video] in the Setup Display. To use the display, see “Using the Setup Displays” (page 62). The default settings are underlined.

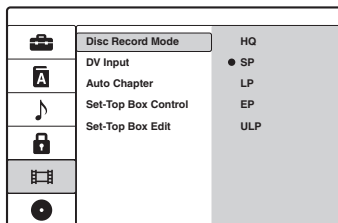

[Disc Record Mode]

Selects one of the following recording modes: HQ, SP, LP, EP and ULP (in the order of picture quality).

[DV Input]

Selects the stereo track when recording from a digital video camera connected to the DV IN jack on the front panel.

[<u>Stereo 1</u>]	Records original sound at the time of shooting. Normally select this when dubbing a DV/Digital8 format tape.
[<u>Stereo 2</u>]	Records only additional sound over-dubbed after shooting.

[Auto Chapter]

Automatically divides a recording (a title) into chapters by inserting chapter markings at a specified interval. The markings are inserted while the recording is being made.

[<u>No Separation</u>]	No chapter mark is inserted.
[<u>5 minutes</u>]	Sets the interval to 5 minutes.
[<u>10 minutes</u>]	Sets the interval to 10 minutes.

Note

Depending on the size of the recording being made, the actual interval may vary from the interval selected in [Auto Chapter]. When recording in ULP mode, the interval is set to 10-minutes. The selected interval should only be used as an approximation to create chapters.

[Set-Top Box Control]

Turns on the cable box/satellite receiver control function.

[<u>Off</u>]	Select this if you do not use the supplied set top box controller.
[<u>On</u>]	Select this when you use the supplied set top box controller. Select [Edit] and make necessary settings. For details, see "Setting up the cable box/satellite receiver control" (page 19).

[Set-Top Box Edit]

When [Set-Top Box Control] is set to [On], you can change the following settings. See page 19 for details.

[Device Type]: Selects the type of cable box/satellite receiver.

[Brand]: Selects the brand name of your cable box/satellite receiver.

[Number of Digits]: Selects the number of digits for your cable box/satellite receiver's channel.

[ENTER key]: Selects whether you need to press the ENTER button after entering the channel number.

[Key Speed]: Selects the key speed to send commands to the cable box/satellite receiver.

[Test]: Checks that the control works correctly.

Disc Settings

The [Disc] setup contains disc-related items such as disc protection and labeling.

Select  [Disc] in the Setup Display. To use the display, see "Using the Setup Displays" (page 62). The default settings are underlined.

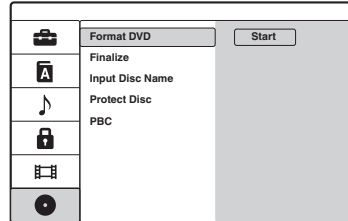

[Format DVD]

You can manually re-format a DVD+RW or DVD-RW disc to make a blank disc. See page 26 for details.

[Finalize]

"Finalizing" makes discs playable on other DVD equipment. See page 33 for details.

[Input Disc Name]

Name or rename the recorded discs to make them discernible on the display (page 31).

[Protect Disc]

Protects disc recording against erasure and alteration (page 33).

[PBC] (Playback Control)

Turns the PBC function on or off when playing VIDEO CDs.

[<u>Off</u>]	The PBC function is not activated. VIDEO CDs with PBC will be played the same way as audio CDs.
[<u>On</u>]	The PBC function is activated when playing VIDEO CDs with PBC.

Resetting the Recorder (Factory Set)

Select this to reset the recorder to all its default settings. Note that Parental Control settings in the [Lock] setup remain unaffected.

- 1 Press SYSTEM MENU to turn on the System Menu.**
- 2 Select [Setup] and press ENTER.**
- 3 Select  [General] and press →.**
- 4 Select [Factory Set] and press →.**

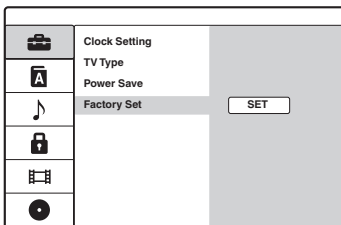

- 5 Press ENTER while [SET] is selected.**
The display asks for confirmation.
- 6 Select [OK] and press ENTER.**
Initial Setup starts (see page 18).

Additional Information

Troubleshooting

If you experience any of the following difficulties while using the recorder, use this troubleshooting guide to help remedy the problem before requesting repairs. Should any problem persist, consult your nearest Sony dealer.

Power

The power does not turn on.

- ➔ Check that the mains lead (the power cord) is connected securely.

Picture

There is no picture.

- ➔ Re-connect all connecting cords securely.
- ➔ The connecting cords are damaged.
- ➔ Check the connection to your TV (page 12).
- ➔ Switch the input selector on your TV (such as to "VCR") and "AV 1" so that the signal from the recorder appears on the TV screen.
- ➔ This recorder cannot record PAL signals.

Picture noise appears.

- ➔ If the picture output signal from your recorder passes through your VCR to get to your TV, or if you are connected to a combination TV/VIDEO player, the copy-protection signal applied to some DVD programs could affect picture quality.
- ➔ You have set the recorder to progressive format even though your TV cannot accept the progressive signals. In this case, remove the disc and close the disc tray. Then press the RESOLUTION button on the recorder to switch the signals.
- ➔ Even if your TV is compatible with progressive format (480p) signals, the image may be affected when you set the recorder to progressive format. In this case, remove the disc and close the disc tray. Then press the RESOLUTION button on the recorder to switch the signals.
- ➔ You are playing a disc recorded in a color system that is different from your TV.

The channel on the cable box/satellite receiver has been changed.

- ➔ The set top box controller is connected and [Set-Top Box Control] is set to [On]. Check the [Set-Top Box Control] settings in the [Video] setup (page 19).

The picture from equipment connected to the recorder's input jack does not appear on the screen.

- ➔ If the equipment is connected to the LINE 1 IN jack, select "L1" in the front panel display by pressing INPUT.
If the equipment is connected to the LINE 2 IN jacks, select "L2" in the front panel display by pressing INPUT.
If the equipment is connected to the DV IN jack, (this is usually for a digital video camera connection), select "dV" in the front panel display by pressing INPUT.

The playback picture or TV program from the equipment connected through the recorder is distorted.

- ➔ If the playback picture output from a DVD player, VCR, or tuner goes through your recorder before reaching your TV, the copy-protection signal applied to some programs could affect picture quality. Disconnect the playback equipment in question and connect it directly to your TV.

The picture does not fill the screen.

- ➔ Set [TV Type] in the [General] setup in accordance with the screen size of your TV (page 63).

The picture does not fill the screen, even though the aspect ratio is set in [TV Type] in the [General] setup.

- ➔ The screen size of the title is fixed.

Sound

There is no sound.

- ➔ Re-connect all connections securely.
- ➔ The connecting cord is damaged.
- ➔ The input source setting on the audio component or the connection to the audio component is incorrect.
- ➔ The recorder is in reverse play, fast forward, slow motion, or pause mode.
- ➔ If the audio signal does not come through the DIGITAL OUT (COAXIAL)/HDMI OUT jacks, check the [Audio] setup settings (page 65).

Sound is noisy.

- ➔ When playing a CD with DTS sound tracks, noise will come from LINE OUT (AUDIO L/R)/AUDIO OUT L/R jacks (page 46).

Recorded or played back audio is not stereo.

- ➔ The TV is not stereo-compatible.
- ➔ The input source is not in stereo format.
- ➔ The AV output jacks on the recorder are not connected to TV AV input jacks.

The sound volume is low.

- ➔ The sound volume is low on some DVDs. The sound volume may improve if you set [Audio DRC] in the [Audio] setup to [On] (page 65).

An alternate audio track cannot be played.

- ➔ If you have connected an AV amplifier to the DIGITAL OUT (COAXIAL) jack and want to change the audio track during playback, set [Dolby Digital Output] in the [Audio] setup to [Dolby Digital → PCM] (page 65).

Playback

The recorder does not play any type of disc.

- ➔ The disc is upside down. Insert the disc with the playback side facing down.
- ➔ The disc is not correctly inserted.
- ➔ Moisture has condensed inside the recorder. In this case, if the recorder is on, leave it on (if it is off, leave it off) for about an hour until the moisture evaporates.
- ➔ If the disc was recorded on another recorder and was not finalized (page 33), the recorder cannot play the disc.

- ➔ Cancel the rating function or change the rating level (page 66).

The recorder does not start playback from the beginning.

- ➔ Resume play was activated (page 43).
- ➔ You have inserted a disc whose Title menu or DVD menu automatically appears on the TV screen when it is first inserted. Use the menu to start playback.

The recorder starts playing automatically.

- ➔ The DVD VIDEO features an auto playback function.

Playback stops automatically.

- ➔ If the DVD has an auto pause signal, the recorder stops playback at the auto pause signal.

Some functions such as Stop, Search, or Slow-motion Play cannot be performed.

- ➔ Depending on the DVD, you may not be able to do some of the operations above. See the instructions supplied with the disc.

The language for the sound track cannot be changed.

- ➔ Multilingual tracks are not recorded on the DVD being played.
- ➔ The DVD VIDEO prohibits the changing of the language for the sound track.
- ➔ Try changing the language using the DVD VIDEO's menu.

The subtitle language cannot be changed or turned off.

- ➔ Multilingual subtitles are not recorded on the DVD VIDEO.
- ➔ The DVD VIDEO prohibits changing of the subtitles.
- ➔ Try changing the subtitle using the DVD VIDEO's menu.
- ➔ The subtitles cannot be changed for the titles recorded on this recorder.

The angles cannot be changed.

- ➔ Multi-angles are not recorded on the DVD VIDEO being played.
- ➔ You are trying to change the angles when “” does not appear on the TV screen (page 44).
- ➔ The DVD VIDEO prohibits changing angles.

- ➔ Try changing the angle using the DVD VIDEO's menu.
- ➔ The angles cannot be changed for the titles recorded on this recorder.

The MP3 audio tracks or JPEG image files do not play.

- ➔ The MP3 audio tracks or JPEG image files are not recorded in a format that the recorder can play (page 76).

Recording/Timer recording/ Editing

The channel cannot be changed from the channel you are recording.

- ➔ Set the TV's input source to "TV."

Recording does not start immediately after you press ● REC.

- ➔ Operate the recorder only after "REAd" disappears from the front panel display.

Nothing was recorded even though you set the timer setting correctly.

- ➔ There was a power failure during recording.
- ➔ The recorder's internal clock stopped due to a power failure. Reset the clock (page 63).
- ➔ Disconnect the mains lead (the power cord) from the AC outlet, and connect it again.
- ➔ The program contains copy protection signals that restrict copying.
- ➔ Another timer setting overlapped the timer setting (page 38).
- ➔ There is no DVD inside the recorder.
- ➔ There is not enough disc space for the recording.
- ➔ The disc is protected (DVD-RW (VR mode)) (page 33).
- ➔ The recorder was in the process of DV Dubbing (page 59).
- ➔ The connected cable box/satellite receiver was turned off.
- ➔ The set top box controller was incorrectly connected (page 11).
- ➔ The settings in [Set-Top Box Control] of the [Video] setup have been changed (page 19).

Recording does not stop immediately after you press ■ REC STOP.

- ➔ It will take a few seconds for the recorder to input disc data before recording can stop. On-screen instructions may appear after pressing ■ REC STOP. In the case, follow the on screen instructions.

Timer recording is not complete or did not start from the beginning.

- ➔ There was a power failure before or during recording. Reset the clock (page 63).
- ➔ Another timer setting overlapped the timer setting (page 38).
- ➔ Disc space was not sufficient.

Contents previously recorded were erased.

- ➔ Data that is not playable on this recorder but was recorded on a DVD with a PC will be erased from the disc when the disc is inserted.

Display

The clock has stopped.

- ➔ Set the clock again (page 63).
- ➔ The clock stopped due to a power failure. Reset the clock (page 63).

The "⌚" indicator is flashing.

- ➔ The disc does not have enough space.
- ➔ Insert a recordable disc into the recorder.

The recording mode indication is incorrect.

- ➔ When the recording or dubbing is less than three minutes, the recording mode indication may be displayed incorrectly. The actual recording itself is correctly made in the selected recording mode.

Remote control

The remote does not function.

- ➔ The batteries are weak.
- ➔ The remote is too far from the recorder.
- ➔ There is an obstacle in the path of the remote control and the recorder.
- ➔ The remote's manufacturer code returned to the default setting when you replaced the batteries. Reset the code (page 17).
- ➔ Turn on the recorder.

- ➔ The remote is not pointed at the remote sensor on the recorder.
- ➔ Different command modes are set for the recorder and remote. Set the same command mode (page 17). The default command mode setting for this recorder and the supplied remote is **“3 (Default setting).”** You can check the current command mode in the front panel display (page 17).

Other Sony equipment responds to the remote.

- ➔ The same command mode is set for both the equipment and recorder. Set a different command mode for the recorder (page 17).

Others

The recorder does not detect USB memory connected to the recorder.

- ➔ Make sure that the USB memory is securely connected to the recorder (page 24).
- ➔ Check that the USB memory is not damaged.













The recorder does not operate properly.

- ➔ Restart the recorder. Press down **I/⏻** on the recorder for more than five seconds until the recorder turns off. If a disc is still in the recorder, press **⏏** OPEN/CLOSE and remove the disc.
- ➔ When static electricity, etc., causes the recorder to operate abnormally, turn off the recorder and wait until the clock appears in the front panel display. Then, unplug the recorder and after leaving it off for a while, plug it in again.

The disc tray does not open after you press **⏏ OPEN/CLOSE.**

- ➔ It may take a few seconds for the disc tray to open after you have recorded or edited a DVD. This is because the recorder is adding disc data to the disc.

Recordable and Playable Discs

Type	Disc Logo	Icon used in this manual	Formatting (new discs)	Compatibility with other DVD players (finalising)	
DVD+RW	 DVD+ReWritable  DVD+ReWritable		Automatically formatted in +VR mode (DVD+RW VIDEO)	Playable on DVD+RW compatible players (finalization necessary) (page 33)	
DVD-RW	VR mode	  RW		Format in VR mode (page 26)	Playable only on VR mode compatible players (finalization necessary) (page 33)
	Video mode	 RW 		Format in Video mode (page 26)	Playable on most DVD players (finalization necessary) (page 33)
DVD+R	 DVD+R		Automatically formatted in +VR mode (DVD+R VIDEO)	Playable on most DVD players (finalization necessary) (page 33)	
DVD-R	 R		Automatically formatted in Video mode (page 26).	Playable on most DVD players (finalization necessary) (page 33)	

Usable disc versions (as of May 2008)

- 8x-speed or slower DVD+RWs
- 6x-speed or slower DVD-RWs (Ver.1.1, Ver.1.2 with CPRM*)
- 16x-speed or slower DVD+Rs
- 16x-speed or slower DVD-Rs (Ver.2.0, Ver.2.1 with CPRM*)

“DVD+RW,” “DVD-RW,” “DVD+R,” and “DVD-R” are trademarks.

* CPRM (Content Protection for Recordable Media) is a coding technology that protects copyrights for images.

Discs that cannot be recorded on

- DVD-RAMs
- DVD-R DL (Dual Layer)/+R DL (Double Layer) discs
- 8cm discs









Maximum recordable number of titles

Disc	Number of titles
DVD-RW/DVD-R	99
DVD+RW/DVD+R	49

Notes

- You cannot mix VR mode and Video mode on the same DVD-RW. To change the disc's format, reformat the disc (page 26). Note that the disc's contents will be erased after reformatting.
- You cannot shorten the time required for recording even with high-speed discs.
- It is recommended that you use discs with “For Video” printed on their packaging.
- You cannot add new recordings to DVD+Rs, DVD-Rs, or DVD-RWs (Video mode) that contain recordings made on other DVD equipment.
- In some cases, you may not be able to add new recordings to DVD+RWs that contain recordings made on other DVD equipment. If you do add a new recording, note that this recorder will rewrite the DVD menu.
- You cannot edit recordings on DVD+RWs, DVD-RWs (Video mode), DVD+Rs, or DVD-Rs that are made on other DVD equipment.
- If the disc contains PC data unrecognisable by this recorder, the data may be erased.
- You may not be able to record, edit, or dub on some recordable discs, depending on the disc.
- Do not insert any discs that cannot be recorded or played on this recorder. This may cause the recorder to malfunction.

Playable Discs

Type	Disc Logo	Icon used in this manual	Characteristics
DVD VIDEO			Discs such as movies that can be purchased or rented This recorder also recognises DVD-RAMs* as DVD Video compatible discs.
VIDEO CD			VIDEO CDs or CD-Rs/CD-RWs in VIDEO CD/Super VIDEO CD format
CD			Music CDs or CD-Rs/CD-RWs in music CD format
DATA DVD	—		DVD+RWs/DVD+Rs/DVD-RAMs* containing MP3 audio tracks DVD-RWs/DVD-Rs/DVD-ROMs containing MP3 audio tracks or JPEG image files
DATA CD	—		CD-ROMs/CD-Rs/CD-RWs containing either MP3 audio tracks or JPEG image files

*“DVD VIDEO” and “CD” are trademarks.

* If the DVD-RAM has a removable cartridge, remove the cartridge before playback.

Discs that cannot be played

- PHOTO CDs
- CD-ROMs/CD-Rs/CD-RWs that are recorded in a format different from the formats mentioned in the table above.
- Data part of CD-Extras
- BDs (Blu-ray Discs)
- HD DVDs
- Discs recorded with an AVCHD-compatible DVD video camera
- DVD-ROMs/DVD+RWs/DVD-RWs/DVD+Rs/DVD-Rs that do not contain DVD Video, JPEG image files, or MP3 audio tracks.
- DVD Audio discs
- Cartridge-only type DVD-RAMs
- HD layer on Super Audio CDs
- DVD VIDEOS with a different region code (page 77).
- DVDs that were recorded on a different recorder and not correctly finalised.

Note on playback operations of DVD VIDEOS/VIDEO CDs

Some playback operations of DVD VIDEOS/VIDEO CDs may be intentionally set by software producers. Since this recorder plays DVD VIDEOS/VIDEO CDs according to the disc contents the software producers designed, some playback features may not be available. Refer to the instructions supplied with the DVD VIDEOS/VIDEO CDs.

Region code (DVD VIDEO only)

Your recorder has a region code printed on the rear of the unit and will only play DVD VIDEOS (playback only) labeled with identical region codes. This system is used to protect copyrights. DVD VIDEOS labeled  will also play on this recorder.

If you try to play any other DVD VIDEO, the message "Playback prohibited by region code." will appear on the TV screen. Depending on the DVD VIDEO, no region code indication may be labeled even though playing the DVD VIDEO is prohibited by area restrictions.



Region code

Music discs encoded with copyright protection technologies

This product is designed to play back discs that conform to the Compact Disc (CD) standard. Various music discs encoded with copyright protection technologies are being marketed by some record companies. Please be aware that among those discs, there are some that do not conform to the CD standard and may not be playable by this product.

Note on DualDiscs

A DualDisc is a two sided disc product which mates DVD recorded material on one side with digital audio material on the other side. However, since the audio material side does not conform to the Compact Disc (CD) standard, playback on this product is not guaranteed.

Notes

- Some DVD+RWs/DVD+Rs, DVD-RWs/DVD-Rs, DVD-RAMs, or CD-RWs/CD-Rs cannot be played on this recorder due to the recording quality or physical condition of the disc, or the characteristics of the recording device and authoring software. The disc will not play if it has not been correctly finalised. For more information, refer to the operating instructions for the recording device.
- If the disc contains PC data unrecognisable by this recorder, the data may be erased.
- Do not insert any discs that cannot be recorded or played on this recorder. This may cause the recorder to malfunction.

About MPEG-2

ANY USE OF THIS PRODUCT OTHER THAN CONSUMER PERSONAL USE IN ANY MANNER THAT COMPLIES WITH THE MPEG-2 STANDARD FOR ENCODING VIDEO INFORMATION FOR PACKAGED MEDIA IS EXPRESSLY PROHIBITED WITHOUT A LICENSE UNDER APPLICABLE PATENTS IN THE MPEG-2 PATENT PORTFOLIO, WHICH LICENSE IS AVAILABLE FROM MPEG LA, L.L.C., 250 STEELE STREET, SUITE 300, DENVER, COLORADO 80206.

Language Code List

For details, see page 64.

The language spellings conform to the ISO 639: 1988 (E/F) standard.

Language	Code	Language	Code	Language	Code	Language	Code
Abkhazian	6566	Galician	7176	Marathi	7782	Telugu	8469
Afar	6565	Georgian	7565	Moldavian	7779	Thai	8472
Afrikaans	6570	German	6869	Mongolian	7778	Tonga	8479
Albanian	8381	Greek	6976	Nauru	7865	Turkish	8482
Amharic	6577	Greenlandic	7576	Nepali	7869	Turkmen	8475
Arabic	6582	Guarani	7178	Norwegian	7879	Twi	8487
Armenian	7289	Gujarati	7185	Oriya	7982	Ukrainian	8575
Assamese	6583	Hausa	7265	Punjabi	8065	Urdu	8582
Aymara	6588	Hebrew	7387	Pashto; Pushto	8083	Uzbek	8590
Azerbaijani	6590	Hindi	7273	Persian	7065	Vietnamese	8673
Bashkir	6665	Hungarian	7285	Polish	8076	Volapük	8679
Basque	6985	Icelandic	7383	Portuguese	8084	Welsh	6789
Bengali; Bangla	6678	Indonesian	7378	Quechua	8185	Wolof	8779
Bhutani	6890	Interlingua	7365	Rhaeto-Romance	8277	Xhosa	8872
Bihari	6672	Irish	7165	Romanian	8279	Yiddish	7473
Breton	6682	Italian	7384	Russian	8285	Yoruba	8979
Bulgarian	6671	Javanese	7487	Samoan	8377	Zulu	9085
Burmese	7789	Kannada	7578	Sanskrit	8365		
Byelorussian	6669	Kashmiri	7583	Scots Gaelic	7168		
Chinese	9072	Kazakh	7575	Serbian	8382		
Croatian	7282	Kirghiz	7589	Serbo-Croatian	8372		
Czech	6783	Korean	7579	Shona	8378		
Danish	6865	Kurdish	7585	Sindhi	8368		
Dutch	7876	Laothian	7679	Singhalese	8373		
English	6978	Latin	7665	Slovak	8375		
Esperanto	6979	Latvian; Lettish	7686	Slovenian	8376		
Estonian	6984	Lingala	7678	Spanish	6983		
Faroese	7079	Lithuanian	7684	Sundanese	8385		
Fiji	7074	Macedonian	7775	Swahili	8387		
Finnish	7073	Malagasy	7771	Swedish	8386		
French	7082	Malay	7783	Tagalog	8476		
Frisian	7089	Malayalam	7776	Tajik	8471		
		Maori	7773	Tamil	8465		

Area Code List

For details, see page 67.

Code Area	Code Area	Code Area	Code Area
AF	Afghanistan	ES	Spain
AN	Netherlands	ET	Ethiopia
	Antilles	FI	Finland
AR	Argentina	FJ	Fiji
AT	Austria	FR	France
AU	Australia	GB	Great Britain
BE	Belgium	GL	Greenland
BO	Bolivia	GR	Greece
BR	Brazil	HK	Hong Kong
BT	Bhutan	HR	Croatia
BY	Belarus	HU	Hungary
CA	Canada	ID	Indonesia
CG	Congo	IE	Ireland
CH	Switzerland	IL	Israel
CL	Chile	IN	India
CN	China	IT	Italy
CO	Colombia	JM	Jamaica
CR	Costa Rica	JP	Japan
CY	Cyprus	KE	Kenya
CZ	Czech Republic	KH	Cambodia
DE	Germany	KR	South Korea
DK	Denmark	KW	Kuwait
EC	Ecuador	LK	Sri Lanka
EG	Egypt	LU	Luxembourg
		LY	Libya
		MA	Morocco
		MC	Monaco
		MN	Mongolia
		MV	Maldives
		MX	Mexico
		MY	Malaysia
		NG	Nigeria
		NL	Netherlands
		NO	Norway
		NP	Nepal
		NZ	New Zealand
		OM	Oman
		PA	Panama
		PE	Peru
		PH	Philippines
		PK	Pakistan
		PL	Poland
		PT	Portugal
		PY	Paraguay
		RO	Romania
		RU	Russian Federation
		SA	Saudi Arabia
		SE	Sweden
		SG	Singapore
		SI	Slovenia
		SK	Slovak Republic
		SN	Senegal
		SV	El Salvador
		TH	Thailand
		TR	Turkey
		TW	Taiwan
		UA	Ukraine
		UG	Uganda
		US	United States
		UY	Uruguay
		UZ	Uzbekistan
		VN	Vietnam
		ZA	South Africa
		ZW	Zimbabwe

Notes About This Recorder

On operation

- If the recorder is brought directly from a cold to a warm location, or is placed in a very damp room, moisture may condense on the lenses inside the recorder. Should this occur, the recorder may not operate properly. In this case, if the recorder is on, leave it on (if it is off, leave it off) for about an hour until the moisture evaporates.
- When you move the recorder, take out any discs to avoid damaging the disc.

On adjusting volume

Do not turn up the volume while listening to a section with very low level inputs or no audio signals. If you do, the speakers may be damaged when a peak level section is played.

On cleaning

Clean the cabinet, panel, and controls with a soft cloth slightly moistened with a mild detergent solution. Do not use any type of abrasive pad, scouring powder or solvent such as alcohol or benzine.

On cleaning discs, disc/lens cleaners

Do not use cleaning discs or disc/lens cleaners (including wet or spray types). These may cause the recorder to malfunction.

Notes about the discs

- To keep the disc clean, handle the disc by its edge. Do not touch the surface. Dust, fingerprints, or scratches on the disc may cause it to malfunction.



- Do not expose the disc to direct sunlight or heat sources such as hot air ducts, or leave it in a car parked in direct sunlight as the temperature may rise considerably inside the car.
- After playing, store the disc in its case.
- Clean the disc with a cleaning cloth. Wipe the disc from the centre out.



- Do not use solvents such as benzine, thinner, commercially available cleaners, or anti-static spray intended for vinyl LPs.
- Do not use the following discs.
 - A disc that has a non-standard shape (e.g., card, heart).
 - A disc with a label or sticker on it.
 - A disc that has cellophane tape or sticker adhesive on it.

On replacement of parts

In the event that this unit is repaired, repaired parts may be collected for reuse or recycling purposes.

Notes on MP3 Audio Tracks, JPEG Image Files, and i.Link

About MP3 audio tracks and JPEG image files

MP3 is an audio compression technology that satisfies certain ISO/MPEG regulations. JPEG is an image compression technology.

You can play MP3 (MPEG1 Audio Layer 3) format audio tracks on DATA CDs (CD-ROMs/CD-Rs/CD-RWs) or DATA DVDs (DVD-ROMs/DVD-RWs/DVD-Rs/DVD+RWs/DVD+Rs/DVD-RAMs) or play JPEG image files on DATA CDs (CD-ROMs/CD-Rs/CD-RWs) or DATA DVDs (DVD-ROMs/DVD-RWs/DVD-Rs). DATA DVDs must be recorded according to ISO9660 Level 1 or Level 2 format for the recorder to recognise the MP3 tracks and JPEG image files.

DATA CDs must be recorded according to ISO9660 Level 1, Level 2, or Joliet format for the recorder to recognise the MP3 tracks and JPEG image files.

You can also play discs recorded in MultiSession/Border.

Refer to the instructions supplied with the disc drives and the recording software (not supplied) for details on the recording format.

Note on MultiSession/Border discs

If audio tracks and images in Music CD format or Video CD format are recorded in the first session/border, only the first session/border will be played back.

MP3 audio tracks or JPEG image files that the recorder can play

The recorder can play the following tracks and files:

- MP3 audio tracks with the extension “.mp3.”
- JPEG image files with the extension “.jpeg” or “.jpg.”

Hint

Since a disc with many trees takes longer to start playback, it is recommended that you create albums with no more than two trees.

Notes

- The recorder will play any data with the extension “.mp3,” “.jpeg,” or “.jpg,” even if they are not in MP3 or JPEG. Playing these data may generate a loud noise which could damage your speaker system.
- Depending on the disc, normal playback may not be possible. For example, the picture may be unclear, playback may not appear smooth, the sound may skip, and so on.
- Depending on the disc, playback may take some time to start.
- Some files cannot be played.
- For MP3 audio tracks, the recorder can play up to a total number of 650 albums and files.
- For JPEG image files, the recorder can load up to a total number of 650 albums and files a DATA CD/DATA DVD or the connected USB device at a time. To view unloaded albums, reload them.
- Proceeding to the next or another album may take some time.
- The image size that can be displayed is limited. The following image sizes can be displayed: width 6000 pixels by height 4499 pixels (less than 4 MB).
- This recorder supports MP3 audio tracks recorded with a sampling frequency of 32 kHz, 44.1 kHz, and 48 kHz.
- No more than a 1 GB MP3 audio track can be played.
- The recorder does not conform to audio tracks in mp3PRO format.

About i.LINK

The DV IN jack on this recorder is i.LINK-compliant for digital video cameras. i.LINK is a more familiar term for IEEE 1394 data transport bus proposed by SONY, and is a trademark approved by many corporations. IEEE 1394 is an international standard standardized by the Institute of Electrical and Electronics Engineers.

For details on how to dub when this recorder is connected to other video equipment having DV jacks, see page 59.

The DV jack on this recorder can only input DVC-SD signals. It cannot output signals. The DV jack will not accept MICRO MV signals from equipment such as a MICRO MV digital video camera with an i.LINK jack.

For further precautions, see the notes on page 59. For details on precautions when connecting this recorder, also refer to the instruction manuals for the equipment to be connected.

Note

Normally, only one piece of equipment can be connected to this recorder by the i.LINK cable (DV connecting cable). When connecting this recorder to i.LINK-compatible equipment having two or more i.LINK jacks (DV jacks), refer to the instruction manual of the equipment to be connected.

i.LINK and  are trademarks.

Specifications

System

Laser: Semiconductor laser

Timer: Clock: Quartz locked/Timer indication: 12-hour cycle (digital)

Video recording format: MPEG-2

Audio recording format/applicable bit

rate: Dolby Digital 2 ch

256 kbps (in HQ and SP mode), 192 kbps

(in LP and EP mode), 96 kbps (in ULP mode)

Inputs and outputs

LINE 1 IN

(VIDEO): Phono jack /1.0 Vp-p

(AUDIO): Phono jack/2 Vrms/47 kilohms

LINE 2 IN

(VIDEO): Phono jack/1.0 Vp-p

(AUDIO): Phono jack/2 Vrms/more than 47 kilohms

LINE OUT

(VIDEO): Phono jack /1.0 Vp-p

(AUDIO): Phono jack/2 Vrms/600 ohms

AUDIO OUT: Phono jack/2 Vrms/600 ohms

DV IN: 4-pin/i.LINK S100

DIGITAL OUT (COAXIAL): Phono jack/0.5 Vp-p/75 ohms

COMPONENT VIDEO OUT (Y, P_B, P_R):

Phono jack/Y: 1.0 Vp-p,

P_B: 0.7 Vp-p, P_R: 0.7 Vp-p

SET TOP BOX CONTROL: Mini jack

HDMI OUT: HDMI™ Connector

USB: USB jack Type A

General

Power requirements: 120 V AC, 60 Hz

Power consumption: 20 W

Dimensions (approx.):

430 × 53 × 258 mm (17 × 2 1/8 × 10 1/8 inch)

(width/height/depth) incl. projecting parts

Mass (approx.): 2.6 kg (5.73 lb)

Operating temperature: 5°C to 35°C (41°F to 95°F)

Operating humidity: 25% to 80%

Supplied accessories:

Power cord (1)

Video cord (1)

Audio cord (1)

Remote commander (remote) (1)

Size AA (R6) batteries (2)

Set top box controller (1)

Specifications and design are subject to change
without notice.

Index

Words in brackets appear in the on-screen displays.

Numerics

- [16:9] 63
- [4:3 Letter Box] 63
- [4:3 Pan Scan] 63
- [96kHz PCM Output] 65

A

- [A-B Erase] 53
- A-B Repeat 46
- Album 48
- Angle 45
- Area Code 67, 78
- Audio 45, 65
- Audio cord 14
- [Audio DRC] 65
- Audio input 14
- [Auto Chapter] 40, 67

B

- Batteries 16
- Bookmark 47

C

- Cable box 10
- CD 76
- Chapter 40, 56
- Chapter List 29, 42, 55, 58
- [Clock Setting] 63
- [Combine] 56
- Command Mode 17
- COMPONENT VIDEO OUT 13
- Connecting
 - the audio cords 14
 - the HDMI cord 14
 - the USB device 24
 - the video cords 12
- Controlling TVs with the remote 16
- Copy control signals 35
- Copy-Free 35
- Copy-Never 35

- Copy-Once 35
- CPRM 35, 75
- Creating chapters 56

D

- DATA CD 76
- DATA DVD 76
- DIGITAL OUT (COAXIAL) 14
- Digital video camera 59
- [Disc Record Mode] 67
- Disc space 51
- Disc types 74, 76
- DISPLAY 30
- Display
 - Setup Display 62
- [Divide] 54
- Dolby Digital 14, 65
- DTS 14, 65
- DV Dubbing 59
- DV IN 59
- [DV Input] 61, 67
- DVD VIDEO 76
- DVD+R 74
- DVD+RW 74
- DVD-R 74
- DVD-RAM 76
- DVD-RW 51, 74

E

- [Edit] 32, 53
- Editing 51
- Enter characters 31
- [Erase] 53, 56

F

- [Factory Set] 69
- File 50
- [Finalize] 34, 68
- Folder 50
- [Format DVD] 26, 68
- Front panel 8
- [Full Play] 42, 56

H

- Handling discs 79
- HDMI cord 12
- HDMI OUT 13, 14
- [Hide] 55, 56

I

- i.LINK 81
- Initial Setup 18
- INPUT 41, 60
- [Input Disc Name] 32, 68

J

- JPEG image files 50

L

- LINE 1 IN 11
- LINE 2 IN 21
- LINE OUT 12, 14

M

- MENU 42
- Menu
 - DVD's Menu 42
 - Top menu 42
- [Move] 58
- MP3 audio tracks 48
- MPEG 14, 65

N

- Number buttons 32

O

- On-screen display
 - Setup Display 62
 - Sub-menu 28
- Original 28, 51
- OSD language 64

P

Parental Control 43, 66
Parts and controls 6
PBC (Playback Control) 43
PCM 65
Playable discs 74, 76
Playback 42, 44, 48, 74, 76
 A-B Repeat 46
 fast forward 44, 49
 fast reverse 44, 49
 Repeat Play 46, 49
 Resume Play 43
 Slow-motion play 45
Playlist 28, 51, 57
Power cord 15
[Protect] 54
[Protect Disc] 33, 68

Q

Quick Timer 39

R

Rear panel 9
REC 27, 39
REC MODE 35
Rec Mode Adjust 37
Recordable discs 74
Recording 27, 35, 39, 41, 67
 overwriting a recorded
 title 40
 recording format 74
 recording mode 35, 67
 recording time 35
 while watching another
 program 39
Region code 77
Remote 6, 16
Repeat Play 46, 49
Resetting the recorder 69
Resume Play 43

S

[Search] 29
Searching
 fast forward 44, 49
 fast reverse 44, 49
 locating the beginning of
 the title/chapter/
 track 44
[Set Password] 66
Set top box controller 11, 20
[Set-Top Box Control] 19, 68
Setup Display 62
[Show] 55, 56
Slide show 50
[Stereo 1] 67
[Stereo 2] 67
Sub-menu 28
Subtitle 45, 64
Super VIDEO CD 76
Surround 30
System Menu 25

T

Timer List 37
Timer recording
 check/change/cancel 37
 Rec Mode Adjust 37
 Timer List 37
Title 28, 42
Title List 28, 42, 52
[Title Name] 31, 53
Track 48
Troubleshooting 70
TV INPUT 16
[TV Type] 63

U

[Unfinalize] 34
Usable discs 74, 76

V

VIDEO CD 43, 76
Video mode 74
[Vocal] 66
VR mode 74

Z

ZOOM 45

Free Manuals Download Website

<http://myh66.com>

<http://usermanuals.us>

<http://www.somanuals.com>

<http://www.4manuals.cc>

<http://www.manual-lib.com>

<http://www.404manual.com>

<http://www.luxmanual.com>

<http://aubethermostatmanual.com>

Golf course search by state

<http://golfingnear.com>

Email search by domain

<http://emailbydomain.com>

Auto manuals search

<http://auto.somanuals.com>

TV manuals search

<http://tv.somanuals.com>