

DVD Player/ Video Cassette Recorder

Operating Instructions _____ **US**

Manual de instrucciones _____ **ES**

For customers in the USA

If you have any questions about your Sony DVD-VCR, you may call **Sony Customer Information Center** at 1-800-VHS-SONY (847-7669).

For all other Sony product questions, please call **Sony Customer Information Center** at 1-800-222-SONY (7669).

Or write to: **Sony Customer Information Center** 12451 Gateway Boulevard Ft. Myers, FL 33913



Hi-Fi



SLV-D380P

WARNING

To reduce the risk of fire or electric shock, do not expose this apparatus to rain or moisture.

To avoid electrical shock, do not open the cabinet. Refer servicing to qualified personnel only.

CAUTION

The use of optical instruments with this product will increase eye hazard. As the laser beam used in this DVD player is harmful to eyes, do not attempt to disassemble the cabinet.

Refer servicing to qualified personnel only.

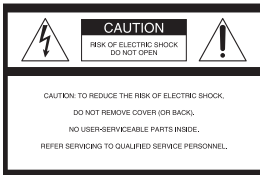

This symbol is intended to alert the user to the presence of uninsulated "dangerous voltage" within the product's enclosure that may be of sufficient magnitude to constitute a risk of electric shock to persons.



This symbol is intended to alert the user to the presence of important operating and maintenance (servicing) instructions in the literature accompanying the appliance.

For customers in the U.S.A Owner's Record

The model and serial numbers are located at the rear of the unit. Record the serial number in the space provided below. Refer to them whenever you call upon your Sony dealer regarding this product.

Model No. _____
Serial No. _____

CAUTION

You are cautioned that any changes or modifications not expressly approved in this manual could void your authority to operate this equipment.

Note

This equipment has been tested and found to comply with the limits for a Class B digital device, pursuant to Part 15 of the FCC Rules. These limits are designed to provide reasonable protection against harmful interference in a residential installation. This equipment generates, uses, and can radiate radio frequency energy and, if not installed and used in accordance with the instructions, may cause harmful interference to radio communications. However, there is no guarantee that interference will not occur in a particular installation. If this equipment does cause harmful interference to radio or television reception, which can be determined by turning the equipment off and on, the user is encouraged to try to correct the interference by one or more of the following measures:

- Reorient or relocate the receiving antenna.
- Increase the separation between the equipment and receiver.
- Connect the equipment into an outlet on a circuit different from that to which the receiver is connected.
- Consult the dealer or an experienced radio/TV technician for help.

Notes about discs

- To keep the disc clean, handle the disc by its edge. Do not touch the surface.



- Do not expose the disc to direct sunlight or heat sources such as hot air ducts, or leave it in a car parked in direct sunlight as the temperature may rise considerably inside the car.
- After playing, store the disc in its case.
- Clean the disc with a cleaning cloth. Wipe the disc from the center out.



- Do not use solvents such as benzene, thinner, commercially available disc/lens cleaners, or anti-static spray intended for vinyl LPs.
- If you have printed the disc's label, dry the label before playing.

Precautions

On safety

- To prevent fire or shock hazard, do not place objects filled with liquids, such as vases, on the apparatus.
- Should any solid object or liquid fall into the cabinet, unplug the player and have it checked by qualified personnel before operating it any further.

On power sources

- Operate the unit only on 120 V AC, 60 Hz.
- This unit is not disconnected from the AC power source (mains) as long as it is connected to the wall outlet, even if the unit itself has been turned off.
- Install this system so that the power cord can be unplugged from the wall socket immediately in the event of trouble.
- Unplug the unit from the wall outlet if you do not intend to use it for an extended period of time. To disconnect the cord, pull it out by the plug, never by the cord.

On placement

- Do not install the unit in a confined space such as a bookshelf or similar unit.
- Do not install the unit in an inclined position. It is designed to be operated in a horizontal position only.
- Keep the unit, discs and cassettes away from equipment with strong magnets, such as microwave ovens or large loudspeakers.
- Do not place heavy objects on the unit.

On operation

- When you move the player, take out any discs. If you don't, the disc may be damaged.
- If the unit is brought directly from a cold to a warm location, or is placed in a very damp room, moisture may condense on the lenses inside the player and cause damage to the video head, tape, and the optical block. Should this occur, the player may not operate properly. When you first install the player, or when you move it from a cold to a warm location, remove the disc and tape and leave the player turned on for about three hours before operating the player.

On adjusting volume

Do not turn up the volume while listening to a section with very low level inputs or no audio signals. If you do, the speakers may be damaged when a peak level section is played.

On cleaning

Clean the cabinet, panel and controls with a soft cloth slightly moistened with a mild detergent solution. Do not use any type of abrasive pad, scouring powder or solvent, such as alcohol or benzene.

On cleaning discs, disc/lens cleaners

Do not use cleaning discs or disc/lens cleaners (including wet or spray types). These may cause the player to malfunction.

On cleaning the video heads

- **Rough picture**
- **Unclear picture**
- **No picture (or black & white screen appears)**



initial
contamination

terminal

When the video heads are dirty, clean the video heads using a Sony video head cleaning cassette. If a Sony cleaning cassette is not available in your area, have the heads cleaned at your nearest Sony dealer (a standard service fee will be charged). Do not use a commercially available liquid type cleaning cassette, as it may damage the video heads.

On replacement of parts

In the event that this unit is repaired, repaired parts may be collected for reuse or recycling purposes.

US

continued

Copyright

- Television programs, films, video tapes and other materials may be copyrighted. Unauthorized recording of such material may be contrary to the provisions of the copyright laws. Also, use of this recorder with cable television transmission may require authorization from the cable television transmission and/or program owner.
- This product incorporates copyright protection technology that is protected by U.S. patents and other intellectual property rights. Use of this copyright protection technology must be authorized by Macrovision, and is intended for home and other limited viewing uses only unless otherwise authorized by Macrovision. Reverse engineering or disassembly is prohibited.

IMPORTANT NOTICE

Caution: This player is capable of holding a still video image or on-screen display image on your television screen indefinitely. If you leave the still video image or on-screen display image displayed on your TV for an extended period of time you risk permanent damage to your television screen. Projection televisions are especially susceptible to this.

Important Safety Instructions

- 1 Read these instructions.
- 2 Keep these instructions.
- 3 Heed all warnings.
- 4 Follow all instructions.
- 5 Do not use this apparatus near water.
- 6 Clean only with dry cloth.
- 7 Do not block any ventilation openings. Install in accordance with the manufacturer's instructions.
- 8 Do not install near any heat sources such as radiators, heat registers, stoves, or other apparatus (including amplifiers) that produce heat.
- 9 Do not defeat the safety purpose of the polarized or grounding-type plug. A polarized plug has two blades with one wider than the other. A grounding type plug has two blades and a third grounding prong. The wide blade or the third prong are provided for your safety. If the provided plug does not fit into your outlet, consult an electrician for replacement of the obsolete outlet.
- 10 Protect the power cord from being walked on or pinched particularly at plugs, convenience receptacles, and the point where they exit from the apparatus.
- 11 Only use attachments/accessories specified by the manufacturer.
- 12 Use only with the cart, stand, tripod, bracket, or table specified by the manufacturer, or sold with the apparatus. When a cart is used, use caution when moving the cart/apparatus combination to avoid injury from tip-over.
- 13 Unplug this apparatus during lightning storms or when unused for long periods of time.
- 14 Refer all servicing to qualified service personnel. Servicing is required when the apparatus has been damaged in any way, such as power-supply cord or plug is damaged, liquid has been spilled or objects have fallen into the apparatus, the apparatus has been exposed to rain or moisture, does not operate normally, or has been dropped.



Table of contents

- 2 WARNING
- 2 Notes about discs
- 3 Precautions
- 7 About this manual
- 7 This player can play the following discs

Getting Started

- 10 Step 1 : Unpacking
- 11 Step 2 : Setting up the remote commander
- 14 Step 3 : Basic hookups
- 18 Step 4 : Selecting a language
- 19 Step 5 : Setting the clock

Advanced Hookups for the DVD Player

- 21 Component Video hookup
- 22 A/V Receiver hookup

Basic Operations

- 24 Playing discs
- 28 Guide to the on-screen display
- 31 Playing a tape
- 35 Recording from a connected equipment
- 38 Recording from a connected equipment using the timer
- 41 Checking/changing/canceling timer settings
- 43 Locking the DVD-VCR (Child Lock)

DVD Settings and Adjustments

- 44 Audio Setup
- 46 Screen Setup
- 50 Setting the display or sound track language
- 52 Parental Control (limiting playback by children)

continued

DVD Additional Operations

- 55** Using the DVD's menu
- 56** Zooming into a scene
- 57** Changing the angles
- 59** Displaying the subtitle
- 61** Various play mode functions (Program play, Shuffle play, Repeat play)
- 65** Changing the sound
- 67** Virtual surround setting
- 69** Playing an MP3 audio track
- 75** Playing JPEG image files
- 79** Playing VIDEO CDs with "PBC ON/OFF" Functions

VCR Additional Operations







- 81** Quick Timer Recording
- 82** Searching using various functions
- 84** Editing with another VCR

Additional Information

- 86** Changing menu options
- 88** Troubleshooting
- 93** Glossary
- 95** Specifications
- 96** Index to parts and controls
- 100** DVD Audio/Subtitle Language
- 101** Index











About this manual

- This manual mainly explains operations using the remote, but the same operations can also be performed using the buttons on the DVD-VCR having the same or similar names.
- “DVD” may be used as a general term for DVD VIDEOS, DVD-RWs/DVD-Rs, and DVD+RWs/DVD+Rs.
- The meaning of the icons used in this manual is described below:

Icon	Meaning
	Functions available for DVD VIDEOS and DVD-RWs/DVD-Rs in video mode or DVD+RWs/DVD+Rs
	Functions available for DVD-RWs/DVD-Rs in VR (Video Recording) mode
	Functions available for VIDEO CDs, Super VCDs or CD-Rs/CD-RWs in video CD format or Super VCD format
	Functions available for music CDs or CD-Rs/CD-RWs in music CD format
	Functions available for DATA CDs (CD-ROMs/CD-Rs/CD-RWs containing MP3* audio tracks or JPEG files)
	Functions available for DATA DVDs (DVD-ROMs/DVD+RWs/DVD+Rs/DVD-RWs/DVD-Rs containing MP3* audio tracks or JPEG files)
	Functions available for VHS VIDEOS

* MP3 (MPEG 1 Audio Layer III) is a standard format defined by ISO/MPEG which compresses audio data.

This player can play the following discs

Format of discs	
DVD VIDEO	
DVD-RW/-R	 
DVD+RW/+R	  
VIDEO CD/ Music CD	 
CD-RW/-R	 

“DVD+RW,” “DVD-RW,” “DVD+R,” “DVD+R DL,” “DVD-R,” “DVD VIDEO,” and “CD” logos are trademarks.

Note about CDs/DVDs

The player can play CD-ROMs/CD-Rs/CD-RWs recorded in the following formats:

- music CD format
- video CD format
- MP3 audio tracks and JPEG image files of format conforming to ISO 9660* Level 1/ Level 2, or its extended format, Joliet
- KODAK Picture CD format

* A logical format of files and folders on CD-ROMs, defined by ISO (International Organization for Standardization).

The player can play DVD-ROMs/DVD+RWs/DVD+Rs/DVD-RWs/DVD-Rs recorded in the following formats:

- MP3 audio tracks and JPEG image files of format conforming to ISO 9660 Level 1/ Level 2, or its extended format, Joliet.
- 8 cm DVD+RW, DVD-RW, and DVD-R recorded with a DVD Video camera

continued

Region code

Your player has a region code printed on the back of the unit and only will play DVD VIDEO discs (playback only) labeled with identical region codes. This system is used to protect copyrights.

DVDs labeled  will also play on this player.

If you try to play any other DVD VIDEO, a message will appear on the TV screen to indicate that the disc is not playable. Depending on the DVD VIDEO, no region code indication may be labeled even though playing the DVD VIDEO is prohibited by area restrictions.

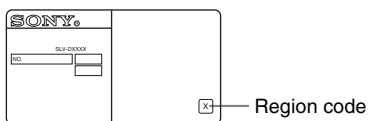

Example of discs that the player cannot play

The player cannot play the following discs:

- CD-ROMs/CD-Rs/CD-RWs other than those recorded in the formats listed on the previous page.
- CD-ROMs recorded in PHOTO CD format.
- Data part of CD-Extras
- DVD Audios
- HD layer on Super Audio CDs
- DVD-RAMs

Also, the player cannot play the following discs:

- A DVD VIDEO with a different region code.
- A disc recorded in a color system other than NTSC, such as PAL or SECAM (this player conforms to the NTSC color system).
- A disc that has a non-standard shape (e.g., card, heart).
- A disc with paper or stickers on it.
- A disc that has the adhesive of cellophane tape or a sticker still left on it.

Notes about DVD+RWs/ DVD+Rs, DVD-RWs/DVD-Rs or CD-Rs/CD-RWs

Some DVD+RWs/DVD+Rs, DVD-RWs/DVD-Rs or CD-Rs/CD-RWs cannot be played on this player due to the recording quality or physical condition of the disc, or the characteristics of the recording device and authoring software.

The disc will not play if it has not been correctly finalized. For more information, refer to the operating instructions for the recording device. Note that some playback functions may not work with some DVD+RWs/DVD+Rs, even if they have been correctly finalized. In this case, view the disc by normal playback. Also some DATA CDs/DATA DVDs created in Packet Write format cannot be played.

Note on playback operations of DVDs and VIDEO CDs

Some playback operations of DVDs and VIDEO CDs may be intentionally set by software producers. Since this player plays DVDs and VIDEO CDs according to the disc contents the software producers designed, some playback features may not be available. Also, refer to the instructions supplied with the DVDs or VIDEO CDs.

Music discs encoded with copyright protection technologies

This product is designed to playback discs that conform to the Compact Disc (CD) standard. Recently, various music discs encoded with copyright protection technologies are marketed by some record companies. Please be aware that among those discs, there are some that do not conform to the CD standard and may not be playable by this product.

Note on DualDiscs

A DualDisc is a two sided disc product which mates DVD recorded material on one side with digital audio material on the other side.

However, since the audio material side does not conform to the Compact Disc (CD) standard, playback on this product is not guaranteed.

Step 1 : Unpacking

Check that you have received the following items with the DVD-VCR:

- Remote commander
- Audio/video cord

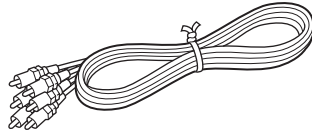
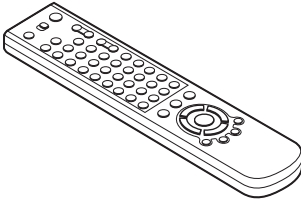

- Size AA (R6) batteries

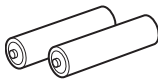

Note

- The supplied remote commander is for the exclusive use of this DVD-VCR.

Step 2 : Setting up the remote commander

Inserting the batteries

Insert two size AA (R6) batteries by matching the + and – on the batteries to the diagram inside the battery compartment.

Insert the negative (–) end first, then push in and down until the positive (+) end clicks into position.

Reattach the cover after inserting the batteries.

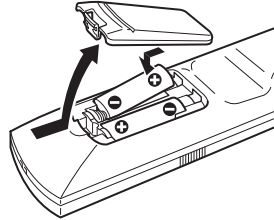

Using the remote commander

You can use this remote commander to operate this DVD-VCR and a Sony TV. Buttons on the remote commander marked with an orange dot (•) can be used to operate your Sony TV.

If the TV does not have the  symbol near the remote sensor, this remote commander will not operate the TV.

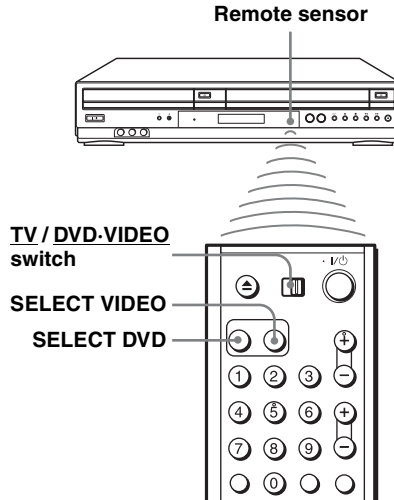

To operate	Set <u>TV / DVD-VIDEO</u> switch to
the DVD player	<u>DVD-VIDEO</u> , then press SELECT DVD and point at the remote sensor at the DVD-VCR.
the VCR	<u>DVD-VIDEO</u> , then press SELECT VIDEO and point at the remote sensor at the DVD-VCR.
your TV	<u>TV</u> and point at the remote sensor at your TV.

continued

Notes

- With normal use, the batteries should last about three to six months.
- If you do not use the remote commander for an extended period of time, remove the batteries to avoid possible damage from battery leakage.
- Do not use a new battery with an old one.
- Do not use different types of batteries.
- Do not leave the remote commander in an extremely hot or humid place.
- Do not drop any foreign object into the remote casing, particularly when replacing the batteries.
- Do not expose the remote sensor to direct light from the sun or lighting apparatus. Doing so may cause a malfunction.

Controlling TVs with the remote commander

The remote commander is preprogrammed to control non-Sony TVs. If your TV is listed in the following table, set the appropriate manufacturer's code number.

- 1** Set TV / DVD-VIDEO switch at the top of the remote commander to TV.
- 2** Hold down **I/⏻**, and enter your TV's code number using the number buttons. Then release **I/⏻**.

Now you can use the buttons with an orange dot (•) to control your TV.

When the TV / DVD-VIDEO switch is set to TV, the remote performs the following:

Buttons	Operations
I/⏻	Turns your TV on or off.
VOL +/-	Adjusts the volume of your TV.
CH +/-	Selects the channel on your TV.
Number buttons and ENTER*	Selects the channel on a Sony TV.
MUTING*	Mutes a Sony TV equipped with the muting function.
TV/VIDEO	Switches your TV's input source.

* for Sony TV only

Code numbers of controllable TVs

If more than one code number is listed, try entering them one at a time until you find the one that works with your TV.

TV brand	Code number
Sony	01 (default)
Akai	04
AOC	04
Centurion	12
Coronado	03
Curtis-Mathes	12
Daewoo	22
Daytron	12
Emerson	03, 04, 14
Fisher	11
General Electric	06, 10
LG/Gold Star	03, 04, 17
Hitachi	02, 03
J.C.Penney	04, 12
JVC	09
KMC	03
Magnavox	03, 08, 12
Marantz	04, 13
MGA/Mitsubishi	04, 12, 13, 17
NEC	04, 12

TV brand	Code number
Panasonic	06, 19
Philco	03, 04
Philips	08
Pioneer	16
Portland	03
Quasar	06, 18
Radio Shack	05, 14
RCA	04, 10
Sampo	12
Sanyo	11
Scott	12
Sears	07, 10, 11
Sharp	03, 05, 18
Sylvania	08, 12
Teknika	03, 08, 14
Toshiba	07
Wards	03, 04, 12
Yorx	12
Zenith	15

Notes

- If you enter a new code number, the code number previously entered will be erased.
- If the TV uses a different remote control system from the one programmed to work with the DVD-VCR, you cannot control your TV with the remote commander.
- When you replace the batteries of the remote commander, the code number may change. Set the appropriate code number every time you replace the batteries.

Step 3 : Basic hookups

This section explains the basic hookups for connecting to the TV and the connection to record from a connected equipment. Be sure to connect the power cord only after all connections are complete.

Before you get started

This DVD-VCR does not have a TV tuner. To record TV programs, connect this unit to the cable box or satellite receiver with audio/video outputs (page 16).

If you have been using your VCR connected to an antenna, connect this DVD-VCR to your VCR using an audio/video cord. In this way, you will be able to watch and record TV programs.

The DVD-VCR cannot record programs if you have:

- a cable box without audio/video outputs.
- cable with no cable box.
- antenna only (no cable TV).

In this case, consult your contracted (or nearest) CATV provider.

Notes

- You cannot connect your DVD-VCR to a TV that does not have a video input jack.
- Be sure to disconnect the AC power cord of each component before connecting.
- Be sure you make connections firmly. Loose connections may cause picture distortion.

Connecting to your TV

Connect the TV and DVD-VCR using the supplied audio/video cord.

See “Advanced Hookups for the DVD Player” (page 21, 22) for hookup methods that will optimize the picture and sound for a true “hometheater” experiences.

If you want to record cable TV programs, complete these connections first, and then go to the following pages for cable hookups.

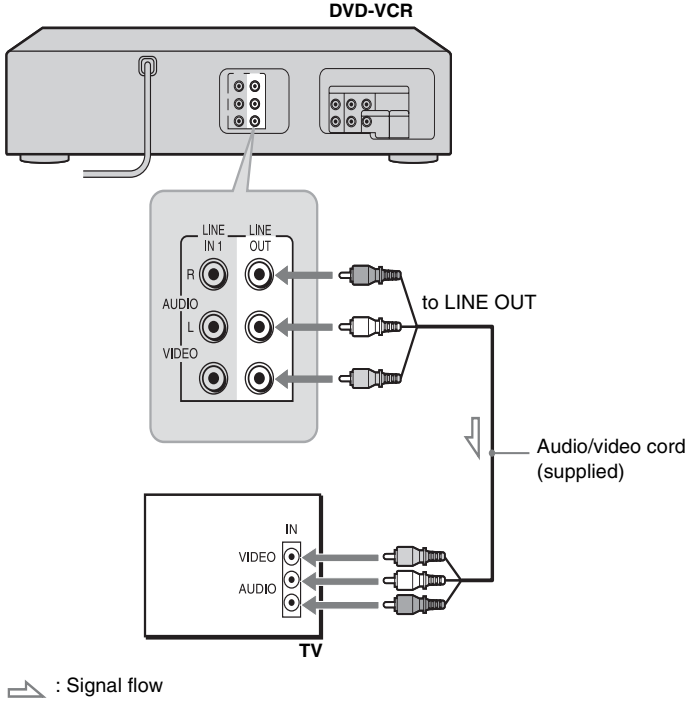

Note

- When the connected TV has only monaural sound input jack, connect to just the LINE OUT/ AUDIO L (white) and VIDEO input jacks. Do not connect the AUDIO R (red) jack.

continued

Connecting a cable box or satellite receiver

With this hookup, you can record any channel on the cable box or satellite receiver. Be sure that the cable box or satellite receiver is turned on. To watch cable or satellite channel, you need to match the DVD-VCR's input source (L1) to the input jack connected to the cable box or satellite receiver (LINE IN 1).

Tip

- You can also connect a cable box or satellite receiver using the LINE-2 IN jacks on the front panel (page 84).

Note

- The DVD-VCR cannot record programs if you have:
 - a cable box without audio/video outputs.
 - cable with no cable box.
 - antenna only (no cable TV).

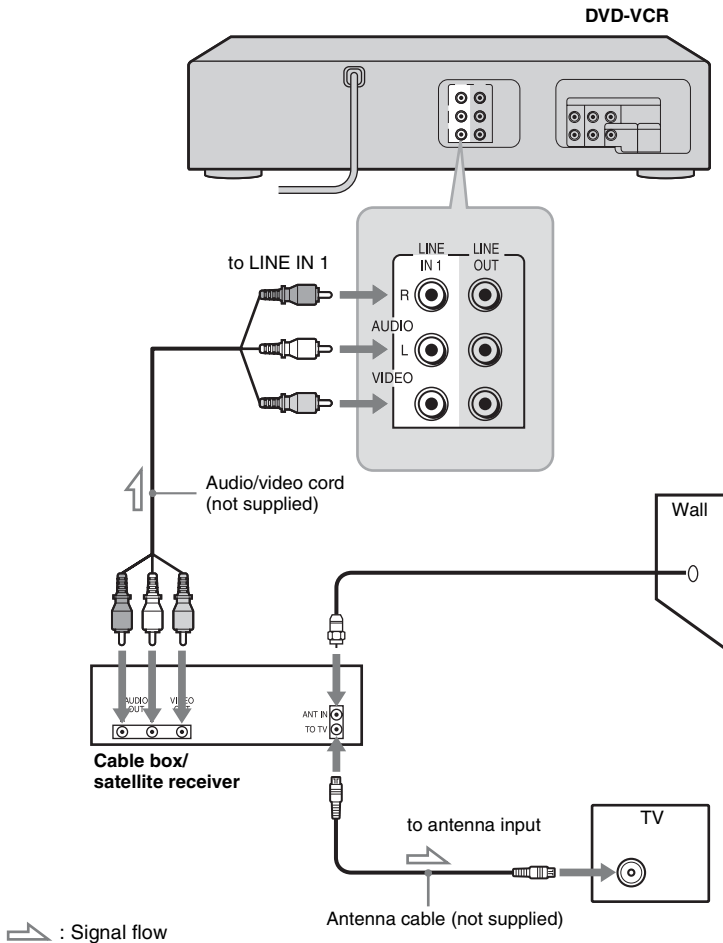

After you have completed hookup...

After you have completed hookup, plug the DVD-VCR into an AC outlet. If you connect additional equipment to this DVD-VCR (page 21, 22), be sure to connect the power cord only after all connections are complete.

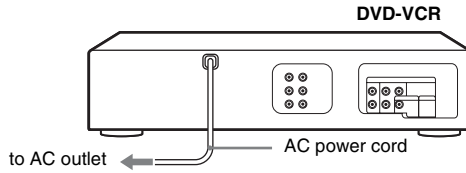



Step 4 : Selecting a language



You can change the on-screen display language.

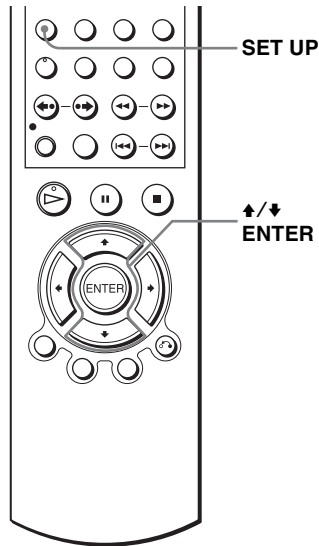

Before you start...

- Turn on the DVD-VCR and your TV.
- Set the TV to video input so that the signal from the player appears on the TV screen.
- Set **TV / DVD-VIDEO** switch to **DVD-VIDEO** on the remote.
- If the DVD player is in play mode, you cannot display the setup menu. Stop the DVD playback.

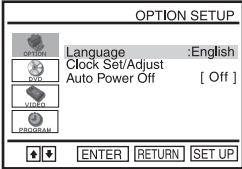





- 1**  Press SET UP, then press  to select (OPTION) and press ENTER.

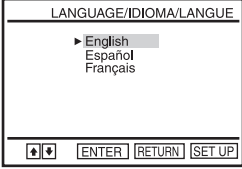

The screenshot shows the 'OPTION SETUP' menu with 'Language :English' highlighted. Other options include 'Clock Set/Adjust' and 'Auto Power Off [Off]'. Navigation buttons at the bottom include up/down arrows, ENTER, RETURN, and SET UP.
- 2**  Press  to select "Language", then press ENTER.

The "LANGUAGE/IDIOMA/LANGUE" menu appears.



The screenshot shows the 'LANGUAGE/IDIOMA/LANGUE' menu with 'English' highlighted. Other options are 'Español' and 'Français'. Navigation buttons at the bottom include up/down arrows, ENTER, RETURN, and SET UP.
- 3**  Press  to select the desired language, English, Spanish or French, then press ENTER.
- 4**  Press SET UP to exit the menu.

Step 5 : Setting the clock

You must set the clock on the DVD-VCR to use the timer features properly.

Before you start...

- Turn on the DVD-VCR and your TV.
- Set the TV to video input so that the signal from the player appears on the TV screen.
- Set **TV / DVD-VIDEO** switch to **DVD-VIDEO** on the remote.
- If the DVD player is in play mode, you cannot display the setup menu. Stop the DVD playback.

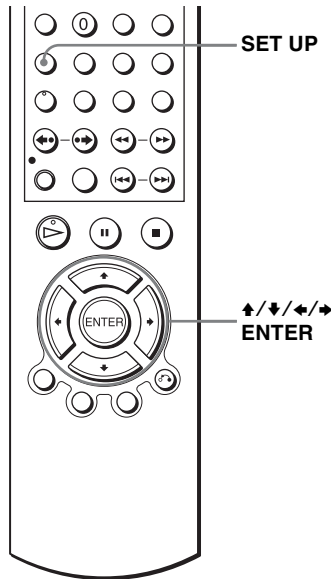

- 1** Press **SET UP**, then press **▲/▼** to select **(OPTION)** and press **ENTER**.

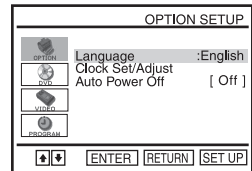
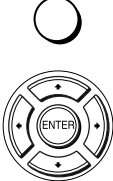

- 2** Press **▲/▼** to select “Clock Set/Adjust”, then press **ENTER**.



The “CLOCK SET/ADJUST” menu appears.

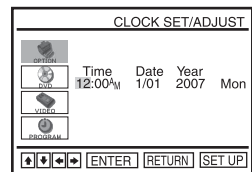

- 3** Set the hour, minutes, month, day and year in sequence by pressing **◀/▶** to select the item to be set, and press **▲/▼** to select the digits. The day of the week is set automatically.

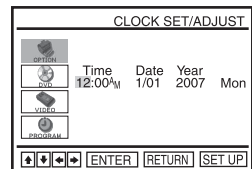

continued

4



Press ENTER to confirm the setting.

5

SET UP



Press SET UP to exit the menu.

Note

- The clock display appears in the display window when VIDEO mode is selected with no tape inserted or when the DVD-VCR is turned off.

Component Video hookup

DVD_{Video} DVD_{VCR} VCD DATA-CD DATA-DVD

Connect a component video cord (not supplied) or three video cords (not supplied) of the same kind and length if your TV has component video input jacks. You will enjoy accurate color reproduction and high quality images when playing DVDs.

Make audio connections using the LINE OUT AUDIO L/R jacks or DIGITAL AUDIO OUT (COAXIAL) jacks on the right side of the DVD-VCR when you use Component Video hookup. See page 22 for audio connections.

If your TV accepts progressive (480p) format signals, you must use this connection and then set “Progressive” to “On” in the “SCREEN SETUP” menu. For details, see “To set the “Progressive” setting” (page 48).

Note

- The connection using COMPONENT VIDEO OUT jacks is only for the DVD player. The signal from the VCR will not be output.

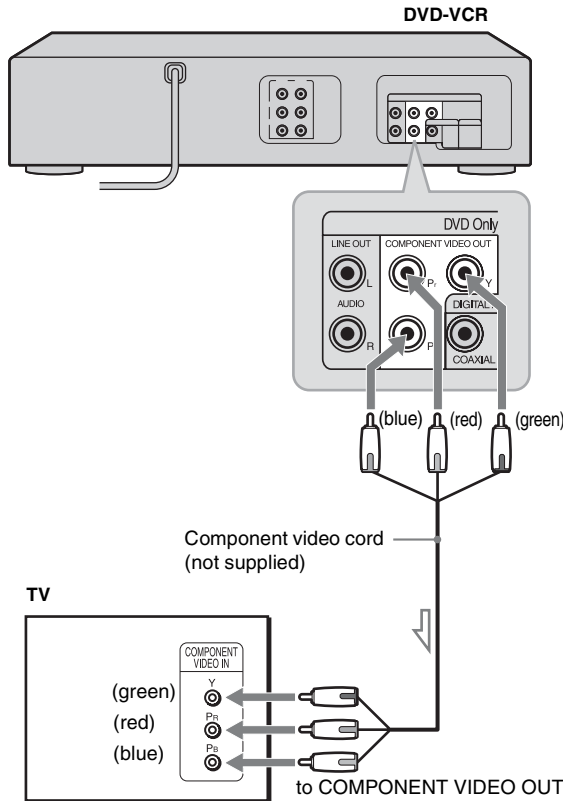

: Signal flow (DVD only)

A/V Receiver hookup

DVDVideo **DVDVR** **VCD** **CD** **DATA-CD** **DATA-DVD**

Select one of the following patterns **A** or **B**, according to the input jack on your AV amplifier (receiver). This will enable you to listen to DVD audio tracks through your AV amplifier (receiver). For correct speaker location, see the operating instructions supplied with the connected components.

Note

- The connection using LINE OUT AUDIO L/R or DIGITAL AUDIO OUT (COAXIAL) jacks is only for the DVD player. The signal from the VCR will not be output.

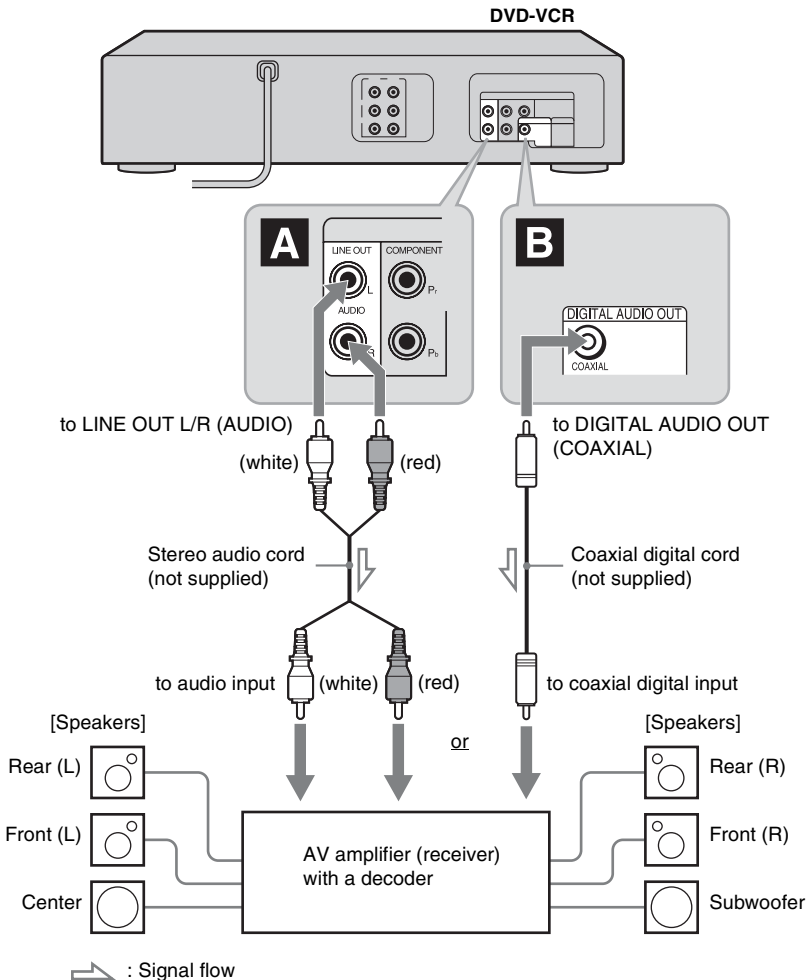

A Connecting to audio L/R jacks

This connection uses a stereo amplifier's (receiver's) two front speakers for sound. You can enjoy the surround function that creates virtual speakers from two stereo speakers. Select from "Surround1", "Surround2" or "Surround3" of the surround effects (page 67).

B Connecting to a digital audio (COAXIAL) input jack

Use this connection if your AV amplifier (receiver) has a Dolby*¹ Digital or DTS*² decoder and a digital input jack. You can enjoy the surround effect of Dolby Digital (5.1ch) or DTS (5.1ch).

*¹ Manufactured under license from Dolby Laboratories.

"Dolby" and the double-D symbol are trademarks of Dolby Laboratories.

*² "DTS" and "DTS Digital Out" are registered trademarks of DTS, Inc.

Note

- After you have completed the connection using DIGITAL AUDIO OUT (COAXIAL), be sure to set "Dolby Digital" to "Dolby Digital" and "DTS" to "On" in "AUDIO SETUP" menu (page 44). Otherwise, no sound or a loud noise will come from the speakers.

3



Press  PLAY.

The disc tray closes and the DVD player starts playback. The display window shows the playback time*.

Depending on the disc, a menu may appear on the TV screen.

For DVDs, see page 55. For VIDEO CDs, see page 79.



* “----” appears when no disc is loaded.

Tip

- To make a video timer reservation during DVD playback, we recommend performing the operations under “Quick Timer Recording” (page 81).

Notes

- You can change the screen type using the “SCREEN SETUP” menu (see “Screen Setup” on page 46).
- Stop VIDEO playback while playing back a disc.
- If you play a DVD or VIDEO CD that has scratches, the player may stop playback at the point of the scratch.
- Playback of play lists longer than 10 hours recorded in VR mode is not guaranteed.
- When 10 hours have passed, the counter in the display window returns to “0:00” and the count starts over again.
- The disc that has been recorded in another unit or PC may not be able to be played back depending on the recording software’s specifications.
- The player cannot play a disc that has been recorded in another unit and incorrectly finalized (page 8).

Additional operations

To	Press
Stop play	■ STOP
Pause play	PAUSE If you pause the DVD player for more than 5 minutes, the DVD player will automatically stop.
Resume play after pause	▷ PLAY
Go to the next frame in pause mode	•➡ SKIP
Go to the previous frame in pause mode	◀• REPLAY
Go to the next chapter, track, or scene in continuous play mode	▶▶ NEXT on the remote or ▶▶ on the unit
Go back to the previous chapter, track, or scene in continuous play mode	◀◀ PREV on the remote or ◀◀ on the unit

continued

To	Press
Locate a point quickly	<p>◀◀ or ▶▶ on the remote (or hold down ◀◀ or ▶▶ on the unit)</p> <p>The playback speed changes as follows each time you press the button on the remote (or depending on how long you press the button on the unit):</p> <ul style="list-style-type: none"> • DVD fast forward: PLAY → ×1.4 ●▶▶*¹ → 1▶▶ → 2▶▶ → 3▶▶ → 4▶▶ → 5▶▶ → 6▶▶ fast reverse: PLAY → 1◀◀ → 2◀◀ → 3◀◀ → 4◀◀ → 5◀◀ → 6◀◀ • CD, MP3 and VIDEO CD fast forward: PLAY → 1▶▶ → 2▶▶ → 3▶▶ fast reverse: PLAY → 1◀◀ → 2◀◀ → 3◀◀ <p>When you find the point you want, press ▷ PLAY.</p>
Watch slow motion in continuous play mode (DVD and VIDEO CD only)	<p> PAUSE during playback, then press ◀◀ or ▶▶</p> <p>The playback speed changes as follows each time you press ◀◀ or ▶▶:</p> <ul style="list-style-type: none"> • DVD forward slow motion: ×0.6 ●▶▶*¹ → 2▶▶ → 3▶▶ reverse slow motion (except for DVD-RW/DVD-R in VR mode): 1◀◀ → 2◀◀ → 3◀◀ • VIDEO CD forward slow motion only: 1▶▶ → 2▶▶ → 3▶▶ <p>To resume normal playback, press ▷ PLAY.</p>
Replay the previous scene for 10 seconds in continuous play mode* ² (Instant Replay)	◀● REPLAY
Briefly fast forward the current scene for 30 seconds in continuous play mode* ² (Instant Advance)	●▶ SKIP You can press ●▶ SKIP up to 4 times. This allows you to fast forward up to 2 minutes in total.
Stop play and remove the disc	▲

*¹ Playback quickly or slowly with sound (See “To playback quickly or slowly with sound (DVD only)” on page 27.)

*² For DVD VIDEOS and DVD-RWs/DVD-Rs or DVD+Rws/DVD+Rs only

Notes

- No sound is output except for:
 - during normal play
 - during playback quickly or slowly with sound
- You cannot perform playback quickly or slowly with sound when a virtual surround effect is set.
- The fast reverse operation may not be possible for CD, MP3 and VIDEO CD depending on the recording method.
- You may not be able to use the Instant Replay or Instant Advance function with some scenes.
- Switching between original (ORG) and play list (PL) within a disc recorded in VR mode is possible only while the disc is stopped. Press TOP MENU to switch between ORG and PL.

To playback quickly or slowly with sound (DVD only)

You can listen to dialog or sound while playing the current scene quickly or slowly.

To playback quickly, press ►► during playback.

To playback slowly, press ■ PAUSE, then press ► during playback.

Press ▷ PLAY to return to normal playback.

Notes

- You cannot set virtual surround effects while performing playback quickly or slowly with sound. In addition, you cannot perform playback quickly or slowly with sound when a virtual surround effect is set.
- You cannot perform DTS audio output during playback quickly or slowly with sound. In addition, you cannot perform playback quickly or slowly with sound when DTS audio output is set.

To Resume playback for the current disc (Resume Play)

The DVD player remembers the point where you stopped the disc even if the DVD player enters standby mode by pressing I/⏻.

1 While playing a disc, press ■ STOP to stop playback.

2 Press ▷ PLAY.

The DVD player starts playback from the point where you stopped the disc in Step 1.

Tip

- To begin playback from the top of the disc, press ■ STOP twice then press ▷ PLAY.

Notes on playing DTS* sound tracks on a CD

- When playing DTS-encoded CDs, excessive noise will be heard from the analog stereo jacks. To avoid possible damage to the audio system, the consumer should take proper precautions when the analog stereo jacks of the DVD player are connected to an amplification system. To enjoy DTS Digital Surround™ playback, an external 5.1-channel decoder system must be connected to the digital jack of the DVD player.
- Set the sound to “Stereo” using the AUDIO button when you play DTS sound tracks on a CD (page 65).
- Do not play DTS sound tracks without first connecting the DVD player to an audio component having a built-in DTS decoder. The DVD player outputs the DTS signal via the DIGITAL AUDIO OUT (COAXIAL) jack even if “DTS” is set to “Off” in “AUDIO SETUP” menu (page 44), and may affect your ears or cause your speakers to be damaged.

Notes on playing DVDs with a DTS sound track

- DTS audio signals are output only through the DIGITAL AUDIO OUT (COAXIAL) jack.
- When you play a DVD with DTS sound tracks, set “DTS” to “On” in “AUDIO SETUP” menu (page 44).
- If you connect the player to audio equipment without a DTS decoder, do not set “DTS” to “On” in “AUDIO SETUP” menu (page 44). A loud noise may come out from the speakers, affecting your ears or causing the speakers to be damaged.

* “DTS” and “DTS Digital Out” are registered trademarks of DTS, Inc.

Guide to the on-screen display

DVD_{Video} **DVD**_{VR} **VCD** **CD**

You can check disc information during playback.

The displayed contents differ according to the type of disc being played.

Before you start...

- Set **TV / DVD-VIDEO** switch to **DVD-VIDEO** on the remote.

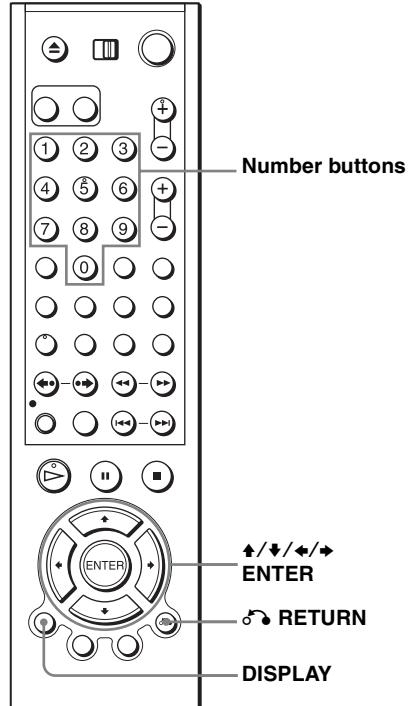

Press **DISPLAY** during playback. The following information appears; type of disc, current title/track, chapter, counter position, voice language, subtitle language and Custom AV Mode setting. Refer to “DVD Audio/Subtitle Language” on page 100 for the abbreviation of the language.

Type of disc	DVD	PLAY
Current title/track number	1/3	
Current chapter number	1/36	
Counter position	T 0:01:09	
Voice language	ENG 5,1CH	
Subtitle language	ENG (3/5)	
Custom AV Mode	Standard	

At the bottom of the display area, there is a row of control icons: a left arrow, a right arrow, a stop icon, a play icon, and an **ENTER** button.

Note

- You cannot select disc information items when the disc is stopped.

To playback the desired title/track or chapter

You can playback the desired title/track or chapter using this menu.

- 1 Press **▲/▼** during playback to select the desired item.
- 2 Press **←/→** to change the item.
- 3 Press **ENTER** to start playback.
- 4 Press **DISPLAY** or **↵** **RETURN** to turn off the menu.

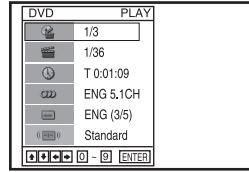

The title/track or chapter icon will appear on the DVD playback screen followed by the current title/track or chapter number and the counter position.

To playback from the desired title/track counter position

You can playback from the desired title/track counter position using this menu.

- 1 Press **▲/▼** during playback to select the counter position icon.
- 2 Enter the desired elapsed playing time of the current title/track using the number buttons.
- 3 Press **ENTER** to start playback.
- 4 Press **DISPLAY** or **↵** **RETURN** to turn off the menu.

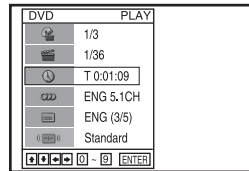

Tip

- You can change the counter position information (playing time or remaining time) using **←/→** (DVD and CD only).

DVD

Indication	Counter information
T * : * : * *	Elapsed playing time of the current title
T- * : * : * *	Remaining time of the current title
C * : * : * *	Elapsed playing time of the current chapter
C- * : * : * *	Remaining time of the current chapter

CD

Indication	Counter information
T * : * : * *	Elapsed playing time of the current track
T- * : * : * *	Remaining time of the current track
D * : * : * *	Elapsed playing time of the disc
D- * : * : * *	Remaining time of the disc

continued

Notes

- The display may not change as operated depending on the disc.
- The display window continue indicating the playing time even when the counter position information on the on-screen display is being changed.
- The remaining time of the current track and the disc may not be indicated correctly for Copy Control CDs, CD EXTRA or CDs with jacket pictures on the disc, etc.

To adjust the playback picture (Custom AV Mode)

You can adjust the video signal of the DVD or VIDEO CD (with PBC function off) from the player to obtain the picture quality you want. Choose the setting that best suits the program you are watching.

- 1 Press **▲/▼** during playback to select the Custom AV Mode icon.

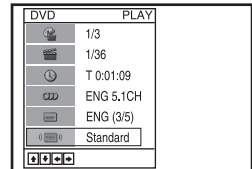

- 2 Press **←/→** to change the setting.

Setting	Video Setting	Audio Setting
Dynamic 2	Produces a more dynamic picture than Dynamic 1 by further increasing the picture contrast and the color intensity.	Full (modulated) sound with even clearer treble and bass than Dynamic 1.
Dynamic 1	Produces a bold dynamic picture by increasing the picture contrast and the color intensity.	Full (modulated) sound with clear treble and bass.
Standard	Off (Default setting) Displays a standard picture.	Standard sound.
Cinema 1	White colors become brighter and black colors become richer, and the color contrast is increased.	Powerful sound with strong bass.
Cinema 2	Enhances details in dark areas by increasing the black level.	Powerful sound with even stronger bass than Cinema 1.

Tip

- When you watch a movie, “Cinema 1” or “Cinema 2” is recommended.

Playing a tape **VHS**

Before you start ...

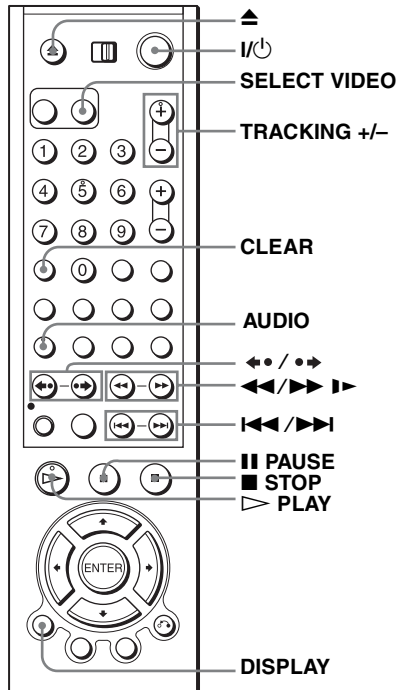

- Turn on the DVD-VCR and your TV.
- Set the TV to video input so that the signal from the player appears on the TV screen.
- Set TV / DVD-VIDEO switch to DVD-VIDEO on the remote.

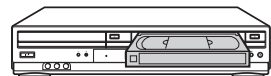

1  Press SELECT VIDEO to control the VCR player.

2 Insert a tape.
The VCR starts playing automatically if you insert a tape with its safety tab removed.



3  Press  PLAY.
The display window shows the playback time.
When the tape reaches the end, it will rewind automatically.



continued

Additional operations

To	Press
Stop play	■ STOP
Pause play	PAUSE If you pause the VCR for more than 5 minutes, the VCR will automatically resume play.
Resume play after pause	PAUSE or ▷ PLAY
Fast-forward the tape	▶▶ during stop
Rewind the tape	◀◀ during stop
Eject the tape	⏏
View the picture during fast-forward or rewind	During fast-forward, hold down ▶▶. During rewind, hold down ◀◀.
Play at high speed	<ul style="list-style-type: none"> • During playback, briefly press ▶▶ or ◀◀. The tape continues to play at 5 times normal speed. • During playback, hold down ▶▶ or ◀◀. The tape continues to play at 5 times normal speed. When you release the button, normal playback resumes.
Play in slow motion	During pause, press ▶◀.
Play frame by frame	During pause, press ●▶ SKIP.
Replay the previous scene in continuous play mode* (Instant Replay)	During playback, press ◀◀ REPLAY.
Fast forward the current scene for 30 seconds in continuous play mode (Instant Skip)	During playback, press ●▶ SKIP. You can press ●▶ SKIP up to 4 times. This allows you to fast forward up to 2 minutes in total.
Play at various speeds (Shuttle play)	During playback, press ◀◀◀ or ▶▶▶. You can change the playback speed as follows. -x7 ↔ -x5 ↔ -x3 ↔ STILL ↔ SLOW ↔ PLAY ↔ x2 ↔ x3 ↔ x5 ↔ x7

* For 10 seconds in SP or LP mode/for 15 seconds in EP mode

To resume normal playback

Press ▷ PLAY.

To turn off the power while rewinding (Rewind Shut Off)

Press I/⏻ while the tape is rewinding. The power will turn off but the tape will keep rewinding until it reaches the end.

To use the time counter

Press CLEAR at the point on the tape that you want to find later. The counter in the display window resets to “00:00.” To search for the counter 00:00 point automatically, see “Searching using various functions” on page 82.



To display the counter on the TV screen, press DISPLAY during normal playback.

Tips

- Adjust the picture using the TRACKING +/- buttons if:
 - Streaks appear while playing in slow motion.
 - Bands appear at the top or bottom while pausing.
 - The picture shakes during pause.
- During playback, press AUDIO to select the sound output (Stereo/L channel/R channel/Mono) you want.
- When you play a tape recorded in monaural, the sound is played back in monaural regardless of the AUDIO setting.

Notes

- Tapes recorded in LP mode on other VCRs can be played back on this VCR but the picture quality cannot be guaranteed.
- The counter resets to “00:00” whenever a tape is reinserted.
- The counter stops counting when it comes to a portion with no recording.
- When 10 hours have passed, the counter in the display window returns to “0:00” and the count starts over again.
- No sound is output during playback at various speeds.
- The picture may show noise when playing at high speed in reverse.
- While playing a tape, you can display the setup menu, but the remote commander’s function switches to DVD automatically. Press  RETURN repeatedly to exit the menu.
- When playback does not start even if you insert a tape with its safety tab removed, set “Auto Play” to “On” in the “VIDEO FUNCTION SETUP” menu (page 86).
- Stop disc playback while playing back a video.
- The VCR can also play S-VHS tapes recorded by S-VHS mode. The VCR will automatically identify the type of tape inserted in the VCR (either VHS or S-VHS). When S-VHS tapes are played in the VCR, the enhanced resolution will not be visible on screen; there may also be picture distortion while playing the S-VHS tape in slow motion or while utilizing other special playback modes. The VCR will not record in S-VHS mode on an S-VHS tape.
- The playback of S-VHS tapes recorded in EP/LP mode cannot be guaranteed.

continued

Adjusting the picture (tracking) **VHS**

Although the VCR automatically adjusts the tracking when playing a tape, distortion may occur if the recording is in poor condition. In this case, manually adjust the tracking.

Press **TRACKING +/-** to display the tracking meter. The distortion should disappear as you press one of the two tracking buttons.

To resume automatic tracking adjustment, eject the tape and reinsert it.

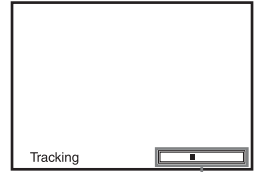

Tracking meter

Note

- The auto tracking adjustment cannot be guaranteed to work with tapes recorded in the LP mode on other VCRs.

Recording from a connected equipment **VHS**

You can record from a connected cable box or satellite receiver. To connect cable box or satellite receiver, see “Connecting a cable box or satellite receiver” on page 16.

Before you start ...

- Turn on the DVD-VCR, TV and your cable box or satellite receiver.
- Set the TV to video input so that the signal from the player appears on the TV screen.
- Set TV / DVD-VIDEO switch to DVD-VIDEO on the remote.
- Make sure the tape is longer than the total recording time.

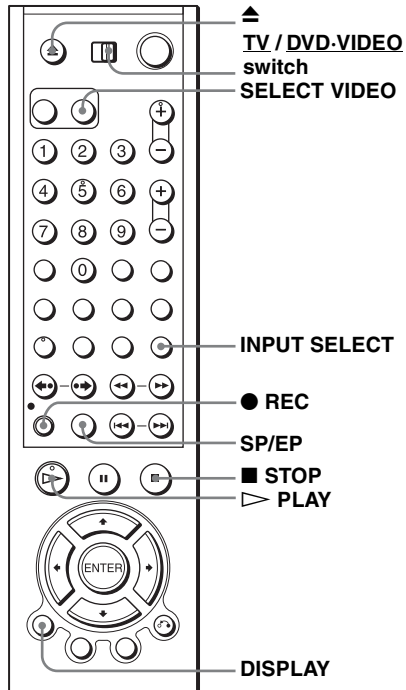

1  Press SELECT VIDEO to control the VCR.

2 Insert a tape with its safety tab in place.

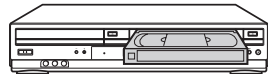

3  Press INPUT SELECT to select a source connected to the LINE IN 1 or LINE-2 IN jacks. “L1” or “L2” appears in the display window.



continued

4

SP/EP



Press SP/EP to select the tape speed, SP or EP.

EP (Extended Play) provides recording time three times as long as SP (Standard Play). However, SP produces better picture and audio quality.

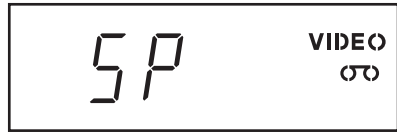

5

● REC



Press ● REC to start recording.

“REC” appears in the display window.

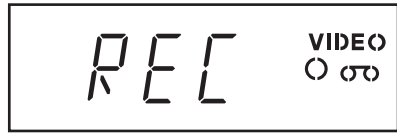

While recording, leave the connected cable box or satellite receiver turned on and do not change their channel you want to record.

To stop recording

Press ■ STOP.

To check the remaining tape length

Press DISPLAY to display the time counter. With the display on, press DISPLAY again to check the remaining time. The white bar indicates the current location in relation to the entire tape length. The remaining time also appears. Press DISPLAY to turn off the indicators.

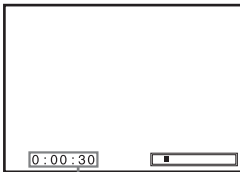

Time counter

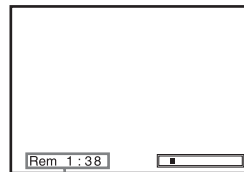

Remaining tape length

To check the remaining tape length of a tape, set “Tape Length” in the “VIDEO FUNCTION SETUP” menu correctly (page 86).

Maximum Recording Time

Tape Length	SP	EP
T-120	2 hrs	6 hrs
T-160	2 hrs 40 mins	8 hrs
T-180	3 hrs	9 hrs

To watch a DVD while recording

- 1 Press SELECT DVD to control the DVD player.
- 2 Press ▲ and place the disc on the disc tray.
- 3 Press ▷ PLAY.

The disc tray closes and the DVD player starts playback. The TV screen will automatically change to the DVD playback screen.

To save a recording

To prevent accidental erasure, break off the safety tab as illustrated. To record on the tape again, cover the tab hole with adhesive tape.



Tips

- The display appears on the TV screen indicating information about the tape, but the information will not be recorded on the tape.
- If you do not want to watch TV while recording, you can turn off the TV.

Notes

- The remaining tape length may not be indicated accurately for short tapes such as T-20 or T-30, or tapes recorded in LP mode.
- It may take up to one minute for the VCR to calculate and display the remaining tape length after you press DISPLAY.
- You cannot record a DVD directly to a VCR tape using your DVD-VCR.

3

Set the line input (L1 or L2), start and stop times, date, and tape speed:

1 Press **▶** to select each item in turn.

2 Press **▲/▼** to set each item.

To correct a setting, press **◀** to return to that setting and reset.

L1/L2	START	END	DATE	SPEED
L1	10:00 ^m	12:00 ^m	10/13	Auto
---	---	---	---	---
---	---	---	---	---
---	---	---	---	---
---	---	---	---	---
---	---	---	---	---
---	---	---	---	---
---	---	---	---	---
---	---	---	---	---
				RETURN CLEAR

INPUT
SELECT



- To select a source connected to the LINE IN 1 or LINE-2 IN jacks, press INPUT SELECT or **▲/▼** to display “L1” or “L2” in the “L1/L2” position.
- To record the same program every day or the same day every week, press **▼** while the date is flashing. For details, see “Daily/weekly recording” on page 39.
- To use the Auto Tape Speed function, press **▼** to display “Auto” in the “SPEED” position. For details, see “To use the Auto Tape Speed function” on page 40.

4

Press **▶** to confirm the setting.

To enter another setting, press **▲/▼** to select the next row and repeat step 3.

Press CLEAR to cancel the setting.

CLEAR

**5**

RETURN

Press **↻** RETURN to exit the menu.

6

The **⊖** indicator appears in the display window and the VCR stands by for recording. While recording, the connected cable box or satellite receiver turned on and do not change their channel you want to record. Timer recording will operate properly regardless if the DVD-VCR power is on or off.

To stop recording

To stop the DVD-VCR while recording, press SELECT VIDEO and then press **■** STOP.

Daily/weekly recording

In step 3, press **▼** to select the recording pattern. Each time you press **▼**, the indication changes as shown below. Press **▲** to change the indication in reverse order.

the current date → **Daily** → **Mo-Sa** → **Mo-Fr** → **Sun's** → **Mon's** → → **Sat's** → **1 month later** → **(dates count down)** → **the current date**

continued

To use the Auto Tape Speed function

When you are recording a program in the Auto mode and the remaining tape becomes shorter than the recording time, the tape speed is automatically changed to EP mode. Note that some noise will appear on the picture when the tape speed is changed. If you want to keep the tape speed, select SP. To operate this function, set "Tape Length" in "VIDEO FUNCTION SETUP" menu correctly (page 86).

To watch a DVD after setting the timer





1 Press SELECT DVD to control the DVD player.

2 Press  and place the disc on the disc tray.

3 Press  PLAY.

The disc tray closes and the DVD player starts playback. The TV screen will automatically change to the DVD playback screen.

Tips

- If the  indicator appears, the timer settings overlap. To check, change or cancel the timer setting, see "Checking/changing/canceling timer settings" on page 41.
- If the  indicator appears, this means that the VCR is currently recording this program.
- You can also do the following tasks while the VCR is recording:
 - Reset the counter (page 33).
 - Display tape information on the TV screen (page 36).
- You can also display the timer programming menu by first pressing SET UP, then  to select  (PROGRAM) and pressing ENTER in step 2.

Note

- The  indicator flashes in the display window when you complete the timer setting with no tape inserted.

Checking/changing/canceling timer settings **VHS**

Before you start...

- Check that the DVD-VCR clock is set to the correct time.
- Turn on the DVD-VCR and your TV.
- Set the TV to video input so that the signal from the player appears on the TV screen.
- Set **TV / DVD-VIDEO** switch to **DVD-VIDEO** on the remote.
- Insert a tape with its safety tab in place. Make sure the tape is longer than the total recording time.
- If the DVD player is in play mode, you cannot display the setup menu. Stop the DVD playback.

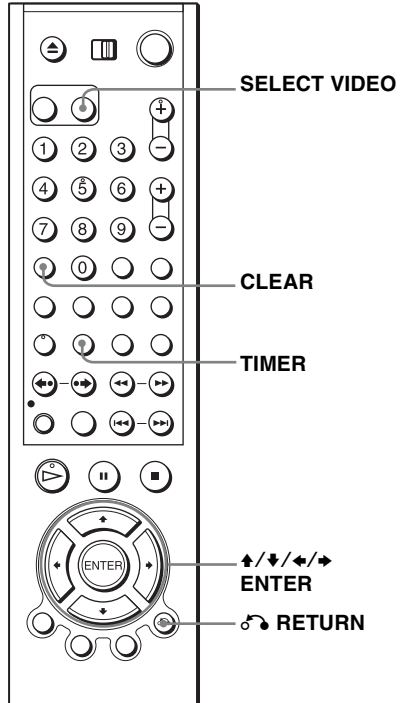

1 **SELECT VIDEO** Press SELECT VIDEO to control the VCR.



2 **SUBTITLE/TIMER** Press TIMER.
The timer programming menu appears.



L1/L2	START	END	DATE	SPEED
L1	05:31 ^{PM}	07:31 ^{PM}	1/20	SP
L1	01:31 ^{PM}	03:32 ^{PM}	1/21	Auto
L2	06:32 ^{PM}	08:32 ^{PM}	1/21	EP
---	---	---	---	---
---	---	---	---	---
---	---	---	---	---
---	---	---	---	---
---	---	---	---	---
---	---	---	---	---
---	---	---	---	---
				(RETURN)

continued

Locking the DVD-VCR (Child Lock)

After you have set the timer, you can lock all of the buttons on the DVD-VCR so that the settings are not canceled by mistake.

I/⏻ POWER

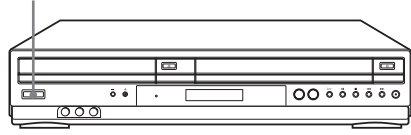

To lock the DVD-VCR

When the DVD-VCR is turned on, hold down I/⏻ POWER on the unit until “LOC” appears in the display window. The DVD-VCR turns off and the Ⓟ indicator remains lit if there is a timer setting. The DVD-VCR will not work except for timer recordings.

To unlock the DVD-VCR

Hold down I/⏻ POWER on the unit until “LOC” disappears from the display window. The DVD-VCR is unlocked and turns on.

To stop timer recording while the DVD-VCR is locked, press ■. The recording stops and the DVD-VCR is unlocked.

Note

- The DVD-VCR will be unlocked when:
 - You stop timer recording by pressing ■.
 - You insert a tape.
 - The AC power cord is disconnected or power supply stops.

Audio Setup DVDVideo DVDVR

“Audio Setup” allows you to set the sound according to the playback and connection conditions.

Before you start...

- Set TV / DVD-VIDEO switch to DVD-VIDEO on the remote.

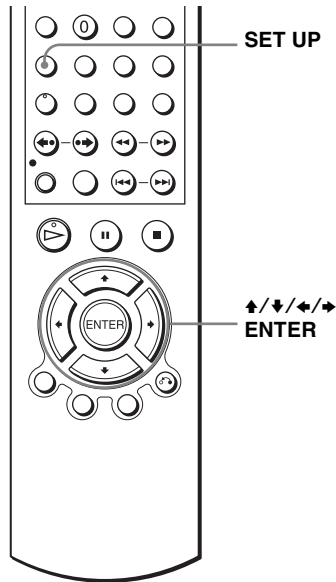

- 1** Press SET UP when the DVD player is in stop mode, then press  (DVD), then press ENTER.



- 2** Press  to select “Audio Setup,” then press ENTER.

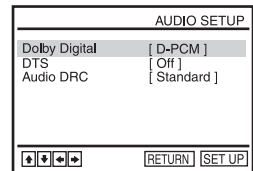

- 3** Press  to select the setup item from the displayed list: “Dolby Digital,” “DTS” or “Audio DRC.”



4

Press ◀/▶ to select an item.

5

SET UP



Press SET UP to exit the menu.

Menu choices

- **Dolby Digital**

Selects the type of Dolby Digital signal.

The default setting is indicated in bold print.

D-PCM	Select this when the player is connected to an audio component lacking a built-in Dolby Digital decoder.
Dolby Digital	Select this when the player is connected to an audio component with a built-in Dolby Digital decoder.

- **DTS**

Selects whether or not to output DTS signals.

The default setting is indicated in bold print.

Off	Select this when the player is connected to an audio component lacking a built-in DTS decoder.
On	Select this when the player is connected to an audio component with a built-in DTS decoder.

- **Audio DRC (Dynamic Range Control)**

Makes the sound clear when the volume is turned down when playing a DVD that conforms to “Audio DRC.” This affects the output from the following jacks:

- LINE OUT AUDIO L/R jacks
- DIGITAL AUDIO OUT (COAXIAL) jack only when “Dolby Digital” is set to “D-PCM”.

The default setting is indicated in bold print.

Standard	Normally select this position.
Wide Range	Gives you the feeling of being at a live performance.

Notes

- If you connect a component that does not conform to the selected audio signal, a loud noise (or no sound) will come out from the speakers, affecting your ears or causing the speakers to be damaged.
- Noise may occur in the LinearPCM double-speed audio. This is not a malfunction.

Screen Setup DVDVideo

“Screen Setup” allows you to set the screen according to the playback and connection conditions.

Before you start...

- Set TV / DVD-VIDEO switch to DVD-VIDEO on the remote.

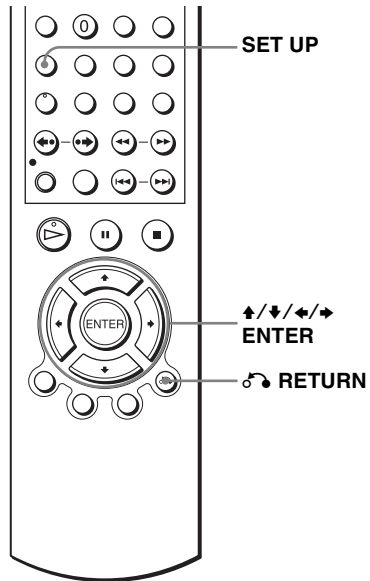

1

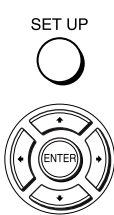

Press SET UP when the DVD player is in stop mode, then press \uparrow/\downarrow to select  (DVD), then press ENTER.



2



Press \uparrow/\downarrow to select “Screen Setup,” then press ENTER.

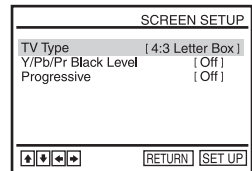

3



Press \uparrow/\downarrow to select the setup item from the displayed list: “TV Type,” or “Y/Pb/Pr Black Level.”

To set the “Progressive” setting, see page 48.

4Press \leftarrow/\rightarrow to select an item.**5**

SET UP



Press SET UP to exit the menu.

Menu choices

- TV Type

Selects the aspect ratio of the connected TV (4:3 standard or wide).

The default setting is indicated in bold print.

4:3 Letter Box	Select this when you connect a 4:3 screen TV. Displays a wide picture with bands on the upper and lower portions of the screen.
4:3 Pan Scan	Select this when you connect a 4:3 screen TV. Automatically displays the wide picture on the entire screen and cuts off the portions that do not fit.
16:9	Select this when you connect a wide-screen TV or a TV with a wide mode function.

4:3 Letter Box



4:3 Pan Scan



16:9



- Y/Pb/Pr Black Level

Selects the black level (setup level) for the video signals output from the COMPONENT VIDEO OUT jacks.

The default setting is indicated in bold print.

Off	Sets the black level of the output signal to the standard level. Normally select this position.
On	Raises the standard black level. Use this setting when the picture appears too dark.

Notes

- Playback settings stored in the disc take priority over the “DVD SETUP” menu settings and not all the functions described may work.
- Depending on the DVD VIDEO, “4:3 Letter Box” may be selected automatically instead of “4:3 Pan Scan” or vice versa.

continued

To set the “Progressive” setting

If your TV accepts progressive (480p) format signals, you will enjoy accurate color reproduction and high quality image.

1 Follow step 1 and 2 on page 46, then press **▲/▼** to select “Progressive.”

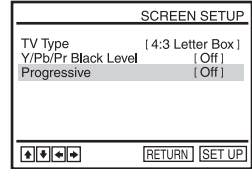

2 Press **←/→** to select “On,” then press ENTER.

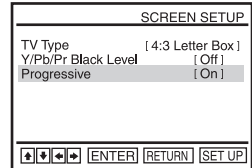

3 Follow the instructions appearing on the screen.

1 Ensure your TV is (480p) Progressive Scan capable.

2 Connect with Component Video Output jacks (red/green/blue connections).

For details, see the connection **B** on page 21.

3 Press **←/→** to select [OK] to test your video signal.

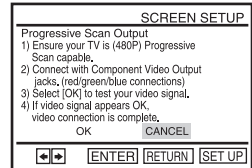

4 If video signal appears OK, video connection is complete. Press ENTER.

The PROGRESSIVE indicator on the unit lights up in orange.

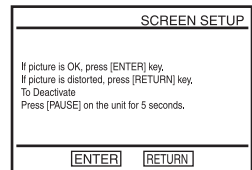
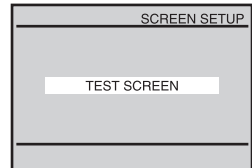
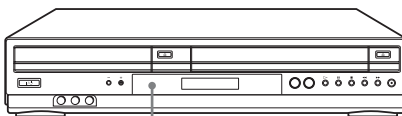

If picture is distorted, press **↶** RETURN. Check the connection (page 21).

5 Press SET UP to exit the menu.

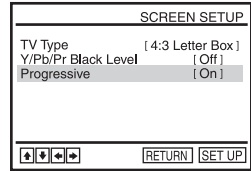

To cancel the “Progressive” setting

Select “Off” in step 2.

You can also cancel by pressing SELECT DVD and then press **■** on the unit continuously for 5 seconds or more when the DVD-VCR is in stop mode.

Note

- If you select progressive signal when you connect the DVD player to a TV that cannot accept the signal in progressive format, the image quality will deteriorate. In this case, set “Progressive” to “Off”.

Setting the display or sound track language DVDVideo

You can set various languages for the disc's menu, sound track or subtitle.

Before you start...

- Set **TV / DVD-VIDEO** switch to **DVD-VIDEO** on the remote.

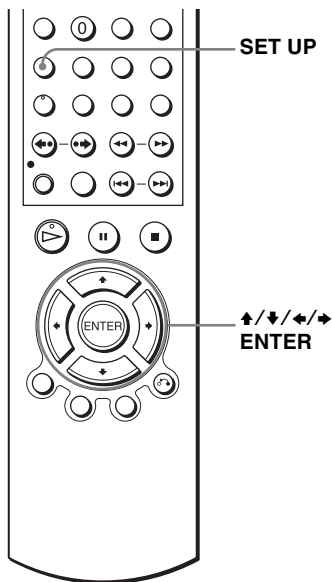

- 1** Press **SET UP** when the DVD player is in stop mode, then press **▲/▼** to select  (DVD) and press **ENTER**.

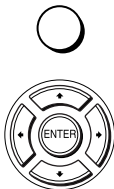

- 2** Press **▲/▼** to select “Language Setup,” then press **ENTER**.
The “LANGUAGE SET UP” menu appears.

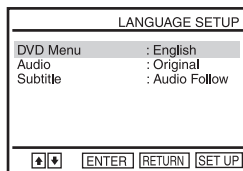

- 3** Press **▲/▼** to select the language setup item from the displayed list: “DVD Menu,” “Audio,” or “Subtitle.”
Then press **ENTER**.



4



Press $\blacktriangle/\blacktriangledown$ to select the desired language, then press ENTER.

- **DVD MENU LANGUAGE**
You can select the desired language for the disc's menu.



- **AUDIO LANGUAGE**
Switches the language of the sound track. When you select "Original," the language given priority in the disc is selected.



- **SUBTITLE LANGUAGE**
Switches the language of the subtitle recorded on the DVD VIDEO. When you select "Audio Follow," the language for the subtitle changes according to the language you selected for the sound track.

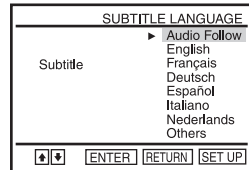

5

SET UP



Press SET UP to exit the menu.

Tip

- If you select "Others" in step 4, an additional language menu appears. Press $\blacktriangle/\blacktriangledown/\blacktriangleleft/\blacktriangleright$ to select the desired language, then press ENTER.



Notes

- When you select a language that is not recorded on the DVD VIDEO in step 4, one of the recorded languages will be automatically selected.
- Playback settings stored in the disc take priority over the DVD SETUP settings and not all the functions described may work.

Parental Control (limiting playback by children)

DVDVideo

Playback of some DVD VIDEOS can be limited according to a predetermined level such as the age of the users. The "Parental Control" function allows you to set a playback limitation level.

Before you start...

- Set TV / DVD-VIDEO switch to DVD-VIDEO on the remote.

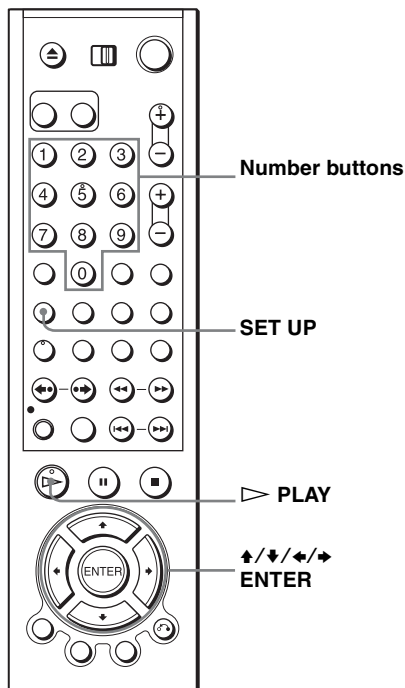

1

SET UP



Press SET UP when the DVD player is in stop mode, then press \uparrow/\downarrow to select  (DVD) and press ENTER.



2



Press \uparrow/\downarrow to select "Parental Setup," then press ENTER.

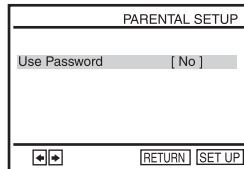

3

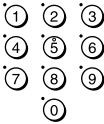

Press **▶** to set the parental control.

- If you have not entered a password
The display for registering a new password appears.
Enter a 4-digit password using the number buttons.

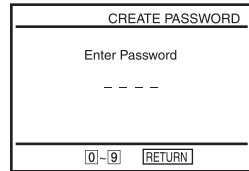

The display for confirming the password appears.
Re-enter the password.

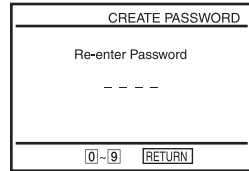

- When you have already registered a password
The display for entering the password appears.
Enter a 4-digit password using the number buttons.
After registering a password, if you set “Use Password” to “No,” “PASSWORD CHECK” screen will not appear.

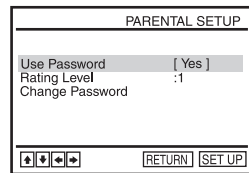
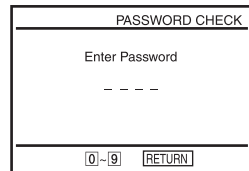

4



Press **▲/▼** to select “Rating Level,” then press ENTER.

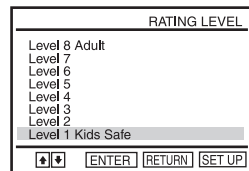

5



Press **▲/▼** to select the level you want, then press ENTER.

The options are as follows.

Level 8 Adult ↔ Level 7 ↔ Level 6 ↔
Level 5 ↔ Level 4 ↔ Level 3 ↔ Level 2
↔ Level 1 Kids Safe

The lower the value, the stricter the limitation.

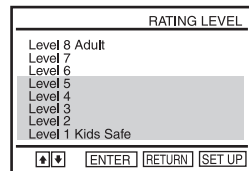

6

SET UP



Press SET UP to exit the menu.

continued

To change the password

- 1** Select “Change Password” in step 4 on page 53.
The display for entering a new password appears.
- 2** Enter a new 4-digit password using the number buttons.
The display for confirming the password appears.
- 3** Re-enter the new password.

To turn off the Parental Control function

Set “Use Password” to “No” in step 3 on page 53.

To play a disc for which Parental Control is set

- 1** Insert the disc, then press \triangleright PLAY.
The display for entering your password appears.
- 2** Enter your 4-digit password using the number buttons.
The player starts playback.

If you forget your password

- 1** Turn on the DVD-VCR.
- 2** Remove the disc and close the disc tray.
- 3** Hold down \blacktriangleleft and \blacktriangleright on the front panel simultaneously for 5 seconds.
“Reset OK” appears on the screen.
- 4** Turn off the DVD-VCR.
The password is cleared.
- 5** To create a new password, follow step 3 on page 53.

Notes

- When you play DVD VIDEOS which do not have the Parental Control function, playback cannot be limited on this player.
- All the ratings higher than the level you select will be blocked.
- Write your password down and keep it in a safe place in case you forget it.
- When you clear the password, “Language” in the “OPTION SETUP” menu and all items in the “DVD SETUP” menu are returned to the default setting.

Using the DVD's menu DVDVideo

A DVD is divided into long sections of a picture or a music feature called "titles." When you play a DVD VIDEO which contains several titles, you can select the title you want using the TOP MENU button.

When you play DVD VIDEOS that allow you to select items such as the language for the subtitles and the language for the sound, select these items using the MENU button.

Before you start...

- Set **TV / DVD-VIDEO** switch to **DVD-VIDEO** on the remote.

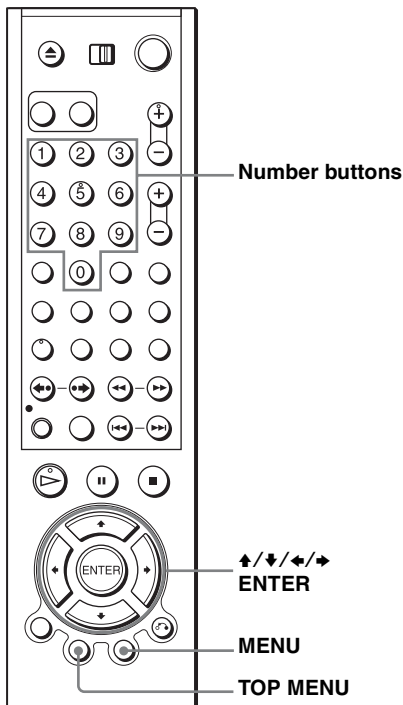

- 1**
- 

TOP MENU



MENU

Press TOP MENU or MENU.
The disc's menu appears on the TV screen.
The contents of the menu vary from disc to disc.

- 2**
- 

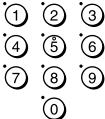
Press **↑/↓/←/→** to select the item you want to play or change, then press ENTER.
You can also use the number buttons to select the item.
- 

Note

- Depending on the DVD VIDEO, you may not be able to use the TOP MENU button or search a point by setting the time.

Zooming into a scene DVDVideo DVDVR VCD

You can zoom into a scene during playback or still mode.

To zoom into a JPEG image, see “Playing JPEG image files” on page 75.

Before you start...

- Set TV / DVD-VIDEO switch to DVD-VIDEO on the remote.

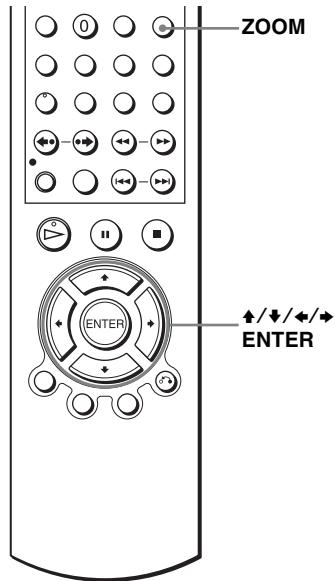

1



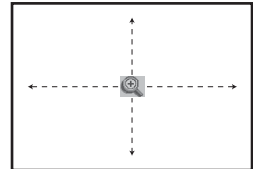

Press ZOOM.
“” appears.



2



Press  to move “” to the position where you want to zoom in.

3



Press ENTER repeatedly to change the magnification.

Each time you press the button, the magnification changes as shown below.

2× → 4× → 2× → normal magnification

Notes

- You cannot use 4× magnification when you play VIDEO CDs.
- The zoom function may not work depending on the DVD.

Changing the angles DVDVideo

If various angles (multi-angles) for a scene are recorded on the DVD VIDEO, “” appears on the screen for few seconds. This means that you can change the viewing angle.

Before you start...

- Set TV / DVD-VIDEO switch to DVD-VIDEO on the remote.

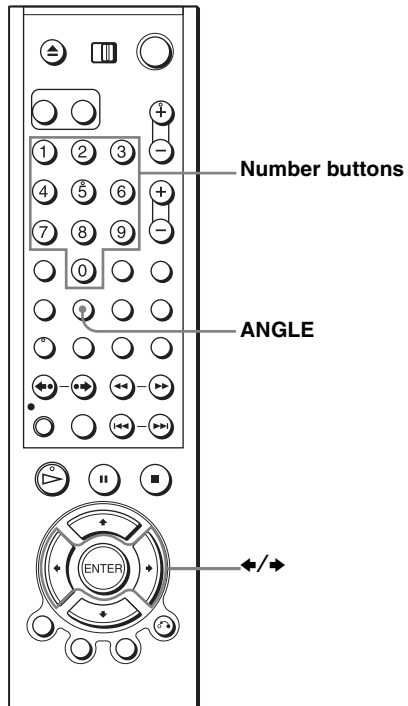

1



Press ANGLE during playback.

The angle number appears on the display.

The number after the slash indicates the total number of angles.

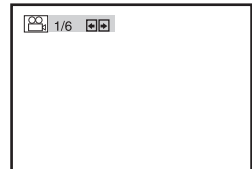

2



Press  repeatedly to select the angle number.

The scene changes to the selected angle.

You can also select the angle number using the number buttons.

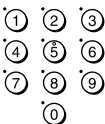

continued

Tip

- To confirm whether the angles of the current scene can be changed, press DISPLAY twice when playing DVDs.

Note

- Depending on the DVD VIDEO, you may not be able to change the angles even if multi-angles are recorded on the DVD VIDEO.

Displaying the subtitle DVDVideo DVDVR

If subtitles are recorded on the disc, you can change the subtitles or turn them on and off whenever you want while playing a DVD.

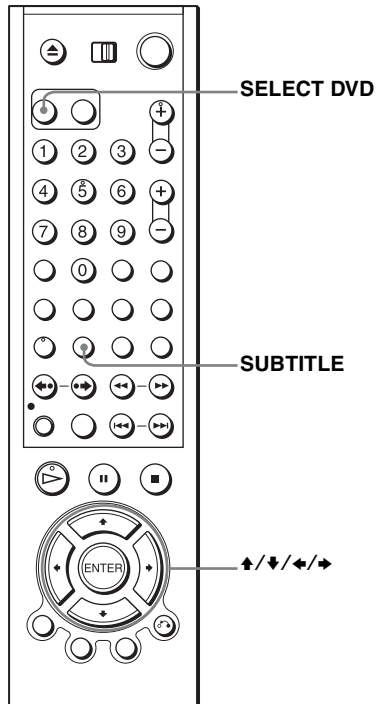

1  Press SELECT DVD to control the DVD player.

2  Press SUBTITLE during playback.

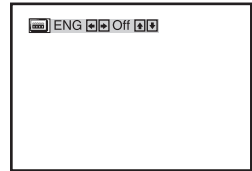

3  Press \leftarrow/\rightarrow repeatedly to select the language.
Depending on the DVD, the choice of language varies.
Refer to “DVD Audio/Subtitle Language” on page 100 for the abbreviation of the language.

continued

4



Press / repeatedly to select “On.”

To turn off the subtitles

Select “Off” in step 4.

Note

- Depending on the DVD, you may not be able to change the subtitles even if multilingual subtitles are recorded on it. You also may not be able to turn them off.

Various play mode functions (Program play, Shuffle play, Repeat play)

DVD_{Video} DVD_{VR} VCD CD DATA-CD DATA-DVD

Before you start...

- Set TV / DVD-VIDEO switch to DVD-VIDEO on the remote.

Note

- The play mode is canceled when:
 - you open the disc tray
 - the player enters standby mode by pressing I/O.

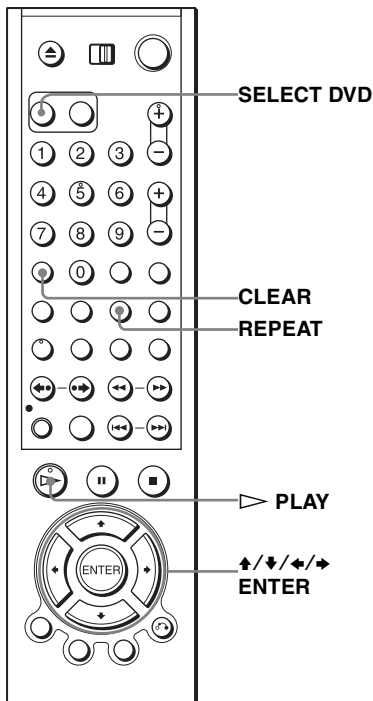

Creating your own program (Program play) CD

You can play the contents of a disc in the order you want by arranging the order of the tracks on the disc to create your own program. You can program up to 20 tracks.

To program MP3 audio tracks, see page 71.

- 1 Press SELECT DVD to control the DVD player.
- 2 Press REPEAT when the DVD player is in stop mode.

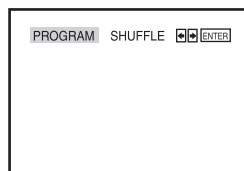

continued

3 Press \leftarrow/\rightarrow to select “PROGRAM”, then press ENTER.

PROGRAM									
Track					Program Order				
01	02	03	04		---	---	---	---	
05	06	07	08		---	---	---	---	
09	10	11	12		---	---	---	---	
13	14	15	16		---	---	---	---	
17	18	19	20		---	---	---	---	
Clear last track					Clear all tracks				
[Left] [Right] [Enter]					[ENTER] [RETURN] [CLEAR]				

4 Press $\uparrow/\downarrow/\leftarrow/\rightarrow$ to select the track number you want to program, then press ENTER.

PROGRAM									
Track					Program Order				
01	02	03	04		01	---	---	---	
05	06	07	08		---	---	---	---	
09	10	11	12		---	---	---	---	
13	14	15	16		---	---	---	---	
17	18	19	20		---	---	---	---	
Clear last track					Clear all tracks				
[Left] [Right] [Enter]					[ENTER] [RETURN] [CLEAR]				

5 To program other tracks, repeat step 4.

The programmed track numbers are displayed in the selected order.

6 Press \triangleright PLAY to start program play.

Program play starts.

When the program ends, you can restart the same program again by pressing \triangleright PLAY.

To stop program play

Press CLEAR until “Off” appears at the upper left top of the TV screen during programme play.

To change or cancel a program

1 Follow steps 1 to 3 of “Creating your own program (Program play).”

2 Press \downarrow repeatedly to select “Clear last track,” then press ENTER. Each time you press the button, the last programmed number is canceled. You can also cancel the last programmed number by pressing CLEAR.

3 Follow step 4 for new programming.

To cancel all the programmed numbers

1 Follow steps 1 to 3 of “Creating your own program (Program play).”

2 Press \downarrow repeatedly to select “Clear last track,” then press \rightarrow to select “Clear all tracks” and press ENTER.

All the programmed numbers are canceled.

Notes

- Up to 99 tracks can be displayed.
- You cannot repeat play while in program play.

Playing in random order (Shuffle play)

You can shuffle the playback order of tracks. Subsequent “shuffling” may produce a different playing order.

To shuffle MP3 audio tracks, see page 72.

- 1 Press SELECT DVD to control the DVD player.
- 2 Press REPEAT when the DVD player is in stop mode.

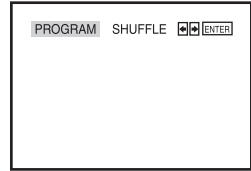

- 3 Press \leftarrow/\rightarrow to select “SHUFFLE”, then press ENTER.

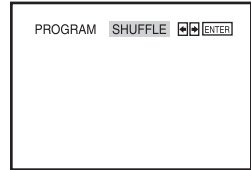

To return to normal play

Press CLEAR until “Off” appears at the upper left top of the TV screen during shuffle play.

Tip

- Shuffle play will stop when all the tracks are played back.

Note

- You cannot repeat play while in shuffle play.

Playing repeatedly (Repeat play) DVDVideo VCD CD DATA-CD DATA-DVD

You can play all of the titles or tracks on a disc or a single title, chapter, or track repeatedly.

1 Press SELECT DVD to control the DVD player.

2 Press REPEAT during playback.

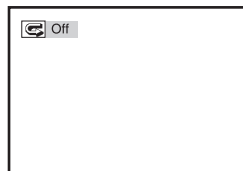

3 Press REPEAT or ◀/▶ repeatedly to select the item to be repeated.

When playing a DVD

- Chapter: repeats the current chapter.
- Title: repeats the current title on a disc.

When playing a VIDEO CD (with PBC function off) or CD

- Track: repeats the current track.
- Disc: repeats all of the tracks.

When playing a DATA CD/DATA DVD (MP3 audio)

- FILE: repeats the current track (file).
- DIR: repeats the current album (directory).
- DISC: repeats the current disc.

To return to normal play

Select “Off” in step 3 or press CLEAR during repeat play.

Tip

- When you press ■ STOP during repeat play, repeat play is canceled.

Notes

- You cannot repeat play with DVD-RW/DVD-R in VR mode.
- You cannot repeat play VIDEO CDs with PBC function on. See “Playing VIDEO CDs with “PBC ON/OFF” Functions” on page 79.
- You cannot repeat play while in program play or shuffle play.

Changing the sound

DVD_{Video}

DVD_{VR}

VCD

CD

When playing a DVD recorded in multiple audio formats (PCM, Dolby Digital, or DTS), you can change the audio format. If the DVD is recorded with multilingual tracks, you can also select the language.

With CDs or VIDEO CDs, you can select the sound from the right or left channel and listen to the sound of the selected channel through both the right and left speakers. For example, when playing a Karaoke VIDEO CD containing a song with the vocals on the right channel and the instruments on the left channel, you can hear the instruments from both speakers by selecting the left channel.

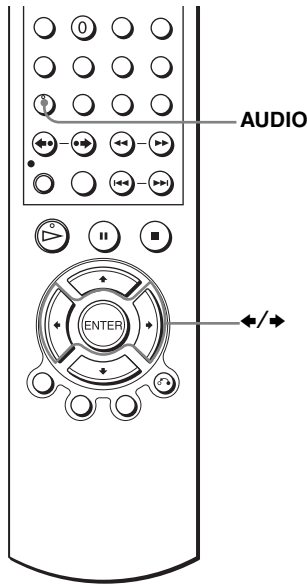

Disc type	Playback instruments only
Karaoke VIDEO CD	Yes
Karaoke DVD	No

1



Press AUDIO during playback.

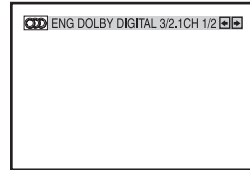

2



Press \leftarrow/\rightarrow repeatedly to select the desired language/audio setting.

- When playing a DVD
Depending on the DVD, the choice of language varies. Refer to “DVD Audio/Subtitle Language” on page 100 for the abbreviation of the language.
- When playing a VIDEO CD or CD
The default setting is indicated in bold print.

Stereo	The standard stereo sound
Left	The sound of the left channel (monaural)
Right	The sound of the right channel (monaural)

continued

Notes

- To enjoy Dolby Digital or DTS effect from a LinearPCM format disc, you have to make the connection using DIGITAL AUDIO OUT (COAXIAL) (page 22).
- When you play a DVD with DTS sound tracks, set “DTS” to “On” in “AUDIO SETUP” menu (page 44).
- If you set DTS audio output, you cannot select surround setting (page 67).
- You cannot perform playback quickly or slowly with sound when DTS audio output is set (page 27).

Virtual surround setting DVDVideo DVDVR VCD CD

When you connect a stereo TV or 2 front speakers, SURROUND lets you enjoy surround sound effects by using sound imaging to create virtual rear speakers from the sound of the front speakers without using actual rear speakers.

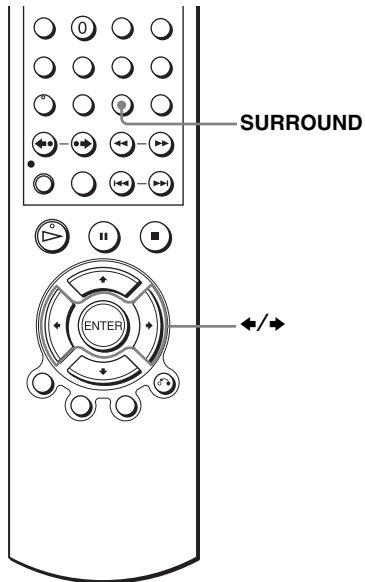

- 1** SURROUND Press SURROUND during playback.

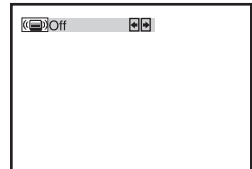

- 2** Press \leftarrow/\rightarrow repeatedly to select "Surround1," "Surround2," "Surround3." Surround effect increases as shown below.

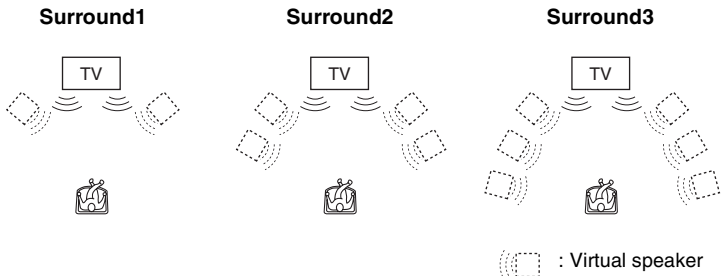

continued

To cancel the setting

Select “Off” in step 2.

Notes

- When the playing signal does not contain a signal for the rear speakers, the surround effects will be difficult to hear.
- When you activate the surround effect, turn off the surround setting of the connected TV or amplifier (receiver).
- Make sure that your listening position is between and at an equal distance from your speakers, and that the speakers are located in similar surroundings.
- You cannot perform playback quickly or slowly with sound when a virtual surround effect is set (page 27).

Playing an MP3 audio track DATA-CD DATA-DVD

You can play back DATA CDs (CD-ROMs/CD-Rs/CD-RWs) or DATA DVDs (DVD-ROMs/DVD+RWs/DVD+Rs/DVD-RWs/DVD-Rs) recorded in MP3 (MPEG1 Audio Layer III) format.

Before you start...

- Set TV / DVD-VIDEO switch to DVD-VIDEO on the remote.

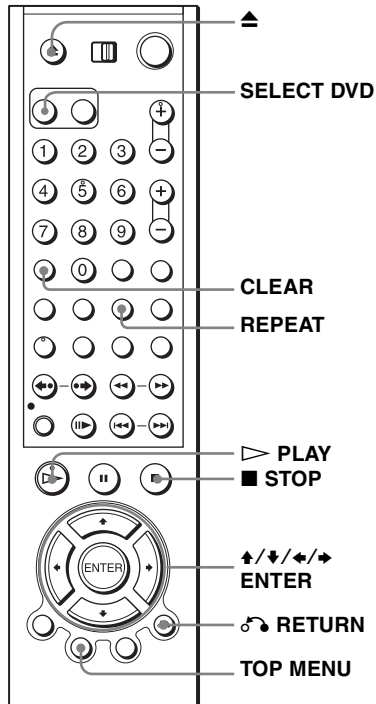

1 Press **SELECT DVD** to control the DVD player.

2 Press and place a DATA CD or DATA DVD on the disc tray, then press to close the tray.

When you load a DATA CD or DATA DVD which contains MP3 audio tracks and JPEG image files, "Select a Media Type" menu appears.

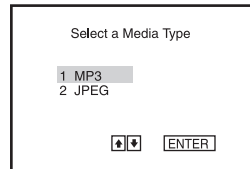

If you load a DATA CD or DATA DVD which contains only MP3 audio files, the MP3 display appears. Then you can skip step 3.

continued

3



Press \uparrow/\downarrow to select “MP3”, then press ENTER.

The first track starts playing. Press \blacksquare STOP if necessary.

Repeat mode
Elapsed playing time

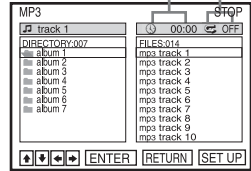

4



RETURN



Press \curvearrowright RETURN, then press \uparrow/\downarrow to select the desired directory in the left column, then press ENTER.

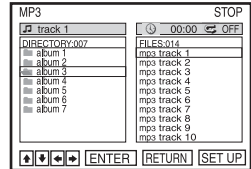

5



Press \uparrow/\downarrow to select the desired track in the right column, then press ENTER.

The selected track starts playing.

When a track or album is being played, the title is shown in a box. The playing track number appears on the display window.

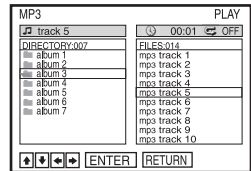

To stop play

Press \blacksquare STOP.

To repeat play

Press REPEAT repeatedly during playback to change the repeat mode.

- FILE: repeats the current track (file).
- DIR: repeats the current album (directory).
- DISC: repeats the current disc.

For details, see “Playing repeatedly (Repeat play)” (page 64).

To go to the next or previous page

Press \blacktriangleright or \blacktriangleleft .

To return to the previous display

Press \curvearrowleft RETURN.

To return to the “Select a Media Type” menu

Press \blacksquare STOP twice, then press TOP MENU.

To turn off the display

Press ■ STOP twice, then press ↻ RETURN repeatedly.

Notes

- Only the letters in the alphabet and numbers can be used for album or track names. Anything else is displayed as an asterisk.
- Up to 12 alphanumeric characters can be displayed for album or track names.
- ID3 tags cannot be displayed.
- You cannot repeat play while in program play or shuffle play.

To program MP3 audio tracks

1 Press ■ STOP twice, then press REPEAT.

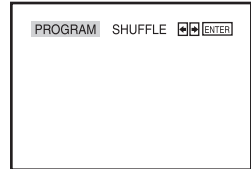

2 Press ←/→ to select "PROGRAM," then press ENTER.

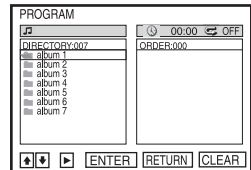

3 Press ▲/▼ to select the desired directory in the left column, then press ENTER.

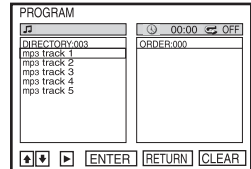

4 Press ▲/▼ to select the track you want to program, then press ENTER.

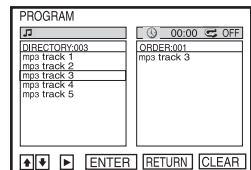

5 To program other tracks, repeat step 4.

The programmed tracks are displayed in the selected order. Press CLEAR to cancel the last programmed track.

6 Press ▷ PLAY to start program play.

Program play starts. When the program ends, you can restart the same program again by pressing ▷ PLAY.

continued

To stop program play

Press ■ STOP during program play.

To return to normal play

Press CLEAR during program play.

Notes

- Up to 20 tracks can be programmed at one time.
- You cannot repeat play while in program play.

To shuffle MP3 audio tracks

- 1 Press REPEAT when the MP3 is in stop mode.
- 2 Press ◀/▶ to select “SHUFFLE,” then press ENTER.

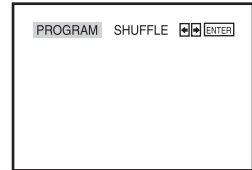

To return to normal play

Press CLEAR during shuffle play.

Tip

- Shuffle play will stop when all the tracks are played back.

Note

- You cannot repeat play while in shuffle play.

About MP3 audio tracks

You can play back DATA CDs (CD-ROMs/CD-Rs/CD-RWs) or DATA DVDs (DVD-ROMs/DVD+RWs/DVD+Rs/DVD-RWs/DVD-Rs) recorded in MP3 (MPEG-1 Audio Layer III) format. However, the discs must be recorded according to ISO9660 Level 1/Level 2 or Joliet format for the player to recognize the tracks (or files). You can also play DATA CDs or DATA DVDs recorded in Multi Session or Multi Border (see “Note on Multi Session/Border discs” on page 72).

Refer to the instructions supplied with the CD-R/CD-RW/DVD-R/DVD-RW drives and the recording software (not supplied) for details on the recording format.

Note on Multi Session/Border discs

If MP3 audio tracks are recorded in the first session/border, the player will also play MP3 audio tracks in other session/border. If audio tracks and images in Music CD format or Video CD format are recorded in the first session/border, only the first session/border will be played back.

Notes

- If you put the extension “.MP3” to data not in MP3 format, the player cannot recognize the data properly and will generate a loud noise which could damage your speaker system.
- The player cannot play audio tracks in MP3PRO format.
- The player may not be able to play some DATA CDs/DATA DVDs created in the Packet Write format.
- If both video data and MP3 audio tracks exist on a DATA DVD, the player recognizes only the video data.
- This player supports MP3 audio tracks recorded with a bit rate of 128 kbps and a sampling frequency of 44.1 kHz. Attempting to play MP3 audio tracks recorded with different specifications may result in loud noise, sound skipping or speaker damage.
- Depending on the disc contents, playback may take some time to start.

The Playback order of MP3 audio tracks

The playback order of albums and tracks recorded on a DATA CD or DATA DVD is as follows.

- Structure of disc contents

Tree 1 Tree 2 Tree 3 Tree 4 Tree 5

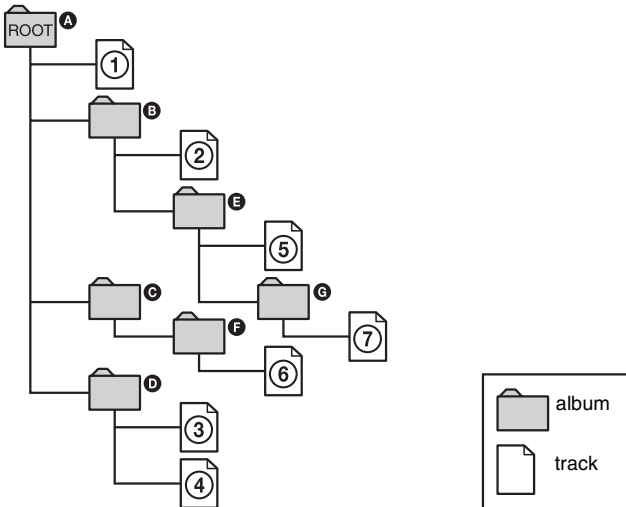

When you insert a DATA CD or DATA DVD and press \triangleright PLAY, the numbered tracks are played sequentially, from ① through ⑦. Any sub-albums/tracks contained within a currently selected album does not take priority over the next album in the same tree. (Example: **E** contains **G** but ⑥ is played before ⑦.)

When you press \curvearrowright RETURN and the list of MP3 albums appears (page 70), the albums are arranged in the following order: **A** \rightarrow **B** \rightarrow **D** \rightarrow **E** \rightarrow **F** \rightarrow **G**. Albums that do not contain tracks (such as album **C**) do not appear in the list.

continued

Tips

- If you add numbers (01, 02, 03, etc.) to the front of the track file names, the tracks will be played in that order.
- A disc with many trees takes longer to start playback. Some discs with many trees cannot be played back.

Notes

- Depending on the software you use to create the DATA CD or DATA DVD, the playback order may differ from the illustration above.
- No more than 250 albums can be recognized.
- A total of up to 999 files can be recognized for discs that contain both MP3 and JPEG files. Files are recognized in the order that they were recorded. For example, if 990 JPEG files are recorded then 100 MP3 files are recorded, the 990 JPEG files recorded first and only the first 9 MP3 files can be recognized.
- Depending on the disc contents, playback may take some time to start.

Playing JPEG image files DATA-CD DATA-DVD



You can play JPEG image files on DATA CDs (CD-ROMs/CD-Rs/CD-RWs) or DATA DVDs (DVD-ROMs/DVD+RWs/DVD+Rs/DVD-RWs/DVD-Rs).

Before you start...

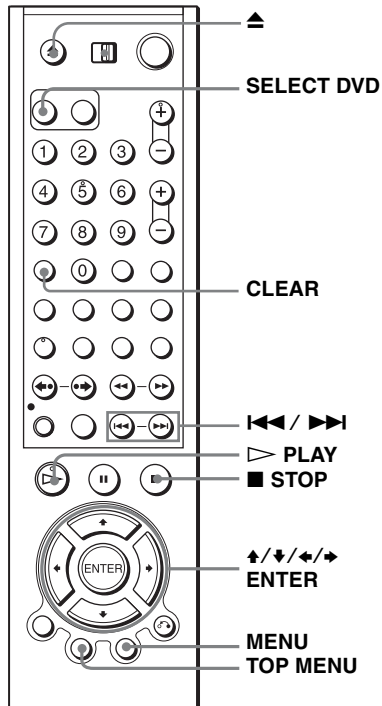
- Set **TV / DVD-VIDEO** switch to **DVD-VIDEO** on the remote.



1  Press **SELECT DVD** to control the DVD player.

2  Press  and place a DATA CD or DATA DVD on the disc tray, then press  to close the tray.

When you load a DATA CD or DATA DVD which contains MP3 audio tracks and JPEG image files, "Select a Media Type" menu appears.

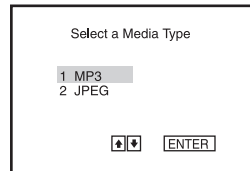

If you load a DATA CD or DATA DVD which contains only JPEG image files, the "Album" display appears. Then you can skip step 3.

continued

3



Press \uparrow/\downarrow to select “JPEG”, then press ENTER.

The “Album” display will appear.

If you do not press ENTER after selecting a media type, the selected media will be automatically played.

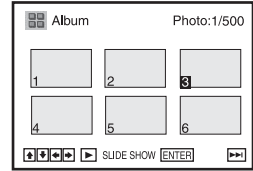

4



Press \leftarrow/\rightarrow to select the next/previous album page, then press $\uparrow/\downarrow/\leftarrow/\rightarrow$ to select an image in the “Album” display.



To display the selected image

1 Press ENTER.

The selected image number appears in the display window.

2 To display the next/previous image, press \leftarrow/\rightarrow .



PLAY



To play the Slide show

1 Press \triangleright PLAY.

You can also play the Slide show using the menu on the selected image.

For details, see “To enjoy the Slide show” on page 77.

2 Press \leftarrow/\rightarrow to select the desired playing speed on the “Interval” menu, then press ENTER.

Slide show starts from the selected image.

Fast

Normal

Slow



To rotate the selected image



1 Press $\uparrow/\downarrow/\leftarrow/\rightarrow$ to select an image in the “Album” display, then press ENTER.

2 Press \leftarrow/\rightarrow to select “”, then press ENTER.

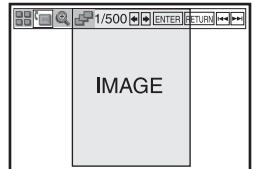
Each time you press ENTER, the image turns clockwise by 90°.



To zoom in an image

- 1 Press **▲/▼/◀/▶** to select an image in the “Album” display, then press ENTER.
- 2 Press **◀/▶** to select “”, then press ENTER.
“” appears.
- 3 Press **▲/▼/◀/▶** to move “” to the position where you want to zoom in.
- 4 Press ENTER repeatedly to change the magnification. Each time you press ENTER, the magnification changes as shown below.
2× → normal magnification

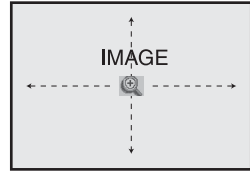

Note

- You cannot use ZOOM on the remote in JPEG image files on DATA CD/DATA DVD.

To enjoy the Slide show

- 1 Press **▲/▼/◀/▶** to select an image in the “Album” display, then press ENTER.
- 2 Press **◀/▶** to select “”, then press ENTER.
The “Interval” menu appears.
- 3 Press **◀/▶** to select the desired play speed, then press ENTER.
Slide show starts.



To turn on/off the menu in the single image display

Press CLEAR to turn off the menu. Press **◀** or **▶** to turn on the menu.



To return to the “Album” display

Press MENU to return to the “Album” display. Press **◀◀** repeatedly to return to the first “Album” page.

To return to the “Select a Media Type” menu

Press **■** STOP twice, then press TOP MENU.

Notes

- Slide show can play in only one direction.
- You cannot rotate or zoom in the image during Slide show.
- If you select “” in the rotated image display, the images in the “Album” display will not be rotated. But if you start the slide show, the images will be rotated. Correct the rotation in the “” menu.

continued

About JPEG image files

You can play back DATA CDs (CD-ROMs/CD-Rs/CD-RWs) or DATA DVDs (DVD-ROMs/DVD+RWs/DVD+Rs/DVD-RWs/DVD-Rs) recorded in JPEG format. However, the discs must be recorded according to ISO9660 Level 1/Level 2 or Joliet format for the player to recognize the tracks (or files). You can also play DATA CDs or DATA DVDs recorded in Multi Session or Multi Border (see “Note on Multi Session/Border discs” on page 78).

Refer to the instructions supplied with the CD-R/CD-RW/DVD-R/DVD-RW drives and the recording software (not supplied) for details on the recording format.

Notes

- If both video data and JPEG image files exist on a DATA DVD, the player recognizes only the video data.
- No more than 250 folders can be recognized.
- A total of up to 999 files can be recognized for discs that contain both MP3 and JPEG files. Files are recognized in the order that they were recorded. For example, if 990 JPEG files are recorded then 100 MP3 files are recorded, the 990 JPEG files recorded first and only the first 9 MP3 files can be recognized.

Note on Multi Session/Border discs

If JPEG image files are recorded in the first session/border, the player will also play JPEG image files in other session/border. If audio tracks and images in Music CD format or Video CD format are recorded in the first session/border, only the first session/border will be played back.

Tip

- If you add numbers (01, 02, 03, etc.) to the front of the file names, the files will be played in that order.

Notes

- This player can play JPEG image files with the extension “.JPEG” or “.JPG.”
- Some DATA CDs or DATA DVDs cannot be played on this system depending on file format.
- The player may not be able to play some DATA CDs/DATA DVDs created in the Packet Write format.
- If you add the extension “.JPG” or “.JPEG” to data not in JPEG format, “Can not Display” will appear.
- Depending on the disc or the size of image files, playback may take some time to start.
- Progressive and lossless compression JPEG image files are not supported.
- The image size that can be displayed is limited. You can display the following images; width 128 - 7680 pixels by height 128 - 7680 pixels.

Playing VIDEO CDs with “PBC ON/OFF” Functions **VCD**

The PBC (Playback control) function allows you to search and perform other operations interactively. PBC playback follows a selection menu displayed on your TV screen.

Before you start...

- Set **TV / DVD-VIDEO** switch to **DVD-VIDEO** on the remote.

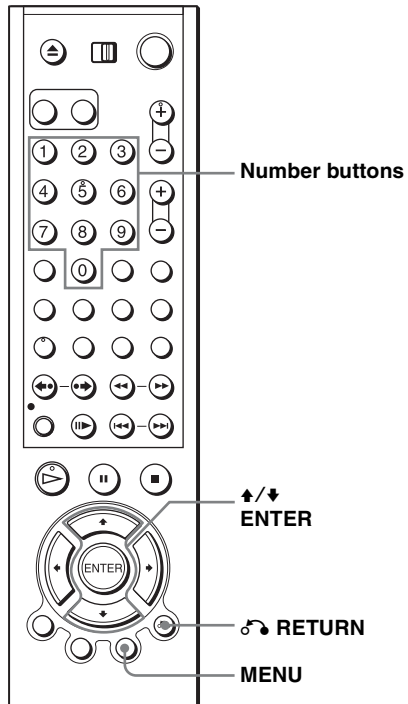

1  Press **MENU** to select “PBC ON.”
The menu for your selection appears.

2  Press **↑/↓** to select the item number you want.
You can also use the number buttons to select the item number and track.

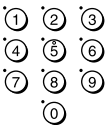

continued

3



Press ENTER.

4

Follow the instructions in the menu for interactive operations.

Refer to the instructions supplied with the disc, as the operating procedure may differ depending on the VIDEO CD.

To return to the menu

Press  RETURN.

To play using “PBC OFF”

Press MENU to select “PBC OFF.”

When “PBC OFF” is selected, the DVD player starts continuous play. You cannot play still pictures such as a menu.

To return to “PBC ON,” press MENU to select “PBC ON.”

Note

- Depending on the VIDEO CD, “Press ENTER” in step 3 may appear as “Press SELECT” in the instructions supplied with the disc. In this case, press  PLAY.

Quick Timer Recording **VHS**

After you have started recording, you can have the VCR stop recording automatically after a specified duration.

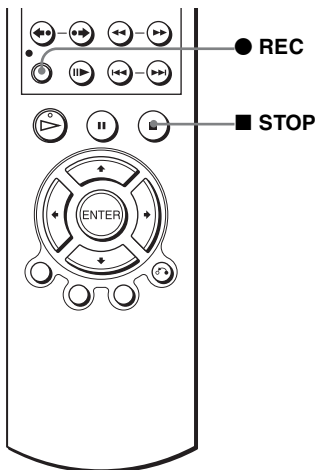

1 While recording, press ● REC.



2 Press ● REC repeatedly to set the duration time.

Each press advances the time as follows.

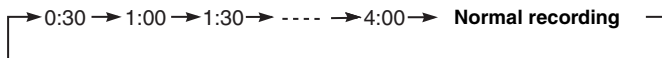

The tape counter decreases minute by minute to 0:00, then the VCR stops recording.

To extend the duration

Press ● REC repeatedly to set a new duration time.

To cancel the duration

Press ● REC repeatedly until the ⊖ indicator disappears and the VCR returns to normal recording mode.

To stop while recording

Press ■ STOP.

Note

- You cannot display the current tape time in the display window when setting the recording duration time.

Searching using various functions **VHS**

The VCR automatically marks the tape with an index signal at the point where each recording begins.

You can easily find a specific point using various search functions.

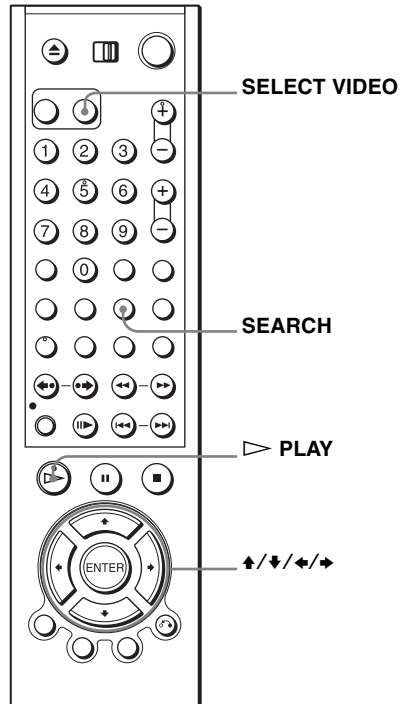

1 **SELECT VIDEO** Press SELECT VIDEO to control the VCR.

2 Insert an indexed tape into the VCR.

3 **REPEAT/SEARCH** Press SEARCH.

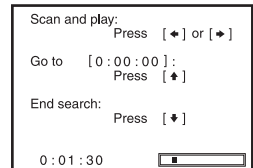

4



- Scan and Play (To search using the index function):
 - 1 Press **▶** to scan ahead, or **◀** to scan backwards.
The VCR searches and then plays back for about five seconds.

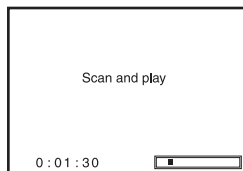

- 2 Press **▷** PLAY to view the program.
If you do not press **▷** PLAY, the VCR automatically searches for the next index mark, or until it reaches the end of the tape.

- Go to [0:00:00] (To search for the counter 0:00:00 point):

Press **▲**.

The VCR starts searching and automatically stops at the 0:00:00 point.

To mark a point on the tape that you want to find later, press CLEAR to reset the tape counter to "0:00:00."

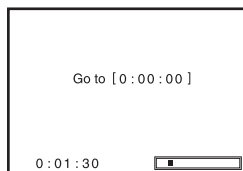

- End search (To search for a blank portion of the tape)

Press **▼**.

The VCR starts searching and automatically stops at the beginning of a blank space. If no blank space is found, the VCR reaches the end.

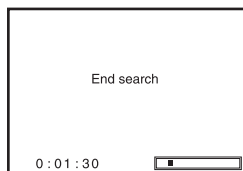

To stop searching

Press **■** STOP.

Note

- Once in recording mode, if the VCR is put in pause and then released to start the recording, no index mark will be inserted. An index mark will be inserted if the channel is changed while VCR is put in pause.

Editing with another VCR **VHS**

How to connect to record on this VCR

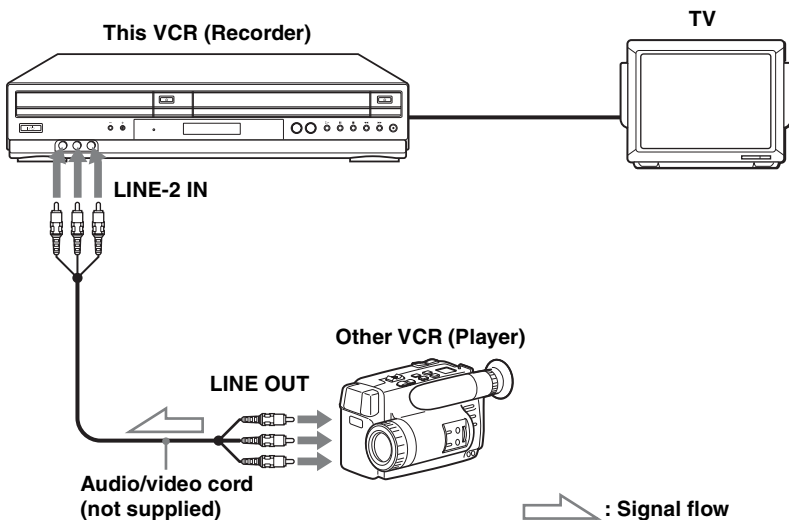

Notes

- Make sure you connect the plugs to jacks of the same color.
- If the other VCR is a monaural type and connected to this VCR's LINE-2 IN jacks, connect the audio plug to the AUDIO L (white) jack. The sound is recorded on both right and left channels. If you connect to the AUDIO R (red) jack, the sound is recorded only on the right channel.
- If you connected this VCR to both the LINE IN and LINE OUT jacks of the other VCR, select the input correctly to prevent a humming noise.
- You can use the LINE IN 1 jacks for editing. If the other VCR is a monaural type the sound is recorded only on the channel whose jack is connected to the audio plug. To record on both right and left channels, connect the audio plugs to the AUDIO L/R jacks using an audio/video cord (not supplied).

Operation (when recording on this VCR)

Before you start editing

- Turn on the VCR and the TV and set it to the video channel.
- Press INPUT SELECT to display “L1” or “L2” in the display window.
- Press SP/EP to select the tape speed, SP or EP.

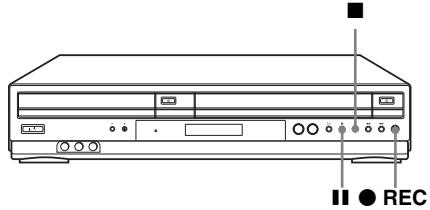

- 1** Insert a source tape with its safety tab removed into the other (playback) VCR. Search for the point to start playback and set it to playback pause.
- 2** Insert a tape into this (recording) VCR. Search for the point to start recording and press **||**.
- 3** Press **●** REC on this VCR to set it to recording pause.
- 4** To start editing, press the **||** (pause) buttons on both VCRs at the same time.

To stop editing

Press the **■** (stop) buttons on both VCRs.

Tip

- To cut out unwanted scenes while editing, press **||** on this VCR when an unwanted scene begins. When it ends, press **||** again to resume recording.

Changing menu options

You can set the auto power off function or change the tape length, auto play and auto repeat settings. Normally the default settings are used. Change these settings if necessary.

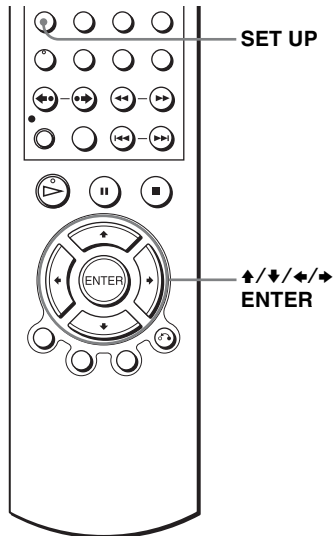

Before you start...

- Set TV / DVD-VIDEO switch to DVD-VIDEO on the remote.

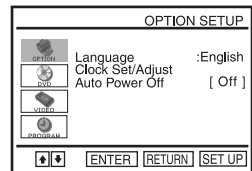

1  Press SET UP when the DVD player is in stop mode.



2  Press  (OPTION) or  (VIDEO) and press ENTER. The "OPTION SETUP" menu or "VIDEO FUNCTION SETUP" menu appears.

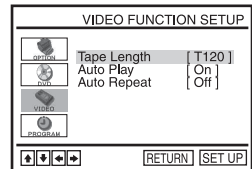
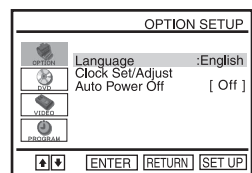

3

Press **↑/↓** to select the item to change, then press **←/→** to make the setting.
For details about each setup item, see “Menu choices” below.

4

SET UP



Press SET UP to exit the menu.

Menu choices

The default settings are indicated in bold print.

OPTION SETUP

For details about menu option “Language” and “Clock Set/Adjust”, see “Selecting a language” on page 18 or “Setting the clock” on page 19.

Menu option	Set this option to
Auto Power Off	<ul style="list-style-type: none"> • Off to deactivate the Auto Power Off function. • 1Hr/2Hr to turn the DVD-VCR off automatically if no signal is received and you do not press any of the buttons during this time.

VIDEO FUNCTION SETUP

Menu option	Set this option to
Tape Length	<ul style="list-style-type: none"> • T-120 when using a T-120 or shorter length tape. • T-160 when using a T-160 length tape. • T-180 when using a T-180 or longer length tape.
Auto Play	<ul style="list-style-type: none"> • On to start playback automatically, when you insert a tape with its safety tab removed. • Off to turn off Auto play. You need to press ▷ PLAY to start playback, even if you insert a tape with its safety tab removed.
Auto Repeat	<ul style="list-style-type: none"> • On to play back a tape repeatedly. The VCR rewinds a tape to the beginning and restarts playback automatically. • Off to turn off Auto repeat.

Troubleshooting

If you have any questions or problems not covered below, please consult your nearest Sony dealer. (see “For customers in USA” on the front cover)

General Troubleshooting

	Symptom	Remedy
Power	The I/⏻ switch does not function.	<ul style="list-style-type: none"> • Connect the AC power cord securely.
	The power is turned on but the DVD-VCR does not operate.	<ul style="list-style-type: none"> • Moisture condensation has occurred. Turn the power off, unplug the AC power cord and leave the DVD-VCR to dry for over three hours.
Clock	The clock has stopped and “-- : --” appears in the display window.	<ul style="list-style-type: none"> • The clock stops if the DVD-VCR is disconnected from the wall outlet. Reset the clock (and timer).
Others	The remote commander does not function.	<ul style="list-style-type: none"> • Make sure you are pointing the remote commander at the remote sensor on the DVD-VCR. • Replace all the batteries in the remote commander with new ones if they are weak. • Make sure the TV / DVD-VIDEO switch is set correctly. • Select DVD or VIDEO mode correctly with the SELECT DVD/VIDEO button.
	Buttons on the unit does not function.	<ul style="list-style-type: none"> • Select DVD or VIDEO mode correctly with the SELECT DVD/VIDEO button.
	The tracking meter does not appear on the screen.	<ul style="list-style-type: none"> • The recording condition of the tape is very poor and tracking cannot be adjusted.
	You cannot control other TVs.	<ul style="list-style-type: none"> • Set your TV's code number. The code number may change when you replace the batteries of the remote commander.

DVD Troubleshooting

	Symptom	Remedy
Picture	There is no picture/picture noise appears.	<ul style="list-style-type: none"> • Re-connect the connecting cord securely. • The connecting cords are damaged. • Check the connection to your TV (page 14) and switch the input selector on your TV so that the signal from the player appears on the TV screen. • The disc is dirty or flawed. • You have set the player to progressive format (the PROGRESSIVE indicator lights up in orange) even though your TV cannot accept the progressive signal. In this case, set “Progressive” to “Off” (page 48). • Even if your TV is compatible with progressive format (480p) signals, the image may be affected when you set the player to progressive format. In this case, set “Progressive” to “Off” and the player is set to normal (interlace) format (page 48). • COMPONENT VIDEO OUT jack is not used or “Progressive” of the “SCREEN SETUP” menu is not set correctly while the PROGRESSIVE indicator lights up in orange. Check the setting (page 46) and connection (page 21).
	The Playback does not start/buttons on the remote and unit does not function.	<ul style="list-style-type: none"> • Make sure the TV / DVD.VIDEOQ switch is set correctly. • Select DVD or VIDEO mode correctly with the SELECT DVD/VIDEO button.
	Even though you set the aspect ratio in “TV Type” of the “SCREEN SETUP” menu the picture does not fill the screen.	<ul style="list-style-type: none"> • The aspect ratio of the disc is fixed on your DVD.
	There is no picture from your VCR connected to the LINE IN jacks.	<ul style="list-style-type: none"> • The DVD player must be in standby mode to view pictures from your VCR.
Sound	There is no sound.	<ul style="list-style-type: none"> • Re-connect the connecting cord securely. • The connecting cord is damaged. • The player is connected to the wrong input jack on the amplifier (receiver) (page 15). • The amplifier (receiver) input is not correctly set. • The player is in pause mode or in Slow-motion Play mode. • The player is in fast forward or fast reverse mode. • If the audio signal does not come through the DIGITAL AUDIO OUT (COAXIAL) jack, check the audio settings (page 44).
	Sound is noisy.	<ul style="list-style-type: none"> • When playing a CD with DTS sound tracks, noise will come from the LINE OUT L/R (AUDIO) jacks (page 27) or DIGITAL AUDIO OUT (COAXIAL) jack.
	The sound volume is low.	<ul style="list-style-type: none"> • The sound volume is low on some DVDs. The sound volume may improve if you set “Audio DRC” to “Wide Range” (page 45).

continued

	Symptom	Remedy
Operation	The disc does not play.	<ul style="list-style-type: none"> The disc is turned over. Insert the disc with the playback side facing down on the disc tray. The disc is skewed. The player cannot play certain discs (page 7). The region code on the DVD does not match the player. Moisture has condensed inside the player (page 3). The player cannot play a recorded disc that is not correctly finalized (page 8). Make sure the <u>TV / DVD-VIDEO</u> switch is set correctly. Select correctly VIDEO or DVD with SELECT DVD/VIDEO button.
	The MP3 audio track cannot be played (page 69).	<ul style="list-style-type: none"> The DATA CD or DATA DVD is not recorded in the MP3 format that conforms to ISO9660 Level 1/Level 2 or UDF. The MP3 audio track does not have the extension “.MP3”. The data is not formatted in MP3 even though it has the extension “.MP3”. The data is not MPEG1 Audio Layer III data. The player cannot play audio tracks in MP3PRO format.
	The JPEG image file cannot be played.	<ul style="list-style-type: none"> The DATA CD or DATA DVD is not recorded in JPEG format that conforms to ISO9660 Level 1/Level 2 or UDF. The JPEG image file does not have the extension “.JPG” or “.JPEG”. The data is not formatted in JPEG even though it has the extension “.JPG” or “.JPEG”.
	The title of the MP3 audio album/ track or JPEG image album/file is not correctly displayed.	<ul style="list-style-type: none"> The player can only display numbers and alphabet. Other characters are displayed as asterisks.
	The disc does not start playing from the beginning.	<ul style="list-style-type: none"> Program play, shuffle play, or repeat play, has been selected (pages 61, 63, 64). Resume play has taken effect (page 27).
	The player starts playing the disc automatically.	<ul style="list-style-type: none"> The disc features an auto playback function.
	Playback stops automatically.	<ul style="list-style-type: none"> While playing discs with an auto pause signal, the player stops playback at the auto pause signal.
	You cannot perform some functions such as stop, search, slow-motion play, repeat play, shuffle play, or program play.	<ul style="list-style-type: none"> Depending on the disc, you may not be able to do some operations. See the operating manual that comes with the disc.
	The language for the sound track cannot be changed.	<ul style="list-style-type: none"> Try using the DVD’s menu instead of the direct selection button on the remote (page 55). Multilingual tracks are not recorded on the DVD being played. The DVD prohibits the changing of the language for the sound track.

	Symptom	Remedy
Operation	The subtitle language cannot be changed or turned off.	<ul style="list-style-type: none"> • Try using the DVD's menu instead of the direct selection button on the remote (page 55). • Multilingual subtitles are not recorded on the DVD being played. • The DVD prohibits the changing of the subtitles.
	The angles cannot be changed.	<ul style="list-style-type: none"> • Try using the DVD's menu instead of the direct selection button on the remote (page 55). • Multi-angles are not recorded on the DVD being played. • The DVD prohibits changing of the angles.
	The player does not operate properly.	<ul style="list-style-type: none"> • When static electricity, etc., causes the player to operate abnormally, unplug the player.

VCR Troubleshooting

	Symptom	Remedy
Playback	The playback picture does not appear on the TV screen.	<ul style="list-style-type: none"> • Make sure the TV is set to the channel for the VCR. If you are using a monitor, set it to video input. • The signal from the VCR will not be output when you make the connection using COMPONENT VIDEO OUT jacks. Make the connection using LINE OUT (Yellow, White, Red) jacks (page 15).
	The Playback does not start/buttons on the remote and unit does not function.	<ul style="list-style-type: none"> • Make sure the TV / DVD-VIDEO switch is set correctly. • Select DVD or VIDEO mode correctly with the SELECT DVD/VIDEO button.
	The picture is not clear.	<ul style="list-style-type: none"> • Adjust the tracking with the TRACKING +/- buttons. • The video heads are dirty (see "On cleaning the video heads" (page 3)). Clean the video heads using a Sony video head cleaning cassette. If a Sony cleaning cassette is not available in your area, have the heads cleaned at your nearest Sony dealer (a standard service fee will be charged). Do not use a commercially available liquid type cleaning cassette, as it may damage the video heads. • The video heads may have to be replaced. Consult your local Sony dealer for more information.
	The picture rolls vertically during picture search.	<ul style="list-style-type: none"> • Adjust the vertical hold control on the TV or monitor.
	The picture has no sound.	<ul style="list-style-type: none"> • The tape is defective. • Check the audio cord connection. • The signal from the VCR will not be output when you make the connection using a DIGITAL AUDIO OUT (COAXIAL) jack. Make the connection using LINE OUT (Yellow, White, Red) jacks (page 15).

continued

	Symptom	Remedy
Recording	The picture from a connected cable box or satellite receiver does not appear on the TV screen.	<ul style="list-style-type: none"> • Make sure the TV or monitor is set to video input. • Select the correct line input (L1 or L2) which the cable box or satellite receiver is connected with the INPUT SELECT button.
	The tape starts playing as soon as it is inserted.	<ul style="list-style-type: none"> • The safety tab has been removed. To record on this tape, cover the tab hole.
	The tape is ejected when you press ● REC.	<ul style="list-style-type: none"> • Check that the safety tab has not been removed.
	Nothing happens when you press ● REC.	<ul style="list-style-type: none"> • Make sure the tape is not at its end.
Timer recording	The timer does not operate.	<ul style="list-style-type: none"> • Check that the clock is set. • Make sure a tape has been inserted. • Check that the safety tab has not been removed. • Make sure the tape is not at its end. • Make sure a program has been set for timer recording. • Make sure your timer settings are past the current time. • Check that the cable box or satellite receiver is turned on. • The clock stops if the DVD-VCR is disconnected from the wall outlet for more than one minute. Reset the clock and timer. • Turn the power off and unplug the AC power cord.
Others	A tape cannot be inserted.	<ul style="list-style-type: none"> • Check that a tape is not already in the tape compartment.
	Control by AV mouse is not possible.	<ul style="list-style-type: none"> • The unit is not compatible with satellite TV receiver AV mouse, etc.

Glossary

Chapter (page 28)

Sections of a picture or a music feature that are smaller than titles. A title is composed of several chapters. Depending on the disc, no chapters may be recorded.

Dolby Digital (pages 22 and 45)

Digital audio compression technology developed by Dolby Laboratories. This technology conforms to 5.1-channel surround sound. The rear channel is stereo and there is a discrete subwoofer channel in this format. Dolby Digital provides the same 5.1 discrete channels of high quality digital audio found in Dolby Digital cinema audio systems. Good channel separation is realized because all of the channel data are recorded discretely and little deterioration is realized because all channel data processing is digital.

Dolby Surround (page 23)

Audio signal processing technology that Dolby Laboratories developed for surround sound. When the input signal contains a surround component, the process outputs the front, center and rear signals. The rear channel is monaural.

DTS (page 45)

Digital audio compression technology that DTS, Inc. developed. This technology conforms to 5.1-channel surround sound. The rear channel is stereo and there is a discrete subwoofer channel in this format. DTS provides the same 5.1 discrete channels of high quality digital audio. Good channel separation is realized because all of the channel data is recorded discretely and little deterioration is realized because all channel data processing is digital.

DVD (page 7)

A disc that contains up to 8 hours of moving pictures even though its diameter is the same as a CD.

The data capacity of a single-layer and single-sided DVD is 4.7 GB (Giga Byte), which is 7 times that of a CD. The data capacity of a double-layer and single-sided DVD is 8.5 GB, a single-layer and double-sided DVD is 9.4 GB, and double-layer and double-sided DVD is 17GB.

The picture data uses the MPEG 2 format, one of the worldwide standards of digital compression technology. The picture data is compressed to about 1/40 (average) of its original size. The DVD also uses a variable rate coding technology that changes the data to be allocated according to the status of the picture. Audio information is recorded in a multi-channel format, such as Dolby Digital, allowing you to enjoy a more real audio presence.

Furthermore, various advanced functions such as the multi-angle, multilingual, and Parental Control functions are provided with the DVD.

DVD+R (page 7)

A DVD+R (read "plus R") is a recordable disc that is the same size as a DVD VIDEO. Contents can be recorded only once to a DVD+R, and will have the same format as a DVD VIDEO.

DVD-R (page 7)

A DVD-R is a recordable disc that is the same size as a DVD VIDEO. Contents can be recorded only once to a DVD-R, and will have the same format as a DVD VIDEO. The DVD-R has two different modes: VR mode and Video mode. DVDs created in Video mode have the same format as a DVD VIDEO, while discs created in VR (Video Recording) mode allow the contents to be programmed or edited.

continued

DVD-RW (page 7)

A DVD-RW is a recordable and rewritable disc that is the same size as a DVD VIDEO. The DVD-RW has two different modes: VR mode and Video mode. DVD-RWs created in Video mode have the same format as a DVD VIDEO, while discs created in VR (Video Recording) mode allow the contents to be programmed or edited.

DVD+RW (page 7)

A DVD+RW (plus RW) is a recordable and rewritable disc. DVD+RWs use a recording format that is comparable to the DVD VIDEO format.

Interlace format

Interlace format shows every other line of an image as a single “field” and is the standard method for displaying images on television. The even number field shows the even numbered lines of an image, and the odd numbered field shows the odd numbered lines of an image.

Progressive format (pages 21 and 48)

Compared to the Interlace format that alternately shows every other line of an image (field) to create one frame, the Progressive format shows the entire image at once as a single frame. This means that while the Interlace format can show 30 frames/60 fields in one second, the Progressive format can show 60 frames in one second. The overall picture quality increases and still images, text, and horizontal lines appear sharper. This player is compatible with the 480 progressive format.

Title (page 28)

The longest section of a picture or music feature on a DVD, movie, etc., in video software, or the entire album in audio software.

Track (page 28)

Sections of a picture or a music feature on a CD or VIDEO CD (the length of a song).

Specifications

System

- Laser
 - Semiconductor laser
- Format
 - VHS NTSC standard
- Video recording system
 - Rotary head helical scanning FM system
- Video heads
 - Double azimuth four heads
- Video signal
 - NTSC color, EIA standards
- Tape speed
 - SP: 33.35 mm/s (1 $\frac{3}{8}$ inches/s)
 - EP: 11.12 mm/s ($\frac{7}{16}$ inches/s)
 - LP: 16.67 mm/s (1 $\frac{1}{16}$ inches/s), playback only
- Maximum recording/playback time
 - 8 hrs. in EP mode (with T-160 tape)
- Rewind time
 - Approx. 2 min (with T-120 tape)

Inputs and outputs

- LINE IN 1 and LINE-2 IN
 - VIDEO IN, phono jack (1 each)
 - Input signal: 1 Vp-p, 75 ohms, unbalanced, sync negative
 - AUDIO IN, phono jacks (2 each)
 - Input level: 327 mVrms
 - Input impedance: more than 47 kilohms
- LINE OUT
 - VIDEO OUT, phono jack (1)
 - Output signal: 1 Vp-p, 75 ohms, unbalanced, sync negative
 - AUDIO OUT, phono jacks (2)
 - Standard output: 327 mVrms
 - Load impedance: 47 kilohms
 - Output impedance: less than 10 kilohms
- DIGITAL OUT
 - COAXIAL, phono jack
 - Output signal: 0.5 Vp-p, 75 ohms
- COMPONENT VIDEO OUT (Y, Pb, Pr)
 - Phono jack
 - Y: 1.0 Vp-p/Pb, Pr: 0.7 Vp-p, 75 ohms

Timer section

- Clock
 - Quartz locked
- Timer indication
 - 12-hour cycle
- Timer setting
 - 8 programs (max.)

General

- Power requirements
 - 120 V AC, 60 Hz
- Power consumption
 - 25 W
- Power back-up
 - Back-up duration: 0 min
- Operating temperature
 - 5°C to 40°C (41°F to 104°F)
- Storage temperature
 - 20°C to 60°C (-4°F to 140°F)
- Operating humidity
 - 25% to 80%
- Dimensions including projecting parts and controls (w/h/d)
 - Approx. 430 × 85 × 287 mm
 - (Approx. 17 × 3 $\frac{3}{8}$ × 11 $\frac{3}{8}$ inches)
- Mass
 - Approx. 3.5 kg (Approx. 7.7 lbs)

Supplied accessories

- Remote commander (1)
- Size AA (R6) batteries (2)
- Audio/video cord (1)

Design and specifications are subject to change without notice.

Index to parts and controls

Refer to the pages indicated in parentheses () for details.

Front panel

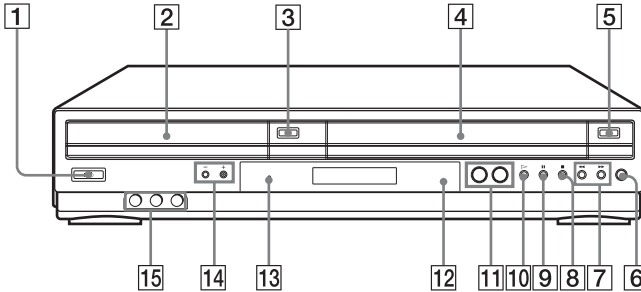

1 I/⏻ POWER (on/standby) switch (27) (32)

2 Disc tray (24)

3 ≡ (open/close) button (24) (26)

4 Tape compartment (31)

5 ≡ (eject) button (32)

6 ● REC (record) button (36)

7 ◀◀ (rewind)/▶▶ (fast-forward) button (26) (32)

8 ■ (stop) button (25) (32)

9 ⏸ (pause) button (25) (32)

10 ▷ (play) button (25) (31)

11 SELECT DVD/VIDEO buttons (11)

12 📡 Remote sensor (11)

13 PROGRESSIVE indicator (48)

14 TRACKING +/- buttons* (34)

15 LINE-2 IN VIDEO/AUDIO L (MONO)/R jacks (84)

* TRACKING + button have a tactile dot. Use the tactile dot as a reference.

Display window

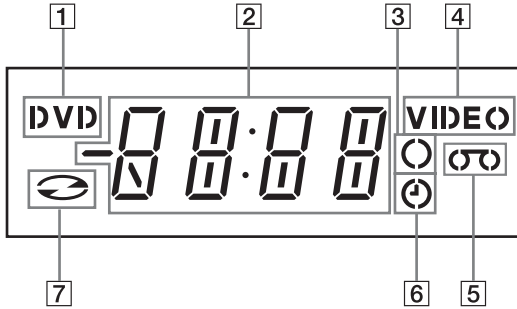

- | | |
|--|-------------------------------|
| 1 DVD indicator (25) | 4 VIDEO indicator (31) |
| 2 Playing time/clock/current status indicator (25) (31) | 5 Tape indicator (31) |
| 3 Record indicator (36) | 6 Timer indicator (39) |
| | 7 Disc indicator (25) |

Rear panel

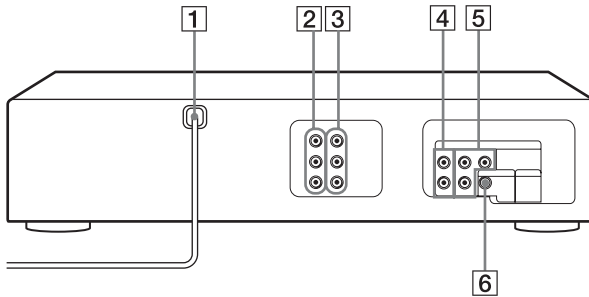

DVD player and VCR

- | |
|---|
| 1 AC power cord (14) (17) |
| 2 LINE IN 1 VIDEO/AUDIO L/R jacks (84) |
| 3 LINE OUT VIDEO/AUDIO L/R jacks (15) |

DVD player only

- | |
|---|
| 4 LINE OUT AUDIO L/R jacks (21) |
| 5 COMPONENT VIDEO OUT Pr/Pb/Y jacks (21) |
| 6 DIGITAL AUDIO OUT (COAXIAL) jack (23) |

Remote commander for DVD

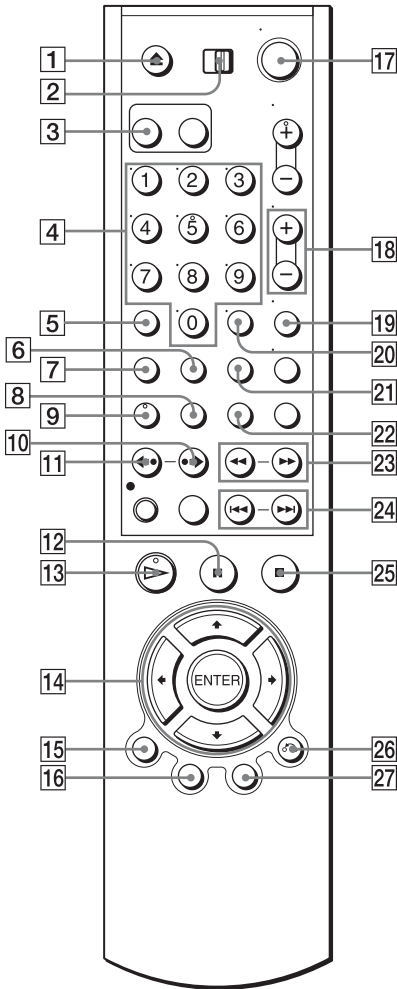

- 7 SET UP button (18)
- 8 SUBTITLE button (59)
- 9 AUDIO button* (65)
- 10 ➡ SKIP button (25)
- 11 ◀◀ REPLAY button (25)
- 12 ■ PAUSE button (25)
- 13 ▷ PLAY button* (25)
- 14 ⬆/⬇/⬅/➡ buttons (18)
ENTER button (18)
- 15 DISPLAY button (29)
- 16 TOP MENU button (55)
- 17 I/O (on/standby) switch (12) (27)
- 18 VOL (volume) +/- buttons (12)
- 19 ZOOM button (56)
- 20 ENTER button (18)
- 21 REPEAT button (61)
- 22 SURROUND button (67)
- 23 ◀◀ ◀◀/▶▶ ▶▶ buttons (25)
- 24 ◀◀◀◀ PREV (previous)/▶▶▶▶ NEXT button (25)
- 25 ■ STOP button (25)
- 26 ↻ RETURN button (28)
- 27 MENU button (55)

- 1 ▲ (open/close) button (24) (26)
- 2 TV / DVD-VIDEO switch (11)
- 3 SELECT DVD button (11)
- 4 Number buttons* (29) (52)
- 5 CLEAR button (62)
- 6 ANGLE button (57)

* Number 5, AUDIO and ▷ PLAY buttons have a tactile dot. Use the tactile dot as a reference.

Remote commander for VIDEO

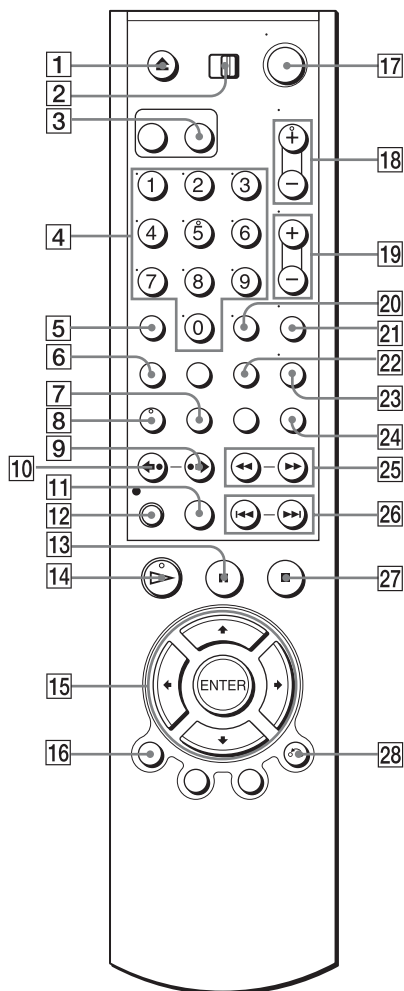

- 1 ▲ (eject) button (32)
- 2 TV / DVD-VIDEO switch (11)
- 3 SELECT VIDEO button (11)
- 4 Number buttons* (12)
- 5 CLEAR button (33) (39)
- 6 SET UP button (18)

- 7 TIMER button (38)
- 8 AUDIO button* (35)
- 9 ●▶ SKIP button (32)
- 10 ◀● REPLAY button (32)
- 11 SP (Standard Play)/EP (Extended Play) button (36)
- 12 ● REC (record) button (36)
- 13 ■ PAUSE button (32)
- 14 ▷ PLAY button* (31)
- 15 ▲/▼/◀/▶ buttons (18)
ENTER button (18)
- 16 DISPLAY button (33)
- 17 I/O (on/standby) switch (12) (32)
- 18 CH (channel)/TRACKING +/- buttons* (12) (34)
- 19 VOL (volume) +/- buttons (12)
- 20 ENTER button (18)
- 21 MUTING button (12)
- 22 SEARCH button (82)
- 23 TV/VIDEO button (12)
- 24 INPUT SELECT button (35)
- 25 ◀◀ (rewind)/▶▶ (fast-forward)/▶ (slow) buttons (32)
- 26 ◀◀/▶▶ SHUTTLE button (32)
- 27 ■ STOP button (32)
- 28 ↻ RETURN button (38)

* Number 5, AUDIO, ▷ PLAY and CH/TRACKING + buttons have a tactile dot. Use the tactile dot as a reference.

DVD Audio/Subtitle Language

Abbreviation	Language
ARA	Arabic
BUL	Bulgarian
CHI	Chinese
CRO	Croatian
CZE	Czech
DAN	Danish
DEU	German
ENG	English
ESP	Spanish
FIN	Finish
FRA	French
GRE	Greek
HUN	Hungarian
IDN	Indonesian
IND	Hindi
ISL	Icelandic
ITA	Italian
IWR	Hebrew
JPN	Japanese
KOR	Korean
MAL	Malay
NLD	Dutch
NOR	Norwegian
POL	Polish
POR	Portuguese
RUS	Russian
SVE	Swedish
THA	Thai
TUR	Turkish
VIE	Vietnamese
ZAF	Afrikaans

Index

Numerics

- 16:9 47
- 4:3 Letter Box 47
- 4:3 Pan Scan 47

A

- Adjusting
 - picture 34
 - tracking 34
- Angle 57

C

- Cleaning the video heads 3
- Clock setting 19
- Connecting
 - cable box 16
 - satellite receiver 16
 - TV 15
- Counter 33
- Custom AV Mode 30

D

- DATA CD 7, 69, 75
- DATA DVD 7, 69, 75
- DOLBY DIGITAL 65
- DTS 65
- Dubbing. *see* Editing
- DVD 7

E

- Editing 84
- EP mode 36

H

- Handling discs 2

I

- Instant Advance 26
- Instant Replay 26, 32
- Instant Skip 32

J

- JPEG 7, 75

L

- Language selecting 18
- LP mode 37

M

- MP3 7, 69

P

- Parental Control 52
- PBC (Playback control) 79
- Picture adjustment 34
- Playback
 - at various speeds 26, 32
 - frame by frame 32
 - MP3 audio track 69
 - program play 61
 - repeat play 64
 - shuffle play 63
 - shuttle play 32
 - slow motion 26, 32
 - VIDEO CDs 79
- Playback quickly or slowly with sound 27
- Program play 61
- Progressive 94

R

- Recording
 - saving 37
- Repeat play 64
- Resume Play 27

S

- Safety tab 37
- Searching
 - at various speeds 26, 32
 - for a blank portion 83
 - for the counter 0 point 83
 - Scan and Play 83
- Shuffle play 63
- Shuttle play 32
- SP mode 36
- STEREO 65
- Subtitle 59
- Surround 67

T

- Timer setting
 - daily/weekly recording 39
- Tracking adjustment. *see* Adjusting

U

- Usable discs 7

V

- VIDEO CD 7, 79

Z

- Zoom 56

Índice

Este manual muestra la configuración básica para utilizar la Videograbadora-DVD.
Para ver detalles, consulte el manual de instrucciones en inglés.

Procedimientos iniciales

- 3** Conexiones básicas
- 7** Selección del idioma
- 8** Ajuste del reloj

Operaciones básicas

- 9** Reproducción de discos
- 11** Reproducción de cintas
- 13** Grabación de un equipo conectado

Conexiones básicas

Esta sección explica las conexiones básicas para conectar al televisor y la conexión para grabar de un equipo conectado. Asegúrese de enchufar el cable de alimentación únicamente después de haber completado todas las conexiones.

Antes de comenzar

Esta Videgrabadora-DVD no tiene sintonizador de TV. Para grabar programas de TV, conecte esta unidad al decodificador de cable o receptor satelital con salidas de audio/vídeo (página 5).

Si ha estado utilizando su videgrabadora conectada a una antena, conecte esta Videgrabadora-DVD a su videgrabadora utilizando un cable de audio/vídeo. De esta forma, podrá ver y grabar programas de TV.

La Videgrabadora-DVD no podrá grabar programas si usted tiene:

- un decodificador de cable sin salidas de audio/vídeo.
- cable sin decodificador de cable.
- solamente antena (no TV por cable).

En este caso, consulte con el proveedor CATV que haya contratado (o el más cercano).

Notas

- No podrá conectar la Videgrabadora-DVD a un televisor que no tenga toma de entrada de vídeo.
- Asegúrese de desconectar el cable de alimentación de CA de cada componente antes de conectarlo.
- Asegúrese de hacer las conexiones firmemente. Las conexiones flojas pueden provocar distorsiones en la imagen.

Conexión a su televisor

Conecte el televisor y la Videgrabadora-DVD utilizando el cable de audio/vídeo suministrado. Si quiere grabar programas de cable, en primer lugar complete estas conexiones, y después vaya a las páginas siguientes para ver las conexiones de TV por cable.

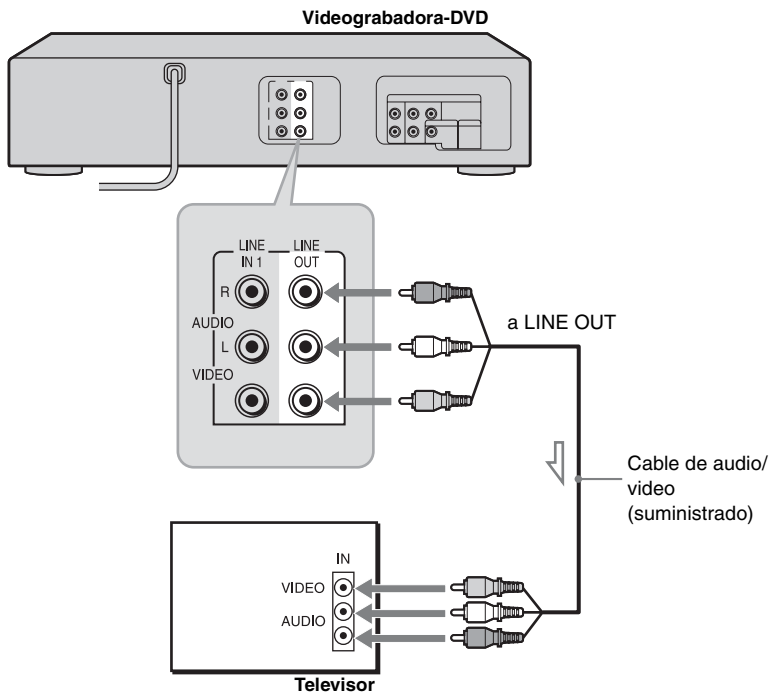

 : Flujo de señales

Nota

- Cuando el televisor conectado solamente tenga toma de entrada de sonido monofónico, conecte solamente a las tomas de entrada LINE OUT/AUDIO L (blanca) y VIDEO. No conecte la toma AUDIO R (roja).

Conexión de un decodificador de cable o receptor satelital

Con esta conexión, puede grabar cualquier canal del decodificador de cable o receptor satelital. Asegúrese de que el decodificador de cable o receptor satelital está encendido. Para ver canales por cable o satélite, debe hacer coincidir la fuente de entrada de la Videograbadora-DVD (L1) con la toma de entrada conectada al decodificador de cable o receptor satelital (LINE IN 1).

Sugerencia

- También puede conectar un decodificador de cable o receptor satelital utilizando las tomas LINE-2 IN del panel delantero.

Nota

- La Videograbadora-DVD no podrá grabar programas si usted tiene:
 - un decodificador de cable sin salidas de audio/vídeo.
 - cable sin decodificador de cable.
 - solamente antena (no TV por cable).

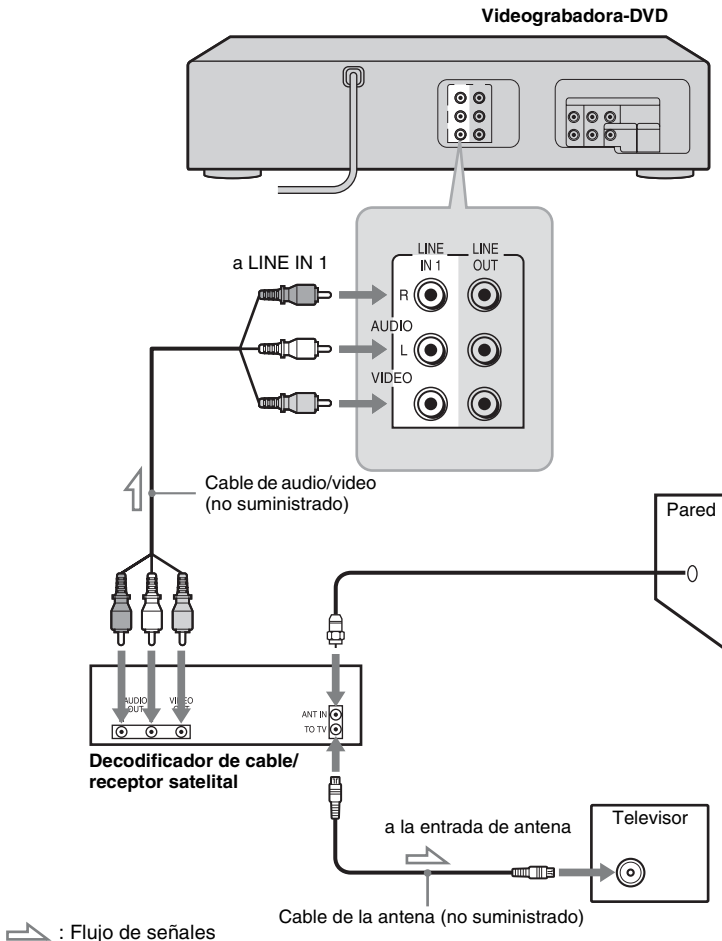

⇒ : Flujo de señales

continúa

Después de haber completado la conexión...

Después de haber completado la conexión, enchufe la Videgrabadora-DVD en una toma de CA.

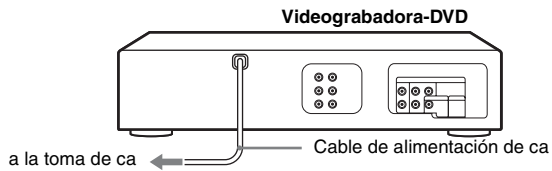

Selección del idioma

Es posible cambiar el idioma de las indicaciones en pantalla.

Antes de comenzar...

- Encienda la Videograbadora-DVD y su televisor.
- Ajuste el televisor a entrada de vídeo para que aparezca en la pantalla de televisor la señal procedente del reproductor.
- Si el reproductor de DVD está en el modo de reproducción, no podrá visualizar el menú de ajustes. Pare la reproducción de DVD.
- Utilice el mando a distancia para realizar las siguientes funciones.

- 1** Pulse SET UP, después pulse \uparrow/\downarrow para seleccionar (OPTION) y pulse ENTER.

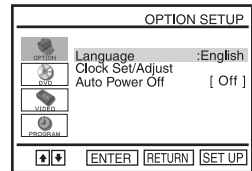

- 2** Pulse \uparrow/\downarrow para seleccionar “Language”, después pulse ENTER.
Aparecerá el menú “LANGUAGE/IDIOMA/LANGUE”.

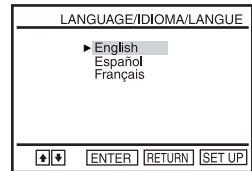

- 3** Pulse \uparrow/\downarrow para seleccionar el idioma deseado, inglés, español o francés, después pulse ENTER.
- 4** Pulse SET UP para salir del menú.

Ajuste del reloj

Antes de comenzar...

- Encienda la Videograbadora-DVD y su televisor.
- Ajuste el televisor a entrada de vídeo para que aparezca en la pantalla de televisor la señal procedente del reproductor.
- Si el reproductor de DVD está en el modo de reproducción, no podrá visualizar el menú de ajustes. Pare la reproducción de DVD.
- Utilice el mando a distancia para realizar las siguientes funciones.

- 1** Pulse SET UP, después pulse \uparrow/\downarrow para seleccionar  (OPTION) y pulse ENTER.

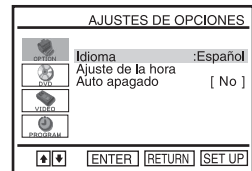

- 2** Pulse \uparrow/\downarrow para seleccionar "Ajuste de la hora", después pulse ENTER.

Aparecerá el menú "AJUSTE DE LA HORA".



- 3** Ajuste la hora, los minutos, el mes, el día y el año consecutivamente pulsando \leftarrow/\rightarrow para seleccionar el elemento a ajustar, y pulse \uparrow/\downarrow para seleccionar los dígitos.

El día de la semana se ajusta automáticamente.



- 4** Pulse ENTER para confirmar el ajuste.

- 5** Pulse SET UP para salir del menú.

Notas

- Para grabar de un equipo conectado utilizando el temporizador, deberá ajustar el reloj exactamente.
- Cuando se seleccione el modo VIDEO sin haber insertado una cinta o cuando la Videograbadora-DVD esté apagada aparecerá la visualización del reloj en el visualizador.

Reproducción de discos

DVD_{Video}

DVD_{VR}

VCD

CD

DATA-CD DATA-DVD

Dependiendo del disco, algunas operaciones podrán variar o estar restringidas. Consulte el manual de instrucciones suministrado con su disco.

Antes de comenzar...

- Encienda la Videgrabadora-DVD y su televisor.
- Ajuste el televisor a entrada de vídeo para que aparezca en la pantalla de televisor la señal procedente del reproductor.
- Utilice el mando a distancia para realizar las siguientes funciones.

1 Pulse SELECT DVD para controlar el reproductor de DVD.

2 Pulse  para abrir la bandeja de discos y poner un disco en ella.



con la cara de
reproducción hacia abajo

3 Pulse  PLAY.

La bandeja de discos se cerrará y el reproductor de DVD comenzará a reproducir. El visualizador mostrará el tiempo de reproducción*.



* Cuando no haya disco cargado aparecerá "----".

Notas

- Detenga la reproducción VIDEO mientras reproduzca un disco.
- Si reproduce un DVD o VIDEO CD que esté rayado, el reproductor podrá parar la reproducción en el punto donde esté rayado.
- La reproducción de listas de reproducción de duración superior a 10 horas grabadas en el modo VR no está garantizada.
- Una vez transcurridas 10 horas, el contador en el visualizador retorna a "0:00" y vuelve a comenzar la cuenta.
- Dependiendo de las especificaciones del software de grabación, es posible que el disco que haya sido grabado en otra unidad o PC no pueda ser reproducido.
- El reproductor no podrá reproducir un disco que haya sido grabado en otra unidad y finalizado incorrectamente.

continúa

Operaciones adicionales

Para	Pulse
Detener la reproducción	■ STOP
Hacer pausas durante la reproducción	PAUSE Si hace una pausa en el reproductor de DVD de más de 5 min (minuto), el reproductor de DVD se parará automáticamente.
Reanudar la reproducción después de la pausa	▷ PLAY
Avanzar al siguiente fotograma en el modo de pausa	●➔ SKIP
Volver al fotograma anterior en el modo de pausa	◀● REPLAY
Ir al siguiente capítulo, tema, o escena en el modo de reproducción continua	▶▶ NEXT en el mando a distancia o ▶▶ en la unidad
Volver al capítulo, tema o escena anterior en el modo de reproducción continua	◀◀ PREV en el mando a distancia o ◀◀ en la unidad
Localizar un punto rápidamente	◀◀ o ▶▶ en el mando a distancia (o mantenga pulsado ◀◀ o ▶▶ en la unidad) La velocidad de reproducción cambia de la forma siguiente cada vez que se pulsa el botón en el mando a distancia (o dependiendo del tiempo que mantenga pulsado el botón en la unidad): Cuando encuentre el punto que quiera, pulse ▷ PLAY.
Ver a cámara lenta en el modo de reproducción continua (DVD y VIDEO CD solamente)	PAUSE durante la reproducción, y pulse ◀◀ o ▶▶ La velocidad de reproducción cambia de la forma siguiente cada vez que se pulsa ◀◀ o ▶▶: Para reanudar la reproducción normal, pulse ▷ PLAY.
Reproducción de la escena anterior en 10 s (segundo) el modo de reproducción continua*1 (Reproducción instantánea)	◀● REPLAY
Avanzar ligeramente la escena actual 30 s (segundo) en el modo de reproducción continua*1 (Avance instantáneo)	●➔ SKIP Puede pulsar ●➔ SKIP hasta 4 veces. Esto le permitirá avanzar rápidamente hasta 2 minutos en total.
Parar la reproducción y extraer el disco	▲

*1 Para DVD VIDEO y DVD-RW/DVD-R o DVD+RW/DVD+R solamente

Notas

- No saldrá sonido excepto:
 - durante la reproducción normal
 - durante la reproducción rápida o lenta con sonido
- Dependiendo del método empleado para la grabación es posible que no pueda realizarse la operación de retroceso rápido para CD, MP3 y VIDEO CD.
- Tal vez no pueda utilizar la función de reproducción instantánea o avance instantáneo con algunas escenas.

Reproducción de cintas **VHS**

Antes de comenzar...

- Encienda la Videgrabadora-DVD y su televisor.
- Ajuste el televisor a entrada de vídeo para que aparezca en la pantalla de televisor la señal procedente del reproductor.
- Utilice el mando a distancia para realizar las siguientes funciones.

1 Pulse SELECT VIDEO para controlar el reproductor de Videgrabadora.

2 Inserte una cinta.

La videgrabadora comenzará a reproducir automáticamente si inserta una cinta con su lengüeta de seguridad quitada.

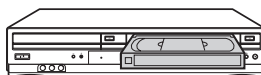

3 Pulse ▷ PLAY.

El visualizador mostrará el tiempo de reproducción.

Cuando la cinta llegue al final, se rebobinará automáticamente.



Operaciones adicionales

Para	Pulse
Detener la reproducción	■ STOP
Hacer pausas durante la reproducción	PAUSE Si hace una pausa en la videgrabadora de más de 5 min (minuto), la videgrabadora reanudará automáticamente la reproducción.
Reanudar la reproducción después de la pausa	PAUSE o bien ▷ PLAY
Avanzar la cinta rápidamente	▶▶ durante la parada
Rebobinar la cinta	◀◀ durante la parada
Expulsar la cinta	⬆
Visualización de la imagen durante el avance rápido o el rebobinado	Durante el avance rápido, mantenga pulsado ▶▶. Durante el rebobinado, mantenga pulsado ◀◀.

continúa

Para	Pulse
Reproducción a alta velocidad	<ul style="list-style-type: none"> • Durante la reproducción, pulse brevemente ►► o ◀◀. La cinta continuará reproduciéndose a una velocidad 5 veces mayor que la reproducción normal. • Durante la reproducción, mantenga pulsado ►► o ◀◀. La cinta continuará reproduciéndose a una velocidad 5 veces mayor que la reproducción normal. Al dejar de pulsar el botón, se reanuda la reproducción normal.
Reproducción a cámara lenta	Durante la pausa, pulse ►▶.
Reproducción fotograma a fotograma	Durante la pausa, pulse ●▶ SKIP.
Reproducción de la escena anterior en el modo de reproducción continua* (Reproducción instantánea)	Durante la reproducción, pulse ◀● REPLAY.
Salto de la escena actual 30 s (segundo) en el modo de reproducción continua* (Salto instantáneo)	Durante la reproducción, pulse ●▶ SKIP. Puede pulsar ●▶ SKIP hasta 4 veces. Esto le permitirá avanzar rápidamente hasta 2 minutos en total.
Reproducción a varias velocidades (Reproducción Shuttle)	<p>Durante la reproducción, pulse ◀◀◀ o ▶▶▶. Podrá cambiar la velocidad de reproducción de la siguiente forma.</p> <p>→7 ↔ →5 ↔ →3 ↔ Reproducción de la imagen fija ↔ Reproducción a cámara lenta ↔ Reproducción normal ↔ ×2 ↔ ×3 ↔ ×5 ↔ ×7</p>

* 10 s (segundo) en el modo SP o en el modo LP/15 s (segundo) en el modo EP

Para reanudar la reproducción normal

Pulse ▷ PLAY.

Para desconectar la alimentación durante el rebobinado (Parada del rebobinado)

Pulse I/⏻ mientras la cinta se está rebobinando. La alimentación se desactivará pero la cinta seguirá rebobinándose hasta que llegue al final.

Notas

- A varias velocidades de reproducción no sale sonido.
- La imagen puede aparecer con ruido al reproducirse a alta velocidad en sentido inverso.
- Pare la reproducción de disco mientras esté reproduciendo un vídeo.

Grabación de un equipo conectado **VHS**

Puede grabar de un decodificador de cable o receptor satelital conectado. Para conectar decodificador de cable o receptor satelital, consulte “Conexión a su televisor” en la página 4.

Antes de comenzar...

- Encienda la Videgrabadora-DVD, el televisor y el decodificador de cable o receptor satelital.
- Ajuste el televisor a entrada de vídeo para que aparezca en la pantalla de televisor la señal procedente del reproductor.
- Compruebe que la longitud de la cinta sea superior al tiempo total de grabación.
- Utilice el mando a distancia para realizar las siguientes funciones.

1 Pulse SELECT VIDEO para controlar la videgrabadora.

2 Inserte una cinta provista de lengüeta de seguridad.

3 Pulse INPUT SELECT para seleccionar una fuente conectada a las tomas LINE IN 1 o LINE-2 IN.

Aparecerá “L1” o “L2” en el visualizador.

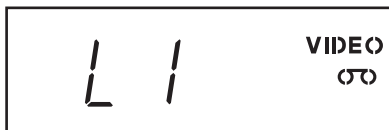

4 Pulse SP/EP para seleccionar la velocidad de cinta, SP (reproducción estándar) o EP (reproducción extendida).

El modo EP proporciona un tiempo de grabación tres veces superior al modo SP. No obstante, se obtiene una mejor calidad de imagen y sonido con el modo SP.



5 Pulse **●** REC para iniciar la grabación.

Aparecerá “REC” en el visualizador.



Mientras graba, deje el decodificador de cable o receptor satelital conectado encendido y no cambie el canal que quiera grabar de ellos.

Para detener la grabación

Pulse **■** STOP.

Notas

- No es posible grabar un DVD directamente a una cinta Videgrabadora utilizando su Videgrabadora-DVD.

<http://www.sony.net/>

Sony Corporation Printed in China

AK68-01307A

Download from [Www.Somanuals.com](http://www.Somanuals.com). All Manuals Search And Download.

Free Manuals Download Website

<http://myh66.com>

<http://usermanuals.us>

<http://www.somanuals.com>

<http://www.4manuals.cc>

<http://www.manual-lib.com>

<http://www.404manual.com>

<http://www.luxmanual.com>

<http://aubethermostatmanual.com>

Golf course search by state

<http://golfingnear.com>

Email search by domain

<http://emailbydomain.com>

Auto manuals search

<http://auto.somanuals.com>

TV manuals search

<http://tv.somanuals.com>