

DVD Recorder

Operating Instructions

 To find out useful hints, tips and information about Sony products and services please visit: www.sony-europe.com/myproduct/

RDR-DC90/DC100/DC200/DC500
RDR-DC105/DC205/DC305/DC505



HDMI



WARNING

To reduce the risk of fire or electric shock, do not expose this apparatus to rain or moisture. To avoid electrical shock, do not open the cabinet. Refer servicing to qualified personnel only. The mains lead must be changed only at a qualified service shop. Batteries or batteries installed apparatus shall not be exposed to excessive heat such as sunshine, fire or the like.

CLASS 1 LASER PRODUCT
LASER KLASSE 1
LUOKAN 1 LASERLÄITE
KLASS 1 LASERAPPARAT

This appliance is classified as a CLASS 1 LASER product. The CLASS 1 LASER PRODUCT MARKING is located on the rear of the unit.

CAUTION

The use of optical instruments with this product will increase eye hazard. As the laser beam used in this DVD recorder is harmful to eyes, do not attempt to disassemble the cabinet. Refer servicing to qualified personnel only.



This label is located on the laser protective housing inside the enclosure.

Notice for customers in the United Kingdom and Republic of Ireland

A molded plug complying with BS1363 is fitted to this equipment for your safety and convenience. Should the fuse in the plug supplied need to be replaced, a fuse of the same rating as the supplied one and approved by ASTA or BSI to BS1362, (i.e., marked with ⚡ or ⚡ mark) must be used.

If the plug supplied with this equipment has a detachable fuse cover, be sure to attach the fuse cover after you change the fuse. Never use the plug without the fuse cover. If you should lose the fuse cover, please contact your nearest Sony service station.

Precautions

- This unit operates on 220 – 240 V AC, 50/60 Hz. Check that the unit's operating voltage is identical with your local power supply.
- To prevent fire or shock hazard, do not place objects filled with liquids, such as vases, on the apparatus.
- Install this system so that the mains lead can be unplugged from the wall socket immediately in the event of trouble.

GUIDE Plus+ is (1) a registered trademark or trademark of, (2) manufactured under license from and (3) subject of various international patents and patent applications owned by, or licensed to, Gemstar-TV Guide International, Inc. and/or its related affiliates.

GEMSTAR-TV GUIDE INTERNATIONAL, INC. AND/OR ITS RELATED AFFILIATES ARE NOT IN ANY WAY LIABLE FOR THE ACCURACY OF THE PROGRAM SCHEDULE INFORMATION PROVIDED BY THE GUIDE PLUS+ SYSTEM. IN NO EVENT SHALL GEMSTAR-TV GUIDE INTERNATIONAL, INC. AND/OR ITS RELATED AFFILIATES BE LIABLE FOR ANY AMOUNTS REPRESENTING LOSS OF PROFITS, LOSS OF BUSINESS, OR INDIRECT, SPECIAL, OR CONSEQUENTIAL DAMAGES IN CONNECTION WITH THE PROVISION OR USE OF ANY INFORMATION, EQUIPMENT, OR SERVICES RELATING TO THE GUIDE PLUS+ SYSTEM.



Disposal of Old Electrical & Electronic Equipment (Applicable in the European Union and other European countries with separate collection systems)

This symbol on the product or on its packaging indicates that this product shall not be treated as household waste. Instead it shall be handed over to the applicable collection point for the recycling of electrical and electronic equipment. By ensuring this product is disposed of correctly, you will help prevent potential negative consequences for the environment and human health, which could otherwise be caused by inappropriate waste handling of this product. The recycling of materials will help to conserve natural resources. For more detailed information about recycling of this product, please contact your local Civic Office, your household waste disposal service or the shop where you purchased the product.

Europe Only



Pb

Disposal of waste batteries (applicable in the European Union and other European countries with separate collection systems)

This symbol on the battery or on the packaging indicates that the battery provided with this product shall not be treated as household waste.

On certain batteries this symbol might be used in combination with a chemical symbol. The chemical symbols for mercury (Hg) or lead (Pb) are added if the battery contains more than 0.0005% mercury or 0.004% lead.

By ensuring these batteries are disposed of correctly, you will help prevent potentially negative consequences for the environment and human health which could otherwise be caused by inappropriate waste handling of the battery. The recycling of the materials will help to conserve natural resources.

In case of products that for safety, performance or data integrity reasons require a permanent connection with an incorporated battery, this battery should be replaced by qualified service staff only.

To ensure that the battery will be treated properly, hand over the product at end-of-life to the applicable collection point for the recycling of electrical and electronic equipment.

For all other batteries, please view the section on how to remove the battery from the product safely. Hand the battery over to the applicable collection point for the recycling of waste batteries.

For more detailed information about recycling of this product or battery, please contact your local Civic Office, your household waste disposal service or the shop where you purchased the product.

The manufacturer of this product is Sony Corporation, 1-7-1 Konan Minato-ku Tokyo, 108-0075 Japan. The Authorized Representative for EMC and product safety is Sony Deutschland GmbH, Hedelfinger Strasse 61, 70327 Stuttgart, Germany.

For any service or guarantee matters please refer to the addresses given in separate service or guarantee documents.

Precautions

This equipment has been tested and found to comply with the limits set out in the EMC Directive using a connection cable shorter than 3 metres.

On safety

Should any solid object or liquid fall into the cabinet, unplug the recorder and have it checked by qualified personnel before operating it any further.

About the hard disk drive

The hard disk has a high storage density, which enables long recording durations and quick access to the written data.

However, it can easily be damaged by shock, vibration or dust, and should be kept away from magnets. To avoid losing important data, observe the following precautions.

- Do not apply a strong shock to the recorder.
- Do not place the recorder in a location subject to mechanical vibrations or in an unstable location.
- Do not place the recorder on top of a hot surface, such as a VCR or amplifier (receiver).
- Do not use the recorder in a place subject to extreme changes in temperature (temperature gradient less than 10 °C/hour).
- Do not move the recorder with its mains lead connected.
- Do not disconnect the mains lead while the power is on.
- When disconnecting the mains lead, turn off the power and make sure that the hard disk drive is not operating (the clock is displayed in the front panel display for at least 30 seconds and all recording or dubbing has stopped).
- Do not move the recorder for one minute after you have unplugged the mains lead.

- Do not attempt to replace or upgrade the hard disk by yourself, as this may result in malfunction.

If the hard disk drive should malfunction, you cannot recover lost data. The hard disk drive is only a temporary storage space.

About repairing the hard disk drive

- The contents of the hard disk drive may be checked in case of repair or inspection during a malfunction or modification. However, the contents will not be backed up or saved by Sony.
- If the hard disk needs to be formatted or replaced, it will be done at the discretion of Sony. All contents of the hard disk drive will be erased, including contents that violate copyright laws.

On power sources

- The recorder is not disconnected from the AC power source (mains) as long as it is connected to the wall outlet, even if the recorder itself has been turned off.
- If you are not going to use the recorder for a long time, be sure to disconnect the recorder from the wall outlet. To disconnect the AC power cord (mains lead), grasp the plug itself; never pull the cord.

On placement

- Place the recorder in a location with adequate ventilation to prevent heat build-up in the recorder.
- Do not place the recorder on a soft surface such as a rug that might block the ventilation holes.
- Do not place the recorder in a confined space such as a bookshelf or similar unit.
- Do not place the recorder in a location near heat sources, or in a place subject to direct sunlight, excessive dust, or mechanical shock.
- Do not place the recorder in an inclined position. It is designed to be operated in a horizontal position only.
- Keep the recorder and discs away from equipment with strong magnets, such as microwave ovens, or large loudspeakers.
- Do not place heavy objects on the recorder.

On recording

Make trial recordings before making the actual recording.

On compensation for lost recordings

Sony is not liable and will not compensate for any lost recordings or relevant losses, including when recordings are not made due to reasons including recorder failure, or when the contents of a recording are lost or damaged as a result of recorder failure or repair undertaken to the recorder. Sony will not restore, recover, or replicate the recorded contents under any circumstances.

Copyrights

- Television programmes, films, video tapes, discs, and other materials may be copyrighted. Unauthorized recording of such material may be contrary to the provisions of the copyright laws. Also, use of this recorder with cable television transmission may require authorization from the cable television transmitter and/or programme owner.
- This product incorporates copyright protection technology that is protected by U.S. patents and other intellectual property rights. Use of this copyright protection technology must be authorized by Macrovision, and is intended for home and other limited viewing uses only unless otherwise authorized by Macrovision. Reverse engineering or disassembly is prohibited.
- ANY USE OF THIS PRODUCT OTHER THAN CONSUMER PERSONAL USE IN ANY MANNER THAT COMPLIES WITH THE MPEG-2 STANDARD FOR ENCODING VIDEO INFORMATION FOR PACKAGED MEDIA IS EXPRESSLY PROHIBITED WITHOUT A LICENSE UNDER APPLICABLE PATENTS IN THE MPEG-2 PATENT PORTFOLIO, WHICH LICENSE IS AVAILABLE FROM MPEG LA, L.L.C., 250 STEELE STREET, SUITE 300, DENVER, COLORADO 80206.
- "PhotoTV HD" and the "PhotoTV HD" logo are trademarks of Sony Corporation.

Copy guard function

Since the recorder has a copy guard function, programmes received through an external tuner (not supplied) may contain copy protection signals (copy guard function) and as such may not be recordable, depending on the type of signal.

IMPORTANT NOTICE

Caution: This recorder is capable of holding a still video image or on-screen display image on your television screen indefinitely. If you leave the still video image or on-screen display image displayed on your TV for an extended period of time you risk permanent damage to your television screen. Plasma display panels and projection televisions are especially susceptible to this.

If you have any questions or problems concerning your recorder, please consult your nearest Sony dealer.

About this manual

Check your model name

The instructions in this manual are for 8 models: RDR-DC90, RDR-DC100, RDR-DC105, RDR-DC200, RDR-DC205, RDR-DC305, RDR-DC500, and RDR-DC505. Check your model name by looking at the front panel of the recorder.



- In this manual, the internal hard disk drive is written as “HDD,” and “disc” is used as a general reference for the HDD, DVDs, or CDs unless otherwise specified by the text or illustrations.
- Icons, such as , listed at the top of each explanation indicate what kind of media can be used with the function being explained. For details, see “Discs That Can Be Dubbed on” on page 106 and “Discs That Can Be Played” on page 108.
- Instructions in this manual describe the controls on the remote. You can also use the controls on the recorder if they have the same or similar names as those on the remote.
- The on-screen display illustrations used in this manual may not match the graphics displayed on your TV screen.
- NEED-to-know information (to prevent incorrect operation) is listed under the  icon. NICE-to-know information (tips and other useful information) is listed under the  icon.
- RDR-DC105/DC205/DC305/DC505 is used for illustration purposes.
- The explanations regarding DVDs in this manual refer to DVDs created on this recorder. The explanations do not apply to DVDs that are created on other recorders and played back on this recorder.

Table of Contents

WARNING	2
Precautions	3
Guide to Parts and Controls	10

Hookups and Settings

Hooking Up the Recorder	15
Step 1: Connecting the Aerial Cable	16
Step 2: Connecting the TV and Audio Component	17
Connecting a SCART cable	17
Connecting an HDMI cable	17
Connecting other cables	18
About the "Control for HDMI" functions for BRAVIA Sync (for HDMI connections only)	20
Step 3: Inserting a Conditional Access Module (CAM) (RDR-DC105/DC205/DC305/DC505 only)	20
Step 4: Connecting the Mains Lead	21
Step 5: Preparing the Remote	21
Controlling TVs with the remote	22
Changing programme positions of the recorder using the remote ..	23
Step 6: Easy Setup	23
Connecting a VCR or Similar Device	25
Connecting to the LINE 1/DECODER jack	25
Connecting to the LINE 2 IN jacks on the front panel	26
Connecting an External Decoder	27
Connecting a decoder	27
Setting external decoder (PAY-TV/Canal Plus analogue decoder) programme positions	28

Basic Operations

Using the System Menu	29
Recording a TV Programme to the HDD	30
Using the Quick Timer function	31
Playing the Recorded Programme (Title List)	31
Watching TV programmes	33
Displaying the programme/playback information	34
Using the Favourites List (for digital broadcasting only)	34

Recording to the HDD (“GUIDE Plus+”)

Using the GUIDE Plus+ Display	36
Listing up your favourite programme information (My TV)	37
One Button Recording (GUIDE Plus+)	38
Recording Programmes Using Series Recording	40
Setting the Timer Manually (Schedule)	41
Setting the timer manually (Timer List)	42
Checking/Changing/Canceling Timer Settings (Schedule)	42
Checking/changing timer settings	42
Cancelling timer settings	43
Changing the GUIDE Plus+ System Settings (Setup)	43
Language/Recording timing/Overnight Download settings (Personal Preferences)	44
Resetting the GUIDE Plus+ system settings (Start Installation Sequence)	44
Recording from Connected Equipment	45

Recording to the HDD (“Freeview+”)

Using the EPG (Electronic Programme Guide) Display	46
Using the Digital Favourites List	47
One Button Recording Using the EPG	47
Recording TV Programme Using the EPG	48
Recording Programmes Using Series Recording (Models for the UK Only)	49
Setting the Timer Manually (Manual)	50
Recording stereo and bilingual programmes	51
Checking/Changing/Canceling Timer Settings (Timer List)	52
Checking/changing timer settings	52
Cancelling timer settings	52
Recording from Connected Equipment	53

Playback

Playing Discs and Recorded Programmes	54
Pausing a TV broadcast (TV Pause/Pause Live TV)	56
Playing from the beginning of the programme you are recording (Chase Play)	56
Playing a previous recording while making another (Simultaneous Rec and Play)	57
Searching for a time/title/chapter/track, etc.	57
Playing repeatedly (Repeat)	57
Playing DivX/Music/Photo Files	58
Copying DivX/music/photo files to the HDD	58
Playing DivX video files	59
Playing music CDs and MP3	61
Playing photo files	63
Playing from the USB device	65
Copying DivX/music/photo files to a disc	65

Erasing and Editing

Before Editing	66
Erasing and Editing a Title	66
Erasing a title (Erase)	67
Erasing a section of a title (A-B Erase)	67
Dividing a title (Divide)	68
Labelling a title (Rename)	68
Creating and Editing a Playlist	69
Creating a Playlist title	69
Erasing a Playlist title	69
Editing a Playlist title	70

Dubbing (HDD ↔ DVD)

Before Dubbing	71
Dubbing from the HDD to a DVD (HDD → DVD)	71
Dubbing from a Finalised DVD to the HDD (DVD → HDD)	73
Playing the Disc on Other DVD Equipment (Finalise)	74

HDD/DV Camcorder Dubbing

Dubbing from HDD Camcorder	75
Preparing for HDD camcorder dubbing	76
One-Touch Dubbing from HDD camcorder (ONE-TOUCH DUB)	76
Dubbing from HDD camcorder using the on-screen display (HDD-Cam Dubbing)	77
Dubbing from DV Camcorder	78
Preparing for DV camcorder dubbing	78
One-Touch dubbing from DV camcorder (ONE-TOUCH DUB)	79
Dubbing from DV camcorder using the on-screen display (DV Dubbing)	80

Settings and Adjustments

Using the Disc Setup Menus (Disc Setup)	81
Disc Settings (Disc Information)	81
Formatting the HDD (HDD Formatting)	82
Using the Setup Menus (Initial Setup)	83
Clock Setting	83
Aerial Reception Settings (Channel)	84
Recorder Settings (System 1)	87
Recorder Settings (System 2)	89
Language Settings (Language)	90
Video Settings (Video In/Out)	91
Audio Input Settings (Audio In)	93
Audio Output Settings (Audio Out)	95
Limitation Settings (Parental Lock)	96
Easy Setup (Resetting the Recorder)	97

Additional Information

Troubleshooting	98
Resetting the Recorder	105
Discs That Can Be Dubbed on	106
Discs That Can Be Played	108
About Recording Mode	109
Language Code List	111
Notes About This Recorder	112
Notes on MP3 files, JPEG Image Files, DivX Video Files, and i.Link ..	113
Specifications	114
Index	118

Guide to Parts and Controls

For more information, see the pages in parentheses.

Remote

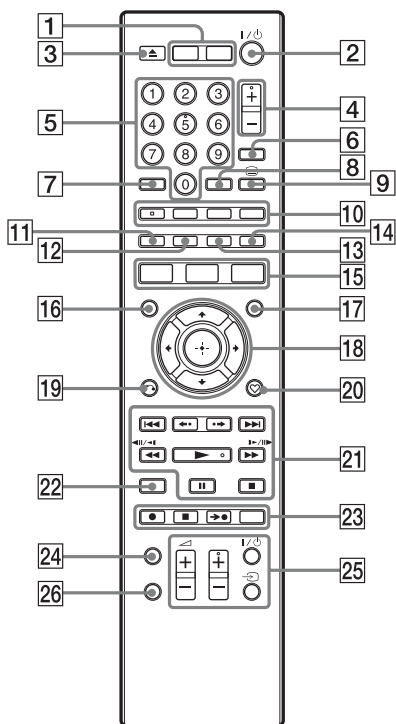

1 HDD (54)

Switches to the HDD.

DVD (54)

Switches to the DVD.

2 I/O (on/standby) (23)

Turns the recorder on or off.

3 \triangle (open/close) (54)

Opens or closes the disc tray.

4 PROG (programme) +/- (30)

The + button has a tactile dot*.

5 Number buttons (57)

The number 5 button has a tactile dot*.

6 INPUT (input select) (45)

Selects an input source.

7 CLEAR (58)

8 ZOOM (64)

Zooms an image in full view.

9 \equiv (text) (34)

This button function is not available in some areas.

10 AUDIO (55)

The AUDIO button has a tactile dot*.

SUBTITLE (55)

Selects a subtitle language.

MENU (54)

Displays the disc's menu.

TIMER (41, 42, 50, 52)

11 Red (38, 46)

12 Green (36, 46)

13 Yellow (36, 46)

14 Blue (36, 46)

15 SYSTEM MENU (29, 81)

TITLE LIST (31, 54, 66)

TOP MENU (54)

GUIDE (36, 46)

Displays the GUIDE Plus+® system or EPG screen.

16 MARKER (31, 57)

17 INFO (information) (36, 46)

Displays the programme information.

18 $\leftarrow/\uparrow/\downarrow/\rightarrow/+$ (enter) (23)

Selects a desired item.

19 \curvearrowright RETURN (23)

20 \heartsuit (favourites) (34, 47)

Displays the Favourites List.

21 **◀◀/▶▶** (previous/next) (55)

PAGE +/- (36, 46)

Changes the programme list by page.

◀•/•▶ (instant replay/instant advance) (55)

◀◀◀||◀||▶▶▶ (search/slow/freeze frame) (55)

DAY +/- (36, 46)

Changes the programme list by day.

▶ (play) (54)

|| (pause) (30, 55)

■ (stop) (54)

The ▶ button has a tactile dot*.

22 **DISPLAY** (34)

Displays the playing status.

23 **● REC** (30)

■ REC STOP (30)

→● SYNCHRO REC

This button function is not available.

REC MODE (30)

Selects the recording mode.

24 **TV/RADIO** (33)

Switches between TV and radio channels.

25 **TV I/⏻** (on/standby) (22)

TV ↻ (input select) (22)

TV ▲ (volume) +/- (22)

TV PROG (programme) +/- (22)

The + button has a tactile dot*.

26 **TV/DVD** (22)

Switches between TV mode and DVD mode.

* Use the tactile dot as a reference when operating the recorder.

Front panel

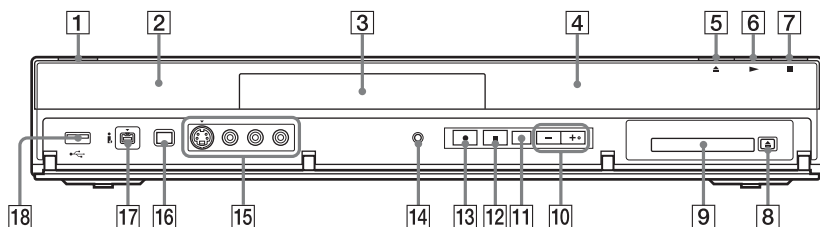

- 1** **I/⏻ (on/standby) (23)**
Turns the recorder on or off.
- 2** **📶 (remote sensor) (21)**
- 3** **Disc tray (54)**
- 4** **Front panel display (13)**
- 5** **⏮ (open/close) (54)**
Opens or closes the disc tray.
- 6** **▶ (play) (54)**
The ▶ button has a tactile dot*.
- 7** **■ (stop) (54)**
- 8** **⏮ (eject) (RDR-DC105/DC205/
DC305/DC505 only) (20)**
Removes the CAM from the CAM slot.
- 9** **CAM (Conditional Access
Module) slot (RDR-DC105/
DC205/DC305/DC505 only) (20)**
- 10** **PROGRAM +/- (30)**
The + button has a tactile dot*.
- 11** **INPUT (input select) (45)**
Selects an input source.
- 12** **■ REC STOP (30)**
- 13** **● REC (30)**
- 14** **RESET**
When the recorder does not operate properly, press the RESET button.
- 15** **LINE 2 IN (S VIDEO/VIDEO/
L(MONO) AUDIO R) jacks (26)**
Connect a VCR or similar recording device to these jacks.
- 16** **ONE-TOUCH DUB (76, 79)**
Starts dubbing from a connected digital video camera.
- 17** **📺 DV IN jack (78)**
Connect a DV camcorder to this jack.
- 18** **🔌 USB jack (58, 75)**
Connect a USB device to this jack.

* Use the tactile dot as a reference when operating the recorder.

Front panel display

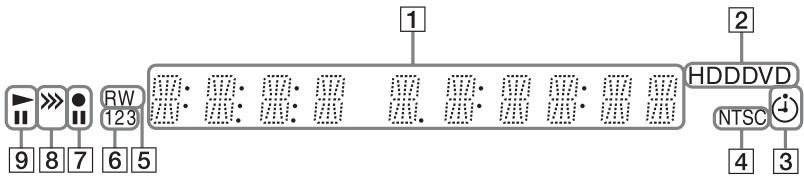

1 Displays the following:

- Playing/Recording time
- Current title number
- Clock
- Programme position
- UPDATE indication
“UPDATE” appears when the recorder is updating information.

2 HDD

Lights up when the HDD is selected.

DVD

Lights up when the DVD is selected.

3 Timer indicator (50)

Lights up when the timer for recording is set.

4 NTSC indicator (92)

Lights up when playing an NTSC disc.

5 Disc type

“RW” lights up when a DVD+RW/
DVD-RW disc is loaded.

“R” lights up when a DVD+R/DVD-R
disc is loaded.

6 Command Mode indicator (88)

Displays the current command mode
number for the recorder.

7 Recording status

8 Dubbing direction indicator

9 Playing status

Rear panel

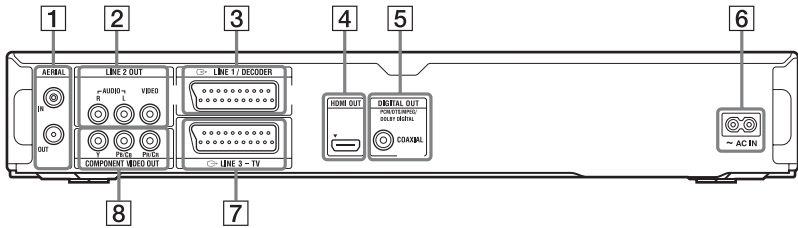

- | | |
|--|---|
| 1 AERIAL IN/OUT jacks (16) | 5 DIGITAL OUT (COAXIAL) jack (18) |
| 2 LINE 2 OUT (R-AUDIO-L/VIDEO) jacks (18) | 6 AC IN terminal (21) |
| 3 LINE 1/DECODER jack (25) | 7 LINE 3 - TV jack (17) |
| 4 HDMI OUT jack (17) | 8 COMPONENT VIDEO OUT (Y, Pb/Cb, Pr/Cr) jacks (18) |

Hooking Up the Recorder

Follow steps 1 through 6 to hook up and adjust the settings of the recorder. Do not connect the mains lead until you reach “Step 4: Connecting the Mains Lead” on page 21.



- See “Specifications” (page 114) for a list of supplied accessories.
- Plug in cables securely to prevent unwanted noise.
- Refer to the instructions supplied with the components to be connected.
- You cannot connect this recorder to a TV that does not have a SCART or video input jack.
- Be sure to disconnect the mains lead of each component before connecting.

Step 1: Connecting the Aerial Cable

Connect the aerial cable by following the steps below.

“Standby Mode” is set to “Mode 1” (default) in the “System 1” setup and the picture does not appear on the TV when the recorder is in standby mode.

To watch TV in standby mode, set “Standby Mode” to “Mode 2” in “Step 6: Easy Setup” (page 23) or use a splitter to divide aerial input signals between the TV and the recorder.



You can also set “Standby Mode” to “Mode 2” in the “System 1” setup (page 87).



- If your aerial is a flat cable (300-ohm twin lead cable), use an external aerial connector (not supplied) to connect the aerial to the recorder.
- If you have separate cables for AERIAL antennas, use an AERIAL UHF/VHF band mixer (not supplied) to connect the aerial to the recorder.

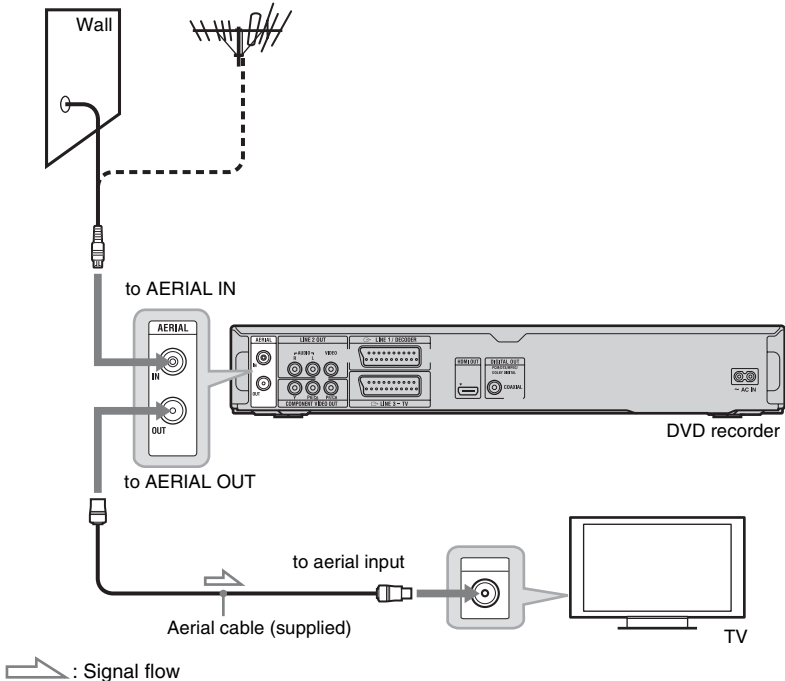

- 1** Disconnect the aerial cable from your TV, and connect it to AERIAL IN on the rear panel of the recorder.
- 2** Connect AERIAL OUT of the recorder to the aerial input of your TV using the supplied aerial cable.

Step 2: Connecting the TV and Audio Component

Select one of the following patterns according to the input jack on your TV monitor, projector, or audio component such as an AV amplifier (receiver).

Connecting a SCART cable

When setting “LINE 3 Out [LINE 1 In]” to “S-Video [S-Video],” “RGB [Video/RGB]” or “RGB [Decoder]” in the “Video In/Out” setup (page 91), use a SCART cable that conforms to the selected signal.

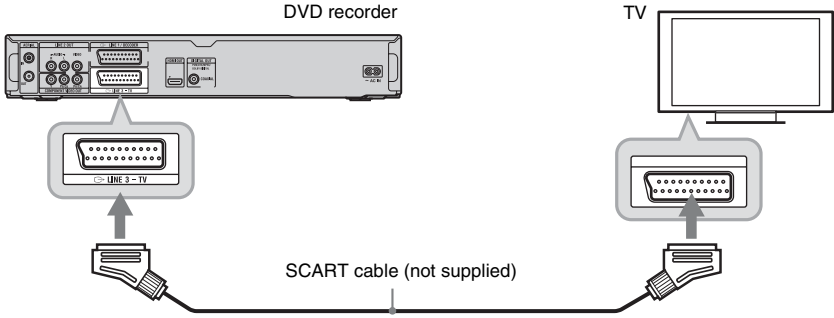

Connecting an HDMI cable

Use a certified HDMI cable to enjoy high quality digital picture and sound through the HDMI OUT jack.

When connecting a Sony TV/audio component that is compatible with the “Control for HDMI” function, see page 20.

To connect a TV

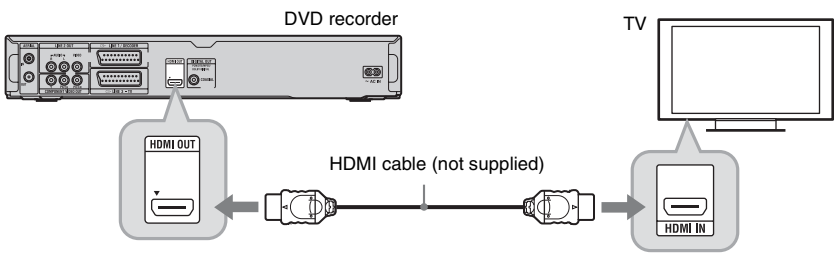

To connect a TV through an audio component

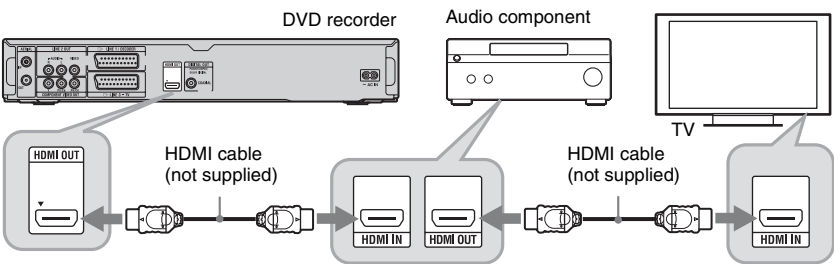

Connecting other cables

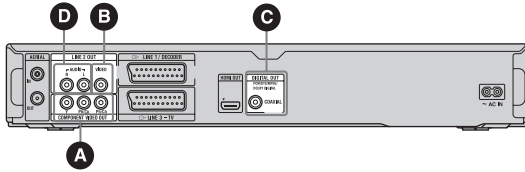

To connect to video jacks

Connecting to video jacks will enable you to view pictures.

A Component video output jacks (Y, P_B/C_B, P_R/C_R)

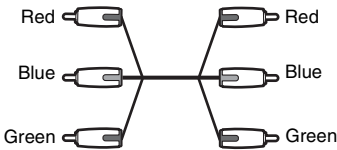

You will enjoy accurate colour reproduction and high-quality images.

If your TV accepts progressive 525p/625p format signals and if you do not use the HDMI connection, use this connection and set "Progressive" to "Compatible" in the "Easy Setup" setup (page 23). Or, set "Component Video Out" to "Progressive" in the "Video In/Out" setup to send progressive video signals. For details, see "Component Video Out" on page 91.

B Video output jack

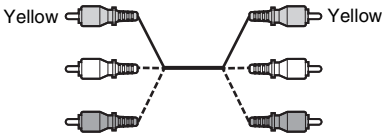

You will enjoy standard quality images.

To connect to audio jacks

Connecting to audio jacks will enable you to listen to sound.

C Digital audio output jack (COAXIAL)



If your audio component has a Dolby^{*1} Digital, DTS^{*2}, or MPEG audio decoder and a digital input jack, use this connection. You can enjoy Dolby Digital (5.1ch), DTS (5.1ch), and MPEG audio (5.1ch) surround effects.

^{*1} Manufactured under license from Dolby Laboratories.

Dolby and the double-D symbol are trademarks of Dolby Laboratories.

^{*2} Manufactured under license under U.S. Patent #: 5,451,942 & other U.S. and worldwide patents issued & pending. DTS and DTS Digital Out are registered trademarks and the DTS logos and Symbol are trademarks of DTS, Inc. © 1996-2008 DTS, Inc. All Rights Reserved.

D Audio L/R (left/right) output jacks

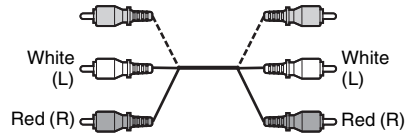

This connection will use your TV's or audio component's two speakers for sound.

When connecting to the HDMI jack

Follow the steps below. Improper handling may damage the HDMI jack and the connector.

- 1 Carefully align the HDMI jack on the rear of the recorder and the HDMI connector by checking their shapes. Make sure the connector is not upside down or tilted.

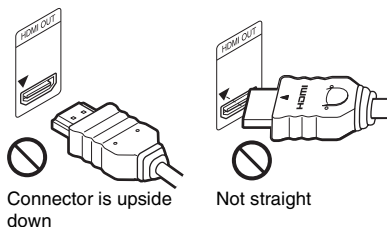

- 2 Insert the HDMI connector straight into the HDMI jack. Do not bend or apply pressure to the HDMI connector.

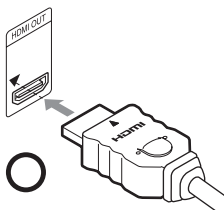

- Be sure to disconnect the HDMI cable when moving the recorder.
- Do not press the recorder against the cabinet wall when you place the recorder in a cabinet with the HDMI cable connected. It may damage the HDMI jack or the HDMI cable.
- Do not twist the HDMI connector while connecting to or disconnecting from the HDMI jack to avoid damaging the HDMI jack and connector.

When playing “wide screen” images

Some recorded images may not fit your TV screen. To change the picture size, see page 91.

If you are connecting to a VCR

Connect your VCR to the LINE 1/DECODER jack on the recorder (page 25).



For correct speaker location, refer to the operating instructions supplied with the connected components.



- Do not connect the recorder to your TV using both a SCART cable and an HDMI cable.
- Do not connect more than one type of video cable between the recorder and your TV at the same time.
- When you connect the recorder to your TV via the SCART jacks, the TV's input source is set to the recorder automatically when you start playback. If necessary, press the TV  button on the remote to return the input to the TV.
- You cannot connect the HDMI OUT jack to DVI jacks that are not HDCP compliant (e.g., DVI jacks on PC displays).
- Component progressive signals are not output when using the HDMI connection.
- Do not connect your TV's audio output jacks to the LINE 2 IN (R-AUDIO-L) jacks at the same time. This will cause unwanted noise to come from your TV's speakers.
- When connecting to the audio L/R input jacks, do not connect the LINE 2 IN (R-AUDIO-L) and LINE 2 OUT (R-AUDIO-L) jacks to your TV's audio output jacks at the same time. This will cause unwanted noise to come from your TV's speakers.
- When connecting to the HDMI OUT jack or DIGITAL OUT (COAXIAL) jack, after you have completed the connection, make the appropriate settings in the “Audio Out” setup (page 95). Otherwise, no sound or a loud noise will come from your speakers.

* This DVD recorder incorporates High-Definition Multimedia Interface (HDMI™) technology.

HDMI, the HDMI logo and High-Definition Multimedia Interface are trademarks or registered trademarks of HDMI Licensing LLC.

About the “Control for HDMI” functions for BRAVIA Sync (for HDMI connections only)

By connecting Sony components that are compatible with the “Control for HDMI” function with an HDMI cable (not supplied), operation is simplified as below:

- One-Touch Play (page 55)
- System Power-Off
When you turn the TV off using the power button on the TV’s remote, the recorder and components compatible with the “Control for HDMI” function turn off automatically. However, the recorder does not turn off while recording or dubbing even if you turn off the TV.
- BRAVIA Sync display
You can control the recorder by pressing the SYNC MENU button on the TV’s remote.



- Depending on the connected component, the “Control for HDMI” function may not work. Refer to the operating instructions supplied with the component.
- You can use the BRAVIA Sync display feature only when the connected TV has the SYNC MENU button. For details on BRAVIA Sync, refer to the operating instructions supplied with the TV.
- To use the BRAVIA Sync features, set “Control for HDMI” to “On” (default) in the “System 1” setup (page 87).

Step 3: Inserting a Conditional Access Module (CAM) (RDR-DC105/DC205/DC305/DC505 only)

Insert a conditional access module (CAM) provided by your service provider to receive scrambled digital broadcasting. This recorder is designed to work with modules that support the DVB standard. Contact your service provider to obtain the right kind of CAM.

Insert the CAM into the CAM slot as far as it will go.

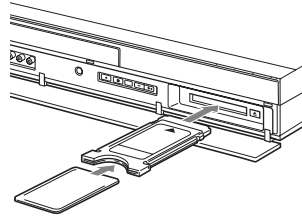

To remove the CAM

Press  located on the right side of the CAM slot.



- The CAM slot accepts only Type I and Type II PC cards. Do not insert other cards or unacceptable objects into the CAM slot.
- Do not remove or insert the CAM while receiving broadcasts. This will cause the picture not to be displayed.

Step 4: Connecting the Mains Lead

Connect the supplied mains lead to the AC IN terminal of the recorder. Then plug the recorder and TV mains leads into the mains. After you connect the mains lead, **you must wait for a short while before operating the recorder.** You can operate the recorder once the front panel display lights up and the recorder enters standby mode.

If you connect additional equipment to this recorder (page 25), be sure to connect the mains lead after all connections are complete.

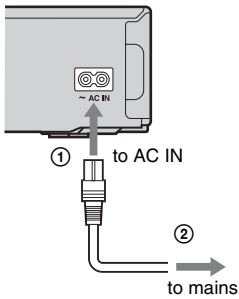

Step 5: Preparing the Remote

You can control the recorder using the supplied remote. Insert two R6 (size AA) batteries by matching the ⊕ and ⊖ ends on the batteries to the markings inside the battery compartment. When using the remote, point it at the remote sensor  on the recorder.

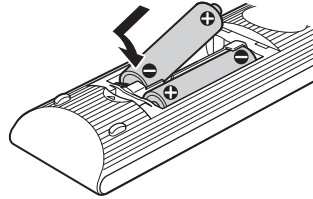

- If the supplied remote interferes with your other Sony DVD recorder or player, change the command mode number for this recorder (page 88).
- Use the batteries correctly to avoid possible leakage and corrosion. Should leakage occur, do not touch the liquid with bare hands. Observe the following:
 - Do not use a new battery with an old battery, or batteries of different manufacturers.
 - Do not attempt to recharge the batteries.
 - If you do not intend to use the remote for an extended period of time, remove the batteries.
 - If battery leakage occurs, wipe out any liquid inside the battery compartment, and insert new batteries.
- Do not expose the remote sensor (marked  on the front panel) to strong light, such as direct sunlight or a lighting apparatus. The recorder may not respond to the remote.
- When you replace the batteries of the remote, the code number and Command Mode may be reset to the default setting. Set the appropriate code number and Command Mode again.

Controlling TVs with the remote

You can adjust the remote's signal to control your TV.



- Depending on the connected unit, you may not be able to control your TV with some or all of the buttons below.
- If you enter a new code number, the code number previously entered will be erased.

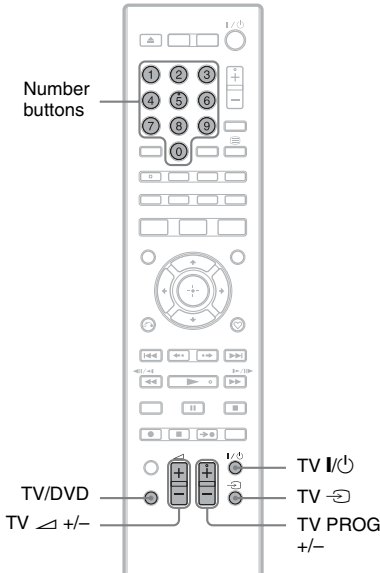

1 Hold down TV I/⏻ located at the bottom of the remote.

Do not press the I/⏻ button at the top of the remote.

2 With TV I/⏻ pressed down, enter the TV's manufacturer code using the number buttons.

For instance, to enter "09," press "0" then "9." After you enter the last number, release the TV I/⏻ button.

Code numbers of controllable TVs

If more than one code number is listed, try entering them one at a time until you find the one that works with your TV.

Manufacturer	Code number
Sony	01 (default)
Grundig	11
Hitachi	24
ITT	15, 16
JVC	33
LG/Goldstar	76
Loewe	45
Nokia	15, 16, 69, 73
Panasonic	17, 49
Philips	06, 07, 08, 72
Saba	12, 13, 74
Samsung	22, 23, 71
Sanyo	25
Sharp	29
Telefunken	36
Thomson	43, 75
Toshiba	38

The remote performs the following:

Buttons	Operations
TV I/⏻	Turns your TV on or off.
TV ↵ (volume) +/-	Adjusts the volume of your TV.
TV PROG +/-	Selects the programme position on your TV.
TV ↵ (input select)	Switches your TV's input source.

To operate the TV/DVD button (for SCART connections only)

The TV/DVD button switches between TV mode and DVD mode. Press the TV/DVD button when in stop mode or no menu appears on the TV screen. Point your remote at the recorder when using this button.

TV mode: switch to this when you use the TV's tuner mainly. When you start playback, the input source for the TV is set to the recorder automatically.

DVD mode: switch to this when you use the recorder's tuner mainly.

Changing programme positions of the recorder using the remote

You can change programme positions of the recorder using the number buttons.

Example: for channel 50

Press "5," "0," then press \oplus .

Step 6: Easy Setup

Make the basic adjustments by following the on-screen instructions in "Easy Setup."

Be careful not to disconnect the cables or exit the "Easy Setup" function during this procedure.

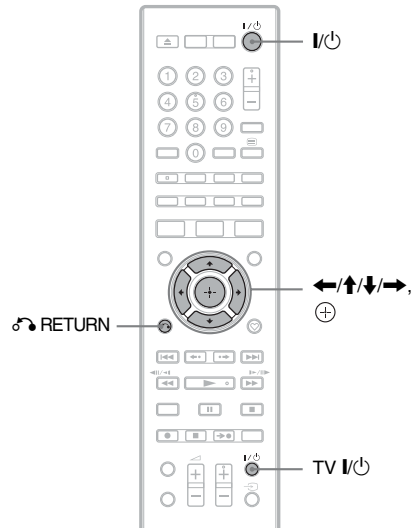

- 1 Turn on the recorder and your TV. Then switch the input selector on your TV so that the signal from the recorder appears on your TV screen.**

- 2 Follow the on-screen instructions to make each setting, and press \oplus or \rightarrow to proceed.**

◆ Language (language)

Select a language for the on-screen displays using \uparrow/\downarrow .

◆ Country

Select your country/region using \uparrow/\downarrow .

◆ Digital Source

Select the input source for digital broadcasting. When you receive analogue broadcasting only, press \rightarrow several times to proceed to the "Auto Channel Setting" setting.

"Antenna": Select this to receive digital terrestrial television (DVB-T).

“Cable”: Select this to receive digital cable television (DVB-C) (not available in some areas).

For UK models

When you select “Cable,” the GUIDE Plus+ system will not be available. The recorder skips the “EPG Type Select” and “Postal Code” settings.

For other models

When you select “Cable,” the GUIDE Plus+ system will not be available. The recorder skips the “Postal Code” setting.

◆ EPG Type Select (models for the UK only)

Select the EPG (Electronic Programme Guide) type to use.

“GUIDE Plus+”: Select this to use the Gemstar GUIDE Plus+ electronic programme guide (page 36).

“Freeview+”: Select this to use the digital electronic programme guide (page 46).

◆ Postal Code

Enter your postal code using $\leftarrow/\uparrow/\downarrow/\rightarrow$, and press \oplus .

◆ Auto Channel Setting (page 84)

1 Select a channel type to scan using \leftarrow/\rightarrow , and press \downarrow .

“All”: Scans both digital and analogue channels.

“Digital”: Scans only digital channels.

“Analog”: Scans only analogue channels.

When you select “Analog,” go to step 3.

2 Select a service type to scan, “All Services” or “Free Services” using \leftarrow/\rightarrow , and press \downarrow .

3 Select “Start,” and press \oplus .

The recorder starts scanning the programme positions.

◆ TV Type (page 91)

- If you have a widescreen TV, select “16:9.”
- If you have a standard TV, select “4:3 Letter Box” or “4:3 Pan Scan.” This will determine how “widescreen” images are displayed on your TV.

◆ Progressive

When you connect a progressive format TV to this recorder using the COMPONENT VIDEO OUT jacks, select “Compatible.”

When using the HDMI connection (page 17), the recorder skips the “Progressive” setting.

◆ Standby Mode (page 87)

Select the mode for when the recorder is turned off.

- “Yes (Mode 2)”: Input signals are output when the recorder is in standby mode.
- “No (Mode 1)”: No input signals are output when the recorder is in standby mode.

◆ Manual Clock Setting

The recorder sets the clock automatically. When the signal cannot be found, set the clock manually.

Set the day, month, year, hour, and minutes using $\leftarrow/\uparrow/\downarrow/\rightarrow$, and press \oplus to start the clock.

3 Press \oplus when “Finish” appears.

“Easy Setup” is completed.

To receive GUIDE Plus+ system data your recorder must be turned off when not in use. After initial setup, it may take up to 24 hours to begin receiving TV programme listings.

To return to the previous step

Press \leftarrow RETURN.



If you want to run “Easy Setup” again, press SYSTEM MENU and select “Easy Setup” in “Initial Setup” (page 97).

Connecting a VCR or Similar Device

After disconnecting the recorder's mains lead from the mains, connect a VCR or similar recording device to the LINE IN jacks of this recorder.

To watch the connected VCR or a similar device's picture through the recorder while the recorder is in standby mode, set "Standby Mode" to "Mode 2" in the "System 1" setup (page 87). If not, the picture will not appear.

Use the DV IN jack on the front panel if the equipment has a DV output jack (i.LINK jack) (page 78).

For details, refer to the instruction manual supplied with the connected equipment.

To record on this recorder, see "Recording from Connected Equipment" on page 45.

Connecting to the LINE 1/DECODER jack

Connect a VCR or similar recording device to the LINE 1/DECODER jack of this recorder.

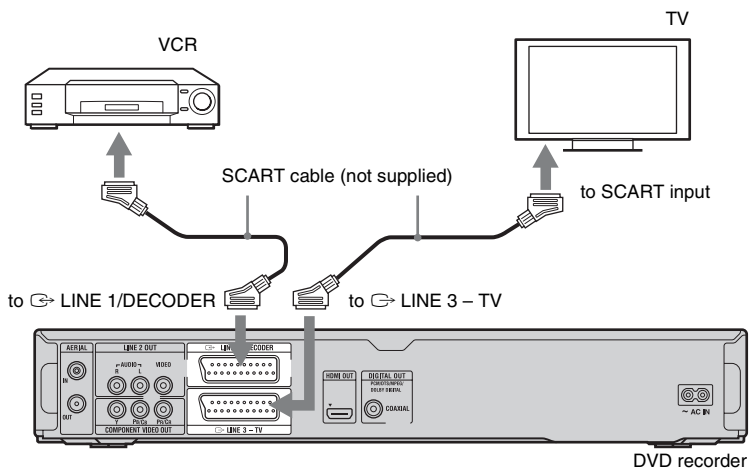

- Pictures containing copy protection signals that prohibit any copying cannot be recorded.
- If you pass the recorder signals through a VCR, you may not receive a clear image on your TV screen.

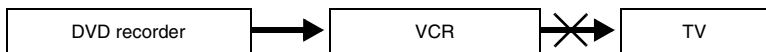

Be sure to connect your VCR to the DVD recorder and to your TV in the order shown below. To watch video tapes, watch the tapes through a second line input on your TV.

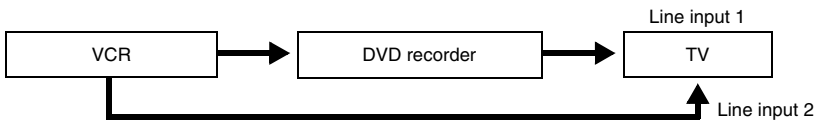

- When you record to a VCR from this DVD recorder, do not switch the input source to TV by pressing the TV/DVD button on the remote.
- If you disconnect the recorder's mains lead, you will not be able to view the signals from the connected VCR.

Connecting to the LINE 2 IN jacks on the front panel

Connect a VCR or similar recording device to the LINE 2 IN jacks of this recorder. If the equipment has an S-video jack, you can use an S-video cable instead of an audio/video cable.

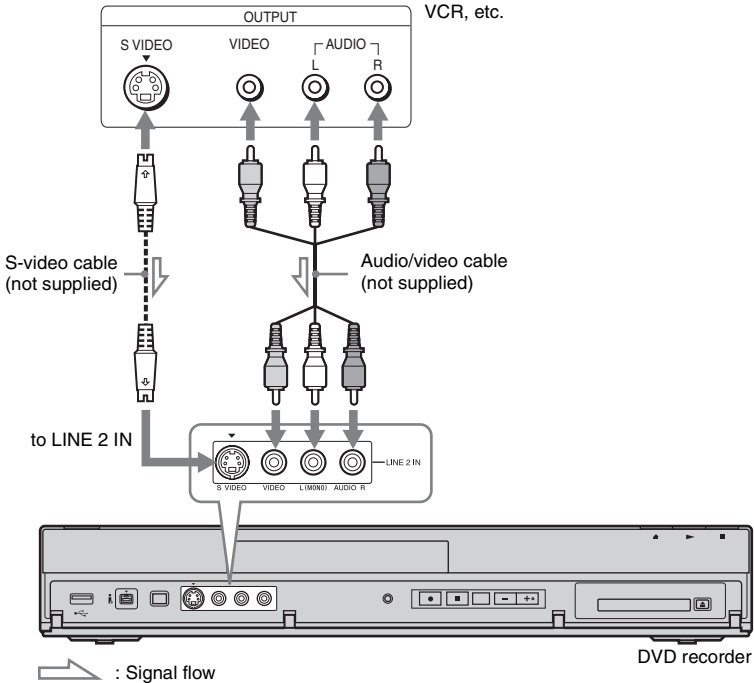

When the connected equipment outputs only monaural sound, connect to only the L(MONO) and VIDEO input jacks on the front of the recorder. Do not connect the R input jack.



- Do not connect the yellow LINE IN (VIDEO) jack when using an S-video cable.
- Do not connect the output jack of this recorder to another equipment's input jack with the other equipment's output jack connected to the input jack of this recorder. This may cause noise (feedback).
- Do not connect more than one type of video cable between the recorder and your TV at the same time.

Connecting an External Decoder

You can watch or record external decoder (PAY-TV/Canal Plus analogue decoder) programmes if you connect a decoder (not supplied) to the recorder. Disconnect the recorder's mains lead from the mains when connecting the decoder.

To watch the connected external decoder (PAY-TV/Canal Plus analogue decoder) programmes while the recorder is in standby mode, set "Standby Mode" to "Mode 2" in the "System 1" setup (page 87). If not, the picture will not appear. Note that when you set "LINE 3 Out [LINE 1 In]" to "Video [Decoder]" or "RGB [Decoder]" in step 5 of "Setting external decoder (PAY-TV/Canal Plus analogue decoder) programme positions" (page 28), you will not be able to select "L1" because Line 1 will become a dedicated line for the decoder.

Connecting a decoder

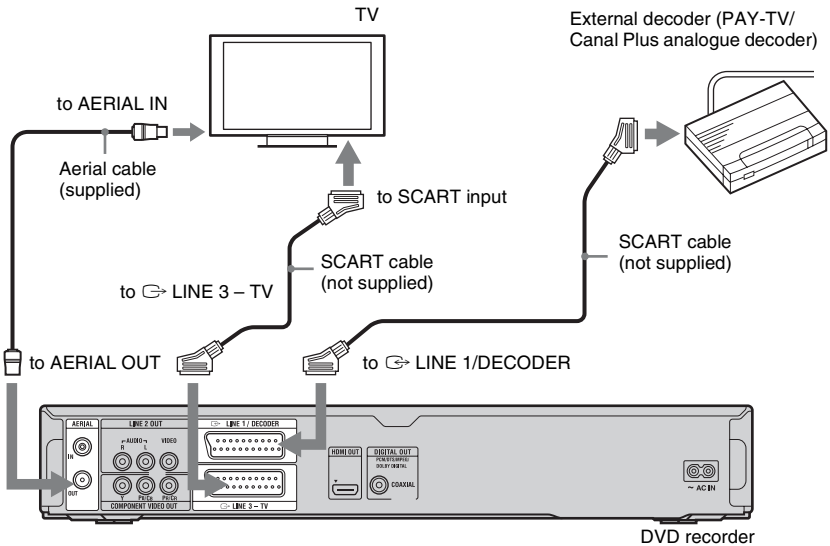

Setting external decoder (PAY-TV/Canal Plus analogue decoder) programme positions

To watch or record PAY-TV/Canal Plus analogue programmes, set your recorder to receive the programme positions using the on-screen display.

In order to set the programme positions correctly, be sure to follow all of the steps below.

- 1 Press SYSTEM MENU.**
The System Menu appears.
- 2 Select “Initial Setup” using ↑/↓, and press ⊕.**
- 3 Select “Video In/Out” using ↑/↓, and press ⊕.**
- 4 Select “LINE 3 Out [LINE 1 In]” using ↑/↓, and press ⊕.**
- 5 Press ↑/↓ to select “Video [Decoder]” or “RGB [Decoder],” and press ⊕.**
- 6 Press ↶ RETURN to return to “Initial Setup.”**
- 7 Select “Channel” using ↑/↓, and press ⊕.**
- 8 Select “Analog Manual Setting” using ↑/↓, and press ⊕.**
- 9 Select the desired programme position using ↑/↓, and press the red button (“Edit”).**

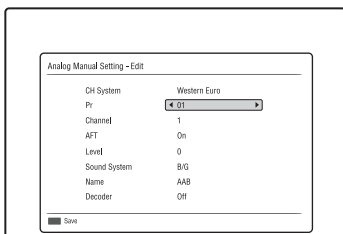

- 10 Select “Channel” using ↑/↓, and select the external decoder programme position using ←/→.**

- 11 Select “Sound System” using ↑/↓, and select an available TV system, B/G, D/K, I, or L using ←/→.**

To receive broadcasts in France, select “L.”

- 12 Select “Decoder” using ↑/↓, and select “On” using ←/→.**

- 13 Press the red button (“Save”).**

To return to the previous step

Press ↶ RETURN.



- If you disconnect the recorder’s mains lead, you will not be able to view the signals from the connected decoder.
- To watch the connected external decoder (PAY-TV/Canal Plus analogue decoder) programmes while the recorder is in standby mode, set “Standby Mode” to “Mode 2” in the “System 1” setup (page 87).

Basic Operations

Using the System Menu

The System Menu provides entry to the recorder's functions.

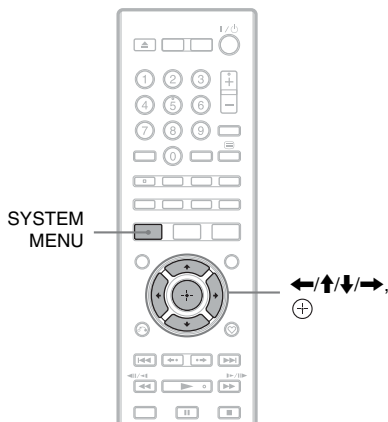

- 1 Press **SYSTEM MENU**.
The System Menu appears.

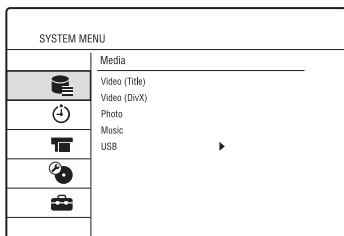

- 2 Select a menu icon using **↑/↓**, and press **+**.
- 3 Select an option using **↑/↓**, and press **+**.
If necessary, select a sub-option using **↑/↓**, and press **+**.

To exit the System Menu

Press **SYSTEM MENU**.

Media

Displays the contents of the HDD, a disc, or the connected USB device.

“Video (Title)”: Displays the Title List on the HDD or a DVD (page 31).

“Video (DivX)”: Displays the DivX List on the HDD, DATA DVD, or DATA CD (page 59).

“Music”: Displays the Music List on the HDD, CD, DATA DVD, or DATA CD (page 61).

“Photo”: Displays the Photo List on the HDD, DATA DVD, or DATA CD (page 63).

“USB”: Displays the DivX List/Music List/Photo List on the connected USB device (page 65).

Timer Recording

Displays a menu for timer recording.

“Programme Guide”: Allows you to set a programme to be recorded based on the information provided by the EPG (Electronic Programme Guide) (page 38, 47).

“Timer List”: Allows you to set the date, time, and programme position of the programme manually (page 50).

HDD-Cam/DV

Displays the Dubbing List.

“HDD-Cam Dubbing”: Allows you to dub the contents of a Sony HDD camcorder to the hard disk drive of the recorder via the USB jack on the front panel (page 75).

“DV Dubbing”: Allows you to dub the contents of a DV camcorder to the hard disk drive of the recorder via the DV IN jack on the front panel (page 78).

Disc Setup (page 81)

Displays the Disc Setup menu for adjusting HDD/DVD related settings.

Initial Setup (page 83)

Displays the Initial Setup menu for setting up the recorder to suit your preferences.

Recording a TV Programme to the HDD

HDD

This section introduces the basic operation to record a current TV programme to the hard disk (HDD). For an explanation of how to make timer recordings, see page 38 or page 47.



The recording destination is HDD only.

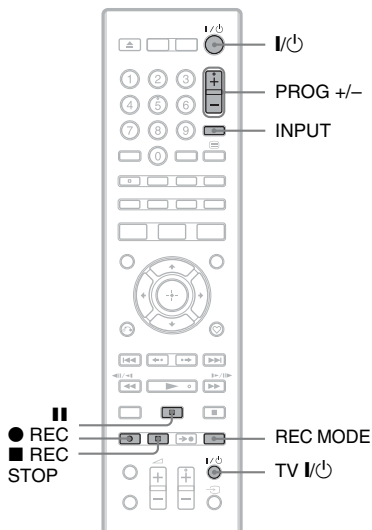

1 Turn on the recorder and your TV. Then switch the input selector on your TV so that the signal from the recorder appears on your TV screen.

2 Press PROG +/- to select the programme position or input source you want to record.

3 Press ● REC.

The recording mode is automatically set to DR mode, and recording starts.

To pause recording

Press ■ (pause).

To resume recording, press ● REC.

To change the recording mode (for analogue broadcasting only)

Press REC MODE repeatedly to select the recording mode before recording starts.

Each time you press the button, the display on the TV screen changes as follows:

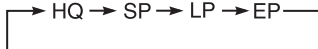

For more details about the recording mode, see page 109.

To watch another TV programme while recording

If your TV is connected to the ⇨ LINE 3 – TV jack, set your TV to the TV input using the TV/DVD button and select the programme you want to watch. If your TV is connected to the LINE 2 OUT or COMPONENT VIDEO OUT jacks, set the TV to TV input using the TV ⇨ button (page 22).



- After pressing the ● REC button, it may take a short while to start recording.
- It may take a short while for recorder to stop or pause recording.
- You cannot change the recording mode while recording.
- If there is a power failure, the programme you are recording may be erased.
- You cannot watch a PAY-TV/Canal Plus programme while recording another PAY-TV/Canal Plus programme.

To stop recording

Press ■ REC STOP.

Using the Quick Timer function

You can set the recorder to record in 30-minute increments.

Press ● REC repeatedly to set the duration.

Each press advances the time in 30-minute increments. The maximum duration is 8 hours.

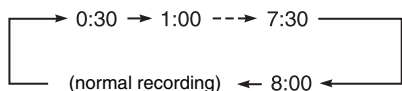

The time counter decreases minute by minute to 0:00, then the recorder stops recording.

To cancel the Quick Timer

Press ● REC repeatedly until the time counter disappears. The recorder returns to normal recording mode.

To stop recording, press ■ REC STOP.

Playing the Recorded Programme (Title List)



To play a recorded title, select the title from the Title List.



The recorder records TV programmes only to the HDD. To keep and enjoy programmes as a single DVD, record the programmes to the HDD, then dub them to a DVD (page 71).

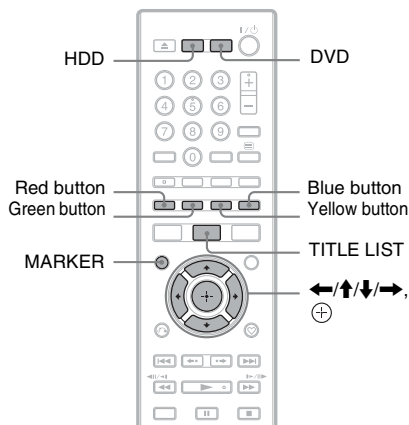

1 Press HDD or DVD.

If you select DVD, insert a DVD (see “Playing Discs and Recorded Programmes” on page 54).

Playback starts automatically depending on the disc.

2 Press TITLE LIST.

- Options applicable only to the selected media are displayed.
 - Only the options that are available during recording are displayed.
- Example: HDD

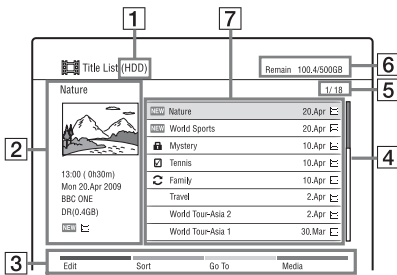

- 1** Media type: HDD or DVD
- 2** Preview of the selected title:
Displays the selected title's preview with information (title name, recording date and time, station name or programme number, recording mode, title size, and icons). For details on icons, see "Icons/Title name/Recording Date:" below.
- 3** Colour buttons:
Press the same colour button on the remote.
Red button ("Edit"): Allows you to erase/dub titles, etc.
Green button ("Sort"): Sorts titles by various options.
Yellow button ("Go To"): Switches the Title List to show Playlists (page 69) or "Visual Search."
Blue button ("Media"): Switches the list to the DivX List, Music List, or Photo List.
- 4** Scroll bar:
Appears when all of the titles do not fit on the list. To view the hidden titles, press \uparrow/\downarrow .
- 5** Title number/Total number of titles
- 6** Remaining capacity/Total capacity (approx.)

- 7** Icons/Title name/Recording Date:
: Indicates a protected title.
"NEW": Indicates that the title is newly recorded (not played back).
: Indicates that the title is recorded using the Update function.
Genre icons: Indicates the title's genre only when the title has genre information.

You can check each genre icon name. See "To search for programmes by genre (Genre)" on page 49.

: Select a title, and press MARKER. A check mark appears next to the selected title. You can then edit all the selected titles at once.

- 3** Select a title using \uparrow/\downarrow , and press \oplus .
Playback starts from the selected title.

To stop playback

Press (stop).

To scroll the list display by page (Page mode)

Press \lll/\ggg while the Title List is displayed. Each time you press \lll/\ggg , the Title List changes to the previous/next page of titles.

To change the title order

- 1** Press the green button ("Sort") while the Title List is displayed.
- 2** Select an item using \uparrow/\downarrow , and press \oplus .

Order	Sorted
By Date	In order of when the titles were recorded.
New*	In order of when unseen titles were recorded.
By Genre*	In order of genre.
By Name	In alphabetical order.
By Length	In order of recording length.

* HDD only

Visual Search

Select a title in the Title List, and press the yellow button “Go To” to select “Visual Search.”

Chapters in the selected title are displayed in the “Visual Search” display. Select a chapter using $\leftarrow/\uparrow/\downarrow/\rightarrow$, and press \oplus to play.

To turn off the Title List

Press TITLE LIST.



Each time you sort titles by the same sort method, the titles are sorted in ascending/descending order.



- The title names do not appear for DVDs created on other DVD recorders.
- It may take a few seconds for the thumbnail pictures to be displayed.

Watching TV programmes

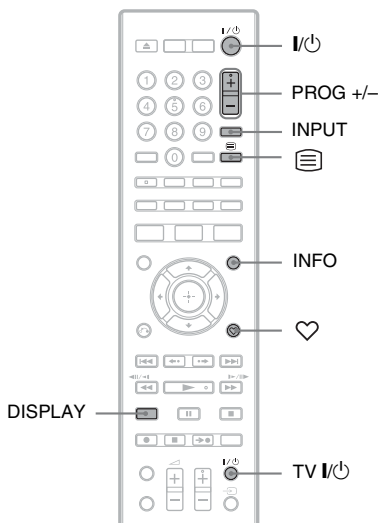

- 1** Turn on the recorder and your TV. Then switch the input selector on your TV so that the signal from the recorder appears on your TV screen.
- 2** Press PROG +/- to select the programme position or input source you want to watch.

To select a programme position using the Channel List (for digital broadcasting only)

- 1** While watching TV, press \oplus . The Channel List appears.
- 2** Select a programme position using \uparrow/\downarrow , and press \oplus . The selected programme is displayed.

To display the programme information (for digital broadcasting only)

While watching TV, press INFO.

The information display appears showing a description of the current programme on view.

To switch the display between descriptions of the current and next programme, press **←/→**.

To view a Digital Text Service (for digital broadcasting only (not available in some areas))

Press **≡** (text) or the button indicated on screen by the broadcaster.

You can view the Teletext that comes simultaneously with certain programmes. To exit the Teletext service, press **≡** or follow the on-screen instructions.

Displaying the programme/ playback information



You can check various information on the current programme, title, chapter, track, file, or disc.

Press DISPLAY.

The displays differ depending on the situation.

Example: when playing a title on the HDD

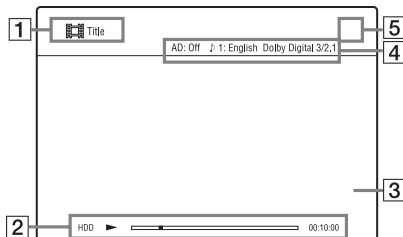

- 1 Programme Name/Title name
- 2 Status information
Displays media type/status bar/elapsed time
- 3 Various information (depends on the situation)

- 4 The currently selected function or audio setting (appears only temporarily)

Example: Dolby Digital 5.1ch

Audio description (narration) of visual information*

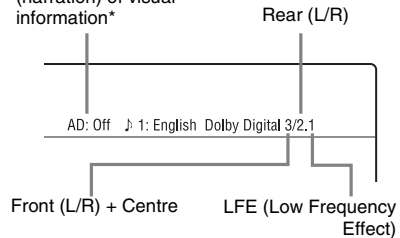

* Only when audio descriptions are provided. To select the audio description in the language you want, press AUDIO repeatedly. "On" appears when the audio description is output.

- 5 Channel number

Using the Favourites List (for digital broadcasting only)

The Favourite application gives you the option to:

- Store your favourite channels in one of four TV or four Radio lists.
- Add or delete channels to or from the Favourites List.
- Quickly display a favourite channel.

To set the Favourites List

- 1 Press **♥** (favourites) repeatedly to select a Favourites List. To switch the Favourites List to show TV or radio list, press TV/RADIO.
- 2 Press the green button ("Add"). All the TV or radio channels that are not in the Favourites List are displayed.

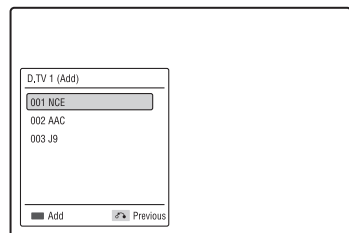

- 3** Select a channel you want to add to the Favourites List using **↑/↓**, and press the green button (“Add”).
The selected channel is added to the Favourites List.
- To remove a channel from the Favourites List, press the red button (“Remove”) after step 1. Then select a channel you want to remove from the Favourites List using **↑/↓**, and press the red button (“Remove”) again.
 - To scroll the list display by page, press **◀◀/▶▶**.
 - To go back to the Favourites List, press **↶** RETURN.

To watch or listen to a favourite channel

- 1** While watching TV, press **♥** repeatedly to select a Favourites List. To switch the Favourites List to show TV or radio list, press TV/RADIO.
- 2** Select a channel using **↑/↓**, and press **⊕**.
- To scroll the Favourites List display by page, press **◀◀/▶▶**.
 - To exit the Favourites List, press **↶** RETURN.

Recording to the HDD ("GUIDE Plus+")

Using the GUIDE Plus+ Display

The GUIDE Plus+® system is a free interactive programme guide. It displays up to 8 days of programme listings, including programme titles, promotions, and broadcast information. GUIDE Plus+ data for the television programme listings are carried by your local broadcast host channel and are received through your aerial. Visit www.europe.guideplus.com for a list of all European host channels.

These are just a few of the ways to use the GUIDE Plus+ system.

- Search for programmes by listing them according to category (such as Movies or Sport) or by using the Keyword Search function (page 39).
- Once you have found the programme you are looking for, use the GUIDE Plus+ system to set the timer for recording (page 38).
- You can set the system to display your favourite programmes according to conditions that you set, such as category and keyword (page 37).

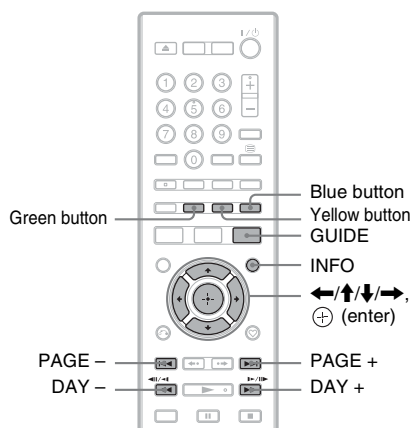

Press GUIDE.

The GUIDE Plus+ system "Home Screen" appears.

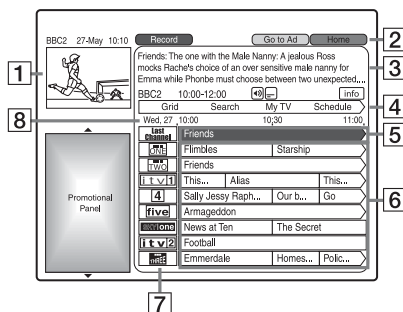

- 1 Video Window: This shows the programme you were watching when you pressed GUIDE.
- 2 Action Bar: When the same colour button on the remote is pressed, the Action Bar functions. The Action Bar function differs according to the screen.
- 3 Information Box: Shows information about the selected programme when the "Home Screen" is displayed. Contents will differ according to the displayed screen.
- 4 Menu Bar: Press the blue button ("Home"), and press **↑** to move the cursor to the Menu Bar. Then select one of the following features using **←/→**, and press **+** or **↓**.

"Grid": Shows the programmes for the current time slot and next 8 days.
 "Search": Allows you to search for titles by category or by keyword (page 39). The displayed category depends upon the programme data received by this recorder. Movies, Sport, and Children are examples of possible categories.
 "My TV": Sets the profile for your favourite programmes (page 37).
 "Schedule": Displays the list of timer settings (page 42).
 "Setup": Allows you to change the language, country/region, postal code, or recording timing (page 43).

- 5 "Home" position: When you press the blue button ("Home"), the cursor returns to the first page of the "Grid."
- 6 Tiles: Shows the programme titles. Select a programme using $\leftarrow/\uparrow/\downarrow/\rightarrow$, and press \oplus to watch the programme.
- 7 Broadcast station Logo: Shows the broadcast station logo.
- 8 Time Slot: Indicates the currently selected time slot. Use \leftarrow/\rightarrow to select a different time slot.

Available buttons in the GUIDE Plus+ system "Home Screen"

Buttons	Operations
Blue button ("Home")	Returns to the "Home" position on the "Grid."
GUIDE	Closes the GUIDE Plus+ system.
PAGE +/-	Changes the programme list by page.
DAY +/-	Changes the programme list by day.
INFO	Shows information about the selected programme.

To change the GUIDE Plus+ settings

See "Changing the GUIDE Plus+ System Settings (Setup)" on page 43.

Listing up your favourite programme information (My TV)

You can set a profile and list up only your favourite programme information.

- 1 Press **GUIDE**.
- 2 Press \uparrow to move the cursor to the Menu Bar.

3 Select "My TV" using \leftarrow/\rightarrow .

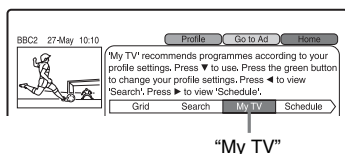

4 Press the green button ("Profile").

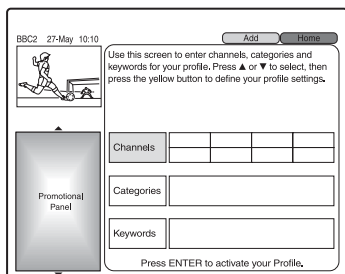

5 Select "Channels," "Categories," or "Keywords," and press the yellow button ("Add").

"Channels": Select the programme position using $\leftarrow/\uparrow/\downarrow/\rightarrow$, and press \oplus . To add more programme positions, press the yellow button ("Add"). You can register up to 16 programme positions.

"Categories": Select the category using $\leftarrow/\uparrow/\downarrow/\rightarrow$, and press \oplus . To add more categories, press the yellow button ("Add"). You can register up to 4 categories.

"Keywords": Enter a keyword. See "To enter a new keyword" on page 39. To add more keywords, press the yellow button ("Add"). You can register up to 16 keywords.

To cancel the registration, select an item, and press the red button ("Delete").

6 Press \oplus .

To change the profile settings

Repeat from step 3 above.

To select and watch a programme from "My TV"

- 1 After step 3 above, press \oplus .
The programmes that match the profile conditions are displayed.
- 2 Select a programme using $\leftarrow/\uparrow/\downarrow/\rightarrow$, and press \oplus .

One Button Recording (GUIDE Plus+)

HDD

You can use the GUIDE Plus+ system to set the timer to record a programme up to 8 days in advance.

You can set the timer for a total of 32 programmes using the GUIDE Plus+ system and the Timer List (page 50).

Before you start recording...

- Check that the HDD has enough available space for the recording (page 82). You can open up disc space by erasing titles (page 67).



The recording destination is HDD only.

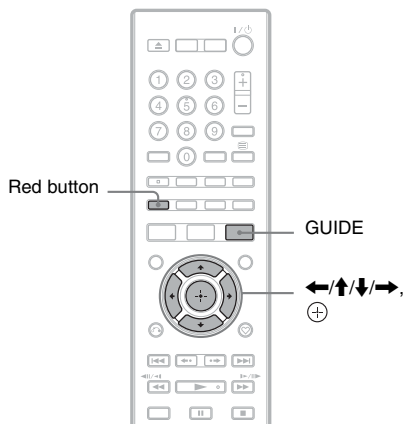

1 Press GUIDE.

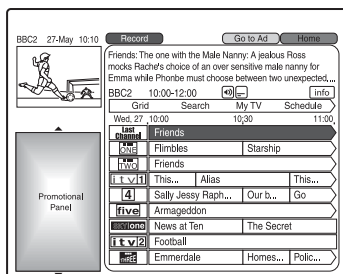

2 Select a programme using $\leftarrow/\uparrow/\downarrow/\rightarrow$.

3 Press the red button ("Record").

The set programme and Time Slot change colour and the recorder is ready to start recording.

Unlike a VCR, there is no need to turn off the recorder before the timer recording starts.



To cancel the timer recording, select the programme set for timer recording, and press the red button ("Cancel").

To search for a programme

- 1 Press **↑** to move the cursor to the Menu Bar while the GUIDE Plus+ system "Home Screen" is displayed.
- 2 Select "Search" using **←/→**.

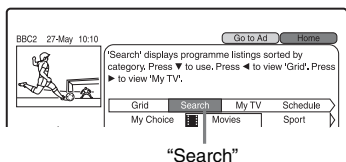

- 3 Press **↓**.
- 4 Select a category or "My Choice" using **←/→**.
When you select "My Choice," you can search for a programme by keyword. To enter a new keyword, see page 39.
- 5 Select a sub-category or keyword using **↑/↓**, and press **⊕**.
Programmes that meet the conditions are listed.
When searching by keyword, programmes that contain the keyword in the programme's title and in the programme's Information Box are listed.
- 6 Select a programme using **↑/↓**, and press **⊕**.

To enter a new keyword

- 1 After step 3 of "To search for a programme," select "My Choice" using **←/→**.
- 2 Press the yellow button ("Add").
The display for entering characters appears.

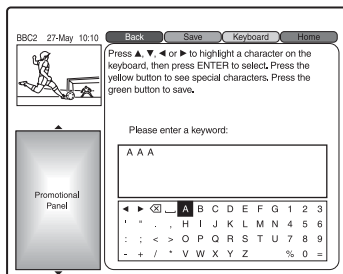

- 3 Select a character on the keyboard using **←/→/↑/↓**, and press **⊕**.
To switch between upper-case, lower-case, or characters with accents, press the yellow button ("Keyboard") repeatedly.
To cancel entering a new keyword, press the red button ("Back").
- 4 Repeat step 3 to enter the keyword.
- 5 Press the green button ("Save").
The entered keyword is registered.
To delete the keyword, select the keyword you want to delete, and press the red button ("Delete").
To change the keyword, select the keyword you want to change, and press the green button ("Edit").
- 6 Go to step 5 of "To search for a programme" on page 39.



When two or more keywords are set for "My Choice," you can select "All" for sub-category.

To confirm, change, or cancel a timer recording

See "Checking/Changing/Canceling Timer Settings (Schedule)" on page 42.

To stop recording during timer recording

Press **■** REC STOP.

Note that it may take a few seconds for the recorder to stop recording.

Recording Programmes Using Series Recording

HDD

Series Recording is a feature which allows you to automatically record programmes in a series, using the information from the GUIDE Plus+ system. You can also search for programmes related to the timer settings.



This function cannot be used when the GUIDE Plus+ system does not include series information with the programme data.

1 Press GUIDE.

2 Select a programme using ←/↑/↓/→.

Press INFO to display the programme's detailed information. You can check whether the selected programme has series information or not.

- Press the yellow button ("More") when the "More" button in the on-screen display is activated. Further information is available.

3 Press the red button ("Record").

4 Press the green button ("Schedule").

5 Press the green button ("Frequency") to select "Series."

The set programme and Time Slot change colour. The other programmes in the series will be set for recording as each previous recording is completed.

: Indicates that the programme is set to be recorded using Series Recording.

: Movies and other programmes that are split into 2 or more parts are called Split Programmes. If one part of a Split Programme is set to be recorded, the other parts will be recorded automatically.

- To modify the timer setting, see page 42.

6 Press GUIDE to exit the GUIDE Plus+ system.

The recorder is ready to start recording.

To search for programmes related to the timer settings

When you set timer recording for a programme that has series information, you can search for related programmes such as listed below.

To use this function, press the yellow button ("More") in step 2 above.

- Repeat programmes: You can search for repeat broadcasts of the programme which is set for timer recording (Alternative Times).
- Programmes in a series: You can search for the next programme in the series of a programme which is set for timer recording (Upcoming Episodes).
- Recommended programmes: You can search for recommended programmes linked to the programme which is set for timer recording (Recommendations).
- Split programmes: You can search for other parts of the split programme which is set for timer recording (Parts).

Setting the Timer Manually (Schedule)

HDD

You can set the timer for a total of 32 programmes using the GUIDE Plus+ system and the Timer List (page 50), up to 30 days in advance.

Before you start recording...

- Check that the HDD has enough available space for the recording (page 82). You can open up disc space by erasing titles (page 67).



The recording destination is HDD only.

- 1 Press TIMER.**
The schedule list appears.
- 2 Press the green button ("Manual").**

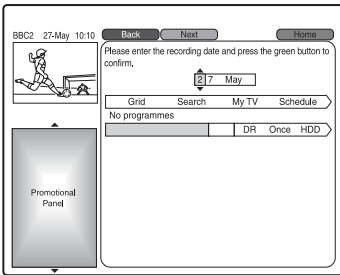

- 3 Set the blue-highlighted date using the number buttons and ←/↑/↓/→. Then press the green button ("Next").**

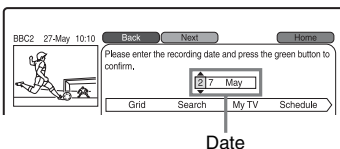

- 4 Set the start time using the number buttons and ←/↑/↓/→. Then press the green button ("Next").**
- 5 Set the stop time using the number buttons and ←/↑/↓/→. Then press the green button ("Next").**

- 6 Confirm the input source and press →, then select the programme position using the number buttons or ↑/↓.**

- 7 Press the green button ("Next").**
The display for entering characters appears. You can change the title name, if necessary.

- 8 Press the green button ("Save").**
The date, start and stop times, programme position, etc. settings appear.

- 9 Press the green button ("Frequency") repeatedly to set the recording frequency.**

- 10 Press → to display "Timing," then press the yellow button ("Timing") repeatedly to adjust the recording start/end time.**

When "Timing" is set to "<5/20>," the recording starts 5 minutes before the scheduled recording start time, and ends 20 minutes after the scheduled recording end time.

- 11 Press GUIDE to exit the GUIDE Plus+ system.**

The recorder is ready to start recording.

- To modify the timer setting, see page 42.

To stop recording during timer recording

Press ■ REC STOP.

Note that it may take a few seconds for the recorder to stop recording.



The title name may be displayed differently in the Title List from the one displayed when you set the timer.

Setting the timer manually (Timer List)

You can also use the Timer List to set the timer manually.

- 1 Press **INPUT** to switch between digital or analogue broadcasting.
- 2 Press **SYSTEM MENU**.
The System Menu appears.
- 3 Select "Timer Recording" using **↑/↓**, and press **⊕**.
- 4 Select "Timer List" using **↑/↓**, and press **⊕**.
The "Timer List" display appears.
- 5 Follow steps 3 to 5 of "Setting the Timer Manually (Manual)" on page 50.



When a timer setting in the Timer List overlaps another timer setting, check the timer setting on the schedule list (page 42).

To check/change/cancel timer settings (Timer List)

- 1 Press **SYSTEM MENU**.
The System Menu appears.
- 2 Select "Timer Recording" using **↑/↓**, and press **⊕**.
- 3 Select "Timer List" using **↑/↓**, and press **⊕**.
The "Timer List" display appears.
- 4 Follow steps 2 to 4 of "Checking/ changing timer settings" on page 52 to check/change a timer setting.
Follow steps 2 and 3 of "Cancelling timer settings" on page 52 to cancel a timer setting.

Checking/Changing/ Cancelling Timer Settings (Schedule)

HDD

You can change or cancel timer settings using the schedule list.

Checking/changing timer settings

- 1 Press **TIMER**.
The schedule list appears.

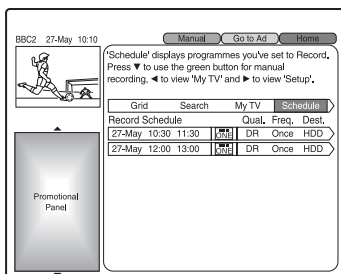

- 2 Select the timer setting you want to change using **↓**.
The selected timer setting is highlighted.
To change the setting, go to step 3.
If not changing the setting, go to step 6.
- 3 Press the green button ("Edit").

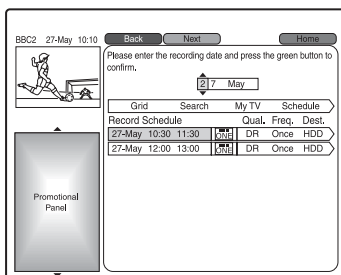

- 4 In the left column, select an item using the red button ("Back") or the green button ("Next"), and adjust using the number buttons or **←/↑/↓/→**.

- 5** Press the corresponding colour button repeatedly to change settings. To set the recording pattern, press the green button ("Frequency").
- 6** Press **→** to display "Timing."
- 7** Press the yellow button ("Timing") repeatedly to change the duration time.
- 8** Press **GUIDE** to exit the **GUIDE Plus+** system.
The new settings become effective.

Canceling timer settings

In step 2 of "Checking/changing timer settings," select the timer setting you want to cancel using **↑/↓**, and press the red button ("Delete").

To close the schedule list
Press **GUIDE**.

When the timer settings overlap

- The programme that starts first has priority and the entire programme is recorded.
- After finishing the previous recording, the other recording starts with several tens-of-second's delay (when the end-time of one recording and the start-time of another are the same).
- When the recordings start at the same time, only one of them will be recorded. Cancel the timer setting for the programme that you are not going to record.

Changing the GUIDE Plus+ System Settings (Setup)

You can change or reset the **GUIDE Plus+** system settings.

- 1** Press **GUIDE**.
- 2** Press **↑** to move the cursor to the Menu Bar.
- 3** Select "Setup" using **←/→**.
The **GUIDE Plus+** setup menu appears.

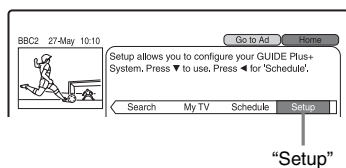

- 4** Press **↓**.
- 5** Select an item using **↑/↓**, and press **+**.

"Personal Preferences":

See "Language/Recording timing/Overnight Download settings (Personal Preferences)" on page 44.

"Start Installation Sequence":

See "Resetting the **GUIDE Plus+** system settings (Start Installation Sequence)" on page 44.

"Manual Data Download":

Use this function to download the **GUIDE Plus+** data manually when the **GUIDE Plus+** data is not displayed.

"**GUIDE Plus+** System Information":

You can check the **GUIDE Plus+** system information.

To cancel the settings

Press the red button ("Back").

Language/Recording timing/ Overnight Download settings (Personal Preferences)

You can select the language for the on-screen displays, set the recording timing to prevent the programmes being cut off at the start/end of the recording, or select whether to download the GUIDE Plus+ data at night.

- 1** In step 5 of “Changing the GUIDE Plus+ System Settings (Setup)” on page 43, select “Personal Preferences,” and press ⊕.
- 2** Select an item using ↑/↓, and press ⊕. Then set each item.
“Language”: Select a language for the on-screen display using ↑/↓, and press ⊕.
“Recording Timing”: Set the additional recording time before/after the scheduled recording start/end time using ↑/↓, and press ⊕.
“Overnight Download”: Select whether to download the GUIDE Plus+ data at night using ↑/↓, and press ⊕.

Resetting the GUIDE Plus+ system settings (Start Installation Sequence)

To reset the GUIDE Plus+ system settings, we recommend that you run “Easy Setup” again in “Initial Setup” (page 97). You can also reset country/region and postal code using the following procedure.
www.europe.guideplus.com

- 1** In step 5 of “Changing the GUIDE Plus+ System Settings (Setup)” on page 43, select “Start Installation Sequence,” and press ⊕.
The display asks for confirmation.
- 2** Select “Yes” using ↑/↓, and press ⊕.
- 3** Select a country/region using ↑/↓, and press ⊕.

- 4** Enter your postal code using ←/↑/↓/→, and press ⊕.

The recorder starts downloading the GUIDE Plus+ data.

A message appears when the download is finished.

- 5** Press ⊕.

Recording from Connected Equipment

HDD

You can record from a connected VCR or similar device. To connect a VCR or similar device, see "Connecting a VCR or Similar Device" on page 25.

1 Press INPUT to select an input source ("L1" or "L2") according to the connection you made.

2 Select the desired audio signal when recording a bilingual programme.

Set "External Audio" to "Bilingual" and "Bilingual Recording" to "A/L" or "B/R" in the "Audio In" setup (page 93).

3 Press REC MODE repeatedly to select the recording mode.

For details about the recording mode, see page 109.

4 Insert the source tape into the connected equipment and set to playback pause.

5 Press ● REC.

This recorder starts recording.

6 Press the pause (or play) button on the connected equipment to cancel the playback pause status.

The connected equipment starts playback and the playback image is recorded by this recorder.

To stop recording, press ■ REC STOP on this recorder.



- When recording a video game image, the screen may not be clear.
- Any programme that contains a Copy-Never copy guard signal cannot be recorded.
- When "Bilingual Rec. Mode (HDD)" is set to "Off" in the "Audio In" setup (page 93), only the audio signal selected in step 2 ("A/L" or "B/R") will be recorded. You will not be able to select the other audio signal during playback.
- You cannot select "L1" in step 1 if "LINE 3 Out [LINE 1 In]" is set to "Video [Decoder]" or "RGB [Decoder]" in the "Video In/Out" setup (page 91).

If you connect a DV camcorder with a DV IN jack

See "Dubbing from DV Camcorder" on page 78.

If you connect an HDD camcorder with a USB jack

See "Dubbing from HDD Camcorder" on page 75.

Recording to the HDD ("Freeview+")

Using the EPG (Electronic Programme Guide) Display

The Electronic Programme Guide is a guide showing the television programme schedule for a day or more at a time on your television.

The EPG provides a quick and easy way to:

- View a complete list of all available channels.
- View a channel list related to a chosen date or genre.
- Set a programme to be recorded (page 47).



- Digital Services availability and content depend on the broadcaster.
- Digital Services are not instantly available when the recorder is first turned on.

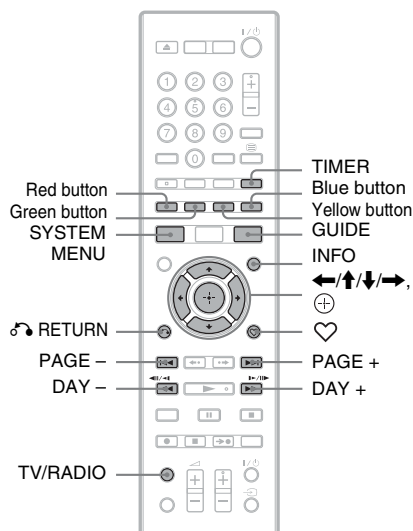

Press GUIDE.

This display consists of an information box and a 9-channel programme list covering a 30-minute period.

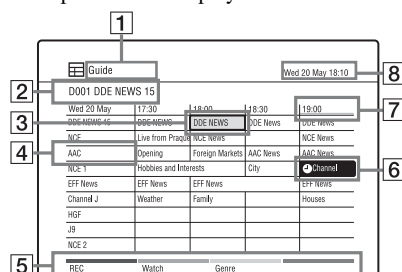

Example of EPG Display:



- 1 Current Genre/Favourites List/TV/Radio mode
- 2 Indicates the currently selected channel number and station name.
- 3 Indicates the currently selected programme and allows you to move around the list.
Press the green button ("Watch") to watch the selected programme.
- 4 Station name
Press the same colour button on the remote ("REC," "Watch," and "Genre").
- 5 Colour buttons
Press the same colour button on the remote ("REC," "Watch," and "Genre").
- 6 Indicates if a timer recording is associated with the programme (page 47).
- 7 Time slot
- 8 Indicates the current time and date.

Available buttons in the programme list

Buttons	Operations
←/↑/↓/→	Selects the desired item.
PAGE +/-	Displays the previous/next 9 channels.
DAY +/-	Displays the previous/next day's programme list.
TV/RADIO	Switches between TV and radio channels.

Buttons	Operations
♡	Displays the Favourites List.
INFO	Displays the detailed information of the selected programme.  : Indicates that the programme has parental control information (page 96).  : Indicates that the programme is pay-per-view.
Colour buttons (red, yellow, green, blue)	Activates the same colour function on the screen.
⊕	Displays the selected programme recording information to be recorded.
TIMER	Displays the Timer List to change timer settings.
↶ RETURN	Closes the EPG display and goes back to the previous display.
GUIDE/ SYSTEM MENU	Closes the EPG display.

Using the Digital Favourites List

You can display the favourite channels set in the Favourites List on the EPG display. To set your favourite channels to the Favourites List, see "Using the Favourites List (for digital broadcasting only)" on page 34.

While displaying the EPG, press ♡ repeatedly to select a Favourites List.

The selected Favourites List display appears. To switch the Favourites List to show TV or radio list, press TV/RADIO.

One Button Recording Using the EPG

HDD

The EPG function is a feature that simplifies setting the timer. Just select the programme you want to record in the EPG display. The date, time, and channel of that programme are set automatically.

You can set the timer for a total of 32 programmes, up to 8 days in advance.

Before you start recording...

- Check that the HDD has enough available space for the recording (page 82). You can open up disc space by erasing titles (page 67).



The recording destination is HDD only.

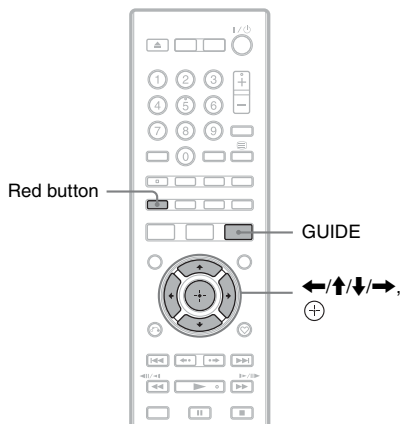

1 Press GUIDE.

Guide		Wed 20 May 18:10		
D001 DDE NEWS 15				
Wed 20 May	17:30	18:00	18:30	19:00
DDE NEWS 15	DDE NEWS	DDE NEWS	DDE News	DDE News
NCE	Live from Prague	NCE News	AAC News	NCE News
AAC	Opening	Foreign Markets	AAC News	AAC News
NCE 1	Hobbies and Interests	City	 Channel	
EFF News	EFF News	EFF News	EFF News	EFF News
Channel J	Weather	Family		House
HGF				
JB				
NCE 2				
REC	Watch	Genre		

2 Select a programme using ←/↑/↓/→.

3 Press the red button (“REC”).

“⏻” appears next to the programme which is set for timer recording. Your recorder will automatically begin recording when the programme starts. Unlike a VCR, there is no need to turn off the recorder before the timer recording starts.

- To modify the timer setting, see page 52.

To stop recording during timer recording

Press ■ REC STOP.

Note that it may take a few seconds for the recorder to stop recording.



- To cancel the timer recording, select the programme set for timer recording, and press the red button (“Cancel”).
- You can display the favourite channels set in the Favourites List on the EPG display (page 47).
- This recorder automatically adjusts the start/end recording time for the programme set for EPG timer recording even if the start/end time of the programme has changed.

Recording TV Programme Using the EPG

HDD

After selecting the programme you want to record in the EPG display, you can check the detailed settings for the timer.

You can set the timer for a total of 32 programmes, up to 8 days in advance.

Before you start recording...

- Check that the HDD has enough available space for the recording (page 82). You can open up disc space by erasing titles (page 67).



The recording destination is HDD only.

1 Press GUIDE.

2 Select a programme using ←/↑/↓/→.

3 Press ⊕.

The recording information appears.

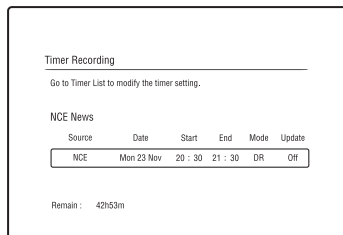

You can check the date, start and stop times, programme position, etc., settings.

4 Press ⊕.

“⏻” appears next to the programme which is set for timer recording. Your recorder will automatically begin recording when the programme starts. Unlike a VCR, there is no need to turn off the recorder before the timer recording starts.

- To modify the timer setting, see page 52.

To search for programmes by genre (Genre)

- 1 Press the yellow button ("Genre") while the programme list is displayed.
- 2 Select a genre using \uparrow/\downarrow , and press \oplus . Programmes that belong to the selected genre are displayed in the programme list.

To stop recording during timer recording

Press \blacksquare REC STOP.

Note that it may take a few seconds for the recorder to stop recording.



- To cancel the timer recording, select the programme set for timer recording, and press the red button ("Cancel").
- You can display the favourite channels set in the Favourites List on the EPG display (page 47).
- This recorder automatically adjusts the start/end recording time for the programme set for EPG timer recording even if the start/end time of the programme has changed.

Recording Programmes Using Series Recording (Models for the UK Only)

HDD

Series Recording is a feature which allows you to automatically record programmes in a series, using the information from the EPG. You can also search for programmes related to the timer settings.



This function cannot be used when the broadcaster does not include series information with the programme data.

- 1 Press GUIDE.
- 2 Select a programme containing series information using $\leftarrow/\uparrow/\downarrow/\rightarrow$.

The blue button ("Series Info.") in the on-screen display is activated when the selected programme has series information.

- 3 Press the blue button ("Series Info.").

The Series Information display appears.

Series Information		Sun 31 Jan 17:58	
NCE	News	5.Jan	14:00 - 14:40
AAC	Premiere	4.Jan	14:00 - 14:40
ESPN	News	3.Jan	14:30 - 15:30
BBC	Sports	23.Dec	15:00 - 15:30
NCE2	News	22.Dec	16:00 - 16:30
AAC	Weather	21.Dec	17:30 - 18:30
NCE	News	10.Oct	16:00 - 16:30
HGF	Sports	9.Oct	17:30 - 18:30

REC Recommend Series Rec.

"Recommended list":

Press the yellow button ("Recommend") when the "Recommend" button in the on-screen display is activated. The event is recommended by broadcaster as a link for current series. Note that recommended programmes will not be automatically set for recording with Series Recording.

4 Press the blue button (“Series Rec.”).

The selected programme is set for recording and appears in the Timer List. The other programmes in the series will be set for recording (appear in the Timer List) as each previous recording is completed.

🔴: Indicates that the programme is set to be recorded.

🔄: Indicates that the programme is set to be recorded using Series Recording.

• To modify the timer setting, see page 52.

About Split Programmes

Movies and other programmes that are split into 2 or more parts are called Split Programmes. If one part of a Split Programme is set to be recorded, the other parts will be recorded automatically.



Only the earliest part of the Split Programme is displayed on the Timer List.

About Alternate Programmes

When you try to set a timer recording for a programme that has series information and if the timer overlaps another timer setting, the recorder asks whether to search an alternate programme. Select “Yes” to set an alternate timer recording in the “Alternate Programme List.”



The message “Now searching...” appears on the Timer List when updating series information. The message disappears when no series information can be received.



To cancel the timer recording, select the programme set for timer recording, and press the red button (“Cancel”).

Setting the Timer Manually (Manual)

HDD

You can set the timer for a total of 32 programmes, up to 30 days in advance. Set the date, time, and programme position of the programme manually.

1 Press INPUT to switch between digital or analogue broadcasting.

2 Press TIMER.

The “Timer List” display appears.

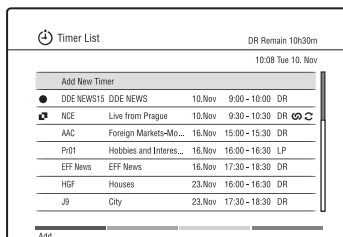

3 Select “Add New Timer,” and press the red button (“Add”).

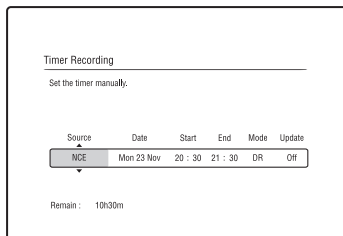

4 Select an item using ←/→ and adjust using ↑/↓.

The adjustable items are listed below.

“Source”: Sets the programme position. To switch between digital TV and radio channels, press TV/RADIO.

To switch the input source, press INPUT repeatedly.

“Date”: Sets the date (up to 30 days later). Select a recording pattern by pressing ↑ repeatedly to set the timer for the same daily or weekly programmes.

“Start”: Sets the start time.

“End”: Sets the stop time.

"Mode": Sets the recording mode (for analogue broadcasting only) (page 109).

"Update": Sets the recorder automatically, replacing the previous timer recording with the new one (only when "Date" is set daily or weekly).

- If you make a mistake, select the item and change the setting.

5 Press .

The "Timer List" display appears.

The timer recording indicator lights up on the front panel display and the recorder is ready to start recording.

- To record a satellite programme, turn on the satellite tuner and select the satellite programme you want to record. Leave the satellite tuner turned on until the recorder finishes recording.
- To modify the timer setting, see page 52.

To stop recording during timer recording

Press .

Note that it may take a few seconds for the recorder to stop recording.

To make the detailed settings

Press the corresponding colour button in step 4 above.

- Red button ("Rename"): The display for entering characters appears. To enter a character, see "Labelling a title (Rename)" on page 68.



You can display the detailed programme information on the "Timer List" using the INFO button.



- Check that the clock is correctly set before setting the timer recording. If not, the timer recording cannot be made.
- Even if the timer is set for the same daily or weekly programme, the timer recording cannot be made if it overlaps with a programme that has priority. " will appear next to the overlapped setting in the Timer List. Check the priority order of the settings (page 52).
- Even if the timer is set, timer recordings cannot be made while recording a programme that has priority.

Recording stereo and bilingual programmes

The recorder automatically receives and records stereo and bilingual programmes based on the ZWEITON system or the NICAM system.

When "Bilingual Rec. Mode (HDD)" is set to "On" in the "Audio In" setup (page 93), the HDD can record both main and sub sounds. You can switch between main and sub when playing the title.

When "Bilingual Rec. Mode (HDD)" is set to "Off" in the "Audio In" setup (page 93), the HDD can record only one sound track (main or sub) at a time.

Before recording starts, set "Bilingual Recording" to "A/L" (default) or "B/R" in the "Audio In" setup (page 94).

About HDD Recording format, see page 93.

ZWEITON (German stereo) system

When a stereo-based programme is received, "Stereo" appears.

When a bilingual ZWEITON-based programme is received, "A," "B," or "A+B" appears.

NICAM system

To record a NICAM programme, be sure to set "NICAM Select" to "NICAM" (default) in the "Audio In" setup. If the sound is not clear when listening to NICAM broadcasts, set "NICAM Select" to "Standard" (page 93).

Checking/Changing/ Cancelling Timer Settings (Timer List)

HDD

You can check, change, or cancel the timer settings using the Timer List.

Checking/changing timer settings



When you change the EPG timer settings, the update function turns off automatically.

1 Press **TIMER**.

The “Timer List” display appears. When all of the timer settings are not visible on the display, press **↑/↓** to view the hidden timer settings.

2 Select the timer setting you want to check/change, and press **⊕**.

3 Select an item using **←/→** and modify using **↑/↓**.

When you do not modify the timer setting, press **↵** RETURN to go back to the Timer List.

- (Models for the UK only) To change the Series Recording setting, press the blue button (“Series”) when the “Series” button in the on-screen display is activated. If you change the date or start and stop times, the Series Recording function will be cancelled.

4 Press **⊕**.

Cancelling timer settings

1 Press **TIMER**.

The “Timer List” display appears. When all of the timer settings are not visible on the display, press **↑/↓** to view the hidden timer settings.

2 Select the timer setting you want to cancel, and press the green button (“Erase”).

3 Select “OK,” and press **⊕**.

To turn off the Timer List

Press **SYSTEM MENU**.

When the timer settings overlap

- The programme that starts first has priority and the entire programme is recorded.
- After finishing the previous recording, the other recording starts with several tens-of-second’s delay (when the end-time of one recording and the start-time of another are the same).
- When the recordings start at the same time, only one of them will be recorded. Cancel the timer setting for the programme that you are not going to record.



- You cannot modify the timer setting for the current recording, but you can extend the duration of the recording time on the “Timer List” while recording (page 52).
- You can move to the previous/next page of the Timer List using **◀◀/▶▶** while the list is displayed.

Recording from Connected Equipment

You can record from a connected VCR or similar device. To connect a VCR or similar device, see “Connecting a VCR or Similar Device” on page 25.

For details, see page 45.

Playing Discs and Recorded Programmes

HDD +RW -RW/VR -RW/Video +R
 -R/VR -R/Video DVD VCD

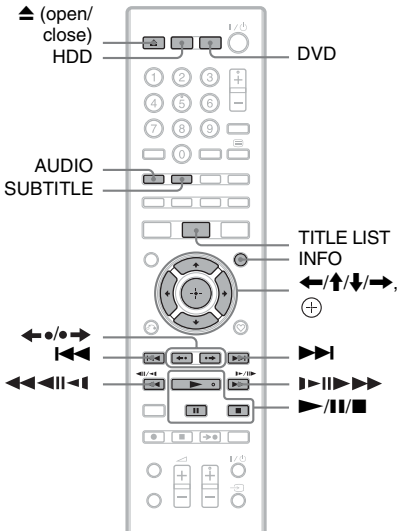

- 1 Press **HDD** or **DVD**.
When you press **HDD**, go to step 4.
- 2 Press **▲** (open/close), and place a disc on the disc tray.

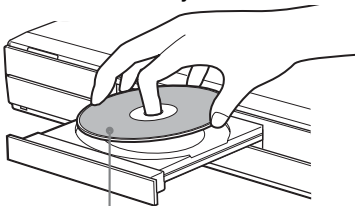

Playing side facing down

- 3 Press **▲** (open/close) to close the disc tray.

Wait until "LOADING" disappears from the front panel display.

- If you insert a DVD VIDEO or VIDEO CD, press **▶**. Playback starts.

- 4 Press **TITLE LIST**.

Example: HDD

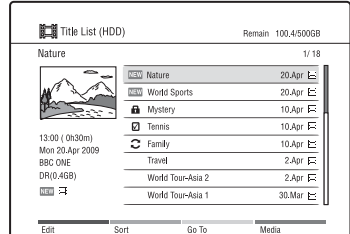

- 5 Select a title using **↑/↓**, and press **+** or **▶**.

Playback starts from the selected title.

To stop playback

Press **■** (stop).

To lock the disc tray (Child Lock)

You can lock the disc tray to prevent it being opened by mistake.

When the recorder is turned off, hold down **■** (stop) on the recorder until "LOCKED" appears in the front panel display. The disc tray is locked.

To unlock the disc tray, hold down **■** (stop) on the recorder until "UNLOCKED" appears in the front panel display.



When the Child Lock cannot be set, check that "Front Panel Display" is set to "On" (default) in the "System 2" setup (page 89).

To use the DVD's Menu

When you play a DVD VIDEO, DVD+RW, DVD+R, or a finalised DVD-RW (Video mode) or DVD-R (Video mode), you can display the disc's menu by pressing **TOP MENU** or **MENU**.

To play VIDEO CDs/Super VIDEO CDs with PBC (Playback Control) functions

- 1 Press TOP MENU to open the menu of the VIDEO CD/Super VIDEO CD.
- 2 Select an item using the number buttons.
- 3 Follow the instructions in the menu. Press  when "Press SELECT" appears.

To play restricted DVDs (Parental Lock)



If you play a restricted DVD, the display for entering your password appears on your TV screen.

Enter your four-digit password using the number buttons.

The recorder starts playback.

To register or change the password, see "Limitation Settings (Parental Lock)" on page 96.















One-Touch Play (for HDMI connection only)





Press . With one touch of the  button, the recorder and your TV automatically turn on and the TV's input is switched to the recorder. Playback starts automatically.





- When using the HDMI connection, there may be a delay, before the playback picture appears on the TV screen, and the beginning portion of the playback picture may not be displayed.
- To use the One-Touch Play function, set "Control for HDMI" to "On" (default) in the "System 1" setup (page 87).



Various video playback options

Buttons	Operations
AUDIO	Selects one of the audio tracks recorded on the disc when pressed repeatedly. For DVD VIDEOS or digital TV programmes recorded on the HDD, selects the language. For DVD-RWs/DVD-Rs (VR mode) or analogue TV programmes recorded on the HDD, selects the main or sub sound. For digital TV programmes recorded with audio descriptions, selects the audio description in the language you want. "On" appears when the audio description is output.
SUBTITLE	Selects a subtitle language when pressed repeatedly. When a four-digit language code is displayed, see "Language Code List" on page 111.
 (instant replay/instant advance)	Replays the scene/briefly fast forwards the scene.
 (previous/next)	Goes to the beginning of the previous/current/next title/chapter/track.
 (fast reverse/fast forward)	Fast reverses/fast forwards the disc. Search speed changes as follows: Fast forward  $\times 1.5^{*1}$ \rightarrow  1 \rightarrow  2 \rightarrow  3^{*2} \rightarrow  4^{*2} Fast reverse  1 \rightarrow  2 \rightarrow  3^{*2} \rightarrow  4^{*2} When you press and hold the button, fast forward/fast reverse continues at the selected speed until you release the button.
	^{*1} When you press  once during playback, you can play quickly with sound (Scan Audio) (not available for VIDEO CDs/Super VIDEO CDs).
	^{*2} Not available for VIDEO CDs/Super VIDEO CDs.
	To resume normal playback, press  .

Buttons	Operations
 * (slow, freeze frame)	Plays in slow motion when pressed for more than one second in pause mode. Plays one frame at a time when pressed briefly in pause mode. To resume normal playback, press  . * For VIDEO CDs/Super VIDEO CDs, playback direction only.
 (pause)	Pauses playback. To resume normal playback, press  .

To resume playback from the point where you stopped (Resume Play)

When you press  again after you stop playback, the recorder resumes playback from the point where you pressed .

To start from the beginning, press the red button (“Edit”) in the Title List to select “Resume Off,” and press . Then, press  to start playback from the beginning of the title/track/chapter.



The point where you stopped playing is cleared from memory when:

- you open the disc tray (except HDD).
- you turn off the recorder.
- you play another title (except HDD).
- you play a title other than that currently recorded during recording.

Pausing a TV broadcast (TV Pause/Pause Live TV)

You can pause a current TV broadcast that is tuned by the recorder and continue watching the programme at a later time. This is useful when you receive an unexpected phone call or visitor while watching TV.



1 While viewing a TV broadcast tuned by the recorder, press .

The picture pauses.

2 Press to resume watching the programme.

It may take a short while to start playback.



- Paused titles are not saved to the HDD.
- This function is cancelled when:
 -  (stop) is pressed.
 - PROG +/- is pressed.
 - DVD is pressed.
 - SYSTEM MENU is pressed.
 - TITLE LIST is pressed.
 - INPUT is pressed.
 - the recorder is turned off.
 - a timer recording is started.
 -  (open/close) is pressed.

Playing from the beginning of the programme you are recording (Chase Play)

HDD

Chase Play allows you to view the recorded part of a programme on the HDD while the recording is being made. You do not need to wait until the recording finishes.

Press while recording.

Playback starts from the beginning of the programme you are recording.

When you fast forward to the point that you are recording, Chase Play returns to normal playback.



You can record the programme for up to 3 hours.

Playing a previous recording while making another (Simultaneous Rec and Play)

HDD +RW -RWVR -RWVideo +R
-RVR -RVideo DVD VCD

“Simultaneous Rec and Play” allows you to play a disc or a previously recorded programme on the HDD while recording programmes. Playback continues even if a timer recording starts.

- 1 Press **TITLE LIST** during recording. The Title List appears.
 - To play a disc, press DVD and insert the disc beforehand.
- 2 Select a title to play, and press **+**. Playback starts from the selected title.

Searching for a time/title/ chapter/track, etc.

HDD +RW -RWVR -RWVideo +R
-RVR -RVideo DVD VCD

You can search a disc by title, chapter, or track. As titles and tracks are assigned individual numbers, select them by entering the appropriate number. You can also search for a scene using the time code.

- 1 Press **INFO** during playback.
- 2 Select a search method, using **↑/↓**.
 - “Title Search” (for HDD/DVDs)
 - “Chap.Search” (for HDD/DVDs)
 - “Track Search” (for VIDEO CDs*)
 - “Time Search” (for HDD/DVDs/ VIDEO CDs*): Searches for a starting point by entering the time code.

* When playing with PBC functions, cancel the functions by pressing **TITLE LIST** before step 1.

- 3 Select the number of the title, chapter, time code, etc., you want using the number buttons or **←/→**.

For example: Time Search

To find a scene at 2 hours, 10 minutes, and 20 seconds, enter “21020.”

If you make a mistake, select another number.

- 4 Press **+**. Playback starts from the selected number.

To close the “Play Mode” menu

Press **INFO**, **↶** RETURN, or **SYSTEM MENU**.

To make a favourite scene (HDD only)

You can have the recorder store specific portions of the title in memory and play immediately whenever you want. Up to 99 markings can be set.

- 1 Press **MARKER** during playback. The marker menu appears at the bottom of the screen.
- 2 Select a scene you want to mark using **▶**, **II**, or **◀◀/▶▶**.
- 3 Press the red button (“Add”) at the scene you want to mark. The marker is added. To search for the marked scene, press **←/→** or **◀◀/▶▶**. To delete a marker, select the marker using **←/→** or **◀◀/▶▶**, and press the green button (“Erase”). To exit the marker menu, press **MARKER** again.

Playing repeatedly (Repeat)

You can repeatedly play all the tracks or a single title/chapter/track on the HDD or a disc.

- 1 Press **INFO** during normal playback.
- 2 Select “Repeat” using **↑/↓**.

3 Select an item to be repeated using ←/→.

“Title” (for HDD/DVDs): repeats the current title.

“Chapter” (for HDD/DVDs): repeats the current chapter.

“Track” (for VIDEO CDs): repeats the current track.

“Disc” (for VIDEO CDs): repeats the entire disc.

4 Press ⊕.

Repeat play starts.

To play a specific portion repeatedly (Repeat A-B)

1 Select “A-B” in step 3.

2 Press ⊕.

The “Repeat A-B” display appears.

3 Press ⊕ again to set the starting point (point A).

4 Press ⊕ again to set the ending point (point B).

Repeat-A-B play starts.

To cancel Repeat play

Press CLEAR, or set “Repeat” to “Off” in the “Play Mode” menu.

To close the “Play Mode” menu

Press INFO, ⏪ RETURN, or SYSTEM MENU.



To play VIDEO CDs repeatedly, cancel the PBC functions by pressing TITLE LIST before step 1.



- Set the start and stop points for “Repeat A-B” within the same title.
- Sections shorter than 7 seconds cannot be set for “Repeat A-B.”

To change the angles

1 Press INFO during playback to select “Angle.”

2 Change the angles using ←/→, and press ⊕.



You can change the angles only when multi-angles are recorded on the DVD.

Playing DivX/Music/Photo Files

Copying DivX/music/photo files to the HDD

1 Connect the USB device to the USB jack on the recorder.

Refer to the operating instructions supplied with the USB device before connecting.

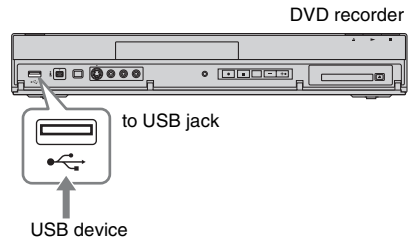

- Some USB devices may not work with this recorder.
- The recorder can recognise Mass Storage Class (MSC) devices that are FAT-compatible.

2 Press HDD.

3 Press SYSTEM MENU.

The System Menu appears.

4 Select “Media,” and press ⊕.

5 Select “USB,” and press ⊕.

6 Select a file type (“Video (DivX),” “Photo,” or “Music”), and press ⊕.

Select a USB partition, if necessary.

The DivX List, Photo List, or Music List appears.

7 Press the red button (“Edit”) to select “Copy,” and press ⊕.

The Copy List appears.

When copying photo files from a USB device, the display asks whether to categorise the data by date. Select “Yes” or “No.”

8 Select a folder or file/track to copy, and press MARKER.

A check mark appears by the selected item.

- To clear the check mark, press MARKER again.
- To select/unselect all items, press the yellow button (“Selection”) repeatedly.
- To change the item order, press the green button (“Sort”) to select “Name,” “Size,” or “Date” (for photo files only), and press ⊕.

9 Repeat step 8 to select all the folders or files/tracks you want to copy.

When you do not select a destination folder, skip steps 10 and 11.

10 Press →.

11 Select a copy destination (a folder) using ↑/↓, and press ⊕.

To create a new folder, press the green button (“New Folder”).

To change the folder name, press the yellow button (“Rename”) (page 68).

12 Press the red button (“Start Copy”).

The items are copied to the HDD.

To copy DivX/music/photo files to the HDD (DISC → HDD)

- 1 Press DVD, and insert a disc.
- 2 Press SYSTEM MENU.
The system menu appears.
- 3 Select “Media,” and press ⊕.
- 4 Follow steps 6 to 12 of “Copying DivX/music/photo files to the HDD” on page 58.

Notes on copying files

- Music files from a CD are converted to MP3 format. Names for music files are automatically labelled as “TRACK01,” “TRACK02,” etc.
- While copying files, other operations including timer recordings are unavailable. If the timer is set during copying, the recorder starts the timer recording after copying is finished.
- Some discs cannot be copied to the HDD.
- If the HDD becomes full during copying, a warning message appears. To erase unnecessary items on the DivX/Photo/Music List, select the item, and press the red button (“Edit”) to select “Erase,” then press ⊕.
- Copying music files from a CD will take more time than the actual playing time because the files are converted to MP3 format. For example, copying a 60-minute music CD will take approximately 70 minutes.

Playing DivX video files

HDD DATA DVD DATA CD

To play from the USB device, see page 65.

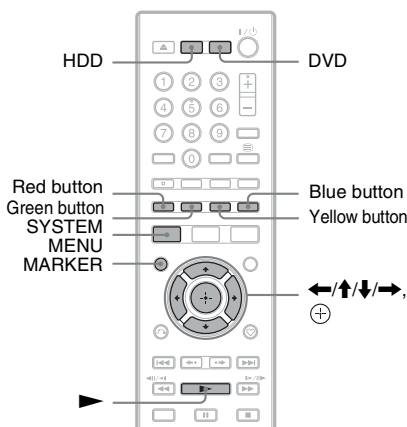

1 Press HDD or DVD.

When you select DVD, insert a disc (see “Playing Discs and Recorded Programmes” on page 54).

2 Press SYSTEM MENU.

The System Menu appears.

3 Select “Media,” and press ⊕.

4 Select “Video (DivX),” and press ⊕.

The DivX List appears.

Options applicable only to the selected media are displayed.

Example: HDD

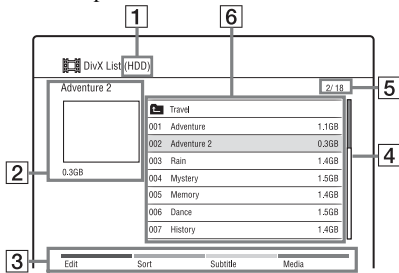

1 Media type: HDD, DVD, CD, or USB

2 Current folder/file name and file size

3 Colour buttons:

Press the same colour button on the remote.

Red button (“Edit”): Allows you to erase/copy folders/files, etc.

Green button (“Sort”): Sorts folders/files by name or size.

Yellow button (“Subtitle”): Allows you to select subtitle font. For example, select “Cyrillic (CP1251)” for Eastern European language when the text is garbled.

Blue button (“Media”): Switches the list to the Title List, Music List, or Photo List.

4 Scroll bar:

Appears when all of the folders/files do not fit on the list. To view the hidden items, press ↑/↓.

5 File number/Total number of files

6 Folder name/File name/File size: Select a folder/file and press MARKER. A check mark appears next to the selected folder/file. You can then edit all the selected folders/files at once.

To display a file list, select a folder, and press ⊕.

5 Select a file using ↑/↓, and press ⊕ or ►.

Playback starts.

To stop playback

Press ■ (stop).

To scroll the list display by page (Page mode)

See “To scroll the list display by page (Page mode)” on page 32.

Various playback options

Buttons	Operations
AUDIO*	Selects one of the audio tracks recorded on the disc when pressed repeatedly.
SUBTITLE*	Selects a subtitle language when pressed repeatedly. When a DivX file contains subtitles, you cannot select subtitles in other files.
◀•/•▶*	Replays the scene/briefly fast forwards the scene. (instant replay/instant advance)
◀◀/▶▶*	Goes to the beginning of the previous/current/next file. (previous/next)
◀◀/▶▶	Fast reverses/fast forwards the disc when pressed during playback. Search speed changes as follows: Fast forward ▶▶ 1 → ▶▶ 2 Fast reverse ◀◀ 1 → ◀◀ 2 When you press and hold the button, fast forward/fast reverse continues at the selected speed until you release the button. To resume normal playback, press ►.

Buttons	Operations
▶▶ ▶▶* (slow, freeze frame)	Plays in slow motion when pressed for more than one second in pause mode. Plays one frame at a time when pressed briefly in pause mode. To resume normal playback, press ▶▶ .
 (pause)	Pauses playback. To resume normal playback, press ▶▶ .

* DivX files only

To search for a file/time (DivX files only)

- 1 Press **INFO** during playback.
- 2 Select a search method using **↑/↓**.
“File Search”
“Time Search”: Searches for a starting point by entering the time code.
- 3 Select the number of the file or time code you want using the number buttons or **←/→**.
For example: Time Search
To find a scene at 2 hours, 10 minutes, and 20 seconds, enter “21020.”
If you make a mistake, select another number.
- 4 Press **+**.
Playback starts from the selected number.

To play a folder/file repeatedly (DivX files only)

- 1 Press **INFO** during playback.
- 2 Select “Repeat” using **↑/↓**.
- 3 Select an item to be repeated using **←/→**.
“Folder”: repeats the current folder.
“Title”: repeats the current file.
- 4 Press **+**.
Repeat play starts.
To cancel repeat play, select “Off” in step 3 or press **CLEAR**.

To display playback information

See “Displaying the programme/playback information” on page 34.

Playing music CDs and MP3

HDD **CD** **DATA DVD** **DATA CD**

To play from the USB device, see page 65.

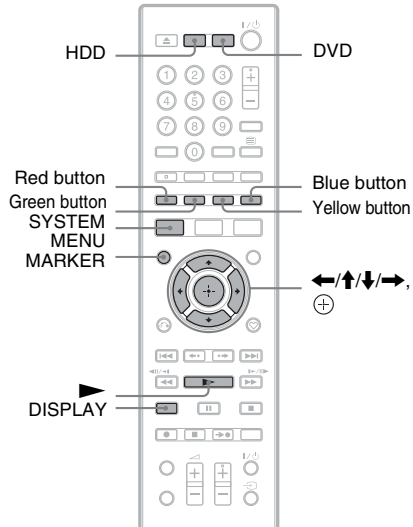

- 1 **Press HDD or DVD.**
When you select DVD, insert a disc (see “Playing Discs and Recorded Programmes” on page 54).
- 2 **Press SYSTEM MENU.**
The System Menu appears.
- 3 **Select “Media,” and press +.**
- 4 **Select “Music,” and press +.**
The Music List appears.
Options applicable only to the selected media are displayed.

Playback

Example: HDD

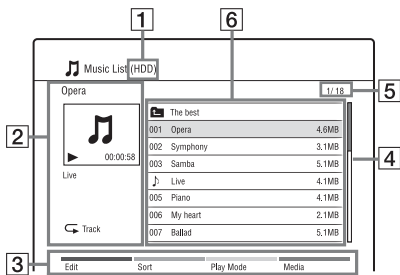

- 1 Media type: HDD, DVD, CD, or USB
- 2 Current folder/track/file name and playback information
- 3 Colour buttons:
Press the same colour button on the remote.
Red button (“Edit”): Allows you to erase/copy folders/tracks/files, switch to the Playlist (page 62), etc.
Green button (“Sort”): Sorts files by name or size.
Yellow button (“Play Mode”): Allows you to set play mode (Repeat Play or Shuffle Play).
Blue button (“Media”): Switches the list to the Title List, DivX List, or Photo List.
- 4 Scroll bar:
Appears when all of the folders/tracks/files do not fit on the list. To view the hidden folders/tracks/files, press \uparrow/\downarrow .
- 5 Track/file number/Total number of tracks/files
- 6 Folder name/Track/file name/
Playing time or file size:
“♪”: Indicates the currently playing track/file.
“☑”: Select a folder/track/file, and press MARKER. A check mark appears next to the selected folder/track/file. You can then edit all the selected folders/tracks/files at once. To display a track/file list, select a folder using \uparrow/\downarrow , and press \oplus .

- 5 Select a track/file, and press \oplus or \blacktriangleright .
Playback starts.

To stop playback

Press \blacksquare (stop).

To scroll the list display by page (Page mode)

See “To scroll the list display by page (Page mode)” on page 32.

Various playback options

See “Various playback options” on page 60.

To display ID3 tag information

Select an MP3 file on the Music List, and press DISPLAY.

Press DISPLAY again to exit.

To create a Playlist

You can create Playlists on the HDD.

- 1 Press the red button (“Edit”) in the Music List to select “New Playlist,” and press \oplus .
The “New Playlist” display appears.
- 2 Select a file in the Music List (left) to add to the Playlist, and press \oplus .
To remove a file from the Playlist, press \blackrightarrow to select the file in the Playlist (right), and press \oplus .
To move the cursor back to the Music List (left), press \blackleftarrow .
- 3 Repeat step 2 to select all of the files you want to add to the Playlist.
- 4 Press the red button (“Save”).
The Playlist is saved and the display switches to the Playlist.
To go back to the Music List, press the blue button (“Music List”).

Notes on playing discs with a DTS sound track

DTS audio signals are output only through the DIGITAL OUT (COAXIAL) jack or HDMI OUT jack.

When you play a disc with DTS sound tracks, set “DTS” to “On” in the “Audio Out” setup (page 95).

Playing photo files

HDD DATA DVD DATA CD

To view photo files from the USB device, see page 65.

If you have a Sony TV compatible with "PhotoTV HD," you can enjoy best quality images.

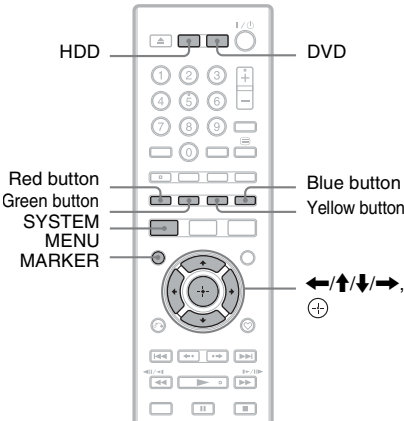

1 Press HDD or DVD.

When you select DVD, insert a disc (see "Playing Discs and Recorded Programmes" on page 54).

2 Press SYSTEM MENU.

The System Menu appears.

3 Select "Media," and press ⊕.

4 Select "Photo," and press ⊕.

The Photo List appears. Options applicable only to the selected media are displayed.

Example: HDD

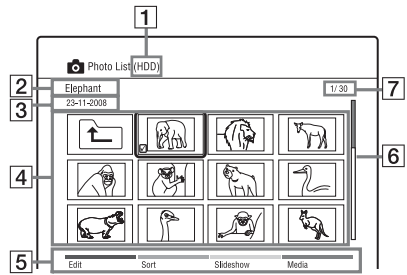

1 Media type: HDD, DVD, CD, or USB

2 Photo folder/file name

3 Date of photo folder/file

4 Photo folders/files

“”: Select a folder/file, and press MARKER. A check mark appears by the selected folder/file. You can then edit all the selected folders/files at once.

To display a photo file list, select a folder, and press ⊕.

5 Colour buttons:

Press the same colour button on the remote.

Red button (“Edit”): Allows you to erase/copy folders/files, etc.

Green button (“Sort”): Sorts files by name, date, or size.

Yellow button (“Slideshow”): Allows you to start a slideshow.

You can also play the slideshow with the sound (page 64).

Blue button (“Media”): Switches the list to the Title List, Music List, or DivX List.

6 Scroll bar:

Appears when all of the folders/files do not fit on the list. To view the hidden items, press ↑/↓.

7 Photo file number/Total number of photo files

5 Select a photo file, and press ⊕.

The photo file is displayed in full view.

- To view the previous/next image, press ◀◀/▶▶.
- To rotate the image, press the green button (“Rotate”).
- To start a slideshow from the current image, press ▶.
- To go back to the Photo List, press ⏪ RETURN.



When you select photo files using the MARKER button, only the selected photo files are played in full view or slideshow.



- Thumbnail images of some photo files may not be displayed.
- For DVD camcorder video files containing JPEG image files and movies, the recorder can play only the movie sections.

To scroll the list display by page (Page mode)

See “To scroll the list display by page (Page mode)” on page 32.

To zoom an image

- 1 Press ZOOM in full view.
- 2 Press ZOOM or ⊕ repeatedly to change the magnification.
Each time you press ZOOM or ⊕, the magnification changes as shown below.
2x → 4x → normal magnification

About “PhotoTV HD”

“PhotoTV HD” allows for a highly-detailed pictures, and photo-like expression of subtle textures and colours. By connecting Sony “PhotoTV HD” compatible devices using an HDMI cable, whole new world of photos can be enjoyed in breathtaking Full HD quality. For instance, the delicate texture of the human skin, flowers, sand and waves can now be displayed on a large screen in beautiful photo-like quality.

- 1 Connect the recorder to the TV using an HDMI cable (not supplied).
- 2 Set “HDMI Resolution” to “Auto (1080p)” or “1080i” in the “Video In/Out” setup (page 92).

- 3 Set the screen resolution of the TV to 1080p or 1080i.

When your TV is compatible with [VIDEO-A] mode, set the TV’s video/photo setting to [VIDEO-A] mode. For details, refer to the operating instructions supplied with the TV.

To play a slideshow with the sound (HDD only)

You can enjoy a slideshow while listening to the sound stored in the HDD. First prepare Music Playlists by adding audio tracks (see “To create a Playlist” on page 62).

- 1 After step 4 of “Playing photo files” on page 63, press the yellow button (“Slideshow”) while a file is highlighted and select “Effect Setting,” then press ⊕.
The “Effect Setting” display appears.
- 2 Select “BGM” or “Speed.”
- 3 Select the desired Music Playlist or speed using ◀/↑/↓/▶.
When there is no Music Playlist on the HDD, a Music Playlist cannot be selected. Select “Repeat All” to play all the files.
- 4 Select “Start,” and press ⊕.
The slideshow starts with the sound. To stop the slideshow, press ⏪ RETURN or ■ (stop).



- If there is no music file in the selected Music Playlist, the slideshow is played back with no sound.
- The “Effect Setting” setting will also be applied next time you play a slideshow. To play a slideshow without the sound, set “BGM” to “Off.”

To display the photo information

- 1 Press DISPLAY in full view or slideshow.
Photo file name and number are displayed.
The colour buttons are also displayed.
- 2 Press the corresponding colour button to rotate the photo, adjust the speed of the slideshow, etc.
- 3 Press DISPLAY again to turn off the information display.

Playing from the USB device

You can play DivX/music/photo files in the connected USB device.

1 Follow steps 1 to 6 of “Copying DivX/music/photo files to the HDD” on page 58.

2 Select a file, and press \oplus .

- For details on playing DivX video files, see page 59.
- For details on playing music files, see page 61.
- For details on playing photo files, see page 63.



Do not remove the USB device during operation. Stop playback and turn off the list menu beforehand.

Copying DivX/music/photo files to a disc

You can copy the edited DivX/music/photo files to a disc.

1 Insert a DVD-RW/DVD-R (Video mode).

2 Press **HDD**.

3 Press **SYSTEM MENU**.

The System Menu appears.

4 Select “Media,” and press \oplus .

5 Select a file type (“Video (DivX),” “Photo,” or “Music”), and press \oplus .

The DivX List, Photo List, or Music List appears.

6 Press the red button (“Edit”) to select “Copy,” and press \oplus .

The Copy List appears.

7 Select a folder or file to copy, and press **MARKER**.

A check mark appears by the selected item.

- To clear the check mark, press **MARKER** again.
- To select/unselect all items, press the yellow button (“Selection”) repeatedly.
- To change the item order, press the green button (“Sort”) to select “Name,” “Size,” or “Date” (for photo files only), and press \oplus .

8 Repeat step 7 to select all the folders or files you want to copy.

9 Press the red button (“Start Copy”).

The items are copied to the disc.

- To play the disc on other DVD equipment, finalise the disc. For details, see steps 2 to 7 of “Playing the Disc on Other DVD Equipment (Finalise)” on page 74.



To format DVD-RWs/DVD-Rs, see page 81.



- You cannot copy files on the HDD to USB devices.
- You cannot copy files to a recordable DVD that has been recorded using other recorders/devices.
- DATA DVDs finalised on this recorder may not be able to play on other equipment.
- You cannot copy a slideshow to a disc.
- When copying more than 2 folder layers, only up to 2 folder layers can be copied on to the disc.

Before Editing

You can edit titles on the HDD.



- Titles on DVDs cannot be edited. For DVD-RWs/DVD-Rs (VR mode), titles can be erased.
- You may lose the edited contents if you remove the disc or a timer recording starts while editing.
- If a message appears and indicates that the disc's control information is full, erase or edit unnecessary titles.
- The remaining disc space displayed on the screen may differ from the actual remaining disc space.
- You cannot erase or edit titles during recording.

Erasing and Editing a Title

This section explains the basic edit functions. Note that editing is irreversible. To edit titles without changing the original recordings, create a Playlist title (page 69).

1 Press TITLE LIST.

2 Select a title, and press the red button ("Edit").

The sub-menu appears.

3 Select an option, and press ⊕.

You can make the following edits to the title.

"Erase": Erases the selected titles (page 67).

"Dubbing": Displays the Dubbing List (page 71).

"Rename": Allows you to change the title name (page 68).

"Protection": Protects the selected titles.

"": appears next to the protected titles.

"A-B Erase": Erases a section of the title (page 67).

"Divide": Divides a title into two titles (page 68).

"New Playlist": Creates a playlist (page 69).

"Select All": Selects all titles.

"Unselect All": Clears all check marks.

Erasing a title (Erase)

HDD -RWVR -RVR

- 1 Press **TITLE LIST**.
- 2 Select the title you want to erase using **↑/↓**.
To erase the selected title only, go to step 5.
- 3 Press **MARKER**.
A check mark appears next to the selected title.
 - To clear the check mark, press **MARKER** again.
- 4 Repeat steps 2 and 3 to select all of the titles you want to erase.
- 5 Press the red button (“Edit”) to select “Erase,” and press **+**.
The display asks for confirmation.
- 6 Select “Yes,” and press **+**.
The selected titles are erased.



Titles on DVD+RWs/DVD+Rs or DVD-RWs/DVD-Rs (Video mode) cannot be erased.

Erasing a section of a title (A-B Erase)

HDD

You can select a section (scene) in a title and erase it. Note that erasing scenes in a title cannot be undone.

- 1 Press **TITLE LIST**.
- 2 Select the title you want to partially erase using **↑/↓**.

- 3 Press the red button (“Edit”) to select “A-B Erase,” and press **+**.

The “A-B Erase” display appears.

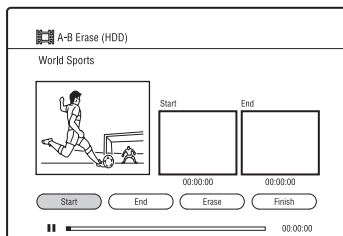

- 4 Press **▶** to start playback.
- 5 Select point A using **◀◀/▶▶**, etc., and press **+** (“Start”).
The start point (point A) is set.
- 6 Select point B, and press **+** (“End”).
The end point (point B) is set.
 - To reset either point A or B, select “Start” or “End” using **◀/▶**, and repeat from step 5 or 6.
- 7 Select “Erase,” and press **+**.
The display asks for confirmation.
- 8 Select “Yes,” and press **+**.
The scene is erased.
- 9 Select “Finish,” and press **+** to exit.

To cancel “A-B Erase”

Press **↶** RETURN. The Title List appears.



- Images or sound may be momentarily interrupted at the point where you erase a section of a title.
- Sections shorter than about 3 seconds may not be erased.

Dividing a title (Divide)

HDD

If you want to dub a long title to a disc but do not want to reduce the picture quality, divide the title into two shorter titles. Note that dividing a title cannot be undone.

- 1 Press **TITLE LIST**.
- 2 Select the title you want to divide into two titles using **↑/↓**.
- 3 Press the red button (“Edit”) to select “Divide,” and press **⊕**.
The “Divide” display appears.

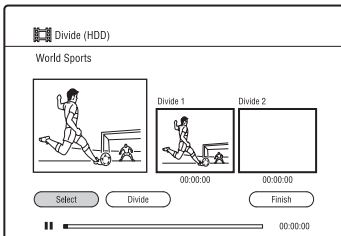

- 4 Press **▶** to start playback.
- 5 Select the dividing point using **◀◀/▶▶**, etc., and press **⊕** (“Select”).
The dividing point is set.
 - To reset the dividing point, select “Select” using **◀**, and repeat this step.
- 6 Select “Divide,” and press **⊕**.
The display asks for confirmation.
- 7 Select “Yes,” and press **⊕**.
The title is divided into two.

To cancel “Divide”

Press **↶** RETURN. The Title List appears.

Labelling a title (Rename)

HDD

- 1 Press **TITLE LIST**.
- 2 Select the title you want to rename using **↑/↓**.

- 3 Press the red button (“Edit”) to select “Rename,” and press **⊕**.

You can enter up to 31 characters.

Input row: the current name

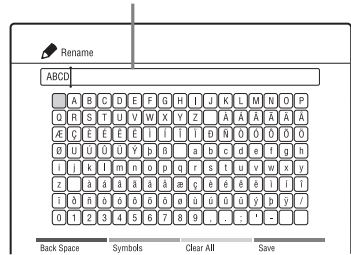

- 4 Move the cursor to the point where you want to insert the character using **◀/↑/↓/▶**.
 - To erase all of the characters, press the yellow button (“Clear All”).
- 5 Press **◀/↑/↓/▶** to select the character you want to enter, and press **⊕**.
The selected character appears at the input row.
 - To insert a space, select the empty key and press **⊕**.
 - To switch between alphabets and symbols, press the green button (“ABCabc”/“Symbols”).
 - To erase a character, move the cursor to the right of the character at the input row, and press the red button (“Back Space”).
 - To insert a character, move the cursor to the right of the point where you want to insert the character. Then select the character, and press **⊕**.
- 6 Press the blue button (“Save”).
To cancel the setting, press **↶** RETURN.



Only the characters displayed on the on-screen keyboard can be input with this recorder.

Creating and Editing a Playlist

Playlist edit allows you to edit or re-edit without changing the actual recordings. You can create up to 99 Playlist titles.



Playlist titles containing titles recorded with the "Copy-Once" copy protection signal cannot be dubbed or moved (page 110).

Creating a Playlist title

HDD

- 1 Press **TITLE LIST**.
- 2 Select the title you want to include in the Playlist title.
- 3 Press the red button ("Edit") to select "New Playlist," and press **+**.
The "New Playlist" display appears.

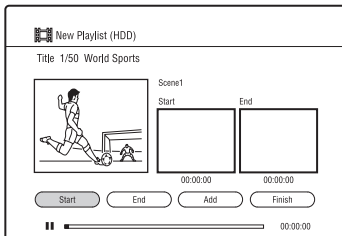

- 4 Press **▶** to start playback.
- 5 Select the start point using **◀◀/▶▶**, etc., and press **+** ("Start").
The start point is set.
- 6 Select the end point, and press **+** ("End").
The end point is set.
 - To reset either start or end point, select "Start" or "End" using **◀/▶**, and repeat from step 5 or 6.
- 7 Select "Add," and press **+**.
A scene for a Playlist title is created.
 - To add more scenes, repeat steps 5 to 7.
 - To add more scenes from another title, switch titles using **◀◀/▶▶**.

- 8 Select "Finish," and press **+**.
A Playlist title is added to the Playlist.

To cancel "New Playlist"

Press **↶** RETURN. The Title List appears.

To play a Playlist title

You can play a Playlist title on the HDD or a DVD-RW/DVD-R (VR mode).

- 1 Press the yellow button ("Go To") while the Title List is displayed.
- 2 Select "Playlist" using **↑/↓**, and press **+**.
To go back to the Title List, press the yellow button ("Title List") again.
- 3 Select a Playlist title using **↑/↓**, and press **+**.
Playback starts from the selected title.



You can search for a Playlist title using the INFO button during playback ("Playlist Search").

To change the Playlist title order

- 1 Press the green button ("Sort") while the Playlist is displayed.
- 2 Select "By Date" or "By Name" using **↑/↓**, and press **+**.



You cannot make a Playlist title that contains scenes from both the titles in DR mode and the titles in other recording modes.

Erasing a Playlist title

HDD

- 1 Press **TITLE LIST**, and switch to the Playlist.
For details on switching to the Playlist, see "To play a Playlist title" on page 69.
- 2 Follow steps 2 to 6 of "Erasing a title (Erase)" on page 67.

Editing a Playlist title

HDD

- 1 Press TITLE LIST, and switch to the Playlist.**
For details on switching to the Playlist, see “To play a Playlist title” on page 69.
- 2 Select the Playlist title you want to edit using ↑/↓.**
- 3 Press the red button (“Edit”) to select “Edit Playlist,” and press ⊕.**
The Edit Playlist menu appears.

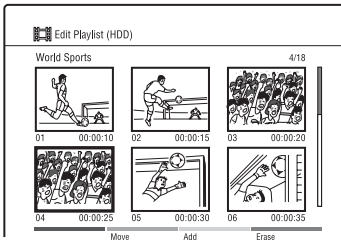

- 4 Select a scene you want to edit, using ←/↑/↓/→.**
To preview a scene, press ⊕.
- 5 Press the corresponding colour button.**
 - Green button (“Move”): Changes the scene order. Select a new location for the scene using ←/↑/↓/→, and press ⊕.
 - Yellow button (“Add”): Adds a scene. Select the location into which you want to insert the scene using ←/↑/↓/→, then follow steps 5 to 7 of “Creating a Playlist title” on page 69.
 - Blue button (“Erase”): Erases the scene.

To cancel “Edit Playlist”

Press ⏪ RETURN. The Playlist appears.

Before Dubbing

In this section, “dubbing” refers to “copying a recorded title on the internal hard disk drive (HDD) to another disc, or vice versa.” Before you start, read the following precautions, which are common to all dubbing methods.

Before you start...

- After you dub a title on the HDD to a DVD, the title cannot be edited on the DVD. Edit the title on the HDD beforehand.
- When you dub a Playlist title containing scenes in various recording modes and select “Original” for the dubbing mode, the selected title will be dubbed in the current recording mode for analogue broadcasting (the default setting is SP). To change the recording mode, select a dubbing mode other than “Original.”
- For titles containing scenes with various aspect ratios, dub on to DVD-RWs/DVD-Rs (VR mode) when dubbing from the HDD to DVDs.



When you dub a Playlist title, it is recorded as an Original title.



- Titles containing copy protection signals are moved. For details on “Move” function, see “Dubbing restriction” on page 110.
- No other operations are available during dubbing.
- Timer recordings do not start while dubbing. Before you start dubbing, check the Timer List for any timer recordings that are due to start during a dubbing.
- The chapter marks in the dubbing source are dubbed. The position of chapter marks may be slightly changed from the original.
- Depending on the DVD, the aspect ratio may change when the title is dubbed.

Dubbing from the HDD to a DVD (HDD → DVD)

HDD +RW -RWVR -RWVideo +R
-RVR -RVideo

You can select the titles you want to dub at 1× speed using Dubbing List.

- 1 Insert the DVD that you are going to dub to.**
See “Playing Discs and Recorded Programmes” on page 54.
- 2 Press HDD.**
- 3 Press TITLE LIST.**
- 4 Press the red button (“Edit”) to select “Dubbing,” and press ⊕.**
The Dubbing List appears.

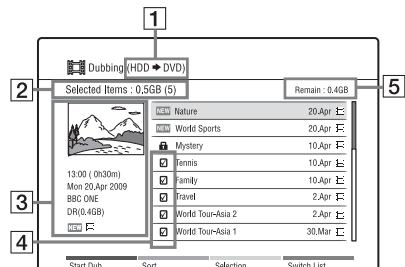

- 1** Direction of dubbing
- 2** Total size (number) of the selected titles
- 3** Detailed information of the selected title
- 4** Check mark
- 5** Available space on the disc to be dubbed (approximate)

5 Select a title you want to dub, and press **MARKER**.

A check mark appears next to the selected title.

- To cancel the selection, press **MARKER** again.
- To select/unselect all items, press the yellow button (“Selection”) to select “Select All” or “Unselect All,” and press ⊕.
- To switch between the Title List and the Playlist, press the blue button (“Switch List”).
- To change the title order, press the green button (“Sort”) to select “By Name,” “By Length,” etc., and press ⊕.

6 Repeat step 5 to select all of the titles you want to dub.

7 Press the red button (“Start Dub”).

The dubbing mode list appears.

8 Select a dubbing mode using ↑/↓, and press ⊕.

Dubbing starts.

For DVD-RWs/DVD-Rs (Video Mode)/DVD+Rs, the display asks for confirmation of finalisation after dubbing. If you select “Yes,” the disc will be finalised when the dubbing is finished.



To format a new DVD, see “Differences between disc types” on page 74.

About dubbing mode

- When you select “Original” in step 8,
 - Titles recorded in DR mode or Playlist titles containing scenes only in DR mode are all converted to 6 Mbps and dubbed.
 - Titles recorded in a recording mode other than DR mode are dubbed in the same mode as the recorded mode.
 - Playlist titles containing scenes in various recording modes are dubbed in the current recording mode for analogue broadcasting (the default setting is SP).

- When you select a dubbing mode other than “Original” in step 8, all the selected titles are dubbed in the selected dubbing mode. When you want to select a different dubbing mode for each title, dub titles one by one.
- The dubbing speed does not exceed the maximum dubbing speed of this recorder even when using discs that support higher dubbing speeds. In addition, depending on the disc condition, the recorder may be unable to dub at the maximum dubbing speed.

To display dubbing information

While dubbing at 1× speed, you can preview the title and check the dubbing information all the time. Press **DISPLAY** to hide the dubbing information.

While dubbing at high-speed, or when dubbing information is not displayed, press **DISPLAY** to check the dubbing information.



While dubbing at high-speed, you can watch TV programmes using the recorder’s tuner.

To cancel dubbing

- 1 Press **REC STOP**.
The display asks for confirmation.
- 2 Select “Yes,” and press ⊕.
When dubbing is stopped partway, no part of the title will be dubbed to the DVD. However, note that this will decrease the free space for DVD+Rs/DVD-Rs.



- Bilingual titles are dubbed in stereo. Only the audio signal that is selected in “Bilingual Recording” in the “Audio In” setup (page 94) (“A/L” (default) or “B/R”) is dubbed to the DVD. To dub a bilingual title in a recording mode other than DR with both main and sub sounds, dub each title to a DVD-VR in “Original” mode one by one.
- You cannot dub titles to finalised DVD-RWs/DVD-Rs/DVD+Rs. However, DVD-RWs finalised on this recorder can be dubbed again if you unfinalise the discs (page 82).
- Audio descriptions and subtitles are not dubbed on DVDs.
- Radio titles recorded on this recorder cannot be dubbed to a DVD.

Dubbing from a Finalised DVD to the HDD (DVD → HDD)



You can dub titles on a finalised DVD to the HDD.

1 Insert the finalised DVD that you are going to dub from.

See “Playing Discs and Recorded Programmes” on page 54.

2 Press DVD.

3 Press SYSTEM MENU.

The System Menu appears.

4 Select “Media,” and press ⊕.

5 Select “Video (Title),” and press ⊕.

6 Press the red button (“Edit”) to select “Dubbing,” and press ⊕.

The Dubbing List appears.

7 Select a title you want to dub, and press MARKER.

A check mark appears next to the selected title.

- To cancel the selection, press MARKER again.
- To select/unselect all items, press the yellow button (“Selection”) to select “Select All” or “Unselect All,” and press ⊕.

8 Repeat step 7 to select all of the titles you want to dub.

9 Press the red button (“Start Dub”).

The dubbing mode list appears.

10 Select a dubbing mode using ↑/↓, and press ⊕.

Dubbing starts.

To cancel dubbing

- 1 Press ■ REC STOP.
The display asks for confirmation.
- 2 Select “Yes,” and press ⊕.
When dubbing is stopped partway, no part of the title will be dubbed to the HDD.



- You cannot dub from DVD VIDEOS to the HDD.
- Bilingual titles are dubbed in stereo. Only the audio signal that is selected in “Bilingual Recording” in the “Audio In” setup (page 94) (“A/L” (default) or “B/R”) is dubbed to the HDD.



When you select “Original” in step 10, titles are dubbed in the same mode as the recorded mode.

Playing the Disc on Other DVD Equipment (Finalise)

-RWVR **-RW_{Video}** **+R** **-RVR** **-R_{Video}**

Finalising is necessary when you play discs dubbed with this recorder on other DVD equipment.

Before finalising, check the differences between the disc types in the table below.

Differences between disc types

+RW Finalising is unnecessary.

-RWVR Finalising is unnecessary when playing a disc on VR format compatible equipment. After finalising, you cannot edit or dub on the disc. However, a disc finalised on this recorder can be edited again if you unfinalise (page 82) or reformat (page 81) the disc. Note that if you reformat the disc, all dubbed contents will be erased. Even if your other DVD equipment is VR format compatible, you may need to finalise the disc, especially if the recording time is short.

-RW_{Video} Finalising is necessary when playing on any equipment other than this recorder. After finalising, you cannot dub on the disc. However, a disc finalised on this recorder can be dubbed again if you unfinalise (page 82) or reformat (page 81) the disc. Note that if you reformat the disc, all dubbed contents will be erased.

-RVR Finalising is necessary. The disc can be played only on equipment that supports DVD-R in VR mode. You cannot edit or dub on the disc after finalising.

+R
-R_{Video} Finalising is necessary when playing on any equipment other than this recorder. After finalising, you cannot dub on the disc.

- 1 Insert a disc.**
See “Playing Discs and Recorded Programmes” on page 54.
 - 2 Press SYSTEM MENU.**
The System Menu appears.
 - 3 Select “Disc Setup,” and press ⊕.**
 - 4 Select “Disc Information,” and press ⊕.**
The Disc Information display appears.
 - 5 Select “Finalise,” and press ⊕.**
 - 6 Select “Yes,” and press ⊕.**
The recorder starts finalising the disc.
 - 7 Press SYSTEM MENU to exit.**
-



For DVD+RWs/DVD+R or DVD-RW/DVD-R (Video mode), DVD menus are created.



- Depending on the condition of the disc or the DVD equipment, discs may not play even if the discs are finalised.
- The recorder may not be able to finalise the disc if it was recorded on another recorder.
- Inserting an unfinalised disc into other DVD equipment may damage the dubbed contents.

HDD/DV Camcorder Dubbing

Dubbing from HDD Camcorder

You can dub the contents of a Sony HDD camcorder to the hard disk drive of the recorder via the USB jack on the front panel. Methods to dub from the HDD camcorder include:

– One-Touch Dubbing

– Dubbing using the on-screen display

Follow the instructions in “Preparing for HDD camcorder dubbing,” and then move on to the section on dubbing.

Before you start HDD camcorder dubbing...

- Check that the HDD of the recorder has enough available space for the dubbing (page 82). You can open up disc space by erasing titles (page 67).
- The contents are dubbed in the current recording mode for analogue broadcasting and external input (the default setting is SP). To check or change the recording mode, press INPUT to switch the input source to analogue broadcasting or the external input, and press REC MODE repeatedly.



- If you want to dub by way of the LINE IN jacks, see “Recording from Connected Equipment” on page 45.
- If you want to dub the contents of the HDD camcorder on a DVD, dub them to the HDD of the recorder first, and then edit the title on the HDD and dub it to a DVD.
- Parts that have finished dubbing remain on the recorder when the disc space of the recorder becomes full or you stop dubbing partway.
- Dolby Digital 5.1ch audio recorded in the HDD camcorder is down-converted to 2ch audio when dubbed to the recorder.



- No timer recordings or other operations are available when dubbing from the HDD camcorder.
- The supported device is Sony HDD SD (standard definition) camcorder released in or before April 2009.
- The recorder does not support the AVCHD format (HD (high definition) image quality). You can dub MPEG-2 format images (SD (standard definition) images) only.
- When the HDD camcorder contains still images and moving images, only moving images can be dubbed to the recorder.
- Playlist made with the HDD camcorder cannot be dubbed to the recorder.
- When dubbing from the HDD camcorder, the recorder recognises and uses the shooting date and time information of the HDD camcorder. If the HDD camcorder’s clock is incorrect, the recorder may not dub the contents properly. Set the HDD camcorder’s clock correctly before shooting.
- You cannot record date, time, or the contents of the HDD camcorder memory onto the recorder.
- If you dub the contents recorded in high quality mode in the HDD camcorder to the recorder, it may take longer to finish dubbing than the recording.
- Set the recorder and HDD camcorder to the same colour system.
- When the total number of titles on the HDD of the recorder exceeds 999, you cannot dub the contents on the HDD camcorder to the recorder.

◆ How titles and chapters are created

In each dubbing operation, the contents dubbed to the recorder are divided into titles by the shooting date. If the date has been changed to the next day during one shooting session, the shot image is included in the title of the date when the shooting session started. The title is divided into chapters. Each shooting session on the HDD camcorder becomes a chapter.



The title names are automatically labelled as “USB *** (start time of the first shooting session).”



Even if the scenes are recorded on the same day, they are dubbed and divided into two or more titles when the total recording time exceeds 8 hours or the total number of scenes exceeds 99.

Preparing for HDD camcorder dubbing

Connect an HDD camcorder to the USB jack on the recorder.

Refer as well to the instruction manual supplied with the HDD camcorder before connecting.

- 1 Turn on your HDD camcorder and the recorder.
- 2 Connect your HDD camcorder to the USB jack on the front panel.

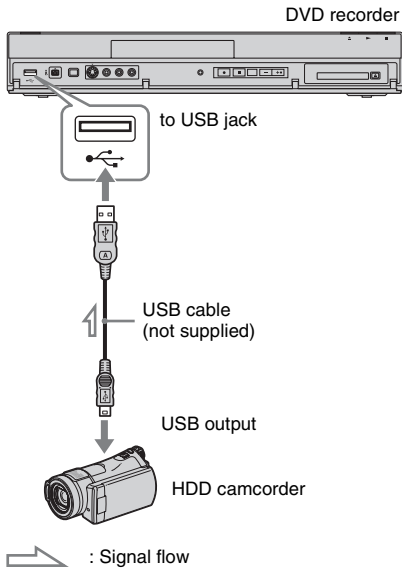

- 3 Set your HDD camcorder to the USB connection mode (example: "COMPUTER" or "USB CONNECT").

For details, refer to the operating instructions supplied with the HDD camcorder.



- Connect the HDD camcorder directly to the recorder.
- Do not disconnect the USB cable while dubbing.
- When signal input to the USB jack on the front panel or recorder operation cannot be performed correctly when using an HDD camcorder, connect the HDD camcorder to the LINE IN jack and follow the instructions of "Recording from Connected Equipment" on page 45.

One-Touch Dubbing from HDD camcorder (ONE-TOUCH DUB)

HDD

You can dub contents of your HDD camcorder onto the HDD of the recorder with a single press of the ONE-TOUCH DUB button on the recorder.

When dubbing from the HDD camcorder for the first time, all of the contents are dubbed to the recorder. The next time, only newly shot sessions that have not been dubbed yet are dubbed to the recorder.

Follow steps 1 to 3 of "Preparing for HDD camcorder dubbing" on page 76, and press ONE-TOUCH DUB on the recorder.

The recorder starts dubbing the contents on the HDD camcorder to the HDD Title List of the recorder.

To stop during dubbing

Press ■ REC STOP.

Note that it may take a few seconds for the recorder to stop dubbing.



- The one-touch dubbing button on the HDD camcorder does not function with the recorder.
- In One-Touch Dubbing, the contents that have already been dubbed to the recorder are not dubbed again even after you erase them from the recorder. To dub the same contents to the recorder again, reset the date and time for One-Touch Dubbing by performing "One-Touch Dubbing reset" in the "System 2" setup (page 89), then perform One-Touch Dubbing again.
- Data about the dubbed contents are all cleared when you reset the recorder (page 105).

Dubbing from HDD camcorder using the on-screen display (HDD-Cam Dubbing)

HDD

You can dub the contents of your HDD camcorder onto the HDD of the recorder using the on-screen display.

1 Follow steps 1 to 3 of “Preparing for HDD camcorder dubbing” on page 76.

2 Press **SYSTEM MENU**.

The System Menu appears.

3 Select “HDD-Cam/DV,” and press \oplus .

4 Select “HDD-Cam Dubbing,” and press \oplus .

5 Select “Yes” or “No” using \leftarrow/\rightarrow , and press \oplus .

When you select “Yes,” all the scenes on the HDD camcorder are sorted by date and put into a folder named with the date.

When you select “No,” a list of all the scenes on the HDD camcorder is displayed.

6 Select a scene/folder you want to dub to the recorder using $\leftarrow/\uparrow/\downarrow/\rightarrow$, and press **MARKER**.

A check mark appears next to the selected item.

- To clear the check mark, press **MARKER** again.
- To select/unselect all items, press the yellow button (“Selection”) to select “Select All” or “Unselect All,” and press \oplus .
- To preview a scene without sound, press \oplus . To exit the preview, press \blacksquare (stop).

7 Repeat step 6 to select all of the scenes/folders you want to dub.

8 Press the red button (“Start Dub”).

The recorder starts dubbing the contents on the HDD camcorder to the HDD Title List of the recorder.

To stop dubbing

Press \blacksquare **REC STOP**. Or, select “Cancel,” and press \oplus .



You can select up to 999 scenes to dub to the recorder at one time.

Dubbing from DV Camcorder

This section explains dubbing with a DV camcorder via the DV IN jack on the front panel. If you want to dub by way of the LINE IN jacks, see “Recording from Connected Equipment” on page 45.

The DV IN jack on this recorder conforms to the i.LINK standard.

Follow the instructions in “Preparing for DV camcorder dubbing,” and then move on to the section on dubbing. For more information about i.LINK, see “About i.LINK” on page 114.

Before you start DV camcorder dubbing...

- Check that the HDD of the recorder has enough available space for the dubbing (page 82). You can open up disc space by erasing titles (page 67).

◆ How chapters are created

The contents dubbed to the HDD become a single title. This title is divided into chapters. Chapters are created for each shooting session on the tape and each pause during dubbing.

To use this recorder’s auto chapter setting, be sure to correctly set the clock on your DV camcorder before shooting.

Preparing for DV camcorder dubbing

You can connect a DV camcorder to the DV IN jack on the recorder to dub or edit from a DV/Digital8 format tape. Operation is straightforward because the recorder will fast forward and rewind the tape for you – you do not need to operate your DV camcorder.

Refer as well to the instruction manual supplied with the DV camcorder before connecting.



- You cannot make a recording while DV camcorder dubbing.
- The DV IN jack is for input only. It will not output signals.
- You cannot use the DV IN jack when:
 - signal input to the DV IN jack on the front panel or recorder operation cannot be performed correctly when using a digital video camera (see “About i.LINK” on page 114). Connect the camera to the LINE IN jack and follow the instructions of “Recording from Connected Equipment” on page 45.
 - the input signal is not in DVC-SD format. Do not connect a MICRO MV format digital video camera even if it has an i.LINK jack.
 - the images on the tape contain copy protection signals, which limit recording.
- Set the recorder and DV camcorder to the same colour system (page 92).
- When the total number of titles on the HDD exceeds 999, you cannot dub the contents on the DV camcorder to the recorder.

Hookups

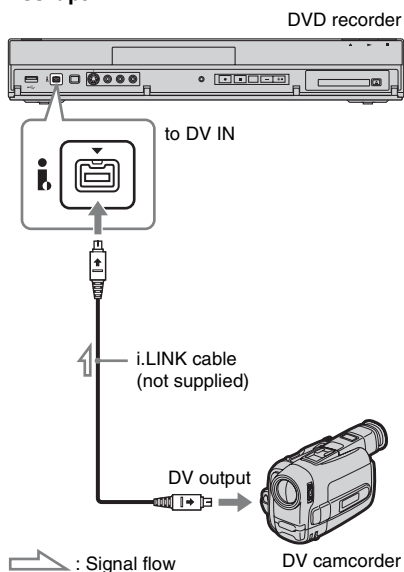

- 1 Insert the source DV/Digital8 format tape into your DV camcorder, and set the DV camcorder to video playback mode.

2 Press REC MODE on the remote repeatedly to select the recording mode.

To change the recording mode, press INPUT to switch the input source to analogue broadcasting or the external input beforehand.

For details about the recording mode, see page 109.

3 Set the “DV Input” setting in the “Audio In” setup (page 94).

You are ready to start dubbing. Select one of the dubbing methods on the following pages.



- You cannot connect more than one piece of digital video equipment to the recorder.
- You cannot control the recorder using another device or another recorder of the same model.
- You cannot dub date, time, or the contents of the cassette memory onto the HDD.
- If you dub from a DV/Digital8 format tape that is recorded in multiple sound tracks, such as a tape with multiple sampling frequencies (48 kHz, 44.1 kHz, or 32 kHz), no sound or an unnatural sound will be output when playing back the sampling frequency switch point on the disc.
- The recorded picture may be momentarily affected or the start and end points of a title may be different from what you have set if the source DV/Digital8 format tape is in any of the following conditions. In this case, connect your DV camcorder to the LINE IN jack and follow the instructions of “Recording from Connected Equipment” (page 45):
 - There is a blank space in the recorded portion of the tape.
 - The tape’s time code is not sequential.
 - If the picture size or the recording mode on the tape being dubbed changes.
- A blank or black coloured screen will be dubbed when the recorder is set to a different colour system from the DV tape contents’ system. Set “Input Colour System” in the “Video In/Out” setup to the same colour system as the DV tape contents’ system (page 92).
- When dubbing bilingual titles on the DV/Digital8 format tape, set “Bilingual Recording” to either “A/L” (default) or “B/R” in the “Audio In” setup (page 94).

One-Touch dubbing from DV camcorder (ONE-TOUCH DUB)

HDD

You can dub the entire contents of a DV/Digital8 format tape to the HDD with a single press of the ONE-TOUCH DUB button on the recorder. The recorder controls the DV camcorder for the whole process, and completes the dubbing.

Follow steps 1 to 3 of “Preparing for DV camcorder dubbing” on page 78, and press ONE-TOUCH DUB on the recorder.

The recorder rewinds the tape and then starts dubbing the tape contents.

After the dubbing is finished, the recorder rewinds the tape to the beginning.

To stop during dubbing

Press SYSTEM MENU.

Note that it may take a few seconds for the recorder to stop dubbing.



- The recorder will pause dubbing when there is a blank space or an image containing copy protection signals or signals in a different colour system from that of the recorder on the tape. The recorder will resume dubbing automatically when receiving a recordable signal within 5 minutes. Otherwise, DV One-Touch Dubbing ends automatically.
- DV One-Touch Dubbing ends automatically when the recorder cannot receive a recordable signal for 12 seconds at the beginning of the tape.
- If the HDD camcorder is also connected to the USB jack, dubbing from the HDD camcorder starts when you press the ONE-TOUCH DUB button. Disconnect the HDD camcorder from the USB jack to dub from the DV camcorder.
- When Timer recording is about to start during DV One-Touch Dubbing, a message appears. Follow the on-screen instructions.

Dubbing from DV camcorder using the on-screen display (DV Dubbing)

HDD

You can select and dub scenes while playing a DV/Digital8 format tape.

- 1 Follow steps 1 to 3 of “Preparing for DV camcorder dubbing” on page 78.
- 2 Press **SYSTEM MENU**.
The System Menu appears.
- 3 Select “HDD-Cam/DV,” and press **+**.
- 4 Select “DV Dubbing,” and press **+**.

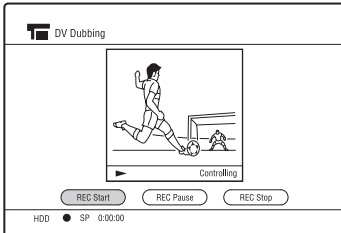

- 5 Find the point on the DV/Digital8 format tape that you want to start dubbing from using **◀◀/▶▶**, etc., and press **II**.
- 6 Select “REC Start,” and press **+**.
The recorder starts dubbing.
- 7 Select “REC Pause,” and press **+**.
The recorder pauses dubbing.
- 8 Press **▶** and repeat steps 5 to 7 to dub more scenes.
- 9 Select “REC Stop,” and press **+**.
The selected scenes are dubbed as a single title.

To exit “DV Dubbing”

Press **SYSTEM MENU**.



- You cannot set a scene to be shorter than one second.
- The recorder will pause recording when there is a blank space or an image containing copy protection signals or signals in a different colour system from that of the recorder on the tape. The recorder will resume recording automatically when receiving a recordable signal within 5 minutes. Otherwise, the recorder stops DV dubbing and exits to the System Menu.

Using the Disc Setup Menu (Disc Setup)

You can adjust HDD/DVD related settings.

- 1** Press **SYSTEM MENU** while the recorder is in stop mode or during playback.
- 2** Select “Disc Setup” using **↑/↓**, and press **+**.
- 3** Select the desired setup item using **↑/↓**, and press **+**.

See the explanations in the following sections.

Disc Settings (Disc Information)

You can check the disc information and use the following functions.

Example: When a DVD-RW (VR mode) is inserted.

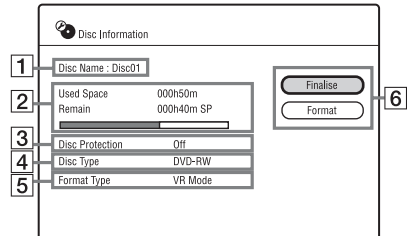

- 1** “Disc Name”
- 2** “Used Space”/“Remain” (approximate): Displays used/remaining time of the disc in current recording mode (example: SP mode).
- 3** “Disc Protection”: Displays whether protection is set.
- 4** “Disc Type”
- 5** “Format Type”: Displays the recording format.
- 6** Disc setting buttons
Available settings differ depending on the disc type.
“Finalise” (page 74)/“Unfinalise” (page 82)
“Format”: Formats a disc. For DVD-RWs, select a recording format (VR mode or Video mode) (page 74).

Unfinalise

You can unfinalise a disc when the disc is finalised.

For DVD-RWs (Video mode)

DVD-RWs (Video mode) that have been finalised to prohibit additional dubbing can be unfinalised to allow further dubbing.

For DVD-RWs (VR mode)

If you cannot edit on a DVD-RW (VR mode) that has been finalised with other DVD equipment, unfinalise the disc.



The recorder may not unfinalise DVD-RWs (Video mode) that have been finalised on another recorder.

- 1 Select “Unfinalise,” and press ⊕.
- 2 Select “Yes,” and press ⊕.
The recorder starts unfinalising the disc.
Unfinalising may take several minutes.
- 3 Press SYSTEM MENU to exit.

Formatting the HDD (HDD Formatting)

You can check used/remaining space of the HDD and use the following functions.

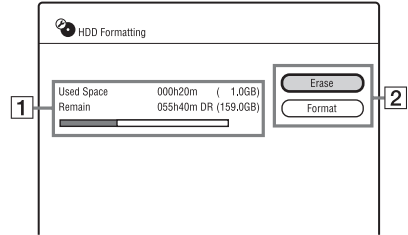

- 1 “Used Space”/“Remain” (approximate): Displays used/remaining time in current recording mode (example: DR mode) and used/remaining space on the HDD.
- 2 HDD setting buttons
“Erase”: Erases all titles (except protected titles) on the HDD.
“Format”: Formats the HDD to resolve the problem when the hard disk error occurred. All of the recorded content on the HDD will be erased.

Using the Setup Menus (Initial Setup)

You can change the settings of the recorder, such as channel settings, audio settings, etc.

- 1** Press **SYSTEM MENU** while the recorder is in stop mode or during playback.
- 2** Select "Initial Setup" using **↑/↓**, and press **⊕**.
- 3** Select the desired setup item using **↑/↓**, and press **⊕**.
See the explanations in the following sections.
The default settings are underlined.

Clock Setting

The recorder will automatically set the clock when any digital channels have been scanned and stored.

Auto Clock Setting

Turns on the Auto Clock Set function when a programme position in your local area broadcasts a time signal.

Select "On," and press **⊕**.

- If the recorder does not receive a time signal from any station, select "Off," and set the clock manually.

Manual Clock Setting

Set the day, month, year, hour, and minutes using **←/↑/↓/→**, and press **⊕** to start the clock.

Summer Time

Select "On" when you are now on summer time, and press **⊕**.

Aerial Reception Settings (Channel)

You can make tuner and channel settings for the recorder.

Auto Channel Setting

Presets channels automatically.

- 1 Select your country/region using \leftarrow/\rightarrow , and press \downarrow .
- 2 Select the channel type you want to preset using \leftarrow/\rightarrow , and press \downarrow .

All	Scans both digital and analogue channels.
Digital	Scans only digital channels.
Analog	Scans only analogue channels. When you select this, go to step 4.

- 3 Select an item using \uparrow/\downarrow , and change the settings using \leftarrow/\rightarrow or number buttons.
 - When you set “Digital Source” to “Antenna” in “Easy Setup” (page 23), set the following items.
 - “Service Type”: To scan all the channels including pay-per-view digital channels, select “All Services.” To scan only free channels, select “Free Services.”
 - “Start Frequency”/“End Frequency”: Set the start/end frequency for scan.
 - When you set “Digital Source” to “Cable” in “Easy Setup” (page 23), set the following items.
 - “Service Type”: See above.
 - “Scan Type”: Normally select “Quick Scan” for quick tuning. If no channel is found using “Quick Scan,” try “Full Scan” though it may take some time.
 - “Frequency”: Set this according to the information supplied from your cable provider.

– “Network ID”: Set this according to the information supplied from your cable provider. The recorder will receive the selected network.

- 4 Select “Start” using \uparrow/\downarrow , and press \oplus . The recorder starts scanning the channels.
- 5 Select “Yes,” and press \oplus . When you select “All” in step 2, the recorder proceeds to scan analogue channels.

To cancel scanning

Press \curvearrowright RETURN. When a result display appears, select “Yes” to save the result.



When you set channels using “Auto Channel Setting,” the timer settings in the Timer List will be erased.

Digital Manual Setting

Presets digital channels on a specific frequency.

When some digital terrestrial channels cannot be set using “Auto Channel Setting,” use this function to set them manually.

- 1 Select “Service Type” using \leftarrow/\rightarrow , and press \downarrow (page 84).
- 2 Set “Channel Number” using \leftarrow/\rightarrow . The “Frequency” and “Band width” will be adjusted accordingly. When you want to set “Frequency” and “Band width” manually, select the item using \uparrow/\downarrow , and change the settings using \leftarrow/\rightarrow or number buttons.
- 3 Select “Start” using \uparrow/\downarrow , and press \oplus . The recorder starts scanning the digital channels.
- 4 Select “Yes,” and press \oplus .

To cancel scanning

Press \curvearrowright RETURN. When a result display appears, select “Yes” to save the result.

Digital Channel List

Allows you to disable/enable or arrange the digital channels.

Select a channel using \uparrow/\downarrow , and press the corresponding colour button.

- Green button (“Disable”): Disables the selected channel. The disabled channel will not appear on the EPG display and will be skipped when you press PROG +/- . Press the red button (“Enable”) to enable the channel again.
- Yellow button (“Swap”): Changes the channel order. Select the channel you want to move, and press the yellow button (“Swap”). Then select another channel to swap positions with, and press the yellow button (“Swap”).
- Blue button (“Signal”): Displays the signal strength and the signal quality.

Analog Manual Setting

Allows you to edit, erase, or arrange the analogue channels.

- 1 Select a channel using \uparrow/\downarrow , and press the red button (“Edit”).
- 2 Select the item you want to change using \uparrow/\downarrow , and change the settings using \leftarrow/\rightarrow .
- 3 Press the red button (“Save”).
 - To preset another channel, repeat from step 1.
 - To erase a channel, select the channel, and press the green button (“Erase”).
 - To change the channel order, see “Digital Channel List” on page 85.

CH System

Select the region to get the best broadcast reception.

FR	Select this when in France.
Western Euro	Select this when in West European countries.
UK	Select this when in Great Britain.
Eastern Euro	Select this when in East European countries.

Channel

Press \leftarrow/\rightarrow repeatedly until the channel you want is displayed.

- To select a cable or satellite channel, press \leftarrow/\rightarrow until the channel you want is displayed.

◆ Receivable channels

TV system	Channel coverage
BG (West European Countries, except those listed below)	E2 – E12 VHF
	Italian A – H VHF
	E21 – E69 UHF
	S1 – S20 CATV
	S21 – S41 HYPER
	S01 – S05 CATV
DK (East European Countries)	R1 – R12 VHF
	R21 – R69 UHF
	S1 – S20 CATV
	S21 – S41 HYPER
	S01 – S05 CATV
I (Great Britain)	B21 – B69 UHF
	S1 – S20 CATV
	S21 – S41 HYPER
	S01 – S05 CATV
L* (France)	F2 – F10 VHF
	F21 – F69 UHF
	B – Q CATV
	S21 – S41 HYPER

* To receive broadcasts in France, select “L.”

◆ Tuning the French CATV channels

This recorder can scan the CATV channels B to Q and the HYPER frequency channels S21 to S41. On the Channel Set menu, the channels are indicated as CC1 to CC44. For example, channel B is indicated by Channel Set number CC1, and channel Q is indicated by Channel Set number CC23 (see the table below). If the CATV channel you want to preset is indicated by its frequency (for example, 152.75 MHz), refer to the table below to find the corresponding channel number.

Corresponding channel	Channel Set number	Receivable Frequency range (MHz)
B	CC1	116.75–124.75
C	CC2	124.75–132.75
D	CC3	132.75–140.75
D	CC4	140.75–148.75
E	CC5	148.75–156.75
F	CC6	156.75–164.75
F	CC7	164.75–172.75
G	CC8	172.75–180.75
H	CC9	180.75–188.75
H	CC10	188.75–196.75
I	CC11	196.75–204.75
J	CC12	204.75–212.75
J	CC13	212.75–220.75
K	CC14	220.75–228.75
L	CC15	228.75–236.75
L	CC16	236.75–244.75
M	CC17	244.75–252.75
N	CC18	252.75–260.75
N	CC19	260.75–268.75
O	CC20	268.75–276.75
P	CC21	276.75–284.75
P	CC22	284.75–292.75
Q	CC23	292.75–300.75
S21	CC24	299.25–307.25
S22	CC25	307.25–315.25
S23	CC26	315.25–323.25
S24	CC27	323.25–331.25
S25	CC28	331.25–339.25
S26	CC29	339.25–347.25
S27	CC30	347.25–355.25
S28	CC31	355.25–363.25
S29	CC32	363.25–371.25
S30	CC33	371.25–379.25
S31	CC34	379.25–387.25
S32	CC35	387.25–395.25
S33	CC36	395.25–403.25

Corresponding channel	Channel Set number	Receivable Frequency range (MHz)
S34	CC37	403.25–411.25
S35	CC38	411.25–419.25
S36	CC39	419.25–427.25
S37	CC40	427.25–435.25
S38	CC41	435.25–443.25
S39	CC42	443.25–451.25
S40	CC43	451.25–459.25
S41	CC44	459.25–467.25

AFT

On	Turns on the Auto Fine Tuning function. Normally select this position.
Off	Allows you to adjust the picture manually.

- If the Auto Fine Tuning function does not work effectively, select “Off” and press ↓ to select “Level.” Press ←/→ to obtain a clearer picture.

Sound System

Select an available TV system (page 85).

B/G	Select this when in West European countries, except those listed in “Receivable channels” on page 85.
D/K	Select this when in East European countries.
I	Select this when in Great Britain.
L	Select this when in France.

Name

Press ←/→ to change or enter a new station name. The recorder must receive channel information for station names to appear automatically.

To enter characters, see page 68.

Decoder

Sets the external decoder (PAY-TV/Canal Plus analogue decoder) channels.

For details, see page 28.

Recorder Settings (System 1)

Standby Mode

<u>Mode 1</u>	<p>When the recorder is turned off,</p> <ul style="list-style-type: none"> – Input signals from the LINE 1/DECODER jack are not output from the LINE 3 – TV jack (page 25) and the connected external decoder cannot be used (page 27). – Aerial input signals are not output to the connected TV. <p>To watch TV, use a splitter to divide aerial input signals between the TV and the recorder (page 16).</p>
<u>Mode 2</u>	<p>When the recorder is turned off, input signals from the LINE 1/DECODER jack are output from the LINE 3 – TV jack and aerial input signals are output to the connected TV. The standby power consumption is higher than that of “Mode 1.”</p>

Auto Power off

<u>On</u>	<p>The recorder automatically turns off when you do not press any buttons for 6 hours in stop mode. The display asks for confirmation about one minute before the recorder turns off. If you want to keep the recorder on, select “Cancel,” and press ⊕.</p>
<u>Off</u>	<p>Turns off the function.</p>

Auto Chapter

The recorder can automatically divide a recording (title) into chapters by inserting chapter marks. You can select chapter mark intervals or disable this function.

<u>Off</u>	<p>No chapter mark is inserted.</p>
<u>10 minutes</u>	<p>Inserts chapter marks at approximately 10-minute intervals.</p>
<u>15 minutes</u>	<p>Inserts chapter marks at approximately 15-minute intervals.</p>



- The actual chapter mark interval may vary depending on the amount of information contained in the video to be recorded.
- The “Auto Chapter” function is not available during dubbing.

EP Mode Time

Sets the maximum continuous recording time for recording in EP mode (only for analogue broadcasts or an external input).

<u>6 hours</u>	<p>Allows you to record continuously for 6 hours.</p>
<u>8 hours</u>	<p>Allows you to record continuously for 8 hours with lower picture quality.</p>

Control for HDMI

<u>On</u>	<p>Allows you to use the “Control for HDMI” function (page 20).</p>
<u>Off</u>	<p>Turns off the function.</p>

EPG Type Select

Selects the EPG (Electronic Programme Guide) type to use.

The default setting varies depending on the country/region.

GUIDE Plus+	Select this to use the Gemstar GUIDE Plus+ electronic programme guide (page 36).
Freeview+	Select this to use the digital electronic programme guide (page 46).



When you switch the EPG type, the timer settings that have been set will be erased.

DivX[®] Registration

Displays the registration code of DivX video files for this recorder.

ABOUT DIVX VIDEO-ON-DEMAND:

This DivX Certified[®] device must be registered in order to play DivX Video-on-Demand (VOD) content. Go to vod.divx.com with this code to complete the registration process and learn more about DivX VOD.

Version

You can check the software version.

Command Mode

Changes the Command Mode of the recorder to avoid interference with your other Sony DVD recorder or player.

- 1 Select a Command Mode (“1,” “2,” or “3 (Default setting)”), and press ⊕.



The default command mode setting for this recorder and the supplied remote is “3.” The remote does not function if different command modes are set for the recorder and remote. Set the same command mode. You can check the Command Mode for the recorder in the front panel display (page 13).

- 2 Set the Command Mode for the remote so it matches the Command Mode for the recorder you set above. Follow the steps below to set the Command Mode on the remote.
 - ① Hold down ⊕.
 - ② While holding down ⊕, enter the Command Mode code number using the number buttons.
 - ③ Hold down both the number and ⊕ buttons at the same time for more than three seconds.

Recorder Settings (System 2)

Software Update

You can check the current software version of the built-in digital tuner and keep it up to date with the latest software.

<u>Auto</u>	Updates the software automatically. Normally, select this position.
Off	Does not update the software automatically.
Start	Updates the software manually.



Do not turn off the recorder during updating the software.

CI Information (RDR-DC105/ DC205/DC305/DC505 only)

You can see the CI information. The displayed information differs depending on the CI module.

One-Touch Dubbing reset

Resets the date and time for One-Touch Dubbing from HDD camcorder. The recorder will dub all of the contents on the HDD camcorder next time you press the ONE-TOUCH DUB button. The display asks for confirmation.

Auto Finalisation

<u>On</u>	When you remove a disc from the recorder, the recorder automatically finalises the disc.
Off	Turns off the function.

Front Panel Display

Adjusts the lighting of the front panel display.

<u>On</u>	Bright lighting.
Off	Turns off the lighting and saves power consumption when the power is off.



When you select "Off," Child Lock is not available. To set the Child Lock, select "On."

Language Settings (Language)

You can make language settings.

OSD Language

Switches the display language on the screen.

DVD Menu (DVD VIDEO only)

Switches the language for the DVD menu.

DVD Audio (DVD VIDEO only)

Switches the language of the sound track. When you select “Original,” the language given priority in the disc is selected.

DVD Subtitle (DVD VIDEO only)

Switches the language of the subtitles recorded on the disc.

When you select “Audio Follow,” the subtitle language changes according to the language you selected for the sound track.

**D.TV Audio(Primary)/
D.TV Audio(Secondary)**

**D.TV Subtitle(Primary)/
D.TV Subtitle(Secondary)**

**D.TV Teletext(Primary)/
D.TV Teletext(Secondary)**

Selects main and sub audio, subtitle, or teletext language for multilingual programmes.

When the language set in “D.TV Audio(Primary)”/“D.TV Subtitle(Primary)”/“D.TV Teletext(Primary)” is not available, the language that is set in “D.TV Audio(Secondary)”/“D.TV Subtitle(Secondary)”/“D.TV Teletext(Secondary)” will be selected.

- When you select “OSD Follow,” the language that is set in “OSD Language” will be selected.
- When you select “Audio Follow,” the subtitle language changes according to the language you selected for the sound track.



If you select “Others” in “DVD Menu,” “DVD Audio,” or “DVD Subtitle,” press ⊕, and enter a language code from “Language Code List” on page 111.



If you select a language that is not recorded on the DVD VIDEO, one of the recorded languages will be automatically selected.

Video Settings (Video In/Out)

You can adjust items related to the image, such as size and colour, according to the type of TV, tuner, or decoder connected to the recorder.

TV Type

Select the playback picture size according to the type of connected TV (widescreen/wide mode TV or conventional 4:3 screen TV).

16:9	Select this when connecting to a widescreen TV or TV with a wide mode function.
4:3 Letter Box	Select this when connecting to a 4:3 screen TV. Displays a wide picture with bands on the upper and lower portions of the screen.
4:3 Pan Scan	Select this when connecting to a 4:3 screen TV. Automatically displays a wide picture on the entire screen and cuts off the portions that do not fit.

16:9

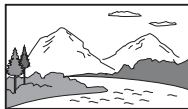

4:3 Letter Box



4:3 Pan Scan

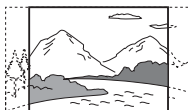

Depending on the disc, "4:3 Letter Box" may be selected automatically instead of "4:3 Pan Scan" or vice-versa.

Component Video Out

Selects the signal format in which the recorder outputs video signals: interlace or progressive, from the COMPONENT VIDEO OUT jacks.

Normal (Interlace)	Outputs signals in the interlace format.
Progressive	Outputs signals in the progressive format. Select this when you want to view progressive signals.



- When using the HDMI connection (page 17), "Progressive" cannot be selected.
- When you set "LINE 3 Out [LINE 1 In]" to "RGB [Video/RGB]" or "RGB [Decoder]," you cannot set "Component Video Out."
- When you connect the recorder to a monitor or projector via only the COMPONENT VIDEO OUT jacks, do not set "LINE 3 Out [LINE 1 In]" to "RGB [Video/RGB]" or "RGB [Decoder]." If you set "LINE 3 Out [LINE 1 In]" to "RGB [Video/RGB]" or "RGB [Decoder]," in this case, the picture may not appear.
- When picture noise appears after you set the recorder to progressive format, hold down **■** (stop) on the recorder, and press **▲** (open/close) on the recorder.

LINE 3 Out [LINE 1 In]

Selects a method of outputting video signals for the LINE 3 – TV jack and a method of inputting video signals for the LINE 1 / DECODER jack. The picture will not be clear if this setting does not match the type of video input signal.

Video [Video/RGB]	Outputs video signals/ inputs video signals or RGB signals.
Video [Decoder]	Outputs video signals. Select this when connecting to an external decoder (PAY-TV/Canal Plus analogue decoder). If you connect to a cable box/satellite receiver such as CanalSat, do not select this option.

S-Video [S-Video]	Outputs/inputs S-video signals.
RGB [Video/RGB]	Outputs RGB signals/inputs video signals or RGB signals.
RGB [Decoder]	Outputs RGB signals. Select this when connecting to an external decoder (PAY-TV/Canal Plus analogue decoder). If you connect to a cable box/satellite receiver such as CanalSat, do not select this option.



If your TV does not accept S-video or RGB signals, the image will not be displayed in the selected method on the TV screen even if you select "S-Video [S-Video]," "RGB [Video/RGB]," or "RGB [Decoder]." Refer to the instructions supplied with your TV.

Input Colour System

Selects the colour system when picture noise appears. This setting is effective when you record an analogue broadcast or an external input.

<u>Auto</u>	Recorder automatically detects signals of colour systems and selects the appropriate colour system.
PAL	Selects the PAL colour system.
SECAM	Selects the SECAM colour system.

HDMI Resolution

Selects the type of video signals output from the HDMI OUT jack. If the picture is not clear, natural or to your satisfaction, try another option that suits the disc and your TV/projector, etc. For details, refer also to the instruction manual supplied with the TV/projector, etc.

<u>Auto (1080p)</u>	Normally select this. The recorder outputs signals starting from the highest resolution acceptable to the TV: 1080p > 1080i > 720p > 576p(480p) If the resulting image format is undesirable, try another setting that suits your TV.
1080i	Outputs 1080i video signals.
720p	Outputs 720p video signals.
576p	Outputs 576p(480p) video signals.



When picture noise appears after you change the "HDMI Resolution" setting, hold down ■ (stop) on the recorder, and press ▲ (open/close) on the recorder.

4:3 Video Output

This setting is effective only when you set “TV Type” to “16:9” in the “Video In/Out” setup.

Adjust this setting to watch 4:3 aspect ratio signals. If you can change the aspect ratio on your TV, change the setting on your TV, not this recorder.

Note that this setting is effective only for HDMI connection.

<u>Full</u>	Select this when you can change the aspect ratio on your TV.
Normal	Select this when you cannot change the aspect ratio on your TV. Shows a 4:3 size video with the aspect ratio as it is.

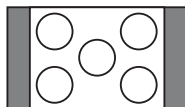

16:9 aspect ratio TV



This setting is not effective when “HDMI Resolution” is set to “576p.”

HDMI Colour

Selects the method of outputting video signals for the HDMI jack.

<u>Auto</u>	Automatically detects the connected TV type, and switches to the matching colour setting.
RGB	Select this when connecting to an RGB device.



Some settings may not be available depending on the connected device.

Audio Input Settings (Audio In)

You can adjust the sound according to the playback and connection conditions.

NICAM Select

For details on NICAM system, see page 51.

<u>NICAM</u>	Normally select this position.
Standard	Select this if the sound from NICAM broadcasts is not clear.

Bilingual Rec. Mode (HDD)

This setting is effective when you record an analogue broadcast or an external input.

<u>On</u>	When recording bilingual programmes, both main and sub sounds can be recorded.
Off	When recording bilingual programmes, only one sound track (main or sub) can be recorded. Set “Bilingual Recording” to “A/L” (default) or “B/R” in the “Audio In” setup (page 94).

Bilingual Recording

Selects the sound to be recorded.

This setting is effective for recording of an analogue broadcast or an external input, or dubbing.

<u>A/L</u>	Records the main sound for the bilingual programme.
B/R	Records the sub sound for the bilingual programme.



When recording a bilingual audio signal to the HDD (when “Bilingual Rec. Mode (HDD)” is set to “On” (page 93)), both audio channels are recorded and you can select the sound when playing.

DV Input

Select the setting for the audio input when DV camcorder dubbing.

Select “Mix” or “Stereo 2” only if you have added a second audio when recording with your digital video camera.

<u>Stereo 1</u>	Records original sound only. Normally select this when dubbing a DV format tape.
Stereo 2	Records additional audio only.
Mix	Records both stereo 1 and 2.

External Audio

<u>Stereo</u>	Select this when receiving stereo programmes from connected equipment.
Bilingual	Select this when receiving bilingual programmes from connected equipment.



When receiving audio input signals from the DV input jack, the recorder automatically selects “Stereo” or “Bilingual” regardless of the “External Audio” setting.

AD Mixing Level

Adjusts the mixing level of the main sound and the audio description. To increase the audio description volume, select a higher numeric value. The default setting is “Middle.”

Audio Output Settings (Audio Out)

You can switch the method of outputting audio signals when you connect a component such as an amplifier (receiver) with a digital input jack.



If you connect a component that does not accept the selected audio signal, a loud noise (or no sound) will come from the speakers, and may affect your ears or cause speaker damage.

Dolby Digital (HDD/DVDs only)

Selects the type of Dolby Digital signal.

Dolby Digital	Select this when the recorder is connected to an audio component with a built-in Dolby Digital decoder.
PCM	Select this when the recorder is connected to an audio component without a built-in Dolby Digital decoder.



If the HDMI OUT jack is connected to equipment not compatible with Dolby Digital signals, the PCM signals will be automatically output even when you select "Dolby Digital."

DTS (DVD VIDEOS only)

Selects whether or not to output DTS signals.

Off	Select this when the recorder is connected to an audio component without a built-in DTS decoder.
On	Select this when the recorder is connected to an audio component with a built-in DTS decoder.



When HDMI output is performed to equipment not compatible with DTS signals, the signals will not be output regardless of the "DTS" setting.

96kHz PCM (DVD VIDEOS only)

Selects the sampling frequency of the audio signal.

96kHz > 48kHz	The audio signals of DVD VIDEOS are converted to 48 kHz and output.
96kHz	All signals containing 96 kHz are output without conversion. However, the signals are output at 48 kHz if copyright-protected signals are contained.



If the HDMI OUT jack is connected to equipment not compatible with 96 kHz signals, 48 kHz PCM will be automatically output even when you select "96kHz."

MPEG (DVD VIDEOS only)

Selects the type of MPEG audio signal.

PCM	Select this when the recorder is connected to an audio component without a built-in MPEG decoder. If you play MPEG audio sound tracks, the recorder outputs stereo signals via the DIGITAL OUT (COAXIAL) jack.
MPEG	Select this when the recorder is connected to an audio component with a built-in MPEG decoder.



If the HDMI OUT jack is connected to equipment not compatible with MPEG audio signals, the PCM signals will be automatically output even when you select "MPEG."

DRC (Dynamic Range Control) (DVDs only)

Selects the dynamic range (difference between soft and loud sounds) setting when playing a DVD that conforms to “DRC.” This affects the output from the following jacks:

- LINE 2 OUT (R-AUDIO-L) jacks
- LINE 3 – TV jack
- LINE 1/DECODER jack
- DIGITAL OUT (COAXIAL)/HDMI OUT jack only when “Dolby Digital” is set to “PCM” (page 95).

<u>Off</u>	Normally select this position.
On	Makes low sounds clear even if you turn the volume down.

HDMI Audio

Selects the type of audio signal output from the HDMI OUT jack.

<u>Auto</u>	Outputs Dolby Digital, MPEG and DTS audio signals as a bitstream signal. Normally select this position.
PCM	Converts all audio signals except for DTS signals to PCM.



- The PCM signals may not be output even when you select “Auto” depending on the “Audio Out” settings, number of audio channels, and the HDMI-connected device.
- The “HDMI Audio” function is not available when a DVI device is connected.

Limitation Settings (Parental Lock)

You can set the password and limit the operations.

When you have not set the password, the display for entering a four-digit password appears. Enter your new password using the number buttons.

D.TV Age Limit

Viewing of some digital TV programmes can be limited according to the age limit you set. To watch or record programmes with an age limit that exceeds the age limit you set, your password is required.

- 1 Select an age as limitation level, and press ⊕.
- 2 Enter your four-digit password using the number buttons.
To cancel the setting, select “Off” (default) in step 1.

DVD Playback (DVD VIDEO only)

Playback of some DVD VIDEOS can be limited according to a predetermined level, such as the age of the users. Scenes may be blocked or replaced with different scenes.

- 1 Select the level, and press ⊕.
The lower the value, the stricter the limitation.
Discs rated higher than the selected level will be restricted.
- 2 Enter your four-digit password using the number buttons.
To cancel the DVD Playback setting for the disc, select “Off” (default) in step 1.

Change Password

You can change the password that gives access to the “Parental Lock” settings. Enter your four-digit password using the number buttons, then enter a new password.



If you forgot your password, reset the recorder (page 105).

Easy Setup (Resetting the Recorder)

Select this to run the “Easy Setup” programme. Follow the instructions for “Easy Setup” (page 23).

Additional Information

Troubleshooting

If you experience any of the following difficulties while using the recorder, use this troubleshooting guide to help remedy the problem before requesting repairs. Should any problem persist, consult your nearest Sony dealer.

Power

The power does not turn on.

- ➔ Check that the mains lead is connected securely.

The power of the recorder turns off at the same time as the TV is turned off.

- ➔ This is caused by the BRAVIA Sync features. Set "Control for HDMI" to "Off" in the "System 1" setup to cancel this function (page 87).

Tuner

The channel is not found or stored or missed.

- ➔ Make sure that your aerial is properly connected to the recorder.
- ➔ Confirm with your dealer that you are in an area that can receive a digital signal.
- ➔ Check your aerial installation.
- ➔ When you have changed the channel settings, turn the recorder off and wait for a while to let the recorder save the settings, then turn it on again. Do not disconnect the mains lead during this procedure.

Picture

There is no picture.

- ➔ Re-connect all connecting cables securely.
- ➔ The connecting cables are damaged.
- ➔ Check the connection to your TV (page 16).

- ➔ Switch the input selector on your TV (such as to "VCR" and "AV 1") so that the signal from the recorder appears on the TV screen.
- ➔ Check that the "Video In/Out" setup is set to the appropriate item that conforms to your system (page 91).
- ➔ If you connect the recorder to your TV via only the COMPONENT VIDEO OUT jacks, set "Component Video Out" in the "Video In/Out" setup to "Progressive" (page 91).
- ➔ Set "Standby Mode" to "Mode 2" in the "System 1" setup (page 87).
- ➔ (For RDR-DC90/DC100/DC200/DC500) A scrambled channel is selected.
- ➔ (For RDR-DC105/DC205/DC305/DC505) A scrambled channel is selected. Insert the proper CAM (page 20).
- ➔ A HD (High Definition) programme is selected.
- ➔ A radio channel is selected.

Picture noise appears.

- ➔ If the picture output signal from your recorder passes through your VCR to get to your TV, or if you are connected to a combination TV/VIDEO player, the copy-protection signal applied to some DVD programmes could affect picture quality. If you still experience this problem even when you connect your recorder directly to your TV, try connecting your recorder to your TV's S VIDEO input.
- ➔ When you set the recorder to progressive format, hold down **■** (stop) on the recorder, and press **▲** (open/close) on the recorder. The recorder is set to normal (interlace) format.
- ➔ You are playing a title recorded in a colour system that is different from your TV.
- ➔ Noise may appear in the pictures recorded on the HDD, which is due to the characteristics of HDD, and is not a malfunction.
- ➔ When playing a double-layer DVD, the video and audio may be momentarily interrupted at the point where the layers switch.

There is no picture or picture noise appears when connected to the DV IN jack.

- ➔ Try the following: ①Turn the recorder off and on again. ②Turn the connected equipment off and on again. ③Disconnect and then connect the i.LINK cable again.

There is no picture or picture noise appears when connected to the HDMI OUT jack.

- ➔ Try the following: ①Turn the recorder off and on again. ②Turn the connected equipment off and on again. ③Disconnect and then connect the HDMI cable again.
- ➔ The recorder is connected to an input device that is not HDCP compliant.
- ➔ When picture noise appears after you change the "HDMI Resolution" setting, hold down ■ (stop) on the recorder, and press ▲ (open/close) on the recorder.

There is no TV programme reception.

- ➔ Set the channel manually in "Digital Manual Setting" (page 84) or "Analog Manual Setting" (page 85) in the "Channel" setup.
- ➔ Select the correct source using the INPUT button, or select a channel of any TV programme using the PROG +/- buttons.

The picture is breaking up.

- ➔ The signal strength is low. For digital broadcasting, you can check the signal strength using the blue button ("Signal") in "Digital Channel List" in the "Channel" setup (page 85).
- ➔ Check aerial installation.

TV programme pictures are distorted.

- ➔ Reorient the TV aerial.
- ➔ Adjust the picture (refer to the TV's instruction manual).
- ➔ Place the recorder and TV farther apart.
- ➔ Place the TV and any bunched aerial cables farther apart.
- ➔ The aerial cable is connected to the AERIAL OUT jack on the recorder. Connect the cable to the AERIAL IN jack.

TV channels cannot be changed.

- ➔ A timer recording started, which changed the channels.

The picture from equipment connected to the recorder's input jack does not appear on the screen.

- ➔ Press INPUT to switch the input source. Select "L1" in the front panel display when the equipment is connected to the LINE 1/DECODER jack, or "L2" when the equipment is connected to the LINE 2 IN jack.
- ➔ When "Standby Mode" is set to "Mode 1" in the "System 1" setup, input signals from the LINE 1/DECODER jack are not output from the LINE 3 - TV jack. Set "Standby Mode" to "Mode 2" in the "System 1" setup (page 87).

The playback picture or TV programme from the equipment connected through the recorder is distorted.

- ➔ If the playback picture output from a DVD player, VCR, or tuner goes through your recorder before reaching your TV, the copy-protection signal applied to some programmes could affect picture quality. Disconnect the playback equipment in question and connect it directly to your TV (page 25).

The picture does not fill the screen.

- ➔ Set "TV Type" in the "Video In/Out" setup in accordance with the screen size of your TV (page 91).

The picture does not fill the screen, even though the picture size is set in "TV Type" in the "Video In/Out" setup.

- ➔ The picture size of the title is fixed.

The picture is black and white.

- ➔ Check that "LINE 3 Out [LINE 1 In]" in the "Video In/Out" setup is set to the appropriate item that conforms to your system (page 91).
- ➔ If you are using a SCART cable, be sure to use one that is fully wired (21 pins).

GUIDE Plus+ system

GUIDE Plus+ system does not appear.

- ➔ Perform “Manual Data Download” to download the GUIDE Plus+ data manually (page 43).
- ➔ The timer is set. Cancel the timer setting.
- ➔ The clock is incorrect. Set the clock manually (page 83).
- ➔ If the host channel has changed or moved, the programme guide data cannot be received. Select “Easy Setup” in “Initial Setup” in the System Menu, and follow the on-screen instructions to make the settings again (page 23). If the problem persists after waiting for one day, search for the host channel at the following website. www.europe.guideplus.com

Programme listings for some programme positions are missing.

- ➔ The programme guide data may not be updated. Turn off the recorder and let the recorder receive the programme guide data.
- ➔ Some broadcast stations support only two days of data. For details, refer to the following website: www.europe.guideplus.com

The programme listing is not up to date.

- ➔ The recorder was in use during the time that the GUIDE Plus+ data was scheduled to be downloaded.

Sound

There is no sound.

- ➔ Re-connect all connections securely.
- ➔ The connecting cable is damaged.
- ➔ The input source setting on the audio component or the connection to the audio component is incorrect.
- ➔ The recorder is in reverse play, fast-forward, slow motion, or pause mode.
- ➔ If the audio signal does not come through the DIGITAL OUT (COAXIAL)/HDMI OUT jacks, check the “Audio Out” setup (page 95).

- ➔ The recorder supports only MP3 audio, Dolby Digital and MPEG audio for DivX video files. Press AUDIO to select a supported audio signal format.
- ➔ When the audio description is not output from the DIGITAL OUT (COAXIAL) jack, set “MPEG” to “PCM” in the “Audio Out” setup (page 95).

No sound is output from the HDMI OUT jack.

- ➔ Try the following: ① Turn the recorder off and on again. ② Turn the connected equipment off and on again. ③ Disconnect and then connect the HDMI cable again.
- ➔ The HDMI OUT jack is connected to a DVI device (DVI jacks do not accept audio signals).
- ➔ The equipment connected to the HDMI OUT jack does not conform to the audio signal format. In this case, set “HDMI Audio” to “PCM” in the “Audio Out” setup (page 96).

The sound volume is low.

- ➔ The sound volume is low on some DVDs. The sound volume may improve if you set “DRC” in the “Audio Out” setup to “On” (page 96).

An alternate audio track cannot be recorded or played.

- ➔ When recording from connected equipment, set “External Audio” to “Bilingual” in the “Audio In” setup (page 94).
- ➔ When recording or playing multilingual tracks (main or sub), set the appropriate settings in the “Audio In” setup (page 93).
- ➔ If you have connected an audio component to the DIGITAL OUT (COAXIAL) jack and want to change the audio track for the HDD (when “Bilingual Rec. Mode (HDD)” is set to “On” in the “Audio In” setup (page 93)) during playback, set “Dolby Digital” in the “Audio Out” setup to “PCM” (page 95).

The sound is breaking up.

- ➔ The signal strength is low. For digital broadcasting, you can check the signal strength using the blue button ("Signal") in "Digital Channel List" in the "Channel" setup (page 85).
- ➔ Check aerial installation.

Recording/Timer recording/ Editing

Recording to a DVD is not possible.

- ➔ The recording destination is HDD only.

The programme position cannot be changed from the programme position you are recording.

- ➔ Set the TV's input source to "TV."

Recording does not start immediately after you press ● REC.

- ➔ Operate the recorder only after "LOADING," "FORMATTING," or "INFO WRITE" disappears from the front panel display.

Nothing was recorded even though you set the timer setting correctly.

- ➔ There was a power failure during recording.
- ➔ The recorder's internal clock stopped due to a power failure that lasted for more than 30 minutes. Reset the clock (page 83).
- ➔ The channel was disabled or erased after the timer recording was set. See "Digital Channel List" (page 85) and "Analog Manual Setting" (page 85).
- ➔ Disconnect the mains lead from the mains, and connect it again.
- ➔ The programme contains copy protection signals (pay-per-view, AVC) that restrict copying, or a scrambled channel is selected.

- ➔ A programme with parental control information has been set for recording. If the display for entering your password appears before recording starts, enter your four-digit password using the number buttons. Your password is required when you record programmes with an age limit that exceeds the age limit you set (page 96).
- ➔ Another timer setting overlapped the timer setting (page 43, 52). Check the timer settings in the schedule list (page 42) and the Timer List (page 52).
- ➔ There is not enough disc space for the recording.
- ➔ The recorder was in the process of dubbing.

Recording does not stop immediately after you press ■ REC STOP.

- ➔ It will take a few seconds for the recorder to input disc data before recording can stop.

Recording does not stop after you press ■.

- ➔ Press ■ REC STOP.

Timer recording is not complete or did not start from the beginning.

- ➔ There was a power failure during recording. If the power recovers when there is a timer recording, the recorder resumes recording. Should the power failure continue for more than 30 minutes, reset the clock (page 83).
- ➔ Another timer setting overlapped the timer setting (page 43, 52). Check the timer settings in the schedule list (page 42) and the Timer List (page 52).
- ➔ Disc space was not sufficient.

Contents previously recorded were erased.

- ➔ Data that is not playable on this recorder but was recorded on a DVD with a PC will be erased from the disc when the disc is inserted.

Editing was not saved on a disc.

- ➔ After editing a disc, there was a power failure or the mains lead was disconnected before editing was saved.
- ➔ For DVDs recorded on other DVD equipment, editing may not be saved correctly.

Titles cannot be edited.

- ➔ Titles cannot be erased or edited while recording or dubbing.
- ➔ Radio titles can only be renamed or erased.

Playback

The recorder does not play any type of disc (except HDD).

- ➔ The disc is upside down. Insert the disc with the labelled side facing up.
- ➔ The disc is not correctly inserted.
- ➔ Moisture has condensed inside the recorder. See “Notes About This Recorder” on page 112.
- ➔ If the disc was recorded on another recorder and was not finalised (page 74), the recorder cannot play the disc.

The recorder does not start playback from the beginning.

- ➔ Resume play was activated (page 56).
- ➔ You have inserted a DVD whose Title menu or DVD menu automatically appears on the TV screen when it is first inserted. Use the menu to start playback (page 54).

The recorder starts playing automatically.

- ➔ The DVD VIDEO features an auto playback function.

Playback stops automatically.

- ➔ If the DVD has an auto pause signal, the recorder stops playback at the auto pause signal.

Some functions such as Stop, Search, or Slow-motion Play cannot be performed.

- ➔ Depending on the DVD, you may not be able to do some of the operations above. Refer to the instruction manual supplied with the disc.

The language of the sound track or the subtitles cannot be changed or turned off.

- ➔ Multilingual tracks are not recorded on the DVD being played.
- ➔ Multilingual subtitles are not recorded on the DVD VIDEO.
- ➔ The DVD VIDEO prohibits the changing of the language of the sound track or the subtitles.
- ➔ Try changing the language using the DVD VIDEO’s menu.
- ➔ After you have changed the language for the DVD menu, remove and insert the DVD again to apply the change.

The angles cannot be changed.

- ➔ Multi-angles are not recorded on the DVD being played.
- ➔ The DVD prohibits changing angles.
- ➔ Try changing the angle using the DVD’s menu.
- ➔ The angles cannot be changed for the titles recorded on this recorder.

The DivX video files do not play.

- ➔ The DivX video files are not created in a format that the recorder can play (page 113).
- ➔ Some DivX video files on a disc or USB device may not play smoothly. In this case, copy the DivX video files to the HDD and play them on the HDD.

The MP3 files do not play.

- ➔ The MP3 files are not recorded in a format that the recorder can play (page 113).

The photo files do not play.

- ➔ The photo files are not recorded in a format that the recorder can play (page 113).
- ➔ It takes some time to play progressive JPEG image files.

TV Pause does not work.

- ➔ The HDD is full.
- ➔ Set the TV’s input source to the recorder, and use the recorder’s tuner to watch TV programmes.

Dubbing

You dubbed a title, but the title did not appear in the HDD Title List.

- ➔ The title contained a copy protection signal, so it was moved (page 110).

You dubbed a title from the HDD to a DVD, but the title did not appear in the DVD Title List.

- ➔ The letters or symbols that are not displayed on the on-screen keyboard for “Rename” (page 68) are replaced with “#.”
- ➔ Depending on the DVD, the title name may not be dubbed.

HDD camcorder dubbing is not possible.

- ➔ An HDD camcorder which is not supported by this recorder is connected (page 75).
- ➔ The HDD camcorder is not set to the USB connection mode (page 76).
- ➔ The HDD camcorder contains only the contents that have already been dubbed to the recorder when you are dubbing using the ONE-TOUCH DUB button. To dub the same contents to the recorder again, perform “One-Touch Dubbing reset” in the “System 2” setup (page 89), then perform One-Touch Dubbing again.

Display

The clock has stopped or is incorrect.

- ➔ Set the clock manually again (page 83).

The timer indicator is flashing.

- ➔ The disc does not have enough space.

The clock does not appear in the front panel display when the recorder is turned off.

- ➔ “Front Panel Display” is set to “Off” in the “System 2” setup (page 89).

The title or station name is not correctly displayed.

- ➔ In some areas, letters or symbols may not be displayed correctly.

The recording mode indication is incorrect.

- ➔ When the recording or dubbing is less than 5 minutes, the recording mode indication may be displayed incorrectly. Note that the actual recording or dubbing itself was correctly made in the selected recording mode.

Remote control

The remote does not function.

- ➔ Different command modes are set for the recorder and remote. Set the same command mode (page 88). The default command mode setting for this recorder and the supplied remote is “3.” You can check the current command mode in the front panel display (page 13).
- ➔ The batteries are weak.
- ➔ The remote is too far from the recorder.
- ➔ The remote’s manufacturer code returned to the default setting when you replaced the batteries. Reset the code (page 22).
- ➔ The remote is not pointed at the remote sensor on the recorder.

Others

The recorder does not detect a USB device connected to the recorder.

- ➔ Make sure that the USB device is securely connected to the recorder (page 58).
- ➔ Check if the USB device or a cable is damaged.
- ➔ Check if the USB device is on.
- ➔ The USB device is connected via a USB hub. Connect the USB device directly to the recorder.

Display language on the screen switches automatically.

- ➔ When “Control for HDMI” is set to “On” (default) in the “System 1” setup (page 87), the display language on the screen automatically switches, according to the language setting of the connected TV, if you change the language settings on your TV, etc.

The BRAVIA Sync features do not operate.

- ➔ Your TV is not compatible with the BRAVIA Sync features.
- ➔ “Control for HDMI” is set to “Off” in the “System 1” setup (page 87).
- ➔ The recorder is connected to the TV via an amplifier. Connect the recorder directly to the TV.

The recorder does not operate properly.

- ➔ Press the RESET button on the front panel (page 12). Then, press **I/⏻** to turn on the recorder.
- ➔ When static electricity, etc., causes the recorder to operate abnormally, turn off the recorder and wait until the clock appears in the front panel display. Then, unplug the recorder and after leaving it off for a while, plug it in again.

The disc tray does not open after you press **⏻ (open/close).**

- ➔ It may take a few seconds for the disc tray to open after you have dubbed or edited a DVD. This is because the recorder is adding disc data to the disc.
- ➔ The recorder is locked. Cancel the Child Lock (page 54).
- ➔ Depending on the disc, the recorder checks whether the disc is finalised when the disc is removed from the recorder.

The disc tray does not open and you cannot remove the disc after you press **⏻ (open/close).**

- ➔ Turn off the recorder. Once the clock appears in the front panel display, disconnect the mains lead. (If the recorder does not turn off or if the clock does not appear in the front panel display, disconnect the mains lead anyway.) Connect the mains lead again while pressing down **⏻** on the recorder, and release the button when the disc tray opens.

“REPAIR ERR” appears in the front panel display.

- ➔ The recorder’s repair function is activated to repair the hard disk drive or disc. Leave the recorder on until “REPAIR ERR” disappears from the front panel display. Some data may be lost even if the repair function is activated.

“E01” appears in the front panel display.

- ➔ There is a problem in the HDD. Contact your nearest Sony dealer. Note that contents on the HDD may be erased when servicing this unit.

“E02” appears in the front panel display.

- ➔ The HDD information is incorrect. You cannot make a new recording to the HDD. Format the HDD following the instructions of “Format” in “HDD Formatting” (page 82). Note that all of the recorded contents on the HDD will be erased. If this does not fix the problem, contact your nearest Sony dealer.

“UPDATE” appears in the front panel display.

- ➔ The recorder is updating the EPG and other information.

The Parental Lock does not work.

- ➔ Check the “D.TV Age Limit” setting in the “Parental Lock” setup (page 96).

Mechanical sounds are heard when the recorder is off.

- ➔ While the recorder is updating the EPG and other information, operating noises (such as the internal fan) may be heard, even when the power is off. This is not a malfunction.

The recorder turns off suddenly while operating.

- ➔ The recorder automatically turns off when it detects any problem. Contact your nearest Sony dealer.

Resetting the Recorder

You can reset the recorder to all its factory settings.

- 1 Make sure that the recorder is turned on and remove the disc.**
- 2 Hold down ■ (stop) on the recorder and press I/⏻ on the recorder.**
All settings are reset and the recorder turns off.

Discs That Can Be Dubbed on

Type		Disc Logo	Icon used in this manual	Formatting (new discs)	Compatibility with other DVD players (finalising)
DVD+RW		 DVD+ReWritable  DVD+ReWritable		Format in VR mode (DVD+RW VIDEO) (page 81)	Playable on DVD+RW-compatible players (finalisation unnecessary)
DVD-RW	VR mode	 DVD RW		Format in VR mode (page 81)	Playable only on VR mode compatible players (finalisation unnecessary)
	Video mode	 DVD RW 		Format in Video mode (page 81)	Playable on most DVD players (finalisation necessary) (page 74)
DVD+R		 DVD+R		Format in VR mode (DVD+R VIDEO)	Playable on most DVD players (finalisation necessary) (page 74)
DVD+R DL		 DVD+R DL			
DVD-R	VR mode	 DVD R R4.7		Format in VR mode	Playable only on DVD-R in VR mode compatible players (finalisation necessary) (page 74)
	DVD-R DL	 DVD R R DL 4X/2X		Format in Video mode	Playable on most DVD players (finalisation necessary) (page 74)

Usable disc versions (as of April 2009)

- 8x-speed or slower DVD+RWs
- 6x-speed or slower DVD-RWs (Ver.1.1, Ver.1.2 with CPRM*)
- 16x-speed or slower DVD+Rs
- 16x-speed or slower DVD-Rs (Ver.2.0, Ver.2.1 with CPRM*)
- 8x-speed or slower DVD+R DL (Double Layer) discs
- 8x-speed or slower DVD-R DL (Dual Layer) discs (Ver.3.0 with CPRM*)

“DVD+RW,” “DVD-RW,” “DVD+R,” “DVD+R DL,” “DVD-R,” and “DVD-R DL” are trademarks.

* CPRM (Content Protection for Recordable Media) is a coding technology that protects copyrights for images.

Discs that cannot be dubbed on

- DVD-RAMs









Maximum number of titles that can be dubbed on a disc

Disc	Number of titles
DVD-RW/DVD-R	99
DVD+RW/DVD+R	49
DVD+R DL	49
DVD-R DL	99



- You cannot record TV programmes or contents on connected equipment directly to a disc.
- You cannot mix VR mode and Video mode on the same DVD-RW. To change the disc's format, reformat the disc (page 81). Note that the disc's contents will be erased after reformatting.
- It is recommended that you use discs with “For Video” printed on their packaging.
- In some cases, you may not be able to dub titles on discs that contain titles dubbed on other DVD equipment. If you do dub a new title, note that this recorder will rewrite the DVD menu of DVD+RWs.
- You may not be able to edit or dub on some recordable discs, depending on the disc.
- Do not insert any discs that cannot be dubbed or played on this recorder. This may cause the recorder to malfunction.

Discs That Can Be Played

Type	Disc Logo	Icon used in this manual	Characteristics
DVD VIDEO			Discs such as movies that can be purchased or rented This recorder also recognises DVD-RAMs*1 as DVD Video compatible discs.
VIDEO CD			VIDEO CDs or CD-Rs/CD-RWs in VIDEO CD/Super VIDEO CD format
CD*2			Music CDs or CD-Rs/CD-RWs in music CD format
DATA DVD*3	—		DVD+RWs/DVD+Rs/DVD-RAMs*1 containing MP3*4 files or DivX video files DVD-RWs/DVD-Rs/DVD-ROMs containing MP3*4 files, JPEG image files or DivX video files
DATA CD*2	—		CD-ROMs/CD-Rs/CD-RWs containing either MP3*4 files, JPEG image files or DivX video files

“DVD VIDEO” and “CD” are trademarks.

*1 If the DVD-RAM has a removable cartridge, remove the cartridge before playback.

*2 You can copy contents on CDs/DATA CDs to the HDD (page 58).

*3 You can copy contents on DATA DVDs to the HDD (page 58). Also, you can copy contents on the HDD to DATA DVDs (page 65).

*4 MPEG Layer-3 audio coding technology and patents licensed from Fraunhofer IIS and Thomson.

- DVD-ROMs/DVD+RWs/DVD-RWs/DVD+Rs/DVD-Rs that do not contain DVD Video, DivX video, photo files, or MP3 files.
- DVD Audio discs
- Cartridge-only type DVD-RAMs.
- HD layer on Super Audio CDs
- DVD VIDEOS with a different region code (page 109).
- DVDs that were recorded on a different recorder and not correctly finalised.

Discs that cannot be played

- PHOTO CDs
- CD-ROMs/CD-Rs/CD-RWs that are recorded in a format different from the formats mentioned in the table above.
- Data part of CD-Extras
- BDs (Blu-ray Discs)
- HD DVDs
- Discs recorded with an AVCHD-compatible DVD video camera

Note on playback operations of DVD VIDEOS/VIDEO CDs

Some playback operations of DVD VIDEOS/VIDEO CDs may be intentionally set by software producers. Since this recorder plays DVD VIDEOS/VIDEO CDs according to the disc contents the software producers designed, some playback features may not be available. Refer to the instructions supplied with the DVD VIDEOS/VIDEO CDs.

Region code (DVD VIDEO only)

Your recorder has a region code printed on the rear of the unit and will only play DVD VIDEOS (playback only) labelled with identical region codes. This system is used to protect copyrights.

DVD VIDEOS labelled  will also play on this recorder.

If you try to play any other DVD VIDEO, the message "Playback prohibited by region code." will appear on the TV screen.

Depending on the DVD VIDEO, no region code indication may be labelled even though playing the DVD VIDEO is prohibited by area restrictions.



Notes on discs

This recorder is designed to playback discs that conform to the Compact Disc (CD) standard. DualDiscs and some music discs encoded with copyright protection technologies do not conform to the Compact Disc (CD) standard. Therefore, these discs may not be compatible with this recorder.



- Some DVD+RWs/DVD+Rs, DVD-RWs/DVD-Rs, DVD-RAMs, or CD-RWs/CD-Rs cannot be played on this recorder due to the recording quality or physical condition of the disc, or the characteristics of the recording device and authoring software. The disc will not play if it has not been correctly finalised. For more information, refer to the operating instructions for the recording device.
- Do not insert any discs that cannot be played on this recorder. This may cause the recorder to malfunction.

About Recording Mode

Like the standard $\times 3$ recording modes of video tapes, you can select the desired recording mode using the REC MODE button.

Recording modes with higher quality provide a more beautiful recording, but the large data volume also results in a shorter recording time.

Conversely, a longer duration provides a longer recording time, but the lower data volume results in a coarser picture quality.

The table below shows the approximate recording times for the HDD in each recording mode.

Recording time in each recording mode

Recording mode	Approx. recording time (hours)				
	RDR-DC90	RDR-DC100/DC105	RDR-DC200/DC205	RDR-DC305	RDR-DC500/DC505
DR* (Direct recording)	42	56	88	112	176
HQ (High quality)	20	27	43	56	89
SP (Standard mode)	41	56	88	115	180
LP (Long duration)	84	110	175	225	355
EP (Extended mode) (6 hours)	100	135	210	270	430
EP (Extended mode) (8 hours)	170	225	355	460	720

* You can record digital TV programmes directly without picture quality deterioration. The approximate recording time above is when recorded at 6 Mbps.



- The maximum continuous recording time to the HDD is 8 hours for a single title. A title longer than 8 hours is divided.
- Situations below may cause slight inaccuracies with the recording time.
 - Recording a programme with poor reception, or a programme or video source of low picture quality.
 - Recording only a still picture or just sound.

About Copy Protection

Pictures with copy protection cannot be recorded on this recorder.

Dubbing restriction

You cannot dub movies and other DVD VIDEOS to the HDD. Also, when dubbing from a DVD to the HDD, scenes that contain a copy protection signal cannot be recorded. Titles containing “Copy-Once” copy protection signals can be moved only from the HDD to a DVD-RW/DVD-R (VR mode)* (after the title is moved, the original title in the HDD is erased). The “Move” function is performed using Dubbing List.

Discs that can be used for protected signals

Copy protection signals	Usable discs
Copy-Free (No copy protection signal)	HDD +RW -RWVR -RWVideo +R -RVR -RVideo
Copy-Once	HDD -RWVR * -RVR *
Copy-Never	None

* CPRM-compatible DVD-RWs/DVD-Rs (VR mode) only.

The dubbed disc can be played only on CPRM compatible equipment (page 107).

CPRM (Content Protection for Recordable Media) is a coding technology that protects copyrights for images.



Protected titles in the HDD cannot be moved.

Language Code List

For details, see page 90.

The language spellings conform to the ISO 639: 1988 (E/F) standard.

Code	Language	Code	Language	Code	Language	Code	Language
1027	Afar	1183	Irish	1347	Maori	1507	Samoan
1028	Abkhazian	1186	Scots Gaelic	1349	Macedonian	1508	Shona
1032	Afrikaans	1194	Galician	1350	Malayalam	1509	Somali
1039	Amharic	1196	Guarani	1352	Mongolian	1511	Albanian
1044	Arabic	1203	Gujarati	1353	Moldavian	1512	Serbian
1045	Assamese	1209	Hausa	1356	Marathi	1513	Siswati
1051	Aymara	1217	Hindi	1357	Malay	1514	Sesotho
1052	Azerbaijani	1226	Croatian	1358	Maltese	1515	Sundanese
1053	Bashkir	1229	Hungarian	1363	Burmese	1516	Swedish
1057	Byelorussian	1233	Armenian	1365	Nauru	1517	Swahili
1059	Bulgarian	1235	Interlingua	1369	Nepali	1521	Tamil
1060	Bihari	1239	Interlingue	1376	Dutch	1525	Telugu
1061	Bislama	1245	Inupiak	1379	Norwegian	1527	Tajik
1066	Bengali; Bangla	1248	Indonesian	1393	Occitan	1528	Thai
1067	Tibetan	1253	Icelandic	1403	(Afan) Oromo	1529	Tigrinya
1070	Breton	1254	Italian	1408	Oriya	1531	Turkmen
1079	Catalan	1257	Hebrew	1417	Punjabi	1532	Tagalog
1093	Corsican	1261	Japanese	1428	Polish	1534	Setswana
1097	Czech	1269	Yiddish	1435	Pashto; Pushto	1535	Tonga
1103	Welsh	1283	Javanese	1436	Portuguese	1538	Turkish
1105	Danish	1287	Georgian	1463	Quechua	1539	Tsonga
1109	German	1297	Kazakh	1481	Rhaeto-Romance	1540	Tatar
1130	Bhutani	1298	Greenlandic	1482	Kirundi	1543	Twi
1142	Greek	1299	Cambodian	1483	Romanian	1557	Ukrainian
1144	English	1300	Kannada	1489	Russian	1564	Urdu
1145	Esperanto	1301	Korean	1491	Kinyarwanda	1572	Uzbek
1149	Spanish	1305	Kashmiri	1495	Sanskrit	1581	Vietnamese
1150	Estonian	1307	Kurdish	1498	Sindhi	1587	Volapük
1151	Basque	1311	Kirghiz	1501	Sangho	1613	Wolof
1157	Persian	1313	Latin	1502	Serbo-Croatian	1632	Xhosa
1165	Finnish	1326	Lingala	1503	Singhalese	1665	Yoruba
1166	Fiji	1327	Loathian	1505	Slovak	1684	Chinese
1171	Faroese	1332	Lithuanian	1506	Slovenian	1697	Zulu
1174	French	1334	Latvian; Lettish				
1181	Frisian	1345	Malagasy			1703	not specified

Notes About This Recorder

On operation

- If the recorder is brought directly from a cold to a warm location, or is placed in a very damp room, moisture may condense on the lenses inside the recorder. Should this occur, the recorder may not operate properly. In this case, if the recorder is on, leave it on (if it is off, leave it off) for about an hour until the moisture evaporates.
- When you move the recorder, take out any discs and do not apply shock or vibration to the hard disk drive to avoid damaging the disc or hard disk drive (page 3).

On adjusting volume

Do not turn up the volume while listening to a section with very low level inputs or no audio signals. If you do, the speakers may be damaged when a peak level section is played.

On cleaning

Clean the cabinet, panel, and controls with a soft cloth slightly moistened with a mild detergent solution. Do not use any type of abrasive pad, scouring powder or solvent such as alcohol or benzine.

On cleaning discs, disc/lens cleaners

Do not use cleaning discs or disc/lens cleaners (including wet or spray types). These may cause the recorder to malfunction.

Notes about the discs

- To keep the disc clean, handle the disc by its edge. Do not touch the surface. Dust, fingerprints, or scratches on the disc may cause it to malfunction.



- Do not expose the disc to direct sunlight or heat sources such as hot air ducts, or leave it in a car parked in direct sunlight as the temperature may rise considerably inside the car.
- After playing, store the disc in its case.
- Clean the disc with a cleaning cloth. Wipe the disc from the centre out.



- Do not use solvents such as benzine, thinner, commercially available cleaners, or anti-static spray intended for vinyl LPs.
- Do not use the following discs.
 - A disc that has a nonstandard shape (e.g., card, heart).
 - A disc with a label or sticker on it.
 - A disc that has cellophane tape or sticker adhesive on it.

On replacement of parts

In the event that this unit is repaired, repaired parts may be collected for reuse or recycling purposes.

Notes on MP3 files, JPEG Image Files, DivX Video Files, and i.Link

About MP3 files, JPEG image files, and DivX video files

MP3 is an audio compression technology that satisfies certain ISO/MPEG regulations. JPEG is an image compression technology. DivX[®] is a registered trademark of DivX, Inc., and is used under license.

ABOUT DIVX VIDEO: DivX[®] is a digital video format created by DivX, Inc. This is an official DivX Certified device that plays DivX video. Visit www.divx.com for more information and software tools to convert your files into DivX video.

You can play MP3/JPEG/DivX format files on the HDD, DATA CDs (CD-ROMs/CD-Rs/CD-RWs), DATA DVDs (DVD-ROMs/DVD-RWs/DVD-Rs/DVD+RWs/DVD-RAMs) or USB devices. DATA DVDs must be recorded according to ISO9660 Level 1, Level 2, Romeo, Joliet, or UDF (Universal Disk Format) 1.02, 1.50, 2.00*, or 2.01 format.

DATA CDs must be recorded according to ISO9660 Level 1, Level 2, Romeo, or Joliet format.

You can also play discs recorded in MultiSession/Border.

Refer to the instructions supplied with the disc drives and the recording software (not supplied) for details on the recording format.

* Not available for MP3 files.

Note on MultiSession/Border discs

If audio tracks and images in Music CD format or Video CD format are recorded in the first session/border, only the first session/border will be played back.

MP3 files, JPEG image files, or DivX video files that the recorder can play

The recorder can play the following tracks and files:

- MP3 files with the extension “.mp3.”
- JPEG image files with the extension “.jpeg” or “.jpg.”
- Baseline JPEG image files that conform to the Exif 2.2* image files format, and Y:C:B:CR is 4:4:4, 4:2:2, or 4:2:0.
- DivX video files with the extension “.avi” or “.divx.”

* “Exchangeable Image File Format”: The file format used by digital still cameras.



- The recorder will play any data with the extension “.mp3,” “.jpeg,” “.jpg,” “.avi,” or “.divx” even if they are not in MP3, JPEG, or DivX format. Playing these data may generate a loud noise which could damage your speaker system.
- Depending on the disc, normal playback may not be possible. For example, the picture may be unclear, playback may not appear smooth, the sound may skip, and so on.
- Depending on the disc, playback may take some time to start.
- Some files cannot be played.
- The maximum number of folders and files that can be played on the HDD or the USB device is 500. For discs that are formatted and copied on this recorder, the maximum number of folders and files that can be played is 500 in total.
- The HDD and the USB device can each have 8 folder layers. Discs that are formatted on this recorder can have 2 folder layers.
- Proceeding to the next or another folder may take some time.
- The image size that can be displayed is limited. The following image sizes can be displayed: width 8,000 pixels by height 8,000 pixels at the maximum.
- This recorder supports progressive JPEG image files that are no more than 2 MB.
- This recorder supports MP3 files recorded with a sampling frequency of 32 kHz, 44.1 kHz, and 48 kHz.

- No more than a 4 GB MP3 file can be played.
- The recorder does not conform to audio tracks in mp3PRO format.
- The recorder cannot play a DivX video file of a size larger than 720 (width) × 576 (height)/4 GB.
- The recorder may not play a DivX video file when the file has been combined from two or more DivX video files.
- Note that the size of JPEG image files copied to the HDD may be automatically increased to fit the TV screen.
- You cannot copy JPEG image files onto a DATA DVD finalised on other recorders or devices.

About i.LINK

The DV IN jack on this recorder is i.LINK-compliant for digital video cameras.

i.LINK is a more familiar term for IEEE 1394 data transport bus proposed by Sony, and is a trademark approved by many corporations.

IEEE 1394 is an international standard standardized by the Institute of Electrical and Electronics Engineers.

For details on how to dub when this recorder is connected to other video equipment having DV jacks, see page 78.

The DV IN jack on this recorder can only input DVC-SD signals. It cannot output signals. The DV IN jack will not accept MICRO MV signals from equipment such as a MICRO MV digital video camera with an i.LINK jack.

For further precautions, see the notes on page 78.

For details on precautions when connecting this recorder, also refer to the instruction manuals for the equipment to be connected.



Normally, only one piece of equipment can be connected to this recorder by the i.LINK cable (DV connecting cable). When connecting this recorder to i.LINK-compatible equipment having two or more i.LINK jacks (DV jacks), refer to the instruction manual of the equipment to be connected.

i.LINK and  are trademarks.

Specifications

System

Laser: Semiconductor laser

Transmission standards (Digital broadcasting): DVB-T, DVB-C

Channel coverage (Digital broadcasting): VHF/UHF

Channel coverage (Analogue broadcasting):

PAL (B/G, D/K, I)/SECAM (L)

VHF: E2 to E12, R1 to R12, F2 to

F10, Italian A to H, Ireland A to J

UHF: E21 to E69, R21 to R69, B21 to B69, F21 to F69

CATV: S01 to S05, S1 to S20, France B to Q

HYPERS: S21 to S41

The above channel coverage merely ensures the channel reception within these ranges. It does not guarantee the ability to receive signals in all circumstances. The channels that can be received differ depending on the country/region.

Video reception: Frequency synthesizer system

Audio reception: Split carrier system

Aerial out: 75-ohm asymmetrical aerial socket

Timer: Clock: Quartz locked/Timer indication: 24-hour cycle (digital)

Video recording format: MPEG-2, MPEG-1

Audio recording format/applicable bit rate:

DVB-T/C: DR (Direct Recording) (TS Rec Mode)

ATT: Dolby Digital 2ch

(HQ, SP, LP, EP (6 hours): 256 kbps,

EP (8 hours): 128 kbps)

Inputs and outputs

LINE 2 OUT

(AUDIO): Phono jack/2 Vrms/10 kilohms

(VIDEO): Phono jack/1.0 Vp-p

LINE 2 IN

(AUDIO): Phono jack/2 Vrms/more than 22 kilohms

(VIDEO): Phono jack/1.0 Vp-p

(S VIDEO): 4-pin mini DIN/Y: 1.0 Vp-p, C: 0.3 Vp-p (PAL)

LINE 3 – TV: 21-pin

CVBS OUT

S-Video/RGB OUT (upstream)

LINE 1/DECODER: 21-pin

CVBS IN/OUT

S-Video/RGB IN

Decoder

DV IN: 4-pin/i.LINK S100

DIGITAL OUT (COAXIAL): Phono jack/0.5 Vp-p/75 ohms

COMPONENT VIDEO OUT

(Y, P_B/C_B, P_R/C_R):

Phono jack/Y: 1.0 Vp-p,

P_B/C_B: 0.7 Vp-p, P_R/C_R: 0.7 Vp-p

HDMI OUT: HDMI™ Connector

USB:

USB jack (For connecting digital still camera, Memory card reader, USB memory, HDD camcorder and Hard disk drive)

Conditional access module (RDR-DC105/DC205/DC305/DC505 only): CAM

(Conditional Access Module) slot

General

Power requirements: 220-240 V AC, 50/60 Hz

Power consumption:

RDR-DC90/DC100/DC200/DC500:
44 W

RDR-DC105/DC205/DC305/DC505:
45 W

Dimensions (approx.):

430 × 71.5 × 258 mm (width/height/depth) incl. projecting parts

Hard disk drive capacity:

RDR-DC90: 120 GB

RDR-DC100/DC105: 160 GB

RDR-DC200/DC205: 250 GB

RDR-DC305: 320 GB

RDR-DC500/DC505: 500 GB

Maximum recordable number of titles* :
999

Mass (approx.): 4.1 kg

Operating temperature: 5°C to 35°C

Operating humidity: 25% to 80%

Supplied accessories:

Mains lead (1)

Aerial cable (1)

Remote commander (remote) (1)

R6 (size AA) batteries (2)

* The maximum length for one title is 8 hours.

Specifications and design are subject to change without notice.

Keep this important information about how to re-tune your Digital TV Recorder during the digital TV switchover

Keep this instruction manual safe – you'll need it

.....

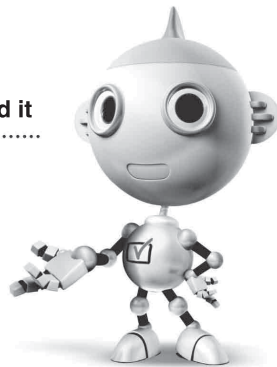

Television in the UK is going digital, bringing us all more choices and new services. Starting in late 2007 and ending in 2012, television services in the UK will go completely digital, TV region by TV region. Please see the overleaf to find out when your area switches to digital.

Digital UK is the independent, non-profit organisation leading the process of digital TV switchover in the UK. Digital UK provides impartial information on what people need to do to prepare for the move to digital, and when they need to do it.

How the switchover affects Digital TV Recorders (DTR) including Freeview+ models and DVD Recorders with Freeview built in:

When the TV switchover happens in your area, there are at least two occasions when you will need to re-tune your digital TV recorder in order to continue receiving your existing TV channels, and also to pick up new ones. Digital UK, the body leading the digital TV switchover, will advise you when you need to re-tune during the switchover.

If you find you can't receive the extra digital channels, it may be because your area is not covered by Freeview yet or that you need an aerial upgrade. Visit www.digital.co.uk to check.

How to re-tune:

- 1 Press SYSTEM MENU while the recorder is in stop mode or during playback.
- 2 Select "Initial Setup" using **↑/↓**, and press **⊕**.
- 3 Select "Channel" using **↑/↓**, and press **⊕**.
- 4 Select "Auto Channel Setting" using **↑/↓**, and press **⊕**.
- 5 Follow the on-screen instructions.

If you are missing any channels, it may be that they are not available in your area, or that your aerial needs upgrading.

If you have any questions, please contact Sony on **08705 111 999** or call Digital UK on **0845 6 50 50 50** or visit **www.digitaluk.co.uk**

When does switchover happen?

*Copeland switches on October 17, 2007



The exact date you switch depends on the transmitter you are served by. To check when you switch, go to Digital UK's postcode checker on www.digitaluk.co.uk

Check your ITV news service or look at Teletext page 106 to see what TV region you're in.



Visit us at digitaluk.co.uk call us on **0845 6 50 50 50[†]**

[†]Calls charged at BT rate of 3p per minute daytime and 1p per minute evenings and weekends. Rates may vary for calls from non-BT lines.

Index

Words in quotations appear in the on-screen displays.

Numerics

“96kHz PCM” 95

A

“A-B Erase” 67
“AD Mixing Level” 94
Aerial 16
“AFT” 86
Alternate Programmes 50
“Analog Manual Setting” 85
“Audio In” 93
“Audio Out” 95
Audio output 18
“Auto Channel Setting” 24, 84
“Auto Chapter” 87
“Auto Clock Setting” 83
“Auto Finalisation” 89
“Auto Power off” 87

B

Batteries 21
“Bilingual Rec. Mode (HDD)” 93
“Bilingual Recording” 94
Bilingual recording 51
BRAVIA Sync 20

C

CAM 20
Canal Plus 27
CD 108
“CH System” 85
“Change Password” 97
“Channel” 84, 85
“Chap.Search” 57
“Chapter” 58
Chase Play 56
Child Lock 54
“CI Information” 89
“Clock Setting” 83

“Command Mode” 88
“Component Video Out” 91
Conditional Access Module 20
Connecting
 the aerial cable 16
 the HDMI cable 17
 the video cables 17
Copy protection signals 110
Copy-Free 110
Copy-Never 110
Copy-Once 110
“Country” 23
CPRM 107
Creating a Playlist 69

D

“D.TV Age Limit” 96
“D.TV Audio(Primary)” 90
“D.TV Audio(Secondary)” 90
“D.TV Subtitle(Primary)” 90
“D.TV Subtitle(Secondary)” 90
“D.TV Teletext(Primary)” 90
“D.TV Teletext(Secondary)” 90
DATA CD 108
DATA DVD 108
“Decoder” 28, 86
“Digital Channel List” 85
“Digital Manual Setting” 84
Digital Services
 EPG 46
“Digital Source” 23
“Disc” 58
“Disc Information” 81
 “Format” 81
 “Rename” 68
Disc settings 74
“Disc Setup” 74, 81
Disc types 106, 108
“Divide” 68

DivX video files 59
“DivX® Registration” 88
Dolby Digital 18, 95
“DRC” 96
DTS 18, 95
“Dubbing” 66
Dubbing
 dubbing format 106
 from a finalised DVD to the HDD 73
 from the HDD to a DVD 71
 Move 110
DV camcorder 78
DV camcorder dubbing 78
 “DV Dubbing” 80
 One Touch Dubbing 79
 “DV Dubbing” 80
“DV Input” 79, 94
“DVD Audio” 90
“DVD Menu” 90
“DVD Playback” 96
“DVD Subtitle” 90
DVD VIDEO 108
DVD+R 106, 108
DVD+RW 106, 108
DVD-R 106, 108
DVD-RAM 108
DVD-ROM 108
DVD-RW 106, 108

E

Easy Setup 23, 97
Editing 66
 Playlist 69
 titles 66
“EP Mode Time” 87
EPG
 Viewing a list of available channels 46
“EPG Type Select” 88
“Erase” 66, 67
“External Audio” 94

F

- “File Search” 61
- “Finalise” 74
- Finalising 74
- Freeze Frame 56, 61
- Front panel 12
- “Front Panel Display” 89
- Front panel display 13

G

- “Grid” 36
- GUIDE Plus+ system 36, 38

H

- Handling discs 112
- HDD camcorder 75
- HDD camcorder dubbing 75
 - “HDD-Cam Dubbing” 77
 - One-Touch Dubbing 76
- “HDD Formatting” 82
- “HDD-Cam Dubbing” 77
- HDMI
 - “4:3 Video Output” 93
 - “Control for HDMI” 87
 - “HDMI Audio” 96
 - “HDMI Colour” 93
 - “HDMI Resolution” 92
- HDMI cable 17

I

- i.LINK 114
- “Initial Setup” 83
- “Input Colour System” 92

L

- “Language” 23, 90
- “LINE 3 Out [LINE 1 In]” 91

M

- Main sound 51, 94
- Mains lead 21
- “Manual Clock Setting” 24, 83
- Menu
 - DVD’s Menu 54
 - Top menu 54
- MPEG 18, 95
- “My TV” 36

N

- “Name” 86
- “New Playlist” 66
- NICAM 51
- “NICAM Select” 93

O

- “One-Touch Dubbing reset” 89
- One-Touch Play 55
- “OSD Language” 90

P

- Page mode 32
- “Parental Lock” 55, 96
- Parts and controls 10
- Pause Live TV 56
- PAY-TV 27
- PBC 55
- PhotoTV HD 64
- Play mode
 - “Repeat” 57
- Playable discs 108

- Playback 54, 108

- DivX video files 59
- fast forward 55, 60
- fast reverse 55, 60
- freeze frame 56, 61
- instant advance 55, 60
- instant replay 55, 60
- MP3 files 61
- music CD 61
- photo files 63
- “Repeat” 57
- resume play 56
- scan audio 55, 60
- slow-motion play 56, 61
- zoom 64

- Playlist 69
- “Progressive” 24
- “Protection” 66
- Protection
 - title 66

Q

- Quick Timer 31

R

- Rear panel 14
- Recording
 - recording mode 109
 - recording time 109
 - Series Recording 40, 49
 - while watching
 - another programme 30
- Recording mode 109
- Recording time 109
- Region code 109
- Remote 10, 21
- “Rename” 66, 68
- “Repeat” 57
- Repeat
 - “Folder” 61
 - “Title” 61
- Resetting the recorder 97, 105
- Resume Play 56

S

Scan Audio 55, 60
“Schedule” 36
“Search” 36
Searching
 fast reverse/fast
 forward 55, 60
 locating the
 beginning of the
 title/chapter/
 track/file 55, 60
 scan audio 55, 60
“Select All” 66
Series Recording 40, 49
“Setup” 36
Simultaneous Rec and
Play 57
Slow-motion play 56, 61
“Software Update” 89
“Sound System” 86
Split Programmes 50
“Standby Mode” 24, 87
Sub sound 51, 94
“Summer Time” 83
Super VIDEO CD 108
“System 1” 87
“System 2” 89

T

“Time Search” 57, 61
Timer List 52
Timer recording
 check/change/cancel
 42, 52
 EPG timer setting
 47, 48
 GUIDEPlus+ system
 38
 manual setting 41,
 50
“Timing” 43
“Title” 58
Title List 31
 “Sort” 32
“Title Search” 57
“Track” 58
“Track Search” 57
TV Pause 56
TV system 86
“TV Type” 24, 91

U

“Unfinalise” 82
“Unselect All” 66
Usable discs 106, 108
USB 76

V

“Version” 88
Video cable 17
VIDEO CD 108
“Video In/Out” 91
Video mode 106
Video output 18
“Visual Search” 33
VR mode 106

Z

Zoom 64
ZWEITON 51



About how to re-tune your TV during the digital TV switchover, see page 116.

Printed on 70% or more recycled paper.



1-4131978113

4-131-978-11(1)

Free Manuals Download Website

<http://myh66.com>

<http://usermanuals.us>

<http://www.somanuals.com>

<http://www.4manuals.cc>

<http://www.manual-lib.com>

<http://www.404manual.com>

<http://www.luxmanual.com>

<http://aubethermostatmanual.com>

Golf course search by state

<http://golfingnear.com>

Email search by domain

<http://emailbydomain.com>

Auto manuals search

<http://auto.somanuals.com>

TV manuals search

<http://tv.somanuals.com>