

DVD Recorder

Operating Instructions

 To find out useful hints, tips and information about Sony products and services please visit: www.sony-europe.com/myproduct

RDR-GX350



WARNING

To reduce the risk of fire or electric shock, do not expose this apparatus to rain or moisture.

To avoid electrical shock, do not open the cabinet. Refer servicing to qualified personnel only.

The mains lead must be changed only at a qualified service shop. Batteries or batteries installed apparatus shall not be exposed to excessive heat such as sunshine, fire or the like.

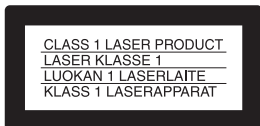

This appliance is classified as a CLASS 1 LASER product. The CLASS 1 LASER PRODUCT MARKING is located on the rear of the unit.

CAUTION

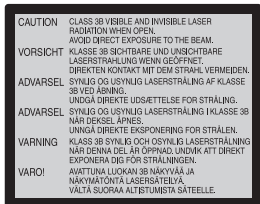

The use of optical instruments with this product will increase eye hazard. As the laser beam used in this DVD recorder is harmful to eyes, do not attempt to disassemble the cabinet.

Refer servicing to qualified personnel only.



This label is located on the rear protective housing inside the enclosure.

Notice for customers in the United Kingdom and Republic of Ireland

A molded plug complying with BS1363 is fitted to this equipment for your safety and convenience. Should the fuse in the plug supplied need to be replaced, a 5 AMP fuse approved by ASTA or BSI to BS1362, (i.e., marked with  or  mark) must be used. If the plug supplied with this equipment has a detachable fuse cover, be sure to attach the fuse

cover after you change the fuse. Never use the plug without the fuse cover. If you should lose the fuse cover, please contact your nearest Sony service station.

Precautions

- This unit operates on 220 – 240 V AC, 50/60 Hz. Check that the unit's operating voltage is identical with your local power supply.
- To prevent fire or shock hazard, do not place objects filled with liquids, such as vases, on the apparatus.
- Install this system so that the mains lead can be unplugged from the wall socket immediately in the event of trouble.

VIDEO Plus+ and PlusCode are registered trademarks of Gemstar Development Corporation. The VIDEO Plus+ system is manufactured under license from Gemstar Development Corporation.



Disposal of Old Electrical & Electronic Equipment (Applicable in the European Union and other European countries with separate collection systems)

This symbol on the product or on its packaging indicates that this product shall not be treated as household waste. Instead it shall be handed over to the applicable collection point for the recycling of electrical and electronic equipment. By ensuring this product is disposed of correctly, you will help prevent potential negative consequences for the environment and human health, which could otherwise be caused by inappropriate waste handling of this product. The recycling of materials will help to conserve natural resources. For more detailed information about recycling of this product, please contact your local Civic Office, your household waste disposal service or the shop where you purchased the product.

Europe Only



Pb

Disposal of waste batteries (applicable in the European Union and other European countries with separate collection systems)

This symbol on the battery or on the packaging indicates that the battery provided with this product shall not be treated as household waste. By ensuring these batteries are disposed of correctly, you will help prevent potentially negative consequences for the environment and human health which could otherwise be caused by inappropriate waste handling of the battery. The recycling of the materials will help to conserve natural resources.

In case of products that for safety, performance or data integrity reasons require a permanent connection with an incorporated battery, this battery should be replaced by qualified service staff only.

To ensure that the battery will be treated properly, hand over the product at end-of-life to the applicable collection point for the recycling of electrical and electronic equipment.

For all other batteries, please view the section on how to remove the battery from the product safely. Hand the battery over to the applicable collection point for the recycling of waste batteries.

For more detailed information about recycling of this product or battery, please contact your local Civic Office, your household waste disposal service or the shop where you purchased the product.

The manufacturer of this product is Sony Corporation, 1-7-1 Konan Minato-ku Tokyo, 108-0075 Japan. The Authorized Representative for EMC and product safety is Sony Deutschland GmbH, Hedelfinger Strasse 61, 70327 Stuttgart, Germany. For any service or guarantee matters please refer to the addresses given in separate service or guarantee documents.

Precautions

This equipment has been tested and found to comply with the limits set out in the EMC Directive using a connection cable shorter than 3 metres.

On safety

Should any solid object or liquid fall into the cabinet, unplug the recorder and have it checked by qualified personnel before operating it any further.

On power sources

- The recorder is not disconnected from the AC power source (mains) as long as it is connected to the wall outlet, even if the recorder itself has been turned off.
- If you are not going to use the recorder for a long time, be sure to disconnect the recorder from the wall outlet. To disconnect the AC power cord (mains lead), grasp the plug itself; never pull the cord.

On placement

- Place the recorder in a location with adequate ventilation to prevent heat build-up in the recorder.
- Do not place the recorder on a soft surface such as a rug that might block the ventilation holes.
- Do not place the recorder in a confined space such as a bookshelf or similar unit.
- Do not place the recorder in a location near heat sources, or in a place subject to direct sunlight, excessive dust, or mechanical shock.
- Do not place the recorder in an inclined position. It is designed to be operated in a horizontal position only.
- Keep the recorder and discs away from equipment with strong magnets, such as microwave ovens, or large loudspeakers.
- Do not place heavy objects on the recorder.

On recording

Make trial recordings before making the actual recording.

On compensation for lost recordings

Sony is not liable and will not compensate for any lost recordings or relevant losses, including when recordings are not made due to reasons including recorder failure, or when the contents of a recording are lost or damaged as a result of recorder failure or repair undertaken to the recorder. Sony will not restore, recover, or replicate the recorded contents under any circumstances.

Copyrights

- Television programmes, films, video tapes, discs, and other materials may be copyrighted. Unauthorized recording of such material may be contrary to the provisions of the copyright laws. Also, use of this recorder with cable television transmission may require authorization from the cable television transmitter and/or programme owner.
- This product incorporates copyright protection technology that is protected by U.S. patents and other intellectual property rights. Use of this copyright protection technology must be authorized by Macrovision, and is intended for home and other limited viewing uses only unless otherwise authorized by Macrovision. Reverse engineering or disassembly is prohibited.
- This Product includes FontAvenue® fonts licenced by NEC corporation. FontAvenue is a registered trademark of NEC corporation.

Copy guard function

Since the recorder has a copy guard function, programmes received through an external tuner (not supplied) may contain copy protection signals (copy guard function) and as such may not be recordable, depending on the type of signal.

IMPORTANT NOTICE

Caution: This recorder is capable of holding a still video image or on-screen display image on your television screen indefinitely. If you leave the still video image or on-screen display image displayed on your TV for an extended period of time you risk permanent damage to your television screen. Plasma display panels and projection televisions are especially susceptible to this.

If you have any questions or problems concerning your recorder, please consult your nearest Sony dealer.

About this manual

- In this manual, "disc" is used as a general reference for the DVDs or CDs unless otherwise specified by the text or illustrations.
- Icons, such as **DVD**, listed at the top of each explanation indicate what kind of media can be used with the function being explained.
- Instructions in this manual describe the controls on the remote. You can also use the controls on the recorder if they have the same or similar names as those on the remote.
- The on-screen display illustrations used in this manual may not match the graphics displayed on your TV screen.
- The explanations regarding DVDs in this manual refer to DVDs created on this recorder. The explanations do not apply to DVDs that are created on other recorders and played back on this recorder.

Table of Contents

WARNING	2
Precautions	3
Quick Guide to Disc Types	7
Recordable and playable discs	7
Playable discs	9

Hookups and Settings 11

Hooking Up the Recorder	11
Step 1: Connecting the Aerial Cable	12
Step 2: Connecting the Video Cords/HDMI Cord	13
About the SMARTLINK features (for SCART connections only)	15
About the HDMI Control functions for 'BRAVIA' Theatre Sync (for HDMI connections only)	15
Step 3: Connecting the Audio Cords/HDMI Cord	16
Step 4: Connecting the Mains Lead	17
Step 5: Preparing the Remote	18
Controlling TVs with the remote	18
If you have a Sony DVD player or more than one Sony DVD recorder	19
Changing programme positions of the recorder using the remote	19
Step 6: Easy Setup	20
Setting Up the VIDEO Plus+ [®] System	21
Connecting a VCR or Similar Device	23
Connecting to the LINE 1/DECODER jack	23
Connecting to the LINE 2 IN jacks on the front panel	24
Connecting to a Satellite or Digital Tuner	25
Connecting an External Decoder	26
Connecting a decoder	26
Setting external decoder (PAY-TV/Canal Plus analogue decoder) programme positions	27

Eight Basic Operations — Getting to Know Your DVD Recorder















1. Inserting a Disc	29
2. Recording a Programme	29
Checking the disc status while recording	30
3. Playing the Recorded Programme (Title List)	31
4. Displaying the Playing Time and Play Information	33
5. Changing the Name of a Recorded Programme	34
6. Labelling and Protecting a Disc	36
Labelling a disc	36
Protecting a disc	36
7. Playing the Disc on Other DVD Equipment (Finalise)	37
Unfinalising a disc	39
8. Reformatting a Disc	40

Timer Recording	41
Before Recording	41
Recording mode	41
Recording stereo and bilingual programmes	42
Unrecordable pictures	42
Timer Recording (Standard/VIDEO Plus+)	43
Setting the timer manually (Standard)	43
Recording TV programmes using the VIDEO Plus+ system	45
Using the Quick Timer function	46
Adjusting the recording picture quality	46
Creating chapters in a title	47
Checking/Changing/Canceling Timer Settings (Timer List)	48
Recording from Connected Equipment	49
Recording from connected equipment with a timer (Synchro Rec.)	49
Recording from connected equipment without a timer	51
<hr/>	
Playback	52
Playing the Recorded Programme/DVD	52
Playback options	54
Playing a specific portion repeatedly (A-B Repeat)	56
Playing repeatedly (Repeat)	56
Creating your own programme (Programme)	57
Adjusting the picture quality	57
Searching for a Time/Title/Chapter/Track, etc.	59
<hr/>	
Erasing and Editing	60
Before Editing	60
Erasing and Editing a Title	61
Erasing a section of a title (A-B Erase)	62
Erasing and Editing a Chapter	63
Dividing a chapter (Divide)	63
Erasing a chapter (Erase)	64
Combining multiple chapters (Combine)	64
Creating and Editing a Playlist	64
Moving a Playlist title (Move)	65
Combining multiple Playlist titles (Combine)	65
Dividing a Playlist title (Divide)	65
Moving a chapter (Move)	66
<hr/>	
Audio Tracks	67
Playing Audio Tracks from CD/DVD	67
Playback options	67
Playing a specific portion repeatedly (A-B Repeat)	68
Playing repeatedly (Repeat)	68
Creating your own programme (Programme)	69
Searching for an Audio Track	70

JPEG Image Files	71
Using the "Photo Album" List	71
Viewing a JPEG image file	72
Playing a slideshow	72
<hr/>	
Settings and Adjustments	74
Disc Settings (Disc Setup)	74
Recorder Settings (Basic)	75
Aerial Reception Settings (Tuner)	77
Auto Channel Setting	77
Manual CH Setting	77
Channel Swapping	79
Set VIDEO Plus+ CH	79
Video Settings (Video In/Out)	79
Audio Input Settings (Audio In)	81
Audio Output Settings (Audio Out)	82
Language Settings (Language)	83
Recording Settings (Recording)	84
Playback Settings (Playback)	87
HDMI Settings (HDMI Output)	89
Other Settings (Options)	91
<hr/>	
Additional Information	93
Troubleshooting	93
Resetting the Recorder	99
Notes About This Recorder	99
Specifications	100
Notes on MP3 Audio Tracks, JPEG Image Files, and DivX Video Files	101
Guide to Parts and Controls	103
Language Code List	106
Country/Area Code	107
Index	108

Quick Guide to Disc Types

Recordable and playable discs

Type	Disc Logo	Icon used in this manual	Formatting (new discs)	Compatibility with other DVD players (finalising)
DVD+RW	 DVD+ReWritable  DVD+ReWritable		Automatically formatted in +VR mode (DVD+RW VIDEO)	Playable on DVD+RW compatible players (automatically finalised)
DVD-RW	VR mode	 RW 	Format in VR mode (page 29)	Playable only on VR mode compatible players (finalisation unnecessary)
	Video mode	 RW  	Format in Video mode (page 29)	Playable on most DVD players (finalisation necessary) (page 37)
DVD+R	 DVD+R  DVD+R DL		Automatically formatted in +VR mode (DVD+R VIDEO)	Playable on most DVD players (finalisation necessary) (page 37)
DVD-R	VR mode	 R R4.7 	Format in VR mode (page 29) ^{*1} Formatting is performed in the "Format" setup (page 40).	Playable only on DVD-R in VR mode compatible players (finalisation necessary) (page 37)
DVD-R DL	Video mode	 R R DL 4X/2X 	Automatically formatted in Video mode	Playable on most DVD players (finalisation necessary) (page 37)

Usable disc versions (as of April 2007)

- 8x-speed or slower DVD+RWs
- 6x-speed or slower DVD-RWs (Ver.1.1, Ver.1.2 with CPRM^{*2})
- 16x-speed or slower DVD+Rs
- 16x-speed or slower DVD-Rs (Ver.2.0, Ver.2.1 with CPRM^{*2})
- 8x-speed or slower DVD+R DL (Double Layer) discs
- 8x-speed or slower DVD-R DL (Dual Layer) discs (Ver.3.0 with CPRM^{*2})

“DVD+RW,” “DVD-RW,” “DVD+R,” “DVD+R DL,” “DVD-R,” and “DVD-R DL” are trademarks.









^{*1} When an unformatted DVD-R is inserted into this recorder, it is automatically formatted in Video mode. To format a new DVD-R in VR mode, format in the “Format” setup (page 40).

^{*2} CPRM (Content Protection for Recordable Media) is a coding technology that protects copyrights for images.

Discs that cannot be recorded on

- DVD-RAMs

Playable discs

Type	Disc Logo	Icon used in this manual	Characteristics
DVD VIDEO			Discs such as movies that can be purchased or rented This recorder also recognises DVD-RAMs* as DVD Video compatible discs.
VIDEO CD			VIDEO CDs or CD-Rs/CD-RWs in VIDEO CD/Super VIDEO CD format
CD			Music CDs or CD-Rs/CD-RWs in music CD format
DATA DVD	—		DVD+RWs/DVD+Rs/DVD-RAMs* containing MP3 audio tracks or DivX video files DVD-RWs/DVD-Rs/DVD-ROMs containing MP3 audio tracks, JPEG image files or DivX video files
DATA CD	—		CD-ROMs/CD-Rs/CD-RWs containing either MP3 audio tracks, JPEG image files or DivX video files

“DVD VIDEO” and “CD” are trademarks.

DivX, DivX Certified, and associated logos are trademarks of DivX, Inc. and are used under license.

DivX[®] is a video file compression technology, developed by DivX, Inc.

* If the DVD-RAM has a removable cartridge, remove the cartridge before playback.

Discs that cannot be played

- PHOTO CDs
- CD-ROMs/CD-Rs/CD-RWs that are recorded in a format different from the formats mentioned in the table above.
- Data part of CD-Extras
- BDs
- HD DVDs
- Discs recorded with an AVCHD-compatible DVD video camera

- DVD-ROMs/DVD+RWs/DVD-RWs/DVD+Rs/DVD-Rs that do not contain DVD Video, DivX video, JPEG image files, or MP3 audio tracks.
- DVD Audio discs
- Cartridge-only type DVD-RAMs.
- HD layer on Super Audio CDs
- DVD VIDEOS with a different region code (page 10).
- DVDs that were recorded on a different recorder and not correctly finalised.

Maximum recordable number of titles

Disc	Number of titles
DVD-RW/DVD-R	99
DVD+RW/DVD+R	49
DVD+R DL	49
DVD-R DL	99

Note on playback operations of DVD VIDEOS/VIDEO CDs

Some playback operations of DVD VIDEOS/VIDEO CDs may be intentionally set by software producers. Since this recorder plays DVD VIDEOS/VIDEO CDs according to the disc contents the software producers designed, some playback features may not be available. See the instructions supplied with the DVD VIDEOS/VIDEO CDs.

Region code (DVD VIDEO only)

Your recorder has a region code printed on the rear of the unit and will only play DVD VIDEOS (playback only) labelled with identical region codes. This system is used to protect copyrights.

DVD VIDEOS labelled  will also play on this recorder.

If you try to play any other DVD VIDEO, the message "Playback prohibited by region code." will appear on the TV screen.

Depending on the DVD VIDEO, no region code indication may be labelled even though playing the DVD VIDEO is prohibited by area restrictions.



Region code

Music discs encoded with copyright protection technologies

This product is designed to play back discs that conform to the Compact Disc (CD) standard.

Recently, various music discs encoded with copyright protection technologies are being marketed by some record companies. Please be aware that among those discs, there are some that do not conform to the CD standard and may not be playable by this product.

Note on DualDiscs

A DualDisc is a two sided disc product which mates DVD recorded material on one side with digital audio material on the other side. However, since the audio material side does not conform to the Compact Disc (CD) standard, playback on this product is not guaranteed.

Notes

- Some DVD+RWs/DVD+Rs, DVD-RWs/DVD-Rs, DVD-RAMs, or CD-RWs/CD-Rs cannot be played on this recorder due to the recording quality or physical condition of the disc, or the characteristics of the recording device and authoring software. The disc will not play if it has not been correctly finalised. For more information, see the operating instructions for the recording device.
- You cannot mix VR mode and Video mode on the same DVD-RW. To change the disc's format, reformat the disc (page 40). Note that the disc's contents will be erased after reformatting.
- You cannot shorten the time required for recording even with high-speed discs.
- It is recommended that you use discs with "For Video" printed on their packaging.
- You cannot add new recordings to DVD+Rs, DVD-Rs, or DVD-RWs (Video mode) that contain recordings made on other DVD equipment.
- In some cases, you may not be able to add new recordings to DVD+RWs that contain recordings made on other DVD equipment. If you do add a new recording, note that this recorder will rewrite the DVD menu.
- You cannot edit recordings on DVD+RWs, DVD-RWs (Video mode), DVD+Rs, or DVD-Rs that are made on other DVD equipment.
- If the disc contains PC data unrecognizable by this recorder, the data may be erased.
- You may not be able to record, edit, or dub on some recordable discs, depending on the disc.
- Do not insert any discs that cannot be recorded or played on this recorder. This may cause the recorder to malfunction.

Hooking Up the Recorder

Follow steps 1 through 6 to hook up and adjust the settings of the recorder. Do not connect the mains lead until you reach “Step 4: Connecting the Mains Lead” on page 17.

Notes

- See “Specifications” (page 100) for a list of supplied accessories.
- Plug in cords securely to prevent unwanted noise.
- Refer to the instructions supplied with the components to be connected.
- You cannot connect this recorder to a TV that does not have a SCART or video input jack.
- Be sure to disconnect the mains lead of each component before connecting.

Step 1: Connecting the Aerial Cable

Connect the aerial cable by following the steps below.

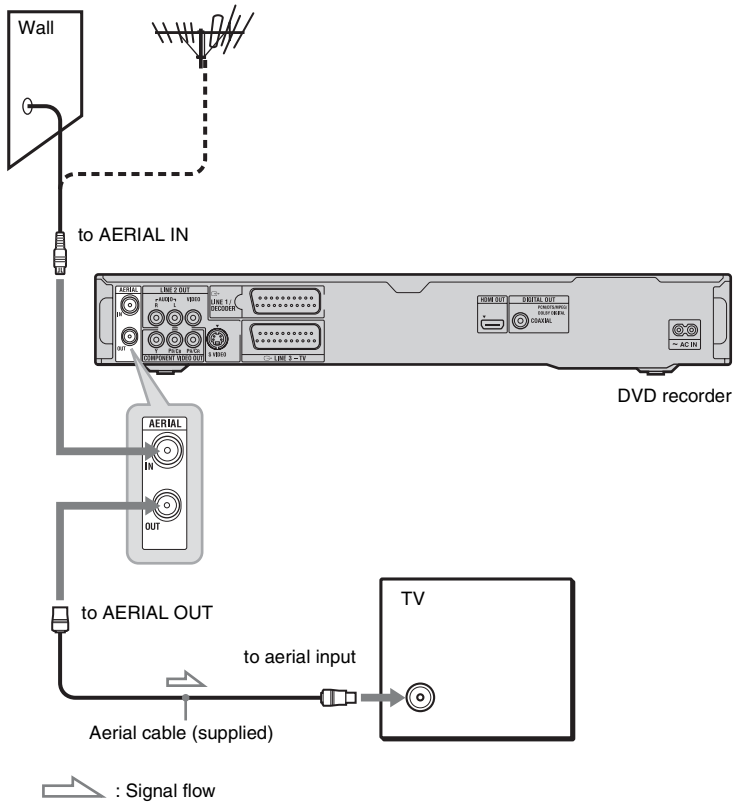

- 1** Disconnect the aerial cable from your TV, and connect it to AERIAL IN on the rear panel of the recorder.
- 2** Connect AERIAL OUT of the recorder to the aerial input of your TV using the supplied aerial cable.

Step 2: Connecting the Video Cords/HDMI Cord

Select one of the following patterns, **A** through **E**, according to the input jack on your TV monitor, projector, or audio component such as an AV amplifier (receiver). This will enable you to view pictures.

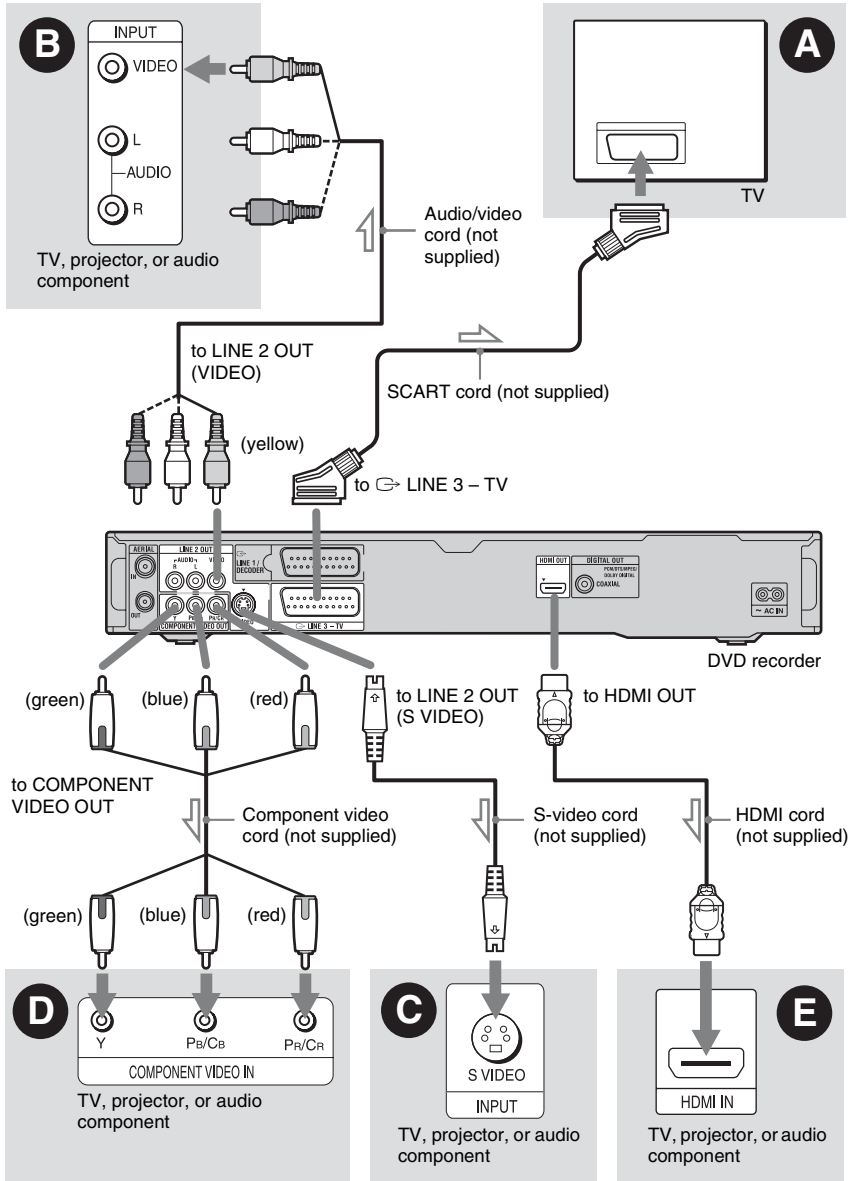

⤵ : Signal flow

A SCART input jack

When setting “LINE 3 Out” to “S-Video” or “RGB” in the “Video In/Out” setup (page 80), use a SCART cord that conforms to the selected signal.

B Video input jack

You will enjoy standard quality images.

C S VIDEO input jack

You will enjoy high quality images.

D Component video input jacks (Y, P_B/C_B, P_R/C_R)

You will enjoy accurate colour reproduction and high quality images.

If your TV accepts progressive 525p/625p format signals, use this connection and set “Progressive” to “Compatible” in the “Easy Setup” setup (page 20). Then set “Component Video Out” to “Progressive” in the “Video In/Out” setup to send progressive video signals. For details, see “Component Video Out” on page 80.

E HDMI input jack

Use a certified HDMI cord (not supplied) to enjoy high quality digital picture and sound through the HDMI OUT jack.

When connecting a Sony TV that is compatible with the HDMI control function, see page 15.

To see the signals from the connected set top box receiver when the set top box receiver is connected to the recorder using a SCART cord only, turn the recorder on.

When connecting to the HDMI jack

Follow the steps below. Improper handling may damage the HDMI jack and the connector.

- 1 Carefully align the HDMI jack on the rear of the recorder and the HDMI connector by checking their shapes. Make sure the connector is not upside down or tilted.



- 2 Insert the HDMI connector straight into the HDMI jack. Do not bend or apply pressure to the HDMI connector.

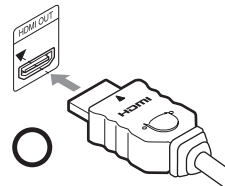

Notes

- Be sure to disconnect the HDMI cord when moving the recorder.
- Do not apply too much pressure to the cabinet wall, if you place the recorder on the cabinet with the HDMI cord connected. It may damage the HDMI jack or the HDMI cord.
- Do not twist the HDMI connector while connecting to or disconnecting from the HDMI jack to avoid damaging the HDMI jack and connector.

When playing “wide screen” images

Some recorded images may not fit your TV screen. To change the picture size, see page 87.

If you are connecting to a VCR

Connect your VCR to the LINE 1/ DECODER jack on the recorder (page 23).

Notes

- Do not connect more than one type of video cord between the recorder and your TV at the same time.
- Do not make connections **A** and **E** at the same time.
- When you connect the recorder to your TV via the SCART jacks, the TV's input source is set to the recorder automatically when you start playback. If necessary, press the TV  button on the remote to return the input to the TV.
- If you connect the recorder to a TV with SMARTLINK, set "LINE 3 Out" to "Video" in the "Video In/Out" setup.
- You cannot connect the HDMI OUT jack (connection **E**) to DVI jacks that are not HDCP compliant (e.g., DVI jacks on PC displays).
- Component video and RGB signals are not output when using the HDMI connection.

* This DVD recorder incorporates High-Definition Multimedia Interface (HDMI™) technology. HDMI, the HDMI logo and High-Definition Multimedia Interface are trademarks or registered trademarks of HDMI Licensing LLC.

About the SMARTLINK features (for SCART connections only)

If the connected TV (or other connected equipment such as a set top box) complies with SMARTLINK, NexTVView Link^{*3}, MEGALOGIC^{*1}, EASYLINK^{*2}, CINEMALINK^{*2}, Q-Link^{*3}, EURO VIEW LINK^{*4}, or T-V LINK^{*5}, you can enjoy the following SMARTLINK features.

- One-Touch Play (page 53)
- Preset Download
You can download the tuner preset data from your TV to this recorder, and tune the recorder according to that data in "Easy Setup."
- NexTVView Download
You can easily set the timer by using the NexTVView Download function on your TV.

To prepare for the SMARTLINK features

Set "LINE 3 Out" to "Video" in the "Video In/Out" setup (page 80) and "SMARTLINK" to "This Recorder Only" in the "Options" setup (page 92).

Notes

- For correct SMARTLINK connection, you will need a SCART cord that has the full 21 pins. Refer to your TV's instruction manual as well for this connection.
- Not all TVs respond to the functions above.

- *1 "MEGALOGIC" is a registered trademark of Grundig Corporation.
- *2 "EASYLINK" and "CINEMALINK" are trademarks of Philips Corporation.
- *3 "Q-Link" and "NexTVView Link" are trademarks of Panasonic Corporation.
- *4 "EURO VIEW LINK" is a trademark of Toshiba Corporation.
- *5 "T-V LINK" is a trademark of JVC Corporation.

About the HDMI Control functions for 'BRAVIA' Theatre Sync (for HDMI connections only)

By connecting Sony components that are compatible with the HDMI Control function with an HDMI cord (not supplied), operation is simplified as below:

- One-Touch Play (page 53)
- System Power-Off
When you turn the TV off by using the power button on the TV's remote, the components compatible with the HDMI Control function turn off automatically.

To prepare for the 'BRAVIA' Theatre Sync features

Set "HDMI Control" to "On" in the "HDMI Output" setup (page 91). For details on TV settings, refer to the operating instructions supplied with the TV.

Notes

- Depending on the connected component, the HDMI Control function may not work. Refer to the operating instructions supplied with the component.
- The recorder supports only the playback option of HDMI Control. "Player" appears on the TV screen when using the HDMI Control functions.

Step 3: Connecting the Audio Cords/HDMI Cord

Select one of the following patterns, **A** or **B**, according to the input jack on your TV monitor, projector, or audio component such as an AV amplifier (receiver). This will enable you to listen to sound.

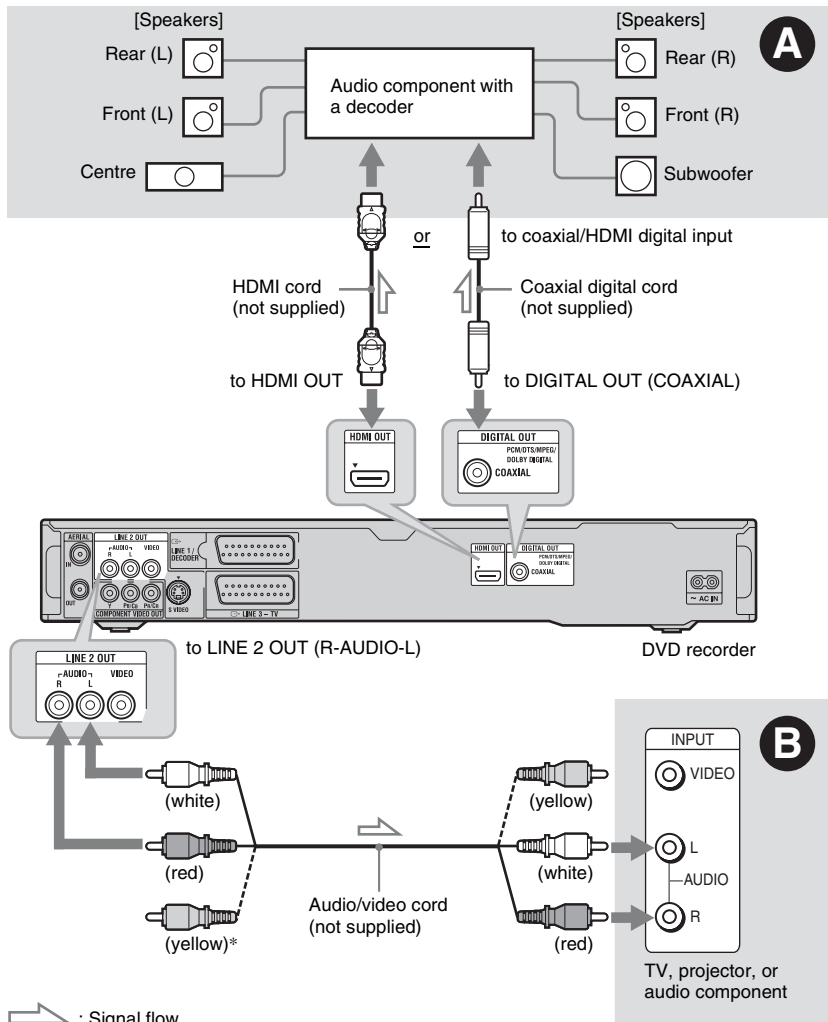

* The yellow plug is used for video signals (page 13).

A Digital audio input jack

If your audio component has a Dolby[®] Digital^{*2}, or MPEG audio decoder and a digital input jack, use this connection. You can enjoy Dolby Digital (5.1ch), DTS (5.1ch), and MPEG audio (5.1ch) surround effects.

If you connect a Sony audio component that is compatible with the HDMI control function, refer to the operating instructions supplied with the audio component.

B Audio L/R (left/right) input jacks

This connection will use your TV's or audio component's two speakers for sound.

💡 Hint

For correct speaker location, see the operating instructions supplied with the connected components.

⚡ Notes

- Do not connect your TV's audio output jacks to the LINE IN (R-AUDIO-L) jacks at the same time. This will cause unwanted noise to come from your TV's speakers.
- With connection **B**, do not connect the LINE IN (R-AUDIO-L) and LINE 2 OUT (R-AUDIO-L) jacks to your TV's audio output jacks at the same time. This will cause unwanted noise to come from your TV's speakers.
- With connection **A**, after you have completed the connection, make the appropriate settings in the "Audio Out" setup (page 82). Otherwise, no sound or a loud noise will come from your speakers.
- When you connect the recorder to an audio component using an HDMI cord, you will need to do one of the following:
 - Connect the audio component to the TV with the HDMI cord, or
 - Connect the recorder to the TV with a video cord other than HDMI cord (component video cord, S-video cord, or audio/video cord).

*1 Manufactured under license from Dolby Laboratories.

"Dolby" and the double-D symbol are trademarks of Dolby Laboratories.

*2 "DTS" and "DTS Digital Out" are registered trademarks of DTS, Inc.

Step 4: Connecting the Mains Lead

Connect the supplied mains lead to the AC IN terminal of the recorder. Then plug the recorder and TV mains leads (AC power cords) into the mains. After you connect the mains lead, **you must wait for a short while before operating the recorder.** You can operate the recorder once the front panel display lights up and the recorder enters standby mode.

If you connect additional equipment to this recorder (page 23), be sure to connect the mains lead after all connections are complete.

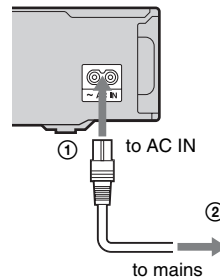

Step 5: Preparing the Remote

You can control the recorder using the supplied remote. Insert two R6 (size AA) batteries by matching the ⊕ and ⊖ ends on the batteries to the markings inside the battery compartment. When using the remote, point it at the remote sensor  on the recorder.

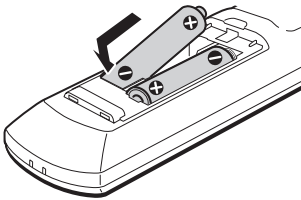

Notes

- If the supplied remote interferes with your other Sony DVD recorder or player, change the command mode number for this recorder (page 19).
- Use the batteries correctly to avoid possible leakage and corrosion. Should leakage occur, do not touch the liquid with bare hands. Observe the following:
 - Do not use a new battery with an old battery, or batteries of different manufacturers.
 - Do not attempt to recharge the batteries.
 - If you do not intend to use the remote for an extended period of time, remove the batteries.
 - If battery leakage occurs, wipe out any liquid inside the battery compartment, and insert new batteries.
- Do not expose the remote sensor (marked  on the front panel) to strong light, such as direct sunlight or a lighting apparatus. The recorder may not respond to the remote.
- When you replace the batteries of the remote, the code number and Command Mode may be reset to the default setting. Set the appropriate code number and Command Mode again.

Controlling TVs with the remote

You can adjust the remote's signal to control your TV.

Notes

- Depending on the connected unit, you may not be able to control your TV with some or all of the buttons below.
- If you enter a new code number, the code number previously entered will be erased.

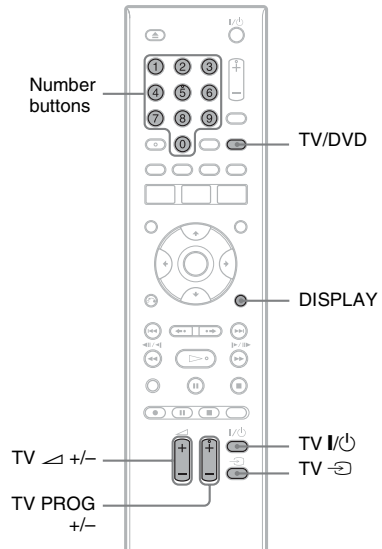

1 Hold down TV I/O located at the bottom of the remote.

Do not press the I/O button at the top of the remote.

2 With TV I/O pressed down, enter the TV's manufacturer code using the number buttons.



For instance, to enter "09," press "0" then "9." After you enter the last number, release the TV I/O button.

Code numbers of controllable TVs

If more than one code number is listed, try entering them one at a time until you find the one that works with your TV.

Manufacturer	Code number
Sony	01 (default)
Hitachi	24
JVC	33
Panasonic	17, 49
Philips	06, 08
Samsung	71
Sanyo	25
Thomson	43
Toshiba	38

The remote performs the following:

Buttons	Operations
TV 	Turns your TV on or off.
TV  (volume) +/-	Adjusts the volume of your TV.
TV PROG +/-	Selects the programme position on your TV.
TV  (input select)	Switches your TV's input source.

To operate the TV/DVD button (for SCART connections only)

The TV/DVD button switches between TV mode and DVD mode. Press the TV/DVD button when in stop mode or no menu appears on the TV screen. Point your remote at the recorder when using this button.

TV mode: switch to this when you use the TV's tuner mainly. When you start playback, the input source for the TV is set to the recorder automatically.

DVD mode: switch to this when you use the recorder's tuner mainly.

To check the current mode, press DISPLAY (page 33).

If you have a Sony DVD player or more than one Sony DVD recorder

If the supplied remote interferes with your other Sony DVD recorder or player, set the command mode number for this recorder and the supplied remote to one that differs from the other Sony DVD recorder or player after you have completed "Step 6: Easy Setup." The default command mode setting for this recorder and the supplied remote is DVD3. You can check the current Command Mode in the front panel display. For details, see page 92.

The default command mode setting for this recorder and the supplied remote is DVD3. The remote does not function if different command modes are set for the recorder and remote. Set the same command mode.

Changing programme positions of the recorder using the remote

You can change programme positions of the recorder using the number buttons.

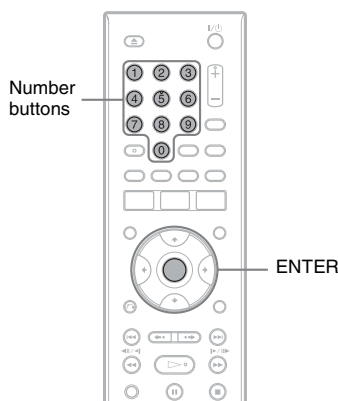

Example: for channel 50
Press "5," "0," then press ENTER.

Step 6: Easy Setup

Make the basic adjustments by following the on-screen instructions in “Easy Setup.” Be careful not to disconnect the cables or exit the “Easy Setup” function during this procedure.

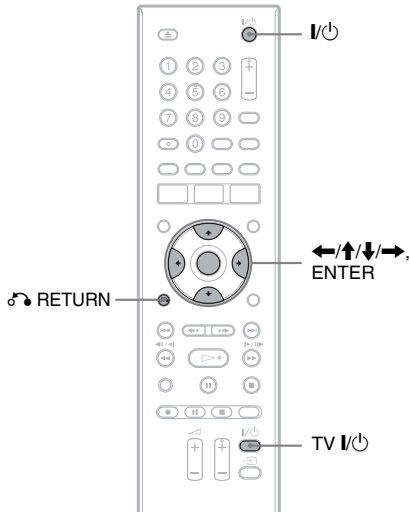

- 1 Turn on the recorder and your TV. Then switch the input selector on your TV so that the signal from the recorder appears on your TV screen.**

The “Language” display appears.

- If the “Language” display does not appear, select “Easy Setup” in the “Basic” setup from “Initial Setup” in the System Menu (page 76).

- 2 Select a language for the on-screen displays using $\leftarrow/\uparrow/\downarrow/\rightarrow$, and press ENTER.**

The initial settings message appears.

- 3 Select “Start” using \uparrow/\downarrow , and press ENTER.**

Follow the on-screen instructions to make the following settings.

◆ Auto Channel Setting

If you connect a TV to this recorder not using SMARTLINK, select “Auto Scan.” Then select your country/region using \leftarrow/\rightarrow , and press ENTER. The programme position order will be set according to the country/region you select.

If you connect a TV to this recorder with SMARTLINK, select “Download from TV.” Then select your country/region using \leftarrow/\rightarrow , and press ENTER. The tuner preset data will be downloaded from your TV to this recorder. (For details, refer to the operating instructions supplied with your TV.)

To skip this setting, select “Do not set.” To set the programme positions manually, see page 77.

◆ Clock Setting

Select “Auto” when a programme position in your local area broadcasts a time signal. The “Auto Clock Setting” display appears.

- 1** Select the programme position of the station that carries a time signal using \leftarrow/\rightarrow .
- 2** Select “Start” using \downarrow , and press ENTER.
If a clock signal cannot be found, press \curvearrowright RETURN, and set the clock manually.

Select “Manual” to set the clock manually. The “Manual Clock Setting” display appears.

- 1** Select the time zone for your area using \leftarrow/\rightarrow , and press \downarrow .
- 2** Select “On” using \leftarrow/\rightarrow if you are now on summer time, and press ENTER.
- 3** Set the day, month, year, hour, and minutes using $\leftarrow/\uparrow/\downarrow/\rightarrow$, and press ENTER to start the clock.

◆ **TV Screen Size (page 87)**

If you have a wide-screen TV, select “Wide (16:9).” If you have a standard TV, select “Standard (4:3).” This will determine how “wide-screen” images are displayed on your TV.

◆ **Progressive**

When you connect a progressive format TV to this recorder using the COMPONENT VIDEO OUT jacks, select “Compatible.”

4 Select “Finish Setup” using ↑/↓, and press ENTER.

“Easy Setup” is completed.

To return to the previous step

Press ⏪ RETURN.

💡 Hint

If you want to run “Easy Setup” again, select “Easy Setup” in the “Basic” setup from “Initial Setup” in the System Menu (page 76).

Setting Up the VIDEO Plus+® System

Setting up your recorder involves coordinating the TV programme position (the number you turn to on your TV or recorder to watch a programme) with the guide channel (the number that’s assigned to that channel in your TV programme guide).

To find the guide channel numbers, look at the “Channel Line-up Chart” in the programme guide for your area that features PlusCode numbers.

Use the Channel Line-up Chart to coordinate the guide channel number with the TV programme position.

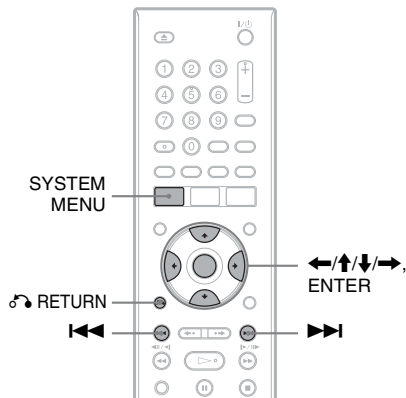

- 1 Press SYSTEM MENU while the recorder is stopped.**
- 2 Select “Initial Setup,” and press ENTER.**

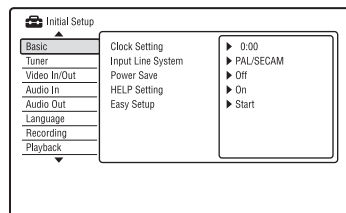

- 3 Select “Tuner,” and press ENTER.**
- 4 Select “Set VIDEO Plus+ CH,” and press ENTER.**

- 5** Select “Next Screen,” and press ENTER.
 - 6** Select the guide channel number assigned in the program guide using ↑/↓.
To go to the next/previous page, press |◀◀/▶▶|.
 - 7** Select “Preset” (the TV channel number or station name) using ←/→.
 - 8** Repeat steps 6 and 7 for each guide channel number that does not match the TV channel number.
 - 9** Press SYSTEM MENU to exit the menu.
-

To return to the previous step

Press ⏪ RETURN.

Connecting a VCR or Similar Device

After disconnecting the recorder's mains lead from the mains, connect a VCR or similar recording device to the LINE IN jacks of this recorder. For details, refer to the instruction manual supplied with the connected equipment. To record on this recorder, see "Recording from Connected Equipment" on page 49.

Connecting to the LINE 1/DECODER jack

Connect a VCR or similar recording device to the LINE 1/DECODER jack of this recorder.

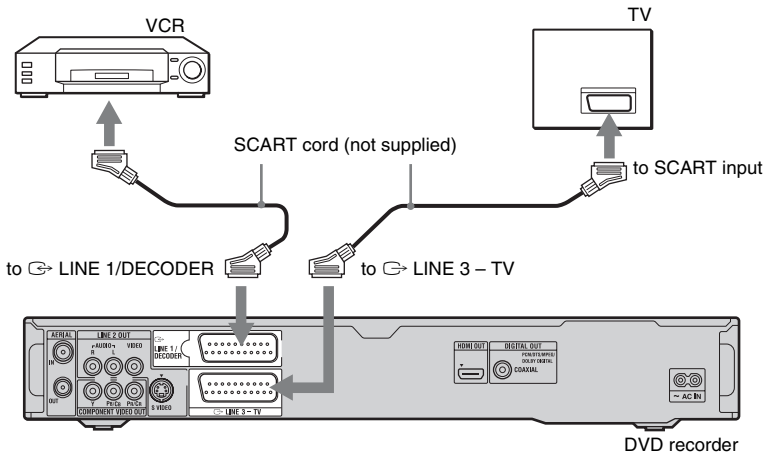

Notes

- Pictures containing copy protection signals that prohibit any copying cannot be recorded.
- If you pass the recorder signals through a VCR, you may not receive a clear image on your TV screen.

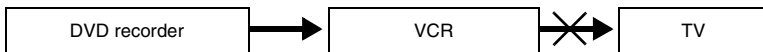

Be sure to connect your VCR to the DVD recorder and to your TV in the order shown below. To watch video tapes, watch the tapes through a second line input on your TV.

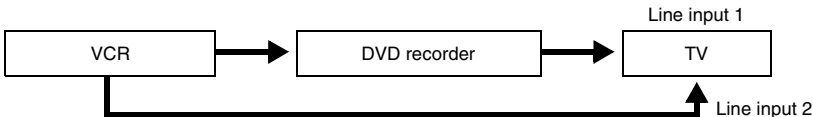

- The SMARTLINK features are not available for devices connected via the DVD recorder's LINE 1/DECODER jack.
- To watch the connected VCR or similar device's pictures through the recorder while the recorder is in standby mode, set "Power Save" to "Off" (default) in the "Basic" setup (page 76).
- When you record to a VCR from this DVD recorder, do not switch the input source to TV by pressing the TV/DVD button on the remote.
- If you disconnect the recorder's mains lead, you will not be able to view the signals from the connected VCR.

Connecting to the LINE 2 IN jacks on the front panel

Connect a VCR or similar recording device to the LINE 2 IN jacks of this recorder. If the equipment has an S-video jack, you can use an S-video cord instead of an audio/video cord.

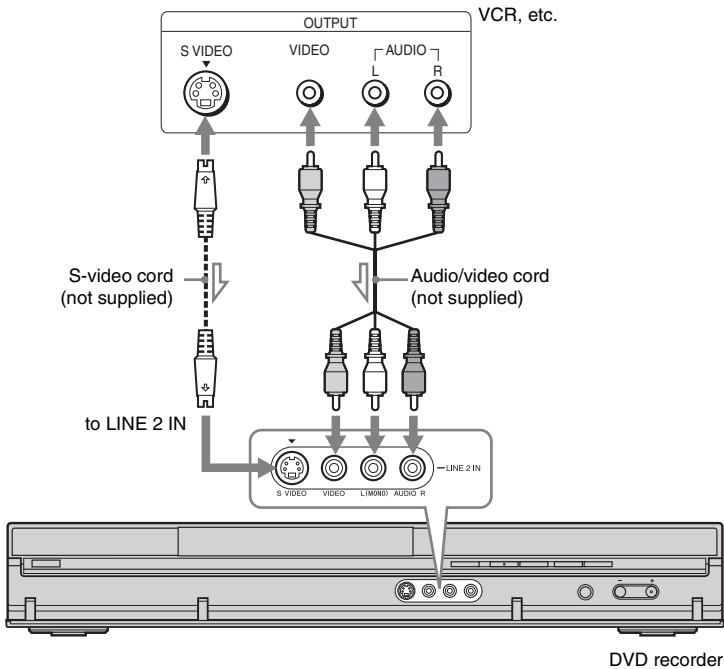

 : Signal flow

Hint

When the connected equipment outputs only monaural sound, connect to only the L(MONO) and VIDEO input jacks on the front of the recorder. Do not connect the R input jack.

Notes

- Do not connect the yellow LINE IN (VIDEO) jack when using an S-video cord.
- Do not connect the output jack of this recorder to another equipment's input jack with the other equipment's output jack connected to the input jack of this recorder. This may cause noise (feedback).
- Do not connect more than one type of video cord between the recorder and your TV at the same time.

Connecting to a Satellite or Digital Tuner

Connect a satellite or digital tuner to this recorder using the LINE 1/DECODER jack. Disconnect the recorder's mains lead from the mains when connecting the tuner.

To use the Synchro Rec function, see below.

Do NOT set "LINE 1 In" to "Decoder" in the "Video In/Out" setup (page 80) when making this connection.

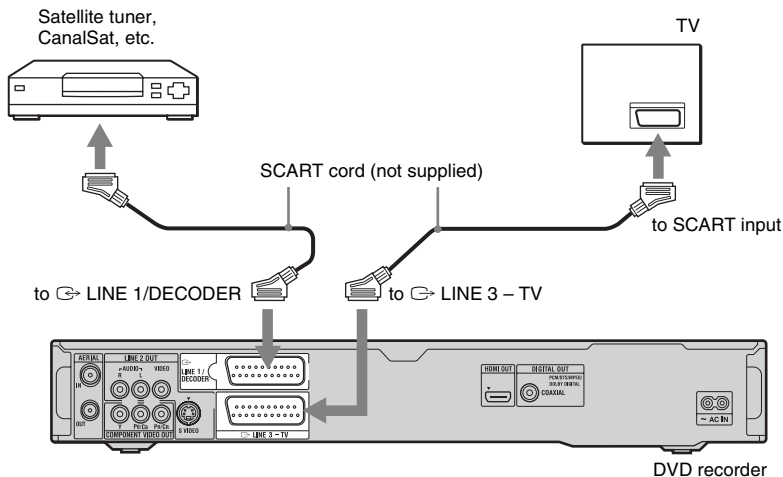

If the satellite tuner can output RGB signals

This recorder accepts RGB signals. If the satellite tuner can output RGB signals, connect the TV SCART connector on the satellite tuner to the LINE 1/DECODER jack, and set "LINE 1 In" to "RGB" in the "Video In/Out" setup (page 80). See the instructions supplied with the set top box receiver.

If you want to use the Synchro Rec function

This connection is necessary to use the Synchro-Recording function. See "Recording from connected equipment with a timer (Synchro Rec.)" on page 49. Set "LINE 1 In" in the "Video In/Out" setup (page 80) according to the specifications of your satellite tuner. See your satellite tuner's instructions for more information.

Notes

- Synchro-Recording does not work with some tuners. For details, see the tuner's operating instructions.
- If you disconnect the recorder's mains lead, you will not be able to view the signals from the connected tuner.

Connecting an External Decoder

You can watch or record external decoder (PAY-TV/Canal Plus analogue decoder) programmes if you connect a decoder (not supplied) to the recorder. Disconnect the recorder's mains lead from the mains when connecting the decoder. Note that when you set "LINE 1 In" to "Decoder" in step 7 of "Setting external decoder (PAY-TV/Canal Plus analogue decoder) programme positions" (page 27), you will not be able to select "L1" because Line 1 will become a dedicated line for the decoder.

Connecting a decoder

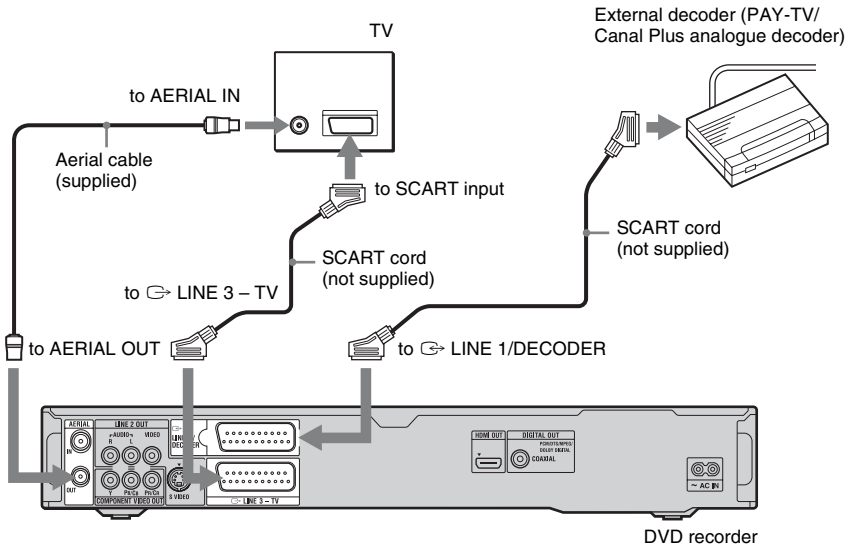

Setting external decoder (PAY-TV/Canal Plus analogue decoder) programme positions

To watch or record PAY-TV/Canal Plus analogue programmes, set your recorder to receive the programme positions using the on-screen display.

In order to set the programme positions correctly, be sure to follow all of the steps below.

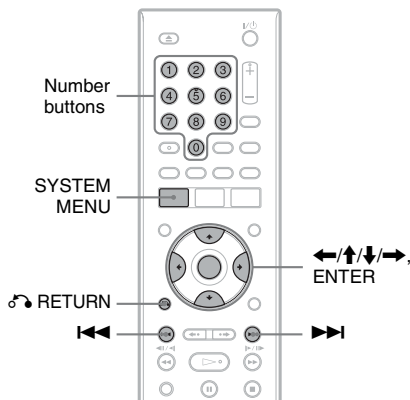

- 1** Press **SYSTEM MENU**.
The System Menu appears.
- 2** Select **"Initial Setup,"** and press **ENTER**.

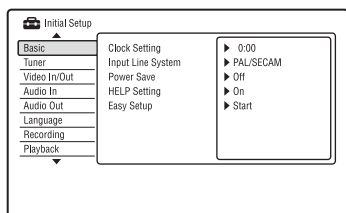

- 3** Select **"Video In/Out,"** and press **ENTER**.

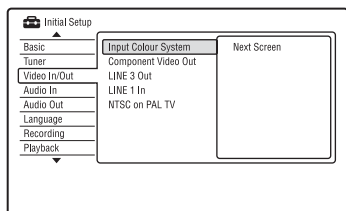

- 4** Select **"LINE 3 Out,"** and press **ENTER**.

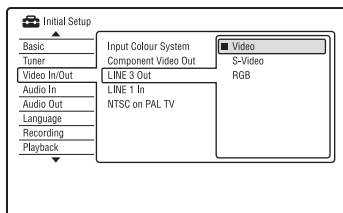

- 5** Press **↑/↓** to select **"Video"** or **"RGB,"** and press **ENTER**.
- 6** Select **"LINE 1 In,"** and press **ENTER**.

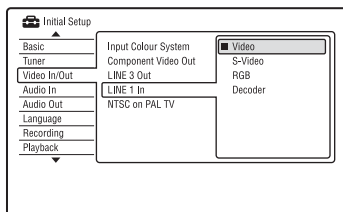

- 7** Press **↑/↓** to select **"Decoder,"** and press **ENTER**.
- 8** Press **RETURN** to return the cursor to the left column.
- 9** Select **"Tuner,"** and press **ENTER**.

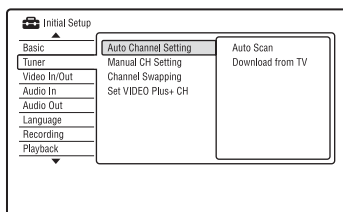

- 10** Select **"Manual CH Setting,"** and press **ENTER**.
- 11** Select **"Next Screen,"** and press **ENTER**.

12 Select your country/region, and press ENTER.

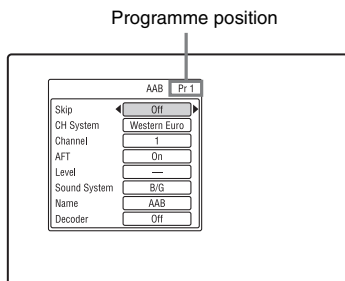

13 Select the desired programme position using **◀◀/▶▶** or number buttons.

14 Select "Channel" using **↑/↓**.

15 Select the external decoder programme position using **←/→**.

16 Select "Sound System" using **↑/↓**.

17 Press **←/→** to select an available TV system, B/G, D/K, I, or L.

To receive broadcasts in France, select "L."

18 Select "Decoder" using **↑/↓**.

19 Select "On" using **←/→**, and press ENTER.

To return to the previous step

Press **↶** RETURN.

⚡ Notes

- If you disconnect the recorder's mains lead, you will not be able to view the signals from the connected decoder.
- To watch the connected external decoder (PAY-TV/Canal Plus analogue decoder) programmes during recording, press the PROGRAM + button on the recorder ("SCART THRU" appears on the front panel display). To return to the previous display, press the PROGRAM - button on the recorder ("SCART NORM" appears on the front panel display). The recorder automatically switches to the programme tuned by the recorder's tuner after the recording has finished. To watch the connected external decoder (PAY-TV/Canal Plus analogue decoder) programmes while the recorder is in standby mode, set "Power Save" to "Off" (default) in the "Basic" setup (page 76).

1. Inserting a Disc

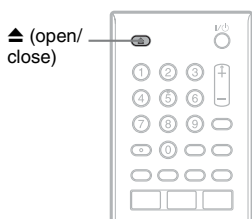

- 1 Press **▲** (open/close), and place a disc on the disc tray.

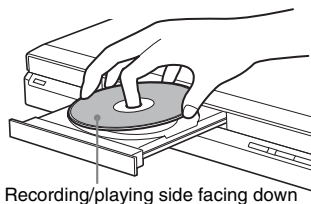

- 2 Press **▲** (open/close) to close the disc tray.

Wait until “LOAD” disappears from the front panel display.

Unused DVDs are formatted automatically.

- For DVD-RW discs

DVD-RWs are formatted in the recording format (VR mode or Video mode) set by “Format DVD-RW” of “Basic” in the “Disc Setup” setup (page 74).

- For DVD-R discs

DVD-Rs are automatically formatted in Video mode. To format an unused DVD-R in VR mode, format the disc in the “Format” setup (page 40) **before** you make a recording.

If the disc is recordable on this recorder, you can manually re-format the disc to make a blank disc (page 40).

2. Recording a Programme



This section introduces the basic operation to record a current TV programme to a disc (DVD). For an explanation of how to make timer recordings, see page 41.

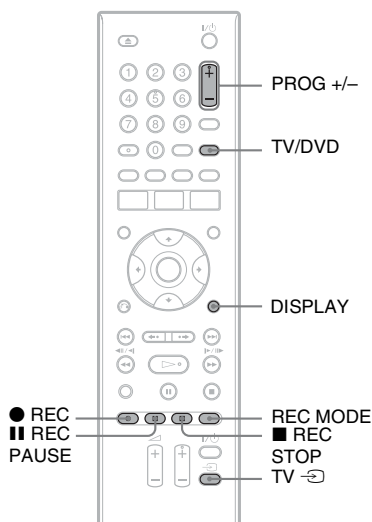

- 1 Insert a recordable DVD.
- 2 Press **PROG +/-** to select the programme position or input source you want to record.

3 Press REC MODE repeatedly to select the recording mode.

Each time you press the button, the display on the TV screen changes as follows:

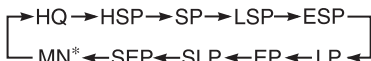

* Available when "Manual Rec. Mode" is set to "On (go to setup)" in the "Recording" setup (page 84).

For more details about the recording mode, see page 41.

4 Press ● REC.

Recording starts.

Recording stops when the DVD is full.

To stop recording

Press ■ REC STOP.

Note that it may take a few seconds for recorder to stop recording.

To pause recording

Press ■ REC PAUSE.

To restart recording, press the button again.

To watch another TV programme while recording

If your TV is connected to the ↗ LINE 3 – TV jack, set your TV to the TV input using the TV/DVD button and select the programme you want to watch. If your TV is connected to the LINE 2 OUT or COMPONENT VIDEO OUT jacks, set the TV to TV input using the TV ↗ button (page 18).

⚡ Notes

- If you press the I/O button while recording, the recorder stops recording and turns off.
- After pressing the ● REC button, it may take a short while to start recording.
- You cannot change the recording mode while recording.
- If there is a power failure, the programme you are recording may be erased.
- You cannot watch a PAY-TV/Canal Plus programme while recording another PAY-TV/Canal Plus programme.

Checking the disc status while recording

You can check the recording information such as recording time or disc type.

Press DISPLAY during recording.

The recording information appears.

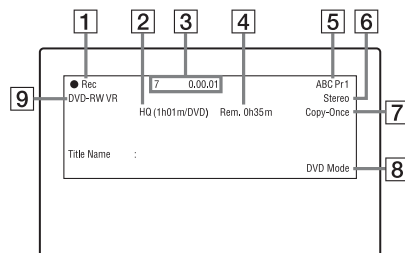

- 1 Recording status
- 2 Current selected recording mode (maximum DVD recording time) (page 41)
- 3 Title number and recording elapsed time
- 4 Remaining time
- 5 Station name and programme position number
- 6 Audio setting for the current programme
- 7 Recording restrictions for the current programme
- 8 TV mode or DVD mode (page 19)
- 9 Disc type/format

Press DISPLAY to turn off the display.

3. Playing the Recorded Programme (Title List)

+RW -RWVR -RWVideo +R -RVR
-RVideo

To play a recorded title, select the title from the Title List.

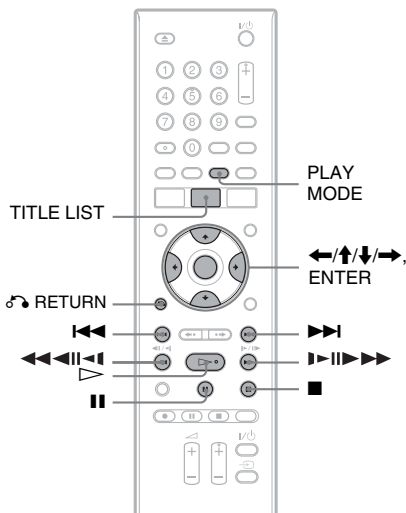

1 Insert a DVD.

See “1. Inserting a Disc” on page 29. Playback starts automatically depending on the disc.

2 Press TITLE LIST.

To show the 8-Title List, press ← to select “Title View,” and press ENTER, then select “8 Titles” using ↑/↓, and press ENTER.

4-Title List (Example: DVD-RW in VR mode)

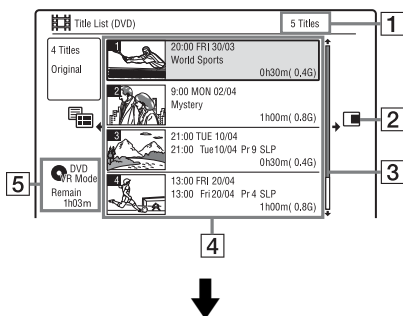

8-Title List

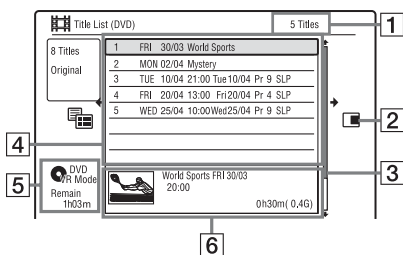

1 Total number of titles

2 Sub-menu:

Press → to display the sub-menu. The sub-menu displays options applicable only to the selected item. The displayed options differ depending upon the model, situation, and disc type.

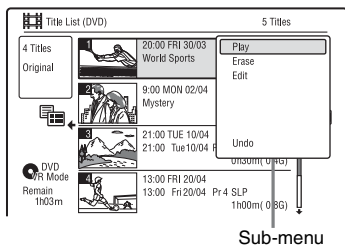

3 Scroll bar:

Appears when all of the titles do not fit on the list. To view the hidden titles, press ↑/↓.

- 4** Title information:
Displays the title number, title thumbnail picture (playback picture for the selected title, still images for the other titles), recording date, title name, and title size.

: Indicates protected title.

- 5** Remaining time of the current disc in the current recording mode (example: SP mode)

- 6** Detailed information for the selected title





3 Select a title using ↑/↓, and press ENTER.

Playback starts from the selected title.

To stop playback

Press  (stop).

To scroll the list display by page (Page mode)

Press   while the Title List is displayed. Each time you press  , the entire Title List changes to the next/previous page of titles.

About the Title List for DVD-RWs/DVD-Rs (VR mode)











You can switch the Title List to show Original or Playlist titles.

- 1** Press  while the Title List is displayed.
- 2** Select “Play List” using ↑/↓, and press ENTER.
- 3** Select “Original” or “Play List” using ↑/↓, and press ENTER.

To change a title thumbnail picture (Thumbnail)

After recording, the first scene of the recording (the title) is automatically set as the thumbnail picture.

You can select a favourite scene for the thumbnail picture shown in the Title List.

- 1** Press TITLE LIST.
For DVD-RWs/DVD-Rs (VR mode), switch the Title Lists, if necessary.
- 2** Select a title, and press .
The sub-menu appears.
- 3** Select “Edit” using ↑/↓, and press ENTER.
- 4** Select “Set Thumbnail” using ↑/↓, and press ENTER.
The display for setting the thumbnail point appears and the title starts to play.
- 5** While watching the playback picture, press ,  or      to select the scene you want to set for a thumbnail picture, and press .
Playback pauses.
You can also select a scene using the PLAY MODE button (page 59).
- 6** Select “OK” using ↑/↓, and press ENTER.
The scene is set for the title’s thumbnail picture.
To return to the Title List, press  RETURN.

To turn off the Title List

Press TITLE LIST.

Hint

You can select “Title List” from the System Menu.

Notes

- The title names may not appear for DVDs created on other DVD recorders.
- It may take a few seconds for the thumbnail pictures to be displayed.
- After editing, the title thumbnail picture may change to the first scene of the recording (title).
- When the Title List does not appear by pressing the TITLE LIST button, the DVD has no Title List. In this case, try pressing the TOP MENU button to display the DVD’s menu.

4. Displaying the Playing Time and Play Information



You can check the playing time of the current title, chapter, track, or disc. Also, you can check the disc name recorded on the DVD/CD.

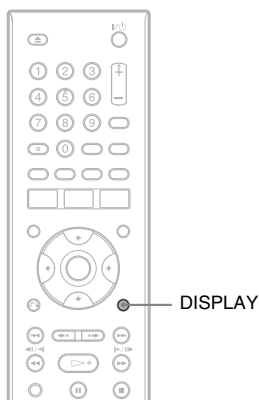

Press DISPLAY repeatedly.

The displays differ depending on the disc type or playing status.

In stop mode

Example: DVD-RW in VR mode

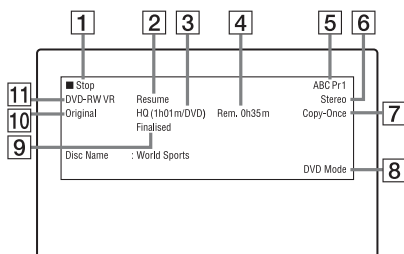

During playback

Example: DVD-R in Video mode

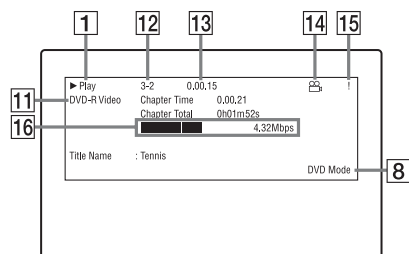

- 1** Playing status
- 2** Shows that the Resume Play is available (page 53).
- 3** Current selected recording mode (maximum DVD recording time) (page 41)
- 4** Remaining time
- 5** Station name and programme position number
- 6** Audio setting for the current programme
- 7** Recording restrictions for the current programme
- 8** TV mode or DVD mode (page 19)
- 9** Disc information
- 10** Title type (Original or Playlist) for DVD-RW/DVD-R in VR mode
- 11** Disc type/format (page 7)
Displays the finalised disc in Video mode as "DVD-VIDEO."
- 12** Title number-Chapter number (page 59)
- 13** Playing time
- 14** Multi-angles indicator (page 52)
- 15** Copy-protected indicator (page 42)
- 16** Data transfer bar and rate

Hints

- When “On Screen Display” is set to “On” (default) in the “Options” setup (page 91), information automatically appears on the screen when the recorder is operated.
- To increase disc space, see “To open up disc space” (page 61).

Note

Playing time of MP3 audio tracks may not be displayed correctly.

5. Changing the Name of a Recorded Programme



You can label a DVD, title, or programme by entering characters. You can enter up to 64 characters for a title recorded in the DVD-RW/DVD-R (VR mode), 40 characters for a title recorded in the DVD+RW/DVD-RW (Video mode)/DVD+R/DVD-R (Video mode), but the actual number of characters displayed in the menus such as the Title List will vary. The steps below explain how to change the name of the recorded programme.

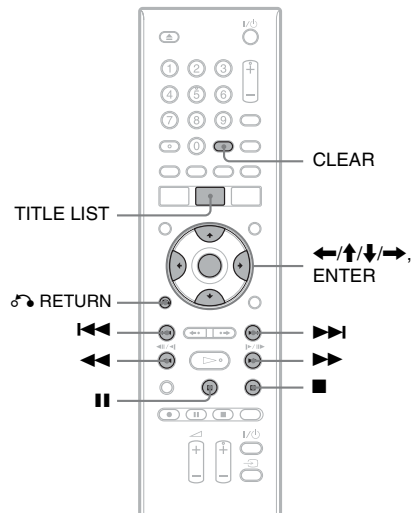

- 1** Press TITLE LIST.
- 2** Select a title, and press **→**.
The sub-menu appears.
- 3** Select “Edit,” and press ENTER.

4 Select “Title Name,” and press ENTER.

The display for entering characters appears.

The current name is displayed at the input row.

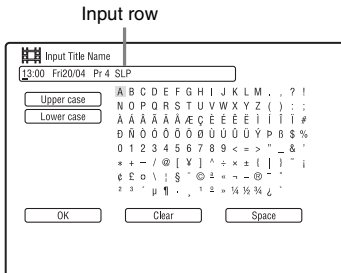

5 Move the cursor to the point where you want to insert the character using ◀▶▶▶.

To erase all of the characters, press and hold CLEAR for 2 seconds or more.

6 Select “Upper case” or “Lower case” using ◀▶▶▶.

The characters for the selected type are displayed.

The type of characters will change according to the language you select in “Easy Setup.”

7 Press ◀/↑/↓/▶ to select the character you want to enter, and press ENTER.

The selected character appears at the input row.

To insert a space, press ■ (or select “Space,” and press ENTER).

8 Repeat steps 6 and 7 to enter the remaining characters.

To erase a character, move the cursor to the character at the input row, and press CLEAR (or select “Clear,” and press ENTER).

To insert a character, move the cursor to the right of the point where you want to insert the character. Then select the character, and press ENTER.

To erase all of the characters, press and hold CLEAR for 2 seconds or more.

9 Press ■ (or select “OK,” and press ENTER).

To cancel the setting, press ⏪ RETURN.

6. Labelling and Protecting a Disc

You can execute options effective for the entire disc in the “Disc Setup” setup.

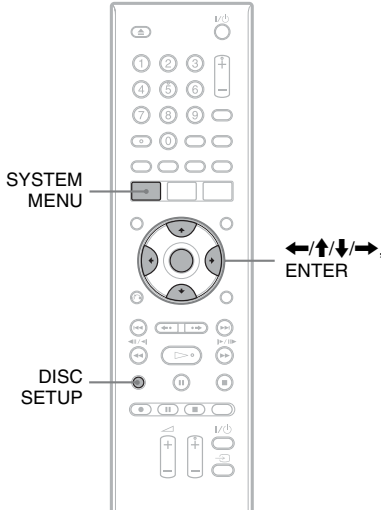

3 Select “Basic,” and press ENTER.

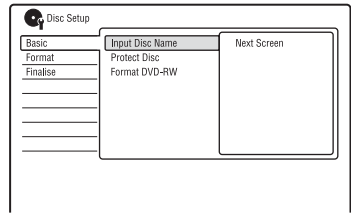

4 Select “Input Disc Name,” and press ENTER.

5 Select “Next Screen,” and press ENTER.

Enter the disc name (page 34).

⚙️ Hint

You can also display the Disc Setup display by selecting “Disc Setup” from the System Menu.

⚡ Note

You can enter up to 64 characters for a DVD-RW/ DVD-R (VR mode) disc name, and 40 characters for a DVD+RW/DVD-RW (Video mode)/DVD+R/ DVD-R (Video mode) disc name. The disc name may not appear when the disc is played on other DVD equipment.

Labelling a disc



1 Insert a disc.

See “1. Inserting a Disc” on page 29.

2 Press DISC SETUP.

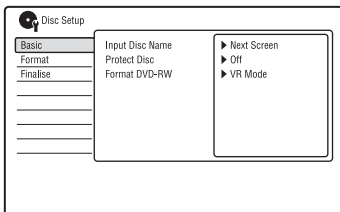

Protecting a disc



1 Insert a disc.

See “1. Inserting a Disc” on page 29.

2 Press DISC SETUP.

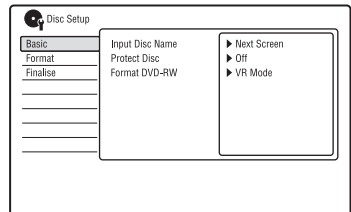

3 Select “Basic,” and press ENTER.

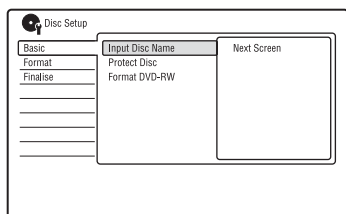

4 Select “Protect Disc,” and press ENTER.

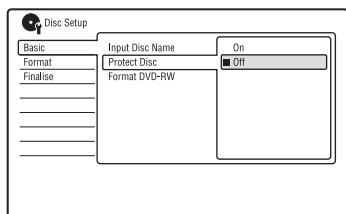

5 Select “On,” and press ENTER.

6 Press SYSTEM MENU to exit.

To cancel the protection

Select “Off” in step 5.

💡 Hints

- You can set protection for individual titles (page 61).
- You can also display the Disc Setup display by selecting “Disc Setup” from the System Menu.

7. Playing the Disc on Other DVD Equipment (Finalise)

+RW **-RWVR** **-RW_{Video}** **+R** **-RVR**
-R_{Video}

Finalising is necessary when you play discs recorded with this recorder on other DVD equipment.

When you finalise a DVD+RW, DVD-RW (Video mode), DVD+R, or DVD-R (Video mode), a DVD menu will be automatically created, which can be displayed on other DVD equipment.

Before finalising, check the differences between the disc types in the table below.

Differences between disc types

+RW

Discs are automatically finalised when removed from the recorder. However, you may need to finalise the disc for certain DVD equipment, or if the recording time is short. You can edit or record on the disc even after finalising.

-RWVR

Finalising is unnecessary when playing a disc on VR format compatible equipment. Even if your other DVD equipment is VR format compatible, you may need to finalise the disc, especially if the recording time is short. You can edit or record on the disc even after finalising.

-RW_{Video}

Finalising is necessary when playing on any equipment other than this recorder. After finalising, you cannot edit or record on the disc. If you want to record on it again, unfinalise (page 39) or reformat the disc (page 40). However, if you reformat the disc, all recorded contents will be erased.

-RVR

Finalising is necessary. The disc can be played only on equipment that supports DVD-R in VR mode. After finalising you cannot edit or record on the disc using this recorder.



Finalising is necessary when playing on any equipment other than this recorder. After finalising, you cannot edit or record on the disc.

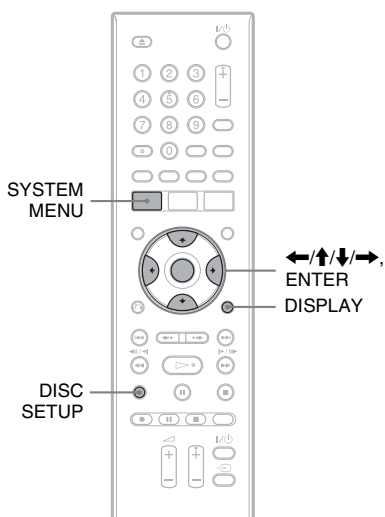

1 Insert a disc.

See "1. Inserting a Disc" on page 29.

2 Press DISC SETUP.

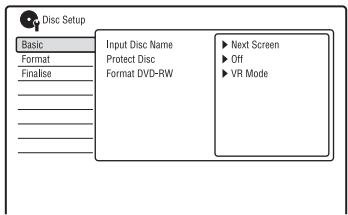

3 Select "Finalise," and press ENTER.

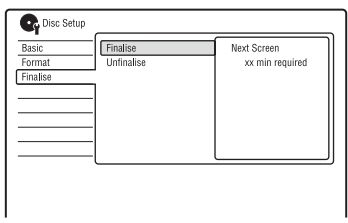

4 Select "Finalise," and press ENTER.

5 Select "Next Screen," and press ENTER.

For DVD-RW/DVD-R (VR mode), the recorder starts finalising the disc. Go to step 8.

6 (DVD+RW/DVD-RW (Video mode)/DVD+R/DVD-R (Video mode) only) Select a title menu style, and press ENTER.

The menu appears in the selected title menu style when the "top menu" (or "menu" for a DVD+RW/DVD+R) is selected on the DVD equipment.

7 (DVD+RW/DVD-RW (Video mode)/DVD+R/DVD-R (Video mode) only) Select "Yes," and press ENTER.

The recorder starts finalising the disc.

8 Press SYSTEM MENU to exit.

Hints

- You can check whether the disc has been finalised or not. Press DISPLAY after step 1 (page 33).
- You can also display the Disc Setup display by selecting "Disc Setup" from the System Menu.

Notes

- Depending on the condition of the disc, recording, or the DVD equipment, discs may not play even if the discs are finalised.
- The recorder may not be able to finalise the disc if it was recorded on another recorder.
- Inserting an unfinalised disc into other DVD equipment may damage the recorded contents.
- When using a DVD+RW, you can edit or record on the disc even after finalising. However, the title menu will not be displayed. Finalise the disc again to display the title menu.

Unfinalising a disc

-RWVR -RWVideo

For DVD-RWs (Video mode)

DVD-RWs (Video mode) that have been finalised to prohibit additional recording or editing can be unfinalised to allow further recording or editing.

For DVD-RWs (VR mode)

If you cannot record or edit on a DVD-RW (VR mode) that has been finalised with other DVD equipment, unfinalise the disc.

Note

The recorder is not able to unfinalise DVD-RWs (Video mode) that have been finalised on another recorder.

1 Insert a disc.

See “1. Inserting a Disc” on page 29.

2 Press DISC SETUP.

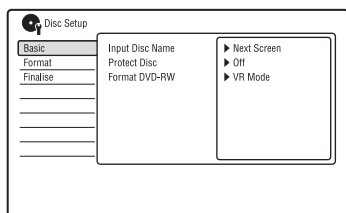

3 Select “Finalise,” and press ENTER.

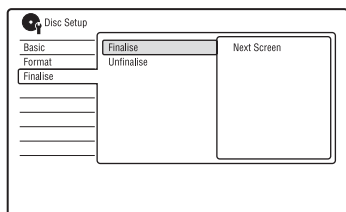

4 Select “Unfinalise,” and press ENTER.

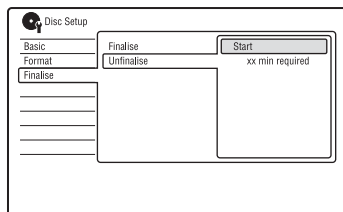

5 Select “Start,” and press ENTER.

The recorder starts unfinalising the disc. Unfinalising may take several minutes.

Hint

You can also display the Disc Setup display by selecting “Disc Setup” from the System Menu.

8. Reformatting a Disc

+RW -RWVR -RWVideo -RVR -RVideo

New discs are automatically formatted when inserted. If necessary, you can manually reformat a DVD+RW, DVD-RW, or DVD-R disc to make a blank disc. For DVD-RWs or DVD-Rs, you can select a recording format (VR mode or Video mode) according to your needs.

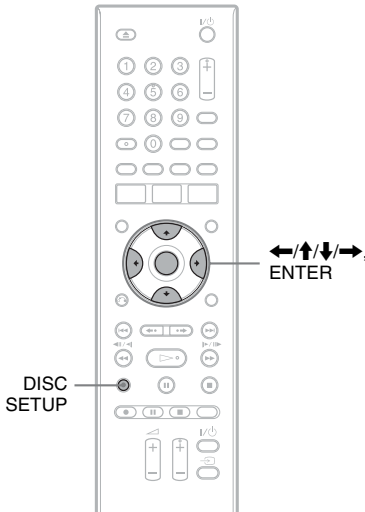

1 Insert a disc.

See "1. Inserting a Disc" on page 29.

2 Press DISC SETUP.

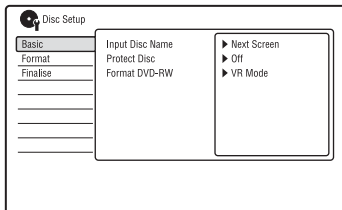

3 Select "Format," and press ENTER.

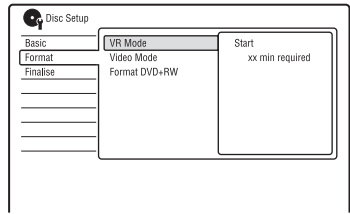

4 Select an item, and press ENTER.

"VR Mode": Formats DVD-RWs/DVD-Rs (VR mode or unrecorded discs) in VR mode.

"Video Mode": Formats DVD-RWs/DVD-Rs in Video mode.

"Format DVD+RW": Formats DVD+RWs.

5 Select "Start," and press ENTER.

All contents on the disc are erased.

⚙ Hints

- By reformatting, you can change the recording format on DVD-RWs, or record again on DVD-RWs that have been finalised.
- You can also display the Disc Setup display by selecting "Disc Setup" from the System Menu.

⚡ Note

You cannot reformat recorded DVD-Rs.

Before Recording

Before you start recording...

- Check that the disc has enough available space for the recording (page 33). For DVD+RWs and DVD-RWs, you can free up disc space by erasing titles (page 61).
- Adjust the recording picture quality if necessary (page 46).

Note

To play a recorded disc on other DVD equipment, finalise the disc (page 37).

Recording mode

Like the standard ×3 recording modes of video tapes, you can select the desired recording mode using the REC MODE button.

Recording modes with higher quality provide a more beautiful recording, but the large data volume also results in a shorter recording time.

Conversely, a longer duration provides a longer recording time, but the lower data volume results in a coarser picture quality.

Press REC MODE repeatedly to switch the recording modes.

To select further options for recording mode (manual recording mode), set “Manual Rec. Mode” to “On (go to setup)” in the “Recording” setup (page 84).

For timer recording, you can also select “AUTO” as recording mode, which maximizes the recording quality for the space available on the disc.

Recording mode	Approx. recording time (hours)	
	DVD* ¹	DVD+R DL* ¹ DVD-R DL* ¹
HQ (High quality)	1 hr. 1 min.	1 hr. 51 min.
HSP ↑	1 hr. 30 min.	2 hr. 41 min.
SP (Standard mode)	2	3 hr. 35 min.
LSP ↓	2 hr. 30 min.	4 hr. 29 min.
ESP ↓	3	5 hr. 23 min.
LP ↓	4	7 hr. 11 min.
EP ↓	6	10 hr. 46 min.
SLP ↓	8	14 hr. 21 min.
SEP* ² (Long duration)	10	17 hr. 57 min.

*¹ The approximate recording time is for 12 cm DVD discs.

*² When recording to DVD+RW or DVD+R, SLP is the longest recording time available. If you select SEP, the recording mode will automatically revert to SLP.

Hint

To easily select a manual recording mode, press REC MODE repeatedly to display “MN,” and select a manual recording mode using ←/→.

Notes

- Situations below may cause slight inaccuracies with the recording time.
 - Recording a programme with poor reception, or a programme or video source of low picture quality.
 - Recording on a disc that has already been edited.
 - Recording only a still picture or just sound.
- Programmes are recorded in the following aspect ratio.
 - In the original aspect ratio, when recording to DVD-RWs/DVD-Rs (VR mode).
 - In 4:3 when recording to DVD+RWs/DVD+Rs.
- When recording to DVD-R DLs (Video mode), the title is divided when the layer switches.

Recording stereo and bilingual programmes

The recorder automatically receives and records stereo and bilingual programmes based on the ZWEITON system or the NICAM system.

A DVD-RW (VR mode) or DVD-R (VR mode) can record both main and sub sounds. You can switch between main and sub when playing the disc.

A DVD+RW, DVD+R, DVD-RW (Video mode), or DVD-R (Video mode) can record only one sound track (main or sub) at a time. Select the sound track in the “Audio In” setup before recording starts. Set “Bilingual Recording” to “A/L” (default) or “B/R” in the “Audio In” setup (page 81).

ZWEITON (German stereo) system

When a stereo-based programme is received, “Stereo” appears.

When a bilingual ZWEITON-based programme is received, “L,” “R,” or “L+R” appears.

NICAM system

To record a NICAM programme, be sure to set “NICAM Select” to “NICAM” (default) in the “Audio In” setup. If the sound is not clear when listening to NICAM broadcasts, set “NICAM Select” to “Standard” (page 81).

Hint

You can select the audio (main or sub) while recording bilingual programmes using the AUDIO button. This does not affect the recorded sound.

Unrecordable pictures

Pictures with copy protection cannot be recorded on this recorder.

Copy control Recordable discs signals

Copy-Free



Copy-Once



Copy-Never

None

* The recorded disc can be played only on CPRM compatible equipment (page 7).

Timer Recording (Standard/VIDEO Plus+)

- +RW** **-RWVR** **-RW_{Video}** **+R** **-RVR**
- R_{Video}**

You can set the timer for a total of 32 programmes (8 programmes when using the VPS/PDC function), up to 30 days in advance.

There are two methods to set the timer: the standard method and VIDEO Plus+ method.

- **Standard:** Set the date, time, and programme position of the programme manually.
- **VIDEO Plus+:** Enter the PlusCode number designated for each TV programme (page 45).

Setting the timer manually (Standard)

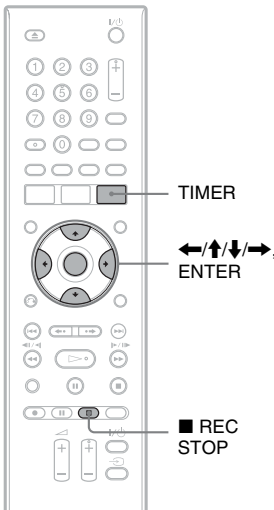

1 Press **TIMER**.

The “Timer List” display appears.

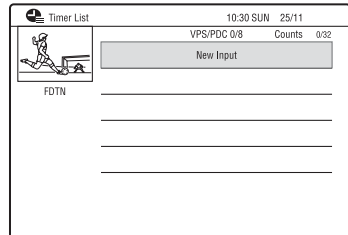

2 Select the “New Input” row, and press **ENTER**.

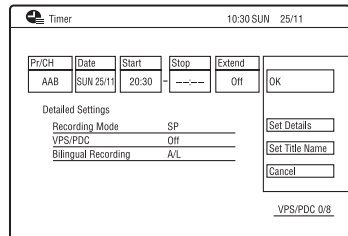

3 Select an item using **←/→** and adjust using **↑/↓**. Then press **ENTER**.

The adjustable items are listed below.

- “Pr/CH”: Sets the programme position.
- “Date”: Sets the date (up to 30 days later). Select a recording pattern by pressing **↑** repeatedly to set the timer for the same daily or weekly programmes.
- “Start”: Sets the start time.
- “Stop”: Sets the stop time.
- “Extend”: Sets duration when a timer recording is in progress. If the programme set to be recorded daily or weekly is extended, the manually extended time set here will be added to the subsequent timer recording times. Note that when “VPS/PDC” is set to “On,” you cannot make the “Extend” setting.

- If you want to make the detailed settings, select “Set Details” and press **ENTER**. Select an item using **↑/↓** and set using **←/→**.
 - “Recording Mode”: Sets the recording mode (page 41).

“VPS/PDC”: Sets the VPS/PDC function. See “About the VPS/PDC function” below.

“Bilingual Recording”: Sets the sound to be recorded (page 81).

- To enter a title name, select “Set Title Name” and press ENTER (page 34).
- If you make a mistake, select the item and change the setting.

4 Select “OK,” and press ENTER.

The “Timer List” display appears (page 48).

The timer recording indicator lights up on the front panel display and the recorder is ready to start recording.

Unlike a VCR, there is no need to turn off the recorder before the timer recording starts.

To stop recording during timer recording

Press **■ REC STOP**.

Note that it may take a few seconds for the recorder to stop recording.

On-screen instructions may appear after pressing **■ REC STOP**. In this case, follow the on-screen instructions.

About the VPS/PDC function

VPS/PDC signals are transmitted with TV programmes in some broadcast systems. These signals ensure that timer recordings are made regardless of any broadcast delays, early starts, or broadcast interruptions.

◆ To use the VPS/PDC function

Set “VPS/PDC” to “On” in step 3 above.

When you turn on this function, the recorder starts scanning the channels before the timer recording starts.

Rec. Mode Adjust

If there is not enough available disc space for the recording, the recorder automatically adjusts the recording mode to enable the entire programme to be recorded. Set “Rec. Mode Adjust” to “On” in the “Recording” setup (page 86).

If the timer settings overlap

The confirmation screen appears.

To store the setting, select “Yes.”

To cancel the overlapped setting, select “No.”

To confirm, change, or cancel a timer recording

See “Checking/Changing/Cancelling Timer Settings (Timer List)” on page 48.

Hint

You can also display the Timer display by selecting “Timer Recording” from the System Menu.

Notes

- Check that the clock is correctly set before setting the timer recording. If not, the timer recording cannot be made.
- To record a satellite programme, turn on the satellite tuner and select the satellite programme you want to record. Leave the satellite tuner turned on until the recorder finishes recording. If you connect equipment with a timer function, you can use the Synchro Rec function (page 49).
- Even if the timer is set for the same daily or weekly programme, the timer recording cannot be made if it overlaps with a programme that has priority. “Overlap” will appear next to the overlapped setting in the Timer List. Check the priority order of the settings (page 48).
- Even if the timer is set, timer recordings cannot be made while recording a programme that has priority.
- The “Rec. Mode Adjust” function only works with a timer recording and the VPS/PDC function set to off. It does not function with Quick Timer or Synchro Rec.
- The beginning of some recordings may not be made when using the VPS/PDC function.
- You cannot extend the recording duration time when “VPS/PDC” is set to “On.”
- The recording mode cannot be set to “AUTO” when “VPS/PDC” is set to “On.”

Recording TV programmes using the VIDEO Plus+ system

The VIDEO Plus+ system is a feature that simplifies setting the timer. Just enter the PlusCode number listed in the TV programme guide. The date, time, and programme position of that programme are set automatically.

Before you start, check that the TV and guide channels are correctly set in "Set VIDEO Plus+ CH" in the "Tuner" setup (page 21).

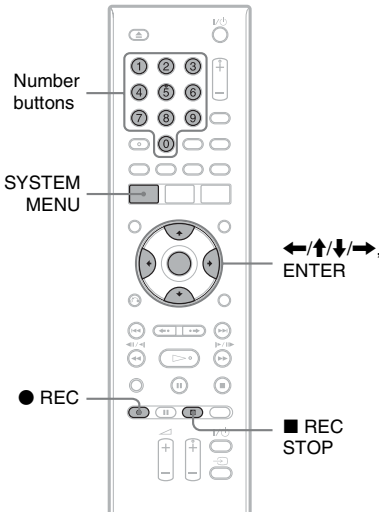

- 1 Press SYSTEM MENU.**
The System Menu appears.
- 2 Select "Timer Recording," and press ENTER.**
- 3 Select "VIDEO Plus+" using \uparrow/\downarrow , and press ENTER.**

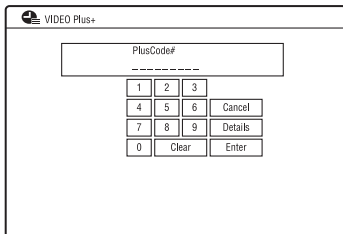

- 4 Enter the PlusCode number using $\leftarrow/\uparrow/\downarrow/\rightarrow$ or the number buttons.**
 - If you want to make the detailed settings, select "Details" using $\leftarrow/\uparrow/\downarrow/\rightarrow$, and press ENTER. The date, start and stop times, programme position, recording mode, etc., settings appear. Press \leftarrow/\rightarrow to select the item and press \uparrow/\downarrow to change the setting (page 43). Then select "OK."

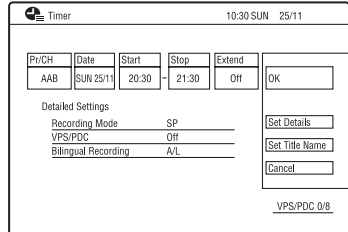

- 5 Press ENTER.**
The timer recording indicator lights up on the front panel display, and the recorder is ready to start recording.

To stop recording during timer recording

Press **■ REC STOP**.

Note that it may take a few seconds for the recorder to stop recording.

On-screen instructions may appear after pressing **■ REC STOP**. In this case, follow the on-screen instructions.

If the timer settings overlap

See page 44.

To confirm, change, or cancel a timer recording

See "Checking/Changing/Canceling Timer Settings (Timer List)" on page 48.

💡 Hint

The "Rec. Mode Adjust" function also works with this timer method (page 44).

Using the Quick Timer function

You can set the recorder to record in 30-minute increments.

Press ● REC repeatedly to set the duration.

Each press advances the time in 30-minute increments. The maximum duration is six hours.

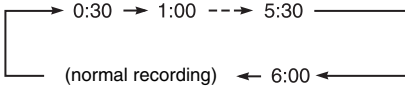

The time counter decreases minute by minute to 0:00, then the recorder stops recording (the power turns off).

To cancel the Quick Timer

Press ● REC repeatedly until the counter appears in the front panel display. The recorder returns to normal recording mode. To stop recording, press ■ REC STOP.

Note

If you turn off the recorder during recording, recording is stopped.

Adjusting the recording picture quality

You can adjust the picture quality by selecting a preset setting. You can also adjust the picture quality by changing detailed settings, and store up to three settings in the memory.

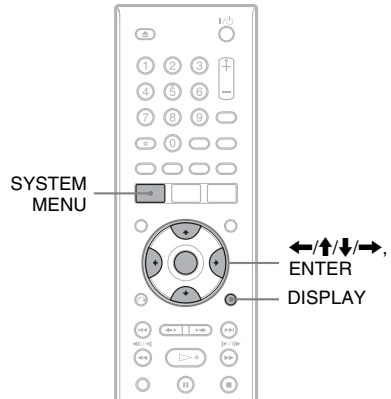

1 Press SYSTEM MENU in stop mode.

The System Menu appears.

2 Select "Picture Adjustment," and press ENTER.

3 Select a preset setting, and press ENTER.

"Tuner": TV broadcasts

"VCR": Video cassettes

"DTV": Digital broadcasts

"Memory1"/"Memory2"/"Memory3":

Your own settings. To create your own settings, see "To create your own setting" on page 47.

To check the detailed settings for the selected preset, press DISPLAY.

4 Press SYSTEM MENU to exit.

To create your own setting

- 1 Select "Memory1," "Memory2," or "Memory3" in step 3.
- 2 Select "Detailed Settings," and press ENTER.
The display for adjusting detailed settings appears.
- 3 Select an item using \uparrow/\downarrow , and adjust settings using \leftarrow/\rightarrow .
For details about each setting, see the explanation of the display.
 - "Prog. Motion": Adjusts the progressive video signal when "Component Video Out" is set to "Progressive" (page 80) or when using the HDMI connection. Select "Motion" for a picture, including subjects that move dynamically. Select "Still" for a picture with little movement.
 - "Cinema": Converts the progressive video signal to match the type of DVD software that you are watching when "Component Video Out" is set to "Progressive" (page 80) or when using the HDMI connection. Select "Auto" to detect the software type (Film-based or Video-based) automatically and select the appropriate conversion mode. Normally select this position.
 - Select "Off" to fix the conversion mode to the mode for Video-based software.
 - "3-D Y/C": Adjusts the brightness/colour separation for the video signals. Select "Motion" for a picture, including subjects that move dynamically. Select "Still" for a picture with little movement.
 - "YNR" (luminance noise reduction): Reduces noise contained in the luminance element of the video signal.
 - "CNR" (chroma noise reduction): Reduces noise contained in the chroma element of the video signal.
 - "Detail": Adjusts the sharpness of images outlines.
 - "White AGC": Turn on for automatic white level adjustment.
 - "White Enhancer": Adjusts the intensity of white.
 - "Black Enhancer": Adjusts the intensity of black.

"Black Level": Selects the black level (setup level) for the NTSC video signals. Select "ON" to remove the 7.5 IRE setup level.

Normally, select "OFF" position.

"Hue": Adjusts the colour balance.

"Chroma Level": Makes the colours deeper or lighter.

- 4 Press SYSTEM MENU to exit.
The setting is automatically stored as the setting you selected in step 1.

Creating chapters in a title

The recorder can automatically divide a recording (a title) into chapters by inserting chapter marks. To select chapter mark intervals or disable this function, see "Auto Chapter (VR)," "Auto Chapter (Video)," or "Auto Chapter (DVD+R/+RW)" in the "Recording" setup (page 86).

When recording to a DVD-R (VR mode) or a DVD-RW (VR mode), you can edit chapter marks (page 63).

Checking/Changing/ Cancelling Timer Settings (Timer List)

+RW -RWVR -RWVideo +R -RVR
-RVideo

You can check, change, or cancel timer settings using the “Timer List.”

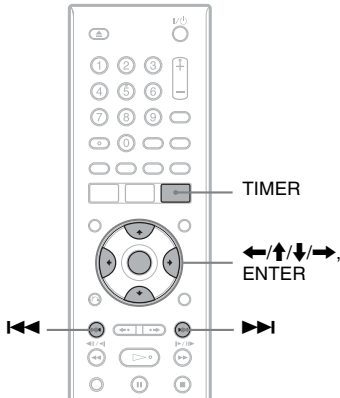

1 Press TIMER.

The “Timer List” display appears.

Timer List		10:30 SUN 25/11	
VPS/PDC 0/8		Counts	4/32
MON - SAT	22:00 - 22:15	AAB	OK
DEF	SUN 25/11 20:30 - 21:30	DEF	Overlap
SUN	25/11 21:00 - 22:00	GHI	Overlap
MON	26/11 16:00 - 17:00	DEF	OK
New Input			

Timer information displays the recording date, time, recording mode, etc.

When all of the timer settings do not fit on the list, the scroll bar appears.

To view the hidden timer settings, press **↑/↓**.

2 Select the timer setting you want to check/change/cancel, and press **→**.

The sub-menu appears.

3 Select an option, and press ENTER.

“Modify”:

Changes the timer setting.

Select an item using **←/→** and adjust using **↑/↓**. Select “OK,” and press ENTER.

Timer		10:30 SUN 25/11			
Pri/CH	Date	Start	Stop	Extend	OK
DEF	SUN 25/11	20:30	21:30	Off	
Detailed Settings					
Recording Mode	SP				
VPS/PDC	Off				
Bilingual Recording	A/L				
					Set Details
					Set Title Name
					Cancel
VPS/PDC 0/8					

“Erase”:

Erases the timer setting. Select “Yes,” and press ENTER.

“Skip Once”:

Cancels the daily or weekly recordings only once. After cancelling the timer setting, “Skip Once” appears next to the timer setting in the “Timer List.”

To change or cancel the setting, repeat steps 2 and 3 above.

When the timer settings overlap

- The programme that starts first has priority and the entire programme is recorded.
- After finishing the previous recording, the other recording starts with several tens-of-second’s delay (when the end-time of one recording and the start-time of another are the same).
- When the recordings start at the same time, only one of them will be recorded. Cancel the timer setting for the programme that you are not going to record.

Hint

You can move to the first row/bottom row of the Timer List using **◀◀/▶▶** while the list is displayed.

Notes

- When “VPS/PDC” is set to “On” for one or more timer recordings, the start times may change in the event of a broadcast delay or early start.
- Even if the timer is set, timer recordings cannot be made while recording a programme that has priority.
- Even if the timer is set for the same daily or weekly programme, the timer recording cannot be made if it overlaps with a programme that has priority. “Overlap” will appear next to the overlapped setting in the Timer List. Check the priority order of the settings.

Recording from Connected Equipment

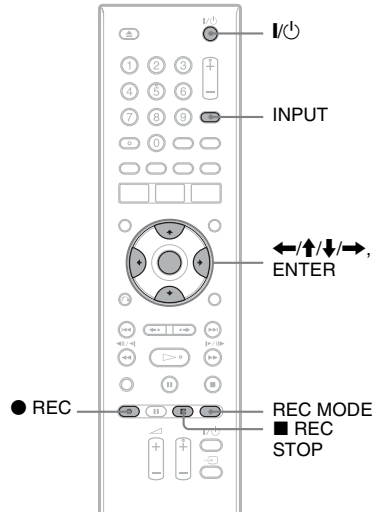

Recording from connected equipment with a timer (Synchro Rec.)

+RW -RWVR -RW_{Video} +R -RVR
-R_{Video}

You can set the recorder to automatically record programmes from connected equipment that has a timer function (such as a satellite tuner). Connect the equipment to the LINE 1/DECODER jack of the recorder (page 25).

When the connected equipment turns on, the recorder starts recording a programme from the LINE 1/DECODER jack.

1 Press REC MODE repeatedly to select the recording mode.

For details about recording mode, see page 41.

2 Select the desired audio signal when recording a bilingual programme.

Set "External Audio" to "Bilingual" and "Bilingual Recording" to "A/L" or "B/R" in the "Audio In" setup (page 81). For details about the bilingual recording, see page 42.

3 Set the timer on the connected equipment to the time of the programme you want to record, and turn it off.

4 Press down ■ REC STOP on the recorder for more than 3 seconds.

The SYNCHRO REC indicator lights up in the front panel display and the recorder turns off. The recorder is ready to start Synchro-Recording.

You can also set the recorder to stand by for Synchro-Recording by setting "Synchro Rec." of "Timer Recording" to "Yes" from the System Menu.

To cancel Synchro Rec before recording starts

Press I/O.

The SYNCHRO REC indicator in the front panel display turns off.

To cancel Synchro Rec during recording

Press down ● REC for more than 3 seconds. The Synchro Rec is cancelled, and the recording continues.

To stop recording

Press ■ REC STOP. Then select "Yes" in the confirmation display, and press ENTER.

Notes

- The recorder starts recording only after detecting a video signal from the connected equipment. The beginning of the programme may not be recorded regardless of whether or not the recorder's power is on or off.
- The Synchro Rec function does not work when "LINE 1 In" is set to "Decoder" in the "Video In/Out" setup (page 80).
- The Synchro Rec function does not work with some tuners. For details, see the tuner's operating instructions.
- The Synchro Rec function does not work when the timer is set for the programme from the LINE 1/DECODER jack and the VPS/PDC function is on.
- While the recorder is standing by for Synchro-Recording, the Auto Clock Set function (page 75) does not work.
- To use the Synchro Rec function, you must first set the recorder's clock correctly.
- For a bilingual programme, only the audio signal selected in step 2 can be played back.

If the timer settings of a Synchro-Recording and another timer recording overlap

Timer recordings always have priority. The Synchro-Recording starts only after the timer recording has finished.

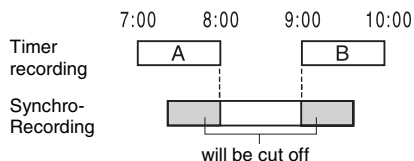

Recording from connected equipment without a timer

+RW -RWVR -RW_{Video} +R -RVR

-R_{Video}

You can record from a connected VCR or similar device. To connect a VCR or similar device, see “Connecting a VCR or Similar Device” on page 23.

1 Insert a recordable DVD.

See “1. Inserting a Disc” on page 29.

2 Press INPUT to select an input source according to the connection you made.

The front panel display changes as follows:

programme position → L1 → L2



3 Select the desired audio signal when recording a bilingual programme to DVD-RWs/DVD-Rs (Video mode).

Set “External Audio” to “Bilingual” and “Bilingual Recording” to “A/L” or “B/R” in the “Audio In” setup (page 81).

4 Press REC MODE repeatedly to select the recording mode.

For details about the recording mode, see page 41.

5 Insert the source tape into the connected equipment and set to playback pause.

6 Press ● REC.

This recorder starts recording.

7 Press the pause (or play) button on the connected equipment to cancel the playback pause status.

The connected equipment starts playback and the playback image is recorded by this recorder.

To stop recording, press ■ REC STOP on this recorder.

Hint

You can adjust the settings for the recording picture before recording. See “Adjusting the recording picture quality” on page 46.

Notes

- When recording a video game image, the screen may not be clear.
- Any programme that contains a Copy-Never copy guard signal cannot be recorded.
- When “Bilingual Recording” is set to “A/L” or “B/R” in step 3, you cannot select the sound when playing in the following cases.
 - When recording in PCM mode.
 - When recording to DVD+RW/DVD+R/DVD-RW/DVD-R (Video mode).
- You cannot select “L1” in step 2 if “LINE 1 In” is set to “Decoder” in the “Video In/Out” setup (page 80).

Playing the Recorded Programme/DVD



* DivX video file only

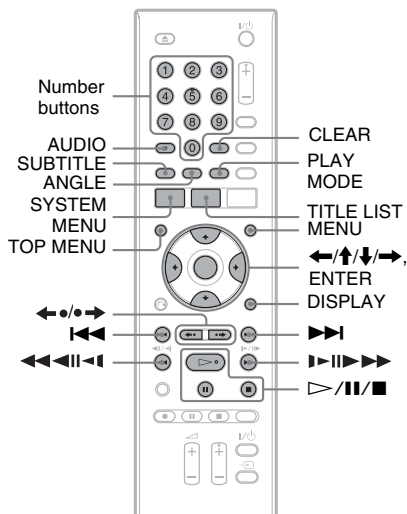

1 Insert a disc.

- See “1. Inserting a Disc” on page 29.
- If you insert a DVD VIDEO, VIDEO CD, DATA DVD or DATA CD, press \triangleright . Playback starts.

2 Press TITLE LIST.

For details about the Title List, see “3. Playing the Recorded Programme (Title List)” on page 31.

Example: DVD-RW in VR mode

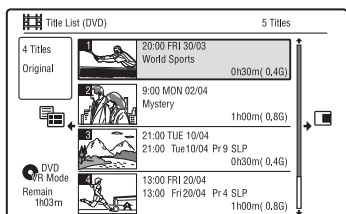

3 Select a title using \uparrow/\downarrow , and press ENTER.

Playback starts from the selected title.

To use the DVD's Menu

When you play a DVD VIDEO, or a finalised DVD+RW, DVD-RW (Video mode), DVD+R, or DVD-R (Video mode), you can display the disc's menu by pressing TOP MENU or MENU.

Note

The \triangleright button is not available in the disc's menu.

To play VIDEO CDs/Super VIDEO CDs with PBC functions

PBC (Playback Control) allows you to play VIDEO CDs/Super VIDEO CDs interactively using the menu on your TV screen.

When you start playing a VIDEO CD/Super VIDEO CD with PBC functions, the menu appears.

Select an item using the number buttons, and press ENTER. Then, follow the instructions in the menu (press \triangleright when “Press SELECT” appears).

Note

Some playback options such as search, repeat play or programme play cannot be played with PBC function. To play with playback options, start playback without PBC functions using the Title List.

To change the angles

If various angles (multi-angles) for a scene are recorded on the disc, “” appears on the screen. Press ANGLE during playback. To switch the angle mark indicator to off, set “Angle Indicator” to “Off” in the “Playback” setup (page 89).

To stop playback

Press \blacksquare .

To playback quickly with sound (Scan Audio)

When you press $\blacktriangleright\blacktriangleright$ during playback, you can play quickly with dialogue or sound (except for VIDEO CDs/Super VIDEO CDs).

No sound is output when you press $\blacktriangleright\blacktriangleright$ two or more times to change search speed.

To display the registration code for this recorder

Select “Registration Code” of “DivX” in the “Options” setup (page 92).

To resume playback from the point where you stopped (Resume Play)

When you press \triangleright again after you stop playback, the recorder resumes playback from the point where you pressed \blacksquare .

To start from the beginning, press \blacksquare again, and press \triangleright . Playback starts from the beginning of the title/track/scene.

The point where you stopped playing is cleared when:

- you open the disc tray.
- you play another title.
- you start playback using the Title List.
- you edit the title after stopping playback.
- you change the settings on the recorder.
- you make a recording (except DVD-RWs/DVD-Rs in VR mode).
- you disconnect the mains lead.

Note

Resume Play is not available for Super VIDEO CDs.

To play restricted DVDs (Parental Control)

If you play a restricted DVD, the display for entering your password appears on your TV screen.

Enter your four-digit password using the number buttons, and press ENTER.

The recorder starts playback.

To register or change the password, see “Parental Control (DVD VIDEO only)” on page 88.

To lock the recorder (Child Lock)

You can lock all of the buttons on the recorder so that the settings are not cancelled by mistake.

When the recorder is turned off, hold down \blacksquare on the recorder until “LOCKED” appears in the front panel display. The recorder does not work except for timer recordings and Synchro-Recording while the Child Lock is set.

To unlock the recorder, hold down \blacksquare on the recorder until “UNLOCKED” appears in the front panel display.

One-Touch Play (for SCART/HDMI connections only)

Press \triangleright . With one touch of the \triangleright button, the recorder and your TV automatically turn on and the TV’s input is switched to the recorder. Playback starts automatically. Set “HDMI Control” to “On” in the “HDMI Output” setup (page 91) to use the One-Touch Play function.

Hint









You can also use the \triangleright button in step 3 (page 52) to start playback.

Note

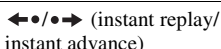
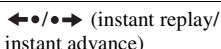
When using the HDMI connection, there may be a delay, before the playback picture appears on the TV screen, and the beginning portion of the playback picture may not be displayed.

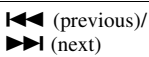
Playback options

To check the position of the buttons below, see the illustration on page 52.

Buttons	Operations
AUDIO  * DivX video file only	Selects one of the audio tracks recorded on the disc when pressed repeatedly in normal playback mode. DVD DATA DVD * DATA CD *: Selects the language. -RWVR -RVR : Selects the main or sub sound. VCD : Selects stereo or monaural audio tracks.
SUBTITLE  * DivX video file only	Selects a subtitle language when pressed repeatedly.
 (instant replay/ instant advance)	Each time you press  , replays the scene for the following duration. 5 seconds → 15 seconds → 30 seconds → 1 minute → 2 minutes → 3 minutes → 5 minutes → 10 minutes → 20 minutes → advances the time in 10-minute increments → 2 hours Each time you press  , briefly fast forwards the current scene for the following duration. 30 seconds → 1 minute → 1 minute 30 seconds → 2 minutes → 3 minutes → 5 minutes → 10 minutes → 20 minutes → advances the time in 10-minute increments → 2 hours
 (previous/ next)	Goes to the beginning of the previous/next title/chapter/scene/track when pressed during playback. Goes to the beginning of the first title/track when pressed in stop mode.
 (fast reverse/fast forward)	Fast reverses/fast forwards the disc when pressed during playback. Search speed changes as follows: <div style="text-align: center;"> <p>fast reverse fast forward</p> <p>◀◀FR^{*1} ← →▶▶FF^{*2}</p> <p>◀◀◀FR^{*2} ← ← → →▶▶▶FF^{*2}</p> <p>◀◀◀◀FR^{*3} ← ← ← → → →▶▶▶▶FF^{*3}</p> <p>◀◀◀◀◀FR^{*3} ← ← ← ← → → → →▶▶▶▶▶FF^{*3}</p> </div> When you press and hold the button, fast forward/fast reverse continues at the selected speed until you release the button. ^{*1} When you press  once during playback, you can play Reverse play (not available for VIDEO CDs/Super VIDEO CDs/DivX video files). ^{*2} When you press  once during playback, you can play quickly with sound (not available for VIDEO CDs/Super VIDEO CDs). ^{*3} Not available for VIDEO CDs/Super VIDEO CDs.
	To resume normal playback, press  .

Buttons	Operations
 (slow, freeze frame)	Plays in slow motion when pressed for more than one second in pause mode. Plays one frame at a time when pressed briefly in pause mode. To resume normal playback, press ▷.
+RW -RWVR -RW _{Video} +R -RVR -R _{Video} DVD VCD *1 DATA DVD *1*2 DATA CD *1*2	
*1 Playback direction only *2 DivX video file only	
II (pause)	Pauses playback. To resume normal playback, press ▷.

Notes

- Angles and subtitles cannot be changed with titles recorded on this recorder.
- JPEG image files made with a DVD camcorder can only be played as a slideshow. For video files containing JPEG image files and movies, the recorder can play movie parts only.

Notes on playing DVDs with a DTS sound track

DTS audio signals are output only through the DIGITAL OUT (COAXIAL) jack.
 When you play a DVD with DTS sound tracks, set “DTS Output” to “On” in the “Audio Out” setup (page 82).

Playing a specific portion repeatedly (A-B Repeat)

1 Press PLAY MODE during playback.

The "Play Mode" menu appears.

2 Select "A-B Repeat," and press ENTER.

"Set point A" is selected.

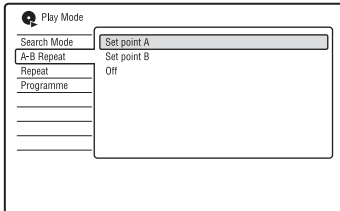

3 While monitoring the sound, press ENTER at the starting point (point A) of the portion to be played repeatedly.

"Set point B" is selected.

4 Continue playing to locate the ending point (point B), and press ENTER.

A-B Repeat starts.

To cancel A-B Repeat

Press CLEAR. Or, set "A-B Repeat" to "Off" in the "Play Mode" menu.

Hint

You can select "A-B Repeat" from "Play Mode" in the System Menu.

Note

When playing a DVD VIDEO/DVD-RW (Video mode)/DVD-R (Video mode), set the start and stop points within the same title.

Playing repeatedly (Repeat)

You can play repeatedly all the titles/tracks/files or a single title/chapter/track on a disc.

1 Press PLAY MODE during playback.

The "Play Mode" menu appears.

2 Select "Repeat," and press ENTER.

3 Select an item to be repeated using / .

"Repeat Title" (for DVDs/DATA DVDs^{*1}/DATA CDs^{*1}): repeats the current title.

"Repeat Chapter" (for DVDs): repeats the current chapter.

"Repeat Track" (for VIDEO CDs^{*2}): repeats the current track.

"Repeat Programme": repeats the current programme (page 57).

"Repeat Disc" (for VIDEO CDs^{*2}/DVD-RWs/DVD-Rs (VR mode)): repeats all of the tracks on a disc.

^{*1} DivX video file only

^{*2} Available only when playing without PBC functions

4 Press ENTER.

Repeat play starts.

To cancel Repeat play

Press CLEAR. Or, set "Repeat" to "Repeat Off" in the "Play Mode" menu.

Hint

You can select "Repeat" from "Play Mode" in the System Menu.

Note

You cannot select "Repeat Programme" when no programme remains.

Creating your own programme (Programme)

-RWVideo * -RVideo * VCD

* finalised disc only

You can play the contents of a disc in the order you want by arranging the order of the titles/chapters/albums/tracks on the disc to create your own programme. You can make a programme of up to 24 steps.

1 Press PLAY MODE during playback.

The "Play Mode" menu appears.

2 Select "Programme," and press ENTER.

3 Select "Input/Edit Programme," and press ENTER.

The "Input/Edit Programme" display differs depending upon the disc type.

Example: DVD

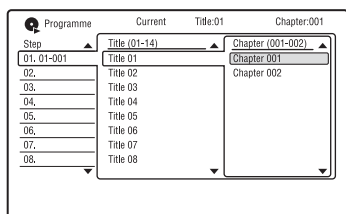

4 Select a title or album (example: Title 01) using ↑/↓, and press ENTER.

5 Select a chapter or track (example: Chapter 001) using ↑/↓, and press ENTER.

The chapter or track is programmed. If you make a mistake, select the step number (example: 01.) using ←/↑/↓, and press CLEAR.

6 To programme other chapters or tracks, press ←/↑/↓/→ to select a step number, and repeat steps 4 and 5.

7 Press ▷.

Programme play starts.

To cancel Programme play

Press CLEAR during playback. Or, set "Programme" to "Cancel Programme Play" in the "Play Mode" menu.

To erase the programme

Press CLEAR in stop mode. Or, set "Programme" to "Erase Programme List" in the "Play Mode" menu.

🔧 Hints

- The program you made remains after Programme play finishes. To play the same program again, set "Programme" to "Start Programme Play" in the "Play Mode" menu. However, the programme is cleared after you remove the disc or press I/O.
- You can repeat Programme play. Set "Repeat" to "Repeat Programme" in the "Play Mode" menu (page 56).
- You can select "Programme" from "Play Mode" in the System Menu.

Adjusting the picture quality

+RW -RWVR -RWVideo +R -RVR
-RVideo DVD VCD DATA DVD * DATA CD *

* DivX video file only

You can adjust the picture quality from connected equipment, such as a TV or projector by selecting a preset setting. You can also adjust the picture quality by changing detailed settings, and store up to three settings in the memory.

1 Press SYSTEM MENU during playback or in pause mode.

The System Menu appears.

2 Select "Picture Adjustment," and press ENTER.

3 Select a preset setting using ←/→, and press ENTER.

Dynamic: produces a bold dynamic picture by increasing the picture contrast and the colour intensity.

Standard: displays a standard picture.

Professional: displays an original picture.

Memory1/Memory2/Memory3: Your own settings. To create your own settings, see "To create your own setting" below.

To check the detailed settings for the selected preset, press DISPLAY.

4 Press SYSTEM MENU to exit.

To create your own setting

- 1 Select “Memory1,” “Memory2,” or “Memory3” in step 3.
- 2 Select “Detailed Settings,” and press ENTER.

The display for adjusting detailed settings appears.

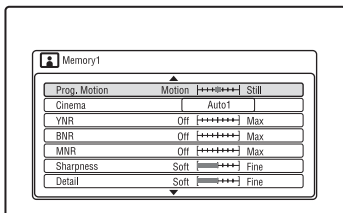

- 3 Select an item using \uparrow/\downarrow , and adjust settings using \leftarrow/\rightarrow .

For details about each setting, see the explanation of the display.

“Prog. Motion”: Adjusts the progressive video signal when “Component Video Out” is set to “Progressive” (page 80) or when “Screen Resolution” is set to other than “720 x 576i” (or “720 x 480i”) (page 90).

Select “Motion” for a picture, including subjects that move dynamically. Select “Still” for a picture with little movement.

“Cinema”: Converts the progressive video signal to match the type of DVD software that you are watching when “Component Video Out” is set to “Progressive” (page 80) or when “Screen Resolution” is set to other than “720 x 576i” (or “720 x 480i”) (page 90). Select “Auto1” to automatically detect the software type (Film-based or Video-based) and select the appropriate conversion mode. Normally select this position.

If the picture appears unnatural, select “Auto2,” “On,” or “Off.”

“YNR” (luminance noise reduction): Reduces noise contained in the luminance element of the video signal.

“BNR” (block noise reduction): Reduces “block noise” or mosaic-like patterns in the picture.

“MNR” (mosquito noise reduction): Reduces the faint noise appearing around the outlines of the images. The noise reduction effects are automatically adjusted within each setting range according to the video bit rate and other factors.

“Sharpness”: Sharpens the outlines of the images.

“Detail”: Adjusts the sharpness of images outlines.

“White Enhancer”: Adjusts the intensity of white.

“Black Enhancer”: Adjusts the intensity of black.

“Black Level”: Selects the black level (setup level) for the video signals. Select “ON” to raise the black level.

Select this when the picture appears too dark.

Select “OFF” to set the black level of the input signals to the standard level. Normally, select this position.

“Gamma Correction”: Adjusts how dark areas look.

“Hue”: Adjusts the colour balance.

“Chroma Level”: Makes the colours deeper or lighter.

4 Press SYSTEM MENU to exit.

The setting is automatically stored as the setting you selected in step 1.

Notes

- If the outlines of the images on your screen become blurred, set “BNR” and/or “MNR” to “Off.”
- Depending on the disc or the scene being played, the above BNR or MNR effects may be hard to discern. Also, these functions may not work with some screen sizes.
- The following settings are not available for the signals output from the HDMI jack.
 - “Sharpness”
 - “White Enhancer”
 - “Black Enhancer”
 - “Black Level”
 - “Gamma Correction”
 - “Hue”
 - “Chroma Level”

Searching for a Time/ Title/Chapter/Track, etc.

+RW -RWVR -RW_{Video} +R -RVR
 -R_{Video} DVD VCD DATA DVD * DATA CD *

* DivX video file only

You can search a disc by title, chapter, scene or track. As titles and tracks are assigned individual numbers, select the title or track by entering its number. You can also search for a scene using the time code.

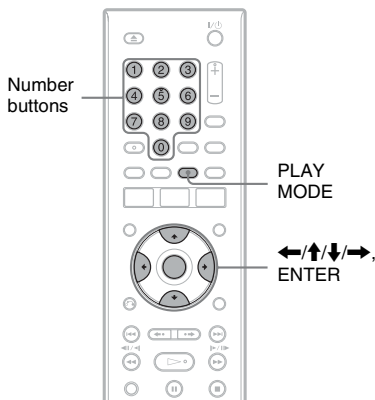

1 Press PLAY MODE during playback.

The "Play Mode" menu appears.

2 Select "Search Mode," and press ENTER.

3 Select a search method, and press ENTER.

"Time Search" (for DVDs/DATA DVDs^{*1}/DATA CDs^{*1}/VIDEO CDs^{*2*3}): Searches for a starting point by entering the time code.

"Title Search" (for DVDs/DATA DVDs^{*1}/DATA CDs^{*1})

"Chapter Search" (for DVDs)

"Track Search" (for VIDEO CDs^{*3})

*1 DivX video file only

*2 Except Super VIDEO CDs

*3 Available only when playing without PBC functions

The display for entering the number appears.

Example: Chapter Search

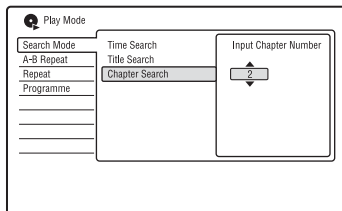

4 Press the number buttons to select the number of the title, chapter, time code, etc., you want.

For example: Time Search

To find a scene at 2 hours, 10 minutes, and 20 seconds, enter "21020."

If you make a mistake, select another number.

5 Press ENTER.

The recorder starts playback from the selected number.

Before Editing

This recorder offers various edit options for various disc types.

Notes

- You may lose the edited contents if you remove the disc or a timer recording starts while editing.
- DVD discs created by DVD camcorders cannot be edited on this recorder.
- If a message appears and indicates that the disc's control information is full, erase or edit unnecessary titles.
- The remaining disc space displayed on the screen may differ from the actual remaining disc space.
- When editing a DVD+R or DVD-R, finish all editing before finalising the disc. You cannot edit a finalised disc.

Edit features		+RW	-RWVR	Original title	Playlist title
		-RWVideo	-RVR		
		+R			
		-RVideo			
Title edit	Erase (page 61)	Yes	Yes	Yes	Yes
	Title Name (page 61)	Yes	Yes	Yes	Yes
	Set Thumbnail (page 61)	Yes	Yes	Yes	Yes
	A-B Erase (page 62)	No	Yes	Yes	Yes
	Divide (page 65)	No	No	No	Yes
	Protect (page 61)	Yes	Yes	Yes	No
	Move (page 65)	No	No	No	Yes
	Combine (page 65)	No	No	No	Yes
	Creating a Playlist (page 64)	No	No	No	Yes
	Undo (page 61)	Yes	Yes	Yes	Yes
Chapter edit	Divide (page 63)	No	Yes	Yes	Yes
	Erase (page 64)	No	Yes	Yes	Yes
	Move (page 66)	No	No	No	Yes
	Combine (page 64)	No	Yes	Yes	Yes

To open up disc space

To open up disc space on a DVD+RW or DVD-RW (Video mode), erase the title with the largest number in the title list.

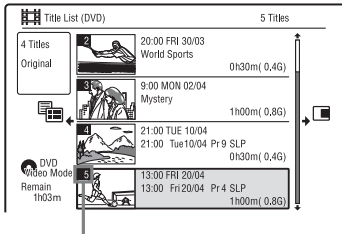

Largest title number

To open up disc space on a DVD-RW (VR mode), you can erase any title. See “Erasing and Editing a Title” on page 61. For DVD-Rs and DVD+Rs, the available disc space does not increase even if you erase titles.

To switch between the Playlist and Original Title List (DVD-RW/DVD-R in VR mode only)

You can display the Playlist titles in the Title List (Playlist), or the Original titles in the Title List (Original).

- 1 Press **←** while the Title List is displayed.
- 2 Select “Play List” using **↑/↓**, and press **ENTER**.
- 3 Select “Original” or “Play List” using **↑/↓**, and press **ENTER**.

Erasing and Editing a Title



This section explains the basic edit functions. Note that editing is irreversible. To edit DVD-RWs/DVD-Rs (VR mode) without changing the original recordings, create a Playlist title (page 64).

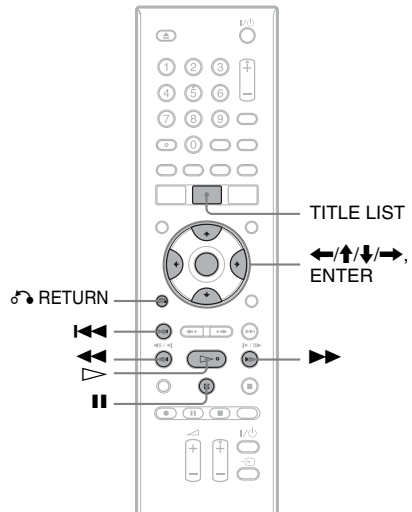

- 1 **Press TITLE LIST.**
For DVD-RWs/DVD-Rs in VR mode, switch the Title List (Original or Playlist), if necessary.
- 2 **Select a title, and press →.**
The sub-menu appears.
- 3 **Select an option, and press ENTER.**

You can make the following edits to the title.

“Erase”: Erases the selected title. Select “Yes” when asked for confirmation.

“Edit”: Allows you to make the following edits.

- “Title Name”: Allows you to enter or re-enter a title name (page 34).
- “Set Thumbnail”: Changes the title’s thumbnail picture that appears in the Title List (page 32).

- “A-B Erase”: Erases a section of the title (page 62).
- “Divide”: Divides a title into two titles (page 65).
- “Chapter Edit”: Edits chapters in a title (page 63).
- “Protect”: Protects the title. “ ” appears next to the protected title.
- “Move”: Changes the title’s playing order (page 65).
- “Combine”: Combines two titles into one (page 65).
- “Create”: Creates a Playlist (page 64).
- “Undo”: Undoes the last edit you made.

Hint

You can label or re-label DVDs (page 36).





Erasing a section of a title (A-B Erase)



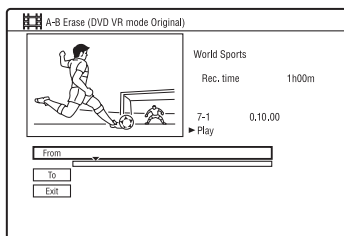

You can select a section (scene) in a title and erase it. Note that erasing scenes in a title cannot be undone.

- 1 After step 2 of “Erasing and Editing a Title,” select “Edit,” and press ENTER.**
- 2 Select “A-B Erase,” and press ENTER.**
The display for setting point A appears.
The title starts to play.



- 3 Select point A using  or , and press II.**
 - To return to the beginning of the title, press **II** and then press .
- 4 Select “From,” and press ENTER.**
The position of point A is displayed.
- 5 Press .**

6 Select point B using  or , and press II.

7 Select “To,” and press ENTER.
The position of point B is displayed.

8 Select “Yes,” and press ENTER.
The scene is erased.

To cancel “A-B Erase”

Press  RETURN. The Title List appears.

Hint

A chapter mark is inserted after the scene is erased. The chapter mark divides the title into separate chapters on either side of the mark.

Notes

- Images or sound may be momentarily interrupted at the point where you erase a section of a title.
- Sections shorter than five seconds may not be erased.

Erasing and Editing a Chapter

-RWVR -RVR

You can edit individual chapters within a title. To edit DVD-RWs/DVD-Rs (VR mode) without changing the original recordings, create a Playlist (page 64).

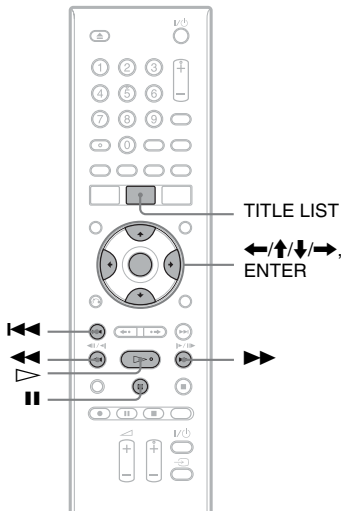

- 1 Press TITLE LIST.**
For DVD-RWs/DVD-Rs in VR mode, switch the Title List (Original or Playlist), if necessary.
- 2 Select a title containing the chapter you want to edit, and press →.**
The sub-menu appears.
- 3 Select “Edit,” and press ENTER.**
- 4 Select “Chapter Edit,” and press ENTER.**

- 5 Select an option, and press ENTER.**
You can make the following edits to the chapter.
“Divide”: Divides a chapter into two (page 63).
“Erase/Move”
 - “Erase”: Erases the selected chapter (page 64).
 - “Move” (for Playlist titles on DVD-RWs/DVD-Rs in VR mode): Changes the chapter’s playing order (page 66).
- “Combine”: Combines two chapters into one (page 64).

Dividing a chapter (Divide)

- 1 After step 4 of “Erasing and Editing a Chapter,” select “Divide.”**

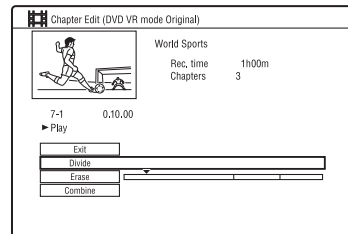

- 2 Select a chapter using ←/→, and press ENTER.**
- 3 Select the dividing point using ◀◀/▶▶ or ▷, and press ■.**
 - To return to the beginning of the chapter, press ■ and then press ◀◀.
- 4 Press ENTER.**
The chapter is divided into two.

Erasing a chapter (Erase)

- 1 After step 4 of “Erasing and Editing a Chapter,” select “Erase.”

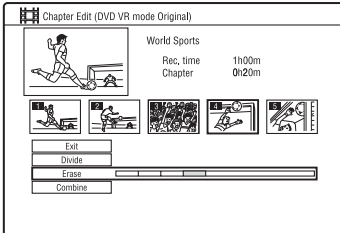

- 2 Select a chapter using \leftarrow/\rightarrow , and press ENTER.
- 3 (For a Playlist chapter only) Select “Erase,” and press ENTER. The display asks for confirmation.
- 4 Select “Yes,” and press ENTER. The chapter is erased.

Combining multiple chapters (Combine)

- 1 After step 4 of “Erasing and Editing a Chapter,” select “Combine.”

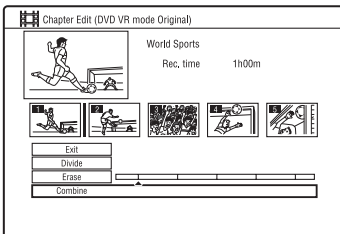

- 2 Move the combining bar using \leftarrow/\rightarrow , and press ENTER. The two adjacent chapters of the combining bar are combined.

Creating and Editing a Playlist

-RWVR -RVR

Playlist edit allows you to edit or re-edit without changing the actual recordings. You can create up to 99 Playlist titles.

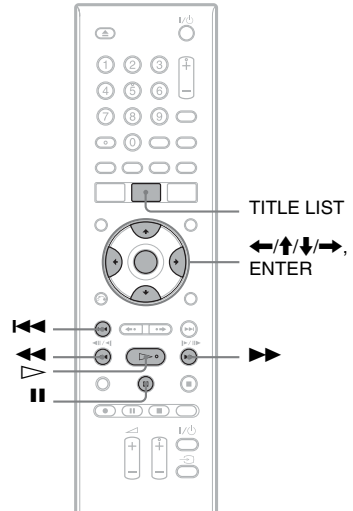

- 1 Press TITLE LIST.
Switch to the Playlist (page 61).
- 2 Press \rightarrow .
The sub-menu appears.
- 3 Select “Create,” and press ENTER.
The original titles in the Title List appear.
- 4 Select an original title to add to the Playlist, and press ENTER.
The selected title is added to the Playlist.
- 5 Repeat steps 3 and 4 to select all of the titles you want to add to the Playlist.

Moving a Playlist title (Move)

- 1 Press TITLE LIST.**
Switch to the Playlist (page 61).
- 2 Select a Playlist title, and press →.**
The sub-menu appears.
- 3 Select “Edit,” and press ENTER.**
- 4 Select “Move,” and press ENTER.**

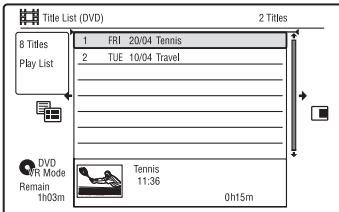

- 5 Select a new location for the title using ↑/↓, and press ENTER.**
The title moves to the new location.
 - To move more titles, repeat from step 2.

Combining multiple Playlist titles (Combine)

- 1 Press TITLE LIST.**
Switch to the Playlist (page 61).
- 2 Select a Playlist title, and press →.**
The sub-menu appears.
- 3 Select “Edit,” and press ENTER.**
- 4 Select “Combine,” and press ENTER.**

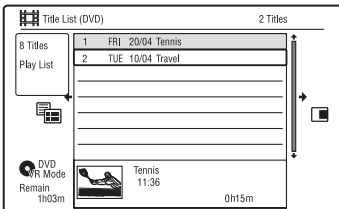

- 5 Select a title you want to combine, and press ENTER.**
- 6 Select “Yes,” and press ENTER.**
The titles are combined.

Dividing a Playlist title (Divide)

-RWVR -RVR

You can divide a Playlist title.

- 1 Press TITLE LIST.**
Switch to the Playlist (page 61).
- 2 Select a Playlist title, and press →.**
The sub-menu appears.
- 3 Select “Edit,” and press ENTER.**
- 4 Select “Divide,” and press ENTER.**
The display for setting the dividing point appears.
The title starts to play.

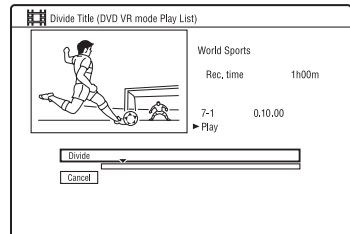

- 5 Select the dividing point using ◀◀/▶▶ or ▶, and press ■.**
 - To return to the beginning of the title, press ■ and then press ◀◀.
- 6 Press ENTER.**
The title is divided into two.

Moving a chapter (Move)

- 1 Press TITLE LIST.**
Switch to the Playlist (page 61).
- 2 Select a Playlist title containing the chapter you want to edit, and press →.**
The sub-menu appears.
- 3 Select “Edit,” and press ENTER.**
- 4 Select “Chapter Edit,” and press ENTER.**
- 5 Select “Erase/Move.”**

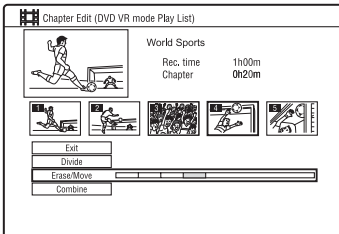

- 6 Select a chapter using ←/→, and press ENTER.**
- 7 Select “Move,” and press ENTER.**
- 8 Select a new location for the chapter using ←/→, and press ENTER.**
The chapter moves to the new location.

Playing Audio Tracks from CD/DVD

CD DATA DVD DATA CD

You can play audio tracks on CDs, DATA DVDs (DVD-ROMs/DVD+RWs/DVD+Rs/DVD-RWs/DVD-Rs/DVD-RAMs), or DATA CDs (CD-ROMs/CD-Rs/CD-RWs).

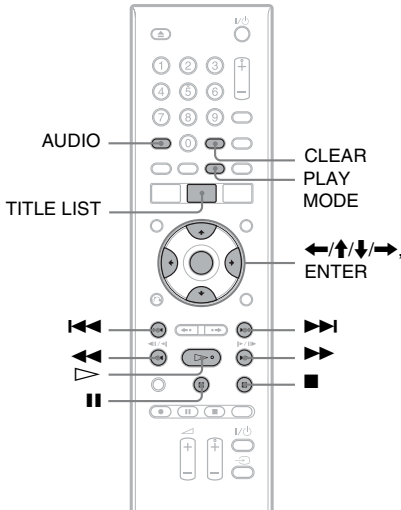

1 Insert a disc.

See “1. Inserting a Disc” on page 29.

2 Press .

Playback starts.

To stop playback

Press (stop).

Hint

You can play audio tracks using the Title List. Press TITLE LIST. Then select a track, and press ENTER.

Note

When any video titles are recorded on a DATA DVD, the MP3 audio tracks on that DATA DVD cannot be played.

To lock the recorder (Child Lock)

You can lock all of the buttons on the recorder so that the settings are not cancelled by mistake.

When the recorder is turned off, hold down on the recorder until “LOCKED” appears in the front panel display. The recorder does not work except for timer recordings and Synchro-Recording while the Child Lock is set.

To unlock the recorder, hold down on the recorder until “UNLOCKED” appears in the front panel display.

Playback options

CD DATA DVD DATA CD

Buttons	Operations
AUDIO	Selects stereo or monaural audio tracks recorded on the disc when pressed repeatedly in normal playback mode.
	Goes to the next or previous track when pressed during playback. For MP3 discs, goes to the next or previous album when pressed repeatedly.
	Fast reverses/fast forwards the disc when pressed during playback. Search speed changes as follows: fast reverse fast forward
	Pauses playback. To resume normal playback, press .

Notes on playing DTS sound tracks on a CD

- When playing DTS-encoded CDs, excessive noise will be heard from the LINE 3-TV/LINE 1/DECODER/LINE 2 OUT (R-AUDIO-L) jacks. To avoid possible damage to the audio system, the user should take proper precautions when the LINE 3-TV/LINE 1/DECODER/LINE 2 OUT (R-AUDIO-L) jacks of the recorder are connected to an amplification system. To enjoy DTS Digital Surround™ playback, an external DTS decoder must be connected to the DIGITAL OUT jack of the recorder.
- Set the sound to “Stereo” using the AUDIO button when you play DTS sound tracks on a CD (page 67).

Playing a specific portion repeatedly (A-B Repeat)

CD

1 Press PLAY MODE during playback.

The “Play Mode” menu appears.

2 Select “A-B Repeat,” and press ENTER.

“Set point A” is selected.

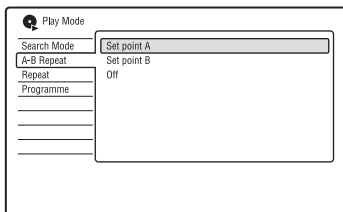

3 While monitoring the sound, press ENTER at the starting point (point A) of the portion to be played repeatedly.

“Set point B” is selected.

4 Continue playing to locate the ending point (point B), and press ENTER.

A-B Repeat starts.

To cancel A-B Repeat

Press CLEAR. Or, set “A-B Repeat” to “Off” in the “Play Mode” menu.

💡 Hint

You can select “A-B Repeat” from “Play Mode” in the System Menu.

🔊 Note

“A-B Repeat” is not available for MP3 audio tracks.

Playing repeatedly (Repeat)

CD DATA DVD DATA CD

You can play repeatedly all the tracks or a single track on an album or disc.

1 Press PLAY MODE during playback.

The “Play Mode” menu appears.

2 Select “Repeat,” and press ENTER.

3 Select an item to be repeated using ↑/↓.

“Repeat Disc”: repeats all of the tracks on a disc.

“Repeat Album” (except for CD): repeats the current album.

“Repeat Track”: repeats the current track.

“Repeat Programme”: repeats the current programme (page 69).

4 Press ENTER.

Repeat play starts.

To cancel Repeat play

Press CLEAR. Or, set “Repeat” to “Repeat Off” in the “Play Mode” menu.

💡 Hint

You can select “Repeat” from “Play Mode” in the System Menu.

🔊 Note

You can select “Repeat Programme” only during Programme play.

Creating your own programme (Programme)

CD DATA DVD DATA CD

You can play the contents of an album or disc in the order you want by arranging the order of the albums/tracks on a disc to create your own programme. You can make a programme of up to 24 steps.

1 Press PLAY MODE during playback.

The “Play Mode” menu appears.

2 Select “Programme,” and press ENTER.

3 Select “Input/Edit Programme,” and press ENTER.

The “Input/Edit Programme” display differs depending upon the disc type. Example: DATA DVD

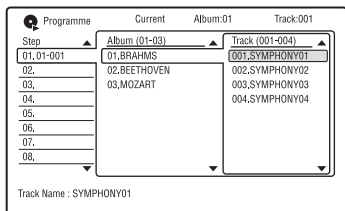

4 Select an album (example: 01.BRAHMS) using ↑/↓, and press →.

5 Select a track (example: 001.SYMPHONY01) using ↑/↓, and press ENTER.

The track is programmed.

If you make a mistake, select the step number (example: 01-001) using ←/↑/↓, and press CLEAR.

6 To programme other tracks, press ←/↑/↓/→ to select a step number, and repeat steps 4 and 5.

7 Press ▷.

Programme play starts.

To cancel Programme play

Press CLEAR during playback. Or, set “Programme” to “Cancel Programme Play” in the “Play Mode” menu.

To erase the programme

Press CLEAR in stop mode. Or, set “Programme” to “Erase Programme List” in the “Play Mode” menu.

🔧 Hints

- The programme you made remains after Programme play finishes. To play the same programme again, set “Programme” to “Start Programme Play” in the “Play Mode” menu. However, the programme is cleared after you remove the disc or press I/⏻.
- You can repeat Programme play. Set “Repeat” to “Repeat Programme” in the “Play Mode” menu (page 68).
- You can select “Programme” from “Play Mode” in the System Menu.

Searching for an Audio Track

CD DATA DVD DATA CD

You can search a disc by album or track. As albums and tracks are assigned individual numbers, select the album or track by entering its number.

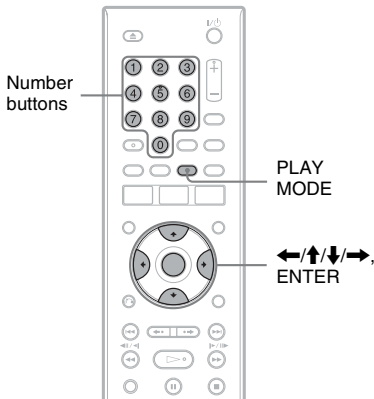

4 Press the number buttons to select the number of the album or track you want.

If you make a mistake, select another number.

5 Press ENTER.

The recorder starts playback from the selected number.

Hint

You can select an album or track using in step 4.

1 Press PLAY MODE during playback.

The “Play Mode” menu appears.

2 Select “Search Mode,” and press ENTER.

3 Select a search method, and press ENTER.

“Album Search” (except for CD)

“Track Search”

The display for entering the number appears.

Example: Album Search

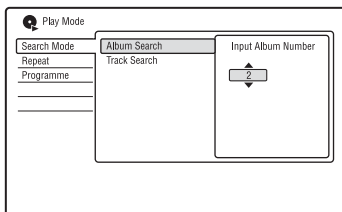

Using the "Photo Album" List

You can play JPEG image files on DATA DVDs/DATA CDs using the "Photo Album" list.

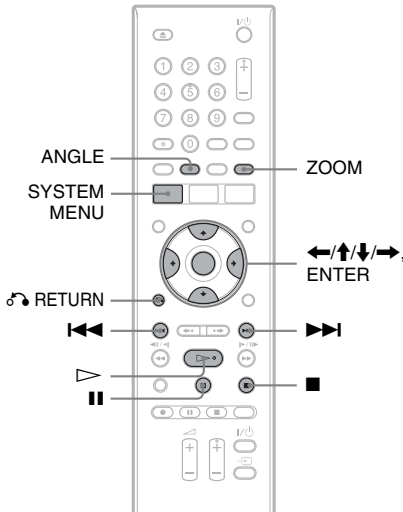

- 1 Press SYSTEM MENU.**
The System Menu appears.
- 2 Select "Photo Album," and press ENTER.**
The "Photo Album" list appears.
- 3 Select an album using \uparrow/\downarrow , and press ENTER.**
To show the 4-Photo List or 1-Photo List, press \leftarrow to select "Title View," and press ENTER, then select "4 Photos" or "1 Photo" using \uparrow/\downarrow , and press ENTER.

12-Photo List (Example: DVD)

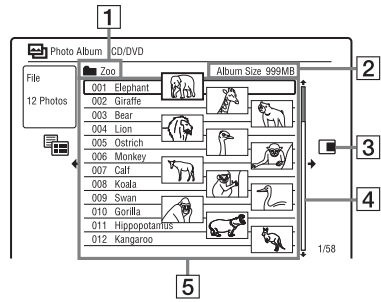

4-Photo List

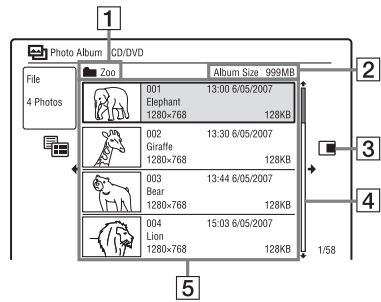

1-Photo List

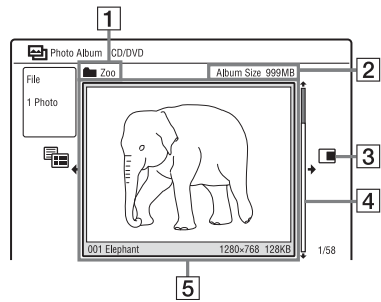

- 1** Album name
- 2** Album size

3 Sub-menu:

Press **→** to display the sub-menu.

The sub-menu displays options applicable only to the selected item. The displayed options differ depending upon the model, situation, and disc type.

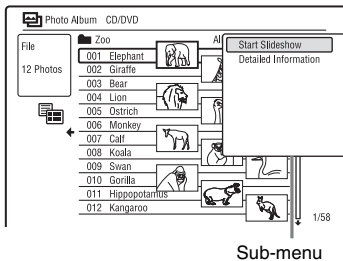

4 Scroll bar:

Appears when all of the JPEG image files do not fit on the list. To view the hidden JPEG image files, press **↑/↓**.

5 Album and JPEG image file information:

Displays the image, JPEG image file number, recording date and time, JPEG image file name, and JPEG image file size.

To scroll the list display by page (Page mode)

Press **◀/▶** while the "Photo Album" list is displayed. Each time you press **◀/▶**, the entire "Photo Album" list changes to the next/previous page of albums/JPEG image files.

To switch between the album list and JPEG image file list

- 1 Press **←** while the "Photo Album" list is displayed.
- 2 Select "Display Mode" using **↑/↓**, and press ENTER.
- 3 Select "File" or "Album" using **↑/↓**, and press ENTER.

To turn off the "Photo Album" list

Press SYSTEM MENU.

To reload the files or folders

When a disc contains 1,000 or more files and/or 100 or more folders, select "Read next" in the "Photo Album" list, and press ENTER to view unloaded files or folders. It may take a few minutes to load files or folders.

Note

The thumbnail for a file that cannot be playable on the recorder is displayed as "△."

Viewing a JPEG image file

1 Follow steps 1 to 3 of "Using the "Photo Album" List."

The "Photo Album" list appears. Switch to the album list, if necessary.

2 Select a JPEG image file using **↑/↓**, and press ENTER.

The selected JPEG image file is displayed on the entire screen.

To display the detailed information

- 1 Select a JPEG image file, and press **→**.
- 2 Select "Detailed Information," and press ENTER. The detailed information for the selected JPEG image file appears.

Playing a slideshow

1 Follow steps 1 to 3 of "Using the "Photo Album" List."

The "Photo Album" list appears. Switch between the album list and JPEG image file list, if necessary.

2 Select an album or JPEG image file using **↑/↓**, and press **▷**.

The slideshow starts.

If you press **▷** while selecting a JPEG image file, the slideshow starts from the selected JPEG image file.

To stop a slideshow

Press **■** (stop) or **↶** RETURN.

To pause a slideshow

Press **II** (pause).

To view the next/previous image during a slideshow

Press **I◀◀/▶▶I**.

To zoom an image

Press **ZOOM** repeatedly during a slideshow. Each time you press **ZOOM**, the magnification changes as shown below.

2× → 4× → normal magnification

You can move the area you want to zoom using **←/↑/↓/→**.

To rotate an image

Press **ANGLE** repeatedly during a slideshow.

Each time you press **ANGLE**, the image turns clockwise by 90°.

💡 Hint

You can start a slideshow by selecting “Start Slideshow” from the sub-menu.

Disc Settings (Disc Setup)

The “Disc Setup” setup allows you to adjust DVD related settings.

Press DISC SETUP.

The “Disc Setup” setup appears with the following options. The default settings are underlined.

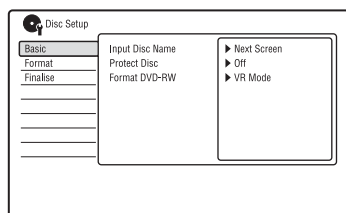

Hint

You can also display the Disc Setup display by selecting “Disc Setup” from the System Menu.

Basic

◆ Input Disc Name

You can label a disc.

For details, see page 36.

◆ Protect Disc

You can protect a disc against erasure.

For details, see page 36.

◆ Format DVD-RW (DVD-RW only)

The recorder automatically starts formatting in VR mode or Video mode, whichever is selected below, when a new, unformatted DVD-RW is inserted.

<u>VR Mode</u>	Automatically formats the disc in VR mode.
Video Mode	Automatically formats the disc in Video mode.

Format

You can manually re-format a DVD+RW, DVD-RW, or DVD-R disc to make a blank disc.

For details, see page 40.

Finalise

Finalises a disc to play it on other DVD equipment.

For details, see page 37.

Recorder Settings (Basic)

The “Basic” setup helps you to make clock and other recorder related settings.

- 1 Press **SYSTEM MENU** while the recorder is in stop mode.
 - 2 Select “Initial Setup,” and press **ENTER**.
 - 3 Select “Basic,” and press **ENTER**.
The “Basic” setup appears with the following options. The default settings are underlined.
- To turn off the display, press **SYSTEM MENU**.

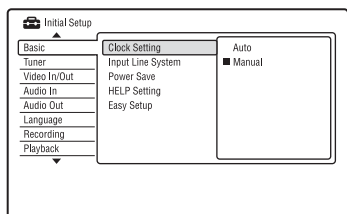

Clock Setting

◆ Auto (Auto Clock Set)

Turns on the Auto Clock Set function when a programme position in your local area broadcasts a time signal.

- 1 Select “Clock Setting” in “Basic,” and press **ENTER**.
- 2 Select “Auto,” and press **ENTER**.

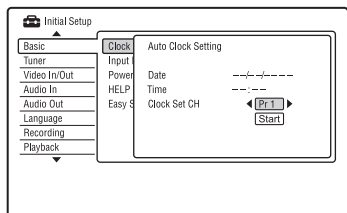

- 3 Press **←/→** repeatedly until the programme position of the station that carries a time signal appears.

- 4 Press **↓** to select “Start,” and press **ENTER**.
 - If the recorder does not receive a time signal from any station, press **↶ RETURN** and set the clock manually.
 - If the Auto Clock Set function did not set the clock correctly for your local area, try another station for the Auto Clock Set function or set the clock manually.

🔔 Note

The Auto Clock Set function does not work while the recorder is standing by for Synchro-Recording.

◆ Manual (Manual Clock Set)

Set the clock manually.

- 1 Select “Clock Setting” in “Basic,” and press **ENTER**.
- 2 Select “Manual,” and press **ENTER**.

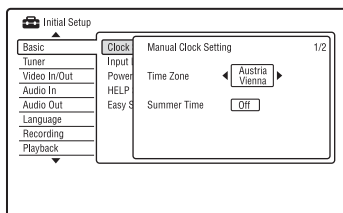

- 3 Press **←/→** to select the time zone for your area, and press **↓**.
- 4 Select “On” using **←/→** if you are now on summer time, and press **ENTER**.

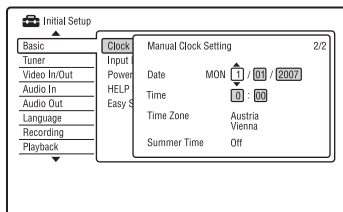

- 5** Press \uparrow/\downarrow to set the day, and press \rightarrow . Set the month, year, hour, and minutes in sequence. Press \leftarrow/\rightarrow to select the item to be set, then press \uparrow/\downarrow to set the numbers. The day of the week is set automatically.

To change the numbers, press \leftarrow to return to the item to be changed, and press \uparrow/\downarrow .

- 6** Press ENTER to start the clock.

Input Line System

Selects the colour system when recording from the connected equipment.

NTSC	Records in NTSC or PAL-60 colour system.
<u>PAL/</u> <u>SECAM</u>	Records in PAL or SECAM colour system.

Note

When picture noise appears after you change the "Input Line System" setting, change the "Input Colour System" setting (page 79). If picture noise still appears, hold down \blacksquare (stop) on the recorder, and press INPUT on the recorder.

Power Save

Selects whether this recorder is in power save mode when the power is turned off (standby).

Mode 1	Only antenna input signals are output to the connected TV when the recorder is in standby.
Mode 2	No input signals are output when the recorder is in standby.
<u>Off</u>	Does not set to power save mode. Normally, select this setting.

Note

Power Save mode does not function in the following cases, even when "Power Save" is set to "Mode 1" or "Mode 2."

- Synchro-Recording is set.
- There is a timer setting with "VPS/PDC" set to "On" in the Timer List.
- The SMARTLINK features are not available when "Power Save" is set to "Mode 1" or "Mode 2."

HELP Setting

<u>On</u>	Displays Help information for GUI displays.
Off	Does not set to HELP setting mode.

Easy Setup (Resetting the Recorder)

Select this to run the "Easy Setup" programme.

- 1** Select "Easy Setup" in "Basic," and press ENTER.
- 2** Select "Start," and press ENTER.
- 3** Follow the instructions for "Easy Setup" (page 20) from step 2.

Aerial Reception Settings (Tuner)

The “Tuner” setup helps you to make tuner and programme position settings for the recorder.

- 1 Press **SYSTEM MENU** while the recorder is in stop mode.
- 2 Select “Initial Setup,” and press **ENTER**.
- 3 Select “Tuner,” and press **ENTER**.

The “Tuner” setup appears with the following options. The default settings are underlined.

To turn off the display, press **SYSTEM MENU**.

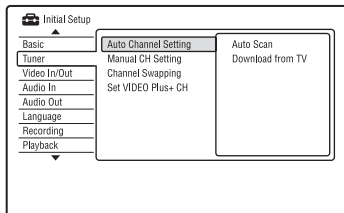

Auto Channel Setting

Auto Scan

If you connect a TV to this recorder not using SMARTLINK, you can preset programme positions automatically using “Auto Scan.”

- 1 Select “Auto Channel Setting” in “Tuner,” and press **ENTER**.
- 2 Select “Auto Scan,” and press **ENTER**.
- 3 Select your country/region using **←/→**, and press **ENTER**.

The programme position order will be set according to the country/region you set. If any programme positions are unused or contain unwanted channels, you can disable them (page 78).

Download from TV

If you connect a TV to this recorder with SMARTLINK, you can preset programme positions by downloading from your TV. For details, refer to the operating instructions supplied with your TV.

- 1 Select “Download from TV,” and press **ENTER**.
- 2 Select your country/region using **←/→**, and press **ENTER**.
The tuner preset data will be downloaded from your TV to this recorder. If any programme positions are unused or contain unwanted channels, you can disable them (page 78).

Manual CH Setting

Presets programme positions manually.

If some programme positions could not be set using the “Easy Setup” function, you can set them manually.

If there is no sound or if the picture is distorted, the wrong tuner system may have been preset during “Easy Setup.” Set the correct tuner system manually in the steps below.

- 1 Select “Manual CH Setting” in “Tuner,” and press **ENTER**.
- 2 Select “Next Screen,” and press **ENTER**.
- 3 Select your country/region using **←/→**, and press **ENTER**.

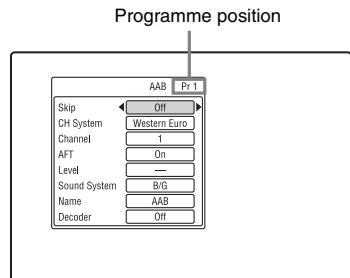

- 4 Press **◀/▶** to select the programme position.
- 5 Select the item you want to change using **↑/↓**, and change the settings using **←/→**, then press **ENTER**.
 - To preset another programme position, repeat from step 4.

Skip

On	Select this when the programme position is unused or contains unwanted channels. The selected position will be skipped when you press PROG +/-.
Off	Does not skip the selected programme position.

CH System

Select the region to get the best broadcast reception.

FR	Select this when in France.
Western Euro	Select this when in West European countries.
UK & IE	Select this when in Great Britain/Ireland.
Eastern Euro	Select this when in East European countries.

AFT

On	Turns on the Auto Fine Tuning function. Normally select this position.
Off	Allows you to adjust the picture manually.

- If the Auto Fine Tuning function does not work effectively, select "Off" and press ↓. Press ←/→ to obtain a clearer picture, and press ENTER.

Sound System

Select an available TV system (page 78).

B/G	Select this when in West European countries, except those listed in "Receivable channels" on page 78.
D/K	Select this when in East European countries.
I	Select this when in Great Britain/Ireland.
L	Select this when in France.

Name

Changes or enters a new station name (up to 5 characters). The recorder must receive programme position information (e.g., SMARTLINK information) for station names to appear automatically.

Press →, then press ←/→ repeatedly to select a character.

To change the characters, press ↑/↓ to move the cursor, and press ←/→.

Decoder

Sets the external decoder (PAY-TV/Canal Plus analogue decoder) channels.

For details, see page 27.

Channel

Press ←/→ repeatedly until the programme position you want is displayed.

- To select a cable or satellite programme position, press ←/→ until the programme position you want is displayed.

◆ Receivable channels

TV system	Channel coverage
BG (West European Countries, except those listed below)	E2 – E12 VHF
	Italia A – H VHF
	E21 – E69 UHF
	S1 – S20 CATV
	S21 – S41 HYPHER
S01 – S05 CATV	
DK (East European Countries)	R1 – R12 VHF
	R21 – R69 UHF
	S1 – S20 CATV
	S21 – S41 HYPHER
	S01 – S05 CATV
I (Great Britain/Ireland)	Ireland A – J VHF
	South Africa 4 – 11, 13 VHF
	B21 – B69 UHF
	S1 – S20 CATV
	S21 – S41 HYPHER
S01 – S05 CATV	

TV system	Channel coverage
L* (France)	F2 – F10 VHF
	F21 – F69 UHF
	B – Q CATV
	S21 – S41 HYPER

* To receive broadcasts in France, select “L.”

Channel Swapping

After the programme positions have been set, you can change the order of each programme position in the display list.

- 1 Select “Channel Swapping” in “Tuner,” and press ENTER.
- 2 Select “Next Screen,” and press ENTER.

[1] 1/17				[2] 1/17			
Pr	System	CH	Name	Pr	System	CH	Name
1	B/G	2		1	B/G	2	
2	B/G	3		2	B/G	3	
3	B/G	4		3	B/G	4	
4	B/G	5		4	B/G	5	
5	B/G	6		5	B/G	6	
6	B/G	7		6	B/G	7	

Swap Preset

- 3 Press **↑/↓** to select the programme position number you want to swap, and press **→**.
 - To display other pages, press **◀◀/▶▶** repeatedly.
- 4 Press **↑/↓** to select the programme position number to swap for the one selected in step 3, and press ENTER. The programme position numbers are swapped.
 - To swap the programme position number of another station, repeat from step 3.

Set VIDEO Plus+ CH

Sets the guide channel number assigned to each channel.

You need to set this correctly to make timer recordings with the VIDEO Plus+ function. For details, see page 21.

Video Settings (Video In/Out)

The “Video In/Out” settings will adjust items related to the image, such as size and colour. Select the settings according to the type of TV, tuner, or decoder connected to the DVD recorder.

- 1 Press **SYSTEM MENU** while the recorder is in stop mode.
- 2 Select “Initial Setup,” and press **ENTER**.
- 3 Select “Video In/Out,” and press **ENTER**.

The “Video In/Out” setup appears with the following options. The default settings are underlined.

Initial Setup	
Basic	Input Colour System
Tuner	Component Video Out
<u>Video In/Out</u>	LINE 3 Out
Audio In	LINE 1 In
Audio Out	NTSC on PAL TV
Language	
Recording	
Playback	

Next Screen

Input Colour System

Selects the colour system when picture noise appears after you change the “Input Line System” setting (page 76).

<u>Auto</u>	Recorder automatically detects signals of colour systems and selects the appropriate colour system.
PAL	Selects the PAL colour system when “Input Line System” is set to “PAL/SECAM.”
SECAM	Selects the SECAM colour system when “Input Line System” is set to “PAL/SECAM.”

Hint

When “Input Line System” is set to “NTSC,” you can select “Auto,” “3.58NTSC,” or “PAL-60.”

Component Video Out

Selects the signal format in which the recorder outputs video signals: interlace or progressive, from the COMPONENT VIDEO OUT jacks.

<u>Normal(Inter-lace)</u>	Outputs signals in the interlace format.
Progressive	Outputs signals in the progressive format. Select this when you want to view progressive signals.

🔊 Notes

- When you set “LINE 3 Out” to “RGB,” you cannot set “Component Video Out.”
- When you connect the recorder to a monitor or projector via only the COMPONENT VIDEO OUT jacks, do not set “LINE 3 Out” to “RGB.” If you set “LINE 3 Out” to “RGB,” in this case, the picture may not appear.
- When picture noise appears after you set the recorder to progressive format, hold down ■ (stop) on the recorder, and press ▲ (open/close) on the recorder.
- No video signals are output when using the HDMI connection.

LINE 3 Out

Selects a method of outputting video signals for the LINE 3 – TV jack.

<u>Video</u>	Outputs video signals.
S-Video	Outputs S-video signals.
RGB	Outputs RGB signals.

🔊 Notes

- If your TV does not accept S-video or RGB signals, the image will not be displayed in the selected method on the TV screen even if you select “S-Video” or “RGB.” See the instructions supplied with your TV.
- SMARTLINK is available only when “Video” is selected.
- RGB signals are not output when using the HDMI connection.

LINE 1 In

Selects a method of inputting video signals for the LINE 1/DECODER jack. The picture will not be clear if this setting does not match the type of video input signal.

<u>Video</u>	Inputs video signals.
S-Video	Inputs S-video signals.
RGB	Inputs RGB signals.
Decoder	Select this when connecting to an external decoder (PAY-TV/Canal Plus analogue decoder). If you connect to a cable box/satellite receiver such as CanalSat, do not select this option.

NTSC on PAL TV

Sets the recorder to convert signals of the NTSC colour system to the PAL colour system to play NTSC discs on PAL-only TVs. Refer to the operating instructions supplied with your TV.

<u>On</u>	Plays NTSC discs on PAL-only TVs.
Off	Select this if the connected TV is a multi-system (NTSC-compatible) TV.

Audio Input Settings (Audio In)

The “Audio In” setup allows you to adjust the sound according to the playback and connection conditions.

- 1 Press **SYSTEM MENU** while the recorder is in stop mode.
- 2 Select “Initial Setup,” and press **ENTER**.
- 3 Select “Audio In,” and press **ENTER**.
The “Audio In” setup appears with the following options. The default settings are underlined.

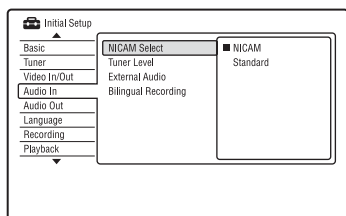

NICAM Select (page 42)

<u>NICAM</u>	Normally select this position.
Standard	Select this if the sound from NICAM broadcasts is not clear.

Tuner Level

If the playback sound is distorted, set this item to “Compression.” The recorder reduces the audio output level.

This function affects the output of the following jacks:

- LINE 2 OUT R-AUDIO-L jacks
- LINE 3 – TV jack
- LINE 1/DECODER jack

<u>Normal</u>	Normally select this position.
Compression	Select this when the playback sound from the speakers is distorted.

External Audio

<u>Stereo</u>	Select this when receiving stereo programmes from connected equipment.
Bilingual	Select this when receiving bilingual programmes from connected equipment.

Bilingual Recording

Selects the sound to be recorded.

<u>A/L</u>	Records the main sound for the bilingual programme.
B/R	Records the sub sound for the bilingual programme.

Note

When recording a bilingual audio signal to a DVD-RW/DVD-R in VR mode (except in PCM mode), both audio channels are recorded and you can select the sound when playing.

Audio Output Settings (Audio Out)

The “Audio Out” setup allows you to switch the method of outputting audio signals when you connect a component such as an amplifier (receiver) with a digital input jack. If you connect a component that does not accept the selected audio signal, a loud noise (or no sound) will come from the speakers, and may affect your ears or cause speaker damage.

- 1** Press **SYSTEM MENU** while the recorder is in stop mode.
- 2** Select “Initial Setup,” and press **ENTER**.
- 3** Select “Audio Out,” and press **ENTER**.
The “Audio Out” setup appears with the following options. The default settings are underlined.

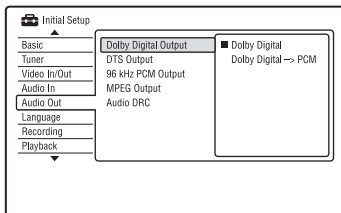

Dolby Digital Output (DVDs only)

Selects the type of Dolby Digital signal.

<u>Dolby Digital</u>	Select this when the recorder is connected to an audio component with a built-in Dolby Digital decoder.
Dolby Digital -> PCM	Select this when the recorder is connected to an audio component lacking a built-in Dolby Digital decoder.

Note

If the HDMI OUT jack is connected to equipment not compatible with Dolby Digital signals, the PCM signals will be automatically output even when you select “Dolby Digital.”

DTS Output (DVD VIDEOS only)

Selects whether or not to output DTS signals.

<u>On</u>	Select this when the recorder is connected to an audio component with a built-in DTS decoder.
Off	Select this when the recorder is connected to an audio component without a built-in DTS decoder.

Note

When HDMI output is performed to equipment not compatible with DTS signals, the signals will not be output regardless of the “DTS Output” setting.

96 kHz PCM Output (DVD VIDEOS only)

Selects the sampling frequency of the audio signal.

<u>96 kHz -> 48 kHz</u>	The audio signals of DVD VIDEOS are converted to 48 kHz and output.
96 kHz	All signals containing 96 kHz are output without conversion. However, the signals are output at 48 kHz if copyright-protected signals are contained.

Notes

- “96 kHz PCM Output” setting has no effect when audio signals are output from the LINE 2 OUT (R-AUDIO-L) jacks or LINE 3 – TV/LINE 1/DECODER jack. If the sampling frequency is 96 kHz, signals are simply converted to analogue signals and output.
- If the HDMI OUT jack is connected to equipment not compatible with 96 kHz signals, 48 kHz PCM will be automatically output even when you select “96 kHz.”

MPEG Output (DVD VIDEOS only)

Selects the type of MPEG audio signal.

MPEG	Select this when the recorder is connected to an audio component with a built-in MPEG decoder.
<u>MPEG -> PCM</u>	Select this when the recorder is connected to an audio component without a built-in MPEG decoder. If you play MPEG audio sound tracks, the recorder outputs stereo signals via the DIGITAL OUT (COAXIAL) jack.

Note

If the HDMI OUT jack is connected to equipment not compatible with MPEG audio signals, the PCM signals will be automatically output even when you select "MPEG."

Audio DRC (Dynamic Range Control) (DVDs only)

Selects the dynamic range (difference between soft and loud sounds) setting when playing a DVD that conforms to "Audio DRC." This affects the output from the following jacks:

- LINE 2 OUT R-AUDIO-L jacks
- LINE 3 - TV jack
- LINE 1/DECODER jack
- DIGITAL OUT (COAXIAL)/HDMI OUT jack only when "Dolby Digital Output" is set to "Dolby Digital -> PCM" (page 82).

On	Makes low sounds clear even if you turn the volume down.
<u>Off</u>	Normally select this position.

Language Settings (Language)

The "Language" setup allows you to adjust language settings.

- 1 Press SYSTEM MENU while the recorder is in stop mode.**
- 2 Select "Initial Setup," and press ENTER.**
- 3 Select "Language," and press ENTER.**

The "Language" setup appears with the following options. The default settings are underlined.

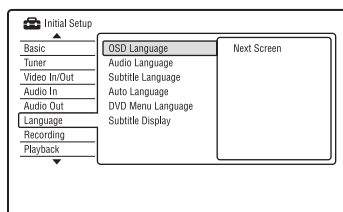

OSD Language

Switches the display language on the screen.

Audio Language (DVD VIDEO only)

Switches the language of the sound track.

Subtitle Language (DVD VIDEO only)

Switches the language of the subtitles recorded on the disc.

Auto Language

The “Auto Language” function is available when “Audio Language” and “Subtitle Language” are set to the same language, and “Subtitle Display” is set to “On.”

<u>On</u>	For DVD VIDEOS whose main audio track is the language you set in “Audio Language” and “Subtitle Language,” the recorder plays the main audio track without subtitles. For DVD VIDEOS whose main audio track is not the language you set in “Audio Language” and “Subtitle Language,” the recorder plays the main audio track with subtitles in the language you set.
Off	Turns off the function.

DVD Menu Language (DVD VIDEO only)

Switches the language for the DVD menu. Select “w/Subtitle Language” to set the same language as the language you set in “Subtitle Language.”

Subtitle Display

<u>On</u>	Displays subtitles.
Off	Does not display subtitles.
Assist Subtitle	Displays special assistive subtitles, where available.

Hint

If you select “Others” in “Audio Language,” “Subtitle Language,” or “DVD Menu Language,” press **↓**, and enter a language code from “Language Code List” on page 106.

Note

If you select a language in “DVD Menu Language,” “Subtitle Language,” or “Audio Language” that is not recorded on the DVD VIDEO, one of the recorded languages will be automatically selected.

Recording Settings (Recording)

The “Recording” setup allows you to adjust recording settings.

- 1 Press **SYSTEM MENU** while the recorder is in stop mode.
- 2 Select “Initial Setup,” and press **ENTER**.
- 3 Select “Recording,” and press **ENTER**.

The “Recording” setup appears with the following options. The default settings are underlined.

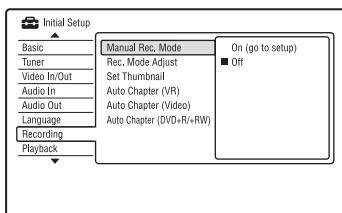

Manual Rec. Mode

<u>On (go to setup)</u>	Allows you to select all recording modes. Select this, and press ENTER . Then, select a recording mode using ←/→ , and press ENTER .
Off	Allows you to select standard recording modes only.

◆ Manual recording mode

The table below shows the approximate recording times for the different DVD types in each manual recording mode, as well as the standard recording mode equivalents.

The recording time for DVDs

Recording mode	Approx. recording time (hours)	
	DVD+RW/ DVD-RW/ DVD+R/ DVD-R	DVD+R DL/ DVD-R DL
PCM ^{*1}	1 hr. 1 min.	1 hr. 51 min.
MN32 (HQ)	1 hr. 1 min.	1 hr. 51 min.
MN31	1 hr. 5 min.	1 hr. 57 min.
MN30	1 hr. 10 min.	2 hr. 6 min.
MN29	1 hr. 15 min.	2 hr. 15 min.
MN28	1 hr. 20 min.	2 hr. 24 min.
MN27	1 hr. 25 min.	2 hr. 33 min.
MN26 (HSP)	1 hr. 30 min.	2 hr. 41 min.
MN25	1 hr. 35 min.	2 hr. 50 min.
MN24	1 hr. 40 min.	2 hr. 59 min.
MN23	1 hr. 45 min.	3 hr. 8 min.
MN22	1 hr. 50 min.	3 hr. 17 min.
MN21 (SP)	2	3 hr. 35 min.
MN20	2 hr. 10 min.	3 hr. 53 min.
MN19	2 hr. 20 min.	4 hr. 11 min.
MN18 (LSP)	2 hr. 30 min.	4 hr. 29 min.
MN17	2 hr. 40 min.	4 hr. 47 min.
MN16	2 hr. 50 min.	5 hr. 5 min.
MN15 (ESP)	3	5 hr. 23 min.
MN14	3 hr. 10 min.	5 hr. 41 min.
MN13	3 hr. 20 min.	5 hr. 59 min.
MN12	3 hr. 30 min.	6 hr. 17 min.
MN11	3 hr. 40 min.	6 hr. 35 min.
MN10	3 hr. 50 min.	6 hr. 53 min.
MN9 (LP)	4	7 hr. 11 min.
MN8	4 hr. 30 min.	8 hr. 4 min.
MN7	5	8 hr. 58 min.
MN6 (EP)	6	10 hr. 46 min.
MN5	7	12 hr. 34 min.

Recording mode	Approx. recording time (hours)	
	DVD+RW/ DVD-RW/ DVD+R/ DVD-R	DVD+R DL/ DVD-R DL
MN4 (SLP)	8	14 hr. 21 min.
MN3 ^{*2} (SEP ^{*2})	10	17 hr. 57 min.
MN2 ^{*2}	12	21 hr. 32 min.
MN1 ^{*2}	13 hr. 22 min.	24

^{*1} Audio signals are recorded in 48kHz PCM format, and video signals are recorded in HQ mode. When recording a bilingual programme, select the sound to be recorded (page 81).

^{*2} SEP, MN1, MN2, or MN3 mode is not available for DVD+RWs/DVD+Rs/DVD+R DLs. When recording to DVD+RWs/DVD+Rs, the recording mode automatically switches to SLP mode even if you set to SEP, MN1, MN2, or MN3 mode.

💡 Hint

Audio signals are recorded in Dolby Digital 2 ch format (except for PCM mode).

◆ Resolution

The first figure refers to when “Input Line System” is set to “NTSC”; the second when set to “PAL/SECAM” in the “Basic” setup (page 76).

For DVD-RW (VR mode)/DVD-R (VR mode)

PCM, MN32 to MN16: 720 × 480 / 720 × 576
 MN15 to MN12: 544 × 480 / 544 × 576
 MN11 to MN9: 480 × 480 / 544 × 576
 MN8 and MN7: 352 × 480 / 352 × 576
 MN6 to MN1: 352 × 240 / 352 × 288

For DVD+RW/DVD-RW (Video mode)/ DVD+R/DVD-R (Video mode)

PCM, MN32 to MN9: 720 × 480 / 720 × 576
 MN8 and MN7: 352 × 480 / 352 × 576
 MN6 to MN1: 352 × 240 / 352 × 288

Rec. Mode Adjust

On	Automatically adjusts the recording mode to enable the entire programme to be recorded (page 44).
<u>Off</u>	Turns off the function.

Set Thumbnail

Selects a scene for the thumbnail picture shown in the Title List.

<u>0 seconds</u>	The first frame of the title is set for the thumbnail picture.
30 seconds	The frame at 30 seconds from the first frame is set for the thumbnail picture.
3 minutes	The frame at 3 minutes from the first frame is set for the thumbnail picture.

Auto Chapter (VR) (DVD-RW/DVD-R in VR mode only)

<u>On</u>	The recorder detects changes in the picture and sound and automatically inserts chapter marks.
Off	No chapter mark is inserted.

Note

The actual chapter mark interval may vary depending on the amount of information contained in the video to be recorded.

Auto Chapter (Video) (DVD-RW/DVD-R in Video mode only)

No Separation	No chapter mark is inserted.
<u>10 minutes</u>	Inserts chapter marks at approximately 10-minute intervals.
15 minutes	Inserts chapter marks at approximately 15-minute intervals.

Auto Chapter (DVD+R/+RW) (DVD+RW/DVD+R only)

No Separation	No chapter mark is inserted.
<u>10 minutes</u>	Inserts chapter marks at approximately 10-minute intervals.
15 minutes	Inserts chapter marks at approximately 15-minute intervals.

Playback Settings (Playback)

The "Playback" setup allows you to adjust the playback settings.

- 1 Press **SYSTEM MENU** while the recorder is in stop mode.
- 2 Select "Initial Setup," and press **ENTER**.
- 3 Select "Playback," and press **ENTER**.

The "Playback" setup appears with the following options. The default settings are underlined.

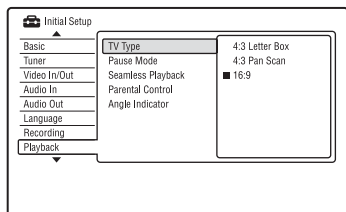

TV Type

Select the playback picture size according to the type of connected TV (wide-screen/wide mode TV or conventional 4:3 screen TV).

<u>4:3 Letter Box</u>	Select this when connecting to a 4:3 screen TV. Displays a wide picture with bands on the upper and lower portions of the screen.
<u>4:3 Pan Scan</u>	Select this when connecting to a 4:3 screen TV. Automatically displays a wide picture on the entire screen and cuts off the portions that do not fit.
<u>16:9</u>	Select this when connecting to a wide-screen TV or TV with a wide mode function.

4:3 Letter Box



4:3 Pan Scan

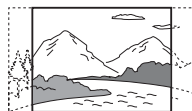

16:9



Note

Depending on the disc, "4:3 Letter Box" may be selected automatically instead of "4:3 Pan Scan" or vice-versa.

Pause Mode

Selects the picture quality in pause mode.

<u>Field</u>	Outputs a stable, generally shake-free image.
<u>Frame</u>	Outputs a sharp image, but may be prone to shake.
<u>Auto</u>	Outputs a generally less sharp but more stable still image.

Seamless Playback (DVD-RW/DVD-R in VR mode only)

<u>On</u>	Playback is smooth, but with a trade-off against the accuracy of the edit points.
<u>Off</u>	You may notice momentary interruption at edited points during playback of a VR mode Playlist.

Parental Control (DVD VIDEO only)

Playback of some DVD VIDEOS can be limited according to a predetermined level, such as the age of the users. Scenes may be blocked or replaced with different scenes.

- 1 Select "Parental Control" in "Playback," and press ENTER.

When you have already registered a password, go to step 4.

- 2 Select "Set Password," and press ENTER.

The display for registering a new password appears.

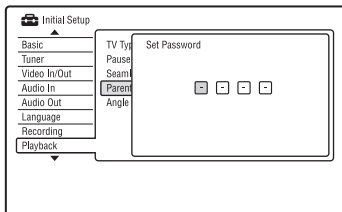

- 3 Enter your four-digit password using the number buttons, and press ENTER.

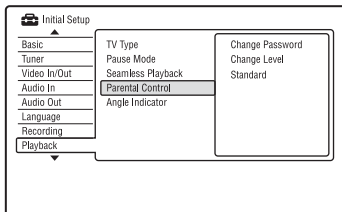

- 4 Select "Standard," and press ENTER. The "Parental Control : Standard" display appears.

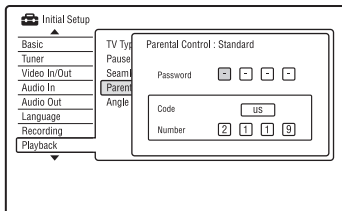

- 5 Enter your four-digit password using the number buttons, and press ENTER.

- 6 Select "Code" (geographic area) as the playback limitation level, and press ENTER.

The area is selected.

- When you select "Number," press the number buttons to select and enter a country/area code in the table (page 107), and press ENTER.

- 7 Select "Change Level," and press ENTER.

The "Parental Control : Change Level" display appears.

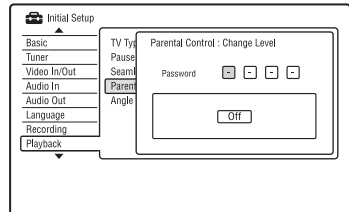

- 8 Enter your four-digit password using the number buttons, and press ENTER.

- 9 Select the level.

The lower the value, the stricter the limitation.

Discs rated higher than the selected level will be restricted.

- 10 Press ENTER.

The Parental Control setting is complete. To cancel the Parental Control setting for the disc, select "Off" in step 9.

◆ Change Password

- 1 Select "Parental Control" in "Playback," and press ENTER.

- 2 Select "Change Password," and press ENTER.



- 3 Enter your four-digit password in the "Current Password" row using the number buttons, and press ENTER.

- 4 Enter a new password in the "New Password" row using the number buttons, and press ENTER.

Notes

- If you forget your password, reset the recorder (page 99).
- When you play discs which do not have the Parental Control function, playback cannot be limited on this recorder.
- Depending on the disc, you may be asked to change the Parental Control level while playing the disc. In this case, enter your password, then change the level.

Angle Indicator (DVD VIDEOS only)

On	Displays “  ” on the TV screen if various angles (multi-angles) for a scene are recorded on the disc.
Off	Does not display “  ” on the TV screen.

HDMI Settings (HDMI Output)

The “HDMI Output” setup allows you to adjust items related to the HDMI connection. You can select “HDMI Output” only when connecting equipment to the HDMI OUT jack.

- 1** Press **SYSTEM MENU** while the recorder is in stop mode.
- 2** Select “Initial Setup,” and press **ENTER**.
- 3** Select “HDMI Output,” and press **ENTER**.

The “HDMI Output” setup appears with the following options. The default settings are underlined.

After connecting equipment to the HDMI OUT jack, “Screen Resolution,” “4:3 Video Output,” and “Colour” are automatically set to the appropriate settings.

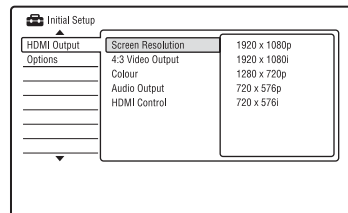

Screen Resolution

Selects the type of video signals output from the HDMI OUT jack. If the picture is not clear, natural or to your satisfaction, try another option that suits the disc and your TV/projector, etc. For details, refer also to the instruction manual supplied with the TV/projector, etc.

1920 x 1080p	Sends 1920×1080p video signals.
1920 x 1080i	Sends 1920×1080i video signals.
1280 x 720p	Sends 1280×720p video signals.
720 x 576p*1	Sends 720×576p video signals.
720 x 480p*2	Sends 720×480p video signals.
720 x 576i*1	Sends 720×576i video signals.
720 x 480i*2	Sends 720×480i video signals.

*1 Can be selected only when "Input Line System" is set to "PAL/SECAM" in the "Basic" setup (page 76).

*2 Can be selected only when "Input Line System" is set to "NTSC" in the "Basic" setup (page 76).

Notes

- When picture noise appears after you change the "Screen Resolution" setting, hold down **■** (stop) on the recorder, and press **▲** (open/close) on the recorder.
- When "Colour" is set to "YCbCr 4:2:2" in the "HDMI Output" setup, you cannot select "720 x 576i" (or "720 x 480i").

4:3 Video Output

This setting is effective only when you set "TV Type" to "16:9" in the "Playback" setup. Adjust this setting to watch 4:3 aspect ratio signals. If you can change the aspect ratio on your TV, change the setting on your TV, not this recorder.

Note that this setting is effective only for HDMI connection.

Full	Select this when you can change the aspect ratio on your TV.
Normal	Select this when you cannot change the aspect ratio on your TV. Shows a 4:3 size video with the aspect ratio as it is.

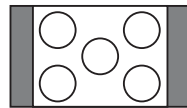

16:9 aspect ratio TV

Colour

Selects the method of outputting video signals for the HDMI jack.

RGB (0-255)	Outputs RGB (0-255) signals. Select this when connecting to an RGB (0-255) device.
RGB (16-235)	Outputs RGB (16-235) signals. Select this if colours appear overly rich and the black appears too deep.
YCbCr 4:2:2	Outputs 10-bit YCbCr 4:2:2 component signals.
YCbCr 4:4:4	Outputs 8-bit YCbCr 4:4:4 component signals.

Notes

- Some settings may not be available depending on the connected device.
- When a DVI device is connected, you cannot select "YCbCr 4:2:2" or "YCbCr 4:4:4."
- When "Screen Resolution" is set to "720 x 576i" (or "720 x 480i") in the "HDMI Output" setup, you cannot select "YCbCr 4:2:2."

Audio Output

Selects the type of audio signal output from the HDMI OUT jack.

<u>Auto</u>	Outputs Dolby Digital, MPEG and DTS audio signals as a bitstream signal. Normally select this position.
PCM	Converts all audio signals except for DTS signals to PCM.
Bitstream Priority	Select this if the connected device is compatible with bitstream audio.

Notes

- The PCM signals may not be output even when you select "Auto" depending on the "Audio Out" settings, number of audio channels, and the HDMI-connected device.
- The "Audio Output" function is not available when a DVI device is connected.

HDMI Control

<u>On</u>	Allows you to use the HDMI control features (page 15).
<u>Off</u>	Turns off the function.

Other Settings (Options)

The "Options" setup allows you to set up other operational settings.

- 1 Press SYSTEM MENU while the recorder is in stop mode.**
 - 2 Select "Initial Setup," and press ENTER.**
 - 3 Select "Options," and press ENTER.**
- The "Options" setup appears with the following options. The default settings are underlined.

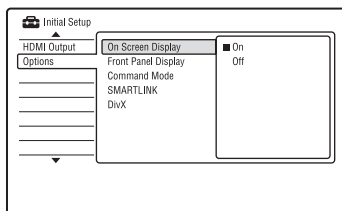

On Screen Display

<u>On</u>	Automatically displays information on the screen when the recorder is turned on, etc.
Off	Displays information only when DISPLAY is pressed.

Front Panel Display

Adjusts the lighting of the front panel display.

<u>On</u>	Bright lighting.
Off	Turns off the lighting when the power is off.

Command Mode

Changes the Command Mode of the recorder to avoid interference with your other Sony DVD recorder or player.

- 1 Select "Command Mode" in "Options," and press ENTER.
- 2 Select a Command Mode (DVD1, DVD2, or DVD3), and press ENTER.

Note

The default command mode setting for this recorder and the supplied remote is DVD3. The remote does not function if different command modes are set for the recorder and remote. Set the same command mode.

- 3 Set the Command Mode for the remote so it matches the Command Mode for the recorder you set above. Follow the steps below to set the Command Mode on the remote.
 - ① Hold down ENTER.
 - ② While holding down ENTER, enter the Command Mode code number using the number buttons.

Command Mode	Code number
DVD1	number button 1
DVD2	number button 2
DVD3	number button 3

- ③ Hold down both the number and ENTER buttons at the same time for more than three seconds.

Hint

You can check the Command Mode for the recorder in the front panel display.

Command Mode	In the front panel display
DVD1	"1" appears.
DVD2	"2" appears.
DVD3	Either "1" or "2" does not appear.

SMARTLINK

This Recorder Only	Allows you to use the SMARTLINK function with the recorder when the recorder is in standby mode.
Pass Through	Allows you to use the SMARTLINK function with the connected equipment when the recorder is in standby mode.

Note

Set "Power Save" to "Off" in the "Basic" setup (page 76) to set "SMARTLINK" to "Pass Through."

DivX

◆ Registration Code

Displays the registration code of DivX video files for this recorder.

For more information, go to <http://www.divx.com/vod> on the Internet.

Troubleshooting

If you experience any of the following difficulties while using the recorder, use this troubleshooting guide to help remedy the problem before requesting repairs. Should any problem persist, consult your nearest Sony dealer.

Power

The power does not turn on.

- ➔ Check that the mains lead is connected securely.

Picture

There is no picture.

- ➔ Re-connect all connecting cords securely.
- ➔ The connecting cords are damaged.
- ➔ Check the connection to your TV (page 12).
- ➔ Switch the input selector on your TV (such as to "VCR" and "AV 1") so that the signal from the recorder appears on the TV screen.
- ➔ Check that the "Video In/Out" setup is set to the appropriate item that conforms to your system (page 79).
- ➔ If you connect the recorder to your TV via only the COMPONENT VIDEO OUT jacks, set "Component Video Out" in the "Video In/Out" setup to "Progressive" (page 80).
- ➔ When playing a double-layer DVD, the video and audio may be momentarily interrupted at the point where the layers switch.

Picture noise appears.

- ➔ If the picture output signal from your recorder passes through your VCR to get to your TV, or if you are connected to a combination TV/VIDEO player, the copy-protection signal applied to some DVD programmes could affect picture quality. If you still experience this problem even when you connect your recorder directly to your TV, try connecting your recorder to your TV's S VIDEO input.
- ➔ You have set the recorder to progressive format even though your TV cannot accept the progressive signal. In this case, hold down ■ (stop) on the recorder, and press ▲ (open/close) on the recorder.
- ➔ Even if your TV is compatible with progressive format (525p/625p) signals, the image may be affected when you set the recorder to progressive format. In this case, hold down ■ (stop) on the recorder, and press ▲ (open/close) on the unit and the recorder is set to normal (interlace) format.
- ➔ You are playing a title recorded in a colour system that is different from your TV.
- ➔ When playing a double-layer DVD, the video and audio may be momentarily interrupted at the point where the layers switch.

There is no picture or picture noise appears when connected to the HDMI OUT jack.

- ➔ Try the following: ① Turn the recorder off and on again. ② Turn the connected equipment off and on again. ③ Disconnect and then connect the HDMI cord again.
- ➔ If the HDMI OUT jack is used for video output, changing the "Screen Resolution" setting in the "HDMI Output" setup may solve the problem (page 90). Connect the TV and the recorder using a video jack other than HDMI OUT, and switch the TV's input to the connected video input so that you can see the on-screen displays. Change the "Screen Resolution" setting in the "HDMI Output" setup, and switch the TV's input back to HDMI. If the picture still does not appear, repeat the steps and try other options.
- ➔ The recorder is connected to an input device that is not HDCP compliant (page 13).

- ➔ When picture noise appears after you change the “Screen Resolution” setting, hold down ■ (stop) on the recorder, and press ▲ (open/close) on the recorder.

TV programme reception does not fill the screen.

- ➔ Set the channel manually in “Manual CH Setting” in the “Tuner” setup (page 77).
- ➔ Select the correct source using the INPUT button, or select a channel of any TV programme using the PROG +/- buttons.

TV programme pictures are distorted.

- ➔ Reorient the TV aerial.
- ➔ Adjust the aerial (see the TV’s instruction manual).
- ➔ Place the recorder and TV farther apart.
- ➔ Place the TV and any bunched aerial cables farther apart.
- ➔ The aerial cable is connected to the AERIAL OUT jack on the recorder. Connect the cable to the AERIAL IN jack.
- ➔ The recorder’s colour system is different from your TV. Hold down ■ (stop) on the recorder, and press INPUT on the recorder to change the recorder’s colour system.

TV channels cannot be changed.

- ➔ The channel is skipped (page 78).
- ➔ A timer recording started, which changed the channels.

The picture from equipment connected to the recorder’s input jack does not appear on the screen.

- ➔ If the equipment is connected to the LINE 1/DECODER jack, select “L1” in the front panel display by pressing INPUT. If the equipment is connected to the LINE 2 IN jacks, select “L2” in the front panel display by pressing INPUT.

The playback picture or TV programme from the equipment connected through the recorder is distorted.

- ➔ If the playback picture output from a DVD player, VCR, or tuner goes through your recorder before reaching your TV, the copy-protection signal applied to some programmes could affect picture quality. Disconnect the playback equipment in question and connect it directly to your TV.

The picture does not fill the screen.

- ➔ Set “TV Type” in the “Playback” setup in accordance with the screen size of your TV (page 87).

The picture does not fill the screen, even though the picture size is set in “TV Type” in the “Playback” setup.

- ➔ The picture size of the title is fixed.

The picture is black and white.

- ➔ Check that “LINE 3 Out” in the “Video In/Out” setup is set to the appropriate item that conforms to your system (page 80).
- ➔ If you are using a SCART cord, be sure to use one that is fully wired (21 pins).

Sound

There is no sound.

- ➔ Re-connect all connections securely.
- ➔ The connecting cord is damaged.
- ➔ The input source setting on the audio component or the connection to the audio component is incorrect.
- ➔ The recorder is in reverse play, fast-forward, slow motion, or pause mode.
- ➔ If the audio signal does not come through the DIGITAL OUT (COAXIAL)/HDMI OUT jacks, check the “Audio Out” setup (page 82).
- ➔ The recorder supports only MP3 audio, Dolby Digital and MPEG audio for DivX video files. Press AUDIO and select MP3 audio or MPEG audio.

No sound is output from the HDMI OUT jack.

- ➔ Try the following: ①Turn the recorder off and on again. ②Turn the connected equipment off and on again. ③Disconnect and then connect the HDMI cord again.
- ➔ The HDMI OUT jack is connected to a DVI device (DVI jacks do not accept audio signals).
- ➔ The equipment connected to the HDMI OUT jack does not conform to the audio signal format. In this case, set "Audio Output" to "PCM" in the "HDMI Output" setup (page 91).

Sound distortion occurs.

- ➔ Set "Tuner Level" in the "Audio In" setup to "Compression" (page 81).

Sound is noisy.

- ➔ When playing a CD with DTS sound tracks, noise will come from the LINE 2 OUT R-AUDIO-L jacks, LINE 3 – TV jack, or LINE 1/DECODER jack (page 68).

The sound volume is low.

- ➔ The sound volume is low on some DVDs. The sound volume may improve if you set "Audio DRC" in the "Audio Out" setup to "On" (page 83).
- ➔ Set "Tuner Level" in the "Audio In" setup to "Normal" (page 81).

An alternate audio track cannot be recorded or played.

- ➔ When recording from connected equipment, set "External Audio" to "Bilingual" in the "Audio In" setup (page 81).
- ➔ Multilingual tracks (main and sub) cannot be recorded on DVD+RWs, DVD-RWs (Video mode), DVD+Rs, or DVD-Rs (Video mode). To record the language, set "Bilingual Recording" in the "Audio In" setup to "A/L" or "B/R" before recording (page 81). To record both the main and sub sounds on a disc, record on DVD-RWs/ DVD-Rs (VR mode).

- ➔ If you have connected an audio component to the DIGITAL OUT (COAXIAL) jack and want to change the audio track for DVD-RWs/DVD-Rs (VR mode) during playback, set "Dolby Digital Output" in the "Audio Out" setup to "Dolby Digital -> PCM" (page 82).

Playback

The recorder does not play any type of disc.

- ➔ The disc is upside down. Insert the disc with the labelled side facing up.
- ➔ The disc is not correctly inserted.
- ➔ Moisture has condensed inside the recorder. In this case, if the recorder is on, leave it on (if it is off, leave it off) for about an hour until the moisture evaporates.
- ➔ If the disc was recorded on another recorder and was not finalised (page 37), the recorder cannot play the disc.

The recorder does not start playback from the beginning.

- ➔ Resume play was activated (page 53).
- ➔ You have inserted a DVD whose Title menu or DVD menu automatically appears on the TV screen when it is first inserted. Use the menu to start playback.

The recorder starts playing automatically.

- ➔ The DVD VIDEO features an auto playback function.

Playback stops automatically.

- ➔ If the DVD has an auto pause signal, the recorder stops playback at the auto pause signal.

Some functions such as Stop, Search, or Slow-motion Play cannot be performed.

- ➔ Depending on the DVD, you may not be able to do some of the operations above. See the instruction manual supplied with the disc.

The language for the sound track cannot be changed.

- ➔ Multilingual tracks are not recorded on the DVD being played.
- ➔ The DVD VIDEO prohibits the changing of the language for the sound track.
- ➔ Try changing the language using the DVD VIDEO's menu.

The subtitle language cannot be changed or turned off.

- ➔ Multilingual subtitles are not recorded on the DVD VIDEO.
- ➔ The DVD VIDEO prohibits changing of the subtitles.
- ➔ Try changing the subtitle using the DVD VIDEO's menu.
- ➔ The subtitles cannot be changed for the titles recorded on this recorder.

The angles cannot be changed.

- ➔ Multi-angles are not recorded on the DVD VIDEO being played.
- ➔ You are trying to change the angles when "OO" does not appear on the TV screen (page 52). To display "OO" if various angles (multi-angles) for a scene are recorded on the disc, set "Angle Indicator" to "On" in the "Playback" setup (page 89).
- ➔ The DVD VIDEO prohibits changing angles.
- ➔ Try changing the angle using the DVD VIDEO's menu.
- ➔ The angles cannot be changed for the titles recorded on this recorder.
- ➔ The angles cannot be changed during slow motion playback or when playback is paused.

The DivX video files do not play.

- ➔ The file is not created in DivX format.
- ➔ The file has an extension other than ".avi" or ".divx."
- ➔ The DATA CD (DivX video)/DATA DVD (DivX video) is not created in a DivX format that conforms to ISO9660 Level 1/ Level 2, Romeo, Joliet, or UDF (Universal Disk Format) 1.02, 1.50, 2.00, or 2.01.
- ➔ The DivX video file format is larger than 720 (width) × 576 (height).

The MP3 audio tracks do not play.

- ➔ The MP3 audio tracks are not recorded in a format that the recorder can play (page 101).

The JPEG image files do not play.

- ➔ The JPEG image files are not recorded in a format that the recorder can play (page 101).
- ➔ Progressive JPEG images cannot be played.

**Recording/Timer recording/
Editing**

The programme position cannot be changed from the programme position you are recording.

- ➔ Set the TV's input source to "TV."

Recording does not start immediately after you press ● REC.

- ➔ Operate the recorder only after "LOAD," "FORMAT," or "INFO WRITE" disappears from the front panel display.

Nothing was recorded even though you set the timer setting correctly.

- ➔ There was a power failure during recording.
- ➔ The recorder's internal clock stopped due to a power failure that lasted for more than 1 hour. Reset the clock (page 75).
- ➔ The channel was disabled after the timer recording was set. See "Manual CH Setting" on page 77.
- ➔ Disconnect the mains lead from the mains, and connect it again.
- ➔ The programme contains copy protection signals that restrict copying.
- ➔ Another timer setting overlapped the timer setting (page 48).
- ➔ There is no DVD inside the recorder.
- ➔ There is not enough disc space for the recording.

Recording does not stop immediately after you press ■ REC STOP.

- ➔ It will take a few seconds for the recorder to input disc data before recording can stop. On-screen instructions may appear after pressing ■ REC STOP. In this case, follow the on-screen instructions.

Recording does not stop after you press ■.

- ➔ Press ■ REC STOP.

Timer recording is not complete or did not start from the beginning.

- ➔ There was a power failure during recording. If the power recovers when there is a timer recording, the recorder resumes recording. Should the power failure continue for more than 1 hour, reset the clock (page 75).
- ➔ Another timer setting overlapped the timer setting (page 48).
- ➔ Disc space was not sufficient.
- ➔ The VPS/PDC function is working.

Contents previously recorded were erased.

- ➔ Data that is not playable on this recorder but was recorded on a DVD with a PC will be erased from the disc when the disc is inserted.

The VPS/PDC function does not operate.

- ➔ Check that the clock and date are set correctly.
- ➔ Check that the VPS/PDC time you set is correct (there might be a mistake in the TV programme guide). If the broadcast you wanted to record did not send the correct VPS/PDC information, the recorder will not start recording.
- ➔ If the reception is poor, the VPS/PDC signal might be altered and the recorder might not start recording.

Recording from the connected equipment with a timer

Nothing was recorded even though you set the Synchro-Recording setting correctly.

- ➔ You forgot to turn off the connected equipment. Turn off the connected equipment and set the recorder to Synchro-Recording standby mode (page 49).
- ➔ The recorder was not set to the Synchro-Recording standby mode. Set the recorder to stand by for Synchro-Recording. Make sure the SYNCHRO REC indicator lights up in the front panel display (page 49).
- ➔ The equipment is not connected to the LINE I/DECODER jack of the recorder.
- ➔ The recorder is connected to the TV output jack of the connected equipment.
- ➔ The Synchro-Recording and another timer recording overlap (page 50).

Synchro-Recording does not complete.

- ➔ The timer setting for the connected equipment overlapped the recorder's timer setting (page 50).
- ➔ There was a power failure during the recording.
- ➔ The I/⏪ button was pressed before Synchro-recording started.

The recorder automatically starts recording when the satellite receiver is turned on.

- ➔ The Synchro Rec function was activated. Turn off the satellite receiver and cancel the Synchro Rec function (page 49).

Display

The clock has stopped.

- ➔ Set the clock again (page 75).
- ➔ The clock stopped due to a power failure that lasted for more than 1 hour. Reset the clock (page 75).

The timer indicator is flashing.

- ➔ The disc does not have enough space.
- ➔ Insert a recordable disc into the recorder.
- ➔ The inserted DVD is protected (page 36).

The clock does not appear in the front panel display when the recorder is turned off.

- ➔ "Front Panel Display" is set to "Off" in the "Options" setup (page 91).

Remote control

The remote does not function.

- ➔ Different command modes are set for the recorder and remote. Set the same command mode (page 92). The default command mode setting for this recorder and the supplied remote is **DVD3**. You can check the current command mode in the front panel display (page 92).
- ➔ The batteries are weak.
- ➔ The remote is too far from the recorder.
- ➔ The remote's manufacturer code returned to the default setting when you replaced the batteries. Reset the code (page 18).
- ➔ The remote is not pointed at the remote sensor on the recorder.

Others

Display language on the screen switches automatically.

- ➔ When "HDMI Control" is set to "On" in the "HDMI Output" setup (page 91), the display language on the screen automatically switches, according to the language setting of the connected TV, if you change the language settings on your TV, etc.

The recorder does not operate properly.

- ➔ Press down **I/⏻** on the recorder for more than five seconds until the recorder turns off. Then, press **I/⏻** again to turn on the recorder.
- ➔ When static electricity, etc., causes the recorder to operate abnormally, turn off the recorder and wait until the clock appears in the front panel display. Then, unplug the recorder and after leaving it off for a while, plug it in again.

The disc tray does not open after you press **⏻ (open/close).**

- ➔ It may take a few seconds for the disc tray to open after you have recorded or edited a DVD. This is because the recorder is adding disc data to the disc.

Any buttons do not function and "LOCKED" appears in the front panel display.

- ➔ The recorder is locked. Cancel the Child Lock (page 53, 67).

The disc tray does not open and "TRAYLOCKED" appears in the front panel display.

- ➔ Contact your Sony dealer or local authorized Sony service facility.

"REPAIR" appears in the front panel display.

- ➔ The recorder's repair function is activated to repair the disc. Leave the recorder on until "REPAIR" disappears from the front panel display. Some data may be lost even if the repair function is activated.

"HDCP_ERR" appears in the front panel display.

- ➔ The recorder is connected to an input device that is not HDCP compliant. Connect the equipment that is HDCP compliant (page 13). Disregard this error message if the output picture is displayed correctly.

Mechanical sounds are heard when the recorder is off.

- ➔ While the recorder is adjusting the clock for the Auto Clock Set function, operational noises may be heard, even when the power is off. This is not a malfunction.

Resetting the Recorder

You can reset the recorder to all its factory settings.

- 1 Make sure that the recorder is turned on and remove the disc.**
- 2 Hold down ■ (stop) on the recorder and press I/⏪ on the recorder.**
All settings are reset and the recorder turns off.

Notes About This Recorder

On operation

- If the recorder is brought directly from a cold to a warm location, or is placed in a very damp room, moisture may condense on the lenses inside the recorder. Should this occur, the recorder may not operate properly. In this case, if the recorder is on, leave it on (if it is off, leave it off) for about an hour until the moisture evaporates.
- When you move the recorder, take out any discs to avoid damaging the disc.

On adjusting volume

Do not turn up the volume while listening to a section with very low level inputs or no audio signals. If you do, the speakers may be damaged when a peak level section is played.

On cleaning

Clean the cabinet, panel, and controls with a soft cloth slightly moistened with a mild detergent solution. Do not use any type of abrasive pad, scouring powder or solvent such as alcohol or benzene.

On cleaning discs, disc/lens cleaners

Do not use cleaning discs or disc/lens cleaners (including wet or spray types). These may cause the recorder to malfunction.

Notes about the discs

- To keep the disc clean, handle the disc by its edge. Do not touch the surface. Dust, fingerprints, or scratches on the disc may cause it to malfunction.



- Do not expose the disc to direct sunlight or heat sources such as hot air ducts, or leave it in a car parked in direct sunlight as the temperature may rise considerably inside the car.
- After playing, store the disc in its case.
- Clean the disc with a cleaning cloth. Wipe the disc from the centre out.



- Do not use solvents such as benzene, thinner, commercially available cleaners, or anti-static spray intended for vinyl LPs.
- Do not use the following discs.
 - A disc that has a non-standard shape (e.g., card, heart).
 - A disc with a label or sticker on it.
 - A disc that has cellophane tape or sticker adhesive on it.

On replacement of parts

In the event that this unit is repaired, repaired parts may be collected for reuse or recycling purposes.

Specifications

System

Laser: Semiconductor laser

Channel coverage:

PAL/SECAM (B/G, D/K, I, L)

VHF: E2 to E12, R1 to R12, F2 to F10,
Italian A to H, Ireland A to J, South
Africa 4 to 11, 13

UHF: E21 to E69, R21 to R69, B21 to
B69, F21 to F69

CATV: S01 to S05, S1 to S20, France
B to Q

HYPER: S21 to S41

The above channel coverage merely ensures the channel reception within these ranges. It does not guarantee the ability to receive signals in all circumstances. For details, see "Receivable channels" (page 78).

Video reception: Frequency synthesizer system

Audio reception: Split carrier system

Aerial out: 75-ohm asymmetrical aerial socket

Timer: Clock: Quartz locked/Timer indication: 24-hour cycle (digital)/
Power back-up duration: 1 hour

Video recording format: MPEG-2, MPEG-1

Audio recording format/applicable bit rate: Dolby Digital 2 ch
256 kbps/128 kbps (in EP, SLP, and SEP mode), PCM

Inputs and outputs

LINE 2 OUT

(AUDIO): Phono jack/2 V_{rms}/10 kilohms

(VIDEO): Phono jack/1.0 V_{p-p}

(S VIDEO): 4-pin mini DIN/Y: 1.0 V_{p-p},
C: 0.3 V_{p-p} (PAL)

LINE 2 IN

(AUDIO): Phono jack/2 V_{rms}/more than
22 kilohms

(VIDEO): Phono jack/1.0 V_{p-p}

(S VIDEO): 4-pin mini DIN/Y: 1.0 V_{p-p},
C: 0.3 V_{p-p} (PAL)

LINE 3 – TV: 21-pin

CVBS OUT

S-Video/RGB OUT (upstream)

LINE 1/DECODER: 21-pin

CVBS IN/OUT

S-Video/RGB IN

Decoder

DIGITAL OUT (COAXIAL): Phono jack/
0.5 V_{p-p}/75 ohms

COMPONENT VIDEO OUT

(Y, P_B/C_B, P_R/C_R):

Phono jack/Y: 1.0 V_{p-p},

P_B/C_B: 0.7 V_{p-p}, P_R/C_R: 0.7 V_{p-p}

HDMI OUT: HDMI 19-pin-Standard
Connector

General

Power requirements: 220-240 V AC,
50/60 Hz

Power consumption: 22 W

Dimensions (approx.):

430 × 66.5 × 286 mm (width/height/
depth) incl. projecting parts

Mass (approx.): 3.6 kg

Operating temperature: 5°C to 35°C

Operating humidity: 25% to 80%

Supplied accessories:

Mains lead (1)

Aerial cable (1)

Remote commander (remote) (1)

R6 (size AA) batteries (2)

Specifications and design are subject to change without notice.

Notes on MP3 Audio Tracks, JPEG Image Files, and DivX Video Files

About MP3 audio tracks, JPEG image files, and DivX video files

MP3 is an audio compression technology that satisfies certain ISO/MPEG regulations.

JPEG is an image compression technology. You can play MP3 (MPEG1 Audio Layer 3) format audio tracks and JPEG image files on DATA CDs (CD-ROMs/CD-Rs/CD-RWs) or JPEG image files on DATA DVDs (DVD-ROMs/DVD-RWs/DVD-Rs).

DivX[®] is a video file compression technology, developed by DivX, Inc. This product is an official DivX[®] Certified product. You can play DATA CDs (CD-ROMs/CD-Rs/CD-RWs) and DATA DVDs (DVD-ROMs/DVD+RWs/DVD+Rs/DVD-RWs/DVD-Rs) that contain DivX video files. DATA DVDs must be recorded according to ISO9660 Level 1, Level 2, Romeo, Joliet, or UDF (Universal Disk Format) 1.02, 1.50, 2.00*, or 2.01 format for the recorder to recognise the MP3 tracks, JPEG image files, and DivX video files.

DATA CDs must be recorded according to ISO9660 Level 1, Level 2, Romeo, or Joliet format for the recorder to recognise the MP3 tracks, JPEG image files, and DivX video files.

You can also play discs recorded in MultiSession/Border.

See the instructions supplied with the disc drives and the recording software (not supplied) for details on the recording format.

* Not available for MP3 audio tracks.

Note on MultiSession/Border discs

If audio tracks and images in Music CD format or Video CD format are recorded in the first session/border, only the first session/border will be played back.

MP3 audio tracks, JPEG image files, or DivX video files that the recorder can play

The recorder can play the following tracks and files:

- MP3 audio tracks with the extension “.mp3.”
- JPEG image files with the extension “.jpeg” or “.jpg.”
- Baseline JPEG image files that conform to the Exif 2.2* image files format, and Y:Cb:Cr is 4:4:4, 4:2:2, or 4:2:0.
- DivX video files with the extension “.avi” or “.divx.”

* “Exchangeable Image File Format”: The file format used by digital still cameras.

🔔 Hint

Since a disc with many trees takes longer to start playback, it is recommended that you create albums with no more than two trees.

🔊 Notes

- The recorder will play any data with the extension “.mp3,” “.jpeg,” “.jpg,” “.avi,” or “.divx” even if they are not in MP3, JPEG, or DivX format. Playing these data may generate a loud noise which could damage your speaker system.
- Depending on the disc, normal playback may not be possible. For example, the picture may be unclear, playback may not appear smooth, the sound may skip, and so on.
- Depending on the disc, playback may take some time to start.
- Some files cannot be played.
- For MP3 audio tracks and DivX video files, the recorder can play up to 99 albums each on a DATA CD or DATA DVD. Up to 99 tracks and files under an album can be played.
- For JPEG image files, the recorder can load up to 99 albums and/or up to 999 files under an album on a DATA CD/DATA DVD at a time. To view unloaded albums, reload them.
- Proceeding to the next or another album may take some time.
- The image size that can be displayed is limited. The following image sizes can be displayed: width 160–5,120 pixels by height 120–3,840 pixels.
- This recorder supports MP3 audio tracks recorded with a sampling frequency of 32 kHz, 44.1 kHz, and 48 kHz.
- No more than a 1 GB MP3 audio track can be played.
- The recorder does not conform to audio tracks in mp3PRO format.

- The recorder cannot play a DivX video file of a size larger than 720 (width) × 576 (height)/4 GB.
- The recorder may not play a DivX video file when the file has been combined from two or more DivX video files.

Guide to Parts and Controls

For more information, see the pages in parentheses.

Remote

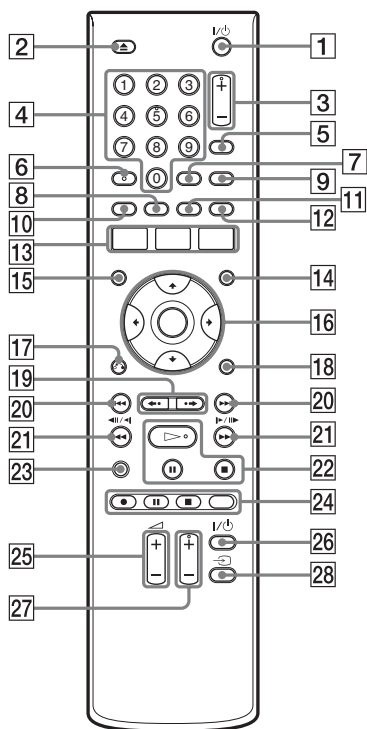

- 1 **I/⏻** (on/standby) button (20)
- 2 **▲** (open/close) button (29)
- 3 **PROG** (programme) +/- buttons (29)
The + button has a tactile dot*.
- 4 Number buttons (45, 59)
The number 5 button has a tactile dot*.
- 5 **INPUT** (input select) button (49)
- 6 **AUDIO** button (54, 67)
The AUDIO button has a tactile dot*.
- 7 **CLEAR** button (34, 56, 68, 69)
- 8 **ANGLE** button (52, 73)
- 9 **TV/DVD** button (18)
- 10 **SUBTITLE** button (54)

- 11 **PLAY MODE** button (56, 59, 68, 70)
- 12 **ZOOM** button (73)
- 13 **SYSTEM MENU** button (45, 46, 57, 74)
TITLE LIST button (31, 52, 61)
TIMER button (43)
- 14 **MENU** button (52)
- 15 **TOP MENU** button (52)
- 16 **←/↑/↓/→/ENTER** button (20)
- 17 **↶** **RETURN** button (20)
- 18 **DISPLAY** button (33)
- 19 **←•/•→** (instant replay/instant advance) buttons (54)
- 20 **◀◀/▶▶** (previous/next) buttons (54, 67)
- 21 **◀◀◀||◀/▶▶▶** (search/slow freeze frame) buttons (54, 67)
- 22 **▷** (play) button (52, 67, 72)
|| (pause) button (54, 67, 72)
■ (stop) button (52, 67, 72)
The ▷ button has a tactile dot*.
- 23 **DISC SETUP** button (36, 37, 40, 74)
- 24 **● REC** button (29)
|| REC PAUSE button (29)
■ REC STOP button (29)
REC MODE button (29)
- 25 **TV** **↔** (volume) +/- buttons (18)
- 26 **TV I/⏻** (on/standby) button (18)
- 27 **TV PROG** (programme) +/- buttons (18)
The + button has a tactile dot*.
- 28 **TV** **↶** (input select) button (18)

* Use the tactile dot as a reference when operating the recorder.

Front panel

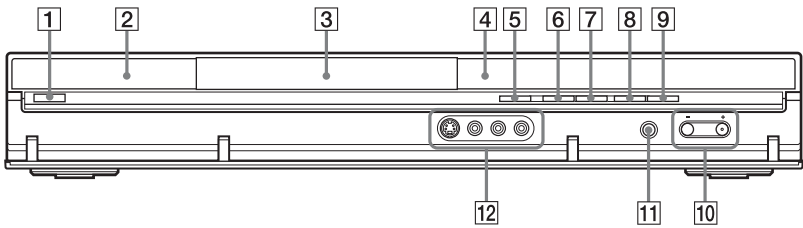

- | | |
|--|--|
| <p>1 I/⏻ (on/standby) button (20)</p> <p>2 📡 (remote sensor) (18)</p> <p>3 Disc tray (29)</p> <p>4 Front panel display (104)</p> <p>5 ⏮ (open/close) button (29)</p> <p>6 ▶ (play) button (52, 67, 72)
The ▶ button has a tactile dot*.</p> <p>7 ■ (stop) button (52, 67, 72)</p> | <p>8 ● REC button (29)</p> <p>9 ■ REC STOP button (29)</p> <p>10 PROGRAM +/- buttons (29)
The + button has a tactile dot*.</p> <p>11 INPUT (input select) button (49)</p> <p>12 LINE 2 IN (S VIDEO/VIDEO/
L(MONO) AUDIO R) jacks (24)</p> |
|--|--|

* Use the tactile dot as a reference when operating the recorder.

Front panel display

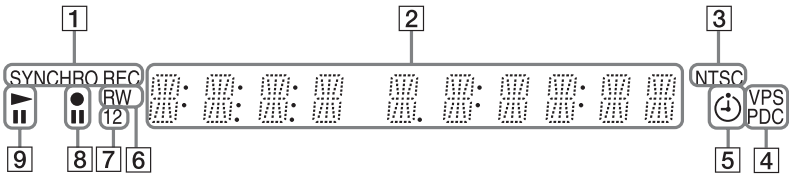

- | | |
|---|---|
| <p>1 SYNCHRO REC indicator (49)</p> <p>2 Displays the following:</p> <ul style="list-style-type: none"> • Playing time • Current title/chapter/track/index number • Recording time/recording mode • Clock • Programme position <p>3 NTSC indicator (76, 80)</p> <p>4 VPS/PDC indicator (44)</p> <p>5 Timer indicator (43)</p> | <p>6 Disc type
Lights when a recordable DVD-R or DVD-RW disc is loaded.</p> <p>7 Command Mode indicator (92)
Displays the Command Mode of the remote.
When the Command Mode for the recorder is set to DVD3 (default), either "1" or "2" does not appear.</p> <p>8 Recording status</p> <p>9 Playing status</p> |
|---|---|

Rear panel

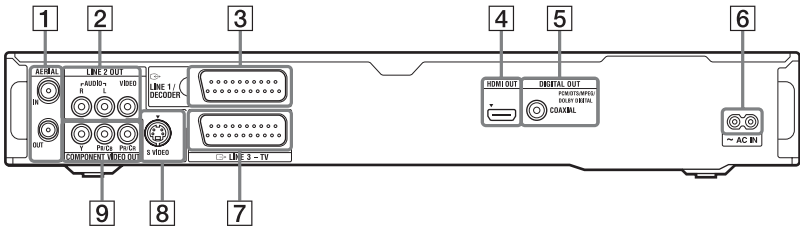

- 1** AERIAL IN/OUT jacks (12)
- 2** LINE 2 OUT (R-AUDIO-L/VIDEO) jacks (13, 16)
- 3** LINE 1/DECODER jack (23)
- 4** HDMI OUT (high-definition multimedia interface out) jack (13, 16)
- 5** DIGITAL OUT (COAXIAL) jack (16)
- 6** AC IN terminal (17)
- 7** LINE 3 - TV jack (13)
- 8** LINE 2 OUT (S VIDEO) jack (13)
- 9** COMPONENT VIDEO OUT (Y, PB/CB, PR/CR) jacks (13)

Language Code List

For details, see page 83.

The language spellings conform to the ISO 639: 1988 (E/F) standard.

Number	Language (code)	Number	Language (code)	Number	Language (code)
0101	Afar (aa)	0905	Interlingue (ie)	1813	Rhaeto-Romance (rm)
0102	Abkhazian (ab)	0911	Inupiak (ik)	1814	Kirundi (rn)
0106	Afrikaans (af)	0914	Indonesian (in)	1815	Romanian (ro)
0113	Amharic (am)	0919	Icelandic (is)	1821	Russian (ru)
0118	Arabic (ar)	0920	Italian (it)	1823	Kinyarwanda (rw)
0119	Assamese (as)	0923	Hebrew (iw)	1901	Sanskrit (sa)
0125	Aymara (ay)	1001	Japanese (ja)	1904	Sindhi (sd)
0126	Azerbaijani (az)	1009	Yiddish (ji)	1907	Sangho (sg)
0201	Bashkir (ba)	1023	Javanese (jw)	1908	Serbo-Croatian (sh)
0205	Byelorussian (be)	1101	Georgian (ka)	1909	Singhalese (si)
0207	Bulgarian (bg)	1111	Kazakh (kk)	1911	Slovak (sk)
0208	Bihari (bh)	1112	Greenlandic (kl)	1912	Slovenian (sl)
0209	Bislama (bi)	1113	Cambodian (km)	1913	Samoan (sm)
0214	Bengali (bn)	1114	Kannada (kn)	1914	Shona (sn)
0215	Tibetan (bo)	1115	Korean (ko)	1915	Somali (so)
0218	Breton (br)	1119	Kashmiri (ks)	1917	Albanian (sq)
0301	Catalan (ca)	1121	Kurdish (ku)	1918	Serbian (sr)
0315	Corsican (co)	1125	Kirghiz (ky)	1919	Siswati (ss)
0319	Czech (cs)	1201	Latin (la)	1920	Sesotho (st)
0325	Welsh (cy)	1214	Lingala (ln)	1921	Sundanese (su)
0401	Danish (da)	1215	Laothian (lo)	1922	Swedish (sv)
0405	German (de)	1220	Lithuanian (lt)	1923	Swahili (sw)
0426	Bhutani (dz)	1222	Latvian (lv); Lettish	2001	Tamil (ta)
0512	Greek (el)	1307	Malagasy (mg)	2005	Telugu (te)
0514	English (en)	1309	Maori (mi)	2007	Tajik (tg)
0515	Esperanto (eo)	1311	Macedonian (mk)	2008	Thai (th)
0519	Spanish (es)	1312	Malayalam (ml)	2009	Tigrinya (ti)
0520	Estonian (et)	1314	Mongolian (mn)	2011	Turkmen (tk)
0521	Basque (eu)	1315	Moldavian (mo)	2012	Tagalog (tl)
0601	Persian (fa)	1318	Marathi (mr)	2014	Setswana (tn)
0609	Finnish (fi)	1319	Malay (ms)	2015	Tonga (to)
0610	Fiji (fj)	1320	Maltese (mt)	2018	Turkish (tr)
0615	Faroese (fo)	1325	Burmese (my)	2019	Tsonga (ts)
0618	French (fr)	1401	Nauru (na)	2020	Tatar (tt)
0625	Frisian (fy)	1405	Nepali (ne)	2023	Twi (tw)
0701	Irish (ga)	1412	Dutch (nl)	2111	Ukrainian (uk)
0704	Scots Gaelic (gd)	1415	Norwegian (no)	2118	Urdu (ur)
0712	Galician (gl)	1503	Occitan (oc)	2126	Uzbek (uz)
0714	Guarani (gn)	1513	(Afan)Oromo (om)	2209	Vietnamese (vi)
0721	Gujarati (gu)	1518	Oriya (or)	2215	Volapük (vo)
0801	Hausa (ha)	1601	Panjabi (pa)	2315	Wolof (wo)
0809	Hindi (hi)	1612	Polish (pl)	2408	Xhosa (xh)
0818	Croatian (hr)	1619	Pashto (ps); Pushto (ps)	2515	Yoruba (yo)
0821	Hungarian (hu)			2608	Chinese (zh)
0825	Armenian (hy)	1620	Portuguese (pt)	2621	Zulu (zu)
0901	Interlingua (ia)	1721	Quechua (qu)		

Country/Area Code

For details, see page 88.

Number	Area (Code)	Number	Area (Code)
0118	Argentina (ar)	1325	Malaysia (my)
0121	Australia (au)	1324	Mexico (mx)
0120	Austria (at)	1412	Netherlands (nl)
0205	Belgium (be)	1426	New Zealand (nz)
0218	Brazil (br)	1415	Norway (no)
0301	Canada (ca)	1611	Pakistan (pk)
0312	Chile (cl)	1608	Philippines (ph)
0314	China (cn)	1620	Portugal (pt)
0411	Denmark (dk)	1821	Russia (ru)
0609	Finland (fi)	1907	Singapore (sg)
0618	France (fr)	0519	Spain (es)
0405	Germany (de)	1905	Sweden (se)
0811	Hong Kong (hk)	0308	Switzerland (ch)
0914	India (in)	2023	Taiwan (tw)
0904	Indonesia (id)	2008	Thailand (th)
0920	Italy (it)	0702	United Kingdom (gb)
1016	Japan (jp)	2119	USA (us)
1118	Korea (kr)		

Index

Words in quotations appear in the on-screen displays.

Numerics

- “16:9” 87
- “4:3 Letter Box” 87
- “4:3 Pan Scan” 87
- “96 kHz PCM Output” 82

A

- “A-B Erase” 62
- “A-B Repeat” 56, 68
- Adjusting
 - playback picture 57
 - recording picture 46
- Aerial 12
- “AFT” 78
- “Album Search” 70
- ANGLE 52, 73
- “Angle Indicator” 52, 89
- AUDIO 54, 67
- Audio cord 16
- “Audio DRC” 83
- “Audio In” 81
- Audio input 17
- “Audio Language” 83
- “Audio Out” 82
- “Auto” 75
- “Auto Channel Setting” 20, 77
- “Auto Chapter (DVD+R/+RW)” 86
- “Auto Chapter (Video)” 86
- “Auto Chapter (VR)” 86
- Auto Clock Set 20, 75
- “Auto Language” 84
- “Auto Scan” 20, 77

B

- “Basic” 74, 75
- Batteries 18
- “Bilingual Recording” 81
- Bilingual recording 42
- ‘BRAVIA’ Theatre Sync 15

C

- Canal Plus 26
- CD 9
- “CH System” 78
- “Channel” 78
- “Channel Swapping” 79
- Chapter 33, 47
- Chapter number 33
- “Chapter Search” 59
- Checking/changing/cancelling timer settings (Timer List) 48
- Child Lock 53, 67
- “Clock Setting” 20, 75
- “Combine” 64, 65
- “Command Mode” 19, 92
- COMPONENT VIDEO OUT 14
- “Component Video Out” 80
- Connecting
 - the aerial cable 12
 - the audio cords 16
 - the HDMI cord 13, 16
 - the video cords 13
- Controlling TVs with the remote 18
- Copy control signals 42
- Copy-Free 42
- Copy-Never 42
- Copy-Once 42
- Country/Area code 107
- CPRM 8
- Creating a Playlist 64

D

- DATA CD 9
- DATA DVD 9
- “Decoder” 27, 78, 80
- DIGITAL OUT (COAXIAL) 16
- Disc settings 36, 37, 40, 74
- “Disc Setup” 36, 37, 40, 74
- Disc space 61
- Disc types 7, 60
- “Divide” 63, 65
- DivX video files 52
- Dolby Digital 16, 82
- “Download from TV” 20, 77
- DTS 16, 82
- “DVD Menu Language” 84
- DVD VIDEO 9
- DVD+R 7, 60
- DVD+RW 7, 60
- DVD-R 7, 60
- DVD-RAM 9
- DVD-RW 7, 60

E

- Easy Setup 20, 76
- “Edit” 61
- Editing 60, 64
 - chapters 63
 - Playlist 64
 - titles 61
- Enter characters 34
- “Erase” 48, 61, 64
- “External Audio” 81

F

“Finalise” 37
Finalising 37
“Format” 40
“Format DVD-RW” 74
Formatting 40
Freeze Frame 55
Front panel 104
“Front Panel Display” 91
Front panel display 104

H

Handling discs 99
HDMI
 “4:3 Video Output”
 90
 “Audio Output” 91
 “Colour” 90
 “HDMI Control” 91
 “Screen Resolution”
 90
HDMI cord 13, 16
HDMI OUT 14, 16
“HDMI Output” 89
“HELP Setting” 76

I

INPUT 51
“Input Colour System” 79
“Input Line System” 76

J

JPEG image files 71

L

Labelling 36
“Language” 83
“LINE 1 In” 80
LINE 1/DECODER 23
LINE 2 IN 24
“LINE 3 Out” 80

M

Main sound 42, 81
Mains lead 17
“Manual” 75
“Manual CH Setting” 77
Manual Clock Set 20, 75
“Manual Rec. Mode” 84
Manual recording mode 85
MENU 52
Menu
 DVD’s Menu 52
 Top menu 52
“Modify” 48
“Move” 65, 66
MP3 audio tracks 67
MPEG 16, 83

N

“Name” 78
NICAM 42, 81
“NICAM Select” 81
“NTSC on PAL TV” 80
Number buttons 45, 59

O

“On Screen Display” 91
One-Touch Play 15, 53
“Options” 91
Original 32, 60
“OSD Language” 83

P

Page mode 32, 72
Parental Control 53, 88
Parts and controls 103
“Pause Mode” 87
PAY-TV 26
PBC 52
PDC 44
“Photo Album” list 71
“Picture Adjustment” 46, 57
Picture quality 46, 57
PLAY MODE 56, 57, 68, 69
Play mode
 “A-B Repeat” 56, 68
 “Programme” 57, 69
 “Repeat” 56, 68
Playable discs 7, 9
“Playback” 87
Playback 7, 52, 67, 71
 “A-B Repeat” 56, 68
 DivX video files 52
 fast forward 54, 67
 fast reverse 54, 67
 freeze frame 55
 instant advance 54
 instant replay 54
 JPEG image files 71
 MP3 audio tracks 67
 “Programme” 57, 69
 “Repeat” 56, 68
 resume play 53
 rotate 73
 scan audio 52
 slow-motion play 55
 zoom 73
Playlist 32, 60
“Power Save” 76
“Programme” 57, 69
“Progressive” 21
“Protect” 62
“Protect Disc” 36
Protection
 disc 36
 title 62

Q

Quick guide to disc types 7
Quick Timer 46

R

Rear panel 105
REC 29
REC MODE 41
REC STOP 29
“Rec. Mode Adjust” 44, 86
Recordable discs 7
“Recording” 84
Recording 41

- picture adjustment 46
- recording format 7
- recording mode 30, 41
- recording time 30, 41
 - while watching
 - another
 - programme 30

Recording mode 30, 41
Recording time 30, 41
Region code 10
“Registration Code” 92
Remaining time 30, 33
Remote 18, 103
“Repeat” 56, 68
“Repeat Album” 68
“Repeat Chapter” 56
“Repeat Disc” 56, 68
“Repeat Programme” 56, 68
“Repeat Title” 56
“Repeat Track” 56, 68
Resetting the recorder 76, 99
Resume Play 53
“RGB” 80
Rotate 73

S

S VIDEO 14
Satellite tuner 25
Scan Audio 52
“Seamless Playback” 87
Searching

- audio track 67
- fast reverse/fast
 - forward 54, 67
- JPEG image file 73
- locating the beginning
 - of the title/
chapter/track
 - 54, 67
 - scan audio 52

“Set Thumbnail” 61, 86
“Set VIDEO Plus+ CH” 21
Setting the VIDEO Plus+
programme positions 21
“Skip” 78
“Skip Once” 48
Slideshow 72
Slow-motion play 55
SMARTLINK 15, 92
“Sound System” 78
“Standard (4:3)” 21
Sub sound 42, 81
SUBTITLE 54
“Subtitle Display” 84
“Subtitle Language” 83
Super VIDEO CD 9
“S-Video” 80
Synchro Rec 49

T

Thumbnail picture 32
“Time Search” 59
TIMER 43
Timer List 48
Timer recording

- check/change/cancel
- 48
- manual setting 43
- “Rec. Mode Adjust”
- 44
- Synchro Rec 49
- VIDEO Plus+ 45

Title 33
Title List 31

- Thumbnail 32

“Title Name” 61
Title number 33
“Title Search” 59
TOP MENU 52
“Track Search” 59, 70
Troubleshooting 93
“Tuner” 77
“Tuner Level” 81
“TV Screen Size” 21
TV system 78
TV  18, 30
“TV Type” 87
TV/DVD 19, 30

U

“Undo” 62
“Unfinalise” 39
Unfinalising 39
Usable discs 7, 9

V

“Video” 80

VIDEO CD 9

Video cord 13

“Video In/Out” 79

Video input 14

Video mode 7

VIDEO Plus+ 21, 45

VPS 44

VR mode 7

W

“Wide (16:9)” 21

Z

Zoom 73

ZWEITON 42



Printed on 70% or more recycled paper.



1-3113759120

3-113-759-12(1)

Free Manuals Download Website

<http://myh66.com>

<http://usermanuals.us>

<http://www.somanuals.com>

<http://www.4manuals.cc>

<http://www.manual-lib.com>

<http://www.404manual.com>

<http://www.luxmanual.com>

<http://aubethermostatmanual.com>

Golf course search by state

<http://golfingnear.com>

Email search by domain

<http://emailbydomain.com>

Auto manuals search

<http://auto.somanuals.com>

TV manuals search

<http://tv.somanuals.com>