

DVD Recorder

Operating Instructions

RDR-HX900/HX1000



DVD + ReWritable



WARNING

To prevent fire or shock hazard, do not expose the unit to rain or moisture. To avoid electrical shock, do not open the cabinet. Refer servicing to qualified personnel only. The mains lead must only be changed at a qualified service shop.

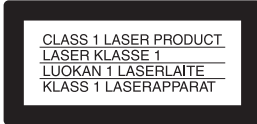

This appliance is classified as a CLASS 1 LASER product. The CLASS 1 LASER PRODUCT MARKING is located on the rear exterior.

CAUTION

The use of optical instruments with this product will increase eye hazard. As the laser beam used in this DVD recorder is harmful to eyes, do not attempt to disassemble the cabinet. Refer servicing to qualified personnel only.



This label is located on the laser protective housing inside the enclosure.

Notice for customers in the United Kingdom and Republic of Ireland

A moulded plug complying with BS1363 is fitted to this equipment for your safety and convenience.

Should the fuse in the plug supplied need to be replaced, a 5 AMP fuse approved by ASTA or BSI to BS1362, (i.e., marked with ⚡ or ⚡ mark) must be used.

If the plug supplied with this equipment has a detachable fuse cover, be sure to attach the fuse cover after you change the fuse. Never use the plug without the fuse cover. If you should lose the fuse cover, please contact your nearest Sony service station.

Precautions

- This unit operates on 220 – 240 V AC, 50/60 Hz. Check that the unit's operating voltage is identical with your local power supply.
- To prevent fire or shock hazard, do not place objects filled with liquids, such as vases, on the apparatus.

VIDEO Plus+ and PlusCode are registered trademarks of Gemstar Development Corporation. The VIDEO Plus+ system is manufactured under license from Gemstar Development Corporation.

Precautions

This equipment has been tested and found to comply with the limits set out in the EMC Directive using a connection cable shorter than 3 metres.

On safety

Should any solid object or liquid fall into the cabinet, unplug the recorder and have it checked by qualified personnel before operating it any further.

On power sources

- The recorder is not disconnected from the AC power source (mains) as long as it is connected to the wall outlet, even if the recorder itself has been turned off.
- If you are not going to use the recorder for a long time, be sure to disconnect the recorder from the wall outlet. To disconnect the AC power cord (mains lead), grasp the plug itself; never pull the cord.
- Before disconnecting the AC power cord (mains lead), check that the recorder's hard disk is not operating (recording or dubbing) on the front panel display.

On placement

- Place the recorder in a location with adequate ventilation to prevent heat build-up in the recorder.
- Do not place the recorder on a soft surface such as a rug that might block the ventilation holes.
- Do not place the recorder in a confined space such as a bookshelf or similar unit.
- Do not place the recorder in a location near heat sources, or in a place subject to direct sunlight, excessive dust, or mechanical shock.
- Do not place the recorder in an inclined position. It is designed to be operated in a horizontal position only.
- Keep the recorder and discs away from equipment with strong magnets, such as microwave ovens, or large loudspeakers.

- Do not place heavy objects on the recorder.

On recording

- Note that the contents of the recording cannot be compensated for under any and all conditions, including conditions that may arise due to a malfunction of this unit.
- Make trial recordings before making the actual recording.

About the hard disk drive

The hard disk has a high storage density, which enables long recording durations and quick access to the written data. However, it can easily be damaged by shock, vibration or dust, and should be kept away from magnets. To avoid losing important data, observe the following precautions.

- Do not apply a strong shock to the recorder.
- Do not place the recorder in a location subject to mechanical vibrations or in an unstable location.
- Do not move the recorder with its mains lead connected.
- Do not move the recorder for one minute after you have unplugged the mains lead.
- Do not disconnect the mains lead while the power is on.
- Do not use the recorder in a place subject to extreme changes in temperature (temperature gradient less than 10 °C/hour).
- Do not attempt to change the hard disk. This may result in a malfunction. Should the hard disk be damaged, you cannot recover lost data. The hard disk is only a temporary storage space.
- The recorded contents of the hard disk drive may be erased or destroyed if the unit should malfunction for whatever reason, or if the hard disk drive is repaired, modified or replaced. Note that the contents of the recording cannot be compensated for under any and all conditions.

Copyrights

- Television programmes, films, video tapes, discs, and other materials may be copyrighted. Unauthorized recording of such material may be contrary to the provisions of the copyright laws. Also, use of this recorder with cable television transmission may require authorization from the cable television transmitter and/or programme owner.
- This product incorporates copyright protection technology that is protected by U.S. patents and other intellectual property rights. Use of this copyright protection technology must be authorized by Macrovision, and is intended for home and other limited viewing uses only unless otherwise authorized by Macrovision. Reverse engineering or disassembly is prohibited.

Copy guard function

Since the recorder has a copy guard function, programmes received through an external tuner (not supplied) may contain copy protection signals (copy guard function) and as such may not be recordable, depending on the type of signal.

IMPORTANT NOTICE

Caution: This recorder is capable of holding a still video image or on-screen display image on your television screen indefinitely. If you leave the still video image or on-screen display image displayed on your TV for an extended period of time you risk permanent damage to your television screen. Plasma display panels and projection televisions are especially susceptible to this.

If you have any questions or problems concerning your recorder, please consult your nearest Sony dealer.

About this manual

Check your model name

The instructions in this manual are for 2 models: RDR-HX900 and RDR-HX1000. Check your model name by looking at the front panel of the recorder.

- In this manual, the internal hard disk drive is written as “HDD,” and “disc” is used as a general reference for the HDD, DVDs, or CDs unless otherwise specified by the text or illustrations.
- Instructions in this manual describe the controls on the remote. You can also use the controls on the recorder if they have the same or similar names as those on the remote.
- The on-screen display illustrations used in this manual may not match the graphics displayed on your TV screen.
- The explanations regarding DVDs in this manual refer to DVDs created on this recorder. The explanations do not apply to DVDs that are created on other recorders and played back on this recorder.

Table of Contents

WARNING	2
Precautions	2
Ways to Use Your DVD Recorder	6
Quick Guide to Disc Types	8
<hr/>	
Hookups and Settings	12
Hooking Up the Recorder	12
Step 1: Unpacking	12
Step 2: Connecting the Aerial Cable	13
Step 3: Connecting the Video Cords	14
Step 4: Connecting the Audio Cords	17
Step 5: Connecting the Mains Lead	19
Step 6: Preparing the Remote	19
Step 7: Easy Setup	22
Connecting a VCR or Similar Device	26
Connecting to a Satellite or Digital Tuner	28
Connecting a PAY-TV/Canal Plus Decoder	29
<hr/>	
Guide to Displays	32
Using the On-Screen Menus	32
Using the Title List	33
Using the "Disc Info" Screen (disc settings)	35
Checking the Play Information and Playing Time	38
How to Enter Characters	40
<hr/>	
Recording	41
Before Recording	41
Timer Recording (Standard/VIDEO Plus+)	42
Checking/Changing/Canceling Timer Settings (Timer List)	46
Recording Without the Timer	48
Recording From Connected Equipment With a Timer (Synchro Rec)	51
Recording From Connected Equipment Without a Timer	52
<hr/>	
Playback	54
Playing	54
Chasing Playback/Simultaneous Rec and Play	60
Searching for a Title/Chapter/Track, etc.	61
Playing MP3 Audio Tracks	62
<hr/>	
Editing	64
Before Editing	64
Editing a Title	65
Creating and Editing a Playlist	68

Dubbing (HDD ↔ DVD)	72
Before Dubbing	72
Dubbing a Single Title (Title Dub)	74
Dubbing Multiple Titles (Dub Selected Titles)	75
<hr/>	
DV Dubbing (DV → HDD/DVD)	77
Before DV Dubbing	77
Recording an Entire DV Format Tape (One Touch Dubbing)	79
Program Edit	80
<hr/>	
Settings and Adjustments	83
Using the Setup Displays	83
Aerial Reception and Language Settings (Settings)	84
Video Settings (Video)	88
Audio Settings (Audio)	91
Recording and Parental Control Settings (Features)	93
Disc and Remote Control Settings/Factory Settings (Options)	96
Easy Setup (Resetting the Recorder)	98
<hr/>	
Additional Information	99
Troubleshooting	99
Self-diagnosis Function (When letters/numbers appear in the display)	104
Notes About This Recorder	104
Specifications	105
About i.LINK	106
Guide to Parts and Controls	108
Glossary	112
Language Code List	114
Index	115

Ways to Use Your DVD Recorder

Quick access to recorded titles – Title List

- ➔ Display the Title List to see all of the titles on the disc, including recording date, channel, recording mode and thumbnail image (page 33).

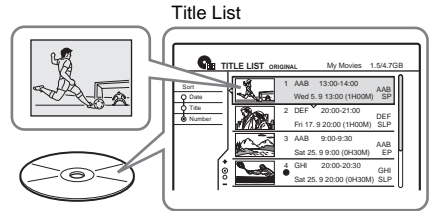

Play the beginning of a title while it is being recorded – Chasing Playback

- ➔ If you are using a DVD-RW (VR mode) or the HDD, you can watch a programme from the beginning while it is being recorded (page 60).

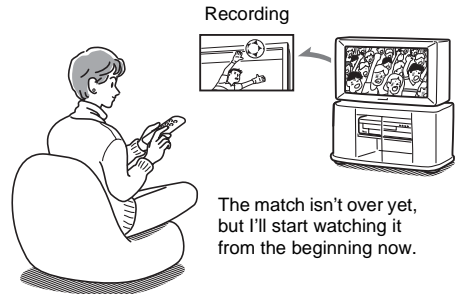

Watching one title while recording another – Simultaneous Rec and Play

- ➔ If you are using a DVD-RW (VR mode) or the HDD, you can watch a previously recorded programme while recording another programme on the same disc (page 60).



Creating your own programme – Playlist

- ➔ Record a programme on a DVD-RW (VR mode), then delete, move and add scenes at will to create your own, original programme (page 68).

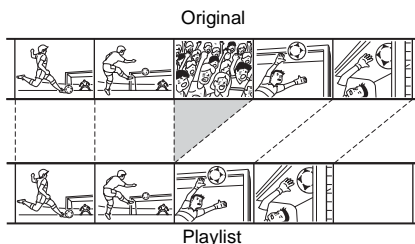

Copying a recorded title to and from the HDD – Dubbing (HDD ↔ DVD)

- ➔ Create copies of your favourite titles for safekeeping by dubbing them to a DVD, or make a copy of your friend's recordings by dubbing them to the HDD (page 72).

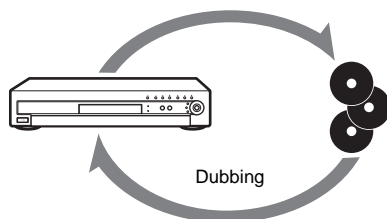

Automatic dubbing of DV tapes – DV Dubbing (DV → HDD/DVD)



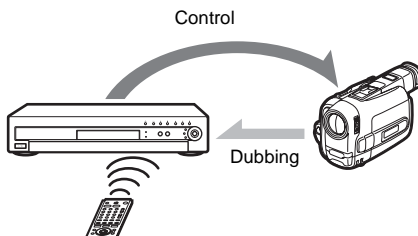







- ➔ Connect your digital video camera to the DV IN jack and automatically dub the entire contents or just selected scenes to a DVD disc (page 77).



A list of recordable and playable discs is on page 8.

Quick Guide to Disc Types

Recordable and playable discs

Type	Disc Logo	Icon used in this manual	Formatting (new discs)	Compatibility with other DVD players (finalizing)
Hard disk drive (internal)			(Formatting unnecessary)	—
DVD+RW			Automatically formatted	Playable on DVD+RW compatible players (automatically finalized)
DVD-RW			Format in VR mode (page 36)	Playable only on VR mode compatible players (finalization unnecessary)
			Format in Video mode (page 36)	Playable on most DVD players (finalization necessary) (page 37)
DVD+R			Automatically formatted	Playable on most DVD+R compatible players (finalization necessary) (page 37)
DVD-R			Automatically formatted	Playable on most DVD players (finalization necessary) (page 37)

Usable disc versions (as of May 2004)

- 4x-speed or slower DVD+RWs
- 2x-speed or slower DVD-RWs (Ver.1.1, Ver.1.1 with CPRM^{*1})
- 8x-speed or slower DVD+Rs
- 8x-speed or slower DVD-Rs (Ver.2.0)

“DVD+RW,” “DVD-RW,” “DVD+R,” and “DVD-R,” are trademarks.

^{*1} CPRM (Content Protection for Recordable Media) is a coding technology that protects copyrights for images.

^{*2} Only if the recording mode is SP, HSP, or HQ, and “DVD Rec Picture Size” is set to “16:9.”









^{*3} Erasing titles does not free up disc space.

	Recording Features				Editing Features			
	Rewrite (page 41)	Auto Chapter (page 93)	Manual Chapter (page 68)	Record 16:9 sizes (page 49)	Change title name (page 65)	Delete title (page 66)	A-B Erase (page 66)	Playlist (page 68)
	Yes	Yes	Yes	Yes	Yes	Yes	Yes	No
	Yes	Yes	No	No	Yes	Yes	Yes	No
	Yes	Yes	Yes	Yes	Yes	Yes	Yes	Yes
	Yes	Yes	No	Yes *2	Yes	Yes	No	No
	No	Yes	No	No	Yes	Yes *3	No	No
	No	Yes	No	Yes *2	Yes	Yes *3	No	No

Discs that cannot be recorded on

- 4x-speed compatible DVD-RWs (Ver. 1.2/4x)
- DVD-RWs (Ver.1.0)
- DVD+RWs that are not 2.4x-speed compatible
- Dual layer discs
- 8 cm discs

Playable discs

Type	Disc Logo	Icon used in this manual	Characteristics
DVD VIDEO			Discs such as movies that can be purchased or rented
VIDEO CD			VIDEO CDs or CD-Rs/CD-RWs in VIDEO CD/Super VIDEO CD format
CD			Music CDs or CD-Rs/CD-RWs in music CD format that can be purchased
DATA CD			CD-ROMs/CD-Rs/CD-RWs created on a PC or similar device in music format containing MP3 audio tracks

Discs that cannot be played

- All CD-ROMs (including PHOTO CDs)
- CD-Rs/CD-RWs, other than those recorded in music CD format, MP3 format, or Video CD format
- Data part of CD-Extras
- DVD-ROMs
- DVD Audio discs
- DVD-RAMs
- HD layer on Super Audio CDs
- DVD VIDEOS with a different region code (page 11)

Hint

This DVD recorder can play 8 cm CDs and 8 cm DVDs as well.

Note on playback operations of DVD VIDEOS/ VIDEO CDs

Some playback operations of DVD VIDEOS/ VIDEO CDs may be intentionally set by software producers. Since this recorder plays DVD VIDEOS/VIDEO CDs according to the disc contents the software producers designed, some playback features may not be available. Also, see the instructions supplied with the DVD VIDEOS/ VIDEO CDs.

Region code (DVD VIDEO only)

Your recorder has a region code printed on the rear of the unit and will only play DVD VIDEOS (playback only) labelled with identical region codes. This system is used to protect copyrights. DVD VIDEOS labelled  will also play on this recorder.

If you try to play any other DVD VIDEO, the message "Playback prohibited by region code." will appear on the TV screen. Depending on the DVD VIDEO, no region code indication may be labelled even though playing the DVD VIDEO is prohibited by area restrictions.



Music discs encoded with copyright protection technologies

This product is designed to play back discs that conform to the Compact Disc (CD) standard. Recently, various music discs encoded with copyright protection technologies are being marketed by some record companies. Please be aware that among those discs, there are some that do not conform to the CD standard and may not be playable by this product.

Notes

- Some DVD+RWs/DVD+Rs, DVD-RWs/DVD-Rs, or CD-RWs/CD-Rs cannot be played on this recorder due to the recording quality or physical condition of the disc, or the characteristics of the recording device and authoring software. The disc will not play if it has not been correctly finalized. For more information, see the operating instructions for the recording device.
- You cannot mix VR mode and Video mode on the same DVD-RW. To change the disc's format, reformat the disc (page 36). Note that the disc's contents will be erased after reformatting.
- You cannot shorten the time required for recording even with high-speed discs. Also, you cannot record on the disc if the disc is not 1x speed compatible.
- It is recommended that you use discs with "For Video" printed on their packaging.
- You cannot add new recordings to DVD-Rs or DVD-RWs (Video mode) that contain recordings made on other DVD equipment.
- In some cases, you may not be able to add new recordings to DVD+RWs that contain recordings made on other DVD equipment. If you do add a new recording, note that this recorder will rewrite the DVD menu.
- If the disc contains PC data unrecognizable by this recorder, the data may be erased.

Hooking Up the Recorder

Follow steps 1 to 7 to hook up and adjust the settings of the recorder.

Notes

- Plug cords securely to prevent unwanted noise.
- Refer to the instructions supplied with the components to be connected.
- You cannot connect this recorder to a TV that does not have a SCART or video input jack.
- Be sure to disconnect the mains lead of each component before connecting.

Step 1: Unpacking

Check that you have the following items:

- Audio/video cord (pinplug × 3 ↔ pinplug × 3) (1)
- Mains lead (1)
- Aerial cable (1)
- Remote commander (remote) (1)
- R6 (size AA) batteries (2)

Step 2: Connecting the Aerial Cable

Connect the aerial cable by following the steps below. Do not connect the mains lead until you reach “Step 5: Connecting the Mains Lead” (page 19).

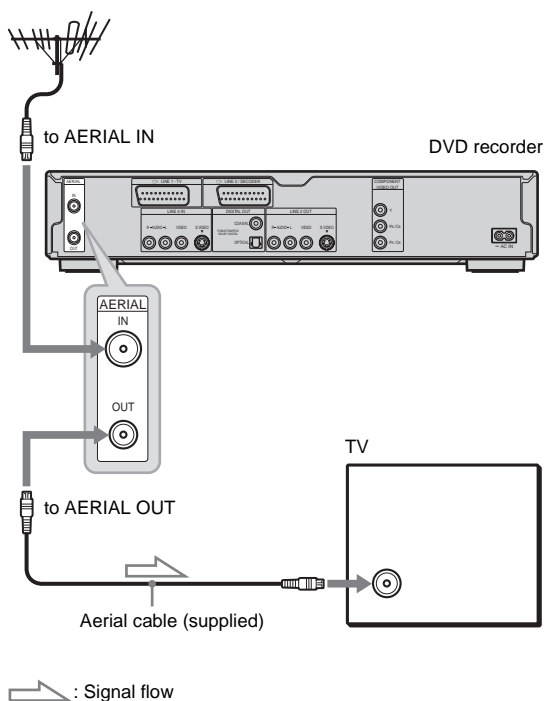

- 1** Disconnect the aerial cable from your TV and connect it to AERIAL IN on the rear panel of the recorder.
- 2** Connect AERIAL OUT of the recorder to the aerial input of your TV, using the supplied aerial cable.

Step 3: Connecting the Video Cords

Select one of the following patterns **A** through **D**, according to the input jack on your TV monitor, projector, or AV amplifier (receiver). This will enable you to view pictures. Audio connections are explained in “Step 4: Connecting the Audio Cords” (page 17).

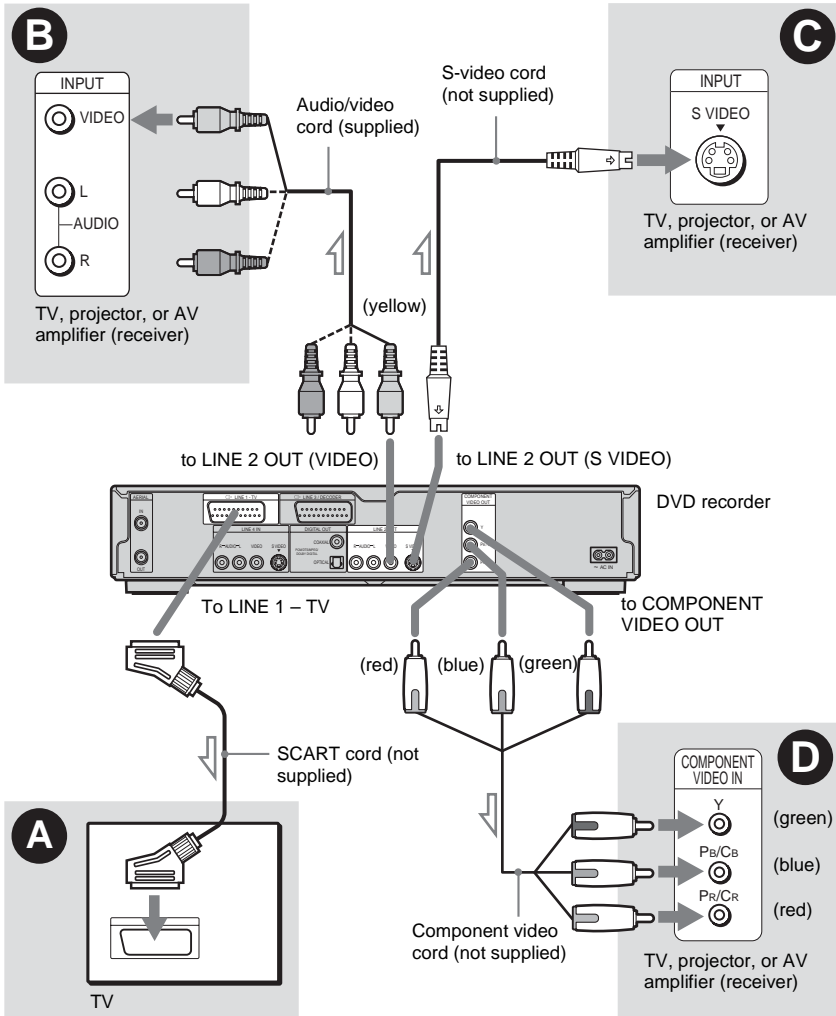

↗ : Signal flow

Note

Do not connect more than one type of video cord between the recorder and your TV at the same time.

A Connecting to a SCART input jack

Connect using a SCART cord (not supplied) to the LINE 1-TV jack and your TV. Be sure to make the connections firmly to avoid hum and noise. See the operating instructions supplied with the TV to be connected. Also, when you set "Line1 Output" to "S Video" or "RGB" in step 15 of Easy Setup (page 22), use a SCART cord that conforms to the selected signal.



If your TV accepts progressive 525p/625p format signals, you must use this connection and set "Component Out" in Video Setup to "On" (page 89). Then press PROGRESSIVE on the remote to send progressive video signals. For details, see "Using the PROGRESSIVE button" (page 16).



B Connecting to a video input jack

Connect the yellow plug of the audio/video cord (supplied) to the yellow (video) jack. You will enjoy standard quality images. Note that you cannot use the PROGRESSIVE button with this connection.



C Connecting to an S VIDEO input jack

Connect using an S-video cord (not supplied). You will enjoy high quality images. Note that you cannot use the PROGRESSIVE button with this connection.



D Connecting to component video input jacks (Y, P_B/C_B, P_R/C_R)

Connect the component via the COMPONENT VIDEO OUT jacks using a component video cord (not supplied) or three video cords (not supplied) of the same kind and length. You will enjoy accurate colour reproduction and high quality images.

When playing "wide screen" images

Some recorded images may not fit your TV screen. To change the aspect ratio, see page 88.

If you are connecting to a VCR

Connect your VCR to the LINE 3/DECODER jack on the recorder (page 26).

Notes

- When you connect the recorder to your TV via the SCART jacks, the TV's input source is set to the recorder automatically when you start playback. If necessary, press TV/DVD on the remote to return the input to the TV.
- For correct SMARTLINK connection, you will need a SCART cord that has the full 21 pins. Refer to your TV's instruction manual as well for this connection.
- If you connect this recorder to a TV with SMARTLINK, set "Line1 Output" to "Video" in step 15 of Easy Setup.

About the SMARTLINK features (for SCART connections only)

If the connected TV (or other connected equipment such as a set top box) complies with SMARTLINK, NexTView Link, MEGALOGIC*¹, EASYLINK*², CINEMALINK*², Q-Link*³, EURO VIEW LINK*⁴, or T-V LINK*⁵, this recorder automatically runs the SMARTLINK function after you complete the connection pattern **A** on page 14 (the SMARTLINK indicator lights up when you turn on your TV). You can enjoy the following SMARTLINK features.

- Preset Download
You can download the tuner preset data from your TV to this recorder, and tune the recorder according to that data in Easy Setup. This greatly simplifies the Easy Setup procedure. Be careful not to disconnect the cables or exit the Easy Setup function during this procedure (page 22).

- **TV Direct Rec**
You can easily record what you are watching on your TV (page 48).
- **One Touch Play**
You can turn on the recorder and TV, set the TV's input to the recorder, and start playback with one touch of the  (play) button (page 55).
- **One Touch Menu**
You can turn on the recorder and TV, set the TV to the recorder's channel, and display the Title List menu with one touch of the **TITLE LIST** button (page 55).
- **One Touch Timer**
You can turn on the recorder and TV, set the TV to the recorder's channel, and display the timer programming menu with one touch of the **TIMER** button on the remote (page 44).
- **Automatic Power Off**
The recorder will turn off automatically if the recorder is not used after you turn off the TV.
- **NexTVView Download**
You can easily set the timer by using the NexTVView Download function on your TV. See your TV's instruction manual.

*1 "MEGALOGIC" is a registered trademark of Grundig Corporation.

*2 "EASYLINK" and "CINEMALINK" are trademarks of Philips Corporation.

*3 "Q-Link" is a trademark of Panasonic Corporation.

*4 "EURO VIEW LINK" is a trademark of Toshiba Corporation.

*5 "T-V LINK" is a trademark of JVC Corporation.

Hint

SMARTLINK also works with TVs or other equipment having EPG Timer Control, EPG Title Download, and Now Recording functions. For details, refer to the operating instructions supplied with your TV or other equipment.

Notes

- The SMARTLINK features are available only when "Video" is selected in "Line1 Output."
- The SMARTLINK features are not available for devices connected via the DVD recorder's LINE 3/DECODER jack.
- Not all TVs respond to the functions above.

Using the PROGRESSIVE button

By using the PROGRESSIVE button on the remote, you can select the signal format in which the recorder outputs video signals: interlace or progressive. Connect the recorder using the COMPONENT VIDEO OUT jacks (pattern  on page 15), and set "Component Out" in Video Setup to "On" (page 89). Then press the PROGRESSIVE button. "PROGRESSIVE" appears in the front panel display when the recorder outputs progressive signals.

◆ **Progressive**

Select this when:

- your TV accepts progressive signals, and,
- the TV is connected to the COMPONENT VIDEO OUT jacks.

Note that the pictures will not be clear or no picture will appear if you select progressive signal output when either of the above conditions is not met.

◆ **Interlace**

Set to this position when:

- your TV does not accept progressive signals, or,
- your TV is connected to jacks other than the COMPONENT VIDEO OUT jacks (LINE OUT (VIDEO) or S VIDEO).

Hint

When you select progressive signal output, you can fine-tune the signal according to the type of software you are watching (page 89).

Note

Consumers should note that not all high definition television sets are fully compatible with this product and may cause artifacts to be displayed in the picture. In the case of 525/625 progressive scan picture problems, it is recommended that the user switch the connection to the 'standard definition' output. If there are questions regarding our TV set compatibility with this model 525p/625p DVD recorder, please contact our customer service centre.

Step 4: Connecting the Audio Cords

Select one of the following patterns **A** or **B**, according to the input jack on your TV monitor, projector, or AV amplifier (receiver).

This will enable you to listen to sound.

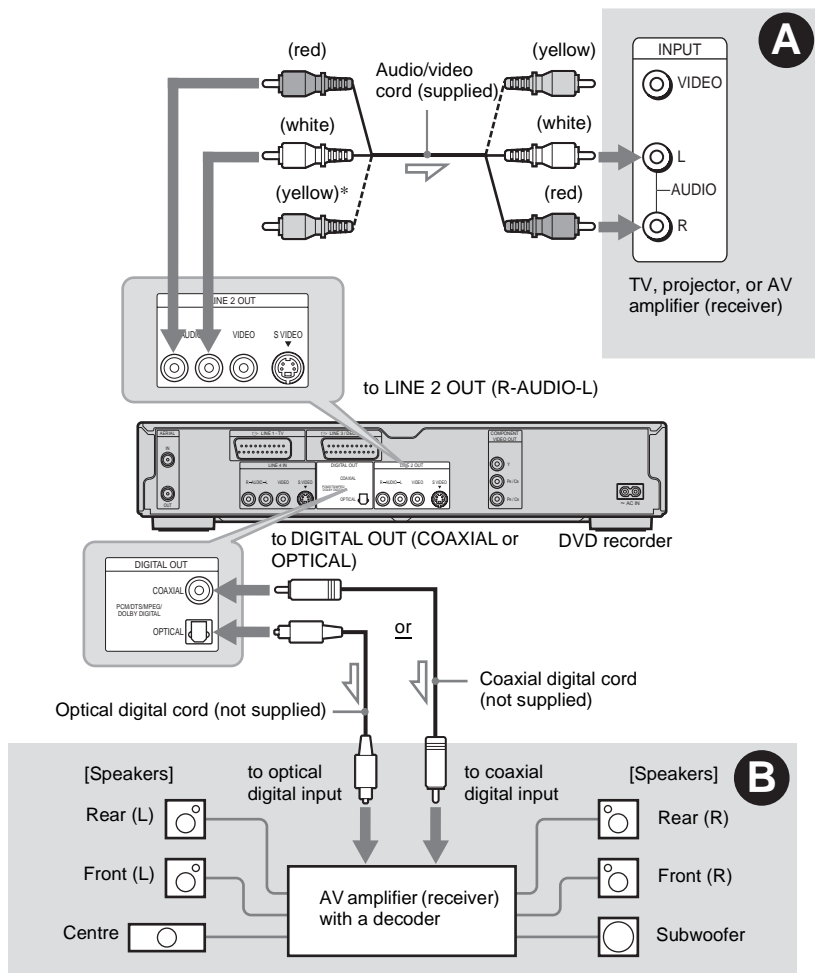

Hint

For correct speaker location, see the operating instructions supplied with the connected components.

Note

Do not connect your TV's audio output jacks to the LINE IN (AUDIO L/R) jacks at the same time. This will cause unwanted noise to come from your TV's speakers.

A Connecting to audio L/R input jacks

This connection will use your TV's or stereo amplifier's (receiver's) two speakers for sound. Connect using the audio/video cord (supplied).



- Surround effect (page 56)
TV: Dynamic, Wide, Night



Stereo amplifier (receiver): Standard, Night

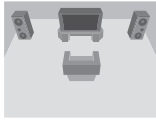

Note

Do not connect the LINE 4 IN (R-AUDIO-L) and LINE 2 OUT (R-AUDIO-L) jacks to your TV's audio output jacks at the same time. This will cause unwanted noise to come from your TV's speakers.

B Connecting to a digital audio input jack

If your AV amplifier (receiver) has a Dolby*¹ Digital, DTS*², or MPEG audio decoder and a digital input jack, use this connection.

Connect using a coaxial or optical digital cord (not supplied).

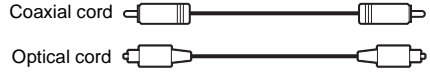

- Surround effect
Dolby Digital (5.1ch), DTS (5.1ch), MPEG audio (5.1ch)

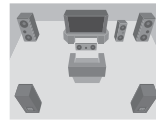

*¹ Manufactured under license from Dolby Laboratories. "Dolby," "Pro Logic," and the double-D symbol are trademarks of Dolby Laboratories.

*² "DTS" and "DTS Digital Out" are trademarks of Digital Theater Systems, Inc.

Notes

- After you have completed connection B, make the appropriate settings under "Audio Connection" in Easy Setup (page 22). If your AV amplifier (receiver) has an MPEG audio decoder function, set "MPEG" to "MPEG" in Audio Setup (page 92). Otherwise, no sound or a loud noise will come from your speakers.
- The surround sound effects of this recorder cannot be used with connection B.

Step 5: Connecting the Mains Lead

Connect the supplied mains lead to the AC IN terminal of the recorder. Then plug the recorder and TV mains leads (power cords) into the mains. After you connect the mains lead, **you must wait for a short while before operating the recorder.** You can operate the recorder once the front panel display lights up and the recorder enters standby mode.

If you connect additional equipment to this recorder (page 26), be sure to connect the mains lead after all connections are complete.

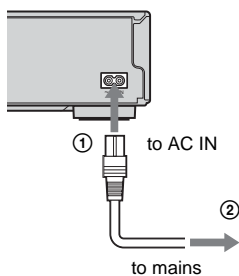

Step 6: Preparing the Remote

You can control the recorder using the supplied remote. Insert two R6 (size AA) batteries by matching the ⊕ and ⊖ ends on the batteries to the markings inside the battery compartment. When using the remote, point it at the remote sensor  on the recorder.

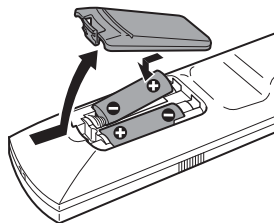

Notes

- If the supplied remote interferes your other Sony DVD recorder or player, change the command mode number for this recorder (page 21).
- Use the batteries correctly to avoid possible leakage and corrosion. Do not touch the liquid with bare hands should leakage occur. Observe the following:
 - Do not use a new battery with an old battery, or batteries of different manufacturers.
 - Do not attempt to recharge the batteries.
 - If you do not intend to use the remote for an extended period of time, remove the batteries.
 - If battery leakage occurs, wipe out any liquid inside the battery compartment, and insert new batteries.
- Do not expose the remote sensor (marked  on the front panel) to strong light, such as direct sunlight or lighting apparatus. The recorder may not respond to the remote.

Controlling TVs with the remote

You can adjust the remote's signal to control your TV.

If you connected the recorder to an AV amplifier (receiver), you can use the supplied remote to control the AV amplifier's (receiver's) volume.

Notes

- Depending on the connected unit, you may not be able to control your TV or AV amplifier (receiver) with some or all of the buttons below.
- If you enter a new code number, the code number previously entered will be erased.
- When you replace the batteries of the remote, the code number may be reset to the default setting. Set the appropriate code number again.

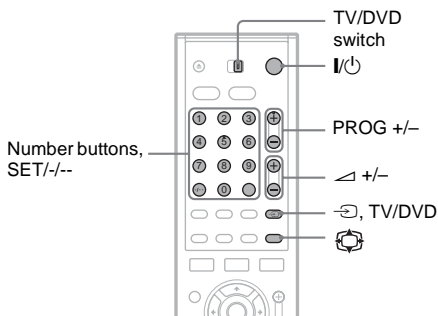

- 1 Slide the TV/DVD switch to TV.
- 2 Hold down I/O.
- 3 Enter your TV's manufacturer code (see "Code numbers of controllable TVs" below) using the number buttons.
- 4 Release I/O.

When the TV/DVD switch is set to TV, the remote performs the following:

I/O	Turns your TV on or off
∧ (volume) +/-	Adjusts the volume of your TV
PROG +/-	Selects the programme position on your TV
⊞ (wide mode)	Switches to or from the wide mode of a Sony wide-screen TV
↶ (TV/video)	Switches your TV's input source

Number buttons and SET, -/-*	Selects the programme position on your TV
------------------------------	---

* If you use the number buttons to select the TV's programme position, press -/- followed by the number buttons for two-digit numbers.

To operate the TV/DVD button (for SCART connections only)

The TV/DVD button switches between the recorder and the last input source selected on the TV. Point your remote at the recorder when using this button. The button works even if the TV/DVD switch is set to DVD.

When you connect the recorder to the TV via the SCART jacks, the input source for the TV is set to the recorder automatically when you start playback. To watch another source, press the TV/DVD button to switch the TV's input source.

Code numbers of controllable TVs

If more than one code number is listed, try entering them one at a time until you find the one that works with your TV.

Manufacturer	Code number
Sony	01 (default)
Aiwa	01 (default)
Grundig	11
Hitachi	23, 24, 72
Loewe	06, 45
Nokia	15, 16, 69, 73
Panasonic	17, 49
Philips	06, 07, 08, 23, 45, 72
Saba	12, 13, 36, 43, 74, 75
Samsung	06, 22, 23, 71, 72
Sanyo	25
Sharp	29
Telefunken	12, 13, 36, 43, 74, 75
Thomson	12, 13, 43, 74, 75
Toshiba	38
LG	06
JVC	33

Controlling the volume of your AV amplifier (receiver) with the remote

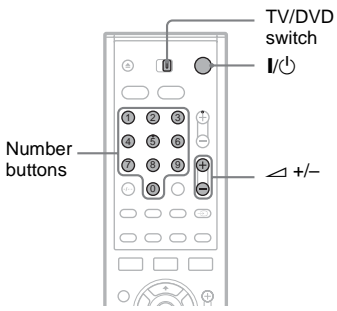

- 1 Slide the TV/DVD switch to DVD.
- 2 Hold down I/⏻, and enter the manufacturer code (see the table below) for your AV amplifier (receiver) using the number buttons.
- 3 Release I/⏻.

The \triangleleft (volume) +/- buttons control the AV amplifier's volume.
 If you want to control the TV's volume, slide the TV/DVD switch to TV.

Hint

If you want to control the TV's volume even when the TV/DVD switch is set to DVD, repeat the steps above and enter the code number 90 (default).

Code numbers of controllable AV amplifiers (receivers)

If more than one code number is listed, try entering them one at a time until you find the one that works with your AV amplifier (receiver).

Manufacturer	Code number
Sony	78, 79, 80, 91
Denon	84, 85, 86
Kenwood	92, 93
Onkyo	81, 82, 83
Pioneer	99
Sansui	87
Technics	97, 98
Yamaha	94, 95, 96

If you have a Sony DVD player or more than one Sony DVD recorder

If the supplied remote interferes with your other Sony DVD recorder or player, set the command mode number for this recorder and the supplied remote to one that differs from the other Sony DVD recorder or player.

The default command mode setting for this recorder and the supplied remote is DVD3.

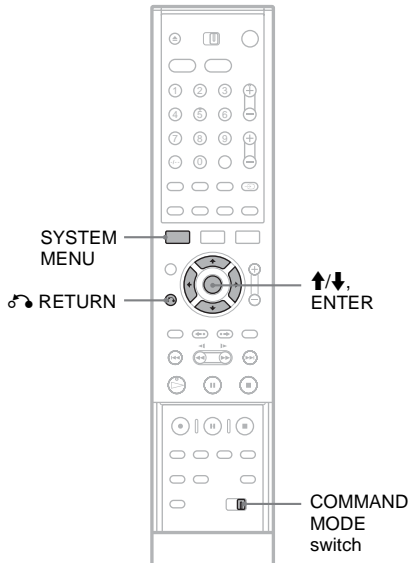

- 1 Press SYSTEM MENU.
The System Menu appears.
- 2 Select "SETUP," and press ENTER.

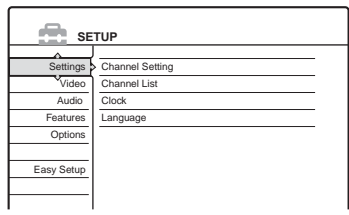

- 3 Select "Options," and press ENTER.

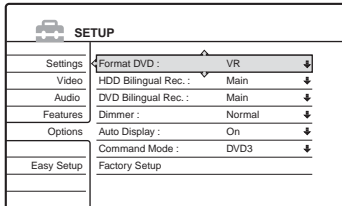

- 4 Select "Command Mode," and press ENTER.

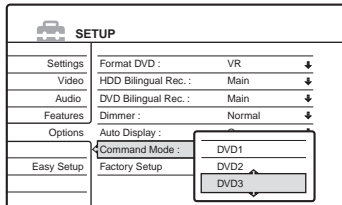

- 5 Select the Command mode (DVD1, DVD2, or DVD3), and press ENTER.

- 6 Slide the COMMAND MODE switch on the remote so it matches the mode you selected above.

To return to the previous step
Press RETURN.

Step 7: Easy Setup

Follow the steps below to make the minimum number of basic adjustments for using the recorder. If you do not complete Easy Setup, it will appear each time you turn on your recorder. Settings are made in the following order.

OSD Language Setup



Tuner and Channel Setup



Clock Setup



TV Type Setup



Video Connection Setup



Audio Connection Setup



Finished!

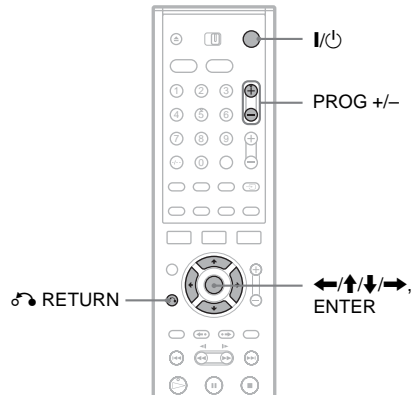

- 1 Turn on the TV.
- 2 Press I/Power.
The recorder turns on.

3 Switch the input selector on your TV so that the signal from the recorder appears on your TV screen.

“Initial settings necessary to operate the DVD recorder will be made. You can change them later using Setup. Before you start, check that you have made all necessary connections.” appears.

- If this message does not appear, select “Easy Setup” from “SETUP” in the System Menu to run Easy Setup. For details, see “Settings and Adjustments” (page 83).

4 Press ENTER.

The Setup Display for selecting the language used in the on-screen display appears.

5 Select a language.

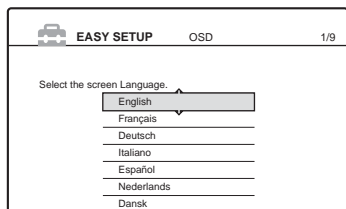

6 Press ENTER.

The Setup Display for selecting your country and language for the tuner system appears. The channel order will be set according to the country or language you select.

7 Select your country or language.

- If you live in a French speaking country that is not listed on the display, select “ELSE.”

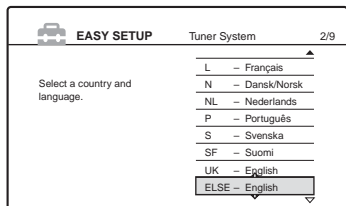

8 Press ENTER.

- If you made connection **A** (page 14) and the connected TV complies with SMARTLINK, the Preset Download function automatically starts.

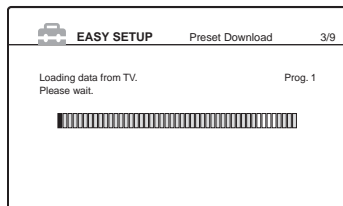

- If the Preset Download function does not work or if you made a connection other than **A**, the Auto Tuner Preset function automatically starts searching for all of the receivable channels and presets them.

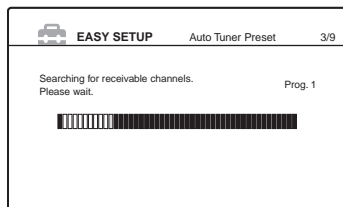

To set the channels manually, see page 84.

9 After the download or search is complete, the Clock function automatically starts.

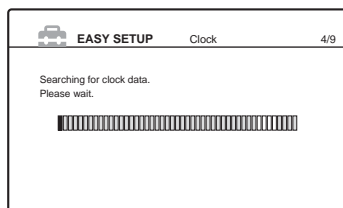

Once the clock signal is received, the Setup Display for selecting the aspect ratio of the connected TV appears.

- If the current time or date is not set, the display for setting the clock manually appears. Set the clock manually using **←/↑/↓/→**, and press ENTER.

10Select the setting that matches your TV type.

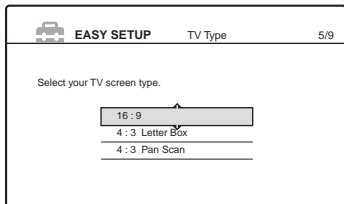

“16:9”: For wide-screen TVs or standard TVs with a wide screen mode.

“4:3 Letter Box”: For standard TVs.

Displays “wide screen” pictures with bands on the upper and lower sections of the screen.

“4:3 Pan Scan”: For standard TVs.

Automatically displays “wide screen” pictures on the entire screen and cuts off the sections that do not fit.

For details, see “TV Type” on page 88.

11Press ENTER.

The Setup Display for the component out jacks appears.

12Select an option.

Select “On” if you are using the COMPONENT VIDEO OUT jacks.

Otherwise, select “Off.”

13Press ENTER.

The Setup Display for the LINE 3/DECODER jack appears.

14Select an option.

Select “Yes” if you will connect a decoder to the LINE 3/DECODER jack. Otherwise, select “No.”

15Press ENTER.

The Setup Display for selecting the type of video signal output from the LINE 1-TV jack appears.

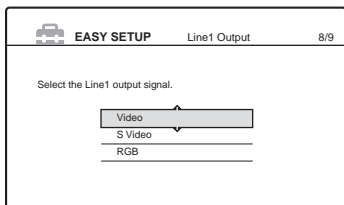

16Select the type of signal you want to output from the LINE1-TV jack.

“Video”: Outputs video signals.

“S Video”: Outputs S video signals.

“RGB”: Outputs RGB signals.

Note that if you select “On” in step 12, you cannot select “RGB,” and that if you select “Yes” in step 14, you cannot select “S Video.”

- If you select “S Video” or “RGB,” SMARTLINK will be deactivated.

17Press ENTER.

The Setup Display for selecting the type of jack used to connect to your amplifier (receiver) appears.

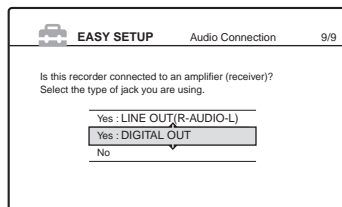

18Select the type of jack (if any) you are using to connect to an amplifier (receiver), and press ENTER.

If you did not connect an AV amplifier (receiver), select “No,” then go to step 22.

If you connected an AV amplifier (receiver) using just an audio cord, select “Yes: LINE OUT (R-AUDIO-L),” then go to step 22.

If you connected an AV amplifier (receiver) using either a digital optical or coaxial cord, select “Yes: DIGITAL OUT.”

19Select the type of Dolby Digital signal you wish to send to your amplifier (receiver).

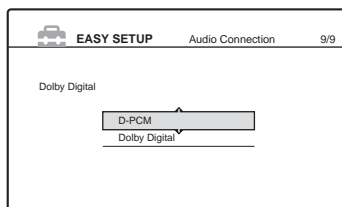

If your AV amplifier (receiver) has a Dolby Digital decoder, select “Dolby Digital.”

Otherwise, select “D-PCM.”

20 Press ENTER.

The Setup Display for the DTS signal appears.

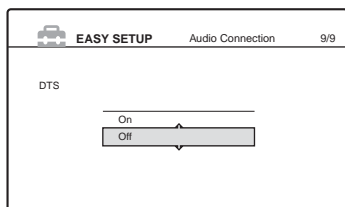

21 Select whether or not you wish to send a DTS signal to your amplifier (receiver), and press ENTER.

If your AV amplifier (receiver) has a DTS decoder, select "On." Otherwise, select "Off."

22 Press ENTER when "Finish" appears.

Easy Setup is finished. All connections and setup operations are complete.

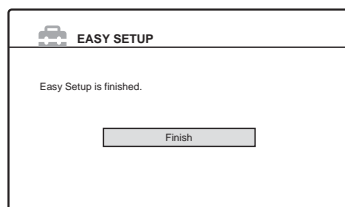

To return to the previous step

Press  RETURN.

Hints

- If your AV amplifier (receiver) has an MPEG audio decoder, set "MPEG" to "MPEG" (page 92).
- If you want to run Easy Setup again, select "Easy Setup" in the Setup Display (page 98).

Note

To record TV programmes using the timer, you must set the clock accurately.

Connecting a VCR or Similar Device

After disconnecting the recorder's mains lead from the mains, connect a VCR or similar recording device to the LINE IN jacks of this recorder.

Use the DV IN jack on the front panel if the equipment has a DV output jack (i.LINK jack) (page 77). See also the instruction manual supplied with the connected equipment.

To record on this recorder, see "Recording From Connected Equipment Without a Timer" (page 52).

Connecting to the LINE 3 jack

Connect a VCR or similar recording device to the LINE 3/DECODER jack of this recorder.

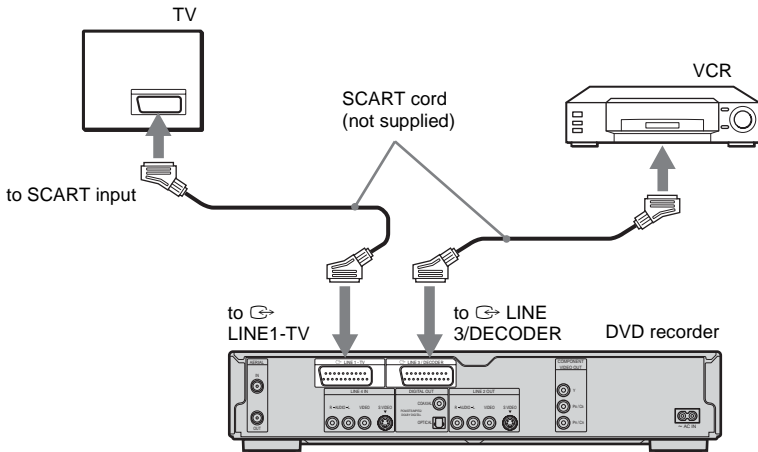

Notes

- Pictures containing copy protection signals that prohibit any copying cannot be recorded.
- If you pass the recorder signals via the VCR, you may not receive a clear image on your TV screen.

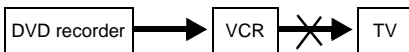

Be sure to connect your VCR to the DVD recorder and your TV in the order shown below. To watch video tapes, watch the tapes through a second line input on your TV.

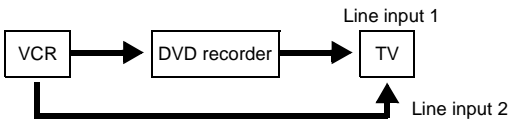

- The SMARTLINK features are not available for devices connected via the DVD recorder's LINE 3/DECODER jack.
- When you record to a VCR from this DVD recorder, do not switch the input source to TV by pressing the TV/DVD button on the remote.
- If you disconnect the recorder's mains lead, you will not be able to view the signals from the connected VCR.

Connecting to the LINE 2 IN or LINE 4 IN jacks

Connect a VCR or similar recording device to the LINE 2 IN or LINE 4 IN jacks of this recorder. If the equipment has an S-video jack, you can use an S-video cord instead of an audio/video cord.

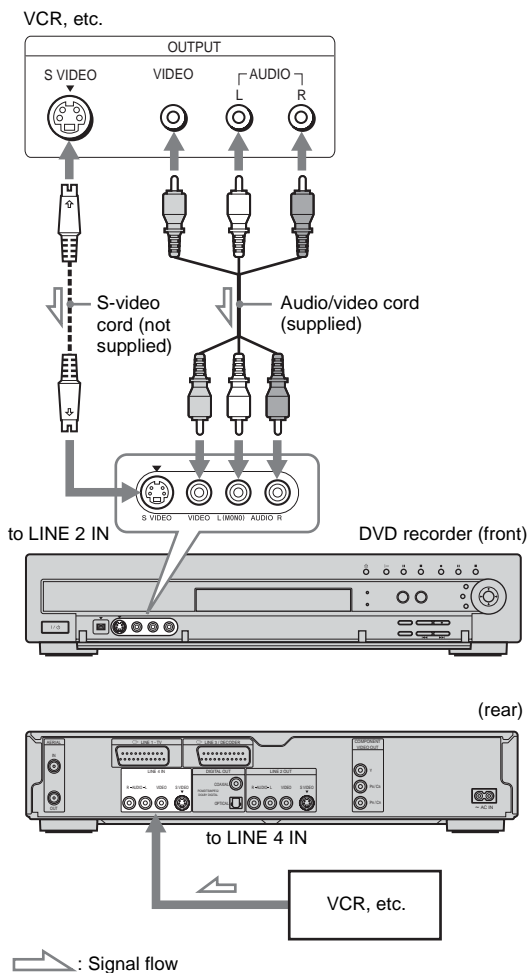

Hint

When the connected equipment outputs only monaural sound, use audio cables that distribute monaural sounds to left/right channels (not supplied).

Notes

- Do not connect the yellow LINE IN (VIDEO) jack when using an S-video cord.
- Do not connect the output jack of this recorder to another equipment's input jack with the other equipment's output jack connected to the input jack of this recorder. Noise (feedback) may result.
- Do not connect more than one type of video cord between the recorder and your TV at the same time.

Connecting to a Satellite or Digital Tuner

Connect a satellite or digital tuner to this recorder using the LINE 3/DECODER jack. Disconnect the recorder's mains lead from the mains when connecting the tuner.

To use the Synchro-Rec function, see below.

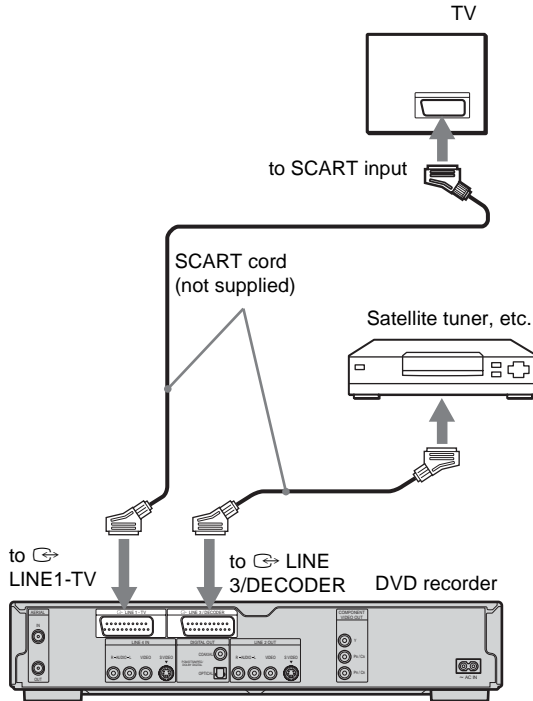

If the satellite tuner can output RGB signals

This recorder accepts RGB signals. If the satellite tuner can output RGB signals, connect the TV SCART connector on the satellite tuner to the LINE 3/DECODER jack, and set "Line3 Input" of "Scart Setting" to "Video/RGB" in Video Setup (page 90). Note that this connection and setup disable the SMARTLINK function. If you want to use the SMARTLINK function with a compatible set top box, see the instructions supplied with the set top box.

If you want to use the Synchro Rec function

This connection is necessary to use the Synchronized Recording function. See "Recording From Connected Equipment With a Timer (Synchro Rec)" (page 51).

Set "Line3 Input" of "Scart Setting" in Video Setup (page 90) according to the specifications of your satellite tuner. See your satellite tuner's instructions for more information.

If you are using a B Sky B tuner, be sure to connect the tuner's VCR SCART jack to the LINE 3/DECODER jack. Then set "Line3 Input" of "Scart Setting" according to the specifications of the VCR SCART jack on your satellite tuner.

Notes

- Do not set "Line3 Input" of "Scart Setting" in Video Setup to "Decoder."
- Synchronized Recording does not work with some tuners. For details, see the tuner's operating instructions.
- If you disconnect the recorder's mains lead, you will not be able to view the signals from the connected tuner.

Connecting a PAY-TV/Canal Plus Decoder

You can watch or record PAY-TV/Canal Plus programmes if you connect a decoder (not supplied) to the recorder. Disconnect the recorder's mains lead from the mains when connecting the decoder.

Connecting a decoder

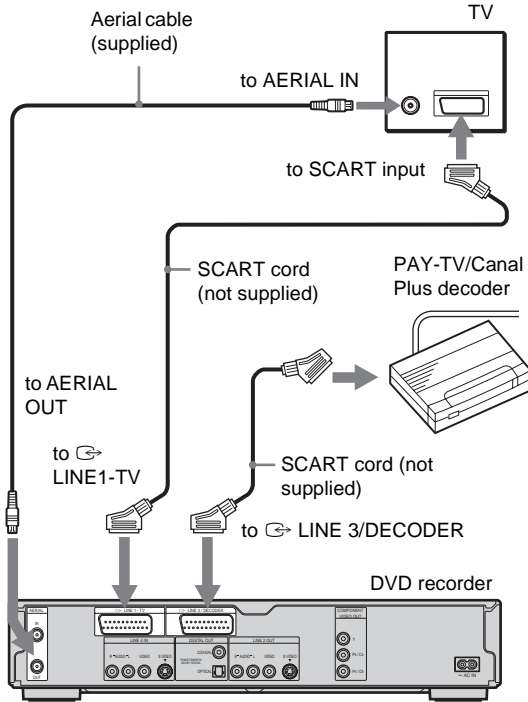

Setting PAY-TV/Canal Plus channels

To watch or record PAY-TV/Canal Plus programmes, set your recorder to receive the channels using the on-screen display.

In order to set the channels correctly, be sure to follow all of the steps below.

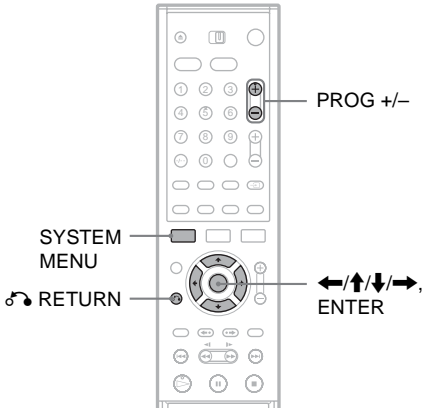

- 1 Press **SYSTEM MENU**.
The System Menu appears.
- 2 Select **"SETUP,"** and press **ENTER**.

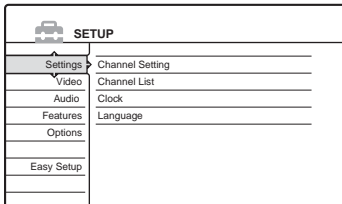

- 3 Select **"Video,"** and press **ENTER**.

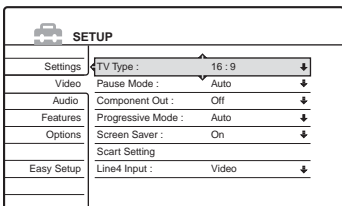

- 4 Select **"Scart Setting,"** and press **ENTER**.

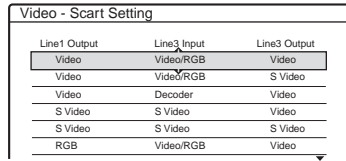

- 5 Press **↑/↓** to select **"Video"** or **"RGB"** for **"Line1 Output,"** **"Decoder"** for **"Line3 Input,"** and **"Video"** for **"Line3 Output,"** and press **ENTER**.

The Video Setup display appears again.

- 6 Press **↶** **RETURN** to return the cursor to the left column.

- 7 Select **"Settings,"** and press **ENTER**.

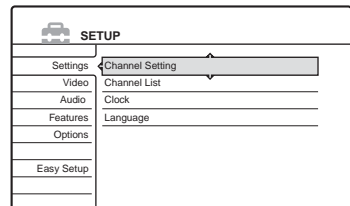

- 8 Select **"Channel Setting,"** and press **ENTER**.

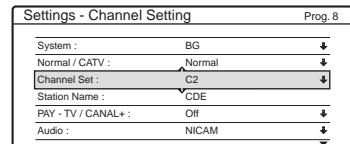

- 9 Press **PROG +/-** to select the desired programme position.

Select programme position

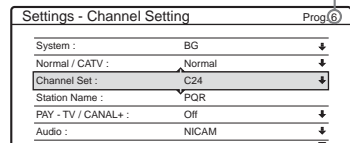

10 Select "System," and press ENTER.

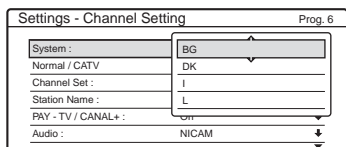

To return to the previous step

Press **↶** RETURN.

Notes

- When you set "Line3 Input" to "Decoder" in step 5 above, you will not be able to select "L3" because Line 3 will become a dedicated line for the decoder.
- If you disconnect the recorder's mains lead, you will not be able to view the signals from the connected decoder.

11 Press **↑/↓** to select an available TV system, BG, DK, I, or L, and press ENTER.
To receive broadcasts in France, select "L."

12 Select "Normal/CATV," and press ENTER.

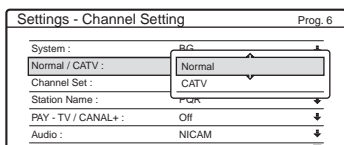

13 Select "Normal," and press ENTER.

To preset CATV (Cable Television) channels, select "CATV."

14 Select "Channel Set," and press ENTER.

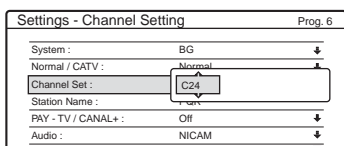

15 Select the PAY-TV/Canal Plus channel, and press ENTER.

16 Select "PAY-TV/CANAL+," and press ENTER.

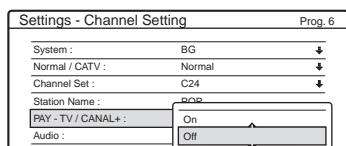

17 Select "On," and press ENTER.

Using the On-Screen Menus



This section introduces the System Menu, TOOLS menu, and sub-menu. By using these displays, you can perform most of the recorder's operations.

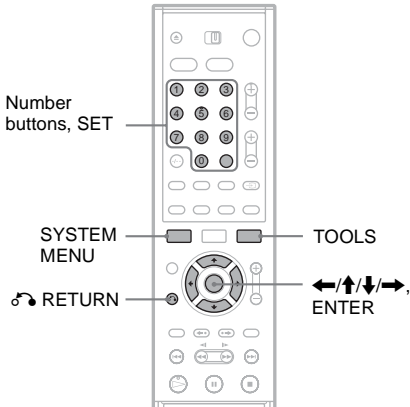

- 2 **TIMER** (page 42):
Allows you to set a new timer recording setting.
- 3 **TIMER LIST** (page 46):
Turns on the Timer List menu, which allows you to check, change, or cancel timer settings.
- 4 **DV EDIT** (page 77):
Activates the DV Edit function, which allows you to record and edit the contents of a DV format tape.
- 5 **DUBBING** (page 72):
Dubs titles from the HDD to a DVD and vice versa. Select the dubbing direction before dubbing.
- 6 **SETUP** (page 83):
Turns on the Setup Display, which allows you to set up the recorder to suit your preferences.

Sub-menu

The sub-menu appears when you select an item from a list menu (e.g. a title from the Title List menu), and press ENTER. The sub-menu displays options applicable only to the selected item. The displayed options differ depending on the situation and disc type. Select an option by pressing \uparrow/\downarrow and ENTER.

System Menu

The System Menu appears when you press SYSTEM MENU, and provides entries to all of the recorder's main functions, such as timer recording and setup.

Select an option by pressing \uparrow/\downarrow and ENTER.

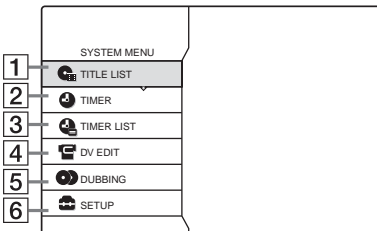

Example: The Title List menu

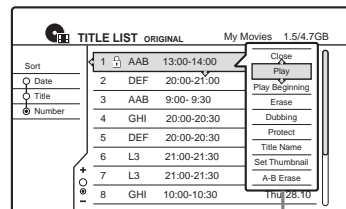

Options for the selected item

- 1 **TITLE LIST** (page 33):
Turns on the Title List menu, which shows recorded titles on the disc.

TOOLS

The TOOLS menu appears when you press TOOLS, and displays options applicable to the entire disc (e.g. disc protection), recorder (e.g. audio settings during recording), or multiple items on a list menu (e.g. erasing multiple titles). The displayed options differ depending on the situation and disc type.

Select the option by pressing **↑/↓** and **ENTER**.

Example 1: When you press TOOLS while the Title List menu is turned on.

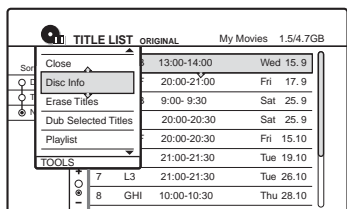

Options for the disc or menu

Example 2: When you press TOOLS while a DVD-RW (VR mode) is playing.

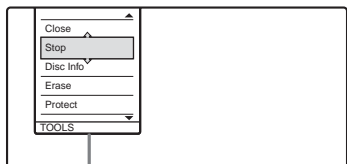

Options for the disc or picture

To return to the previous display

Press **↶** RETURN.

Using the Title List

HDD **+RW** **-RW/VR** **-RW/Video** **+R** **-R**

The title of programmes recorded on a disc is displayed in the Title List.

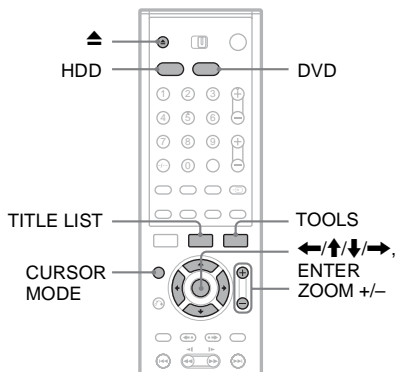

1 Press HDD or DVD.

If you select DVD, press **▲** (open/close) and place a DVD on the disc tray. Press **▲** again to close the disc tray.

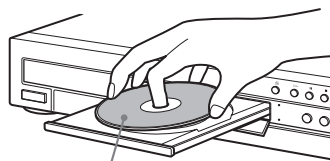

With the recording side facing down

Wait until "LOAD" disappears from the front panel display.

2 Press TITLE LIST.

To show the list in greater detail (zoom), press **ZOOM+**.

Standard Title List (Example: DVD-RW in VR mode)

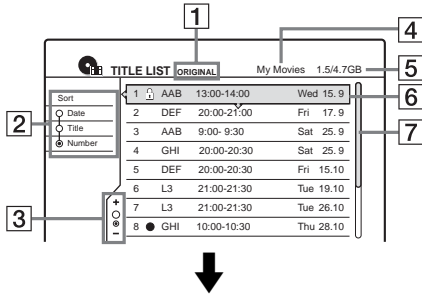

“Zoomed” Title List

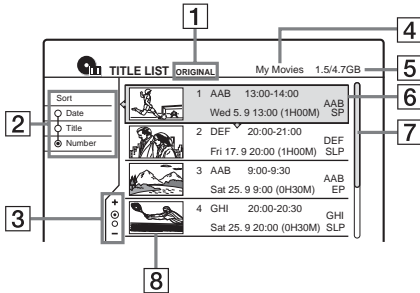

1 Disc type:

Displays a media type, HDD or DVD. Also displays the title type (Original or Playlist) for DVD-RWs (VR mode).

2 Sort buttons:

Sorts the title order (see below).

3 Zooming indicator:

Shows the current zoom status.

4 Disc name (DVD only) (page 36)

5 Disc space (remainder/total)

6 Title information:

Displays the title number, title name, and recording date.

● (red): Indicates that the title is currently being recorded.

● (blue): Indicates that the title is currently being dubbed.

⏏: Indicates the protected title.

“NEW” (or N): Indicates that the title is newly recorded (not played back) (HDD only).

⏏: Indicates that the Update function is set (HDD only) (page 42).

7 Scroll bar:

Appears when all of the titles do not fit on the list. To view the hidden titles, press \uparrow/\downarrow .

8 Title’s thumbnail picture

To scroll the list display by page (Page mode)

Press CURSOR MODE while the list display is turned on. The display enters Page mode. Each time you press \uparrow/\downarrow , the entire Title List changes to the next/previous page of titles.

To return to the Cursor mode, press CURSOR MODE again.

About the Title List for DVD-RWs (VR mode)

You can switch the Title List to show Original or Playlist.

While the Title List menu is turned on, press TOOLS and select either “Original” or “Playlist,” and press ENTER. “PLAYLIST” appears on the front panel display when “Playlist” is selected.

For details, see “Edit options for DVD-RWs (VR mode)” (page 64).

To change the title order (Sort)

Press \leftarrow while the Title List menu is turned on to move the cursor to the Sort column. Press \uparrow/\downarrow to select the item, and press ENTER.

Order	Sorted
New (HDD only)	in order of when the titles were recorded. The title that is recorded most recently and not played back is listed at the top.
Date	in order of when the titles were recorded. The title that is recorded most recently is listed at the top.
Title	in alphabetical order.
Number	in order of recorded title number.

To change a title thumbnail picture (Thumbnail) (HDD/DVD-RW in VR mode only)

You can select a favourite scene for the thumbnail picture shown in the Title List menu.

- 1 Press TITLE LIST while a disc is in the recorder and press ZOOM+.
- 2 Select a title whose thumbnail picture you want to change, and press ENTER.
- 3 Select “Set Thumbnail” from the sub-menu, and press ENTER.
The selected title starts to play in the background.

- 4 While watching the playback picture, press \triangleright , \parallel , or $\llbracket/\triangleright$ to select the scene you want to set for a thumbnail picture, and press ENTER.
The scene is set for the title's thumbnail picture.

To turn off the Title List

Press TITLE LIST.

Hint

After recording, the first scene of the recording (the title) is automatically set as the thumbnail picture.

Notes

- The Title List may not appear for DVDs created on other DVD recorders.
- The letters that cannot be displayed are replaced with “*.”
- Title thumbnail pictures are displayed only on this recorder.
- It may take a few seconds for the thumbnail pictures to be displayed.
- After editing, the title thumbnail picture may change to the first scene of the recording (title).
- After dubbing, the title thumbnail picture set on the source recording is cancelled.

Using the “Disc Info” Screen (disc settings)

HDD +RW -RWVR -RWVideo +R -R

With the Disc Information display, you can check the disc type and remaining disc space. Also, you can perform operations such as formatting and finalizing (page 36).

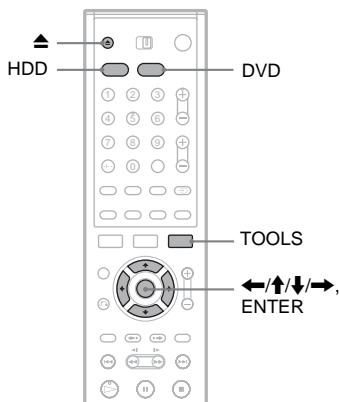

1 Press HDD or DVD.

If you select a DVD, press \blacktriangle (open/close) and place a DVD on the disc tray. Press \blacktriangle again to close the disc tray.

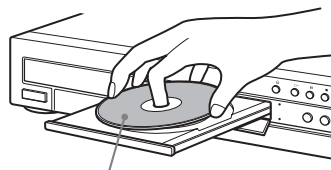

With the recording side facing down

Wait until “LOAD” disappears from the front panel display.

2 Press TOOLS.

The TOOLS menu appears.

3 Select “Disc Info,” and press ENTER.

Items in the display differ depending on the disc type or recording format.

Example: DVD-RW (VR mode)

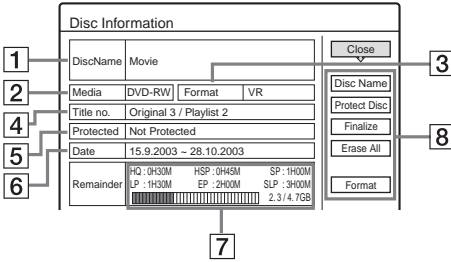

- 1 “Disc Name” (DVD only)
- 2 “Media”: Disc type
- 3 “Format”: Recording format type (DVD-RW only)
- 4 “Title no.”: Total number of titles
- 5 “Protected”: Indicates whether protection is set (DVD-RW in VR mode only)
- 6 “Date”: Dates of when the oldest and the most recent titles were recorded (DVD only)
- 7 “Continuous Rem. Time”/“Remainder” (approximate)
 - The longest continuous recording time in each of the recording modes
 - Disc space bar
 - Remaining disc space/total disc space
- 8 Disc setting buttons (page 36)
 - “Disc Name”
 - “Protect Disc”
 - “Finalize”/“Unfinalize”
 - “Erase All”
 - “Format”
 Available settings differ depending on the disc type.

Hint

For DVD+RWs and DVD-RWs (Video mode), you can check free space and title location on the disc using the Disc Map display (page 67).

Note

On this model, 1 GB (read “gigabyte”) is equivalent to 1 billion bytes. The larger the number, the larger the disc space.

Labelling, protecting, or formatting a disc

HDD **+RW** **-RWVR** **-RWVideo** **+R** **-R**

You can execute options effective for the entire disc using the Disc Information display.

1 Press **TOOLS** while the disc is in the recorder.

The **TOOLS** menu appears.

2 Select “Disc Info,” and press **ENTER**.

Example: When the inserted disc is a DVD-RW (VR mode).

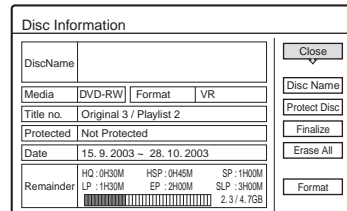

3 Select an option, and press **ENTER**.

“Disc Name” (DVD only): Labels a DVD.

Enter the disc name in the “Input Disc Name” display (page 40).

“Protect Disc” (DVD-RW in VR mode only): Protects all titles on the disc. To cancel the protection, select “Don’t Protect.”

“Erase All” (HDD/DVD+RW/DVD-RW only): Erases all titles on the disc (except the protected titles).

“Format” (HDD/DVD+RW/DVD-RW only): Erases all contents of the disc to make a blank disc. For DVD-RWs, select a recording format (VR or Video) according to your needs.

Hints

- You can set protection for individual titles (page 65).
- By reformatting, you can change the recording format on DVD-RWs, or record again on DVD-RWs (Video mode) that have been finalized.

Note

You can enter up to 64 characters for a DVD’s disc name. The disc name may not appear when the disc is played on other DVD equipment.

Finalizing a DVD (preparing a disc for playback on other equipment)

+RW **-RWVR** **-RW_{video}** **+R** **-R**

Finalizing is necessary when you play discs recorded with this recorder on other DVD equipment.

When you finalize a DVD+RW, DVD-RW (Video mode), DVD+R, or DVD-R, a DVD menu will be automatically created, which can be displayed on other DVD equipment.

Before finalizing, check the differences between the disc types in the table below.

Differences between the disc types

+RW Discs are automatically finalized when removed from the recorder. However, you may need to finalize the disc for certain DVD equipment, or if the recording time is short. You can edit or record on the disc even after finalizing.

-RWVR Finalizing is unnecessary when playing a disc on VR format compatible equipment. Even if your other DVD equipment is VR format compatible, you may need to finalize the disc, especially if the recording time is short. You can edit or record on the disc even after finalizing.

-RW_{video} Finalizing is necessary when playing on any equipment other than this recorder. After finalizing, you cannot edit or record on the disc. If you want to record on it again, reformat the disc (page 36). However, all recorded contents will be erased.

+R Finalizing is necessary when playing on any equipment other than this recorder.
-R After finalizing, you cannot edit or record on the disc.

1 Press **TOOLS** while the disc is in the recorder.

The **TOOLS** menu appears.

2 Select **"Disc Info,"** and press **ENTER**.

The Disc Information display appears.

3 Select **"Finalize,"** and press **ENTER**.

The display shows the approximate time required for finalizing and asks for confirmation.

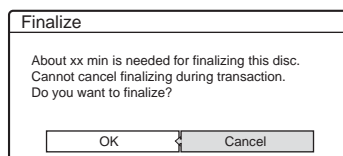

4 Select **"OK,"** and press **ENTER**.

The recorder starts finalizing the disc.

To unfinalize a DVD-RW (VR mode)

If you cannot record or edit on a DVD-RW (VR mode) that has been finalized with other DVD equipment (a message appears), unfinalize the disc by selecting "Unfinalize" in step 3 above.

Hint

You can check whether the disc has been finalized or not. If you cannot select "Finalize" in step 3 above, the disc has already been finalized.

Notes

- Depending on the condition of the disc, recording, or the DVD equipment, discs may not play even if the discs are finalized.
- The recorder may not be able to finalize the disc if it was recorded on another recorder.

Checking the Play Information and Playing Time



You can check the playing time and remaining time of the current title, chapter, or track. Also, you can check the disc name recorded on the DVD/CD.

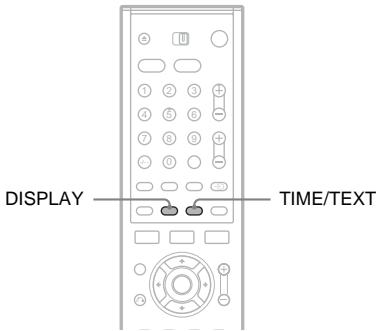

Press DISPLAY repeatedly.

Each time you press the button, the display changes as follows:

Title/track information (Display 1)



Play mode/time information (Display 2)



(Display off)

The displays differ depending on the disc type or playing status.

◆ Display 1

Example: When playing a DVD VIDEO

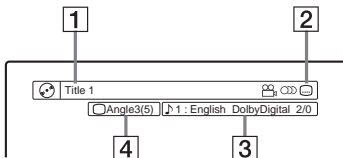

- 1 Title number/name
(Track number for CDs/VIDEO CDs without PBC, scene number for VIDEO CDs with PBC, track number/name for DATA CDs)

- 2 Available functions for DVD VIDEOS (angle/audio/subtitle, etc.)
- 3 The current selected function or audio setting (appears only temporarily)
- 4 The current selected angle

Example: Dolby Digital 5.1 ch

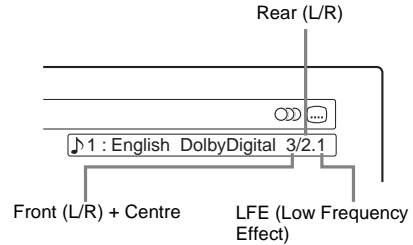

◆ Display 2

Example: When playing a DVD-RW (VR mode)

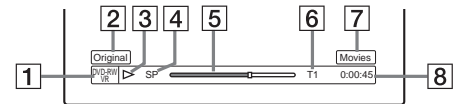

- 1 Disc type*²/format (page 8)
- 2 Title type (Original or Playlist) (page 64)
- 3 Play mode
- 4 Recording mode (page 41)
- 5 Playing status bar*³
- 6 Title number (chapter number*¹) (page 61)
(Track number for CDs/VIDEO CDs without PBC, scene number for VIDEO CDs with PBC, track number (album number*¹) for DATA CDs)
- 7 CD text (album name) appears when text is recorded on a CD.
- 8 Playing time (remaining time*¹)

*¹ Displayed when you press TIME/TEXT repeatedly.
*² Displays Super VCDs as "SVCD," DATA CDs as "CD."
*³ Does not appear with VIDEO CDs, and DATA CDs.

Hints

- If “DTS” is set to “Off” in Audio Setup, the DTS track selection option will not appear on the screen even if the disc contains DTS tracks (page 92).
- When “Auto Display” is set to “On” (default) in Options Setup (page 97), playback information automatically appears when the recorder is turned on, etc.

Notes

- The recorder can only display the first level of a CD’s text, such as the disc name.
- The letters or symbols that cannot be displayed are replaced with “*.”

Example: When playing a CD

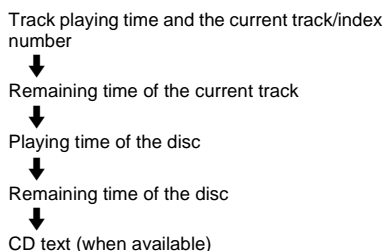

Notes

- The recorder can only display the first level of a CD’s text, such as the disc name.
- The letters or symbols that cannot be displayed are replaced with “*.”
- Playing time of MP3 audio tracks may not be displayed correctly.

Checking the playing/remaining time

You can view the playing or time information displayed on the TV screen and the front panel display.

Press TIME/TEXT repeatedly.

The displays differ depending on the disc type or playing status.

◆ Front panel display

Example: When playing a DVD

Playing time and number of the current title

T 1 1:03:24

Remaining time of the current title

T 1 - 1:15:36

Playing time and number of the current chapter

C 2 0:22:30

Remaining time of the current chapter

C 2 - 0:13:20

Example: When dubbing a DVD

Remaining time of dubbing in progress

DUB - 1:25 8

How to Enter Characters

You can label a DVD, title, or program by entering characters. You can enter up to 64 characters for a title or disc name, but the actual number of characters displayed in the menus such as the Title List will vary. When the display for entering characters appears, follow the steps below.

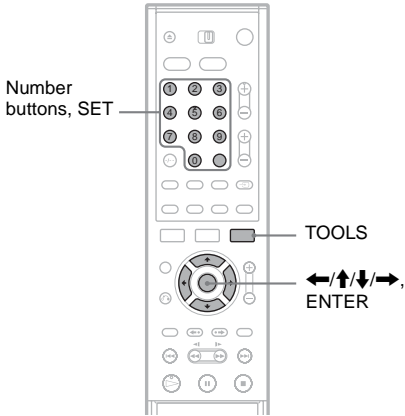

- 1 Press **←/↑/↓/→** to move the cursor to the right of the screen and select "A" (upper-case), "a" (lower-case), or "Symbol," and press ENTER.

The characters of the selected type are displayed.

- 2 Press **←/↑/↓/→** to select the character you want to enter, and press ENTER.

The selected character appears at the top of the display.

Example: Input Title Name

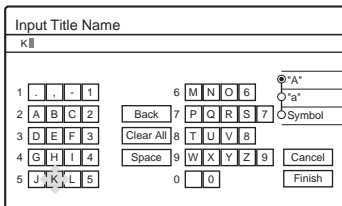

The type of characters will change according to the language you select in Easy Setup. Some languages allow you to enter an accent mark.

To enter a letter with an accent mark, select an accent followed by the letter.

Example: Select "´" and then "a" to enter "à."

To insert a space, select "Space."

- 3 Repeat steps 1 and 2 to enter the remaining characters.

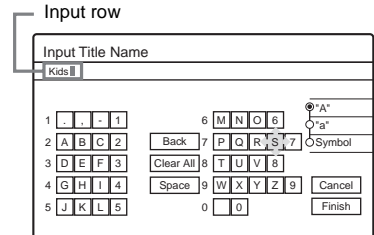

To erase a character, move the cursor to the right of the character at the input row. Select "Back" and press ENTER.

To insert a character, move the cursor to the right of the point where you want to insert the character. Select the character and press ENTER.

To erase all of the characters, select "Clear All" and press ENTER.

- 4 Select "Finish," and press ENTER. To cancel the setting, select "Cancel."

To use the number buttons

You can also use the number buttons to enter characters.

- 1 In step 2 above, press a number button repeatedly to select a character. Example: Press the number 3 button once to enter "D." Press the number 3 button three times to enter "F."
- 2 Press SET and select the next character.
- 3 Select "Finish" and press ENTER.

Before Recording

Before you start recording...

- This recorder can record on various discs. Select the disc type according to your needs (page 8).
- Check that the disc has enough available space for the recording (page 35). For HDD, DVD+RWs, and DVD-RWs, you can free up disc space by erasing titles (page 65).
- Adjust the recording picture quality and picture size if necessary (page 49).

Hint

Timer recordings will be made regardless whether or not the recorder is turned on. You can turn off the recorder without affecting the recording even after recording starts.

Recording mode

Like the SP or LP recording mode of VCRs, this recorder has six different recording modes. Select a recording mode according to the time and picture quality you need. For example, if picture quality is your top priority, select the High Quality mode (HQ). If recording time is your priority, Super Long Play mode (SLP) can be a possible choice. Note that recording times in the following table are approximate and the actual times may differ. Note also that the maximum continuous recording time for a single title is eight hours (HDD), or six hours (DVD). Contents beyond this time will not be recorded. Press REC MODE repeatedly to switch the recording modes.

I want to record with the best possible picture quality, so I'll select HQ.



Recording mode	Recording time (hour)		
	HDD		DVD
	(HX1000)	(HX900)	
HQ (High quality)	53	33	1
HSP ↑	81	51	1.5
SP (Standard mode)	107	67	2
LP ↓	164	103	3
EP ↓	217	137	4
SLP (Long duration)	325	204	6

“HQ+” recording mode

“HQ+” records pictures in higher quality than HQ on the HDD. Set “HQ Setting” in Features Setup to “HQ+” (page 96). Maximum recording time is 34 hours for RDR-HX1000 or 21 hours for RDR-HX900. “HQ” appears in the display.

Note

Situations below may cause slight inaccuracies with the recording time.

- Recording a programme with poor reception, or a programme or video source of low picture quality
- Recording on a disc that has already been edited
- Recording only a still picture or just sound

Recording stereo and bilingual programmes

The recorder automatically receives and records stereo and bilingual programmes based on the ZWEITON system or the NICAM system. The HDD and a DVD-RW (VR mode) can record both main and sub sounds. You can switch between main and sub when playing the disc. For the HDD, you can select the sound track before recording. Select “Main,” “Sub,” or “Main+Sub” in “HDD Bilingual Rec.” of Options Setup (page 97). A DVD+RW, DVD-RW (Video mode), DVD+R, or DVD-R can record only one sound track (main or sub) at a time. Select the sound track using the Setup Display before recording starts. Set “DVD Bilingual Rec.” to “Main” (default) or “Sub” in Options Setup (page 97).

ZWEITON (German stereo) system

When a stereo or bilingual ZWEITON based programme is received, "STEREO" or "BILINGUAL" appears in the front panel display.

NICAM system

When a stereo or bilingual NICAM based programme is received, "NICAM" appears in the front panel display.

To record a NICAM programme, be sure to set "Audio" of "Channel Setting" in Settings Setup to "NICAM" (default). If the sound is not clear when listening to NICAM broadcasts, set "Audio" to "Standard" (see "Channel Setting" on page 84).









Hint

You can select the audio (main or sub) while recording bilingual programmes using the  (audio) button. This does not affect the recorded sound.

Unrecordable pictures

Pictures with copy protection cannot be recorded on this recorder.

When the recorder receives a copy guard signal, the recorder continues to record but only a blank, grey coloured screen will be recorded.

Copy control signals	Recordable discs
Copy-Free	     
Copy-Once	  (Ver.1.1 with CPRM*)
Copy-Never	None (a blank screen is recorded)

* The recorded disc can be played only on CPRM compatible equipment (page 8).

Timer Recording (Standard/VIDEO Plus+)

     

You can set the timer for a total of eight programmes, up to one month in advance.



There are two methods to set the timer: the standard method and VIDEO Plus+ method.

- Standard: Set the date, time, and programme position of the programme manually.
- VIDEO Plus+: Enter the PlusCode number designated for each TV programme (page 44).

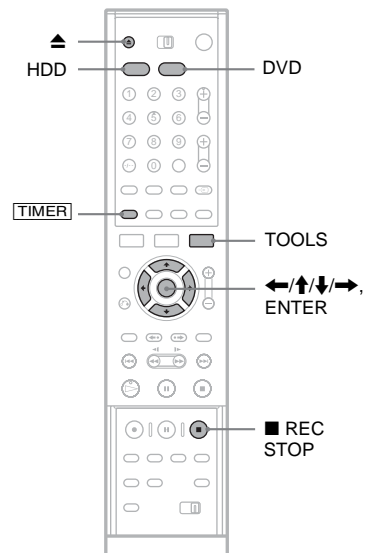
Setting the timer manually (Standard)



1 Press HDD or DVD.

If you select DVD, press  (open/close) and place a DVD on the disc tray. Press  again to close the disc tray.

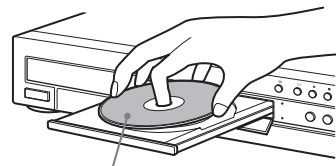

With the recording side facing down

Wait until "LOAD" disappears from the front panel display.
Unused DVDs are formatted automatically.

2 Press **TIMER**.

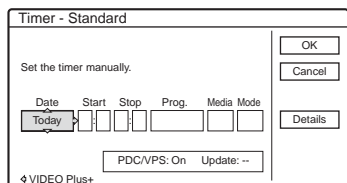

- If the Timer programming (VIDEO Plus+) menu appears, press **←** to switch the display to "Standard."

3 Select an item using **←/→** and adjust using **↑/↓**.

"Date": Sets the date.

The item changes as follows:

Today **↔** Tomorrow **↔** **↔** Thu
28.10 (1 month later) **↔** Sun (every Sunday)
↔ **↔** Sat (every Saturday) **↔**
Mon-Fri (Monday to Friday) **↔** Mon-Sat
(Monday to Saturday) **↔** Sun-Sat (Sunday to
Saturday) **↔** Today

"Start": Sets the start time.

"Stop": Sets the stop time.

"Prog.": Selects the programme position or input source.

"Media": Selects the media, HDD or DVD.

"Mode": Selects the recording mode (page 41).

- If you want to change the setting for the PDC/VPS or Update functions, select "Details" and press **ENTER**. Select an item using **←/→** and set using **↑/↓**.

"PDC/VPS": Sets the PDC/VPS function. See "About the PDC/VPS function" below.

"Update" (HDD only): Automatically records over a previously recorded programme that is set to be recorded daily or weekly.

To return to the Timer programming menu, select "Previous" and **ENTER**.

- If you make a mistake, select the item and change the setting.

4 Select "OK," and press **ENTER**.

The Timer List menu (page 46) appears. The **TIMER REC** indicator lights up on the front panel and the recorder is ready to start recording.

Unlike a VCR, there is no need to turn off the recorder before the timer recording starts.

To stop recording during timer recording

Open the remote's cover and press **■ REC STOP**. Note that it may take a few seconds for the recorder to stop recording.

About the PDC/VPS function

PDC/VPS signals are transmitted with TV programmes in some broadcast systems. These signals ensure that timer recordings are made regardless of any broadcast delays, early starts, or broadcast interruptions.

◆To use the PDC/VPS function

Set "PDC/VPS" to "On" in step 3 above.

When you turn on this function, the recorder starts scanning the channel before the timer recording starts. If you are watching TV when scanning starts, a message will appear on the TV screen. If you want to watch TV, switch to your TV's tuner or turn off the PDC/VPS channel scan function.

◆To turn off the PDC/VPS channel scan

Press **TOOLS** and select "PDC/VPS Scan Off."

To ensure that the PDC/VPS function works properly, turn off the recorder before the timer recording starts. This will automatically turn on the PDC/VPS channel scan function while the recorder remains off.

Rec Mode Adjust

If there is not enough available disc space for the recording, the recorder automatically adjusts the recording mode to enable the entire programme to be recorded. This function is normally set to "On."

To cancel this function, press **TOOLS** while the Timer List is displayed. Select "Rec Mode Adjust" and press **ENTER**. Select "Off" and press **ENTER**.

If the timer settings overlap

Overlapped timer settings are shown as follows.

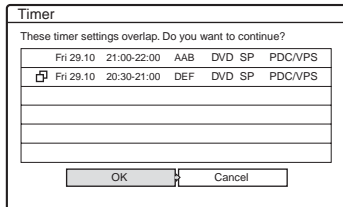

To store the setting as shown, select "OK." The programme that starts first has priority and the second programme starts recording only after the first programme has finished.

To cancel the overlapped setting, select "Cancel."

To confirm, change, or cancel timer recording

See "Checking/Changing/Cancelling Timer Settings (Timer List)" (page 46).

To extend the recording duration time while recording

- 1 Press TOOLS during recording. The TOOLS menu appears.
- 2 Select "Extend Rec" and press ENTER.

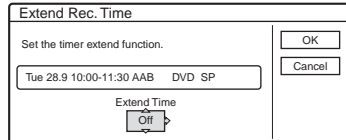

- 3 Press \uparrow/\downarrow to select the duration time. You can set the duration in increments of 10 minutes, for a maximum of 60 minutes.
- 4 Select "OK" and press ENTER.

One Touch Timer

If you use the SMARTLINK connection, you can easily display the timer programming menu.

When the TV is turned on or in standby mode, press [TIMER]. The recorder automatically turns on and the TV's input is switched to the recorder. The Timer programming menu appears.

Hint

You can play the recorded programme by selecting the programme title in the Title List menu.

Notes

- If "The disc is full or nearly full" appears on the screen, change the disc, or make available space for the recording (HDD/DVD+RW/DVD-RW only) (page 66).
- Check that the clock is correctly set before setting the timer recording. If not, the timer recording cannot be made.
To record a satellite programme, turn on the satellite tuner and select the satellite programme you want to record. Leave the satellite tuner turned on until the recorder finishes recording. If you connect equipment with a timer function, you can use the Synchro Rec function (page 51).
- Even if the timer is set for the same daily or weekly programme, the timer recording cannot be made if it overlaps with a programme that has priority. "
" will appear next to the overlapped setting in the Timer List. Check the priority order of the settings.- Even if the timer is set, timer recordings cannot be made while recording a programme that has priority.
- The Rec Mode Adjust function only works with a timer recording and the PDC/VPS function set to off. It does not function with Quick Timer or Synchro Rec.
- The beginning of some recordings may not be made when using the PDC/VPS function.
- You cannot extend the recording duration time when "PDC/VPS" is set to "On."

Recording TV programmes using the VIDEO Plus+ system

The VIDEO Plus+ system is a feature that simplifies setting the timer. Just enter the PlusCode number listed in the TV programme guide. The date, time, and channel of that programme are set automatically.

Check that the channels are correctly set in "Channel Setting" in Settings Setup (page 84).

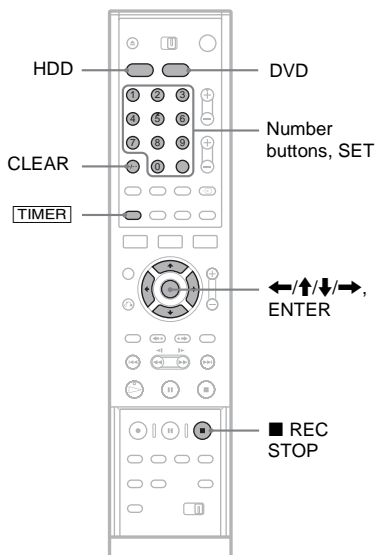

- 1 Press **HDD** or **DVD**.
If you select DVD, insert a recordable DVD.
- 2 Press **TIMER**.

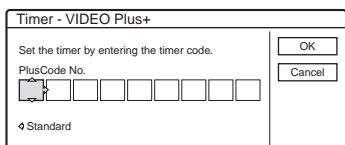

- If the Timer programming (Standard) menu appears, press **←** to switch the display to "VIDEO Plus+."
- 3 Press the number buttons to enter the PlusCode number, and press **SET**.
 - If you make a mistake, press **CLEAR** and re-enter the correct number.
 - 4 Select "OK," and press **ENTER**.
The date, start and stop times, programme position, recording mode, etc. setting (page 43) appear.

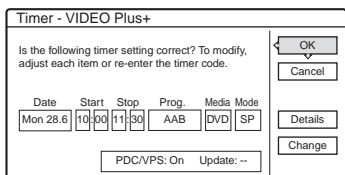

- If you want to change the setting, press **←/→** to select the item and press **↑/↓** to change the setting. For the PDC/VPS or Update functions, select "Details" and change the settings (page 43).

To re-enter the PlusCode number, select "Change."

5 Select "OK," and press **ENTER**.

The **TIMER REC** indicator lights up on the front panel, and the recorder is ready to start recording.

To stop recording during timer recording

Open the remote's cover and press **■ REC STOP**. Note that it may take a few seconds for the recorder to stop recording.

If the timer settings overlap

See page 44.

To extend the recording duration time while recording

See page 44.

To confirm, change, or cancel timer recording

See "Checking/Changing/Canceling Timer Settings (Timer List)" (page 46).

Hint

The Rec Mode Adjust function also works with this timer method (page 43).

Checking/Changing/ Cancelling Timer Settings (Timer List)

HDD +RW -RW_{Video} -RW_{Video} +R -R

You can check, change, or cancel timer settings using the Timer List menu.

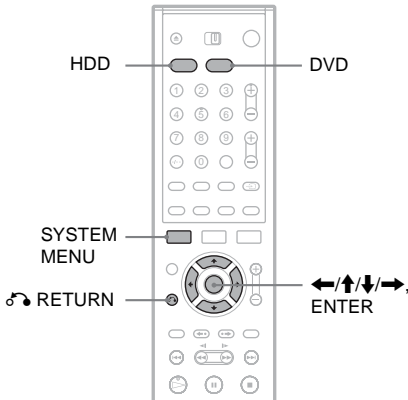

- 1 Press **SYSTEM MENU**.
The System Menu appears.
- 2 Select **"TIMER LIST,"** and press **ENTER**.

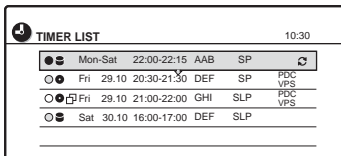

Timer information displays the recording date, time, recording mode, etc.

☐: Indicates that the setting is overlapped by another setting.

● (green): Indicates the setting can be recorded

● (red): Indicates the setting currently being recorded.

○ (grey): Indicates that the setting cannot be recorded in the selected recording mode.

● (HDD icon): Indicates the setting being recorded on the HDD.

● (DVD icon): Indicates the setting being recorded on a DVD.

⌚: Indicates the setting that the Update function is set for.

- 3 Select the timer setting you want to check/change/cancel, and press **ENTER**.
The sub-menu appears.

- 4 Select one of the options, and press **ENTER**.

“Modify”: Changes the timer setting.

Select an item using **←/→** and adjust using **↑/↓**. For the PDC/VPS or Update functions, select “Details” and change the settings (page 43). Select “OK” and press **ENTER**.

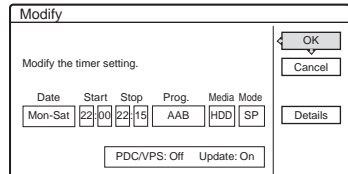

“Erase”: Erases the timer setting. Select “OK” and press **ENTER**.

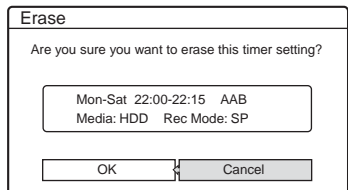

“Check Overlap”: Checks for overlapped settings.

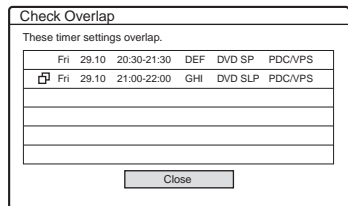

Select “Close” to return to the Timer List.

To change or cancel the setting, repeat steps 3 and 4 above.

When the timer settings overlap

The programme that starts first has priority and the second programme starts recording only after the first programme has finished.

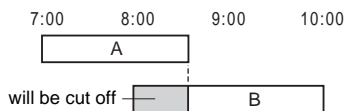

◆ When the recordings start at the same time

The programme that is set last has priority. In this example, timer setting B is set after A, so the first part of timer setting A will not be recorded.

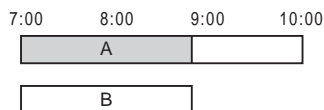

◆ When the end time of one recording and the start time of another are the same

After finishing the previous recording, the other recording may be delayed.

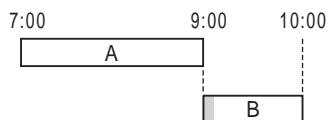

To turn off the Timer List

Press **↵** RETURN.

💡 Hint

While recording, you cannot modify the timer setting for the current recording, but you can extend the recording duration of the recording time (page 44).

Notes

- When "PDC/VPS" is set to "On" for one or more timer recordings, the start times may change in the event of a broadcast delay or early start.
- Even if the timer is set, timer recordings cannot be made while recording a programme that has priority.
- Even if the timer is set for the same daily or weekly programme, the timer recording cannot be made if it overlaps with a programme that has priority. "☐" will appear next to the overlapped setting in the Timer List. Check the priority order of the settings.

Automatically erasing old titles (Auto Title Erase)

HDD

If there is not enough space for a timer recording, the recorder automatically erases old titles recorded on the HDD. The oldest, played title is erased. The protected titles are not erased.

- 1 Display the Timer List menu and press **TOOLS**.
- 2 Select "Auto Title Erase," and press **ENTER**.
- 3 Select "On," and press **ENTER**.
The default setting is "Off."

Recording Without the Timer

HDD +RW -RWVR -RWVideo +R -R

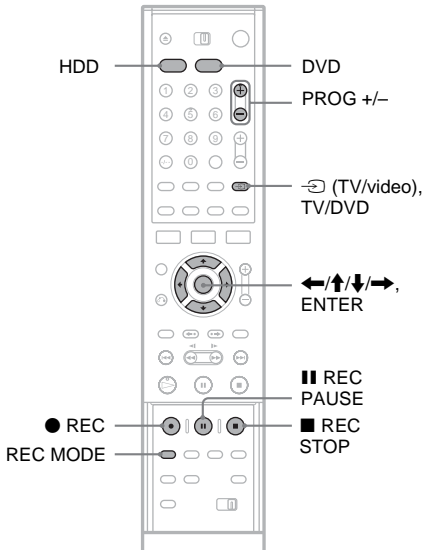

- 1** Press **HDD** or **DVD** to select a media.
When you selected DVD, insert a recordable DVD.
- 2** Press **PROG +/-** to select the programme position or input source you want to record.
- 3** Press **REC MODE** repeatedly to select the recording mode.
Each time you press the button, the display changes on the TV screen as follows:

HQ → HSP → SP → LP → EP → SLP

↑

For more details about the recording mode, see page 41.
- 4** Press **REC**.
Recording starts.
Recording continues until you stop the recording or the disc is full.

To stop recording

Press **■ REC STOP** located beneath the remote control cover. Note that it may take a few seconds for recording to stop.

To pause recording

Press **▬ REC PAUSE** located beneath the remote control cover. To restart recording, press the button again.

To watch another TV programme while recording

If your TV is connected to the LINE 1-TV jack, set your TV to the TV input using the TV/DVD button and select the programme you want to watch. If your TV is connected to the LINE 2 OUT or COMPONENT VIDEO OUT jacks, set the TV to TV input using the (TV/video) button (page 20).

TV Direct Rec

If you use the SMARTLINK connection, you can easily record what you are watching on your TV. When the TV is turned on or in standby mode, press **● REC**. The recorder automatically turns on and starts recording what you are watching on the TV. "TV" appears in the front panel display. You cannot turn off the TV or change the programme position during TV Direct Rec. To turn off the function, set "TV Direct Rec" to "Off" in Features Setup (page 93).

About the Teletext function

Some broadcasts systems ensure a Teletext service* in which the complete programmes and their data (title, date, channel, recording start time etc.) are stored day by day. When recording a programme, the recorder automatically takes the programme name from the Teletext pages and stores it as the title name. For details, see "TV Guide Page" (page 93).

Note that the Teletext information will not appear on your TV screen. To view the Teletext information on your TV screen, press TV/DVD on the remote to switch the input source to your TV.

* not available in some areas

Hint

If you do not want to watch TV while recording, you can turn off the TV. When using a decoder, make sure to leave it on.

Notes

- After pressing ● REC, it may take a short while to start recording.
- You cannot change the recording mode while recording or during recording pause.
- If there is a power failure, the programme you are recording may be erased.
- You cannot watch a PAY-TV/Canal Plus programme while recording another PAY-TV/Canal Plus programme.
- To use the TV Direct Rec function, you must first set the recorder's clock correctly.

Using the Quick Timer function

You can set the recorder to record in 30-minute increments.

Press ● REC repeatedly to set the duration. Each press advances the time in 30-minute increments. The maximum duration is six hours.

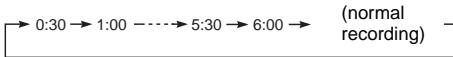

The time counter decreases minute by minute to 0:00, then the recorder stops recording (power does not turn off). Even if you turn off the recorder during recording, the recorder continues to record until the time counter runs out.

Note that the Quick Timer function does not work if "TV Direct Rec" is set to "On" in Features Setup (page 93).

To cancel the Quick Timer

Press ● REC repeatedly until the counter appears in the front panel display. The recorder returns to normal recording mode.

Adjusting the recording picture quality and size

You can adjust the recording picture quality and picture size.

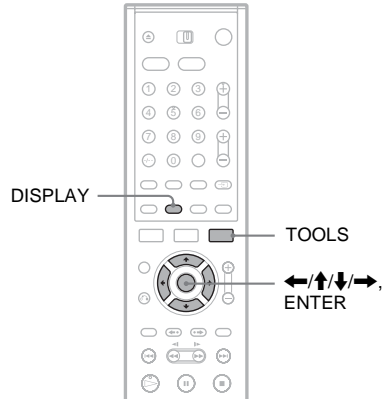

- 1 Before recording starts, press TOOLS and select "Rec Settings." Then press ENTER.

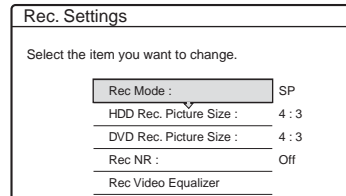

- 2 Select the item you want to adjust, and press ENTER.

The adjustment display appears.

Example: Rec NR

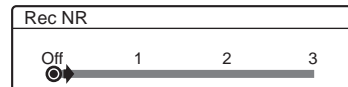

"Rec Mode": Selects the recording mode for the desired recording time and picture quality. For more information, see "Recording mode" (page 41).

“HDD Rec. Picture Size”/“DVD Rec. Picture Size”: Sets the picture size of the programme to be recorded.

- 4:3 (default): Sets the picture size to 4:3.
- 16:9: Sets the picture size to 16:9 (wide mode).
- Auto (HDD only): Automatically selects the actual picture size.

“DVD Rec. Picture Size” works with DVD-Rs and DVD-RWs (Video mode) when the recording mode is set to HQ, HSP, or SP. For all other recording modes, the screen size is fixed at “4:3.”

For DVD-RWs (VR mode), the actual picture size is recorded regardless of the setting. For example, if a 16:9 size picture is received, the disc records the picture as 16:9 even if “DVD Rec. Picture Size” is set to “4:3.”

For DVD+RWs/DVD+Rs, the screen size is fixed at “4:3.”

“Rec NR” (noise reduction): Reduces noise contained in the video signal.

“Rec Video Equalizer”: Adjusts the picture in greater detail.

Press \uparrow/\downarrow to select the item you want to adjust, then press ENTER.

- Contrast: Changes the contrast.
- Brightness: Changes the overall brightness.
- Colour: Makes the colours deeper or lighter.

3 Adjust the setting using $\leftarrow/\uparrow/\downarrow/\rightarrow$, and press ENTER.

The default setting is underlined.

“Rec NR”: (weak) Off 1 ~ 3 (strong)

“Rec Video Equalizer”:

- Contrast: (weak) -3 ~ 0 ~ 3 (strong)
- Brightness: (dark) -3 ~ 0 ~ 3 (bright)
- Colour: (light) -3 ~ 0 ~ 3 (deep)

Repeat steps 2 and 3 to adjust any other items.

Notes

- If one programme contains two picture sizes, the selected size is recorded. However, if the 16:9 signal cannot be recorded as 16:9, it is recorded as 4:3.
- When playing a 16:9 size picture recorded as 4:3, The image is fixed to 4:3 letter box regardless of the setting in “TV Type” of Video Setup (page 88).
- Remnants of images may appear on your screen when using “Rec NR.”
- “Rec Video Equalizer” does not affect the input of the DV IN jack and does not work with RGB signals.

Checking the disc status while recording

You can check the recording information such as recording time or disc type.

Press **DISPLAY** twice during recording.

The recording information appears.



- 1 Disc type/format
- 2 Recording status
- 3 Recording mode
- 4 Recording time

Press **DISPLAY** to turn off the display.

Creating chapters in a title

The recorder will automatically divide a recording (a title) into chapters by inserting chapter marks at 6 or 15-minute intervals during recording. Select the interval, “6Min” (default) or “15Min” in “Auto Chapter” of Features Setup (page 93).

Hint

You can create chapters manually when playing the HDD or DVD-RWs (VR mode). For details, see page 68.

Recording From Connected Equipment With a Timer (Synchro Rec)

HDD +RW -RWVR -RW_{Video} +R -R

You can set the recorder to automatically record programmes from connected equipment that has a timer function (such as a satellite tuner). Connect the equipment to the LINE 3/DECODER jack of the recorder (page 28).

When the connected equipment turns on, the recorder starts recording a programme from the LINE 3/DECODER jack.

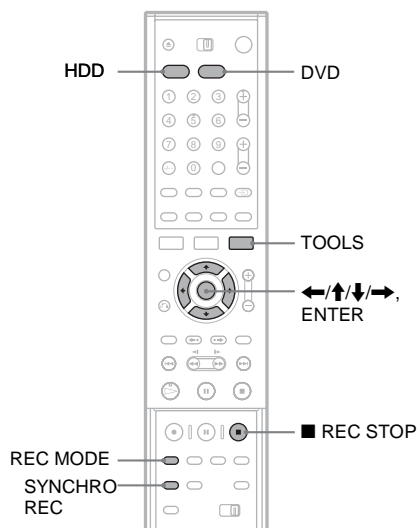

1 Before recording, select HDD or DVD. Set "Synchro Rec" in Features Setup to "Record to HDD" or "Record to DVD" (page 96).

If you select DVD, insert a recordable DVD.

2 Press INPUT SELECT repeatedly to select "L3."

3 Select the line input audio when recording a bilingual programme on the HDD or DVD-RWs (VR mode).

Press TOOLS to display the TOOLS menu. Select "Line Audio Input" and press ENTER. Select "Bilingual" and press ENTER. For details about bilingual recording, see page 41.

4 Press REC MODE repeatedly to select the recording mode, HQ, HSP, SP, LP, EP, or SLP.

5 Set the timer on the connected equipment to the time of the programme you want to record, and turn it off.

6 Press SYNCHRO REC.

The SYNCHRO REC indicator lights up on the front panel. The recorder is ready to start Synchro-Recording.

The recorder automatically starts recording when it receives an input signal from the connected equipment. The recorder stops recording when the connected equipment turns off.

To stop recording

Press ■ REC STOP or SYNCHRO REC.

To cancel Synchro Rec

Press SYNCHRO REC. The SYNCHRO REC indicator on the recorder turns off.

Notes

- The recorder starts recording only after detecting the video signal from the connected equipment. The beginning of the programme may not be recorded regardless of whether or not the recorder's power is on or off.
- During Synchro-Recording, other operations such as normal recording cannot be done.
- To use the connected equipment while the recorder is standing by for Synchro-Recording, cancel Synchro-Recording by pressing SYNCHRO REC. Be sure to turn off the connected equipment and press SYNCHRO REC to reset Synchro-Recording before the timer recording starts.
- The Synchro Rec function does not work when "Line3 Input" of Video Setup is set to "Decoder" (page 90).
- The Synchro Rec function does not work with some tuners. For details, see the tuner's operating instructions.
- While the recorder is standing by for Synchro-Recording, the Auto Clock Set function (page 87) does not work.
- To use the Synchro Rec function, you must first set the recorder's clock correctly.

If the timer settings of a Synchro-Recording and another timer recording overlap

Regardless of whether or not the programme is a Synchro Rec programme, the programme that starts first has priority and the second programme starts recording only after the first programme has finished.

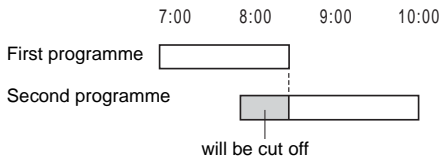

Recording From Connected Equipment Without a Timer

HDD **+RW** **-RWVR** **-RW_{Video}** **+R** **-R**

You can record from a connected VCR or similar device. To connect a VCR or similar device, see “Connecting a VCR or Similar Device” (page 26). Use the DV IN jack on the front panel if the equipment has a DV output jack (i.LINK jack).

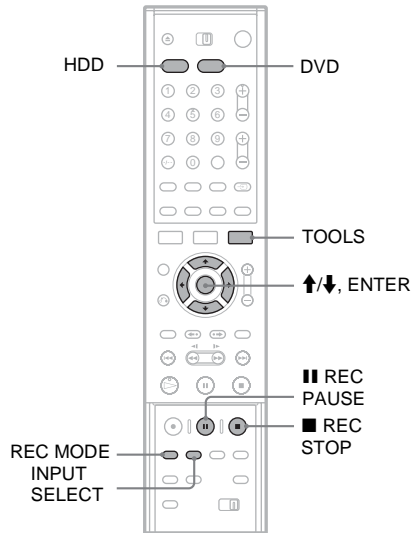

- 1** Press **HDD** or **DVD**.
If you select **DVD**, insert a recordable DVD.
- 2** Press **INPUT SELECT** to select an input source according to the connection you made.

The front panel display changes as follows:

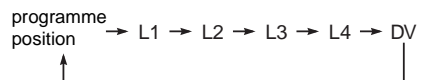

3 Select the line input audio when recording a bilingual programme on the HDD or DVD-RWs (VR mode).

Press **TOOLS** to display the **TOOLS** menu.
Select "Line Audio Input" and press **ENTER**.
Select "Bilingual" and press **ENTER**.
For details about bilingual recording, see page 41.

4 Press **REC MODE** repeatedly to select the recording mode, **HQ**, **HSP**, **SP**, **LP**, **EP**, or **SLP**.

5 Press **■ REC PAUSE** to set this recorder to record pause.

6 Insert the source tape into the connected equipment and set to playback pause.

7 At the same time, press **■ REC PAUSE** on this recorder and the pause or play button on the connected equipment.

Recording starts.

To stop recording, press **■ REC STOP** on this recorder.

If you connect a digital video camera with a DV IN jack

See "DV Dubbing (DV → HDD/DVD)" (page 77) for an explanation of how to record from the DV IN jack.

Hint

You can adjust the settings for the recording picture before recording. See "Adjusting the recording picture quality and size" (page 49).

Notes

- When recording a video game image, the screen may not be clear.
- Any programme that contains a Copy-Never copy guard signal cannot be recorded. The recorder continues to record, but a blank screen will be recorded.

Playback

Playing

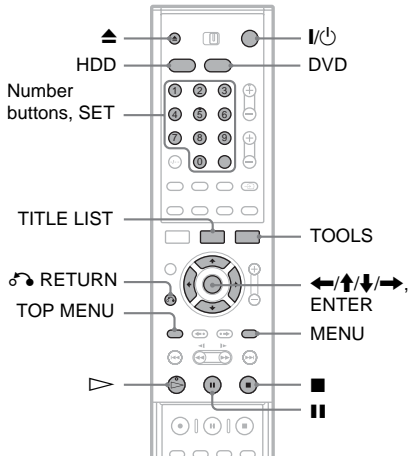

1 Press HDD or DVD.

- If you select DVD, press ▲ (open/close) and place a DVD or CD on the disc tray. Then press the button again to close the disc tray.
- If you insert a DVD VIDEO, VIDEO CD, CD, or DATA CD, press ▷. Playback starts.

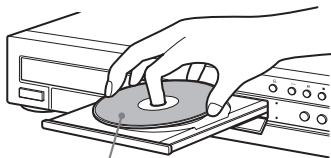

With the playback side facing down

2 Press TITLE LIST.

For details about the Title List, see “Using the Title List” (page 33).

Example: DVD-RW (VR mode)

TITLE LIST ORIGINAL		My Movies 1.5/4.7GB	
Sort	1 AAB 13:00-14:00	Wed 15.9	
Date	2 DEF 20:00-21:00	Fri 17.9	
Title	3 AAB 9:00-9:30	Sat 25.9	
Number	4 GHI 20:00-20:30	Sat 25.9	
	5 DEF 20:00-20:30	Fri 15.10	
	6 L3 21:00-21:30	Tue 19.10	
	7 L3 21:00-21:30	Tue 26.10	
	8 GHI 10:00-10:30	Thu 28.10	

3 Select the title, and press ENTER.

The sub-menu appears.

4 Select “Play,” and press ENTER.

Playback starts from the selected title.

To use the DVD’s Menu

When you play a DVD VIDEO, or a finalized DVD+RW, DVD-RW (Video mode), DVD+R, or DVD-R, you can display the disc’s menu by pressing TOP MENU or MENU.

To play VIDEO CDs with PBC functions

PBC (Playback Control) allows you to play VIDEO CDs interactively using the menu on your TV screen.

When you start playing a VIDEO CD with PBC functions, the menu appears.

Select an item using the number buttons and press ENTER. Then, follow the instructions in the menu (press ▷ when “Press SELECT” appears). The PBC function of Super VCDs does not work with this recorder. Super VCDs are played in continuous play mode only.

To stop playback

Press ■.

To resume playback from the point where you stopped (Resume Play)

When you press ▷ again after you stop playback, the recorder resumes playback from the point where you pressed ■.

To start from the beginning, press TOOLS, select “Play Beginning” and press ENTER. Playback starts from the beginning of the title/track/scene.

The point where you stopped playing is cleared when:

- you open the disc tray (except for HDD).
- you play another title (except for HDD).
- you switch the Title List menu to Original or Playlist (DVD-RW in VR mode only).

- you edit the title after stopping playback.
- you change the settings on the recorder.
- you turn off the recorder (VIDEO CD/CD/DATA CD only).
- you make a recording (except for HDD/DVD-RWs in VR mode).

To play restricted DVDs (Parental Control)



If you play a restricted DVD, the message “Do you want temporarily change parental control to *?” appears on your TV screen.

- 1 Select “OK” and press ENTER.
The display for entering your password appears.
- 2 Enter your four-digit password using the number buttons.
- 3 Press ENTER to select “OK.”
The recorder starts playback.



To register or change the password, see “Parental Control (DVD VIDEO only)” (page 94).

To lock the disc tray (Child Lock)

You can lock the disc tray to prevent children from ejecting the disc.

When the recorder is in standby mode, press  RETURN, ENTER, and then  on the remote.

“LOCKED” appears on the front panel display. The  (open/close) button does not work while the Child Lock is set.

To unlock the disc tray, press  RETURN, ENTER, and then  on the remote again when the recorder is in standby mode.

One Touch Play

If you use the SMARTLINK connection, you can easily start playing.

When the TV is turned on or in standby mode, press . The recorder automatically turns on and the TV’s input is switched to the recorder. Playback starts automatically.

One Touch Menu

If you use the SMARTLINK connection, you can easily display the Title List.

When the TV is turned on or in standby mode, press TITLE LIST. The recorder automatically turns on and the TV’s input is switched to the recorder. The Title List menu appears.





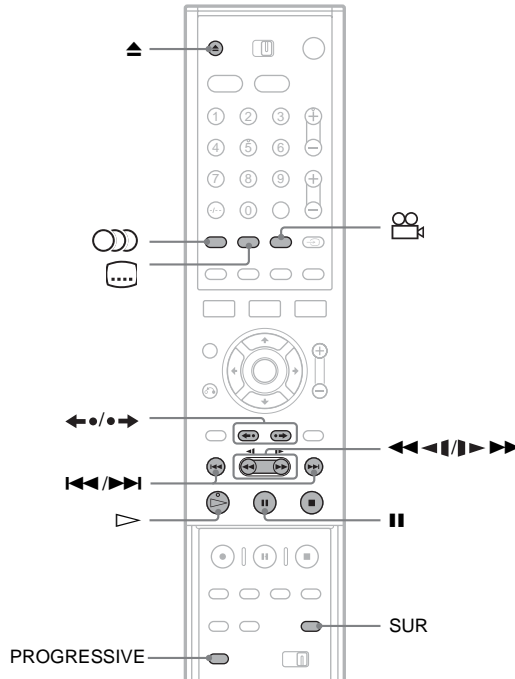

Hints

- You can also use the  button in step 3 (page 54) to start playback.
- Even if a timer recording starts during playback, neither the recording nor playback will stop (page 60).
- Even if you select “Factory Setup” in Options Setup (page 97), the Child Lock remains set.

Playback options



Buttons	Operations	Discs
▲ (open/close)	Stops play and opens the disc tray.	All discs
⊞ (audio)	<p>Selects one of the audio tracks recorded on the disc when pressed repeatedly.</p> <p>DVD : Selects the language.</p> <p>HDD -RWVR : Selects the main or sub sound.</p> <p>VCD CD DATA CD : Selects stereo or monaural audio tracks.</p>	HDD -RWVR DVD VCD CD DATA CD
⋮ (subtitle)	Selects a subtitle language when pressed repeatedly.	DVD
📷 (angle)	<p>Selects an angle when pressed repeatedly.</p> <p>If various angles (multi-angles) for a scene are recorded on the disc, “📷” appears in the front panel display.</p>	DVD

Buttons	Operations	Discs
SUR (surround)	<p>Selects one of the TVS effects when pressed repeatedly.</p> <p>TVS* (TV Virtual Surround) lets you enjoy virtual surround sound effects created from the front left and right speakers. The selected setting is displayed in the front panel display for a few seconds.</p> <p>“TVS OFF”: No surround effect</p> <p>“TVS DYNAMIC”: Creates one set of virtual rear speakers.</p> <p>“TVS WIDE”: Creates five sets of virtual rear speakers.</p> <p>“TVS NIGHT”: Creates five sets of virtual rear speakers. Effective at low volume.</p> <p>“TVS STANDARD”: Creates three sets of virtual rear speakers. Effective when you use two separate front speakers.</p>	<p>DVD</p> <p>* TVS was developed by Sony to produce home surround sound with just a stereo TV. This works with multichannel Dolby Digital and MPEG soundtracks.</p>
PROGRESSIVE	<p>Switches the type of video output signal to interlace or progressive format (page 16).</p>	<p>HDD +RW -RWVR -RW_{video} +R -R DVD VCD</p>
 (instant replay/instant advance)	<p>Replays the scene/briefly fast forwards the scene.</p>	<p>HDD +RW -RWVR -RW_{video} +R -R DVD</p>
 (previous)/  (next)	<p>Goes to the beginning of the previous/next title/ chapter/scene/track.</p>	<p>All discs</p>
 (fast reverse/fast forward)	<p>Fast reverses/fast forwards the disc when pressed during playback.</p> <p>Search speed changes as follows:</p> <p style="text-align: center;"> fast reverse fast forward FR1 ← → FF1 FR2 ← ← → → FF2 FR3* ← ← ← → → → FF3* </p> <p>When you press and hold the button, fast forward/fast reverse continues at the selected speed until you release the button.</p>	<p>All discs</p> <p>* FR3 and FF3 are only available for the HDD and DVDs.</p>
 (slow, freeze frame)	<p>Plays in slow motion when pressed for more than one second in pause mode.</p> <p>Plays one frame at a time when pressed briefly in pause mode.</p>	<p>HDD +RW -RWVR -RW_{video} +R -R DVD VCD *</p> <p>* Playback direction only</p>
 (pause)	<p>Pauses playback.</p>	<p>All discs</p>

To resume normal playback, press .

Notes

- To enjoy the TVS function, set “Digital Output” to “On” and “Dolby Digital” to “D-PCM” in Audio Setup.
- When the playback signal does not contain a signal for the rear speakers, the surround effects will be difficult to hear.
- When you select one of the surround modes, turn off the surround settings of the connected TV or amplifier (receiver).
- Make sure that your listening position is between and at an equal distance from your speakers, and that the speakers are located in similar surroundings.
- The TVS function cannot be used with titles recorded on this recorder. Angles and subtitles also cannot be changed.
- When you use the DIGITAL OUT (COAXIAL) jack to listen to MPEG audio signals and set “MPEG” to “MPEG” in Audio Setup, no sound will come from your speakers if you select one of the TVS modes.

Notes on playing DTS sound tracks on a CD

- When playing DTS-encoded CDs, excessive noise will be heard from the analogue stereo jacks. To avoid possible damage to the audio system, the consumer should take proper precautions when the analogue stereo jacks of the recorder are connected to an amplification system. To enjoy DTS Digital Surround™ playback, an external 5.1-channel decoder system must be connected to the digital jack of the recorder.
- Set the sound to “Stereo” using the  (audio) button when you play DTS sound tracks on a CD (page 56).

Notes on playing DVDs with a DTS sound track

DTS audio signals are output only through the DIGITAL OUT (COAXIAL or OPTICAL) jack.

When you play a DVD with DTS sound tracks, set “DTS” to “On” in Audio Setup (page 92).

Adjusting the picture quality



1 Press **TOOLS** during playback.
The **TOOLS** menu appears.

2 Select “Video Settings,” and press **ENTER**.

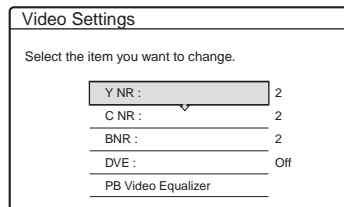

3 Select an item, and press **ENTER**.

The adjustment display appears.

“Y NR” (luminance noise reduction):

Reduces noise contained in the luminance element of the video signal.

“C NR” (chroma noise reduction): Reduces noise contained in the colour element of the video signal.

“BNR” (block noise reduction): Reduces “block noise” or mosaic like patterns in the picture.

“DVE” (digital video enhancer): Sharpens the outlines of the images.

“PB Video Equalizer” (Playback video equalizer): Adjusts the picture in greater detail.

Select an item and press **ENTER**.

- Contrast: changes the contrast.
- Brightness: changes the overall brightness.
- Colour: makes the colours deeper or lighter.
- Hue: changes the colour balance.

4 Press ←/→ to adjust the setting, and press ENTER.

The default settings are underlined.

“Y NR”: (weak) Off 1 2 3 (strong)

“C NR”: (weak) Off 1 2 3 (strong)

“BNR”: (weak) Off 1 2 3 (strong)

“DVE”*: (weak) Off 1 2 3 (strong)

“PB Video Equalizer”:

• Contrast: (weak) -3 ~ 0 ~ 3 (strong)

• Brightness: (dark) -3 ~ 0 ~ 3 (bright)

• Colour: (light) -3 ~ 0 ~ 3 (deep)

• Hue: (red) -3 ~ 0 ~ 3 (green)

Repeat steps 3 and 4 to adjust any other items.

* “1” softens the outlines of the images. “2” enhances the outlines and “3” enhances them more than “2.”

Notes

- If the outlines of the images on your screen become blurred, set “BNR” to “Off.”
- Depending on the disc or the scene being played, the above BNR, Y NR, or C NR effects may be hard to discern. And, these functions may not work with some screen sizes.
- When playing a title recorded in SLP recording mode, the BNR setting may have little effect.
- When using the DVE function, noise found in the title may become more apparent. In this case, it is recommended that you use the BNR function with the DVE function. If the condition still does not improve, set the DVE level to “1” or “Off.”

Adjusting the sound quality

HDD +RW -RWVR -RWVideo +R -R
DVD VCD CD

1 Press TOOLS during playback.

The TOOLS menu appears.

2 Select “Audio Settings,” and press ENTER.

3 Select an item, and press ENTER.

“Surround (TVS)” (DVD VIDEO only):

Selects one of the surround modes. For more information, see “Playback options” (page 56).

“Audio Filter” (all discs): Selects the digital filter to reduce noise above 22.05 kHz (Fs* is 44.1 kHz), 24 kHz (Fs is 48 kHz), or 48 kHz (Fs is above 96 kHz).

• Sharp (default): Provides a wide frequency range and spatial feeling.

• Slow: Provides smooth and warm sound.

* Sampling frequency of audio source. This function only adjusts the output signals from the LINE 1 – TV, LINE 3/DECODER, or LINE 2 OUT (AUDIO L/R).

4 Press ←/↑/↓/→ to select the option, and press ENTER.

Note

There may be little effect by changing the Audio Filter depending on the disc or playback environment.

Chasing Playback/ Simultaneous Rec and Play

You can view the beginning of a programme while it is being recorded. You can also play a title or previously recorded programme while recording.

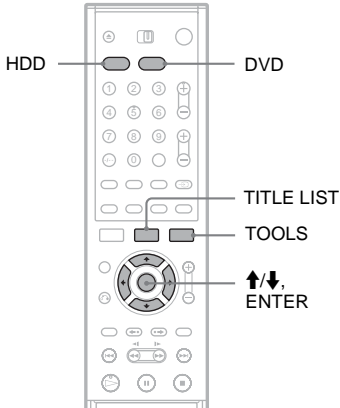

Playing from the beginning of the programme you are recording (Chasing Playback)

HDD **-RWVR**

“Chasing Playback” allows you to view the recorded part of a programme while the recording is being made. You do not need to wait until the recording finishes.

- 1 Press **TOOLS** while recording.
The **TOOLS** menu appears.
- 2 Select “Chasing Playback,” and press **ENTER**.
Playback starts from the beginning of the programme you are recording.
When you fast forward to the point that you are recording, Chasing Playback returns to normal playback.

Notes

- For DVD-RWs (VR mode), this function does not work when recording:
 - on a 1x-speed DVD-RW.
 - in the HQ or HSP recording mode.

- The DVD’s picture on your TV screen freezes for a few seconds when you fast forward/fast reverse or instant replay/advance the recording.

Playing a previous recording while making another (Simultaneous Rec and Play)

HDD **+RW** **-RWVR** **-RWVideo** **+R** **-R**
DVD **VCD** **CD** **DATA CD**

“Simultaneous Rec and Play” allows you to view a previously recorded programme while recording programmes. Playback continues even if a timer recording starts. Use this function as follows:

- While recording to the **HDD**:
Play another title on the **HDD**.
Play a previously recorded programme on a **DVD** by pressing **DVD**.
- While recording to a **DVD**:
Play a previously recorded programme on the **HDD** by pressing **HDD**.
- While recording to a **DVD-RW (VR mode)*1**:
Play another title on the same **DVD-RW (VR mode)** disc.*2

*1 Simultaneous Rec and Play function does not work when you record:
 – on a 1x-speed DVD-RW.
 – in the HQ or HSP recording mode.

*2 Picture noise may appear depending upon the condition of the recording, or when playing a title recorded in the HQ or HSP recording mode.

You can also play a **DVD VIDEO**, **VIDEO CD**, **Super VCD**, **CD**, or **DATA CD** while recording on the **HDD**.

Example: Play another title on the HDD while recording to the HDD.

- 1 While recording, press **TITLE LIST** to display the **HDD Title List**.
- 2 Select the title you want to play, and press **ENTER**.
- 3 Select “Play” from the sub-menu, and press **ENTER**.
Playback starts from the selected title.

Example: Play a DVD while recording to the HDD.

- 1 While recording, press **DVD** and insert the **DVD** into the recorder.
- 2 Press **TITLE LIST** to display the **DVD Title List**.

- 3 Select the title you want to play, and press ENTER.
- 4 Select "Play" from the sub-menu, and press ENTER.
Playback starts from the selected title.

Notes

- The DVD's playback picture on your TV screen freezes for a few seconds when you fast forward/fast reverse or instant replay/advance during Simultaneous Rec and Play.
- You cannot play a DVD recorded in NTSC colour system while recording on the HDD.

Searching for a Title/Chapter/Track, etc.



You can search a disc by title, chapter, scene or track. As titles and tracks are assigned individual numbers, select the title or track by entering its number. You can also search for a scene using the time code.

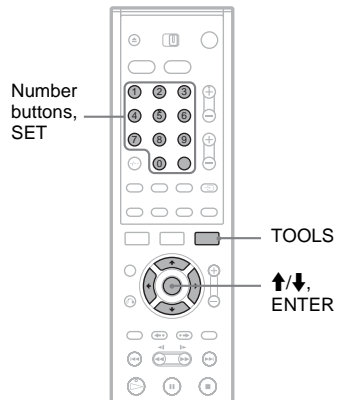

- 1 Press **TOOLS** during playback.
The **TOOLS** menu appears.
- 2 Select a search method, and press **ENTER**.
 "Title Search" (for DVDs)
 "Chapter Search" (for HDD/DVDs)
 "Track Search" (for CDs/DATA CDs)
 "Search" (for VIDEO CDs)
 "Album Search" (for DATA CDs)
 "Time Search" (for HDD/DVDs): Searches for a starting point by entering the time code.

The display for entering the number appears.
Example: Title Search



The number in parentheses indicates the total number of titles, tracks, etc.

- 3** Press the number buttons to select the number of the title, chapter, track, time code, etc., you want.

For example: Time Search

To find a scene at 2 hours, 10 minutes, and 20 seconds, enter “21020.”

If you make a mistake, press CLEAR to cancel the number, then select another number.

- 4** Press SET.

The recorder starts playback from the selected number.

Note

“Title Search” is not applicable to the HDD.

Playing MP3 Audio Tracks

DATA CD

You can play MP3 audio tracks on DATA CDs (CD-ROMs/CD-Rs/CD-RWs).

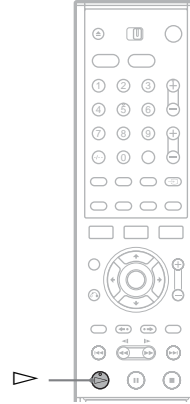

- 1** Insert a DATA CD on the disc tray.

- 2** Press .

Playback starts from the first MP3 audio tracks on the disc. Note that the playback order may be different from the edited order. See “Playback order of MP3 audio tracks” below.

About MP3 audio tracks

MP3 is audio compression technology that satisfies certain ISO/MPEG regulations. You can play back DATA CDs (CD-ROMs/CD-Rs/CD-RWs) recorded in MP3 (MPEG1 Audio Layer 3) format. However, the discs must be recorded according to ISO9660 Level 1, Level 2 or Joliet format for the recorder to recognize the tracks. You can also play discs recorded in Multi Session.

See the instructions supplied with the CD-R/CD-RW drives and the recording software (not supplied) for details on the recording format.

Note on Multi Session discs

If MP3 audio tracks are recorded in the first session, the recorder will also play MP3 audio tracks in other sessions. If audio tracks in Music CD format are recorded in the first session, only the first session will be played back.

Playback order of MP3 audio tracks

Albums containing MP3 audio tracks play in the following order.

A → **B** → **C** → **D** → **F** → **G**. Albums that do not contain tracks (such as album **E**) are skipped.

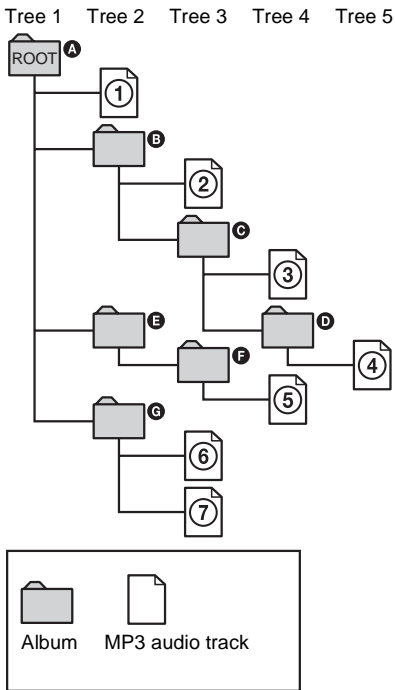

When you insert a DATA CD and press \blacktriangleright , the numbered tracks are played sequentially, from ① through ⑦. Any sub-albums/tracks contained within a currently selected album take priority over the next album in the same tree. (Example: **C** contains **D** so ④ is played before ⑤.)

Hints

- You can view the disc information while playing MP3 audio tracks (page 39).
- If you add numbers (01, 02, 03, etc.) to the front of the track names when you store the tracks in a disc, the tracks will be played in that order.
- Since a disc with many trees takes longer to start playback, it is recommended that you create albums with no more than two trees.

Notes

- Depending on the software you use to create the DATA CD, the playback order may differ from the above illustration.
- Proceeding to the next or another album may take some time.
- The recorder may not be able to play some DATA CDs created in the Packet Write format.
- The recorder will play any data with the extension “.MP3,” even if they are not in MP3 format. Playing this data may generate a loud noise which could damage your speaker system.
- The recorder does not conform to audio tracks in MP3PRO format.
- The playback order above may not be applicable if there are more than a total of 999 albums and tracks in the DATA CD.
- The recorder can recognize up to 499 albums (the recorder will count just albums, including albums that do not contain MP3 audio tracks). The recorder will not play any albums beyond the first 499 albums. Of the first 499 albums, the recorder will play no more than a combined total of 999 albums and tracks.
- The recorder can play MP3 audio tracks recorded in the following sampling frequencies: 32 kHz, 44.1 kHz, 48 kHz.
- Only the letters in the alphabet and numbers can be used for album or track names. Anything else is displayed as “*.”
- ID3 tags cannot be displayed.

Before Editing

This recorder offers various edit options for various disc types. Before you edit, check the disc type in the front panel display, and select the option available for your disc (page 8).

Note

You may lose the edited contents if you remove the disc or a timer recording starts while editing.

Edit options for the HDD and DVD+RWs/DVD-RWs (Video mode)/DVD+Rs/DVD-Rs

HDD **+RW** **-RW_{video}** **+R** **-R**

You can perform simple edits. Since Video mode titles are actual recordings on the disc, you cannot undo any edits you make. The edit functions available for Video mode titles are:

- Setting protection against erasure (page 65).
- Labelling a title (page 65).
- Erasing a title (page 65).
- Erasing multiple titles (page 66).
- Erasing a section of a title (A-B Erase) (HDD and DVD+RWs only) (page 66).
- Erasing titles to open up disc space (Disc Map) (DVD+RWs and DVD-RWs (Video mode) only) (page 67).

Notes

- Once the DVD is finalized, you cannot edit or record on the disc (except for DVD+RWs and DVD-RWs (VR mode)).
- You cannot create a Playlist (see below).
- If a message appears and indicates that the disc's control information is full, erase unnecessary titles.

Edit options for DVD-RWs (VR mode)

-RW_{VR}

You can enjoy advanced edit functions. First you have two options for a DVD-RW (VR mode): editing either the original recording (called the "original"), or the playback information created from the original (called a "Playlist"). Since each is different in nature and offers different merits, read the following and select the one that better suits your needs.

To edit original titles

Edits made to the original titles are final. If you plan to retain an unaltered original recording, create and edit a Playlist (see below). The edit functions available for original titles are:

- Labelling a title (page 65).
- Setting protection against erasure (page 65).
- Erasing a title (page 65).
- Erasing multiple titles (page 66).
- Erasing a section of a title (A-B Erase) (page 66).

To create and edit Playlist titles

A Playlist is a group of Playlist titles created from the original title for editing purposes. When you create a Playlist, only the control information necessary for playback, such as the playback order, is stored on the disc. Since the original titles are left unaltered, Playlist titles can be re-edited.

Example: You have recorded the final few matches of a football tournament on a DVD-RW (VR mode). You want to create a digest with the goal scenes and other highlights, but you also want to keep the original recording.

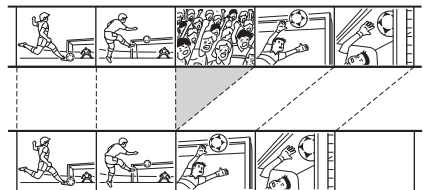

In this case, you can compile highlight scenes as a Playlist title. You can even rearrange the scene order within the Playlist title ("Creating and Editing a Playlist" on page 68).

The advanced edit functions available for Playlist titles are:

- Labelling a title (page 65).
- Erasing a title (page 65).
- Erasing multiple titles (page 66).
- Erasing a section of a title (A-B Erase) (page 66).
- Rearranging the title order (page 70).
- Dividing a title into multiple titles (page 70).
- Combining multiple titles into one title (page 71).

Hint

You can display the disc's Playlist titles in the Title List (Playlist), or the original titles in the Title List (Original). To switch the two Title Lists, press TOOLS while a Title List is displayed, and select "Original" or "Playlist."

Notes

- The Playlist title calls up data from the original titles for playback. When an original title is used for a Playlist title, the original title cannot be erased.
- You cannot protect Playlist titles.
- If a message appears and indicates that the disc's control information is full, erase unnecessary titles.

Editing a Title

HDD +RW -RWVR -RWVideo +R -R

This section explains the basic edit functions. Note that editing is irreversible. To edit a DVD-RW (VR mode) without changing the original recordings, create a Playlist title (page 68).

Note

When editing a DVD+R, DVD-R, or DVD-RW (Video mode), finish all editing before finalizing the disc. You cannot edit a finalized disc.

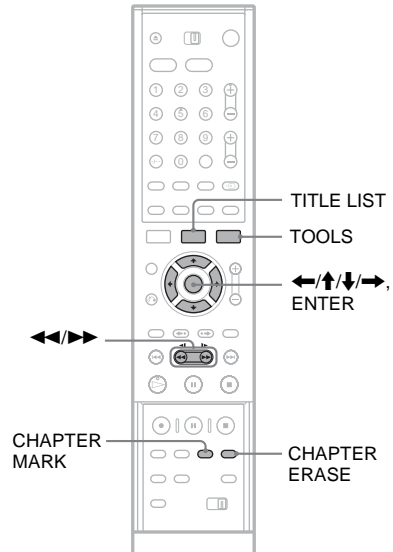

1 Press TITLE LIST.

When editing a DVD-RW in VR mode, press TOOLS and select "Original" or "Playlist" from the TOOLS menu to switch the Title Lists, if necessary.

2 Select a title, and press ENTER.

The sub-menu appears.

3 Select an option, and press ENTER.

You can make the following edits to the title. "Erase": Erases the selected title. Select "OK" when asked for confirmation. When the title is protected, the display asks for confirmation. To erase, select "Change," and when the Protection display appears, select "Off."

“Protect”: Protects the title. Select “On” when the Protection display appears. “” appears next to the protected title. To cancel the protection, select “Off.”

“Title Name”: Allows you to enter or re-enter a title name (page 40).

“Set Thumbnail”: Changes the title’s thumbnail picture that appears in the Title List (page 33).

“A-B Erase”: Erases a section of the title (see below).

Hints

- You can erase multiple titles at one time (page 66), or erase all of the titles on the disc at once (page 36).
- You can label or re-label DVDs (page 36).

Note

You cannot protect Playlist titles.

Erasing a section of a title (A-B Erase)

HDD **+RW** **-RWvR**

You can select a section (scene) in a title and erase it. Note that erasing scenes in a title cannot be undone.

1 After step 2 of “Editing a Title,” select “A-B Erase” and press ENTER.

The display for setting point A appears.

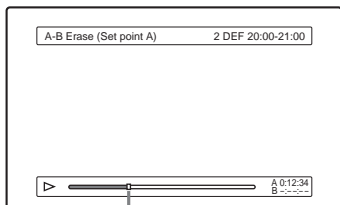

Playback point

- When the title is protected, the display asks for confirmation. To continue, select “Change,” and when the protection display appears, select “Off.”

2 Select point A by pressing / , and press ENTER.

The display for setting point B appears.

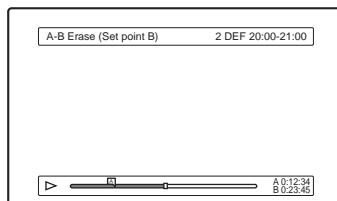

3 Select point B by pressing / , and press ENTER.

The display asks for confirmation. To reset either point A or B, select “Change A” or “Change B,” and go to step 2 or 3.

4 Select “OK,” and press ENTER.

The scene is erased, and the display asks whether to erase another scene. To continue, select “Yes,” and repeat from step 2. To finish, select “No.”

Hint

A chapter mark is inserted after the scene was erased. The chapter mark divides the title into separate chapters on either side of the mark.

Notes

- Images or sound may be momentarily interrupted at the point where you erase a section of a title.
- Sections shorter than five seconds may not be erased.
- For DVD+RWs, the erased section may be slightly different from the points you selected.

Erasing multiple titles (Erase Titles)

HDD **+RW** **-RWvR** **-RWVideo** **+R** **-R**

You can select and erase more than one title at one time using the TOOLS menu.

1 Press TITLE LIST to turn on the Title List menu, and press TOOLS.

The TOOLS menu appears.

2 Select “Erase Titles,” and press ENTER.

The display for selecting titles to be erased appears.

3 Select a title, and press ENTER.

A check mark appears in the check box next to the selected title. To clear the check mark, press ENTER again. To clear all of check marks, select “Reset All.”

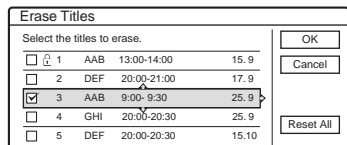

- When the title is protected, the display asks for confirmation. To continue, select “Change,” and when the protection display appears, select “Off.” To cancel, select “Close.”

4 Repeat step 3 to select all of the titles you want to erase.

5 When you finish selecting titles, select “OK,” and press ENTER.

The list of the titles to be erased appears for confirmation. To change the selection, select “Change,” and repeat from step 3.

6 Select “OK” and press ENTER.

The titles are erased.

Erasing titles to open up disc space (Disc Map)

+RW -RW_{Video}

When recording on a DVD+RW or DVD-RW (Video mode), the recorder searches for the largest open space and records there. Before you start, check the disc status by using Disc Map, and erase titles to create a space large enough for the recording.

1 Insert a disc and press TITLE LIST.

2 Press TOOLS and select “Disc Map,” and press ENTER.

The Disc Map appears. To check the open space, select the space by pressing ◀/▶.

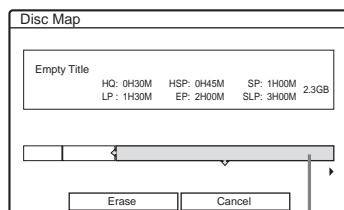

Selected open space

- When ◀ or ▶ appears on either side of the screen, you can scroll sideways by pressing ◀/▶.

3 Select a title by pressing ◀/▶, and press ENTER.

The display for selecting titles to be erased appears. To cancel the selection, press ENTER again.

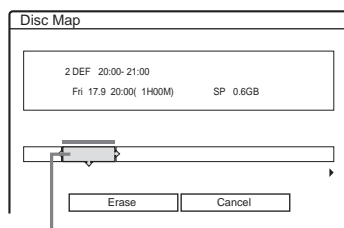

Selected title

- When the title is protected, the display asks for confirmation. To continue, select “Change,” and when the protection display appears, select “Off.” To cancel, select “Close.”

4 Repeat step 3 when erasing more titles.

5 Select “Erase,” and press ENTER.

The display asks for confirmation. To change the selection, select “Change.”

6 Select “OK,” and press ENTER.

The selected titles are erased, freeing up disc space.

Creating chapters manually

HDD **-RWVR**

You can manually insert a chapter mark at any point you like during playback or recording.

Press **CHAPTER MARK** at the point where you want to divide the title into chapters.

Each time you press the button, “Marking...” appears on the screen and the scenes to the left and right of the mark become separate chapters.

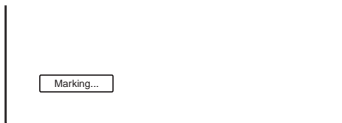

To erase chapter marks

You can combine two chapters by erasing the chapter mark during playback.

Press **◀▶** to search for a chapter number, and while displaying the chapter containing the chapter mark you want to erase, press **CHAPTER ERASE**.

The current chapter combines with the previous chapter.

Notes

- If a message appears and indicates that no more chapter marks can be added, you may not be able to record or edit.
- When dubbing, any chapter marks you enter will be erased.

Creating and Editing a Playlist

-RWVR

Playlist edit allows you to edit or re-edit without changing the actual recordings. A Playlist title can contain up to 50 scenes.

For details, see “Edit options for DVD-RWs (VR mode)” (page 64).

Note

Once you create a Playlist title from original titles, you will be unable to erase or edit the original titles.

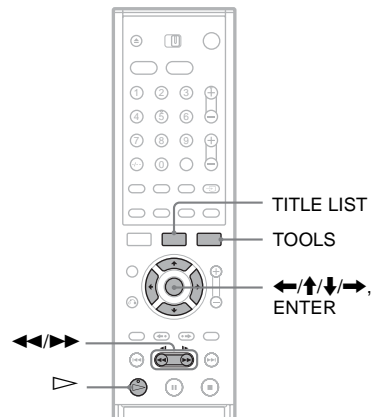

- 1 Press **TITLE LIST** to turn on the Title List menu, and press **TOOLS**. The **TOOLS** menu appears.
- 2 Select “Create Playlist,” and press **ENTER**. The display for selecting titles appears.

- 3** Select the title you want to include in the Playlist title, and press ENTER. A check mark appears in the check box next to the selected title. To clear the check mark, press ENTER again. To select all of the titles, select “Select All.”

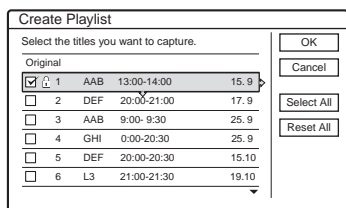

- 4** Repeat step 3 to add more titles. To go to the next page of titles, press ↓. To clear all of the check marks, select “Reset All.”
- 5** Select “OK,” and press ENTER. The list of selected titles appears. To add another title, select “Add Title.”

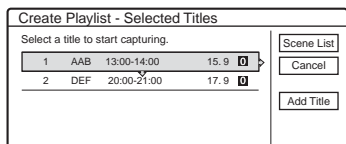

- 6** Select one of the titles, and press ENTER. The sub-menu appears. “Capture”: Adds a section of the title to the Playlist title as one scene. “Capture All”: Adds the entire title to the Playlist title as one scene. After capturing the title, select “Scene List” and go to step 12. “Check Scenes”: Allows you to check the captured scene.
- 7** Select “Capture,” and press ENTER. The display for setting the start point (IN) appears. The title starts to play in the background.

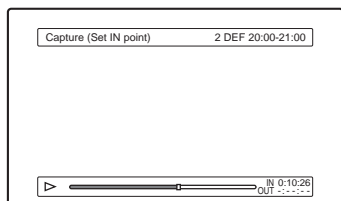

- 8** Select the IN point by pressing ◀◀/▶▶, and press ENTER. The display for setting the end point (OUT) appears, and the title continues to play in the background.

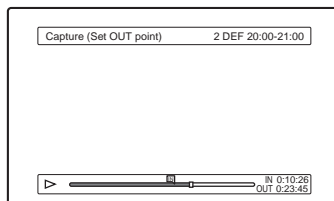

- 9** Select the OUT point by pressing ◀◀/▶▶, and press ENTER. The display asks for confirmation. To reset the IN or OUT point, select “Change IN” or “Change OUT” and repeat step 8 or 9. To view the selected scene, select “Preview.”
- 10** Select “OK,” and ENTER. The selected section is captured as a scene, and the display asks whether you want to continue. To continue, select “More,” and repeat the steps above. To capture a scene from another title, select “New Title.”

- 11** When you finish capturing scenes, select “No More” and press ENTER. The Scene List menu appears with all of the selected scenes.

Total duration of the selected scene Total number of scenes

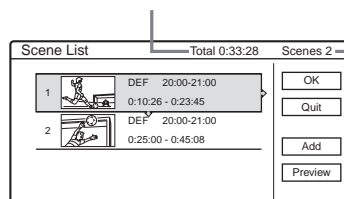

12 Select the scene you want to edit, and press ENTER.

The sub-menu appears.

“Move”: Changes the scene order.

“Erase”: Erases the scene. The selection is cancelled.

“Preview”: Displays thumbnail pictures of the scenes.

“Change IN”: Allows you to change the IN point, and repeat from step 8.

“Change OUT”: Allows you to change the OUT point, and repeat from step 9.

To add more scenes, select “Add” and go to step 6. To preview all of the captured scenes in the listed order, select “Preview.”

13 When you finish editing the Scene List, select “OK,” and press ENTER.

The display for entering the title name appears. To enter a new name, select “Enter” (see page 40).

14 Select “OK” to use the default name, and press ENTER.

To play the Playlist title

Press TOOLS while the Title List menu is turned on. Then, select “Playlist” and press ENTER. When the Title List (Playlist) menu appears, select a title and press ▷.

Hint

When a Playlist title is created, the IN and OUT points will become chapter marks, and each scene will become a chapter.

Note

The picture may pause when the edited scene is played.

Moving a Playlist title (Move)

-RWVR

You can change the Playlist title order within the Title List (Playlist).

1 Press TITLE LIST to turn on the Title List (Playlist) menu.

If the Title List (Original) menu appears, press TOOLS and select “Playlist.”

2 Select “Number” in the “Sort” column, and press ENTER.

The titles are sorted in order of title number.

3 Select a title, and press ENTER.
The sub-menu appears.

4 Select “Move,” and press ENTER.

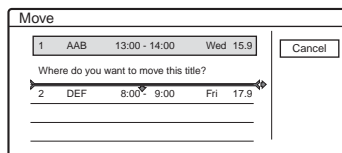

5 Select a new location for the title by pressing ↑/↓, and press ENTER.
The title moves to the new location.

Dividing a Playlist title (Divide)

-RWVR

1 Press TITLE LIST to turn on the Title List (Playlist) menu.

If the Title List (Original) menu appears, press TOOLS and select “Playlist.”

2 Select a title, and press ENTER.
The sub-menu appears.

3 Select “Divide,” and press ENTER.

The display for setting the dividing point appears. The title starts to play in the background.

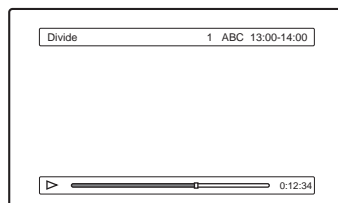

4 Select the dividing point by pressing ◀◀/▶▶, and press ENTER.

The display asks for confirmation. To change the dividing point, select “Change.”

5 Select “OK,” and press ENTER.

The display for entering the title name appears. To use the same title name as before, select “No.”

6 Select “Yes,” and press ENTER to enter a new name.

Follow the explanations on page 40. After you enter a new name, the title is divided in two.

Combining multiple Playlist titles (Combine)

-RWVR

- 1 Press **TITLE LIST** to turn on the **Title List (Playlist)** menu.
If the **Title List (Original)** menu appears, press **TOOLS** and select “**Playlist.**”
- 2 Press **TOOLS** to select “**Combine,**” and press **ENTER**.
The display for selecting titles appears.
- 3 Select a title, and press **ENTER**.
A number indicating the order in which you selected the title appears. To cancel the selection, press **ENTER** again.

Combine

Select the titles to combine.

1	AAB	13:00-14:00	15.9
2	DEF	20:00-21:00	17.9
3	AAB	13:00-14:00	28.9
4	AAB	13:00-14:00	5.10

Buttons: OK, Cancel, Reset All

- 4 Repeat step 3 to select all of the titles you want to combine.
To cancel all of the selections, select “**Reset All.**”
- 5 Select “**OK,**” and press **ENTER**.
The list of titles to be combined appears. To change the selection, select “**Change**” and go to step 3.

Combine

Combine the titles in the following order.

1	AAB	13:00-14:00	15.9	
2	3	AAB	13:00-14:00	28.9
3	4	AAB	13:00-14:00	5.10

Buttons: OK, Change, Cancel

- 6 Select “**OK,**” and press **ENTER**.
The display for selecting a title name from among the selected titles appears. To enter a new name, select “**Enter Text,**” and follow the explanations on page 40.
- 7 Select a name, and press **ENTER**.
The titles are combined.

Before Dubbing

HDD +RW -RWVR -RWVideo +R -R

In this section, “dubbing” refers to “copying a recorded title on the internal hard disk drive (HDD) to another disc, or vice versa.” You can select to dub one title at a time (Title Dubbing – see “Dubbing a Single Title (Title Dub)” on page 74), or multiple titles all at once (Multiple Title Dubbing – see “Dubbing Multiple Titles (Dub Selected Titles)” on page 75).

Before you start, read the following precautions, which are common to both dubbing methods.

Hint

This section deals with dubbing to and from the internal HDD. If you want to record from a digital video camera connected to the DV IN jack, see “DV Dubbing” (page 77). To record from equipment connected to the LINE IN jacks, see “Recording From Connected Equipment Without a Timer” (page 52).

Before you start...

- Select the disc type according to your needs (page 8). This recorder can record on various discs.
- You cannot record both the main and sub sound on a DVD+RW, DVD-RW (Video mode), DVD+R, or DVD-R. For bilingual programs, set “DVD Bilingual Rec.” to either “Main” (default) or “Sub” in Options Setup (page 97).
- Timer recordings and Synchronized recordings do not start during dubbing. Before you start, check the Timer List menu to see if there is any timer recording due to start during dubbing.
- Chapter marks in the original recording do not remain in the dubbed title. Chapter marks are entered according to the “Auto Chapter” setting in Features Setup (page 93).
- For a title whose aspect ratio (16:9 or 4:3) is mixed:
 - When dubbed from the HDD to DVD-RW (Video mode) or DVD-R, the picture size is determined by the setting in “DVD Rec. Picture Size” (page 49).
 - When dubbed from HDD to DVD+RW or DVD+R, the picture size is always 4:3.
 - When dubbed from HDD to DVD-RW (VR mode), the originally recorded picture size is retained.

Hints

- You can dub a Playlist title on a DVD-RW (VR mode) as an original title on the HDD.
- When dubbed from a DVD to the HDD, the picture size and the sound types originally recorded are retained.

Notes

- The recorder may not function as described depending on the disc status. Follow the instructions that appear on the screen.
- When a message appears and indicates that the control information is full, erase unnecessary titles (page 65).
- You cannot dub from DVD VIDEOS or a DVD recorded on other DVD equipment to the HDD.
- Thumbnails that you have set for the originally recorded title (page 34) will not be retained in the dubbed title.

About “Dub Mode”

With this recorder, the recording mode for dubbing is displayed as “Dub Mode.” Two dubbing method are available: High-speed Dubbing and Rec Mode Conversion Dubbing. Read the following and select according to the required time, disc space, and picture quality.

Dubbing at high-speed (High-speed Dubbing)

HDD → +RW / -RWVR / -RWVideo / +R / -R

Allows you to dub what you have stored in the HDD to a high-speed DVD (4x-speed DVD+RWs/2x-speed DVD-RWs/8x-speed DVD+Rs/8x-speed DVD-Rs, or slower versions of each disc type), without changing the recording mode. Dubbing speed is increased when the recording mode of the original title is of a longer recording mode (such as SLP).

Select “Fast” when selecting the “Dub Mode” in “Dubbing a Single Title (Title Dub)” (page 74) or “Dubbing Multiple Titles (Dub Selected Titles)” (page 75). The minimum required time is as follows (approximate).

Example: When a 120 minute-title is dubbed to a high-speed DVD-R in LP mode, dubbing becomes 12 times faster, and takes a minimum of 10 minutes. (120 minutes ÷ 12 = 10 minutes).

Note that speeds shown in the table are an approximate of the maximum dubbing speed.

Speed*1	x2.4-speed	x2-speed	x4-speed
Rec mode	High-speed DVD+RW	High-speed DVD-RW	High-speed DVD+R/DVD-R
HQ	x2.4	x2	x4
HSP	x3.6	x3	x6
SP	x4.8	x4	x8
LP	x7.2	x6	x12
EP	x9.6	x8	x16
SLP	x1	x12	x24*2

*1 Maximum recording speed of this recorder.

*2 When dubbing to DVD+Rs, the dubbing speed is x1-speed.

Notes

- High-speed Dubbing is not available for the following titles:
 - Titles recorded in HQ+.
 - Titles that contain both main and sub sounds (except DVD-RWs (VR mode)).
 - Titles recorded in mixed picture size (4:3 and 16:9 etc.), (except DVD-RWs (VR mode)).
 - Titles recorded in SLP (DVD+RW/DVD+R only).
- When dubbed to a DVD-RW (Video mode)/DVD+RW/DVD+R/DVD-R, erased pictures may remain on the disc.

Rec Mode Conversion Dubbing



Allows you to dub from the HDD to a DVD or vice versa, in a dubbing mode that differs from the original recordings. For example, when you dub an HQ title (data size is large) in SP mode, you can reduce the data size, saving more titles using less space.

Select a mode different from the original recording in “Dub Mode” in the steps of “Dubbing a Single Title (Title Dub)” (page 74) or “Dubbing Multiple Titles (Dub Selected Titles)” (page 75).

When an HQ or HQ+ title is converted to another mode, the recorder automatically assigns an appropriate bit rate, thus retaining the original picture quality as much as possible (“Dynamic VBR Dubbing”).

◆About “VBR”

VBR (Variable Bit Rate) is an effective method of allocating a suitable bit amount per second. Fine detail pictures or dynamically moving pictures are assigned a larger amount, while static pictures are assigned less, for optimum picture quality.

- Variable bit rate (adopted for this recorder)
- Fixed bit rate

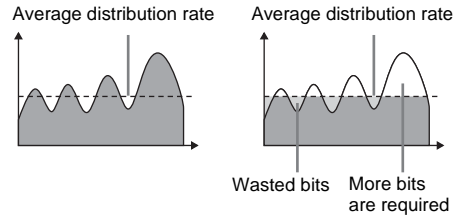

💡 Hint

When you dub an edited title using the Rec Mode Conversion Dubbing method, pauses between scenes are smoothed out.

Note

The picture quality will not improve even if a title is converted to a recording mode of better picture quality.

Dubbing restriction

Some DVD VIDEOS or TV programmes contain copy protection signals such as “Copy-Never” or “Copy-Once.” You cannot record such contents on this recorder (only a grey, blank screen will be recorded). Be especially careful when dubbing on a non-rewritable DVD such as a DVD-R.

Copy protection signals	Original recording	Dubbing
Copy-Free	HDD	+RW -RWVR -RWVideo +R -R
	+RW -RWVR -RWVideo +R -R	HDD
Copy-Once	HDD -RWVR *	recorded in grey.
Copy-Never		recorded in grey.

* Version 1.1 CPRM-compatible DVD-RW (VR mode) only (page 8).

Dubbing (HDD ↔ DVD)

Dubbing a Single Title (Title Dub)

HDD +RW -RWVR -RWVideo +R -R

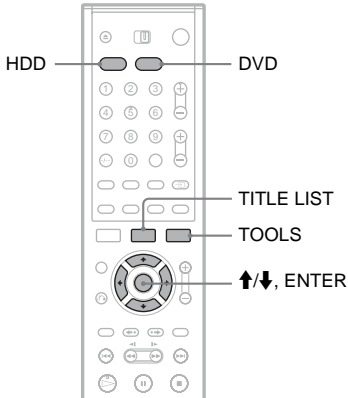

- 1 Insert the DVD that you are going to dub to or from.
- 2 Select the source by pressing HDD or DVD.
- 3 Press TITLE LIST to turn on the Title List menu.
- 4 Select a title and press ENTER. The sub-menu appears.
- 5 Select "Dubbing" and press ENTER. The display for selecting the dubbing mode appears.

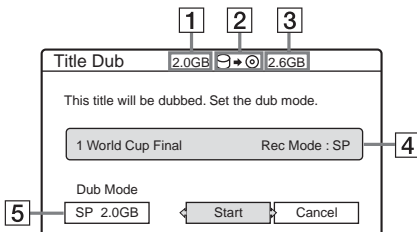

- 1 Size of the title (approximate)
- 2 Direction of dubbing.
- 3 Available space on the disc to be dubbed (approximate).
- 4 Information about the title to be dubbed.

5 Dubbing mode and the space that remains after dubbing (approximate).

6 Select "Dub Mode."

7 Select a dubbing mode by pressing \uparrow/\downarrow .

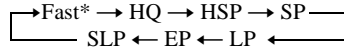

* Appears when High-speed Dubbing is available for the title (page 72).

8 Select "Start," and press ENTER.

To automatically adjust the dubbing mode (Auto Dub Mode)

The recorder adjusts the dubbing mode in order to fit a title on the disc. If there is insufficient disc space in the selected dubbing mode, the following display appears after step 8.

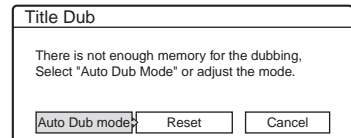

Select "Auto Dub mode" and press ENTER to start dubbing. To manually select another dubbing mode, select "Reset," and go to step 7.

To stop dubbing

Press TOOLS to turn on the TOOLS menu. Or, while the Title List menu is displayed, press ENTER to display the sub-menu. Select "Stop Dubbing," and press ENTER. When asked for confirmation, select "Yes," and press ENTER.

Hints

- If disc space is still insufficient for the selected dubbing mode, erase unnecessary parts of the title, or free up disc space by erasing titles on the disc (page 67).
- You can turn off the recorder without affecting the dubbing. Press \mathbb{I}/\mathbb{C} during dubbing.
- You can start Title Dubbing by selecting "DUBBING" from the System Menu.

Dubbing Multiple Titles (Dub Selected Titles)

HDD +RW -RWVR -RWVideo +R -R

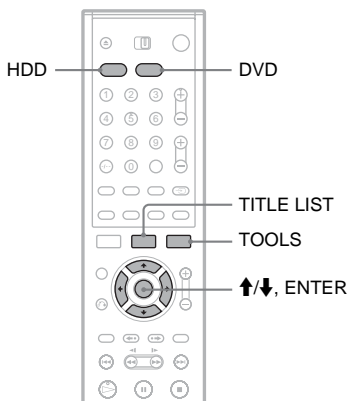

- 1 Insert the DVD that you are going to dub to or from.
- 2 Select the source by pressing HDD or DVD.
- 3 Press TITLE LIST to turn on the Title List menu.
- 4 Press TOOLS. The TOOLS menu appears.
- 5 Select "Dub Selected Titles," and press ENTER. The display for selecting titles appears.

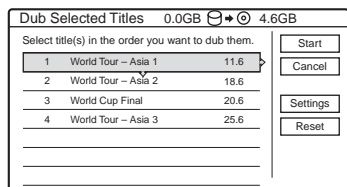

- 6 Select titles in the order you want to dub, and press ENTER. The titles are numbered in the selected order. To cancel the selection, press ENTER again.

- 7 Repeat step 6 to select all of the titles you want to dub.

To make adjustments for each of the titles, select "Settings" (see "Making settings for each title" below). To cancel all of the selections, select "Reset," and go to step 6.

- 8 Select "Start," and press ENTER.

Adjusting the settings for each title

You can make detailed settings for each of the selected titles during Multiple Title Dubbing.

- 1 In step 7 of "Dubbing Multiple Titles (Dub Selected Titles)" (page 75), select "Settings" and press ENTER.

The following display for making the adjustments appears. To re-select titles, select "Change," and go to step 6 of "Dubbing Multiple Titles (Dub Selected Titles)" above. To have the recorder adjust the dubbing mode so all of the selected titles fit in, select "Auto Mode."

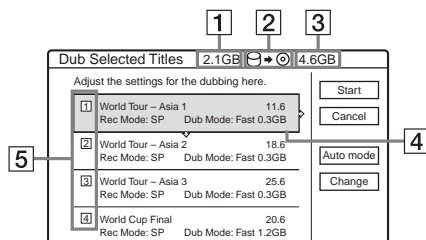

- 1 Total size of the selected titles.
- 2 Direction of dubbing.
- 3 Available space on the disc to be dubbed (approximate).
- 4 Information about the title to be dubbed (title name, original recording mode, dubbing mode, and data size after dubbing).
- 5 Order of dubbing.

- 2 Select the title which you want to adjust, and press ENTER.

The sub-menu appears.

"Dub Mode": Selects the dubbing mode for each title (see page 72).

Dubbing (HDD ↔ DVD)

“Change Order”: Moves the title to change the dubbing order. Press **↑/↓** to select a new location, and press **ENTER**.

“Cancel”: Cancels the title selection. The title is excluded from dubbing.

3 Select an option, and press **ENTER**.

4 When you finish making adjustments, select “Start,” and press **ENTER**.

To automatically adjust the dubbing mode (Auto Dub Mode)

The recorder adjusts the dubbing mode so all of the titles fit in. The same dubbing mode is set for all of the titles. If disc space is insufficient for the selected dubbing mode, the following display appears after step 8 of “Dubbing Multiple Titles” (page 75).

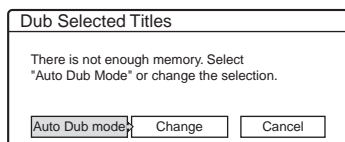

Select “Auto Dub mode” and press **ENTER**. If you have selected only one title, select “OK.”

To stop dubbing

Press **TOOLS** to turn on the **TOOLS** menu. Select “Stop Dubbing” and press **ENTER**. When asked for confirmation, select “Yes,” and press **ENTER**.

Hints

- You can turn off the recorder without affecting the dubbing. Press **I/⏏** during dubbing.
- You can start Multiple Title Dubbing by selecting “DUBBING” from the System Menu.

Before DV Dubbing

This section explains dubbing with a digital video camera via the DV IN jack on the front panel. If you want to dub by way of the LINE IN jacks, see “Recording From Connected Equipment Without a Timer” on page 52.

To record from the DV IN jack

The DV IN jack on this recorder conforms to the i.LINK standard. You can connect any other equipment that has an i.LINK (DV) jack, and record digital signals.

Follow the instructions in “Preparing for recording using the DV IN jack,” and then move on to the section on dubbing. For more information about i.LINK, see “About i.LINK” (page 106).

Hint

If you plan to do additional editing on a disc after the initial dub, use the DV IN jack and record on a DVD-RW (VR mode) or HDD.

Preparing for recording using the DV IN jack

You can connect a digital video camera to the DV IN jack on the recorder to record or edit from a DV format tape. Operation is straightforward because the recorder will fast forward and rewind the tape for you – you do not need to operate your digital video camera. Do the following to start using the “DV Edit” functions of this recorder.

See the instruction manual supplied with the digital video camera as well before connecting.

Notes

- The DV IN jack is for input only. It will not output signals.
- You cannot use the DV IN jack when:
 - your digital video camera does not work with this recorder. Connect the camera to the LINE IN jack and follow the instructions of “Recording From Connected Equipment Without a Timer” (page 52).
 - the input signal is not in DVC-SD format. Do not connect a MICRO MV format digital video camera even if it has an i.LINK jack.
 - the images on the tape contain copy protection signals, which limit recording.

- If you want to play the disc on other DVD equipment, finalize the disc (page 37).

Hookups

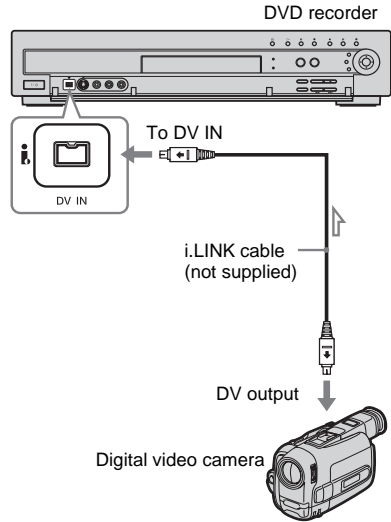

 : Signal flow

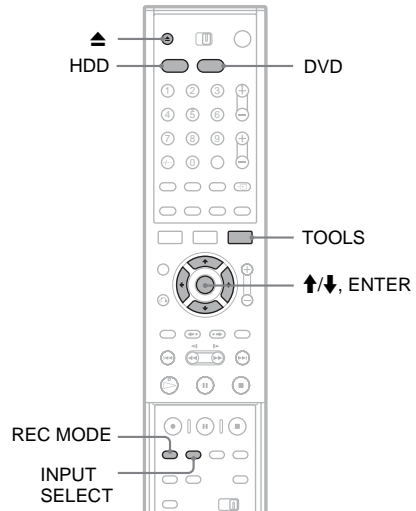

1 Press HDD or DVD.

If you select DVD, press \blacktriangle (open/close) and place a DVD on the disc tray. Press \blacktriangle again to close the disc tray.

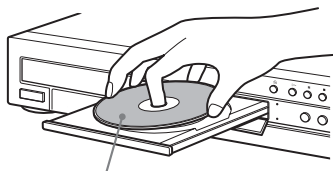

With the recording side facing down

Wait until "LOAD" disappears from the front panel display.

If you use an unused DVD, formatting starts automatically.

2 Insert the source DV format tape into your digital video camera.

For the recorder to record or edit, your digital video camera must be set to video playback mode.

3 Press INPUT SELECT on the remote repeatedly to select "DV."

The front panel display changes as follows:

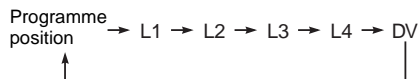

4 Press REC MODE on the remote repeatedly to select the recording mode.

The recording mode changes as follows:

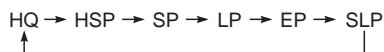

For details about the recording mode, see page 41.

5 Press TOOLS on the remote to select "DV Audio Input," and press ENTER. Then, select the setting for the audio input.

"Stereo1" (default): Records original sound only. Normally select this when dubbing a DV format tape.

"Mix": Records both stereo 1 and 2.

"Stereo2": Records additional audio only.

Select "Mix" or "Stereo2" only if you have added a second audio channel when recording with your digital video camera.

You are ready to start dubbing. Select one of the dubbing methods on the following pages.

💡 Hints

- You can turn off the recorder during dubbing. The recorder completes dubbing even after being turned off.
- You can adjust the settings for the recording picture before recording. See "Adjusting the recording picture quality and size" (page 49).

Notes

- You cannot connect more than one piece of digital video equipment to the recorder.
- You cannot control the recorder using another device or another recorder of the same model.
- You cannot record date, time, or the contents of the cassette memory onto the disc.
- If you record from a DV format tape with a sound track that is recorded in multiple sampling frequencies (48 kHz, 44.1 kHz, or 32 kHz), no sound or an unnatural sound will be output when playing back the sampling frequency switch point on the disc.
- In order to use this recorder's Auto Scene Chaptering function (pages 79, 80), be sure to correctly set the clock on your digital video camera before shooting.
- The recorded picture may be momentarily affected if the picture size of the source image changes, or if there is nothing recorded on the tape.

Recording an Entire DV Format Tape (One Touch Dubbing)

HDD +RW -RWVR -RW_{Video} +R -R

You can record the entire contents of a DV format tape onto a disc with a single press of the ONE TOUCH DUBBING button. The recorder controls the digital video camera for the whole process, and completes the recording.

◆How chapters are created

The dubbed contents on the disc become one title, and the title is divided into chapters. For the HDD and a DVD-RW (VR mode), every shooting on the tape becomes a chapter on the disc (Auto Scene Chaptering function). For other discs, the recorder divides the title in either 6 or 15-minute intervals, according to the setting in “Auto Chapter” in Features Setup.

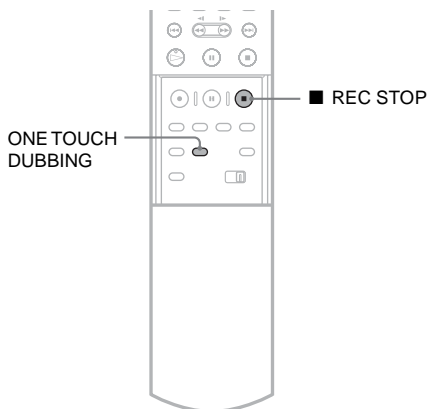

Follow steps 1 to 5 of “Preparing for recording using the DV IN jack” (page 77), and press **ONE TOUCH DUBBING** on the remote.

The recorder rewinds the tape and then starts recording the tape contents.

When the recording is finished, the recorder rewinds the tape in the digital video camera.

To stop during recording

Open the remote’s cover and press ■ **REC STOP**. Note that it may take a few seconds for the recorder to stop recording.

💡 Hints

- If you set “Finalize Disc” to “Auto” in Features Setup (page 96), the recorded disc (except DVD-RW (VR mode)) will automatically be finalized after recording is finished.
- You can play back a previously recorded title on the HDD while One Touch Dubbing is in progress.

Notes

- When a blank space between the recordings on the tape continues for more than five minutes, One Touch Dubbing ends automatically.
- The recorder records a blank for five minutes before it stops dubbing. To stop the blank recording, press ■ **REC STOP**.

Program Edit

HDD **+RW** **-RWVR** **-RWVideo** **+R** **-R**

You can select scenes from a DV format tape, and then automatically record selected scenes to a disc of your choice.

To use this function, you will do the following:

Connect your digital video camera and prepare for recording



Select and edit the scenes you want to dub

Using the recorder's remote control, fast forward or rewind the tape to select the scenes. At this point, the selected scenes are not copied to the disc. The recorder only remembers the IN and OUT points of the scenes that you selected for dubbing. You can also reset, erase, or change the order of the scenes.



Dub the selected scenes to a disc

After you have selected the scenes, the recorder will fast forward and rewind the tape automatically and record the scenes to a disc of your choice.

◆How chapters are created

The dubbed contents on the disc become one title, and the title is divided into chapters. For a DVD-RW (VR mode) and the HDD, every shooting on the tape and each selected scene becomes a chapter on the disc (Auto Scene Chaptering function). For other discs, the recorder divides the title in either 6 or 15-minute intervals, according to the setting in "Auto Chapter" in Features Setup.

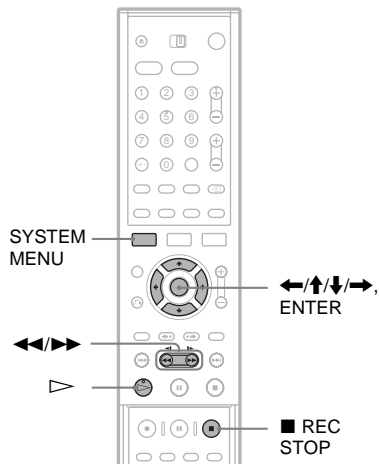

1 Follow steps 1 to 5 of "Preparing for recording using the DV IN jack" (page 77), and press SYSTEM MENU.

2 Select "DV EDIT," and press ENTER.

The display asks if you want to start selecting scenes.

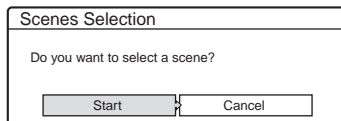

- If you have previously saved a program, the display asks if you want to edit an existing program or to create a new program. To resume editing the existing program, select "Saved Data," and go to step 6.

- 3 Select "Start," and press ENTER.**
 The display for setting the IN point (start of the scene) appears.
 The scene starts to play in the background.

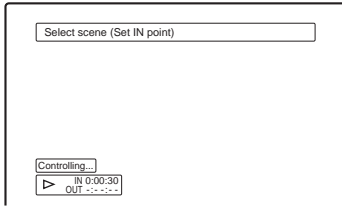

- 4 Select the IN point by pressing ◀◀/▶▶, and press ENTER.**
 The display for setting the OUT point (end of the scene) appears. The scene starts to play in the background from the IN point.

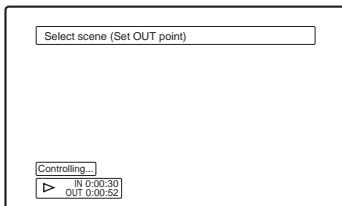

- 5 Select the OUT point by pressing ◀◀/▶▶, and press ENTER.**
 The display asks if you want to add the selected scene to the Scene List menu. To preview the scene, select "Preview." To reset either the IN or OUT point, select "Change IN" or "Change OUT," and repeat from step 4.

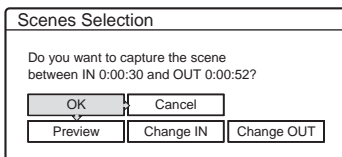

- 6 Select "OK," and press ENTER.**
 A new Scene List menu appears with the selected scene.

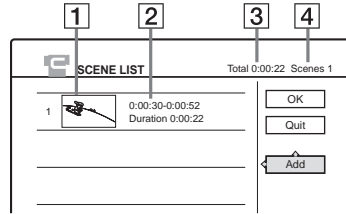

- 1** Thumbnail picture
2 Time information
3 Total duration of the program
4 Total number of scenes

- 7 When you finish adding scenes, select the scene you want to edit, and press ENTER.**
 The sub-menu appears.

"Move": Changes the scene order. Follow the explanations on the screen to change the order by pressing ↑/↓ and ENTER.
 "Erase": Erases the scene. When asked for confirmation, select "OK."
 "Preview": Plays the selected scene.
 "Change IN": Changes the start of the scene. Repeat from step 4.
 "Change OUT": Changes the end of the scene. Repeat from step 5.

- 8 When you finish editing the Scene List, select "OK," and press ENTER.**
 The display for entering the title name appears. To enter a new name, select "Enter," and follow the explanations on page 40.

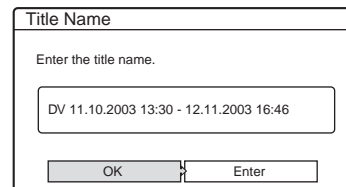

9 Select "OK," and press ENTER.

The default title name is fixed, and the display asks if you want to start recording. To change the disc media, select "Media" and press \uparrow/\downarrow . To change the dubbing mode, select "Dub Mode" and press \uparrow/\downarrow .

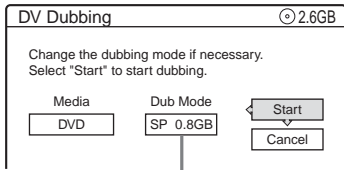

Data capacity required for the dubbing.

10 Select "Start," and press ENTER.

The recorder starts recording the tape contents as programmed.

- If the recording does not fit due to the dubbing mode you selected, the display asks if you want to continue. To change the dubbing mode, select "Reset" and repeat from step 9. To have the recorder adjust the dubbing mode, select "Auto Dub Mode."
- If there is not enough disc space even after changing the dubbing mode, the display asks if you want to record halfway. To continue, select "OK."

To stop during recording

Open the remote's cover and press \blacksquare REC STOP. Note that it may take a few seconds for the recorder to stop recording.

Notes

- The disc may not be recorded as programmed if the tape's time code is not sequential or there are blanks between the recordings on the tape. In this case, see "Recording From Connected Equipment Without a Timer" (page 52).
- The start and end points of a program may be different from what you have set if the source DV format tape is in any of the following conditions:
 - Recording mode was changed during the recording.
 - There is a blank space in the recorded portion of the tape.
- If you set the beginning of the tape as the IN point and the end point as the OUT point, the IN and OUT points may change slightly during dubbing.
- You cannot set a scene to be shorter than one second.

Settings and Adjustments

Using the Setup Displays

By using the Setup Displays, you can make various adjustments to items such as picture and sound, as well as select a language for the subtitles.

The Setup Displays are used in the following way.

Note

Playback settings stored in some titles take priority over the Setup Display settings, and not all of the functions described may work.

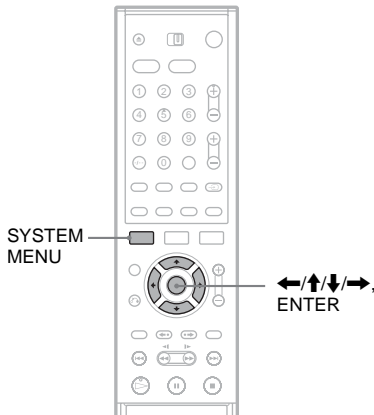

- 1 Press **SYSTEM MENU** while the recorder is in stop mode. The System Menu appears.

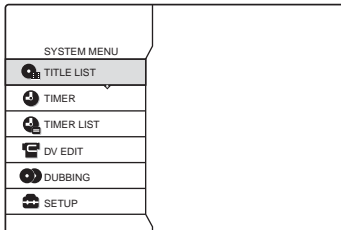

- 2 Select **"SETUP,"** and press **ENTER**. The Setup Display appears.

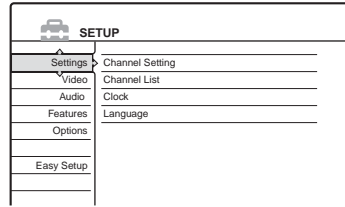

- 3 Select **"Settings," "Video," "Audio," "Features," "Options,"** or **"Easy Setup,"** and press **ENTER**. The selected Setup Display appears. Example: "Video" setup

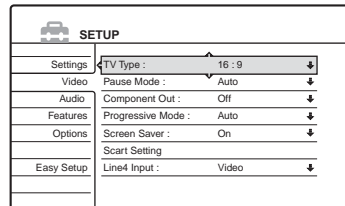

- 4 Select the item you want to set up, and press **ENTER**. Available options for the item appear. Example: "TV Type"

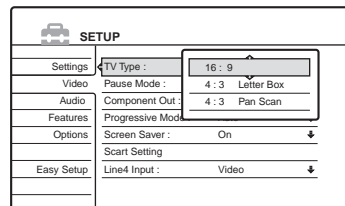

Some items display a dialogue box that provides further detailed settings. Example: The following dialogue box appears when "Parental Control" in Features Setup is selected.

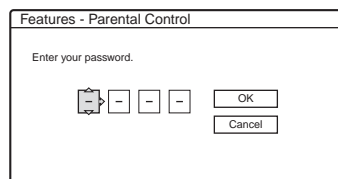

In this case, see “Parental Control” in “Recording and Parental Control Settings (Features)” (page 93).

5 Select an option, and press ENTER.

The currently selected option is displayed next to the setup item.

Example: when “4:3 Letter Box” is set.

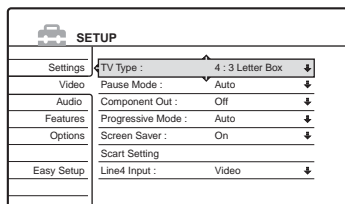

To turn off the display

Press SYSTEM MENU repeatedly.

Aerial Reception and Language Settings (Settings)

The Settings Setup helps you to make tuner, clock, and channel settings for the recorder.

Select “Settings” in the Setup Display. To use the display, see “Using the Setup Displays” (page 83).

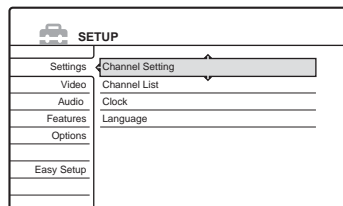

Channel Setting

Presets channels manually.

If some channels could not be set using the Easy Setup function, you can set them manually.

If there is no sound or if the picture is distorted, the wrong tuner system may have been preset during Easy Setup. Set the correct tuner system manually in the steps below.

- 1 Follow steps 1 to 3 of “Using the Setup Displays” (page 83) to select “Settings” in the Setup Display.
- 2 Select “Channel Setting,” and press ENTER.

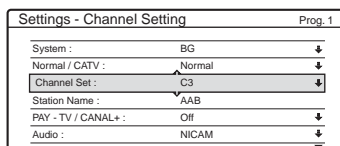

- 3 Press PROG +/- to select the programme position.

Selected programme position

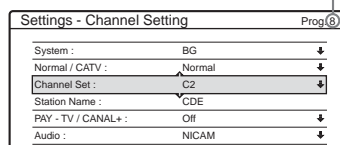

4 Select "System," and press ENTER.

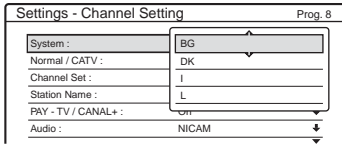

5 Select an available TV system, BG, DK, I, or L, and press ENTER (page 86).

BG	Select this when in West European countries, except those listed in "Receivable channels" (page 86).
DK	Select this when in East European countries.
I	Select this when in Great Britain/Ireland.
L	Select this when in France.

6 Select "Normal/CATV," and press ENTER.

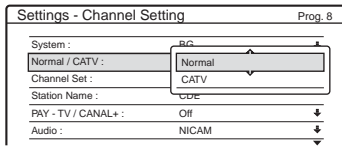

7 Select "Normal." and press ENTER.
To set CATV (Cable Television) channels, select "CATV."

8 Select "Channel Set," and press ENTER.

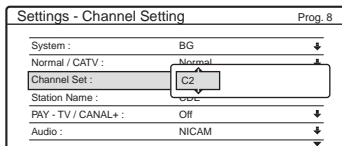

9 Press \uparrow/\downarrow repeatedly until the channel you want is displayed, then press ENTER.
The channels are scanned in the order shown in the table below.

- If you know the number of the channel you want, press the number buttons. For example, for channel 5, first press "0" and then press "5." Then press ENTER.

10 Select "Audio," and press ENTER.

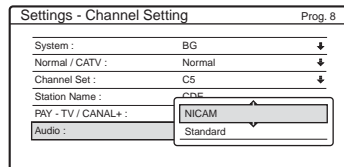

NICAM	Normally, select this.
Standard	Select this if the sound from NICAM broadcasts is not clear.

11 Select "NICAM," and press ENTER.

12 Select "AFT" and press ENTER.

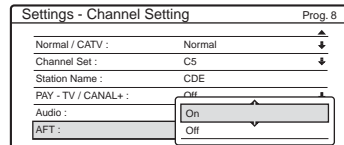

On	Turns on the Auto Fine Tuning function. Normally, select this.
Off	Allows you to adjust the pictures manually.

13 Select "On" to turn on AFT, and press ENTER.

- If the Auto Fine Tuning function does not work effectively, select "Off" and press ENTER. When the fine tuning bar appears, press \leftarrow/\rightarrow to obtain a clearer picture, and press ENTER.

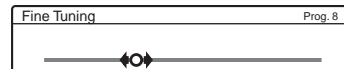

To preset another channel, repeat from step 3.

- 4 Press \uparrow/\downarrow until the selected channel row moves to the desired programme position. The selected channel is inserted at the new programme position.

Settings - Channel List		
Prog	Channel	Name
1	C3	AAB
2	C12	
3	C21	
4	C5	FGH
5	C23	
6	C24	PQR

- 5 Press ENTER to confirm the setting.
- 6 To change or disable the programme position of another station, repeat from step 3.

Note

Be sure to correctly select the programme position you want to disable. If you disable the wrong programme position by mistake, you need to reset that channel manually.

Clock

Auto Adjust

Turns on the Auto Clock Set function when a channel in your local area broadcasts a time signal.

- Follow steps 1 to 3 of "Using the Setup Displays" (page 83) to select "Settings" in the Setup Display.
- Select "Clock," and press ENTER.

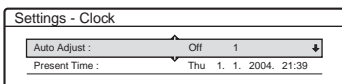

- Select "Auto Adjust," and press ENTER.

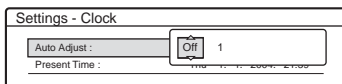

- Select "On," and press \rightarrow .
- Press \uparrow/\downarrow repeatedly until the programme position of the station that carries a time signal appears, and press ENTER.

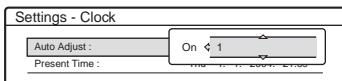

- If the recorder does not receive a time signal from any station, "Auto Adjust" returns to "Off" automatically and the menu for setting the clock manually appears on the screen.

Hint

If you set "Auto Adjust" to "On," the Auto Clock Set function is activated whenever the recorder is turned off.

Note

The Auto Clock Set function does not work while the recorder is standing by for Synchro-Recording.

◆ To set the clock manually

If the Auto Clock Set function did not set the clock correctly for your local area, try another station for the Auto Clock Set function or set the clock manually.

- Follow steps 1 to 3 of "Using the Setup Displays" (page 83) to select "Settings" in the Setup Display.
- Select "Clock," and press ENTER.
- Select "Auto Adjust," and press ENTER.

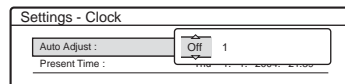

- Select "Off," and press ENTER.
- Select "Present Time," and press ENTER.

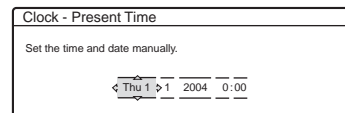

- Press \uparrow/\downarrow to set the day, and press \rightarrow . Set the month, year, hour, and minutes in sequence. Press \leftarrow/\rightarrow to select the item to be set, then press \uparrow/\downarrow to set the numbers. The day of the week is set automatically.

To change the numbers, press \leftarrow to return to the item to be changed, and press \uparrow/\downarrow .

- Press ENTER to start the clock.

Language

OSD (On-Screen Display)

Switches the display language on the screen.

DVD Menu (DVD VIDEO only)

Switches the language for the DVD menu.

Audio (DVD VIDEO only)

Switches the language of the sound track.

When you select "Original," the language given priority in the disc is selected.

Subtitle (DVD VIDEO only)

Switches the language of the subtitles recorded on the disc.

When you select "Audio Follow," the subtitle language changes according to the language you selected for the sound track.

Hint

If you select "Others" in "DVD Menu," "Subtitle," or "Audio," select and enter a language code from "Language Code List" (page 114) using the number buttons.

Note

If you select a language in "DVD Menu," "Subtitle," or "Audio" that is not recorded on the DVD VIDEO, one of the recorded languages will be automatically selected.

Video Settings (Video)

Video settings will adjust items related to the image, such as size and colour.

Choose the settings according to the type of TV, tuner, or decoder connected to the DVD recorder.

- 1 Press **SYSTEM MENU** while the recorder is in stop mode.
- 2 Select "**SETUP**," and press **ENTER**.
- 3 Select "**Video**," and press **ENTER**.
The Video Setup appears with the following options. The default settings are underlined.

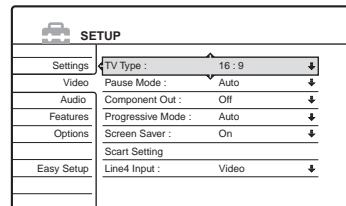

TV Type

Selects the aspect ratio of the connected TV (4:3 standard or wide).

<u>16:9</u>	Select this when connecting to a wide-screen TV or TV with a wide mode function.
4:3 Letter Box	Select this when connecting to a 4:3 screen TV. Displays a wide picture with bands on the upper and lower portions of the screen.
4:3 Pan Scan	Select this when connecting to a 4:3 screen TV. Automatically displays a wide picture on the entire screen and cuts off the portions that do not fit.

16:9



4:3 Letter Box



4:3 Pan Scan

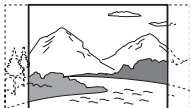

Note

Depending on the disc, “4:3 Letter Box” may be selected automatically instead of “4:3 Pan Scan” or vice versa.

Pause Mode (HDD/DVDs only)

Selects the picture quality in pause mode.

<u>Auto</u>	The picture, including subjects that move dynamically, is output with no jitter. Normally select this position.
Frame	The picture, including subjects that do not move dynamically, is output in high resolution.

Component Out

Selects whether or not to output video signals from the COMPONENT VIDEO OUT jacks.

<u>On</u>	Outputs the component video signals. Select this when you want to view progressive signals.
<u>Off</u>	Outputs no signals.

Notes

- When you set “Line1 Output” to “RGB,” you cannot set “Component Out” to “On.”
- When you connect the recorder to a monitor or projector via only the COMPONENT VIDEO OUT jacks, do not select “Off.” If you select “Off” in this case, the picture may not appear.

Progressive Mode

DVD software can be divided into two types: film based software and video based software. Video based software is derived from TV, such as dramas and sit-coms, and displays images at 30 frames/60 fields (25 frames/50 fields) per second. Film based software is derived from film and displays images at 24 frames per second. Some DVD software contains both Video and Film.

In order for these images to appear natural on your screen when output in PROGRESSIVE mode (50 or 60 frames per second), the progressive video signal needs to be converted to match the type of DVD software that you are watching.

You can fine-tune the progressive 525p/625p video signal that is output when you press PROGRESSIVE (“PROGRESSIVE” lights up). Note that you must connect to a progressive format TV using the COMPONENT VIDEO OUT jacks (page 15).

<u>Auto</u>	Automatically detects the software type (Film-based or Video-based) and selects the appropriate conversion mode. Normally select this position.
Video	Fixes the conversion mode to the mode for Video-based software.

Screen Saver

The screen saver image appears when you do not use the recorder for more than 10 minutes while an on-screen display, such as the System Menu, is displayed on your TV screen. The screen saver image helps prevent your display device from becoming damaged (ghosting).

<u>On</u>	Turns on the screen saver function.
Off	Turns off the function.

Scart Setting

Sets the method of inputting/outputting signals from the SCART jacks on the rear panel of the recorder. Select an option for each of the items below according to the combination of jacks and methods that you are going to use.

◆Line1 Output

Selects a method of outputting video signals for the LINE 1-TV jack.

RGB	Outputs RGB signals.
<u>Video</u>	Outputs video signals.
S Video	Outputs S-video signals.

Notes

- If your TV does not accept S-video or RGB signals, no picture appears on the TV screen even if you select "S Video" or "RGB." See the instructions supplied with your TV.
- You cannot select "RGB" when "Component Out" above is set to "On."
- SMARTLINK is available only when "Video" is selected.

◆Line3 Input

Selects a method of inputting video signals for the LINE 3/DECODER jack. The picture will not be clear if this setting does not match the type of video input signal.

<u>Video/RGB</u>	Inputs video signals or RGB signals.
Decoder	Select this when connecting to a PAY-TV/Canal Plus decoder.
S Video	Inputs S-video signals.

◆Line3 Output

Selects a method of outputting video signals for the LINE 3/DECODER jack.

<u>Video</u>	Outputs video signals.
S Video	Outputs S-video signals.

Line4 Input

Selects a method of inputting video signals for the LINE 4 IN jack on the rear panel of the recorder.

<u>Video</u>	Inputs video signals.
S Video	Inputs S-video signals.

Audio Settings (Audio)

The Audio Setup allows you to adjust the sound according to the playback and connection conditions.

1 Press **SYSTEM MENU** while the recorder is in stop mode.

2 Select **"SETUP,"** and press **ENTER.**

3 Select **"Audio,"** and press **ENTER.**

The Audio Setup appears with the following options. The default settings are underlined.

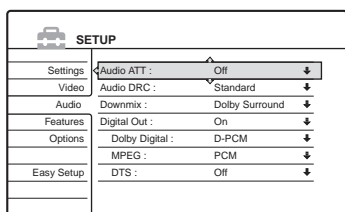

Audio ATT (attenuation)

If the playback sound is distorted, set this item to "On." The recorder reduces the audio output level. This function affects the output of the following jacks:

- LINE 2 OUT AUDIO L/R jacks
- LINE 1-TV jack
- LINE 3/DECODER jack

<u>On</u>	Select this when the playback sound from the speakers is distorted.
<u>Off</u>	Normally select this position.

Audio DRC (Dynamic Range Control) (DVDs only)

Makes the sound clear when the volume is turned down when playing a DVD that conforms to "Audio DRC." This affects the output from the following jacks:

- LINE 2 OUT AUDIO L/R jacks
- LINE 1-TV jack
- LINE 3/DECODER jack
- DIGITAL OUT (OPTICAL or COAXIAL) jack only when "Dolby Digital" is set to "D-PCM" (page 92).

<u>Standard</u>	Normally select this position.
TV Mode	Makes low sounds clear even if you turn the volume down.
Wide Range	Gives you the feeling of being at a live performance.

Downmix (DVDs only)

Switches the method for mixing down to two channels when you play a DVD which has rear sound elements (channels) or is recorded in Dolby Digital format. For details on the rear signal components, see "Checking the Play Information and Playing Time" (page 38). This function affects the output of the following jacks:

- LINE 2 OUT AUDIO L/R jacks
- LINE 1-TV jack
- LINE 3/DECODER jack
- DIGITAL OUT (OPTICAL or COAXIAL) jack when "Dolby Digital" is set to "D-PCM" (page 92).

<u>Dolby Surround</u>	Normally select this position. Multi-channel audio signals are output to two channels for enjoying surround sounds.
Normal	Multi-channel audio signals are downmixed to two channels for use with your stereo.

Digital Out

Selects if audio signals are output via the DIGITAL OUT (OPTICAL or COAXIAL) jacks.

<u>On</u>	Normally select this position. When you select "On," see "To set the digital output signal" for further settings.
Off	The influence of the digital circuit upon the analogue circuit is minimal.

◆To set the digital output signal

The following setup items switch the method of outputting audio signals when you connect a component such as an amplifier (receiver) with a digital input jack.

For connection details, see "Connecting the Audio Cords" (page 17).

Select "Dolby Digital," "MPEG," and "DTS" after setting "Digital Out" to "On."

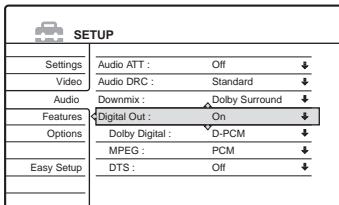

SETUP	
Settings	Audio ATT : Off ↓
Video	Audio DRC : Standard ↓
Audio	Downmix : Dolby Surround ↓
Features	Digital Out : <u>On</u> ↓
Options	Dolby Digital : D-PCM ↓
	MPEG : PCM ↓
Easy Setup	DTS : Off ↓

If you connect a component that does not accept the selected audio signal, a loud noise (or no sound) will come out from the speakers, and may affect your ears or cause speaker damage.

• Dolby Digital (HDD/DVDs only)

Selects the type of Dolby Digital signal.

<u>D-PCM</u>	Select this when the recorder is connected to an audio component lacking a built-in Dolby Digital decoder. You can select whether the signals conform to Dolby Surround (Pro Logic) or not by making adjustments to the "Downmix" item in Audio Setup (page 91).
Dolby Digital	Select this when the recorder is connected to an audio component with a built-in Dolby Digital decoder.

• MPEG (DVD VIDEO only)

Selects the type of MPEG audio signal.

<u>PCM</u>	Select this when the recorder is connected to an audio component without a built-in MPEG decoder. If you play MPEG audio sound tracks, the recorder outputs stereo signals via the DIGITAL OUT (COAXIAL) jack.
MPEG	Select this when the recorder is connected to an audio component with a built-in MPEG decoder.

• DTS (DVD VIDEO only)

Selects whether or not to output DTS signals.

<u>On</u>	Select this when the recorder is connected to an audio component with a built-in DTS decoder.
Off	Select this when the recorder is connected to an audio component without a built-in DTS decoder.

Note

When you use the DIGITAL OUT (COAXIAL) jack to listen to MPEG audio signals and set "MPEG" to "MPEG" in Audio Setup, no sound will come from your speakers if you select one of the TVS modes.

Recording and Parental Control Settings (Features)

The Features Setup allows you to adjust recording and parental control settings.

- 1 Press **SYSTEM MENU** while the recorder is in stop mode.
- 2 Select "**SETUP,**" and press **ENTER**.
- 3 Select "**Features,**" and press **ENTER**.
The Features Setup appears with the following options. The default settings are underlined.

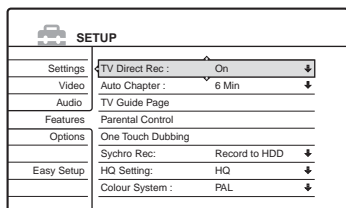

TV Direct Rec (HDD/DVD+RW/DVD-RW/DVD+R/DVD-R only)

<u>On</u>	Allows you to easily record what you are watching on the TV using SMARTLINK.
Off	Turns off the TV Direct Rec function.

Auto Chapter

Automatically divides a recording (a title) into chapters by inserting chapter markings at a specified interval. The markings are inserted while the recording is being made.

Off	No chapter mark is inserted.
<u>6Min</u>	Inserts chapter marks at approximately 6-minute intervals.
15Min	Inserts chapter marks at approximately 15-minute intervals.

Notes

- Depending upon the size of the recording being made, the actual interval may vary from the interval selected in "Auto Chapter." The selected interval should only be used as an approximation to create chapters.
- This function is not available when dubbing DV tapes to HDD and DVD-RWs (VR mode). Chapter marks are automatically entered where the recordings start on the tape (pages 79, 80).

TV Guide Page

Some broadcast systems ensure a Teletext service* in which the complete programmes and their data (title, date, channel, recording start time, etc.) are stored day by day. A TV guide page corresponds to each day of the week. When recording a programme, the recorder automatically takes the programme name from the Teletext pages and stores it as the title name. The TV guide page numbers depend entirely on the broadcast itself and may be subject to change. If so, you may have to set those TV guide page numbers manually in the TV Guide Page menu.

* Not available in some areas.

- 1 After step 3 above, select "TV Guide Page" and press **→** or **ENTER**.
The TV Guide Page menu appears.
- 2 Select the programme position for which you want to set or change the TV guide page by pressing **PROG +/-**.

- The TV guide page numbers (Example: P301) appear automatically when the recorder detects them.

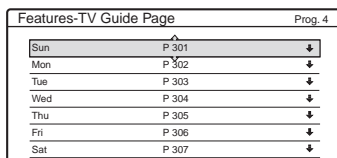

- If no page numbers are detected (P000), you have to set the appropriate TV guide page number manually.

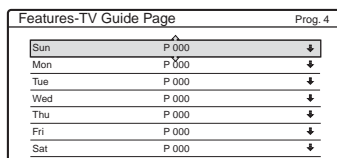

- 3 Select the TV guide page number you want to modify, and press ENTER.

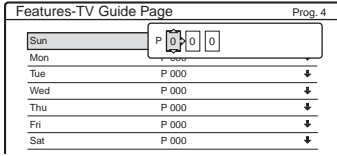

- 4 Press the number buttons or $\leftarrow/\uparrow/\downarrow/\rightarrow$ to enter the TV guide page number, and press ENTER to confirm the setting.
- If you make a mistake, press CLEAR to re-enter the correct number.

To set or change another TV guide page number, repeat steps 3 and 4 above.

Hint

To view Teletext information on your TV screen during a broadcast, switch to your TV's tuner by pressing \rightarrow (TV/video).

Notes

- In step 4 above, enter "000" if you do not want to use the TV guide page number for automatic labelling. The recorder will instead store a default title name (programme position, start time - stop time).
- Refer to the Teletext information on your TV screen to obtain the TV guide page number with programme titles and their start times.
- If the Teletext TV guide has a page which always shows the programmes for the current day, this page should be input for all days.
- If you start recording more than three minutes before the programme is scheduled to start, the correct label information may not be transferred.
- Note that this function may not work correctly with programmes broadcast from some stations.
- If the broadcast system updates the Teletext information at the moment recording starts, the title label may not correspond to the recorded programme. In this case, you may have to manually enter the correct title (page 65).

Parental Control (DVD VIDEO only)

Playback of some DVD VIDEOS can be limited according to a predetermined level, such as the age of the users. Scenes may be blocked or replaced with different scenes.

- 1 After step 3 above, select "Parental Control," and press ENTER.
 - If you have not entered a password, the display for registering a new password appears.

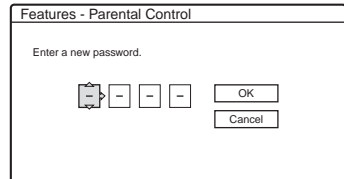

- When you have already registered a password, the display for entering the password appears.

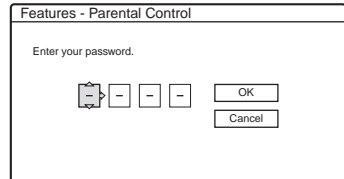

- 2 Enter your four-digit password using the number buttons, then select "OK" and press ENTER.

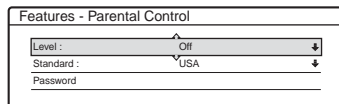

- 3 Select "Standard," and press \rightarrow or ENTER. The selection items for "Standard" are displayed.

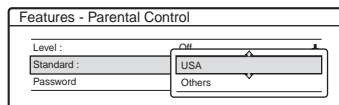

- 4 Select a geographic area as the playback limitation level, and press ENTER.
The area is selected.
- When you select “Others,” press the number buttons to select and enter an area code in the table (see below). Then select “OK” and press ENTER.
- 5 Select “Level,” and press ENTER.
The selection items for “Level” are displayed.

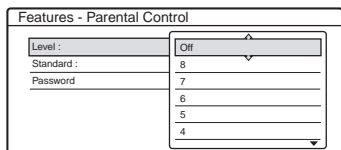

The lower the value, the stricter the limitation.

- 6 Select the level, and press ENTER.
The Parental Control setting is complete.

To cancel the Parental Control setting for the disc, set “Level” to “Off” in step 6.

To change the password, select “Password” in step 3, and press ENTER. When the display for registering a password appears, enter a new four-digit password using the number buttons, then select “OK” and press ENTER.

Notes

- If you forget your password, you will have to reset it by selecting “Parental Control” under “Factory Setup” in Options Setup (page 97).
- When you play discs which do not have the Parental Control function, playback cannot be limited on this recorder.
- Depending on the disc, you may be asked to change the Parental Control level while playing the disc. In this case, enter your password, then change the level.

◆Area code

Standard	Code number
Argentina	2044
Australia	2047
Austria	2046
Belgium	2057
Brazil	2070
Canada	2079
Chile	2090
China	2092
Denmark	2115
Finland	2165
France	2174
Germany	2109
India	2248
Indonesia	2238
Italy	2254
Japan	2276
Korea	2304
Malaysia	2363
Mexico	2362
Netherlands	2376
New Zealand	2390
Norway	2379
Pakistan	2427
Philippines	2424
Portugal	2436
Russia	2489
Singapore	2501
Spain	2149
Sweden	2499
Switzerland	2086
Thailand	2528
United Kingdom	2184

One Touch Dubbing

Displays the following options for the One Touch Dub function.

◆Finalize Disc (for all recordable discs except DVD-RW in VR mode)

Selects whether or not to finalize the disc automatically following One Touch Dubbing (page 79).

Auto	Automatically finalizes the disc following One Touch Dubbing.
<u>Manual</u>	Allows you to finalize the disc manually.

Colour System

Selects the colour system when playing VIDEO CDs (including Super VCDs).

<u>PAL</u>	Plays a disc in PAL colour system.
NTSC	Plays a disc in NTSC colour system.

Synchro Rec

Selects the recording destination used for Synchro-Recording (page 51).

<u>Record to HDD</u>	Records to the HDD.
Record to DVD	Records to DVDs.

HQ Setting (HDD only)

Selects the HQ mode used for recording on the HDD (page 41).

HQ+	Records in higher quality (approximate 15 Mbps).
<u>HQ</u>	Records in the standard HQ mode.

Disc and Remote Control Settings/Factory Settings (Options)

The Options Setup allows you to set up other operational settings.

- 1 Press **SYSTEM MENU** while the recorder is in stop mode.
- 2 Select "**SETUP**," and press **ENTER**.
- 3 Select "**Options**," and press **ENTER**.

The Options Setup appears with the following options. The default settings are underlined.

SETUP	
Settings	<u>Format DVD :</u> VR
Video	<u>HDD Bilingual Rec. :</u> Main
Audio	<u>DVD Bilingual Rec. :</u> Main
Features	<u>Dimmer :</u> Normal
Options	<u>Auto Display :</u> On
	<u>Command Mode :</u> DVD3
Easy Setup	<u>Factory Setup</u>

Format DVD (DVD-RW only)

The recorder automatically starts formatting in VR mode or Video mode, whichever is selected below, when a new, unformatted DVD-RW is inserted.

<u>VR</u>	Automatically formats the disc in VR mode.
Video	Automatically formats the disc in Video mode.

HDD Bilingual Rec. (HDD only)

Selects the sound to be recorded on the HDD.

<u>Main</u>	Records the main sound for the bilingual programme.
Sub	Records the sub sound for the bilingual programme.
Main+Sub	Records the main and sub sounds for the bilingual programme.

Note

If you set the recording mode to be changed while dubbing from a DVD to the HDD, the sound recorded in the source (DVD) is applied regardless of this setting.

DVD Bilingual Rec. (for all recordable discs except DVD-RW in VR mode)

Selects the sound to be recorded on the recordable disc. This setting is not necessary when recording on DVD-RWs (VR mode) that record both the main and sub sounds.

<u>Main</u>	Records the main sound for the bilingual programme.
Sub	Records the sub sound for the bilingual programme.

Dimmer

Adjusts the lighting of the front panel display.

<u>Normal</u>	Bright lighting.
Power Save	Low lighting. Turns off the lighting when the power is off.

Auto Display

<u>On</u>	Automatically displays information on the screen when the recorder is turned on, etc.
Off	Displays information only when DISPLAY is pressed.

Command Mode

Changes the Command Mode of the recorder if other DVD equipment is assigned the same Command Mode. Be sure to match the Command Mode switch on the remote to the setting made here. For details, see "If you have a Sony DVD player or more than one Sony DVD recorder" on page 21.

<u>DVD1</u>	Select this if the default Command Mode conflicts with other DVD equipment.
DVD2	Select this if the default Command Mode conflicts with other DVD equipment.
<u>DVD3</u>	The default Command Mode of the recorder.

Factory Setup

Allows you to select the setup settings by group, and return them to their default settings. Note that all of your previous settings will be lost.

- 1 After step 3 above, select "Factory Setup," and press **➡** or ENTER.
The display for selecting a group of settings appears.
- 2 Select the group of settings you want to return to default from "Settings," "Video," "Audio," "Features," "Options," "Parental Control," and "All," and press **➡** or ENTER.
- 3 Select "Start," and press ENTER.
The selected settings return to their default settings.
- 4 Press ENTER when "Finish" appears.

Easy Setup (Resetting the Recorder)

Select this to run the Easy Setup programme.

- 1** Press SYSTEM MENU while the recorder is in stop mode.
- 2** Select "SETUP," and press ENTER.
- 3** Select "Easy Setup," and press ENTER.

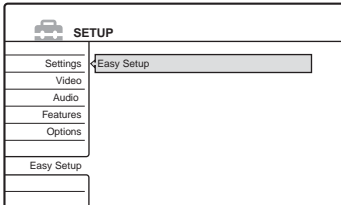

- 4** Press ENTER.
- 5** Select "Start," and press ENTER.
- 6** Follow the instructions for Easy Setup (page 22) from step 5.

Troubleshooting

If you experience any of the following difficulties while using the recorder, use this troubleshooting guide to help remedy the problem before requesting repairs. Should any problem persist, consult your nearest Sony dealer.

Power

The power does not turn on.

- ➔ Check that the mains lead is connected securely.

Picture

There is no picture.

- ➔ Re-connect all connecting cords securely.
- ➔ The connecting cords are damaged.
- ➔ Check the connection to your TV (page 13).
- ➔ Switch the input selector on your TV (such as to "VCR") so that the signal from the recorder appears on the TV screen.
- ➔ Check that "Scart Setting" in Video Setup is set to the appropriate item that conforms to your system (page 90).
- ➔ If you connect the recorder to your TV via only the COMPONENT VIDEO OUT jacks, set "Component Out" in Video Setup to "On" (page 89).
- ➔ This recorder cannot record NTSC signals.

Picture noise appears.

- ➔ If the picture output signal from your recorder passes through your VCR to get to your TV, or if you are connected to a combination TV/VIDEO player, the copy-protection signal applied to some DVD programmes could affect picture quality. If you still experience this problem even when you connect your recorder directly to your TV, try connecting your recorder to your TV's S VIDEO input.
- ➔ You have set the recorder to progressive format (the PROGRESSIVE indicator lights up) even though your TV cannot accept the progressive signal. In this case, press PROGRESSIVE until the progressive indicator turns off.

- ➔ Even if your TV is compatible with progressive format (525p/625p) signals, the image may be affected when you set the recorder to progressive format. In this case, press PROGRESSIVE so that the PROGRESSIVE indicator turns off and the recorder is set to normal (interlace) format.
- ➔ You are playing a DVD recorded in a colour system that is different from your TV.
- ➔ Noises may appear in the pictures recorded on the HDD, which is due to the characteristics of HDD, and is not a malfunction.

TV programme reception does not fill the screen.

- ➔ Set the channel manually in "Channel Setting" in Settings Setup (page 84).
- ➔ Select the correct source using the INPUT SELECT button, or select a channel of any TV programme using the PROG +/- buttons.

TV programme pictures are distorted.

- ➔ Reorient the TV aerial.
- ➔ Adjust the picture (see the TV's instruction manual).
- ➔ Place the recorder and TV farther apart.
- ➔ Place the TV and any bunched aerial cables farther apart.
- ➔ The RF cable is connected to the AERIAL OUT jack on the recorder. Connect the cable to the AERIAL IN jack.

TV channels cannot be changed.

- ➔ The channel is disabled (page 86).
- ➔ A timer recording started, which changed the channels.

The picture from equipment connected to the recorder's input jack does not appear on the screen.

- ➔ If the equipment is connected to the LINE 1-TV jack, select "L1" in the front panel display by pressing PROG +/- or INPUT SELECT. If the equipment is connected to the LINE 2 IN jacks, select "L2" in the front panel display by pressing PROG +/- or INPUT SELECT. If the equipment is connected to the LINE 4 IN jacks, select "L4" in the front panel display by pressing PROG +/- or INPUT SELECT. If the equipment is connected to the LINE 3/DECODER jack, select "L3" in the front panel display by pressing PROG +/- or INPUT SELECT.

If the equipment is connected to the DV IN jack, (this is usually for a digital video camera connection), select "DV" in the front panel display by pressing PROG +/- or INPUT SELECT.

- ➔ When an S video cable is connected to the recorder's LINE 4 IN jack, set "Line4 Input" in Video Setup to "S Video" (page 90).

The playback picture or TV programme from the equipment connected through the recorder is distorted.

- ➔ If the playback picture output from a DVD player, VCR, or tuner goes through your recorder before reaching your TV, the copy-protection signal applied to some programmes could affect picture quality. Disconnect the playback equipment in question and connect it directly to your TV.

The picture does not fill the screen.

- ➔ Set "TV Type" in Video Setup in accordance with the aspect ratio of your TV (page 88).

The picture does not fill the screen, even though the aspect ratio is set in "TV Type" in Video Setup.

- ➔ The aspect ratio of the title is fixed.

The picture is black and white.

- ➔ Check that "Line1 Output" of "Scart Setting" in Video Setup is set to the appropriate item that conforms to your system (page 90).
- ➔ If you are using a SCART cord, be sure to use one that is fully wired (21 pins).

Sound

There is no sound.

- ➔ Re-connect all connections securely.
- ➔ The connecting cord is damaged.
- ➔ The input source setting on the amplifier or the connection to the amplifier is incorrect.
- ➔ The recorder is in reverse play, fast-forward, slow motion, or pause mode.
- ➔ If the audio signal does not come through the DIGITAL OUT (OPTICAL or COAXIAL) jacks, check the Audio Setup settings (page 91).

Sound distortion occurs.

- ➔ Set "Audio ATT" in Audio Setup to "On" (page 91).

Sound is noisy.

- ➔ When playing a CD with DTS sound tracks, noise will come from the LINE 2 OUT AUDIO L/R jacks, LINE 1-TV jack, or LINE 3/DECODER jack (page 58).

The sound volume is low.

- ➔ The sound volume is low on some DVDs. The sound volume may improve if you set "Audio DRC" in Audio Setup to "TV Mode" (page 91).
- ➔ Set "Audio ATT" in Audio Setup to "Off" (page 91).

An alternate audio track cannot be recorded.

- ➔ When recording from connected equipment, set "Line Audio Input" in TOOLS menu to "Bilingual" (page 52).
- ➔ Multilingual tracks (main and sub) cannot be recorded on DVD+RWs, DVD-RWs (Video mode), DVD+Rs, or DVD-Rs. To record the language, select "Main" or "Sub" of "DVD Bilingual Rec." in Options Setup before recording (page 97). To record both the main and sub sounds, record on a DVD-RW (VR mode).
- ➔ Any discs other than the HDD or DVD-RWs (VR mode) cannot be used for recording both main and both sounds. To record on the HDD, set "HDD Bilingual Rec." in Options Setup to "Main+Sub" (page 97).
- ➔ If you have connected an AV amplifier to the DIGITAL OUT (OPTICAL or COAXIAL) jacks and want to change the audio track for a DVD-RW (VR mode) during playback, set "Dolby Digital" in Audio Setup to "D-PCM" (page 92).

Playback

The recorder does not play any type of disc (except HDD).

- ➔ The disc is upside down. Insert the disc with the labelled side facing up.
- ➔ The disc is not correctly inserted.
- ➔ Moisture has condensed inside the recorder. Remove the disc and leave the recorder turned on for about half an hour until the moisture evaporates.
- ➔ If the disc was recorded on another recorder, the recorder cannot play the disc if it was not finalized (page 37).

The recorder does not start playback from the beginning.

- ➔ Resume play was activated (page 54).
- ➔ You have inserted a DVD whose Title menu or DVD menu automatically appears on the TV screen when it is first inserted. Use the menu to start playback.

The recorder starts playing automatically.

- ➔ The DVD VIDEO features an auto playback function.

Playback stops automatically.

- ➔ If the DVD has an auto pause signal, the recorder stops playback at the auto pause signal.

Some functions such as Stop, Search, or Slow-motion Play cannot be performed.

- ➔ Depending on the DVD, you may not be able to do some of the operations above. See the instruction manual supplied with the disc.

The language for the sound track cannot be changed.

- ➔ Multilingual tracks are not recorded on the DVD being played.
- ➔ The DVD VIDEO prohibits the changing of the language for the sound track.
- ➔ Try changing the language using the DVD VIDEO's menu.

The subtitle language cannot be changed or turned off.

- ➔ Multilingual subtitles are not recorded on the DVD VIDEO.
- ➔ The DVD VIDEO prohibits changing of the subtitles.
- ➔ Try changing the subtitle using the DVD VIDEO's menu.
- ➔ The subtitles cannot be changed for the titles recorded on this recorder.

The angles cannot be changed.

- ➔ Multi-angles are not recorded on the DVD VIDEO being played.
- ➔ You are trying to change the angles when “” does not appear on the TV screen (page 56).
- ➔ The DVD VIDEO prohibits changing angles.
- ➔ Try changing the angle using the DVD VIDEO's menu.

- ➔ The angles cannot be changed for the titles recorded on this recorder.

The MP3 audio tracks do not play.

- ➔ The MP3 audio tracks are not recorded in a format that the recorder can play (page 62).

Recording/Timer recording/Editing

The programme position cannot be changed from the channel you are recording.

- ➔ Set the TV's input source to “TV.”

Recording does not start immediately after you press **●** REC.

- ➔ Operate the recorder only after “LOAD,” “FORMAT,” or “INFOWRITE” disappears from the front panel display.

Nothing was recorded even though you set the timer setting correctly.

- ➔ There was a power failure during recording.
- ➔ The recorder's internal clock stopped due to a power failure that lasted for more than 1 hour. Reset the clock (page 87).
- ➔ The channel was disabled after the timer recording was set. See “Channel Setting” on page 84.
- ➔ Disconnect the mains lead from the mains, and connect it again.
- ➔ “PDC/VPS Scan Off” was selected in the TOOLS menu (page 43).
- ➔ The programme contains copy protection signals that restrict copying.
- ➔ Other timer setting overlapped the timer setting (page 47).
- ➔ There is no DVD inside the recorder.
- ➔ There is not enough disc space for the recording.
- ➔ The recorder was in the process of DV Dubbing.

Recording does not stop immediately after you press **■** REC STOP.

- ➔ It will take a few seconds for the recorder to input disc data before recording can stop.

Recording does not stop after you press **■** STOP.

- ➔ Open the remote's cover and press **■** REC STOP.

Timer recording is not complete or did not start from the beginning.

- ➔ There was a power failure during recording. If the power recovers when there is a timer recording, the recorder resumes recording. Should the power failure continue for more than 1 hour, reset the clock (page 87).
- ➔ Other timer setting overlapped the timer setting (page 47).
- ➔ Disc space was not enough.
- ➔ The PDC/VPS function is working.

Contents previously recorded were erased.

- ➔ Data that has been recorded on a DVD with a PC will be erased from the disc when the disc is inserted.
- ➔ “Auto Title Erase” in the TOOLS menu (appears when you press TOOLS while the Timer List menu is turned on) is set to “On” (page 47).
- ➔ The title was updated and recorded over (page 42).

The PDC/VPS function does not operate.

- ➔ Check that the clock and date are set correctly.
- ➔ Check that the PDC/VPS time you set is the correct one (there might be a mistake in the TV programme guide). If the broadcast you wanted to record did not send the good PDC/VPS information, the recorder will not start recording.
- ➔ If the reception is poor, the PDC/VPS signal might be altered and the recorder might not start recording.
- ➔ “PDC/VPS Scan Off” is selected (page 43).

Recording from the equipment with a timer

Nothing was recorded even though you set the Synchro-Rec setting correctly.

- ➔ You forgot to turn off the connected equipment. Turn off the connected equipment and set the recorder to Synchro-Rec standby mode (page 51).
- ➔ The recorder was not set to the Synchro-Recording standby mode. Press SYNCHRO REC to have the recorder stand by for recording. Make sure the SYNCHRO REC indicator lights up on the front panel (page 51).
- ➔ The recorder is connected to the TV output jack of the connected equipment.

Synchro-Recording does not complete.

- ➔ The timer setting for the connected equipment overlapped the recorder’s timer setting (page 52).
- ➔ There was a power failure during the recording.

The recorder automatically starts recording when the satellite receiver is turned on.

- ➔ The Synchro-Rec function was activated. Turn off the satellite receiver and cancel the Synchro-Rec function (page 51).

Display

The clock has stopped.

- ➔ Set the clock again (page 87).
- ➔ The clock stopped due to a power failure that lasted for more than 1 hour. Reset the clock (page 87).

The TIMER REC indicator is flashing.

- ➔ The disc does not have enough space.
- ➔ Insert a recordable disc inside the recorder.

The recording mode indication is incorrect.

- ➔ When the recording or dubbing is less than three minutes, the recording mode indication may be displayed incorrectly. The actual recording itself is correctly made in the selected recording mode.

The clock does not appear in the front panel display.

- ➔ “Dimmer” in Options Setup is set to “Power Save” (page 97).

Remote control

The remote does not function.

- ➔ Batteries are weak.
- ➔ The remote is too far from the recorder.
- ➔ The remote’s manufacturer code returned to the default setting when you replaced the batteries. Reset the code (page 20).
- ➔ Turn on the recorder.
- ➔ The remote is not pointed at the remote sensor on the recorder.
- ➔ Different command modes are set for the recorder and remote. Set the same command mode (page 21).
- ➔ Set the TV/DVD switch to DVD (page 21).

Other Sony equipment responds to the remote.

- ➔ The same command mode is set for both the equipment and recorder. Set a different command mode for the recorder (page 21).

Others

The recorder does not operate properly.

- ➔ Restart the recorder. Press down **I/⏻** on the recorder for more than ten seconds until “WELCOME” appears in the front panel display.
- ➔ When static electricity, etc., causes the recorder to operate abnormally, turn off the recorder and wait until the clock appears in the front panel display. Then, unplug the recorder and after leaving it off for a while, plug it in again.

Five numbers or letters are displayed in the front panel display.

- ➔ The self-diagnosis function was activated (see the table on page 104).

The disc tray does not open after you press **⏻** (open/close).

- ➔ It may take a few seconds for the disc tray to open after you have recorded or edited a DVD. This is because the recorder is adding disc data to the disc.

The disc tray does not open and “TRAY LOCKED” appears in the front panel display.

- ➔ Contact your Sony dealer or local authorized Sony service facility.

“RECOVERY” appears in the front panel display.

- ➔ The recorder’s recovery function was activated when the recorder was turned on because the power was turned off or failed during recording. Leave the recorder on until “RECOVERY” disappears from the front panel display.

“HDD ERROR” appears in the front panel display.

- ➔ The hard disk error occurred. Press down **I/⏻** on the recorder for ten seconds to restart the recorder. If this does not resolve the problem, format the recorder’s HDD by pressing down the HDD button on the recorder for more than ten seconds until “WELCOME” appears in the front panel display. Note that all the contents recorded on the HDD will be erased.

“FAN ERROR” appears in the front panel display.

- ➔ Check that the vent on the rear of the recorder is not blocked. Then, turn off the recorder, wait until the clock appears in the front panel display, and disconnect the mains lead. Leave the recorder off for a while, then re-connect the mains lead, and press **I/⏻** on the recorder.

Mechanical sound is heard when the recorder is off.

- ➔ While the recorder is adjusting the clock for the Auto Clock Set function or scanning the channels for the PDC/VPS function, operational noises (such as the internal fan) may be heard, even when the power is off. This is not a malfunction.

The disc tray does not open and you cannot remove the disc after you press **⏻** (open/close).

- ➔ Turn off the recorder. Once the clock appears in the front panel display, disconnect the mains lead. Connect it again while pressing down **⏻** on the recorder, and release the button when the disc tray opens. Then, keep **I/⏻** on the recorder pressed for about ten seconds until “WELCOME” appears in the front panel display.

“LOCKED” appears in the front panel display.

- ➔ The disc tray is locked. Cancel the Child Lock (page 55).

Self-diagnosis Function (When letters/numbers appear in the display)

When the self-diagnosis function is activated to prevent the recorder from malfunctioning, a five-character service number (e.g., C 13 50) with a combination of a letter and four numbers appears in the front panel display. In this case, check the following table.

First three characters of the service number	Cause and/or corrective action
C 13	The DVD is dirty. ➔ Clean the disc with a soft cloth.
C 31	The DVD/CD is not inserted correctly. ➔ Re-insert the disc correctly.
E XX (xx is a number)	To prevent a malfunction, the recorder has performed the self-diagnosis function. ➔ Contact your nearest Sony dealer or local authorized Sony service facility and give the five-character service number. Example: E 61 10

Notes About This Recorder

On operation

- If the recorder is brought directly from a cold to a warm location, or is placed in a very damp room, moisture may condense on the lenses inside the recorder. Should this occur, the recorder may not operate properly. In this case, remove the disc and leave the recorder turned on for about half an hour until the moisture evaporates.
- When you move the recorder, take out any discs. If you don't, the disc may be damaged.

On adjusting volume

Do not turn up the volume while listening to a section with very low level inputs or no audio signals. If you do, the speakers may be damaged when a peak level section is played.

On cleaning

Clean the cabinet, panel, and controls with a soft cloth slightly moistened with a mild detergent solution. Do not use any type of abrasive pad, scouring powder or solvent such as alcohol or benzene.

About repairing the hard disk drive

- It may be necessary to access data stored on the hard disk for testing purposes; there is no intention to copy or store the data, titles or any other information.
- If replacement or initialization (format) is required, the hard disk will be formatted at our discretion. In this case, please note that all of the contents recorded there will be erased (including any data found to violate copyright law).

On cleaning discs

Do not use a commercially available cleaning disc. It may cause a malfunction.

Notes about the discs

- To keep the disc clean, handle the disc by its edge. Do not touch the surface. Dust, fingerprints, or scratches on the disc may cause it to malfunction.



- Do not expose the disc to direct sunlight or heat sources such as hot air ducts, or leave it in a car parked in direct sunlight as the temperature may rise considerably inside the car.
- After playing, store the disc in its case.
- Clean the disc with a cleaning cloth. Wipe the disc from the centre out.



- Do not use solvents such as benzene, thinner, commercially available cleaners, or anti-static spray intended for vinyl LPs.
- Do not use the following discs.
 - A disc that has a non-standard shape (e.g., card, heart).
 - A disc with a label or sticker on it.
 - A disc that has cellophane tape or sticker adhesive on it.

Specifications

System

Laser: Semiconductor laser

Channel coverage:

PAL/SECAM (B/G, D/K, I, L)

VHF: E2 to E12, R1 to R12, F1 to F10, Italian A to H, Ireland A to J, South Africa 4 to 13/

UHF: E21 to E69, R21 to R69, B21 to B69,

F21 to F69/CATV: S01 to S05, S1 to S20,

France B to Q/HYPER: S21 to S41

The above channel coverage merely ensures the channel reception within these ranges. It does not guarantee the ability to receive signals in all circumstances.

Video reception: Frequency synthesizer system

Audio reception: Split carrier system

Aerial out: 75-ohm asymmetrical aerial socket

Timer: Clock: Quartz locked/Timer indication:

24-hour cycle (digital)/Power back-up

duration: 1 hour

Video recording format: MPEG Video

Audio recording format/applicable bit rate:

Dolby Digital/2 ch, 256 kbps

When you play PCM sound tracks with a 96 kHz sampling frequency, the output signals from the DIGITAL OUT (OPTICAL or COAXIAL) jack are converted to 48 kHz sampling frequency.

Inputs and outputs

LINE 2 OUT

(AUDIO): Phono jack/2 Vrms/10 kilohms

(VIDEO): Phono jack/1.0 Vp-p

(S VIDEO): 4-pin mini DIN/Y:1.0 Vp-p, C: 0.3 Vp-p (PAL)

LINE 2 IN/LINE 4 IN

(AUDIO): Phono jack/2 Vrms/more than 22 kilohms

(VIDEO): Phono jack/1.0 Vp-p

(S VIDEO): 4-pin mini DIN/Y:1.0 Vp-p, C: 0.3 Vp-p (PAL)

LINE 1 -TV: 21-pin

CVBS IN/OUT

S-Video/RGB OUT (upstream)

LINE 3/DECODER: 21-pin

CVBS IN/OUT

S-Video/RGB IN

S-Video OUT (downstream)

Decoder

DV IN: 4-pin/i.LINK S100**DIGITAL OUT (OPTICAL):** Optical output
jack/-18 dBm (wave length: 660 nm)**DIGITAL OUT (COAXIAL):** Phono jack/0.5
Vp-p/75 ohms**COMPONENT VIDEO OUT****(Y, P_B/C_B, P_R/C_R):**Phono jack/Y: 1.0 Vp-p, P_B/C_B: 0.7 Vp-p,P_R/C_R: 0.7 Vp-p**General****Power requirements:** 220-240 V AC, 50/60 Hz**Power consumption:**

RDR-HX900: 54 W

RDR-HX1000: 55 W

Dimensions (approx.): 430 × 89 × 346 mm
(width/height/depth) incl. projecting parts**Hard disk drive capacity:**

RDR-HX900: 160 GB

RDR-HX1000: 250 GB

Mass (approx.): 5.9 kg**Operating temperature:** 5 °C to 35 °C**Operating humidity:** 25 % to 80 %**Supplied accessories:**

Audio/video cord (1)

Mains lead (1)

Aerial cable (1)

Remote commander (remote) (1)

R6 (size AA) batteries (2)

Specifications and design are subject to change without notice.

Compatible colour systems

This recorder is designed to record using the PAL colour system and play back using the PAL or NTSC colour systems.

The signals of the SECAM colour system can be received or recorded but played back in the PAL colour system only. Recording of video sources based on other colour systems cannot be guaranteed.

About i.LINK

The DV IN jack on this recorder is an i.LINK-compliant DV IN jack. This section describes the i.LINK standard and its features.

What is i.LINK?

i.LINK is a digital serial interface for handling digital video, digital audio and other data in two directions between equipment having the i.LINK jack, and for controlling other equipment.

i.LINK-compatible equipment can be connected by a single i.LINK cable. Possible applications are operations and data transactions with various digital AV equipment. When two or more i.LINK-compatible equipment are connected to this recorder in a daisy chain, operations and data transactions are possible with not only the equipment that this recorder is connected to but also with other devices via the directly connected equipment.

Note, however, that the method of operation sometimes varies according to the characteristics and specifications of the equipment to be connected, and that operations and data transactions are sometimes not possible on some connected equipment.

Note

Normally, only one piece of equipment can be connected to this recorder by the i.LINK cable (DV connecting cable). When connecting this recorder to i.LINK-compatible equipment having two or more i.LINK jacks (DV jacks), see the instruction manual of the equipment to be connected.

About the name "i.LINK"

i.LINK is a more familiar term for IEEE 1394 data transport bus proposed by SONY, and is a trademark approved by many corporations. IEEE 1394 is an international standard standardized by the Institute of Electrical and Electronics Engineers.

i.LINK baud rate

i.LINK's maximum baud rate varies according to the equipment. Three maximum baud rates are defined:

- S100 (approx. 100 Mbps*)
- S200 (approx. 200 Mbps)
- S400 (approx. 400 Mbps)

The baud rate is listed under "Specifications" in the instruction manual of each equipment. It is also indicated near the i.LINK jack on some equipment.

The maximum baud rate of equipment on which it is not indicated such as this unit is "S100."

When units are connected to equipment having a different maximum baud rate, the baud rate sometimes differs from the indicated baud rate.

* What is Mbps?

Mbps stands for megabits per second, or the amount of data that can be sent or received in one second. For example, a baud rate of 100 Mbps means that 100 megabits of data can be sent in one second.

i.LINK functions on this recorder

For details on how to dub when this recorder is connected to other video equipment having DV jacks, see page 77.

The DV jack on this recorder can only input DVC-SD signals. It cannot output signals. The DV jack will not accept MICRO MV signals from equipment such as a MICRO MV digital video camera with an i.LINK jack.

For further precautions, see the notes on page 77.

For details on precautions when connecting this recorder, also see the instruction manuals for the equipment to be connected.

Required i.LINK cable

Use the Sony i.LINK 4-pin-to-4-pin cable (during DV dubbing).

i.LINK and  are trademarks.

Guide to Parts and Controls

For more information, see the pages in parentheses.

Front panel

Buttons on the recorder have the same function as the buttons on the remote if they have the same or similar names.

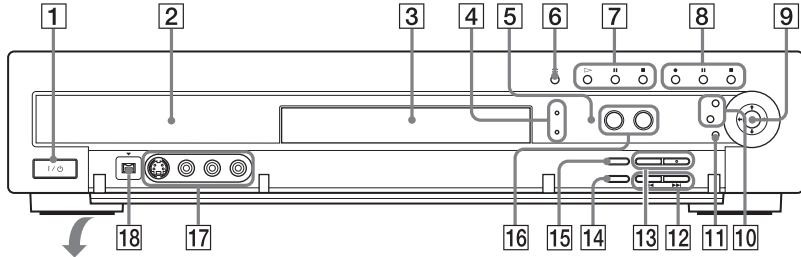

- | | |
|--|--|
| 1 I/O (on/standby) button (22) | 9 ←/↑/↓/→/ENTER button (22) |
| 2 Front panel display (39, 110) | 10 SYSTEM MENU button (32) |
| 3 Disc tray (42) | TOOLS button (33) |
| 4 TIMER REC indicator (42)
SYNCHRO REC indicator (51) | 11 ↻ RETURN button (33) |
| 5 [Sensor icon] (remote sensor) (19) | 12 ◀◀/▶▶ (previous/next) buttons (56) |
| 6 [Open/Close icon] (open/close) button (42) | 13 PROGRAM +/- buttons (48) |
| 7 ▷ (play) button (54)
[Pause icon] (pause) button (56)
[Stop icon] (stop) button (54) | 14 REC MODE button (41) |
| 8 ● REC button (48)
[Pause icon] REC PAUSE button (48)
[Stop icon] REC STOP button (48) | 15 INPUT SELECT button (52, 77) |
| | 16 DVD button/indicator (33)
HDD button/indicator (33) |
| | 17 LINE 2 IN (S VIDEO/VIDEO/AUDIO L/R) jacks (27) |
| | 18 [DV icon] DV IN jack (77) |

Remote

Buttons on the remote have the same function as the buttons on the recorder if they have the same or similar names. Buttons with an orange dot next to them can be used with your TV when the TV/DVD switch is set to TV.

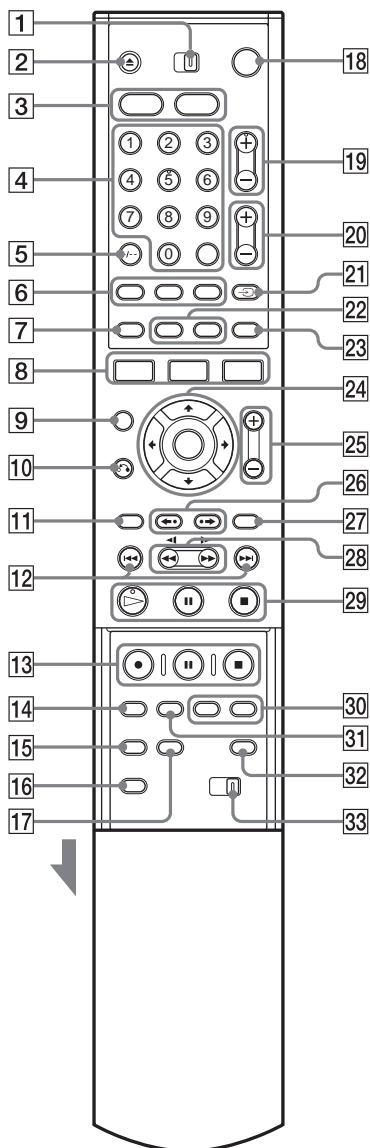

- 1 TV/DVD switch (20)
- 2 ▲ (open/close) button (42, 56)
- 3 HDD button (33)
DVD button (33)
- 4 Number buttons (44, 61)
SET button (44)
The number 5 button has a tactile dot*.
- 5 CLEAR/--- (ten digit) button (44)
- 6 ○○○ (audio) button (56)
⋯ (subtitle) button (56)
∞ (angle) button (56)
- 7 **TIMER** button (42, 44)
- 8 **SYSTEM MENU** button (32)
TITLE LIST button (33, 54, 65)
TOOLS button (33)
- 9 CURSOR MODE button (33)
- 10 ↶ RETURN button (33)
- 11 TOP MENU button (54)
- 12 ◀◀ (previous)/▶▶ (next) buttons (56)
- 13 ● REC button (48)
▬▬ REC PAUSE button (48)
■ REC STOP button (48)
- 14 REC MODE button (41)
- 15 SYNCHRO REC button (51)
- 16 PROGRESSIVE button (16)
- 17 ONE TOUCH DUBBING button (79)
- 18 I/O (on/standby) button (22)
- 19 PROG (programme) +/- buttons (48)
The + button has a tactile dot*.
- 20 ▲ (volume) +/- buttons (20)
- 21 TV (TV/video), TV/DVD button (20)
- 22 DISPLAY button (38)
TIME/TEXT button (38)
- 23 (wide mode) button (20)
- 24 ←/↑/↓/→/ENTER button (22)
- 25 ZOOM +/- buttons (33)
- 26 ◀• (instant replay)/•▶ (instant advance) buttons (56)

- 27 MENU button (54)
- 28 ◀◀◀◀/▶▶▶▶ (search) buttons (56)
- 29 ▷ (play) button (54)
The button has a tactile dot*.
⏸ (pause) button (56)
■ (stop) button (54)
- 30 CHAPTER MARK/ERASE buttons (68)
- 31 INPUT SELECT button (52, 77)
- 32 SUR (surround) button (56)
- 33 COMMAND MODE switch (DVD 1,2,3) (21)

* Use the tactile dot as a reference when operating the recorder.

Front panel display

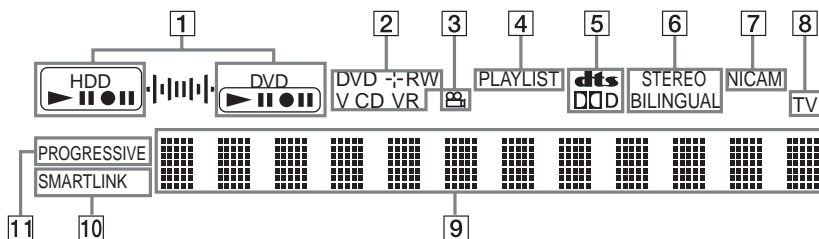

- 1 HDD/DVD indicators
Displays the selected media and the playing/recording/dubbing status.
- 2 Disc type*/recording format
- 3 ∞ (angle) indicator (56)
- 4 PLAYLIST indicator (34)
- 5 Audio signal indicators (38)
- 6 STEREO/BILINGUAL indicators (41)
- 7 NICAM indicator (41)
- 8 TV indicator (48)
- 9 Displays the following (39):
- Playing time/remaining time
 - Current title/chapter/track/index number
 - Recording time/recording mode
 - Clock
 - Programme position
 - TV Direct Rec indication (48): “TV” appears in the right most two digits.
- 10 SMARTLINK indicator (15)
- 11 PROGRESSIVE indicator (16)

* Displays DATA CDs as “CD.”

Hint

You can turn off the front panel display when the recorder is turned off by setting “Dimmer” to “Power Save” in Options Setup (page 97).

Rear panel

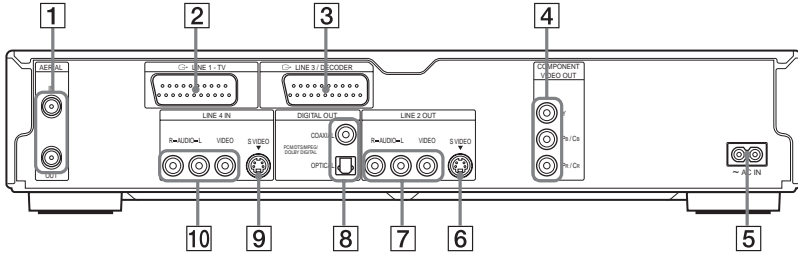

- 1** AERIAL IN/OUT jacks (13)
- 2** LINE 1 - TV jack (14)
- 3** LINE 3/DECODER jack (26)
- 4** COMPONENT VIDEO OUT (Y, Pb/Cb, Pr/Cr) jacks (14)
- 5** AC IN terminal (19)
- 6** LINE 2 OUT (S VIDEO) jack (14)
- 7** LINE 2 OUT (AUDIO L/R/VIDEO) jacks (14, 17)
- 8** DIGITAL OUT (COAXIAL/OPTICAL) jacks (17)
- 9** LINE 4 IN (S VIDEO) jack (27)
- 10** LINE 4 IN (AUDIO L/R/VIDEO) jacks (27)

Glossary

Chapter (page 61)

Sections of a picture or a music feature that are smaller than titles. A title is composed of several chapters. Depending on the disc, no chapters may be recorded.

Copy protection signals (page 42)

Copy restriction set by copyright owners, etc. These signals are included in some software or TV programmes and restrict recording on this recorder.

Dolby Digital (page 92)

Digital audio compression technology developed by Dolby Laboratories. This technology conforms to multi-channel surround sound. The rear channel is stereo and there is a discrete subwoofer channel in this format. Dolby Digital provides the same discrete channels of high quality digital audio found in "Dolby Digital" theater surround sound systems.

Good channel separation is realized because all of the channel data is recorded discretely, and little deterioration occurs because all channel data processing is digital.

DTS (page 92)

Digital audio compression technology by Digital Theater Systems, Inc. This technology conforms to multi-channel surround sound. The rear channel is stereo and there is a discrete subwoofer channel in this format. DTS provides the same discrete channels of high quality digital audio.

Good channel separation is realized because all of the channel data is recorded discretely, and little deterioration occurs because all channel data processing is digital.

DVD+R (page 8)

A DVD+R (read "plus R") is a recordable disc that is the same size as a DVD VIDEO. Contents can be recorded only once to a DVD+R, and will have the same format as a DVD VIDEO.

DVD+RW (page 8)

A DVD+RW (read "plus RW") is a recordable and rewritable disc. DVD+RWs use a recording format that is comparable to the DVD VIDEO format.

DVD-R (page 8)

A DVD-R is a recordable disc that is the same size as a DVD VIDEO. Contents can be recorded only once to a DVD-R, and will have the same format as a DVD VIDEO.

DVD-RW (page 8)

A DVD-RW is a recordable and rewritable disc that is the same size as a DVD VIDEO. The DVD-RW has two different modes: VR mode and Video mode. DVDs created in Video mode have the same format as a DVD VIDEO, while discs created in VR (Video Recording) mode allow the contents to be programmed or edited.

DVD VIDEO (page 8)

A disc that contains up to eight hours of moving pictures on a disc the same diameter as a CD. The data capacity of a single-layer and single-sided DVD is 4.7 GB (Giga Byte), which is 7 times that of a CD. The data capacity of a double-layer and single-sided DVD is 8.5 GB, a single-layer and double-sided DVD is 9.4 GB, and double-layer and double-sided DVD is 17 GB. The picture data uses the MPEG 2 format, which is a worldwide standard of digital compression technology. The picture data is compressed to about 1/40 (average) of its original size. The DVD also uses a variable rate coding technology that changes the data to be allocated according to the status of the picture. Audio information is recorded in a multi-channel format, such as Dolby Digital, allowing you to enjoy a more real audio presence.

Furthermore, various advanced functions such as the multi-angle, multilingual, and Parental Control functions are provided on the DVD.

Hard disk drive (page 3)

A hard disk drive is a whole mechanical system that consists of disks and drive. Disks are flat, circular, rigid plates coated with a thin magnetic media. Magnetic heads record data on the rapidly spinning disks, and this enables the speedy and efficient reading and writing of data.

Interlace format (page 16)

Interlace format shows every other line of an image as a single "field" and is the standard method for displaying images on television. The even number field shows the even numbered lines of an image, and the odd numbered field shows the odd numbered lines of an image.

MPEG Audio (page 92)

International standard coding system used to compress audio digital signals authorized by ISO/IEC. MPEG 2, used on DVDs, conforms to up to 7.1-channel surround.

Original (page 64)

Titles actually recorded on a DVD-RW (VR mode). Erasing original titles frees up disc space.

Playlist (page 64)

Playback information created from the actual recordings on a DVD-RW (VR mode). A Playlist leaves the original titles as they are, and contains only the information needed to control playback. A Playlist title takes up very little disc space.

Progressive format (page 16)

Compared to the Interlace format that alternately shows every other line of an image (field) to create one frame, the Progressive format shows the entire image at once as a single frame. This means that while the Interlace format can show 25-30 frames/50-60 fields in one second, the Progressive format can show 50/60 frames in one second. The overall picture quality increases and still images, text, and horizontal lines appear sharper.

Title (page 61)

The longest section of a picture or music feature on a DVD, movie, etc., in video software, or the entire album in audio software.

Track (page 61)

Sections of a music feature on a CD (the length of a song).

Language Code List

For details, see page 88.

The language spellings conform to the ISO 639: 1988 (E/F) standard.

Code Language	Code Language	Code Language	Code Language
1027 Afar	1183 Irish	1347 Maori	1507 Samoan
1028 Abkhazian	1186 Scots Gaelic	1349 Macedonian	1508 Shona
1032 Afrikaans	1194 Galician	1350 Malayalam	1509 Somali
1039 Amharic	1196 Guarani	1352 Mongolian	1511 Albanian
1044 Arabic	1203 Gujarati	1353 Moldavian	1512 Serbian
1045 Assamese	1209 Hausa	1356 Marathi	1513 Siswati
1051 Aymara	1217 Hindi	1357 Malay	1514 Sesotho
1052 Azerbaijani	1226 Croatian	1358 Maltese	1515 Sundanese
1053 Bashkir	1229 Hungarian	1363 Burmese	1516 Swedish
1057 Byelorussian	1233 Armenian	1365 Nauru	1517 Swahili
1059 Bulgarian	1235 Interlingua	1369 Nepali	1521 Tamil
1060 Bihari	1239 Interlingue	1376 Dutch	1525 Telugu
1061 Bislama	1245 Inupiak	1379 Norwegian	1527 Tajik
1066 Bengali;	1248 Indonesian	1393 Occitan	1528 Thai
Bangla	1253 Icelandic	1403 (Afan)Oromo	1529 Tigrinya
1067 Tibetan	1254 Italian	1408 Oriya	1531 Turkmen
1070 Breton	1257 Hebrew	1417 Punjabi	1532 Tagalog
1079 Catalan	1261 Japanese	1428 Polish	1534 Setswana
1093 Corsican	1269 Yiddish	1435 Pashto;	1535 Tonga
1097 Czech	1283 Javanese	Pushto	1538 Turkish
1103 Welsh	1287 Georgian	1436 Portuguese	1539 Tsonga
1105 Danish	1297 Kazakh	1463 Quechua	1540 Tatar
1109 German	1298 Greenlandic	1481 Rhaeto-	1543 Twi
1130 Bhutani	1299 Cambodian	Romance	1557 Ukrainian
1142 Greek	1300 Kannada	1482 Kirundi	1564 Urdu
1144 English	1301 Korean	1483 Romanian	1572 Uzbek
1145 Esperanto	1305 Kashmiri	1489 Russian	1581 Vietnamese
1149 Spanish	1307 Kurdish	1491 Kinyarwanda	1587 Volapük
1150 Estonian	1311 Kirghiz	1495 Sanskrit	1613 Wolof
1151 Basque	1313 Latin	1498 Sindhi	1632 Xhosa
1157 Persian	1326 Lingala	1501 Sangho	1665 Yoruba
1165 Finnish	1327 Laothian	1502 Serbo-	1684 Chinese
1166 Fiji	1332 Lithuanian	Croatian	1697 Zulu
1171 Faroese	1334 Latvian;	1503 Singhalese	
1174 French	Lettish	1505 Slovak	
1181 Frisian	1345 Malagasy	1506 Slovenian	1703 Not specified

Index

Words in quotations appear in the on-screen displays.

Numerics

- 16:9 24, 88
- 4:3 Letter Box 24, 88
- 4:3 Pan Scan 24, 88

A

- “A-B Erase” 66
- Adjusting
 - playback picture 58
 - playback sound 59
 - recording picture 49
- Aerial 13
- “AFT” 85
- Album 38, 63
- Album number 38
- “Album Search” 61
- Angle 56
- Area code 95
- “Audio” 88
- Audio 56, 91
- “Audio ATT” 91
- “Audio Connection” 24
- Audio cord 17
- “Audio DRC” 91
- “Audio Filter” 59
- “Audio Settings” 59
- “Auto Adjust” 87
- “Auto Chapter” 93
- Auto Clock Set 87
- “Auto Display” 97
- “Auto Title Erase” 47
- Auto Tuner Preset 23

B

- Batteries 19
- “Bilingual” 51, 53
- Bilingual recording 41
- “BNR” 58
- “Brightness” 50, 58

C

- “C NR” 58
- Canal Plus 29
- “Capture” 69
- “Capture All” 69
- “CATV” 85
- CD 10
- “Change IN” 70, 81
- “Change OUT” 70, 81
- “Channel List” 86
- “Channel Setting” 84
- Chapter 38, 50, 68, 112
- CHAPTER ERASE 68
- CHAPTER MARK 68
- Chapter number 38
- “Chapter Search” 61
- “Chasing Playback” 60
- Chasing Playback 60
- “Check Overlap” 46
- “Check Scenes” 69
- Checking/changing/cancel-ling timer settings (Timer List) 46
- Child Lock 55
- Cleaning discs 104
- Clock 23, 87
- “Colour” 50, 58
- “Colour System” 96
- Colour systems 106
- “Combine” 71
- “Command Mode” 22, 97
- “Component Out” 89
- Component video input 15
- COMPONENT VIDEO OUT 14
- Connecting 14
 - the aerial cable 13
 - the audio cords 17
 - the video cords 14
- “Contrast” 50, 58
- Controlling TVs with the re-mote 20
- Copy control signals 42
- Copy protection 112
- Copy-Free 42
- Copy-Never 42
- Copy-Once 42
- CPRM 8
- “Create Playlist” 68

- Creating chapters 68
- Cursor mode 34

D

- DATA CD 10
- “Decoder” 30
- “Digital Out” 92
- Digital video camera 77
- “Dimmer” 97
- “Disc Info” 35
- Disc Map 67
- “Disc Name” 36
- Disc settings 35, 96
- Disc space 36
- Disc types 8
- Display
 - front panel display 39, 110
 - On-screen display 32
 - Setup Display 83
- “Divide” 70
- Dolby Digital 18, 24, 92, 112
- “Downmix” 91
- DTS 25, 92, 112
- “Dub Mode” 72, 82
- Dubbing 72
 - “Dub Mode” 72
 - High-speed Dubbing 72
 - Rec Mode Conversion
 - Dubbing 73
 - “Settings” 75
- “DV Audio Input” 78
- DV Dubbing 77
 - One Touch Dubbing 79, 96
 - Program Edit 80
- “DV EDIT” 80
- DV IN 77
- “DVD Bilingual Rec.” 97
- “DVD Menu” 88
- “DVD Rec. Picture Size” 49
- DVD VIDEO 10, 112
- DVD+R 8, 112
- DVD+RW 8, 112
- DVD-R 8, 112
- DVD-RW 8, 112
- DVD-RWs (Video mode) 64
- “DVE” 58

E

Easy Setup 22, 98
Editing 64, 68
 DV Edit 77
Enter characters 40
“Erase” 46, 65, 70, 81
“Erase All” 36
“Erase Titles” 66
“Extend Rec” 44

F

“Factory Setup” 97
“Features” 93
“Finalize” 37
“Finalize Disc” 96
Finalizing 37
“Format” 36
“Format DVD” 96
Formatting 36
Freeze Frame 57
Front panel 108
Front panel display 39, 110

G

GB 36

H

Handling discs 104
“HDD Bilingual Rec.” 97
“Hue” 58

I

i.LINK 106
INPUT SELECT 52, 78
Interlace 113
Interlace format 113

L

Labelling 36
Language 88
LINE 2 IN 27
LINE 3/DECODER 26
LINE 4 IN 27
“Line Audio Input” 51, 53
“Line1 Output” 24, 90
“Line3 Input” 90
“Line3 Output” 90
“Line4 Input” 90

M

Mains Lead 19
Manual Clock Set 87
MENU 54
Menu
 DVD’s Menu 54
 Top menu 54
“Mix” 78
“Modify” 46
“Move” 70, 81
MP3 audio tracks 62
MPEG 92, 113

N

NICAM 42, 85
“Normal” 85
Number buttons 40, 45

O

One Touch Dubbing 79, 96
One Touch Menu 55
One Touch Play 55
One Touch Timer 44
On-screen display
 “OSD” language 23, 88
 Setup Display 83
 Sub-menu 32
 System Menu 32
 TOOLS menu 33
“Options” 96
Original 34, 64, 113

P

Page mode 34
Parental Control 55, 94
Parts and controls 108
“Pause Mode” 89
PAY-TV 29
“PAY-TV/CANAL +” 86
“PB Video Equalizer” 58
PBC 54
PDC 43
Picture quality 49, 58
Picture size 49
“Play Beginning” 54
Play mode 38
Playable discs 10

Playback 10, 38, 54, 57
 fast forward 57
 fast reverse 57
 Freeze Frame 56
 instant advance 57
 instant replay 57
 Resume Play 54
 Slow-motion play 56

Playing status bar 38
Playlist 34, 64, 68, 113
“Present Time” 87
“Preset Download” 23
“Preview” 70, 81
Program Edit 80
Progressive 16, 113
“Progressive Mode” 89
“Protect” 66
“Protect Disc” 36
Protection
 disc 36
 title 65

Q

Quick guide to disc types 8
Quick Timer 49

R

Rear panel 111
REC 48
“Rec Mode” 49
Rec Mode Adjust 43
“Rec NR” 50
REC PAUSE 48
“Rec Settings” 49
REC STOP 48, 79
“Rec Video Equalizer” 50
Recordable discs 8
Recording 41, 51, 93
 picture adjustment 49
 recording format 8
 Recording mode 41, 50
 Recording time 50
 “Update” 43
 while watching another
 programme 48
Recording time 41
RECOVERY 103
Region code 11
Remaining time 38

Remote 19, 109
Resetting the recorder 98
Resume Play 54
"RGB" 24, 90

S

S VIDEO 15
"S Video" 24, 90
"Scart Setting" 90
Scene List 69
Screen Saver 89
"Search" 61
Searching
 fast reverse/fast forward
 57
 locating the beginning of
 the title/chapter/
 track 57
 Search mode 61
SET 20, 40
"Set Thumbnail" 66
"Settings" 84
Setup Display 83
Simultaneous Rec and Play 60
Slow-motion play 57
SMARTLINK 15
Sort 34
Sound quality 59
"Station Name" 86
"Stereo1" 78
"Stereo2" 78
Sub-menu 32
Subtitle 56, 88
Super VIDEO CD 10
Surround 57
Synchro Rec 51
"System" 85
System Menu 32, 83

T

Teletext 48, 93
Thumbnail picture 34
"Time Search" 61
TIME/TEXT 39
TIMER 43
Timer List 46

Timer recording
 check/change/cancel 46
 manual setting 42
 Rec Mode Adjust 43
 Synchro Rec 51
 VIDEO Plus+ 44

Title 38, 113
TITLE LIST 54
Title List 33, 54
 Sort 34
 Thumbnail 34
 Zoom 33
"Title Name" 66
Title number 38
"Title Search" 61
TOOLS menu 33
TOP MENU 54
Track 113
"Track Search" 61
Troubleshooting 99
Tuner System 23
"TV Direct Rec" 48, 93
"TV Guide Page" 93
TV system 85
"TV Type" 24, 88
TV/DVD 48
TV/DVD switch 20
TVS (TV Virtual Surround)
57

U

"Unfinalize" 37
Usable discs 8, 10

V

"Video" 24, 88, 90
VIDEO CD 10
Video cord 14
Video input 15
Video mode 8
VIDEO Plus+ 44
"Video Settings" 58
VPS 43
VR mode 8, 64

Y

"Y NR" 58

Z

Zoom 33
ZWEITON 42



Printed on 100% recycled paper using
VOC (Volatile Organic Compound)-free
vegetable oil based ink.



2-050-330-11(3)

Free Manuals Download Website

<http://myh66.com>

<http://usermanuals.us>

<http://www.somanuals.com>

<http://www.4manuals.cc>

<http://www.manual-lib.com>

<http://www.404manual.com>

<http://www.luxmanual.com>

<http://aubethermostatmanual.com>

Golf course search by state

<http://golfingnear.com>

Email search by domain

<http://emailbydomain.com>

Auto manuals search

<http://auto.somanuals.com>

TV manuals search

<http://tv.somanuals.com>