

DVD Recorder

Operating Instructions

RDR-HX510

RDR-HX710/HX910  **VIDEO*plus***™



WARNING

To prevent fire or shock hazard, do not expose the unit to rain or moisture. To avoid electrical shock, do not open the cabinet. Refer servicing to qualified personnel only. The mains lead must only be changed at a qualified service shop.



This appliance is classified as a CLASS 1 LASER product. The CLASS 1 LASER PRODUCT MARKING is located on the laser protective housing inside the enclosure.

CAUTION

The use of optical instruments with this product will increase eye hazard. As the laser beam used in this DVD recorder is harmful to eyes, do not attempt to disassemble the cabinet. Refer servicing to qualified personnel only.

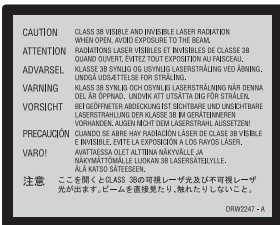

This label is located on the laser protective housing inside the enclosure.

Notice for customers in the United Kingdom and Republic of Ireland

A moulded plug complying with BS1363 is fitted to this equipment for your safety and convenience. Should the fuse in the plug supplied need to be replaced, a 5 AMP fuse approved by ASTA or BSI to BS1362, (i.e., marked with ⚡ or ⚡ mark) must be used. If the plug supplied with this equipment has a detachable fuse cover, be sure to attach the fuse cover after you change the fuse. Never use the plug without the fuse cover. If you should lose the fuse cover, please contact your nearest Sony service station.

Precautions

- This unit operates on 220 – 240 V AC, 50/60 Hz. Check that the unit's operating voltage is identical with your local power supply.
- To prevent fire or shock hazard, do not place objects filled with liquids, such as vases, on the apparatus.

VIDEO Plus+ and PlusCode are registered trademarks of Gemstar Development Corporation. The VIDEO Plus+ system is manufactured under license from Gemstar Development Corporation.



Disposal of Old Electrical & Electronic Equipment (Applicable in the European Union and other European countries with separate collection systems)

This symbol on the product or on its packaging indicates that this product shall not be treated as household waste. Instead it shall be handed over to the applicable collection point for the recycling of electrical and electronic equipment. By ensuring this product is disposed of correctly, you will help prevent potential negative consequences for the environment and human health, which could otherwise be caused by inappropriate waste handling of this product. The recycling of materials will help to conserve natural resources. For more detailed information about recycling of this product, please contact your local city office, your household waste disposal service or the shop where you purchased the product.

Precautions

This equipment has been tested and found to comply with the limits set out in the EMC Directive using a connection cable shorter than 3 metres.

On safety

Should any solid object or liquid fall into the cabinet, unplug the recorder and have it checked by qualified personnel before operating it any further.

About the hard disk drive

The hard disk has a high storage density, which enables long recording durations and quick access to the written data. However, it can easily be damaged by shock, vibration or dust, and should be kept away from magnets. To avoid losing important data, observe the following precautions.

- Do not apply a strong shock to the recorder.
- Do not place the recorder in a location subject to mechanical vibrations or in an unstable location.
- Do not place the recorder on top of a hot surface, such as a VCR or amplifier (receiver).
- Do not use the recorder in a place subject to extreme changes in temperature (temperature gradient less than 10 °C/hour).
- Do not move the recorder with its mains lead connected.
- Do not disconnect the mains lead while the power is on.
- When disconnecting the mains lead, turn off the power and make sure that the hard disk drive is not operating (the clock is displayed in the front panel display and all recording or dubbing has stopped).
- Do not move the recorder for one minute after you have unplugged the mains lead.
- Do not attempt to replace or upgrade the hard disk by yourself, as this may result in malfunction.

If the hard disk drive should malfunction, you cannot recover lost data. The hard disk drive is only a temporary storage space.

About repairing the hard disk drive

- The contents of the hard disk drive may be checked in case of repair or inspection during a malfunction or modification. However, the contents will not be backed up or saved by Sony.
- If the hard disk needs to be formatted or replaced, it will be done at the discretion of Sony. All contents of the hard disk drive will be erased, including contents that violate copyright laws.

On power sources

- The recorder is not disconnected from the AC power source (mains) as long as it is connected to the wall outlet, even if the recorder itself has been turned off.
- If you are not going to use the recorder for a long time, be sure to disconnect the recorder from the wall outlet. To disconnect the AC power cord (mains lead), grasp the plug itself; never pull the cord.
- Before disconnecting the AC power cord (mains lead), check that the recorder's hard disk is not operating (recording or dubbing) on the front panel display.

On placement

- Place the recorder in a location with adequate ventilation to prevent heat build-up in the recorder.
- Do not place the recorder on a soft surface such as a rug that might block the ventilation holes.
- Do not place the recorder in a confined space such as a bookshelf or similar unit.
- Do not place the recorder in a location near heat sources, or in a place subject to direct sunlight, excessive dust, or mechanical shock.
- Do not place the recorder in an inclined position. It is designed to be operated in a horizontal position only.
- Keep the recorder and discs away from equipment with strong magnets, such as microwave ovens, or large loudspeakers.
- Do not place heavy objects on the recorder.

On recording

- Note that the contents of the recording cannot be compensated for under any and all conditions, including conditions that may arise due to a malfunction of this unit.
- Make trial recordings before making the actual recording.

Copyrights

- Television programmes, films, video tapes, discs, and other materials may be copyrighted. Unauthorized recording of such material may be contrary to the provisions of the copyright laws. Also, use of this recorder with cable television transmission may require authorization from the cable television transmitter and/or programme owner.
- This product incorporates copyright protection technology that is protected by U.S. patents and other intellectual property rights. Use of this copyright protection technology must be authorized by Macrovision, and is intended for home and other limited viewing uses only unless otherwise authorized by Macrovision. Reverse engineering or disassembly is prohibited.

Copy guard function

Since the recorder has a copy guard function, programmes received through an external tuner (not supplied) may contain copy protection signals (copy guard function) and as such may not be recordable, depending on the type of signal.

IMPORTANT NOTICE

Caution: This recorder is capable of holding a still video image or on-screen display image on your television screen indefinitely. If you leave the still video image or on-screen display image displayed on your TV for an extended period of time you risk permanent damage to your television screen. Plasma display panels and projection televisions are especially susceptible to this.

If you have any questions or problems concerning your recorder, please consult your nearest Sony dealer.

About this manual

Check your model name

The instructions in this manual are for 3 models: RDR-HX510, RDR-HX710, and RDR-HX910. Check your model name by looking at the front panel of the recorder.

- In this manual, the internal hard disk drive is written as "HDD;" and "disc" is used as a general reference for the HDD, DVDs, or CDs unless otherwise specified by the text or illustrations.
- Instructions in this manual describe the controls on the remote. You can also use the controls on the recorder if they have the same or similar names as those on the remote.
- The on-screen display illustrations used in this manual may not match the graphics displayed on your TV screen.
- RDR-HX710/HX910 are used for illustration purposes.
- The explanations regarding DVDs in this manual refer to DVDs created on this recorder. The explanations do not apply to DVDs that are created on other recorders and played back on this recorder.

Table of Contents

WARNING	2
Precautions	2
Ways to Use Your DVD Recorder	7
Quick Guide to Disc Types	8
Recordable and playable discs	8
Playable discs	10

Hookups and Settings 12

Hooking Up the Recorder	12
Step 1: Unpacking	12
Step 2: Connecting the Aerial Cable	13
Step 3: Connecting the Video Cords	14
About the SMARTLINK features (for SCART connections only)	15
Using the PROGRESSIVE button	16
Step 4: Connecting the Audio Cords	17
Step 5: Connecting the Mains Lead	18
Step 6: Preparing the Remote	19
Controlling TVs with the remote.	19
Controlling the volume of your AV amplifier (receiver) with the remote.	20
If you have a Sony DVD player or more than one Sony DVD recorder.	21
Step 7: Easy Setup	22
Connecting a VCR or Similar Device	23
Connecting to the LINE 3/DECODER jack	23
Connecting to the LINE 2 IN or LINE 4 IN jacks	24
Connecting to a Satellite or Digital Tuner	25
Connecting a PAY-TV/Canal Plus Decoder	26
Connecting a decoder	26
Setting PAY-TV/Canal Plus channels	27

Seven Basic Operations — Getting to Know Your DVD Recorder

1. Inserting and Formatting a DVD Disc (Disc Info)	29
Inserting a Disc	29
Formatting a DVD disc (Disc Info)	29
2. Recording a Programme	31
Checking the disc status while recording.	32
3. Playing the Recorded Programme (Title List)	32
4. Displaying the Playing Time and Play Information	34
Checking the playing/remaining time.	35
5. Changing the Name of a Recorded Programme	36
6. Labelling and Protecting a Disc	38
Labelling a disc	38
Protecting a disc	38
7. Playing the Disc on Other DVD Equipment (Finalize)	39
Unfinalizing a disc	40

Timer Recording	41
Before Recording	41
Recording mode	41
Recording stereo and bilingual programmes	42
Unrecordable pictures	42
Timer Recording (Standard/VIDEO Plus+)	43
Setting the timer manually (Standard)	43
Recording TV programmes using the VIDEO Plus+ system (RDR-HX710/HX910 only)	45
Using the Quick Timer function	46
Adjusting the recording picture quality and size	47
Creating chapters in a title	48
Checking/Changing/Cancelling Timer Settings (Timer List)	48
Automatically erasing old titles (Auto Title Erase)	50
Recording From Connected Equipment	50
Recording from connected equipment with a timer (Synchro Rec)	50
Recording from connected equipment without a timer	52

Playback	53
Playing	53
Playback options	55
Adjusting the picture quality	57
Adjusting the sound quality	57
Pausing a TV Broadcast (TV Pause)	58
Playing from the beginning of the programme you are recording (Chasing Playback)	58
Playing a previous recording while making another (Simultaneous Rec and Play)	59
Searching for a Title/Chapter/Track, etc.	60
Searching by Thumbnail (Visual Search)	60
Searching by title number or time code	60
Playing MP3 Audio Tracks or JPEG Image Files	61
Selecting an MP3 album or track	61
Selecting a JPEG album or image	62
About MP3 audio tracks and JPEG image files	63
MP3 audio tracks or JPEG image files that the recorder can play	63
About playback order of albums, tracks, and files	64

Erasing and Editing	65
Before Editing	65
Edit options for the HDD and DVD-RWs (VR mode)	65
Edit options for DVD+RWs/DVD-RWs (Video mode)/DVD+Rs/DVD-Rs	66
Erasing and Editing a Title	66
Erasing a chapter (Delete Chapter)	67
Erasing a section of a title (A-B Erase)	67
Erasing multiple titles (Erase Titles)	68
Dividing a title (Divide)	68
Erasing all titles on the disc	69
Erasing titles to open up disc space (Disc Map)	69
Creating chapters manually	69

Creating and Editing a Playlist	70
Moving a Playlist title (Change Order)	71
Combining multiple Playlist titles (Combine)	71
Dividing a Playlist title (Divide)	71
Dubbing (HDD ↔ DVD)	72
Before Dubbing	72
About “Dub Mode”	72
Dubbing	74
Dubbing a single title (Title Dub)	74
Dubbing multiple titles (Dub Selected Titles)	75
DV Dubbing (RDR-HX710/HX910 only)	77
Before DV Dubbing	77
Preparing for DV dubbing	77
Recording an Entire DV Format Tape (One Touch Dubbing)	79
Program Edit	79
Settings and Adjustments	82
Aerial Reception and Language Settings (Settings)	82
Channel Setting	82
Channel List (Changing/Disabling the channels)	85
TV Guide Page	85
Clock	86
Language	87
Video Settings (Video)	87
Audio Settings (Audio)	89
Recording and Parental Control Settings (Features)	91
Disc and Remote Control Settings/Factory Settings (Options)	93
Easy Setup (Resetting the Recorder)	95
Additional Information	96
Troubleshooting	96
Self-diagnosis Function (When letters/numbers appear in the display)	102
Notes About This Recorder	103
Specifications	104
About i.LINK (RDR-HX710/HX910 only)	105
Guide to Parts and Controls	106
Glossary	110
Language Code List	112
Area Code	112
Index	113

Ways to Use Your DVD Recorder

Recording/Playback

Compatible media and reference pages

Quick access to recorded titles
– Title List

→ **HDD** **+RW** **-RWVR** **-RW_{Video}** **+R** **-R**
“3. Playing the Recorded Programme (Title List)” on page 32

Play the beginning of a title
while it is being recorded
– Chasing Playback

→ **HDD** **-RWVR**
“Playing from the beginning of the programme you are recording (Chasing Playback)” on page 58

Watching one title while
recording another
– Simultaneous Rec and Play

→ **HDD** **+RW** **-RWVR** **-RW_{Video}** **+R** **-R**
VCD **CD** **DATA DVD** **DATA CD**
“Playing a previous recording while making another (Simultaneous Rec and Play)” on page 59

Dubbing/Editing

Compatible media and reference pages

Creating your own programme
– Playlist

→ **HDD** **-RWVR**
“Creating and Editing a Playlist” on page 70

Copying a recorded title to and
from the HDD
– Dubbing (HDD ↔ DVD)

→ **HDD** **+RW** **-RWVR** **-RW_{Video}** **+R** **-R**
“Dubbing (HDD ↔ DVD)” on page 72















Automatic dubbing of DV tapes
– DV Dubbing
(RDR-HX710/HX910 only)

→ **HDD** **+RW** **-RWVR** **-RW_{Video}** **+R** **-R**
“DV Dubbing (RDR-HX710/HX910 only)” on page 77

A list of recordable and playable discs is on page 8.

Quick Guide to Disc Types

Recordable and playable discs

Type	Disc Logo	Icon used in this manual	Formatting (new discs)	Compatibility with other DVD players (finalizing)
Hard disk drive (internal)			(Formatting unnecessary)	Dub HDD contents to a DVD to play on other DVD players
DVD+RW	 DVD+ReWritable  DVD+ReWritable High Speed		Automatically formatted in +VR mode	Playable on DVD+RW compatible players (automatically finalized)
DVD-RW	VR mode 		Format in VR mode (page 29)	Playable only on VR mode compatible players (finalization unnecessary)
	Video mode 		Format in Video mode (page 29)	Playable on most DVD players (finalization necessary) (page 39)
DVD+R	 DVD+R		Automatically formatted	Playable on most DVD players (finalization necessary) (page 39)
DVD+R DL	 DVD+R DL			
DVD-R	 R R4.7		Automatically formatted	Playable on most DVD players (finalization necessary) (page 39)

Usable disc versions (as of March 2005)

- 8x-speed or slower DVD+RWs
- 6x-speed or slower DVD-RWs (Ver.1.1, Ver.1.2 with CPRM^{*1})
- 16x-speed or slower DVD+Rs
- 16x-speed or slower DVD-Rs (Ver.2.0, Ver.2.1)
- 2.4x-speed DVD+R DL (Double Layer) discs

“DVD+RW,” “DVD-RW,” “DVD+R,” “DVD+R DL,” and “DVD-R” are trademarks.

^{*1} CPRM (Content Protection for Recordable Media) is a coding technology that protects copyrights for images.

^{*2} This logo applies to 4x and 6x speed DVD-RW discs.

	Recording Features				Editing Features			
	Rewrite (page 41)	Auto Chapter (page 91)	Manual Chapter (page 69)	Record 16:9 sizes (page 47)	Change title name (page 66)	Delete title (page 68)	A-B Erase (page 67)	Playlist (page 70)
	Yes	Yes	Yes	Yes	Yes	Yes	Yes	Yes
	Yes	Yes	No	No	Yes	Yes	Yes	No
	Yes	Yes	Yes	Yes	Yes	Yes	Yes	Yes
	Yes	Yes	No	Yes* ³	Yes	Yes	No	No
	No	Yes	No	No	Yes	Yes* ⁴	No	No
	No	Yes	No	Yes* ³	Yes	Yes* ⁴	No	No









Discs that cannot be recorded on

- 8 cm discs
- DVD-Rs in VR mode (Video Recording format)

*³ Only if the recording mode is LSP, SP, HSP, or HQ, and “DVD Rec. Picture Size” is set to “16:9.”

*⁴ Erasing titles does not free up disc space.

Playable discs

Type	Disc Logo	Icon used in this manual	Characteristics
DVD VIDEO			Discs such as movies that can be purchased or rented
VIDEO CD			VIDEO CDs or CD-Rs/CD-RWs in VIDEO CD/Super VIDEO CD format
CD			Music CDs or CD-Rs/CD-RWs in music CD format that can be purchased
DATA DVD	—		DVD+RWs/DVD+Rs/DVD-RWs/DVD-Rs/DVD-ROMs containing JPEG image files
DATA CD	—		CD-ROMs/CD-Rs/CD-RWs containing MP3 audio tracks or JPEG image files
8 cm DVD+RW/ DVD-RW/DVD-R	—	—	8 cm DVD+RW, DVD-RW, and DVD-R recorded with a DVD video camera. (Still images recorded with a DVD video camera cannot be played.)

“DVD VIDEO” and “CD” are trademarks.

Discs that cannot be played

- PHOTO CDs
- CD-ROMs/CD-Rs/CD-RWs that are not recorded in music CD or Video CD format, or do not contain MP3 or JPEG files
- Data part of CD-Extras
- DVD-ROMs that do not contain JPEG files or are not in DVD Video format
- DVD Audio discs
- DVD-RAMs
- HD layer on Super Audio CDs
- DVD VIDEOS with a different region code (page 11)
- DVD-Rs recorded in VR mode (Video Recording format)

Maximum recordable number of titles

Disc	Number of titles*
HDD	300
DVD-RW/DVD-R	99
DVD+RW/DVD+R	49
DVD+R DL	49

* The maximum length for each title is eight hours.

Note on playback operations of DVD VIDEOS/VIDEO CDs

Some playback operations of DVD VIDEOS/VIDEO CDs may be intentionally set by software producers. Since this recorder plays DVD VIDEOS/VIDEO CDs according to the disc contents the software producers designed, some playback features may not be available. Also, see the instructions supplied with the DVD VIDEOS/VIDEO CDs.

Region code (DVD VIDEO only)

Your recorder has a region code printed on the rear of the unit and will only play DVD VIDEOS (playback only) labelled with identical region codes. This system is used to protect copyrights. DVD VIDEOS labelled  will also play on this recorder.

If you try to play any other DVD VIDEO, the message "Playback prohibited by region code." will appear on the TV screen. Depending on the DVD VIDEO, no region code indication may be labelled even though playing the DVD VIDEO is prohibited by area restrictions.



Music discs encoded with copyright protection technologies

This product is designed to play back discs that conform to the Compact Disc (CD) standard. Recently, various music discs encoded with copyright protection technologies are being marketed by some record companies. Please be aware that among those discs, there are some that do not conform to the CD standard and may not be playable by this product.

Note on DualDiscs

A DualDisc is a two sided disc product which mates DVD recorded material on one side with digital audio material on the other side. However, since the audio material side does not conform to the Compact Disc (CD) standard, playback on this product is not guaranteed.

Notes

- Some DVD+RWs/DVD+Rs, DVD-RWs/DVD-Rs, or CD-RWs/CD-Rs cannot be played on this recorder due to the recording quality or physical condition of the disc, or the characteristics of the recording device and authoring software. The disc will not play if it has not been correctly finalized. For more information, see the operating instructions for the recording device.
- You cannot mix VR mode and Video mode on the same DVD-RW. To change the disc's format, reformat the disc (page 29). Note that the disc's contents will be erased after reformatting.
- You cannot shorten the time required for recording even with high-speed discs.
- It is recommended that you use discs with "For Video" printed on their packaging.
- You cannot add new recordings to DVD+Rs, DVD-Rs, or DVD-RWs (Video mode) that contain recordings made on other DVD equipment.
- In some cases, you may not be able to add new recordings to DVD+RWs that contain recordings made on other DVD equipment. If you do add a new recording, note that this recorder will rewrite the DVD menu.
- You cannot edit recordings on DVD+RWs, DVD-RWs (Video mode), DVD+Rs, or DVD-Rs that are made on other DVD equipment.
- If the disc contains PC data unrecognizable by this recorder, the data may be erased.
- You may not be able to record on some recordable discs, depending on the disc.

Hooking Up the Recorder

Follow steps 1 to 7 to hook up and adjust the settings of the recorder.

Notes

- Plug cords securely to prevent unwanted noise.
- Refer to the instructions supplied with the components to be connected.
- You cannot connect this recorder to a TV that does not have a SCART or video input jack.
- Be sure to disconnect the mains lead of each component before connecting.

Step 1: Unpacking

Check that you have the following items:

- Mains lead (1)
- Aerial cable (1)
- Remote commander (remote) (1)
- R6 (size AA) batteries (2)

Step 2: Connecting the Aerial Cable

Connect the aerial cable by following the steps below. Do not connect the mains lead until you reach “Step 5: Connecting the Mains Lead” on page 18.

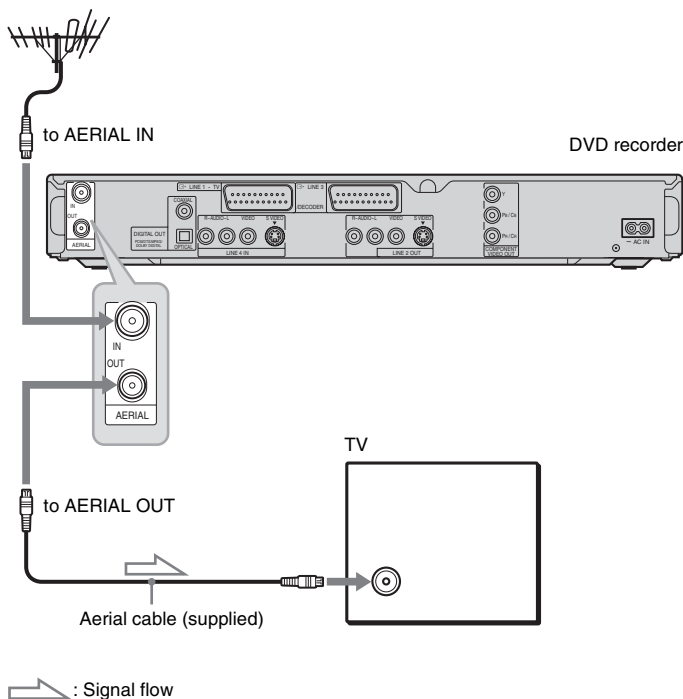

- 1** Disconnect the aerial cable from your TV and connect it to AERIAL IN on the rear panel of the recorder.
- 2** Connect AERIAL OUT of the recorder to the aerial input of your TV, using the supplied aerial cable.

Step 3: Connecting the Video Cords

Select one of the following patterns **A** through **D**, according to the input jack on your TV monitor, projector, or AV amplifier (receiver). This will enable you to view pictures.

A Connecting to a SCART input jack

When you set “Line1 Output” to “S Video” or “RGB” in “Easy Setup” (page 22), use a SCART cord that conforms to the selected signal.

B Connecting to a video input jack

You will enjoy standard quality images.

C Connecting to an S VIDEO input jack

You will enjoy high quality images.

D Connecting to component video input jacks (Y, Pb/Cb, Pr/Cr)

You will enjoy accurate colour reproduction and high quality images.

If your TV accepts progressive 525p/625p format signals, you must use this connection and set “Component Out” in “Video” setup to “On” (page 88). Then press PROGRESSIVE on the remote to send progressive video signals. For details, see “Using the PROGRESSIVE button” on page 16.

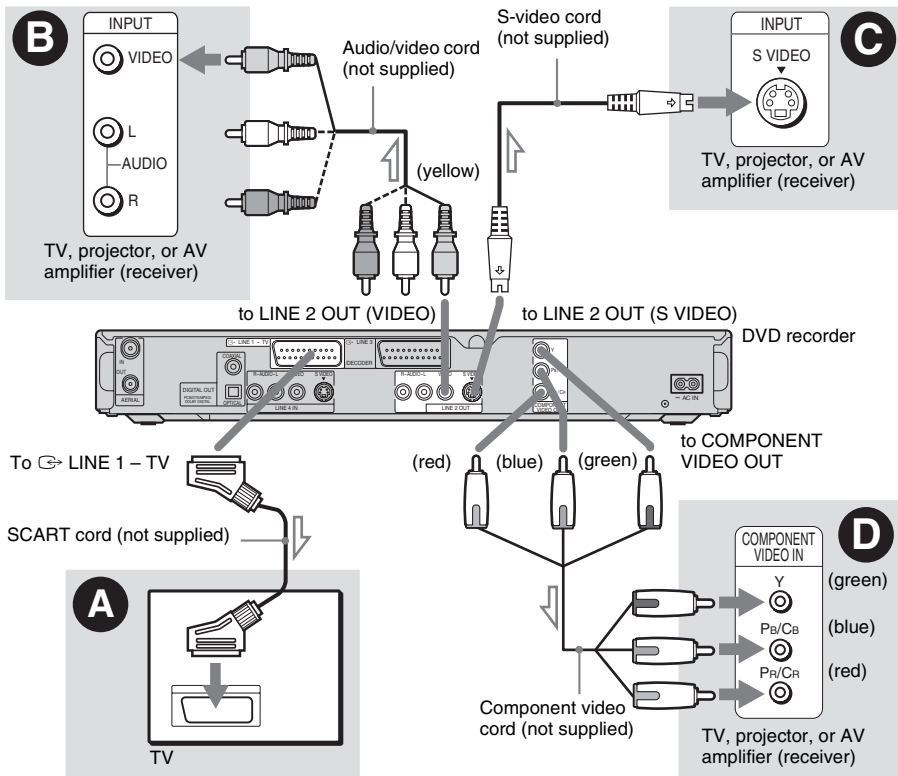

: Signal flow

When playing “wide screen” images

Some recorded images may not fit your TV screen. To change the picture size, see page 87.

If you are connecting to a VCR

Connect your VCR to the LINE 3/DECODER jack on the recorder (page 23).



⚡ Notes

- Do not connect more than one type of video cord between the recorder and your TV at the same time.
- You cannot use the PROGRESSIVE button with the connections **B** and **C**.
- When you connect the recorder to your TV via the SCART jacks, the TV’s input source is set to the recorder automatically when you start playback. If necessary, press  TV/VIDEO to return the input to the TV.
- For correct SMARTLINK connection, you will need a SCART cord that has the full 21 pins. Refer to your TV’s instruction manual as well for this connection.
- If you connect this recorder to a TV with SMARTLINK, set “Line1 Output” to “Video” in “Easy Setup.”

About the SMARTLINK features (for SCART connections only)

If the connected TV (or other connected equipment such as a set top box) complies with SMARTLINK, NexTView Link*³, MEGALOGIC*¹, EASYLINK*², CINEMALINK*², Q-Link*³, EURO VIEW LINK*⁴, or T-V LINK*⁵, this recorder automatically runs the SMARTLINK function after you complete the connection pattern **A** on page 14 (the SMARTLINK indicator lights up when you turn on your TV). You can enjoy the following SMARTLINK features.

- **Preset Download**
You can download the tuner preset data from your TV to this recorder, and tune the recorder according to that data in “Easy Setup.” This greatly simplifies the “Easy Setup” procedure. Be careful not to disconnect the cables or exit the “Easy Setup” function during this procedure (page 22).
- **TV Direct Rec**
You can easily record what you are watching on your TV (page 31).

- **One Touch Play**
You can turn on the recorder and TV, set the TV’s input to the recorder, and start playback with one touch of the  (play) button (page 54).
- **One Touch Menu**
You can turn on the recorder and TV, set the TV to the recorder’s channel, and display the Title List menu with one touch of the TITLE LIST button (page 54).
- **One Touch Timer**
You can turn on the recorder and TV, set the TV to the recorder’s channel, and display the timer programming menu with one touch of the  button (page 44).
- **Automatic Power Off**
The recorder will turn off automatically if the recorder is not used after you turn off the TV.
- **NexTView Download**
You can easily set the timer by using the NexTView Download function on your TV. See your TV’s instruction manual.

*1 “MEGALOGIC” is a registered trademark of Grundig Corporation.

*2 “EASYLINK” and “CINEMALINK” are trademarks of Philips Corporation.

*3 “Q-Link” and “NexTView Link” are trademarks of Panasonic Corporation.

*4 “EURO VIEW LINK” is a trademark of Toshiba Corporation.

*5 “T-V LINK” is a trademark of JVC Corporation.

💡 Hint

SMARTLINK also works with TVs or other equipment having EPG Timer Control, EPG Title Download, and Now Recording functions. For details, refer to the operating instructions supplied with your TV or other equipment.

⚡ Notes

- The SMARTLINK features are available only when “Video” is selected in “Line1 Output.”
- Not all TVs respond to the functions above.

Using the PROGRESSIVE button

By using the PROGRESSIVE button, you can select the signal format in which the recorder outputs video signals: interlace or progressive.

- 1 Connect the recorder using the COMPONENT VIDEO OUT jacks (pattern  on page 14).
- 2 Set “Component Out” in “Video” setup to “On” (page 88).
- 3 Press the PROGRESSIVE button.
“PROGRESSIVE” appears in the front panel display when the recorder outputs progressive signals.

◆ Progressive

Select this when:

- your TV accepts progressive signals, and,
- the TV is connected to the COMPONENT VIDEO OUT jacks.

Note that the pictures will not be clear or no picture will appear if you select progressive signal output when either of the above conditions is not met.

◆ Interlace

Set to this position when:

- your TV does not accept progressive signals, or,
- your TV is connected to jacks other than the COMPONENT VIDEO OUT jacks (LINE 2 OUT (VIDEO or S VIDEO)).

Hint

When you select progressive signal output, you can fine-tune the signal according to the type of software you are watching (page 88).

Step 4: Connecting the Audio Cords

Select one of the following patterns **A** or **B**, according to the input jack on your TV monitor, projector, or AV amplifier (receiver). This will enable you to listen to sound.

A Connecting to audio L/R input jacks

This connection will use your TV's or stereo amplifier's (receiver's) two speakers for sound. You can enjoy the following surround effects (page 55).

- TV: Dynamic, Wide, Night
- Stereo amplifier (receiver): Standard, Night

B Connecting to a digital audio input jack

If your AV amplifier (receiver) has a Dolby[®]*1 Digital, DTS[®]*2, or MPEG audio decoder and a digital input jack, use this connection. You can enjoy Dolby Digital (5.1ch), DTS (5.1ch), and MPEG audio (5.1ch) surround effects.

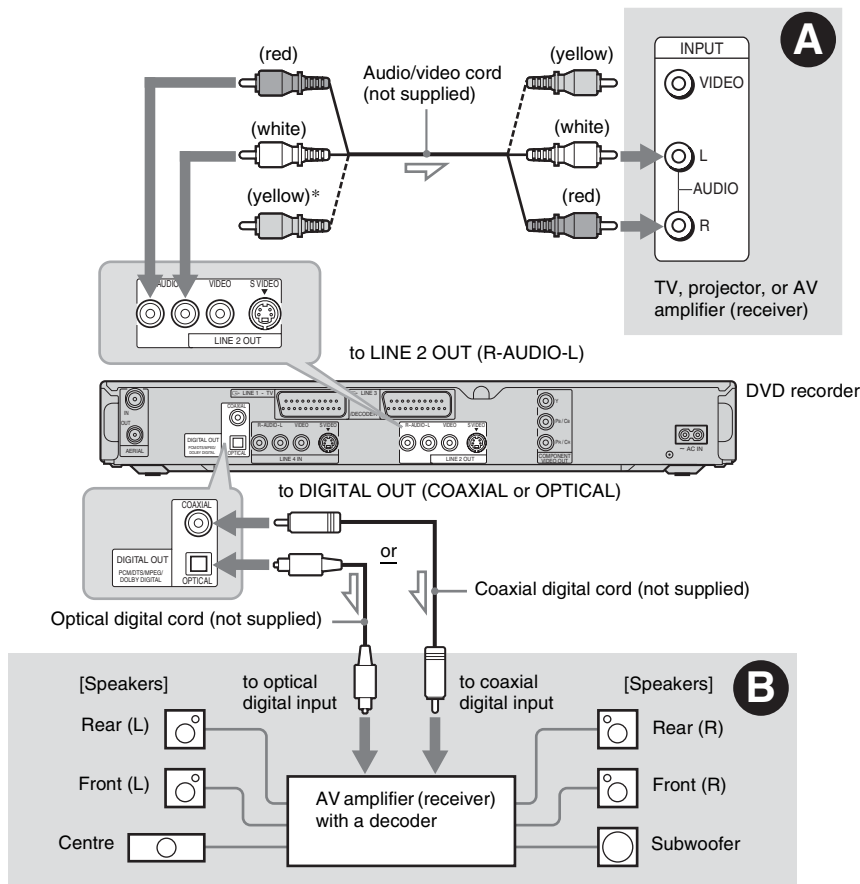

* The yellow plug is used for video signals (page 14).

Hint

For correct speaker location, see the operating instructions supplied with the connected components.

Notes

- Do not connect your TV's audio output jacks to the LINE IN (R-AUDIO-L) jacks at the same time. This will cause unwanted noise to come from your TV's speakers.
- In the connection **A**, do not connect the LINE IN (R-AUDIO-L) and LINE 2 OUT (R-AUDIO-L) jacks to your TV's audio output jacks at the same time. This will cause unwanted noise to come from your TV's speakers.
- In the connection **B**, after you have completed the connection, make the appropriate settings under "Audio Connection" in "Easy Setup" (page 22). Otherwise, no sound or a loud noise will come from your speakers.
- With the connection **B**, the surround sound effects of this recorder cannot be used.

*1 Manufactured under license from Dolby Laboratories. "Dolby," and the double-D symbol are trademarks of Dolby Laboratories.

*2 "DTS" and "DTS Digital Out" are trademarks of Digital Theater Systems, Inc.

Step 5: Connecting the Mains Lead

Connect the supplied mains lead to the AC IN terminal of the recorder. Then plug the recorder and TV mains leads (power cords) into the mains. After you connect the mains lead, **you must wait for a short while before operating the recorder**. You can operate the recorder once the front panel display lights up and the recorder enters standby mode.

If you connect additional equipment to this recorder (page 23), be sure to connect the mains lead after all connections are complete.

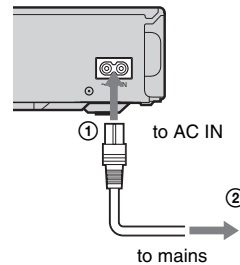

Step 6: Preparing the Remote

You can control the recorder using the supplied remote. Insert two R6 (size AA) batteries by matching the ⊕ and ⊖ ends on the batteries to the markings inside the battery compartment. When using the remote, point it at the remote sensor  on the recorder.

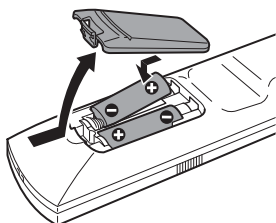

Notes

- If the supplied remote interferes your other Sony DVD recorder or player, change the command mode number for this recorder (page 21).
- Use the batteries correctly to avoid possible leakage and corrosion. Do not touch the liquid with bare hands should leakage occur. Observe the following:
 - Do not use a new battery with an old battery, or batteries of different manufacturers.
 - Do not attempt to recharge the batteries.
 - If you do not intend to use the remote for an extended period of time, remove the batteries.
 - If battery leakage occurs, wipe out any liquid inside the battery compartment, and insert new batteries.
- Do not expose the remote sensor (marked  on the front panel) to strong light, such as direct sunlight or lighting apparatus. The recorder may not respond to the remote.

Controlling TVs with the remote

You can adjust the remote's signal to control your TV.

If you connected the recorder to an AV amplifier (receiver), you can use the supplied remote to control the AV amplifier's (receiver's) volume.

Notes

- Depending on the connected unit, you may not be able to control your TV or AV amplifier (receiver) with some or all of the buttons below.
- If you enter a new code number, the code number previously entered will be erased.
- When you replace the batteries of the remote, the code number may be reset to the default setting. Set the appropriate code number again.

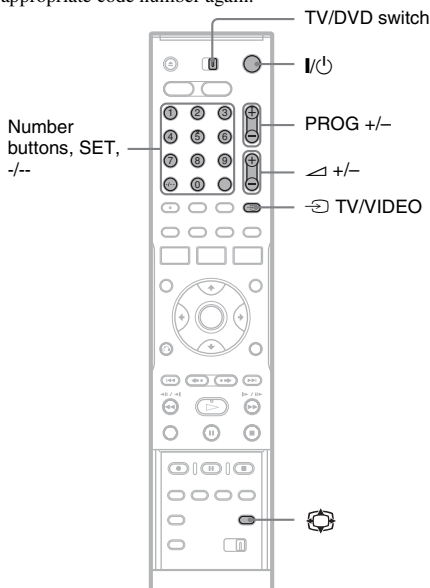

- 1 Slide the TV/DVD switch to TV.
- 2 Hold down I/Power.
- 3 Enter your TV's manufacturer code (see "Code numbers of controllable TVs" below) using the number buttons.

4 Release I/⏻.

When the TV/DVD switch is set to TV, the remote performs the following:

Buttons	Operations
I/⏻	Turns your TV on or off
◀ (volume) +/-	Adjusts the volume of your TV
PROG +/-	Selects the programme position on your TV
⊞ (wide mode)	Switches to or from the wide mode of a Sony wide-screen TV
↔ TV/VIDEO	Switches your TV's input source
Number buttons and SET, -/--*	Selects the programme position on your TV

* If you use the number buttons to select the TV's programme position, press -/-- followed by the number buttons for two-digit numbers.

To operate the ↔ TV/VIDEO button (for SCART connections only)

The ↔ TV/VIDEO button switches between the recorder and the last input source selected on the TV. Point your remote at the recorder when using this button. The button works even if the TV/DVD switch is set to DVD.

When you connect the recorder to the TV via the SCART jacks, the input source for the TV is set to the recorder automatically when you start playback. To watch another source, press the ↔ TV/VIDEO button to switch the TV's input source.

Code numbers of controllable TVs

If more than one code number is listed, try entering them one at a time until you find the one that works with your TV.

Manufacturer	Code number
Sony	01 (default)
Aiwa	01 (default)
Grundig	11
Hitachi	23, 24, 72
Loewe	06, 45
Nokia	15, 16, 69, 73
Panasonic	17, 49

Manufacturer	Code number
Philips	06, 07, 08, 23, 45, 72
Saba	12, 13, 36, 43, 74, 75
Samsung	06, 22, 23, 71, 72
Sanyo	25
Sharp	29
Telefunken	12, 13, 36, 43, 74, 75
Thomson	12, 13, 43, 74, 75
Toshiba	38
LG	06
JVC	33

Controlling the volume of your AV amplifier (receiver) with the remote

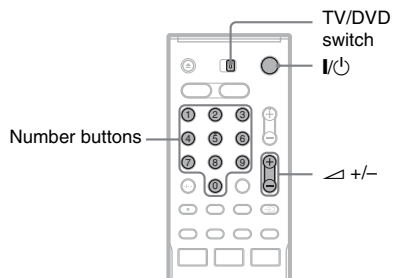

- 1 Slide the TV/DVD switch to DVD.
- 2 Hold down I/⏻, and enter the manufacturer code (see the table below) for your AV amplifier (receiver) using the number buttons.
- 3 Release I/⏻.

The ◀ (volume) +/- buttons control the AV amplifier's volume.

If you want to control the TV's volume, slide the TV/DVD switch to TV.

💡 Hint

If you want to control the TV's volume even when the TV/DVD switch is set to DVD, repeat the steps above and enter the code number 90 (default).

Code numbers of controllable AV amplifiers (receivers)

If more than one code number is listed, try entering them one at a time until you find the one that works with your AV amplifier (receiver).

Manufacturer	Code number
Sony	78, 79, 80, 91
Denon	84, 85, 86
Kenwood	92, 93
Onkyo	81, 82, 83
Pioneer	99
Sansui	87
Technics	97, 98
Yamaha	94, 95, 96

If you have a Sony DVD player or more than one Sony DVD recorder

If the supplied remote interferes with your other Sony DVD recorder or player, set the command mode number for this recorder and the supplied remote to one that differs from the other Sony DVD recorder or player.

The default command mode setting for this recorder and the supplied remote is DVD3.

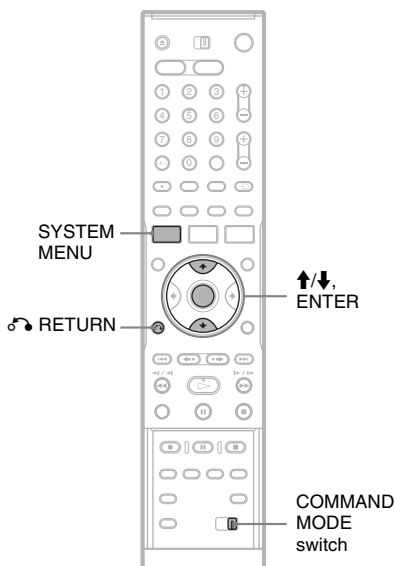

1 Press SYSTEM MENU.

The System Menu appears.

2 Select "SETUP," and press ENTER.

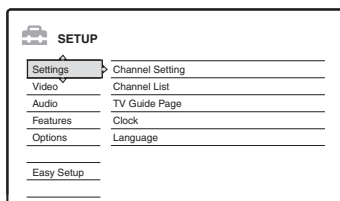

3 Select "Options," and press ENTER.

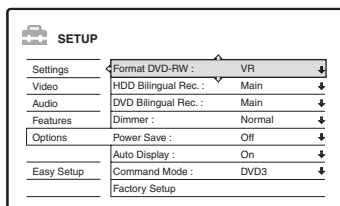

4 Select "Command Mode," and press ENTER.

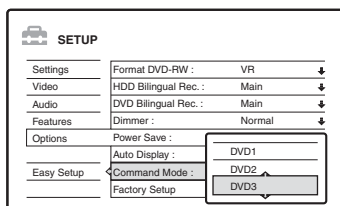

5 Select the Command mode (DVD1, DVD2, or DVD3), and press ENTER.

6 Slide the COMMAND MODE switch on the remote so it matches the mode you selected above.

To return to the previous step

Press **RETURN**.

Check that the command mode switch on the remote is set to the default setting of DVD3 before you try to change the command mode for the recorder. If the command mode for the remote is changed to DVD1 or DVD2, you may be unable to operate this recorder.

Step 7: Easy Setup

Make the basic adjustments by following the on-screen instructions in “Easy Setup.”

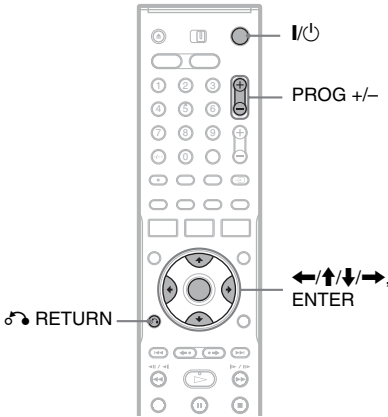

1 Turn on the recorder and switch the input selector on your TV so that the signal from the recorder appears on your TV screen.

The message about the initial settings appears.

- If this message does not appear, select “Easy Setup” from “SETUP” in the System Menu to run “Easy Setup” function (“Settings and Adjustments” on page 82).

2 Press ENTER.

Follow the on-screen instructions to make the following settings.

◆ OSD

Select the language for the on-screen displays.

◆ Tuner System

Select your country or language.

The programme position order will be set according to the country you set.

To set the programme positions manually, see page 82.

- If you live in a French speaking country that is not listed on the display, select “ELSE.”

◆ Clock

The recorder will automatically search for a clock signal. If a clock signal cannot be found, set the clock manually using $\leftarrow/\uparrow/\downarrow/\rightarrow$, and press ENTER.

◆ TV Type

If you have a wide-screen TV, select “16:9.”
If you have a standard TV, select either “4:3 Letter Box” (shrink to fit) or “4:3 Pan Scan” (stretch to fit). This will determine how “wide-screen” images are displayed on your TV.

◆ Component Out

If you are using the COMPONENT VIDEO OUT jack, select “On.”

◆ Line3 Input

If you will connect a decoder to the LINE 3/ DECODER jack, select “Yes.”

◆ Line1 Output

To output video signals, select “Video.”
To output S video signals, select “S Video.”
To output RGB signals, select “RGB.”
Select “Video” to enjoy the SMARTLINK features.

- If you set “Component Out” to “On,” you cannot select “RGB.”
If you set “Line3 Input” to “Yes,” you cannot select “S Video.”

◆ Audio Connection

If you connected an AV amplifier (receiver) using either a digital optical or coaxial cord, select “Yes: DIGITAL OUT” and set the digital output signal (page 90).

3 Press ENTER when “Finish” appears. “Easy Setup” is finished.

To return to the previous step

Press \curvearrowright RETURN.

🔧 Hints

- If your AV amplifier (receiver) has an MPEG audio decoder, set “MPEG” to “MPEG” (page 90).
- If you want to run “Easy Setup” again, select “Easy Setup” from “SETUP” in the System Menu (page 95).

Connecting a VCR or Similar Device

After disconnecting the recorder's mains lead from the mains, connect a VCR or similar recording device to the LINE IN jacks of this recorder.

Use the DV IN jack on the front panel if the equipment has a DV output jack (i.LINK jack) (RDR-HX710/HX910 only) (page 77).

See also the instruction manual supplied with the connected equipment.

To record on this recorder, see "Recording from connected equipment without a timer" on page 52.

Connecting to the LINE 3/DECODER jack

Connect a VCR or similar recording device to the LINE 3/DECODER jack of this recorder.

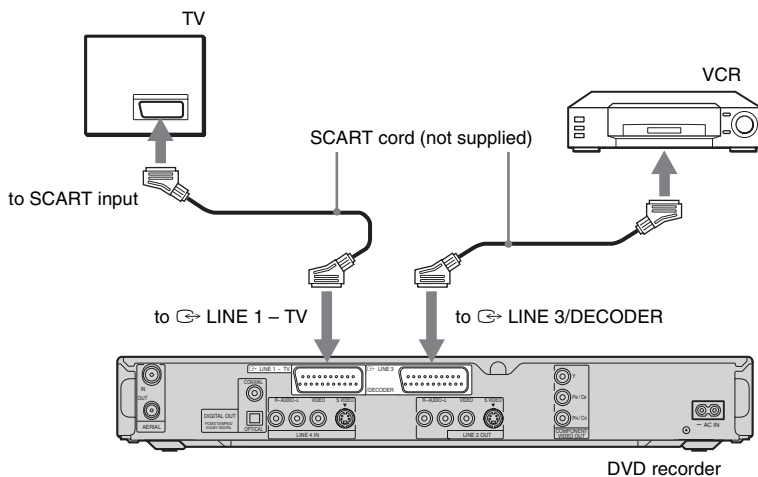

Notes

- Pictures containing copy protection signals that prohibit any copying cannot be recorded.
- If you pass the recorder signals via the VCR, you may not receive a clear image on your TV screen.

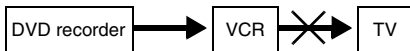

Be sure to connect your VCR to the DVD recorder and your TV in the order shown below. To watch video tapes, watch the tapes through a second line input on your TV.

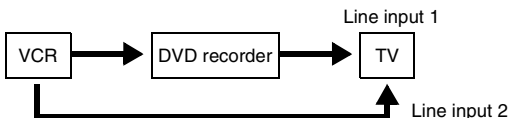

- The SMARTLINK features are not available for devices connected via the DVD recorder's LINE 3/DECODER jack.
- When you record to a VCR from this DVD recorder, do not switch the input source to TV by pressing the TV/VIDEO button on the remote.
- If you disconnect the recorder's mains lead, you will not be able to view the signals from the connected VCR.

Connecting to the LINE 2 IN or LINE 4 IN jacks

Connect a VCR or similar recording device to the LINE 2 IN or LINE 4 IN jacks of this recorder. If the equipment has an S-video jack, you can use an S-video cord instead of an audio/video cord.

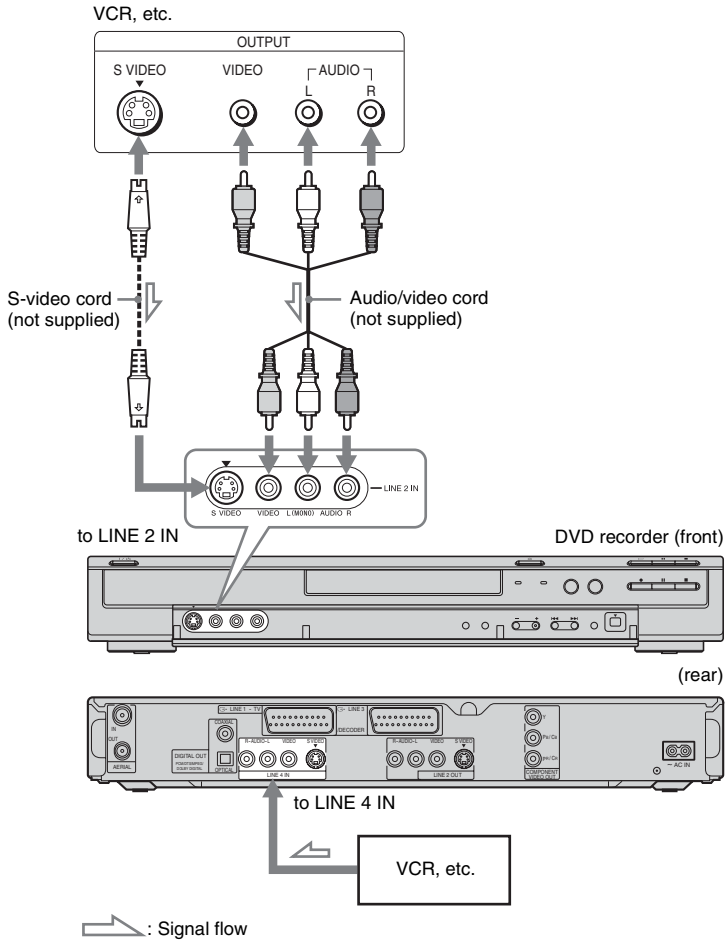

Hint

When the connected equipment outputs only monaural sound, connect to just the L (MONO) and VIDEO input jacks on the front of the recorder. Do not connect the R input jack.

Notes

- Do not connect the yellow LINE IN (VIDEO) jack when using an S-video cord.
- Do not connect the output jack of this recorder to another equipment's input jack with the other equipment's output jack connected to the input jack of this recorder. Noise (feedback) may result.
- Do not connect more than one type of video cord between the recorder and your TV at the same time.

Connecting to a Satellite or Digital Tuner

Connect a satellite or digital tuner to this recorder using the LINE 3/DECODER jack. Disconnect the recorder's mains lead from the mains when connecting the tuner. To use the Synchro-Rec function, see below.

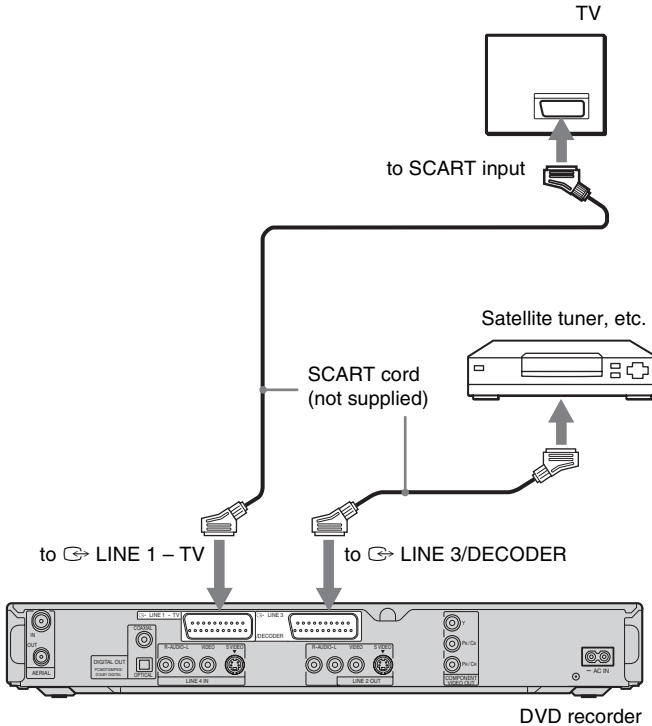

If the satellite tuner can output RGB signals

This recorder accepts RGB signals. If the satellite tuner can output RGB signals, connect the TV SCART connector on the satellite tuner to the LINE 3/DECODER jack, and set “Line3 Input” of “Scart Setting” to “Video/RGB” in “Video” setup (page 88). Note that this connection and setup disable the SMARTLINK function. If you want to use the SMARTLINK function with a compatible set top box, see the instructions supplied with the set top box.

If you want to use the Synchro Rec function

This connection is necessary to use the Synchro-Recording function. See “Recording from connected equipment with a timer (Synchro Rec)” on page 50.

Set “Line3 Input” of “Scart Setting” in “Video” setup (page 88) according to the specifications of your satellite tuner. See your satellite tuner’s instructions for more information.

If you are using a B Sky B tuner, be sure to connect the tuner’s VCR SCART jack to the LINE 3/DECODER jack. Then set “Line3 Input” of “Scart Setting” according to the specifications of the VCR SCART jack on your satellite tuner.

Notes

- Do not set “Line3 Input” of “Scart Setting” in “Video” setup to “Decoder.”
- Synchro-Recording does not work with some tuners. For details, see the tuner’s operating instructions.
- If you disconnect the recorder’s mains lead, you will not be able to view the signals from the connected tuner.

Connecting a PAY-TV/Canal Plus Decoder

You can watch or record PAY-TV/Canal Plus programmes if you connect a decoder (not supplied) to the recorder. Disconnect the recorder's mains lead from the mains when connecting the decoder.

Connecting a decoder

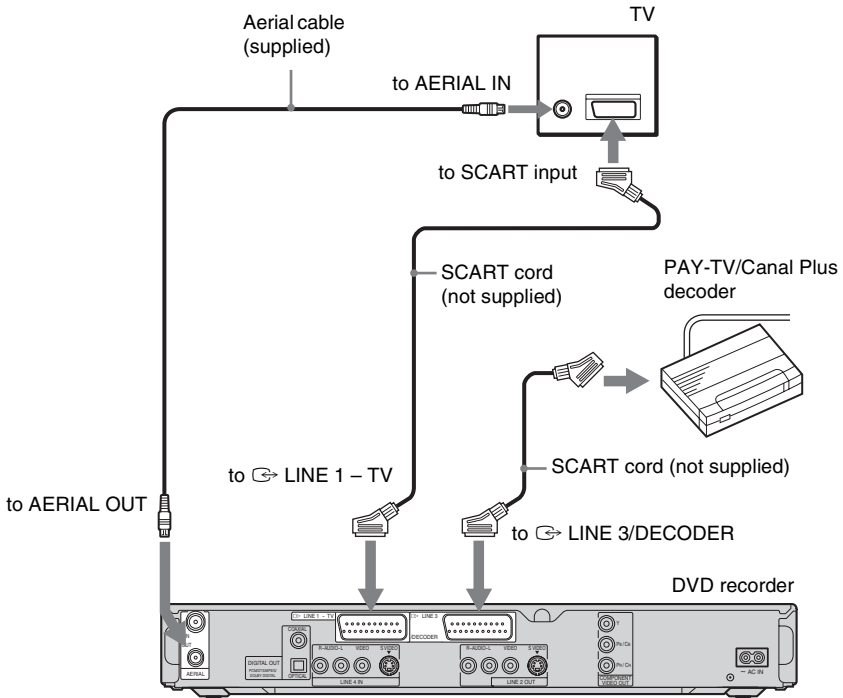

Setting PAY-TV/Canal Plus channels

To watch or record PAY-TV/Canal Plus programmes, set your recorder to receive the channels using the on-screen display. In order to set the channels correctly, be sure to follow all of the steps below.

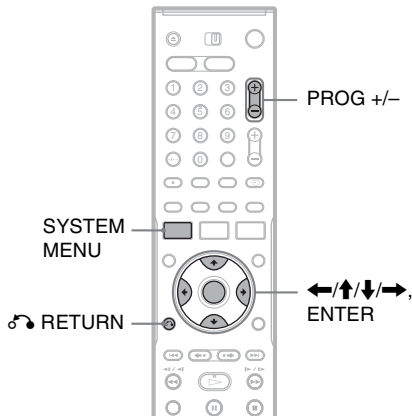

- 1 Press SYSTEM MENU.**
The System Menu appears.
- 2 Select "SETUP," and press ENTER.**

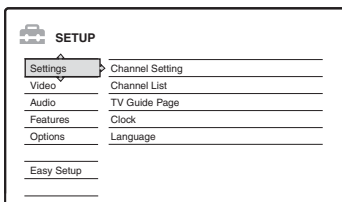

- 3 Select "Video," and press ENTER.**

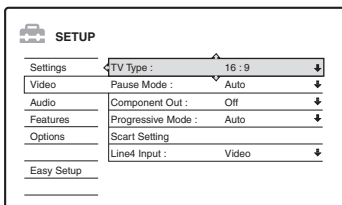

- 4 Select "Scart Setting," and press ENTER.**

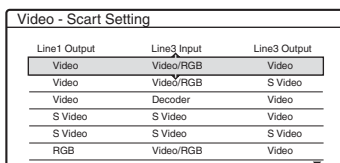

- 5 Press ↑/↓ to select "Video" or "RGB" for "Line1 Output," "Decoder" for "Line3 Input," and "Video" for "Line3 Output," and press ENTER.**

The "Video" setup display appears again.

- 6 Press ↶ RETURN to return the cursor to the left column.**

- 7 Select "Settings," and press ENTER.**

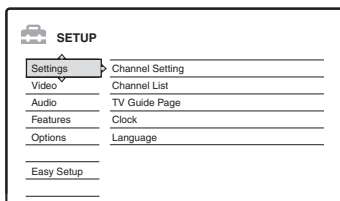

- 8 Select "Channel Setting," and press ENTER.**

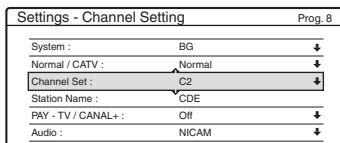

- 9 Press PROG +/- to select the desired programme position.**

Selected programme position

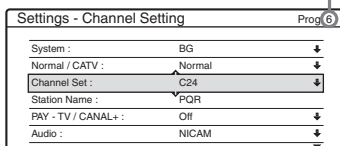

10 Select “System,” and press ENTER.

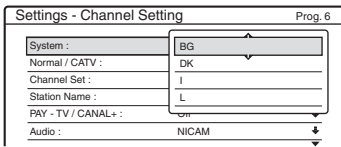

11 Press **↑/↓** to select an available TV system, BG, DK, I, or L, and press ENTER.
To receive broadcasts in France, select “L.”

12 Select “Normal/CATV,” and press ENTER.

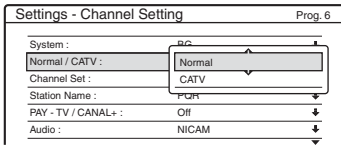

13 Select “Normal,” and press ENTER.

To preset CATV (Cable Television) channels, select “CATV.”

14 Select “Channel Set,” and press ENTER.

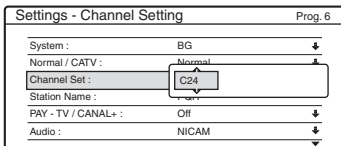

15 Select the PAY-TV/Canal Plus channel, and press ENTER.

16 Select “PAY-TV/CANAL+,” and press ENTER.

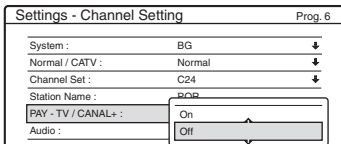

17 Select “On,” and press ENTER.

To return to the previous step

Press **↶** RETURN.

Notes

- When you set “Line3 Input” to “Decoder” in step 5 above, you will not be able to select “L3” because Line 3 will become a dedicated line for the decoder.
- If you disconnect the recorder’s mains lead, you will not be able to view the signals from the connected decoder.

1. Inserting and Formatting a DVD Disc (Disc Info)

Inserting a Disc

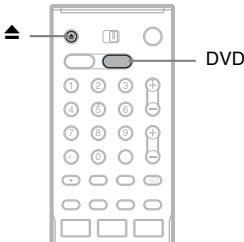

- 1 Press DVD.
- 2 Press ▲ (open/close), and place a disc on the disc tray.

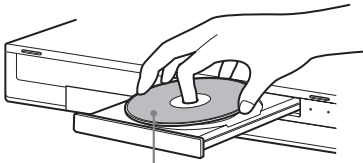

With the recording/playing side facing down

- 3 Press ▲ (open/close) to close the disc tray.
Wait until “LOAD” disappears from the front panel display.
Unused DVDs are formatted automatically.

Formatting a DVD disc (Disc Info)



New discs are automatically formatted when inserted. If necessary, you can manually re-format a DVD+RW or DVD-RW disc to make a blank disc. For DVD-RWs, you can select a recording format (VR mode or Video mode) according to your needs (page 8).

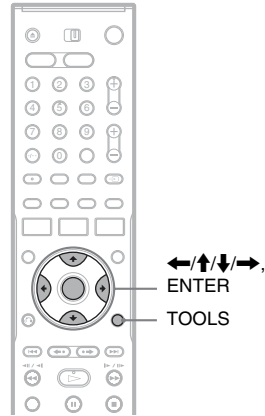

- 1 Insert a disc.
See “Inserting a Disc” on page 29.
- 2 Press TOOLS.
The TOOLS menu appears.



Options for the disc or picture

The TOOLS menu displays options applicable to the entire disc (e.g. disc protection), recorder (e.g. audio settings during recording), or multiple items on a list menu (e.g. erasing multiple titles). The displayed options differ depending on the situation and disc type.

3 Move the cursor down the TOOLS menu until “Disc Info” is selected, and press ENTER.

Example: When a DVD-RW (VR mode) is inserted.

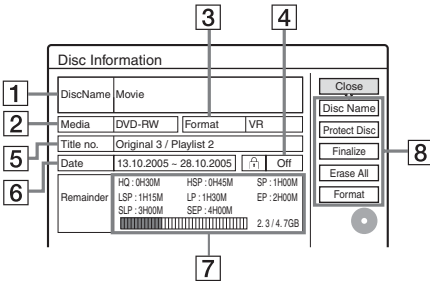

1 “Disc Name” (DVD only)

2 “Media”: Disc type

3 “Format”: Recording format type (DVD-RW only)

4 “On”/“Off”: Indicates whether protection is set (DVD-RW in VR mode only)

5 “Title no.”: Total number of titles

6 “Date”: Dates of when the oldest and the most recent titles were recorded (DVD only)

7 “Continuous Rem. Time”/“Remainder” (approximate)

- The remaining recording time in each of the recording modes
- Disc space bar
- Remaining disc space/total disc space

8 Disc setting buttons

- “Disc Name” (page 38)
- “Protect Disc” (page 38)
- “Finalize”/“Unfinalize” (page 39)
- “Erase All” (page 69)
- “Format”

Available settings differ depending on the disc type.

4 Select “Format,” and press ENTER.

5 Select “OK,” and press ENTER.

For DVD-RWs, select “VR” or “Video,” and press ENTER.

All contents on the disc are erased.

💡 Hints

- By reformatting, you can change the recording format on DVD-RWs, or record again on DVD-RWs that have been finalized.
- For DVD+RWs and DVD-RWs (Video mode), you can check free space and title location on the disc using the Disc Map display (page 69).

📌 Note

On this model, 1 GB (read “gigabyte”) is equivalent to 1 billion bytes. The larger the number, the larger the disc space.

2. Recording a Programme

HDD +RW -RWVR -RWVideo +R -R

This section introduces the basic operation to record the current TV programme to the hard disk (HDD) or to a disc (DVD). For an explanation of how to make timer recordings, see page 41.

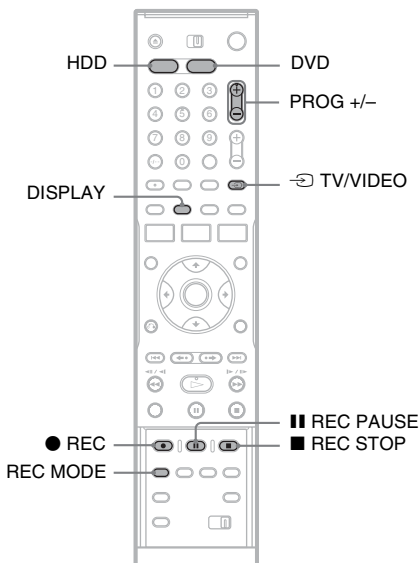

1 Press HDD or DVD.

When you record to a DVD, insert a recordable DVD (see “Inserting a Disc” on page 29).

2 Press PROG +/- to select the programme position or input source you want to record.

3 Press REC MODE repeatedly to select the recording mode.

Each time you press the button, the display on the TV screen changes as follows:



For more details about the recording mode, see page 41.

4 Press ● REC.

Recording starts.

Recording stops automatically after 8 hours of continuous recording or when the HDD or DVD is full.

To stop recording

Press ■ REC STOP located beneath the remote control cover.

Note that it may take a few seconds for recorder to stop recording.

To pause recording

Press || REC PAUSE located beneath the remote control cover.

To restart recording, press the button again.

To watch another TV programme while recording

If your TV is connected to the LINE 1 – TV jack, set your TV to the TV input using the TV/VIDEO button and select the programme you want to watch. If your TV is connected to the LINE OUT or COMPONENT VIDEO OUT jacks, set the TV to TV input using the TV/VIDEO button (page 19).

TV Direct Rec

If you use the SMARTLINK connection, you can easily record what you are watching on your TV. When the TV is turned on or in standby mode, press ● REC. The recorder automatically turns on and starts recording what you are watching on the TV.

Note

If “TV” appears in the front panel display, you cannot turn off the TV or change the programme position during TV Direct Rec. To turn off the function, set “TV Direct Rec” to “Off” in “Features” setup (page 91).

About the Teletext function

Some broadcasts systems ensure a Teletext service* in which the complete programmes and their data (title, date, channel, recording start time etc.) are stored day by day. When recording a programme, the recorder automatically takes the programme name from the Teletext pages and stores it as the title name. For detail, see “TV Guide Page” on page 85.

Note that the Teletext information will not appear on your TV screen. To view the Teletext information on your TV screen, press TV/VIDEO on the remote to switch the input source to your TV.

* not available in some areas

Hint

If you do not want to watch TV while recording, you can turn off the TV. When using a decoder, make sure to leave it on.

Notes

- After pressing REC, it may take a short while to start recording.
- You cannot change the recording mode while recording or during recording pause.
- If there is a power failure, the programme you are recording may be erased.
- You cannot watch a PAY-TV/Canal Plus programme while recording another PAY-TV/Canal Plus programme.
- To use the TV Direct Rec function, you must first set the recorder's clock correctly.

Checking the disc status while recording

You can check the recording information such as recording time or disc type.

Press DISPLAY twice during recording.

The recording information appears.



- 1 Disc type/format
- 2 Recording status
- 3 Recording mode
- 4 Recording time

Press DISPLAY to turn off the display.

3. Playing the Recorded Programme (Title List)

To play a recorded title, select the title from the Title List.

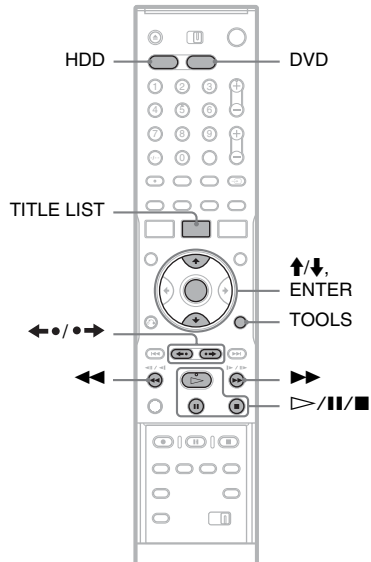

1 Press HDD or DVD.

If you select DVD, insert a DVD (see “Inserting a Disc” on page 29).

Playback starts automatically depending on the disc.

2 Press TITLE LIST.

To show the extended Title List, press TOOLS to select “Display List,” and press ENTER.

Title List with Thumbnail Images (Example: DVD-RW in VR mode)

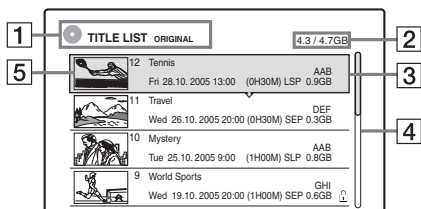

Extended Title List

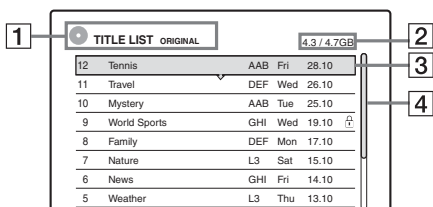

- 1 Disc type:
Displays a media type, HDD or DVD.
Also displays the title type (Original or Playlist) for DVD-RWs (VR mode).
- 2 Disc space (remainder/total)
- 3 Title information:
Displays the title number, title name, and recording date. Title size is shown in the Thumbnail title list.
● (red): Indicates that the title is currently being recorded.
● (red with slash): Indicates that the title is currently being dubbed.
Ⓜ: Indicates the protected title.
“NEW” (or N): Indicates that the title is newly recorded (not played back) (HDD only).
🔄: Indicates that the Update function is set (HDD only) (page 43).
COPY: Indicates titles containing “Copy-Once” copy protection signals (HDD only) (page 73).
- 4 Scroll bar:
Appears when all of the titles do not fit on the list. To view the hidden titles, press \uparrow/\downarrow .
- 5 Title’s thumbnail picture
The still images for each title are displayed.

3 Select a title, and press ENTER.

The sub-menu appears.

The sub-menu displays options applicable only to selected item. The displayed options differ depending on the model, situation, and disc type.

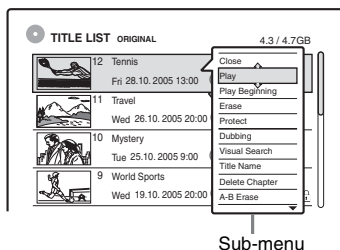

4 Select “Play,” and press ENTER.

Playback starts from the selected title.

To stop playback

Press \blacksquare .

To scroll the list display by page (Page mode)

Press \leftarrow/\rightarrow while the list display is turned on. Each time you press \leftarrow/\rightarrow , the entire Title List changes to the next/previous page of titles.

About the Title List for HDD/DVD-RWs (VR mode)

You can switch the Title List to show Original or Playlist.

While the Title List menu is turned on, press TOOLS to select either “Original” or “Playlist,” and press ENTER.

For details, see “Edit options for the HDD and DVD-RWs (VR mode)” on page 65.

To change the title order (Sort)

While the Title List menu is turned on, press TOOLS to select “Sort Titles.” Press \uparrow/\downarrow to select the item, and press ENTER.

Order	Sorted
By Date	in order of when the titles were recorded. The title that is recorded most recently is listed at the top.
By Title	in alphabetical order.
By Number	in order of recorded title number.

Order	Sorted
Unseen Title (HDD only)	in order of when the titles were recorded. The title that is recorded most recently and not played back is listed at the top. Playlist titles are not displayed.

To change a title thumbnail picture (Thumbnail) (HDD/DVD-RW in VR mode only)

You can select a favourite scene for the thumbnail picture shown in the Title List menu.

- 1 Press TITLE LIST in stop mode.
- 2 Select a title whose thumbnail picture you want to change, and press ENTER. The sub-menu appears.
- 3 Select "Set Thumbnail," and press ENTER. The selected title starts to play in the background.
- 4 While watching the playback picture, press \triangleright , \parallel , or $\triangleleft/\triangleright$ to select the scene you want to set for a thumbnail picture, and press ENTER. The display asks for confirmation.
- 5 Select "OK," and press ENTER. The scene is set for the title's thumbnail picture.

To turn off the Title List

Press TITLE LIST.

💡 Hints

- After recording, the first scene of the recording (the title) is automatically set as the thumbnail picture.
- You can select "TITLE LIST" from the System Menu.

🔊 Notes

- The title names may not appear for DVDs created on other DVD recorders.
- The letters that cannot be displayed are replaced with ".*."
- It may take a few seconds for the thumbnail pictures to be displayed.
- After editing, the title thumbnail picture may change to the first scene of the recording (title).
- After dubbing, the title thumbnail picture set on the source recording is cancelled.

4. Displaying the Playing Time and Play Information



You can check the playing time and remaining time of the current title, chapter, or track. Also, you can check the disc name recorded on the DVD/CD.

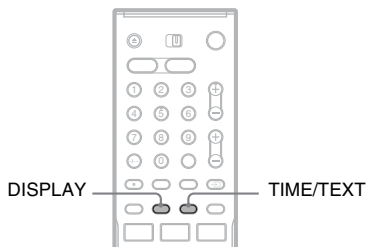

Press DISPLAY repeatedly.

Each time you press the button, the display changes as follows:

Display 1 → Display 2 → Display off

The displays differ depending on the disc type or playing status.

◆ Display 1

Example: When playing a DVD VIDEO

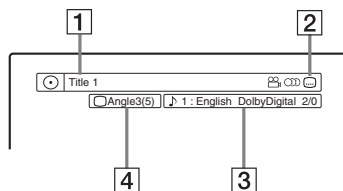

- 1 Title number/name
(Shows either track number, track name, scene number, or file name for CDs, VIDEO CDs, DATA DVDs, or DATA CDs.)
- 2 Available functions for DVD VIDEOS (angle/ audio/ subtitle, etc.), or playback data for DATA DVDs and DATA CDs

- 3** The current selected function or audio setting (appears only temporarily)

Example: Dolby Digital 5.1 ch

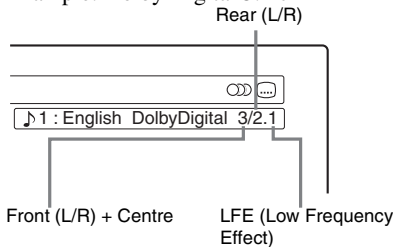

- 4** The current selected angle

◆ **Display 2**

Example: When playing a DVD-RW (VR mode)

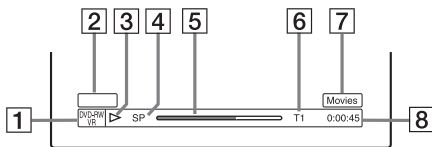

- 1** Disc type^{*1}/format (page 8)
- 2** Title type (only appears for Playlists) (page 65)
- 3** Play mode
- 4** Recording mode (page 41)
- 5** Playing status bar^{*2}
- 6** Title number (chapter number^{*3}) (page 60) (Shows either track number, scene number, album number^{*3}, or file number for CDs, VIDEO CDs, DATA DVDs, or DATA CDs.)
- 7** Album name appears for CDs with CD text, DATA DVDs or DATA CDs when you press TIME/TEXT repeatedly.
- 8** Playing time (remaining time^{*3})

^{*1} Displays Super VIDEO CDs as “SVCD,” DATA CDs as “CD” and DATA DVDs as “DVD.”

^{*2} Does not appear with VIDEO CDs, DATA DVDs, and DATA CDs.

^{*3} Displayed when you press TIME/TEXT repeatedly.

Hints

- If “DTS” is set to “Off” in “Audio” setup, the DTS track selection option will not appear on the screen even if the disc contains DTS tracks (page 90).
- When “Auto Display” is set to “On” (default) in “Options” setup (page 94), playback information automatically appears when the recorder is turned on, etc.

Note

The letters or symbols that cannot be displayed are replaced with “*.”

Checking the playing/remaining time

You can view the playing or time information displayed on the TV screen and the front panel display.

Press TIME/TEXT repeatedly.

The displays differ depending on the disc type or playing status.

◆ **Front panel display**

Example: When playing a DVD

Playing time and number of the current title



Remaining time of the current title

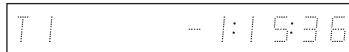

Playing time and number of the current chapter



Remaining time of the current chapter



Example: When dubbing a DVD

Remaining time of dubbing in progress

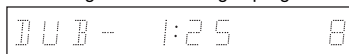

Example: When playing a VIDEO CD

Playing time and number of the current scene or track



Example: When playing a CD

Track playing time and the current track/index number



Remaining time of the current track



Playing time of the disc



Remaining time of the disc



CD text (when available)

Example: When playing an MP3 audio track

Playing time and number of the current track



Current album number

Example: When viewing a JPEG image

Current file number and total number of files in the current album



Current album number and total number of albums

⚡ Notes

- The recorder can only display the first level of a CD's text, such as the disc name.
- The letters or symbols that cannot be displayed are replaced with "*".
- Playing time of MP3 audio tracks may not be displayed correctly.

5. Changing the Name of a Recorded Programme

You can label a DVD, title, or program by entering characters. You can enter up to 64 characters for a title or disc name, but the actual number of characters displayed in the menus such as the Title List will vary. The steps below explain how to change the name of the recorded programme.

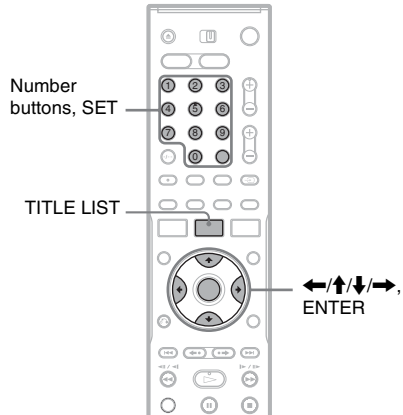

- 1 Press TITLE LIST.**
- 2 Select a title, and press ENTER.**
The sub-menu appears.
- 3 Select "Title Name," and press ENTER.**
The display for entering characters appears.
- 4 Press ←/↑/↓/→ to move the cursor to the right of the screen and select "A" (upper-case), "a" (lower-case), or "Symbol," and press ENTER.**
The characters of the selected type are displayed.

6. Labelling and Protecting a Disc

You can execute options effective for the entire disc using the Disc Information display.

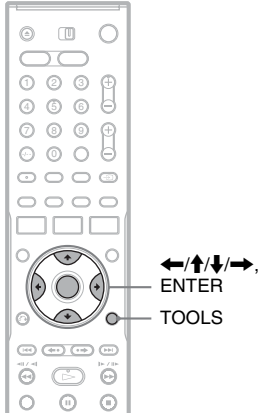

Protecting a disc

-RWVR

- 1 Insert a disc.**
See "Inserting a Disc" on page 29.
- 2 Press TOOLS to select "Disc Info," and press ENTER.**

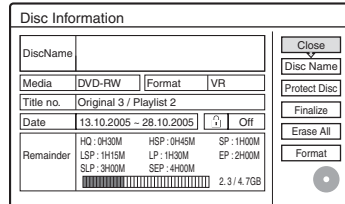

- 3 Select "Protect Disc," and press ENTER.**
- 4 Select "Protect," and press ENTER.**

To cancel the protection

Select "Don't Protect" in step 4.

💡 Hint

You can set protection for individual titles (page 66).

Labelling a disc

+RW -RWVR -RWVideo +R -R

- 1 Insert a disc.**
See "Inserting a Disc" on page 29.
- 2 Press TOOLS to select "Disc Info," and press ENTER.**
Example: When the inserted disc is a DVD-RW (VR mode).

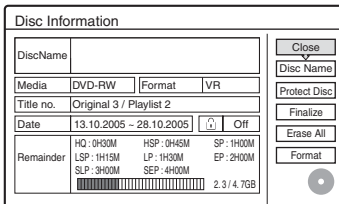

- 3 Select "Disc Name," and press ENTER.**
Enter the disc name in the "Input Disc Name" display (page 36).

📌 Note

You can enter up to 64 characters for a DVD's disc name. The disc name may not appear when the disc is played on other DVD equipment.

7. Playing the Disc on Other DVD Equipment (Finalize)

+RW **-RWVR** **-RW_{Video}** **+R** **-R**

Finalizing is necessary when you play discs recorded with this recorder on other DVD equipment.

When you finalize a DVD+RW, DVD-RW (Video mode), DVD+R, or DVD-R, a DVD menu will be automatically created, which can be displayed on other DVD equipment.

Before finalizing, check the differences between the disc types in the table below.

Differences between the disc types

+RW Discs are automatically finalized when removed from the recorder. However, you may need to finalize the disc for certain DVD equipment, or if the recording time is short. You can edit or record on the disc even after finalizing.

-RWVR Finalizing is unnecessary when playing a disc on VR format compatible equipment. Even if your other DVD equipment is VR format compatible, you may need to finalize the disc, especially if the recording time is short. You can edit or record on the disc even after finalizing.

-RW_{Video} Finalizing is necessary when playing on any equipment other than this recorder. After finalizing, you cannot edit or record on the disc. If you want to record on it again, unfinalize or reformat the disc (page 29). However, if you reformat the disc, all recorded contents will be erased.

+R Finalizing is necessary when playing on any equipment other than this recorder.

-R After finalizing, you cannot edit or record on the disc.

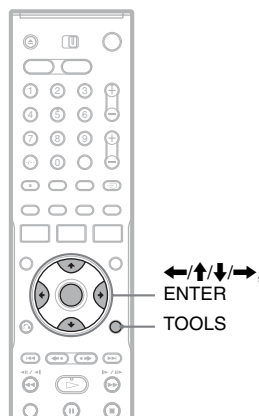

- 1 Insert a disc.**
See “Inserting a Disc” on page 29.
- 2 Press TOOLS to select “Disc Info,” and press ENTER.**
The “Disc Information” display appears.
- 3 Select “Finalize,” and press ENTER.**
The display shows the approximate time required for finalizing and asks for confirmation.

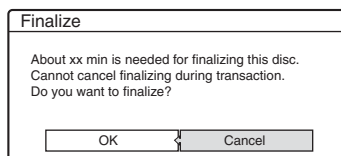

- 4 Select “OK,” and press ENTER.**
The recorder starts finalizing the disc.

Hint

You can check whether the disc has been finalized or not. If you cannot select “Finalize” in step 3 above, the disc has already been finalized.

Notes

- Depending on the condition of the disc, recording, or the DVD equipment, discs may not play even if the discs are finalized.
- The recorder may not be able to finalize the disc if it was recorded on another recorder.

Unfinalizing a disc

-RWVR -RWVideo

For DVD-RWs (Video mode)

DVD-RW (Video mode) that have been finalized to prohibit additional recording or editing can be unfinalized to allow further recording or editing.

For DVD-RWs (VR mode)

If you cannot record or edit on a DVD-RW (VR mode) that has been finalized with other DVD equipment, "This disc was finalized. Unfinalize it." may appear.

Note

The recorder is not able to unfinalize DVD-RWs (Video mode) that have been finalized on another recorder.

1 Insert a disc.

See "Inserting a Disc" on page 29.

2 Press **TOOLS** to select "Disc Info," and press **ENTER**.

The "Disc Information" display appears.

3 Select "Unfinalize," and press **ENTER**.

The recorder starts unfinalizing the disc. Unfinalizing may take several minutes.

Before Recording

Before you start recording...

- This recorder can record on various discs. Select the disc type according to your needs (page 8).
- Check that the disc has enough available space for the recording (page 29). For HDD, DVD+RWs, and DVD-RWs, you can free up disc space by erasing titles (page 69).
- Adjust the recording picture quality and picture size if necessary (page 47).

Hint

Timer recordings will be made regardless whether or not the recorder is turned on. You can turn off the recorder without affecting the recording even after recording starts.

Note

To play a recorded disc on other DVD equipment, finalize the disc (page 39).

Recording mode

Like the SP or LP recording mode of VCRs, this recorder has eight different recording modes. Select a recording mode according to the time and picture quality you need. For example, if picture quality is your top priority, select the High Quality mode (HQ). If recording time is your priority, Super Extended Play mode (SEP) can be a possible choice. Note that recording times in the following table are approximate and the actual times may differ. Note also that the maximum continuous recording time for a single title is eight hours. Contents beyond this time will not be recorded.

Press REC MODE repeatedly to switch the recording modes.

Recording mode	Recording time (hours)			
	HDD			DVD*
	RDR-HX510	RDR-HX710	RDR-HX910	
HQ (High quality)	16	33	53	1
HSP	↑ 25	51	81	1 hr. 30 min.
SP (Standard mode)	33	67	107	2
LSP	↓ 42	85	135	2 hr. 30 min.
LP	↓ 51	103	164	3
EP	↓ 68	137	217	4
SLP	↓ 101	204	325	6
SEP (Long duration)	134	269	428	8

* The recording time for DVD+R DL (Double Layer) discs is as follows:

HQ: 1 hour 48 minutes
 HSP: 2 hours 42 minutes
 SP: 3 hours 37 minutes
 LSP: 4 hours 31 minutes
 LP: 5 hours 25 minutes
 EP: 7 hours 14 minutes
 SLP: 10 hours 51 minutes
 SEP: 14 hours 28 minutes

“HQ+” recording mode

“HQ+” records pictures in higher quality than HQ on the HDD. Set “HQ Setting” in “Features” setup to “HQ+” (page 93). Maximum recording time is 10 hours for RDR-HX510, 21 hours for RDR-HX710, or 34 hours for RDR-HX910. “HQ” appears in the display.

Note

Situations below may cause slight inaccuracies with the recording time.

- Recording a programme with poor reception, or a programme or video source of low picture quality
- Recording on a disc that has already been edited
- Recording only a still picture or just sound

Recording stereo and bilingual programmes

The recorder automatically receives and records stereo and bilingual programmes based on the ZWEITON system or the NICAM system. The HDD and a DVD-RW (VR mode) can record both main and sub sounds. You can switch between main and sub when playing the disc. For the HDD, you can select the sound track before recording. Select “Main,” “Sub,” or “Main+Sub” in “HDD Bilingual Rec.” of “Options” setup (page 93).

A DVD+RW, DVD-RW (Video mode), DVD+R, or DVD-R can record only one sound track (main or sub) at a time. Select the sound track using the Setup Display before recording starts. Set “DVD Bilingual Rec.” to “Main” (default) or “Sub” in “Options” setup (page 94).

ZWEITON (German stereo) system

When a stereo based programme is received, “Stereo” appears.

When a bilingual ZWEITON based programme is received, “Main,” “Sub,” or “Main/Sub” appears.

NICAM system

When a stereo or bilingual NICAM based programme is received, “NICAM” appears in the front panel display.

To record a NICAM programme, be sure to set “Audio” of “Channel Setting” in “Settings” setup to “NICAM” (default). If the sound is not clear when listening to NICAM broadcasts, set “Audio” to “Standard” (see “Channel Setting” on page 82).









Hint

You can select the audio (main or sub) while recording bilingual programmes using the  (audio) button. This does not affect the recorded sound.

Unrecordable pictures

Pictures with copy protection cannot be recorded on this recorder.

When the recorder receives a copy guard signal, the recorder continues to record but only a blank, grey coloured screen will be recorded.

Copy control signals	Recordable discs
Copy-Free	     
Copy-Once	  (CPRM*)
Copy-Never	None (a blank screen is recorded)

* The recorded disc can be played only on CPRM compatible equipment (page 8).

Timer Recording (Standard/VIDEO Plus+)

HDD **+RW** **-RWVR** **-RWVideo** **+R** **-R**

You can set the timer for a total of 30 programmes (8 programmes when using the PDC/VPS function), up to one month in advance.

There are two methods to set the timer: the standard method and VIDEO Plus+ (RDR-HX710/HX910 only) method.

- Standard: Set the date, time, and programme position of the programme manually.
- VIDEO Plus+ (RDR-HX710/HX910 only): Enter the PlusCode number designated for each TV programme (page 45).

Setting the timer manually (Standard)

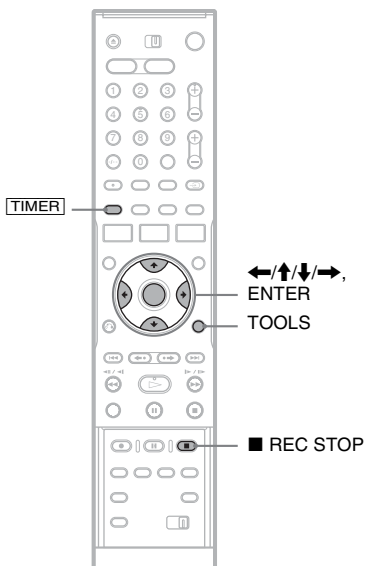

1 Press **TIMER**.

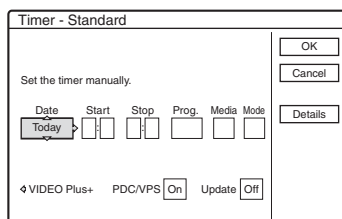

- If the “Timer – VIDEO Plus+” display appears, press **←** to switch the display to “Standard” (RDR-HX710/HX910 only).

2 Select an item using **←/→** and adjust using **↑/↓**.

“Date”: Sets the date.

The item changes as follows:

Today ↔ Tomorrow ↔ ↔ Thu 28.10 (1 month later) ↔ Sun (every Sunday) ↔ ↔ Sat (every Saturday) ↔ Mon-Fri (Monday to Friday) ↔ Mon-Sat (Monday to Saturday) ↔ Sun-Sat (Sunday to Saturday) ↔ Today

“Start”: Sets the start time.

“Stop”: Sets the stop time.

“Prog.”: Selects the programme position or input source.

“Media”: Selects the media, HDD or DVD.

“Mode”: Selects the recording mode (page 41).

- If you want to change the setting for the PDC/VPS or Update functions, select “Details” and press ENTER. Select an item using **←/→** and set using **↑/↓**.

“PDC/VPS”: Sets the PDC/VPS function. See “About the PDC/VPS function” below.

“Update” (HDD only): Automatically records over a previously recorded programme that is set to be recorded daily or weekly.

To return to the Timer programming menu, select “Previous” and ENTER.

- If you make a mistake, select the item and change the setting.

3 Select **“OK,”** and press **ENTER**.

The Timer List (page 48) appears. The **TIMER REC** indicator lights up on the front panel and the recorder is ready to start recording.

Unlike a VCR, there is no need to turn off the recorder before the timer recording starts.

To stop recording during timer recording

Open the remote's cover and press **■ REC STOP**. Note that it may take a few seconds for the recorder to stop recording.

About the PDC/VPS function

PDC/VPS signals are transmitted with TV programmes in some broadcast systems. These signals ensure that timer recordings are made regardless of any broadcast delays, early starts, or broadcast interruptions.

◆ To use the PDC/VPS function

Set "PDC/VPS" to "On" in step 2 above.

When you turn on this function, the recorder starts scanning the channel before the timer recording starts. If you are watching TV when scanning starts, a message will appear on the TV screen. If you want to watch TV, switch to your TV's tuner or turn off the PDC/VPS channel scan function. Note that if you turn off the PDC/VPS channel scan function, the timer recording will not start.

◆ To turn off the PDC/VPS channel scan

Press **TOOLS** and select "PDC/VPS Scan Off."

To ensure that the PDC/VPS function works properly, turn off the recorder before the timer recording starts. This will automatically turn on the PDC/VPS channel scan function while the recorder remains off.

Rec Mode Adjust

If there is not enough available disc space for the recording, the recorder automatically adjusts the recording mode to enable the entire programme to be recorded. This function is normally set to "On."

To cancel this function, press **TOOLS** while the Timer List is displayed. Select "Rec Mode Adjust" and press **ENTER**. Select "Off" and press **ENTER**.

If the timer settings overlap

Overlapped timer settings are shown as follows.

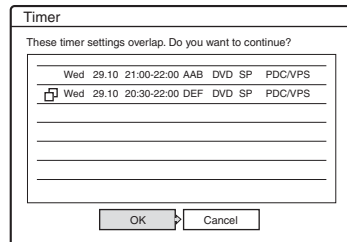

To store the setting as shown, select "OK." The programme that starts first has priority and the second programme starts recording only after the first programme has finished.

To cancel the overlapped setting, select "Cancel."

To confirm, change, or cancel timer recording

See "Checking/Changing/Canceling Timer Settings (Timer List)" on page 48.

To extend the recording duration time while recording

- 1 Press **TOOLS** during recording to select "Extend Rec.," and press **ENTER**.

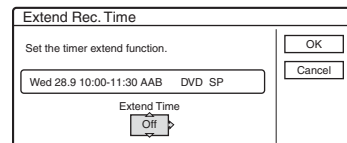

- 2 Press **↑/↓** to select the duration time. You can set the duration in increments of 10 minutes, for a maximum of 60 minutes.

- 3 Select "OK" and press **ENTER**.

One Touch Timer

If you use the SMARTLINK connection, you can easily display the timer programming menu. When the TV is turned on or in standby mode, press **TIMER**. The recorder automatically turns on and the TV's input is switched to the recorder. The Timer programming menu appears.

Hint

You can play the recorded programme by selecting the programme title in the Title List.

Notes

- If a message indicating that the disc is full appears on the screen, change the disc, or make available space for the recording (HDD/DVD+RW/DVD-RW only) (page 68).
- Check that the clock is correctly set before setting the timer recording. If not, the timer recording cannot be made.
To record a satellite programme, turn on the satellite tuner and select the satellite programme you want to record. Leave the satellite tuner turned on until the recorder finishes recording. If you connect equipment with a timer function, you can use the Synchro Rec function (page 50).
- Even if the timer is set for the same daily or weekly programme, the timer recording cannot be made if it overlaps with a programme that has priority. “” will appear next to the overlapped setting in the Timer List. Check the priority order of the settings.
- Even if the timer is set, timer recordings cannot be made while recording a programme that has priority.
- The Rec Mode Adjust function only works with a timer recording and the PDC/VPS function set to off. It does not function with Quick Timer or Synchro Rec. In addition, the Rec Mode Adjust function does not work when recording to the HDD while “Auto Title Erase” is set to “On.”
- The beginning of some recordings may not be made when using the PDC/VPS function.
- You cannot extend the recording duration time when “PDC/VPS” is set to “On.”

Recording TV programmes using the VIDEO Plus+ system (RDR-HX710/HX910 only)

The VIDEO Plus+ system is a feature that simplifies setting the timer. Just enter the PlusCode number listed in the TV programme guide. The date, time, and programme position of that programme are set automatically. Check that the programme positions are correctly set in “Channel Setting” in “Settings” setup (page 82).

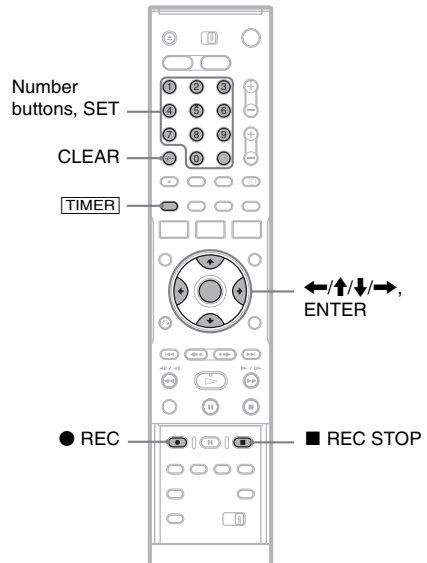

1 Press **TIMER**.

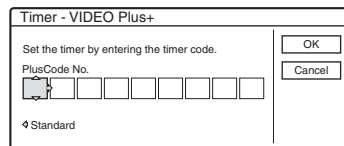

- If the “Timer – Standard” display appears, press  to switch the display to “VIDEO Plus+.”

2 Press the number buttons to enter the PlusCode number, and press SET.

- If you make a mistake, press CLEAR and re-enter the correct number.

3 Select "OK," and press ENTER.

The date, start and stop times, programme position, recording mode, etc. setting (page 44) appear.

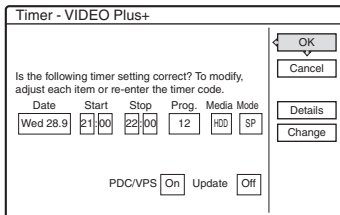

- If you want to change the setting, press ←/→ to select the item and press ↑/↓ to change the setting. For the PDC/VPS or Update functions, select "Details" and change the settings (page 44).

To re-enter the PlusCode number, select "Change."

4 Select "OK," and press ENTER.

The TIMER REC indicator lights up on the front panel, and the recorder is ready to start recording.

To stop recording during timer recording

Open the remote's cover and press ■ REC STOP. Note that it may take a few seconds for the recorder to stop recording.

If the timer settings overlap

See page 44.

To extend the recording duration time while recording

See page 44.

To confirm, change, or cancel timer recording

See "Checking/Changing/Cancelling Timer Settings (Timer List)" on page 48.

💡 Hint

The Rec Mode Adjust function also works with this timer method (page 44).

Using the Quick Timer function

You can set the recorder to record in 30-minute increments.

Press ● REC repeatedly to set the duration.

Each press advances the time in 30-minute increments. The maximum duration is six hours.

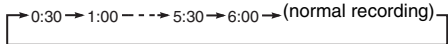

The time counter decreases minute by minute to 0:00, then the recorder stops recording (power does not turn off). Even if you turn off the recorder during recording, the recorder continues to record until the time counter runs out.

Note that the Quick Timer function does not work if "TV Direct Rec" is set to "On" in "Features" setup (page 91).

To cancel the Quick Timer

Press ● REC repeatedly until the counter appears in the front panel display. The recorder returns to normal recording mode.

Adjusting the recording picture quality and size

You can adjust the recording picture quality and picture size.

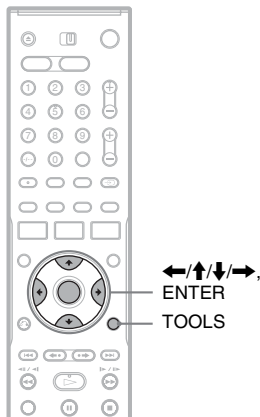

1 Before recording starts, press **TOOLS** to select “Rec Settings,” and press **ENTER**.

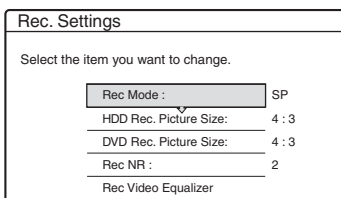

2 Select the item you want to adjust, and press **ENTER**.

The adjustment display appears.

Example: Rec NR

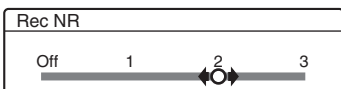

“Rec Mode”: Selects the recording mode for the desired recording time and picture quality. For more information, see “Recording mode” on page 41.

“HDD Rec. Picture Size”/“DVD Rec. Picture Size”: Sets the picture size of the programme to be recorded.

- 4:3 (default): Sets the picture size to 4:3.
- 16:9: Sets the picture size to 16:9 (wide mode).
- Auto (HDD only): Automatically selects the actual picture size.

“DVD Rec. Picture Size” works with DVD-Rs and DVD-RWs (Video mode) when the recording mode is set to HQ, HSP, or SP. For all other recording modes, the screen size is fixed at “4:3.”

For DVD-RWs (VR mode), the actual picture size is recorded regardless of the setting. For example, if a 16:9 size picture is received, the disc records the picture as 16:9 even if “DVD Rec. Picture Size” is set to “4:3.”

For DVD+RWs/DVD+Rs, the screen size is fixed at “4:3.”

“Rec NR” (noise reduction): Reduces noise contained in the video signal.

“Rec Video Equalizer”: Adjusts the picture in greater detail.

Press **↑/↓** to select the item you want to adjust, then press **ENTER**.

- Contrast: Changes the contrast.
- Brightness: Changes the overall brightness.
- Colour: Makes the colours deeper or lighter.

3 Adjust the setting using **←/↑/↓/→**, and press **ENTER**.

The default setting is underlined.

“Rec NR”: (weak) Off 1 ~ 2 ~ 3 (strong)

“Rec Video Equalizer”:

- Contrast: (weak) -3 ~ 0 ~ 3 (strong)
- Brightness: (dark) -3 ~ 0 ~ 3 (bright)
- Colour: (light) -3 ~ 0 ~ 3 (deep)

Repeat steps 2 and 3 to adjust any other items.

Notes

- If one programme contains two picture sizes, the selected size is recorded. However, if the 16:9 signal cannot be recorded as 16:9, it is recorded as 4:3.
- Remnants of images may appear on your screen when using “Rec NR.”
- “Rec Video Equalizer” does not affect the input of the DV IN jack (RDR-HX710/HX910 only) and does not work with RGB signals.

Creating chapters in a title

The recorder can automatically divide a recording (a title) into chapters by inserting chapter marks during recording. To disable this function, set “Auto Chapter” in “Features” setup to “Off” (page 91).

When recording on the HDD or a DVD-RW (VR mode)

The recorder detects changes in the picture and sound and automatically inserts chapter marks. You can also insert and erase chapter marks manually (page 69).

When recording on other recordable discs

Chapter marks are inserted at approximately 6-minute intervals during recording.

Note

When dubbing (page 72), the chapter marks in the dubbing source are not retained in the dubbed title.

Checking/Changing/ Cancelling Timer Settings (Timer List)

HDD +RW -RWVR -RWVideo +R -R

You can check, change, or cancel timer settings using the Timer List.

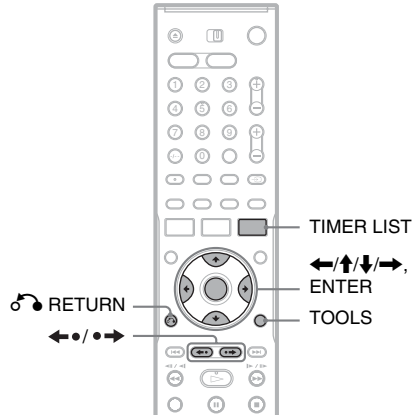

1 Press TIMER LIST.

The Timer List appears.

TIMER LIST						10:30
●	Mon-Sat	22:00-22:15	AAB	SP		
○	Fri	29.10	20:30-21:30	DEF	SP	PDC VPS
○	Fri	29.10	21:00-22:00	GHI	SLP	PDC VPS
○	Sat	30.10	16:00-17:00	DEF	SLP	

Timer information displays the recording date, time, recording mode, etc.

☐: Indicates that the setting is overlapped by another setting.

● (green): Indicates the setting can be recorded.

● (red): Indicates the setting currently being recorded.

○ (grey): Indicates that the setting cannot be recorded in the selected recording mode.

● (HDD): Indicates the setting being recorded on the HDD.

● (DVD): Indicates the setting being recorded on a DVD.

: Indicates the setting that the Update function is set for.

When all of the timer settings do not fit on the list, scroll bar appears.

To view the hidden timer settings, press **↑/↓**.

2 Select the timer setting you want to check/change/cancel, and press ENTER.

The sub-menu appears.

3 Select one of the options, and press ENTER.

“Modify”: Changes the timer setting.

Select an item using **←/→** and adjust using **↑/↓**. For the PDC/VPS or Update functions, select “Details” and change the settings (page 44). Select “OK,” and press ENTER.

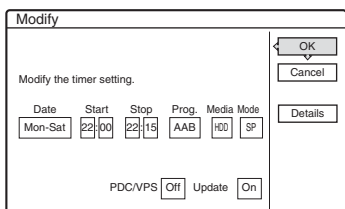

“Erase”: Erases the timer setting. Select “OK,” and press ENTER.

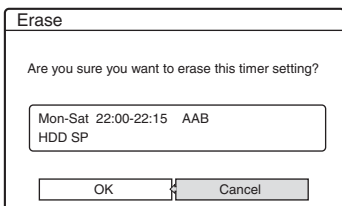

“Check Overlap”: Checks for overlapped settings.

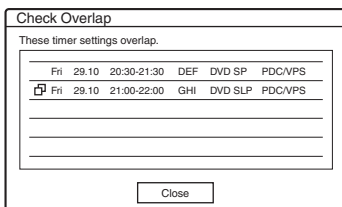

Select “Close” to return to the Timer List. To change or cancel the setting, repeat steps 2 and 3 above.

When the timer settings overlap

The programme that starts first has priority and the second programme starts recording only after the first programme has finished.



◆ When the recordings start at the same time

The programme that is set last has priority. In this example, timer setting B is set after A, so the first part of timer setting A will not be recorded.

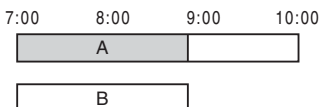

◆ When the end time of one recording and the start time of another are the same

After finishing the previous recording, the other recording may be delayed.

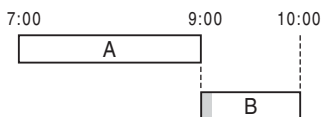

To scroll the list display by page (Page mode)

Press **←•/•→** while the list display is turned on. Each time you press **←•/•→**, the entire Timer List changes to the next/previous page of timer settings.

To turn off the Timer List

Press **TIMER LIST** or **RETURN**.

Hint

While recording, you cannot modify the timer setting for the current recording, but you can extend the recording duration of the recording time (page 44).

Notes

- When “PDC/VPS” is set to “On” for one or more timer recordings, the start times may change in the event of a broadcast delay or early start.
- Even if the timer is set, timer recordings cannot be made while recording a programme that has priority.
- Even if the timer is set for the same daily or weekly programme, the timer recording cannot be made if it overlaps with a programme that has priority. “” will appear next to the overlapped setting in the Timer List. Check the priority order of the settings.

Automatically erasing old titles (Auto Title Erase)

HDD

If there is not enough space for a timer recording, the recorder automatically erases old titles recorded on the HDD. The oldest, played title is erased. The protected titles are not erased.

- 1 Press TIMER LIST.**
The Timer List appears.
- 2 Press TOOLS to select “Auto Title Erase,” and press ENTER.**
- 3 Select “On,” and press ENTER.**
The default setting is “Off.”

Recording From Connected Equipment

HDD +RW -RWVR -RWVideo +R -R

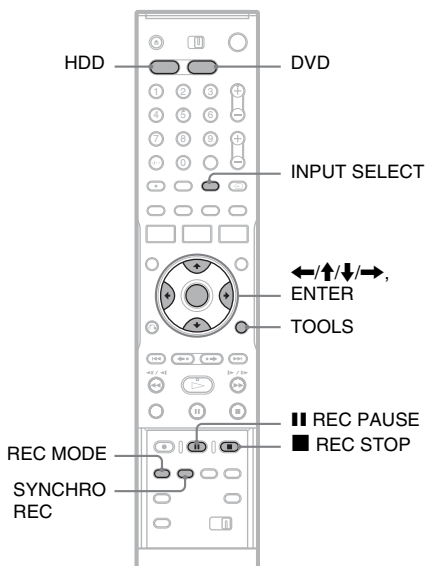

Recording from connected equipment with a timer (Synchro Rec)

You can set the recorder to automatically record programmes from connected equipment that has a timer function (such as a satellite tuner). Connect the equipment to the LINE 3/DECODER jack of the recorder (page 25).

When the connected equipment turns on, the recorder starts recording a programme from the LINE 3/DECODER jack.

- 1 Before recording, select HDD or DVD.**
If you select DVD, insert a recordable DVD (see “Inserting a Disc” on page 29).
- 2 Set “Synchro Rec” in “Features” setup to “Record to HDD” or “Record to DVD” (page 93).**

3 Press **INPUT SELECT** repeatedly to select “L3.”

4 Select the line input audio when recording a bilingual programme on the HDD or DVD-RWs (VR mode).

Press **TOOLS** to select “Line Audio Input,” and press **ENTER**. Then select “Bilingual,” and press **ENTER**.

For details about bilingual recording, see page 42.

5 Press **REC MODE** repeatedly to select the recording mode.

For details about the recording mode, see page 41.

6 Set the timer on the connected equipment to the time of the programme you want to record, and turn it off.

7 Press **SYNCHRO REC**.

The **SYNCHRO REC** indicator lights up on the front panel. The recorder is ready to start Synchro-Recording.

The recorder automatically starts recording when it receives an input signal from the connected equipment. The recorder stops recording when the connected equipment turns off.

⚡ Notes

- The recorder starts recording only after detecting the video signal from the connected equipment. The beginning of the programme may not be recorded regardless of whether or not the recorder’s power is on or off.
- During Synchro-Recording, other operations such as normal recording cannot be done.
- To use the connected equipment while the recorder is standing by for Synchro-Recording, cancel Synchro-Recording by pressing **SYNCHRO REC**. Be sure to turn off the connected equipment and press **SYNCHRO REC** to reset Synchro-Recording before the timer recording starts.
- The Synchro Rec function does not work when “Line3 Input” of “Scart Setting” in “Video” setup is set to “Decoder” (page 89).
- The Synchro Rec function does not work with some tuners. For details, see the tuner’s operating instructions.
- While the recorder is standing by for Synchro-Recording, the Auto Clock Set function (page 86) does not work.
- To use the Synchro Rec function, you must first set the recorder’s clock correctly.

If the timer settings of a Synchro-Recording and another timer recording overlap

Regardless of whether or not the programme is a Synchro Rec programme, the programme that starts first has priority and the second programme starts recording only after the first programme has finished.

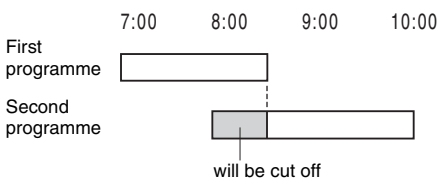

To stop recording

Press **■ REC STOP** or **SYNCHRO REC**.

To cancel Synchro Rec

Press **SYNCHRO REC**.

The **SYNCHRO REC** indicator on the recorder turns off.

Recording from connected equipment without a timer

You can record from a connected VCR or similar device. To connect a VCR or similar device, see “Connecting a VCR or Similar Device” on page 23. Use the DV IN jack on the front panel if the equipment has a DV output jack (i.LINK jack) (RDR-HX710/HX910 only).

1 Press HDD or DVD.

If you select DVD, insert a recordable DVD (see “Inserting a Disc” on page 29).

2 Press INPUT SELECT to select an input source according to the connection you made.

The front panel display changes as follows:

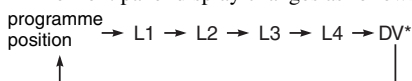

3 Select the line input audio when recording a bilingual programme on the HDD or DVD-RWs (VR mode).

Press TOOLS to select “Line Audio Input,” and press ENTER. Then select “Bilingual,” and press ENTER.

For details about bilingual recording, see page 42.

4 Press REC MODE repeatedly to select the recording mode.

For details about the recording mode, see page 41.

5 Press ■ REC PAUSE to set this recorder to record pause.

6 Insert the source tape into the connected equipment and set to playback pause.

7 At the same time, press ■ REC PAUSE on this recorder and the pause or play button on the connected equipment.

Recording starts.

To stop recording, press ■ REC STOP on this recorder.

If you connect a digital video camera with a DV IN jack (RDR-HX710/HX910 only)

See “DV Dubbing (RDR-HX710/HX910 only)” on page 77 for an explanation of how to record from the DV IN jack.

💡 Hint

You can adjust the settings for the recording picture before recording. See “Adjusting the recording picture quality and size” on page 47.

📌 Notes

- When recording a video game image, the screen may not be clear.
- Any programme that contains a Copy-Never copy guard signal cannot be recorded. The recorder continues to record, but a blank screen will be recorded.

* RDR-HX710/HX910 only

Playback

Playing

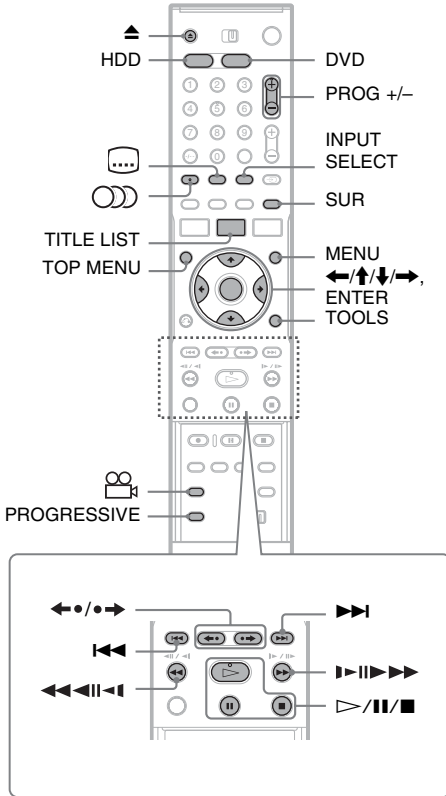

1 Press **HDD** or **DVD**.

- If you select DVD, insert a disc (see “Inserting a Disc” on page 29).
- If you insert a DVD VIDEO, VIDEO CD, or CD, press \triangleright . Playback starts.

2 Press **TITLE LIST**.

For details about the Title List, see “3. Playing the Recorded Programme (Title List)” on page 32.

Example: DVD-RW (VR mode)

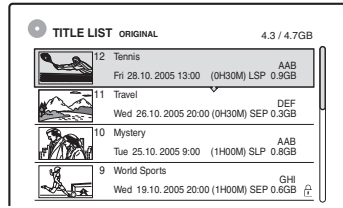

3 Select the title, and press **ENTER**.

The sub-menu appears.

4 Select “Play,” and press **ENTER**.

Playback starts from the selected title.

To use the DVD’s Menu

When you play a DVD VIDEO, or a finalized DVD+RW, DVD-RW (Video mode), DVD+R, or DVD-R, you can display the disc’s menu by pressing TOP MENU or MENU.

To play VIDEO CDs with PBC functions

PBC (Playback Control) allows you to play VIDEO CDs interactively using the menu on your TV screen.

When you start playing a VIDEO CD with PBC functions, the menu appears. Select an item using the number buttons and press ENTER. Then, follow the instructions in the menu (press \triangleright when “Press SELECT” appears). The PBC function of Super VIDEO CDs does not work with this recorder. Super VIDEO CDs are played in continuous play mode only.

To stop playback

Press \blacksquare .

To playback quickly with sound (Scan Audio)

When you press \blacktriangleright during playback of a title recorded in the HDD, you can play quickly with dialogue or sound (“x1.5” appears). No sound is output when you press \blacktriangleright two or more times to change search speed.

To resume playback from the point where you stopped (Resume Play)

When you press \triangleright again after you stop playback, the recorder resumes playback from the point where you pressed \blacksquare .

To start from the beginning, press TOOLS to select "Play Beginning," and press ENTER. Playback starts from the beginning of the title/track/scene.

The point where you stopped playing is cleared when:

- you open the disc tray (except for HDD).
- you play another title (except for HDD).
- you switch the Title List menu to Original or Playlist (HDD/DVD-RW in VR mode only).
- you edit the title after stopping playback.
- you change the settings on the recorder.
- you turn off the recorder (VIDEO CD/CD/ DATA DVD/DATA CD only).
- you make a recording (except for HDD/DVD-RWs in VR mode).
- you switch between JPEG and MP3.

Note

You cannot resume playback during TV Pause.

To play restricted DVDs (Parental Control)

If you play a restricted DVD, the message "Do you want temporarily change parental control to *?" appears on your TV screen.

- 1** Select "OK" and press ENTER.
The display for entering your password appears.
- 2** Enter your four-digit password using the number buttons.
- 3** Press ENTER to select "OK."
The recorder starts playback.

To register or change the password, see "Parental Control (DVD VIDEO only)" on page 92.

To lock the disc tray (Child Lock)

You can lock the disc tray to prevent children from ejecting the disc.

When the recorder is turned on, hold down \blacksquare until "LOCKED" appears in the front panel display.

The \blacktriangle (open/close) button does not work while the Child Lock is set.

To unlock the disc tray, hold down \blacksquare until "UNLOCKED" appears in the front panel display when the recorder is turned on.

One Touch Play

If you use the SMARTLINK connection, you can easily start playing.

Press \triangleright . The recorder and your TV automatically turn on and the TV's input is switched to the recorder. Playback starts automatically.

One Touch Menu

If you use the SMARTLINK connection, you can easily display the Title List.









































Press TITLE LIST. The recorder and your TV automatically turn on and the TV's input is switched to the recorder. The Title List appears.







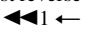

Hints

- You can also use the \triangleright button in step 3 (page 53) to start playback.
- Even if you select "Factory Setup" in "Options" setup (page 94), the Child Lock remains set.

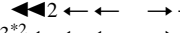
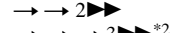
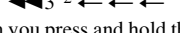
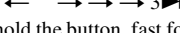
Playback options

To check the position of the buttons below, see the illustration on page 53.

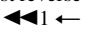
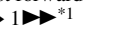
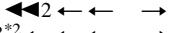
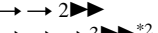
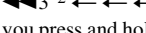
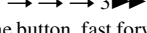
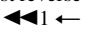
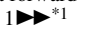
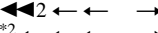
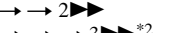
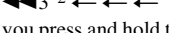
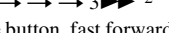
Buttons	Operations
 (audio)     	Selects one of the audio tracks recorded on the disc when pressed repeatedly.  : Selects the language.   : Selects the main or sub sound.   : Selects stereo or monaural audio tracks.
 (subtitle) 	Selects a subtitle language when pressed repeatedly.
 (angle) 	Selects an angle when pressed repeatedly. If various angles (multi-angles) for a scene are recorded on the disc, "  " appears in the front panel display.
SUR (surround)      	Selects one of the TVS effects when pressed repeatedly. TVS* (TV Virtual Surround) lets you enjoy virtual surround sound effects created from the front left and right speakers. The selected setting is displayed in the front panel display for a few seconds. "TVS OFF": No surround effect "TVS DYNAMIC": Creates one set of virtual rear speakers. "TVS WIDE": Creates five sets of virtual rear speakers. "TVS NIGHT": Creates five sets of virtual rear speakers. Effective at low volume. "TVS STANDARD": Creates three sets of virtual rear speakers. Effective when you use two separate front speakers. * TVS was developed by Sony to produce home surround sound with just a stereo TV.
PROGRESSIVE        	Switches the type of video output signal to interlace or progressive format (page 16).
 (instant replay/ instant advance)       	Replays the scene/briefly fast forwards the scene.
 (previous/  (next)	Goes to the beginning of the previous/next title/chapter/scene/track. For the HDD, you cannot go to the beginning of the previous/next title.

Buttons	Operations									
 (fast reverse/fast forward)	Fast reverses/fast forwards the disc when pressed during playback. Search speed changes as follows: <div style="text-align: center; margin: 10px 0;"> <table style="margin: auto;"> <tr> <td style="padding: 0 10px;">fast reverse</td> <td style="padding: 0 10px;">fast forward</td> </tr> <tr> <td style="text-align: center;">  </td> <td style="text-align: center;">  </td> </tr> <tr> <td style="text-align: center;">  </td> <td style="text-align: center;">  </td> </tr> <tr> <td style="text-align: center;">  </td> <td style="text-align: center;">  </td> </tr> </table> </div> When you press and hold the button, fast forward/fast reverse continues at the selected speed until you release the button. *1 When you press  once during playback of a title recorded in the HDD, you can play quickly with sound (“x1.5” appears). *2  and  are only available for the HDD and DVDs.	fast reverse	fast forward							
fast reverse	fast forward									
										
										
										
 (slow, freeze frame) <div style="margin-top: 5px;"> <table style="width: 100%; text-align: center;"> <tr> <td style="border: 1px solid black; padding: 2px;">HDD</td> <td style="border: 1px solid black; padding: 2px;">+RW</td> <td style="border: 1px solid black; padding: 2px;">-RWvR</td> </tr> <tr> <td style="border: 1px solid black; padding: 2px;">-RW_{Video}</td> <td style="border: 1px solid black; padding: 2px;">+R</td> <td style="border: 1px solid black; padding: 2px;">-R</td> </tr> <tr> <td style="border: 1px solid black; padding: 2px;">DVD</td> <td style="border: 1px solid black; padding: 2px;">VCD</td> <td style="padding: 2px;">*</td> </tr> </table> </div> * Playback direction only	HDD	+RW	-RWvR	-RW _{Video}	+R	-R	DVD	VCD	*	Plays in slow motion when pressed for more than one second in pause mode. Plays one frame at a time when pressed briefly in pause mode.
HDD	+RW	-RWvR								
-RW _{Video}	+R	-R								
DVD	VCD	*								
 (pause)	Pauses playback.									

To resume normal playback, press .

Notes

- To enjoy the TVS function, set “Digital Out” to “On” and “Dolby Digital” to “D-PCM” and “MPEG” to “PCM” in “Audio” setup.
- The volume may be reduced when surround effects are set.
- When the playback signal does not contain a signal for the rear speakers, the surround effects will be difficult to hear.
In addition, the surround effects may also be difficult to hear depending on the title being played and the environment where the recorder is being used.
- When you select one of the surround modes, turn off the surround settings of the connected TV or amplifier (receiver).
- Make sure that your listening position is between and at an equal distance from your speakers, and that the speakers are located in similar surroundings.
- Angles and subtitles cannot be changed with titles recorded on this recorder.
- When you use the DIGITAL OUT (COAXIAL or OPTICAL) jack to listen to MPEG audio signals and set “MPEG” to “MPEG” in “Audio” setup, no sound will come from your speakers if you select one of the TVS modes.
- 96 kHz PCM audio and DTS audio do not have surround effects.
- The surround effects do not work while performing playback quickly with sound.

Notes on playing DTS sound tracks on a CD

- When playing DTS-encoded CDs, excessive noise will be heard from the analogue stereo jacks. To avoid possible damage to the audio system, the consumer should take proper precautions when the analogue stereo jacks of the recorder are connected to an amplification system. To enjoy DTS Digital Surround™ playback, an external 5.1-channel decoder system must be connected to the digital jack of the recorder.
- Set the sound to “Stereo” using the  (audio) button when you play DTS sound tracks on a CD (page 55).

Notes on playing DVDs with a DTS sound track

DTS audio signals are output only through the DIGITAL OUT (COAXIAL or OPTICAL) jack.
When you play a DVD with DTS sound tracks, set “DTS” to “On” in “Audio” setup (page 90).

Adjusting the picture quality

HDD +RW -RWVR -RWvideo +R -R
 DVD VCD

1 Press TOOLS during playback to select "Video Settings," and press ENTER.

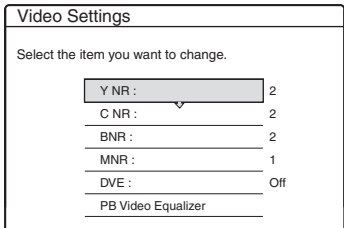

2 Select an item, and press ENTER.

The adjustment display appears.

“Y NR” (luminance noise reduction): Reduces noise contained in the luminance element of the video signal.

“C NR” (chroma noise reduction): Reduces noise contained in the colour element of the video signal.

“BNR” (block noise reduction): Reduces “block noise” or mosaic like patterns in the picture.

“MNR” (mosquito noise reduction): Reduces the faint noise appearing around the outlines of the images. The noise reduction effects are automatically adjusted within each setting range according to the video bit rate and other factors.

“DVE” (digital video enhancer): Sharpens the outlines of the images.

“PB Video Equalizer” (Playback video equalizer): Adjusts the picture in greater detail.

- Select an item and press ENTER.
- Contrast: changes the contrast.
 - Brightness: changes the overall brightness.
 - Colour: makes the colours deeper or lighter.
 - Hue: changes the colour balance.

3 Press ←/→ to adjust the setting, and press ENTER.

The default settings are underlined.

“Y NR”: (weak) Off 1 2 3 (strong)

“C NR”: (weak) Off 1 2 3 (strong)

“BNR”: (weak) Off 1 2 3 (strong)

“MNR”: (weak) Off 1 2 3 (strong)

“DVE”*: (weak) Off 1 2 3 (strong)

“PB Video Equalizer”:

- Contrast: (weak) -3 ~ 0 ~ 3 (strong)
- Brightness: (dark) -3 ~ 0 ~ 3 (bright)
- Colour: (light) -3 ~ 0 ~ 3 (deep)
- Hue: (red) -3 ~ 0 ~ 3 (green)

Repeat steps 2 and 3 to adjust any other items.

* “1” softens the outlines of the images. “2” enhances the outlines and “3” enhances them more than “2.”

Notes

- If the outlines of the images on your screen become blurred, set “BNR” and/or “MNR” to “Off.”
- Depending on the disc or the scene being played, the above BNR, MNR, Y NR, or C NR effects may be hard to discern. And, these functions may not work with some screen sizes.
- When using the DVE function, noise found in the title may become more apparent. In this case, it is recommended that you use the BNR function with the DVE function. If the condition still does not improve, set the DVE level to “1” or “Off.”

Adjusting the sound quality

HDD +RW -RWVR -RWvideo +R -R
 DVD VCD CD DATA CD

1 Press TOOLS during playback to select "Audio Settings," and press ENTER.

2 Select an item, and press ENTER.

“Surround” (TVS): Selects one of the surround modes. For more information, see “Playback options” on page 55.

“Audio Filter”: Selects the digital filter to reduce noise above 22.05 kHz (Fs* is 44.1 kHz), 24 kHz (Fs is 48 kHz), or 48 kHz (Fs is above 96 kHz).

- Sharp (default): Provides a wide frequency range and spatial feeling.

- Slow: Provides smooth and warm sound.

“AV SYNC”: When the video is delayed, this function delays the audio for synchronization with the video (0 to 120 milliseconds). Larger numbers indicate a longer audio delay for synchronization with the video. When dubbing to a VCR or other video recording equipment, be sure to return this setting to 0 ms (default).

* Sampling frequency of audio source. This function only adjusts the output signals from the LINE 1 – TV, LINE 3/DECODER, or LINE 2 OUT (AUDIO L/R).

3 Press ←/↑/↓/→ to select the option, and press ENTER.

Note

There may be little effect by changing the Audio Filter depending on the disc or playback environment.

Pausing a TV Broadcast (TV Pause)

You can pause a current TV broadcast, and then continue watching the programme at a later time. This is useful when you receive an unexpected phone call or visitor while watching TV.

1 While viewing a TV broadcast with this recorder, press II.

The picture pauses. You can pause the picture for up to three hours.

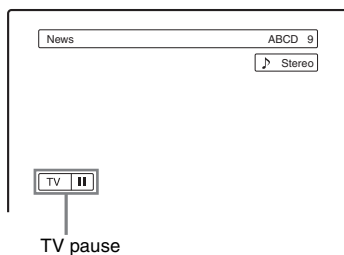

2 Press II or ▷ again to resume watching the programme.

Notes

- Paused titles are not saved to the HDD.
- This function is cancelled when:
 - ■ (stop) is pressed.
 - PROG +/- is pressed.
 - DVD is pressed.
 - ▲ (open/close) is pressed.
 - TITLE LIST is pressed.
 - INPUT SELECT is pressed.
 - the recorder is turned off.
 - a timer recording or Synchro Recording is started.
 - the PDC/VPS function is “On” and channel scan is started.
 - DV dubbing or regular dubbing is started.
- It may take a few seconds to resume playback of the paused programme.
- Even if you fast forward the recorded programme, there will always be a time difference of about one minute or more between the recorded programme and the current TV broadcast.

Playing from the beginning of the programme you are recording (Chasing Playback)

HDD -RWVR

“Chasing Playback” allows you to view the recorded part of a programme while the recording is being made. You do not need to wait until the recording finishes.

Press TOOLS while recording to select “Chasing Playback,” and press ENTER.

Playback starts from the beginning of the programme you are recording.

When you fast forward to the point that you are recording, Chasing Playback returns to normal playback.

Notes

- For DVD-RWs (VR mode), this function does not work when recording:
 - on a 1x-speed DVD-RW.
 - in the HQ or HSP recording mode.
- The DVD’s picture on your TV screen freezes for a few seconds when you fast forward/fast reverse or instant replay/advance the recording.
- Chasing Playback is possible from one minute or more after recording starts.
- Even if you fast forward the recorded programme, there will always be a time difference of about one minute or more between the recorded programme and the current TV broadcast.

Playing a previous recording while making another (Simultaneous Rec and Play)



“Simultaneous Rec and Play” allows you to view a previously recorded programme while recording programmes. Playback continues even if a timer recording starts. Use this function as follows:

- While recording to the HDD:
Play another title on the HDD.
Play a previously recorded programme on a DVD by pressing DVD.
- While recording to a DVD:
Play a previously recorded programme on the HDD by pressing HDD.
- While recording to a DVD-RW (VR mode)^{*1}:
Play another title on the same DVD-RW (VR mode) disc.^{*2}

^{*1} Simultaneous Rec and Play function does not work when you record:

- on a 1x-speed DVD-RW.
- in the HQ or HSP recording mode.

^{*2} Picture noise may appear depending upon the condition of the recording, or when playing a title recorded in the HQ or HSP recording mode. The picture freezes for a few seconds when you use fast forward/fast reverse or instant replay/advance.

You can also play a DVD VIDEO, VIDEO CD, Super VIDEO CD, CD, DATA DVD, or DATA CD while recording on the HDD.

Example: Play another title on the HDD while recording to the HDD.

- 1 While recording, press TITLE LIST to display the HDD Title List.
- 2 Select the title you want to play, and press ENTER.
- 3 Select “Play” from the sub-menu, and press ENTER.
Playback starts from the selected title.

Example: Play a DVD while recording to the HDD.

- 1 While recording, press DVD and insert the DVD into the recorder.
- 2 Press TITLE LIST to display the DVD Title List.
- 3 Select the title you want to play, and press ENTER.
- 4 Select “Play” from the sub-menu, and press ENTER.
Playback starts from the selected title.

Note

You cannot play a DVD or VIDEO CD recorded in the NTSC colour system while recording on the HDD. When playing a VIDEO CD, be sure to set “Colour System” to “PAL” (page 93).

Searching for a Title/Chapter/Track, etc.

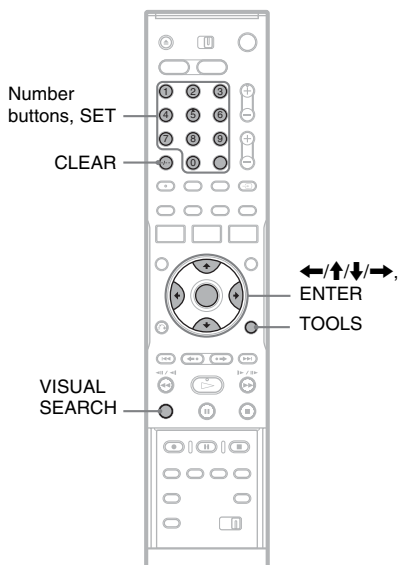

Searching by Thumbnail (Visual Search)

HDD +RW -RWVR -RWVideo +R -R

Each chapter is displayed as a thumbnail. You can search for the desired scene visually.

1 Press VISUAL SEARCH during playback.

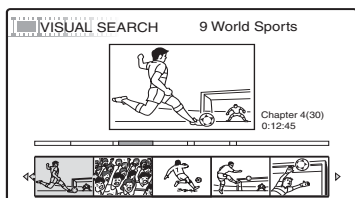

2 Select a scene using ←/→, and press ENTER.

Playback of the selected scene is started.

Searching by title number or time code

HDD +RW -RWVR -RWVideo +R -R
DVD VCD CD DATA DVD DATA CD

You can search a disc by title, chapter, scene or track. As titles and tracks are assigned individual numbers, select the title or track by entering its number. You can also search for a scene using the time code.

1 Press TOOLS during playback to select a search method, and press ENTER.

- “Title Search” (for DVDs)
- “Chapter Search” (for HDD/DVDs)
- “Track Search” (for CDs/DATA CDs)
- “Search” (for VIDEO CDs)
- “Album Search” (for DATA DVDs/DATA CDs)
- “Time Search” (for HDD/DVDs): Searches for a starting point by entering the time code.
- “File Search” (for DATA DVDs/DATA CDs)

The display for entering the number appears.
Example: Title Search



The number in parentheses indicates the total number of titles, tracks, etc.

2 Press the number buttons to select the number of the title, chapter, track, time code, etc., you want.

For example: Time Search
To find a scene at 2 hours, 10 minutes, and 20 seconds, enter “21020.”

If you make a mistake, press CLEAR to cancel the number, then select another number.

3 Press SET.

The recorder starts playback from the selected number.

Note

“Title Search” is not applicable to the HDD.

Playing MP3 Audio Tracks or JPEG Image Files

DATA DVD DATA CD

You can play MP3 audio tracks and JPEG image files on DATA CDs (CD-ROMs/CD-Rs/CD-RWs) or JPEG image files on DATA DVDs (DVD-ROMs/DVD+RWs/DVD+Rs/DVD-RWs/DVD-Rs).

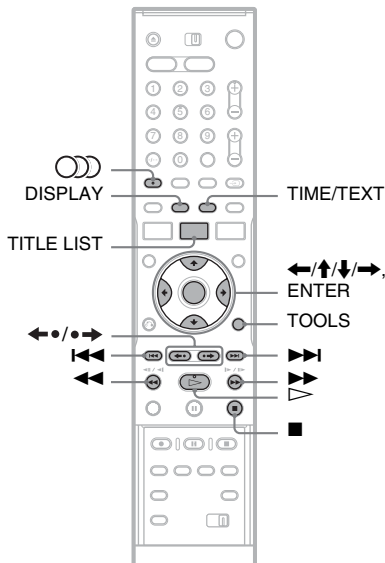

1 Insert a disc.

See “Inserting a Disc” on page 29.

2 Press ▶.

For MP3 discs, playback starts from the first MP3 audio track on the disc.

For JPEG files, a slideshow of the pictures on the disc begins.

If the DATA CD contains both MP3 audio tracks and JPEG image files, playback starts from the JPEG image files the first time ▶ is pressed.

Selecting an MP3 album or track

1 Press TITLE LIST.

The album list appears.

To change the page, press <←/•/•→.

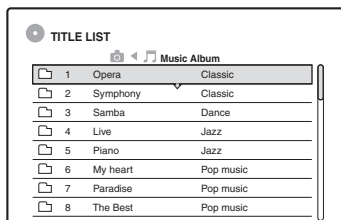

2 Select an album, and press ENTER.

The sub-menu appears.

3 Select “View Album,” and press ENTER.

The track list appears.

To change the page, press <←/•/•→.



4 Select a track, and press ENTER.

“Play”: Plays the track.

“Play Beginning”: Plays the beginning of the track.

“Track Data”: Shows data about the track such as artist and album name.

To stop playback

Press ■.

To fast forward or review a track

Press <◀/▶> during playback.

To go to the next or previous MP3 audio track

Press <◀◀> or <▶▶> during playback. If you repeatedly press <◀◀> or <▶▶>, you will go to the next or previous album.

To go to the next or previous album

Press <←/•/•→> during playback.

💡 Hint

Press the ◯◯◯ (audio) button to switch between stereo or monaural audio tracks.

Selecting a JPEG album or image

1 Press TITLE LIST.

The album list appears.

To change the page, press ◀/▶.

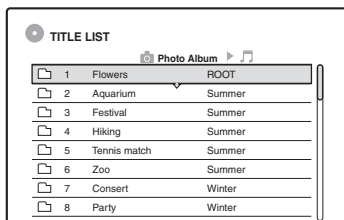

2 Select an album, and press ENTER.

The sub-menu appears.

3 Select "View Album," and press ENTER.

The image list appears.

To change the page, press ◀/▶.

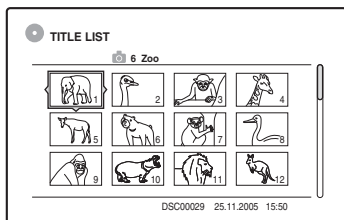

4 Select an image, and press ENTER.

"View Image": Shows the image on the entire screen.

"Slideshow": Shows the images in the album as a slideshow.

"Image Data": Shows data about when the picture was taken.

To stop viewing the JPEG image

Press ■.

To view the next or previous picture

Press ◀◀/▶▶ while the picture is displayed.

To rotate a picture

Press TOOLS while the image is displayed to select "Rotate Right" or "Rotate Left," and press ENTER.

To change the slideshow speed

Press TOOLS while the album list or image list is displayed to select "Slideshow Speed," and press ENTER. Then select the speed from "Fast" (quick), "Normal," and "Slow."

To go to the next or previous album

Press ◀/▶ while the JPEG image is displayed.

💡 Hints

- If you are playing a DATA CD that has both MP3 and JPEG files, you can switch between photo and music albums by using the ◀/▶ buttons when the album list is displayed.
- You can rotate a JPEG image by using the ◀/▶ buttons when the image is displayed.
- Press DISPLAY repeatedly to show information about the JPEG album or image on your TV screen. Then press TIME/TEXT to toggle between the current selected image number and album number.

📌 Notes

- If the DVD disc, such as a disc from a DVD video camera, contains both video and JPEG images, only the video can be played back.
- Some JPEG files, especially files of three million pixels or more, may lengthen the slideshow interval.
- Rotated JPEG images will not be saved when you press ■ or switch to another folder.
- Images larger than 720 × 480 will be reduced to 720 × 480 when displayed.
- Images larger than 4 mega bytes cannot be displayed.
- Progressive JPEG images cannot be displayed.
- When you attempt to play a broken file or a file that does not satisfy the play conditions, 📄 appears but the recorder cannot play the file.

About MP3 audio tracks and JPEG image files

MP3 is audio compression technology that satisfies certain ISO/MPEG regulations. JPEG is image compression technology.

You can play MP3 (MPEG1 Audio Layer 3) format audio tracks and JPEG image files on DATA CDs (CD-ROMs/CD-Rs/CD-RWs) or JPEG image files on DATA DVDs (DVD-ROMs/DVD+RWs/DVD+Rs/DVD-RWs/DVD-Rs).

DATA CDs discs must be recorded according to ISO9660 Level 1, Level 2 or Joliet format for the recorder to recognize the MP3 tracks. DATA DVDs must be recorded in Universal Disc Format (UDF). You can also play discs recorded in MultiSession.

See the instructions supplied with the CD-R/CD-RW/DVD-R/DVD-RW drives and the recording software (not supplied) for details on the recording format.

Note on MultiSession/Border discs

If MP3 audio tracks or JPEG image files are recorded in the first session/border, the recorder will also play MP3 audio tracks or JPEG image files in other sessions/borders. If audio tracks and images in Music CD format or Video CD format are recorded in the first session/border, only the first session/border will be played back.

Note

The recorder may not be able to play some DATA CDs/DATA DVDs created in the Packet Write format.

MP3 audio tracks or JPEG image files that the recorder can play

The recorder can play the following tracks and files:

- MP3 audio tracks with the extension “.MP3,” “.mp3,” or “.Mp3.”
- JPEG image files with the extension “.JPEG,” “.jpg,” “.JPG,” “.Jpg,” “.jpeg,” or “.Jpeg.”
- JPEG image files that conform to the DCF* image file format.

* “Design rule for Camera File system”: Image standards for digital cameras regulated by JEITA (Japan Electronics and Information Technology Industries Association).

Notes

- The recorder will play any data with the extension “.MP3,” “.mp3,” “.Mp3,” “.JPEG,” “.jpg,” “.JPG,” “.Jpg,” “.jpeg,” or “.Jpeg” even if they are not in MP3 or JPEG format. Playing these data may generate a loud noise which could damage your speaker system.
- The recorder does not conform to audio tracks in mp3PRO format.
- Some files cannot be played.
- The letters that cannot be displayed are replaced with “*.”

About playback order of albums, tracks, and files

Albums play in the following order:

Structure of disc contents

Tree 1 Tree 2 Tree 3 Tree 4 Tree 5

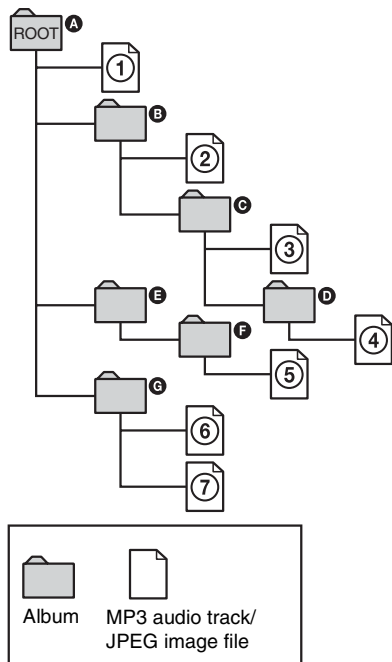

When you insert a DATA CD/DATA DVD and press \triangleright , the numbered tracks (or files) are played sequentially, from ① through ⑦. For JPEG image files, press $\bullet \rightarrow$ to go to the next album. (For instance, when you want to go from ① to ②.) Any sub-albums/tracks (or files) contained within a currently selected album take priority over the next album in the same tree. (Example: C contains D so ④ is played before ⑤.) When you press TITLE LIST and the list of album names appears (page 32), the album names are arranged in the following order: A \rightarrow B \rightarrow C \rightarrow D \rightarrow F \rightarrow G. Albums that do not contain tracks (or files) (such as album E) do not appear in the list.

💡 Hints

- If you add numbers (01, 02, 03, etc.) to the front of the track/file names when you store the tracks (or files) in a disc, the tracks and files will be played in that order.
- Since a disc with many trees takes longer to start playback, it is recommended that you create albums with no more than two trees.

🔍 Notes

- Depending on the software you use to create the DATA DVD/DATA CD, the playback order may differ from the above illustration.
- No more than a total of 199 individual folders can be played. (Folders that do not contain JPEG/MP3 files are counted as well.)
- No more than a total of 999 folders and files can be played. (Files other than JPEG/MP3 files, and folders that do not contain JPEG/MP3 files are counted as well.)
- No more than 200 folders and files can be recognized in a single folder. (Folders that do not contain JPEG/MP3 files are counted as well.)
- Proceeding to the next or another album may take some time.
- This recorder supports MP3 audio bit rates up to 160 kbps.

Before Editing

This recorder offers various edit options for various disc types. Before you edit, check the disc type in the front panel display, and select the option available for your disc (page 8).

Notes

- You may lose the edited contents if you remove the disc or a timer recording starts while editing.
- DVD discs created by DVD video cameras cannot be edited on this recorder.

Edit options for the HDD and DVD-RWs (VR mode)

HDD -RWvR

You can enjoy advanced edit functions. First you have two options for the HDD and DVD-RWs (VR mode): editing either the original recording (called the “original”), or the playback information created from the original (called a “Playlist”). Since each is different in nature and offers different merits, read the following and select the one that better suits your needs.

To edit original titles

Edits made to the original titles are final. If you plan to retain an unaltered original recording, create and edit a Playlist (see below). The edit functions available for original titles are:

- Labelling a title (page 66).
- Setting protection against erasure (page 66).
- Erasing a title (page 66).
- Erasing multiple titles (page 68).
- Erasing a section of a title (A-B Erase) (page 67).
- Erasing all titles on the disc (page 69).
- Erasing a chapter (page 67).
- Dividing one title into two titles (HDD only) (page 68).

To create and edit Playlist titles

A Playlist is a group of Playlist titles created from the original title for editing purposes. When you create a Playlist, only the control information necessary for playback, such as the playback order, is stored on the disc. Since the original titles are left unaltered, Playlist titles can be re-edited.

Example: You have recorded the final few matches of a football tournament on a DVD-RW (VR mode). You want to create a digest with the goal scenes and other highlights, but you also want to keep the original recording.

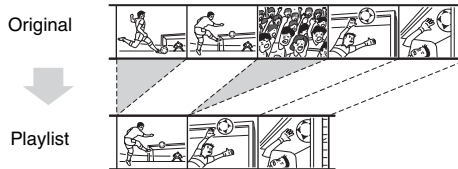

In this case, you can compile highlight scenes as a Playlist title. You can even rearrange the scene order within the Playlist title (“Creating and Editing a Playlist” on page 70).

The advanced edit functions available for Playlist titles are:

- Setting protection against erasure (HDD only) (page 66).
- Labelling a title (page 66).
- Erasing a title (page 66).
- Erasing multiple titles (page 68).
- Erasing a section of a title (A-B Erase) (page 67).
- Rearranging the title order (DVD-RWs (VR mode) only) (page 71).
- Dividing a title into multiple titles (page 68).
- Combining multiple titles into one title (page 71).
- Erasing a chapter (page 67).

Hint

You can display the disc’s Playlist titles in the Title List (Playlist), or the original titles in the Title List (Original). To switch the two Title Lists, press TOOLS while a Title List is displayed, and select “Original” or “Playlist.”

Notes

- The Playlist title calls up data from the original titles for playback. When an original title is used for a Playlist title, the original title cannot be erased.
- If a message appears and indicates that the disc's control information is full, erase or edit unnecessary titles.
- Playlist titles containing titles recorded with the "Copy-Once" copy protection signal cannot be dubbed or moved (page 73).

Edit options for DVD+RWs/DVD-RWs (Video mode)/DVD+Rs/DVD-Rs

+RW -RW_{Video} +R -R

You can perform simple edits. Since Video mode titles are actual recordings on the disc, you cannot undo any edits you make. The edit functions available for Video mode titles are:

- Setting protection against erasure (page 66).
- Labelling a title (page 66).
- Erasing a title (page 66).
- Erasing multiple titles (page 68).
- Erasing a section of a title (A-B Erase) (DVD+RWs only) (page 67).
- Erasing all titles on the disc (page 69).
- Erasing titles to open up disc space (Disc Map) (DVD+RWs and DVD-RWs (Video mode) only) (page 69).

Notes

- When editing a DVD+R or DVD-R, finish all editing before finalizing the disc. You cannot edit a finalized disc.
- The available disc space does not increase even when you erase titles for DVD+Rs and DVD-Rs.
- If a message appears and indicates that the disc's control information is full, erase or edit unnecessary titles.

Erasing and Editing a Title

HDD +RW -RW_{VR} -RW_{Video} +R -R

This section explains the basic edit functions. Note that editing is irreversible. To edit the HDD or DVD-RWs (VR mode) without changing the original recordings, create a Playlist title (page 70).

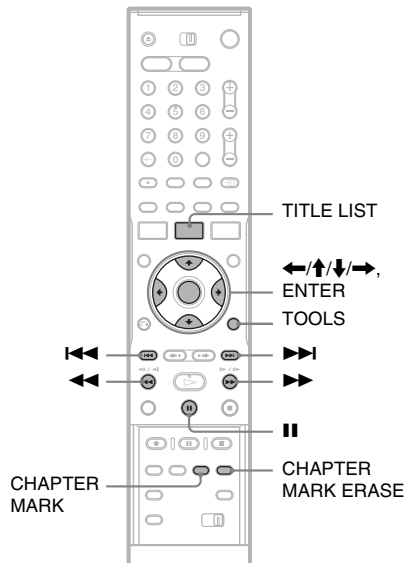

1 Press TITLE LIST.

For HDD titles or DVD-RWs in VR mode, press TOOLS and select "Original" or "Playlist" from the TOOLS menu to switch the Title Lists, if necessary.

2 Select a title, and press ENTER.

The sub-menu appears.

3 Select an option, and press ENTER.

You can make the following edits to the title. "Erase": Erases the selected title. Select "OK" when asked for confirmation.

"Protect": Protects the title. Select "On" when the Protection display appears. "P" appears next to the protected title. To cancel the protection, select "Off."

"Title Name": Allows you to enter or re-enter a title name (page 36).

"Set Thumbnail": Changes the title's thumbnail picture that appears in the Title List (page 34).

“A-B Erase”: Erases a section of the title (page 67).

“Delete Chapter”: Erases chapter units of the title while viewing thumbnails (see below).

“Divide”: Divides a title into two titles (page 68).

Hints

- You can erase multiple titles at one time (page 68), or erase all of the titles on the disc at once (page 69).
- You can automatically erase titles that have already played.
- You can label or re-label DVDs (page 38).

Note

DVD-RW (VR mode) playlist titles cannot be protected.

Erasing a chapter (Delete Chapter)

HDD **-RWvR**

Thumbnails are displayed for each chapter. You can easily select and erase a section in a title. Note that erasing a chapter cannot be undone.

1 After step 2 of “Erasing and Editing a Title,” select “Delete Chapter,” and press **ENTER**.

2 Select a thumbnail of the chapter using **←/→**, and press **ENTER**.

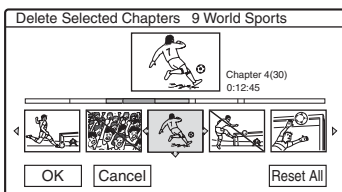

- To cancel the selection, press **ENTER** again.
- To erase multiple chapters, repeat step 2.
- To reset all selections, select “Reset All.”

3 Select “OK,” and press **ENTER**.

The display asks for confirmation.

4 Select “Yes,” and press **ENTER**.

Erasing a section of a title (A-B Erase)

HDD **+RW** **-RWvR**

You can select a section (scene) in a title and erase it. Note that erasing scenes in a title cannot be undone.

1 After step 2 of “Erasing and Editing a Title,” select “A-B Erase” and press **ENTER**.

The display for setting point A appears.

- To return to the beginning of the title, press **II** and then press **◀◀**.

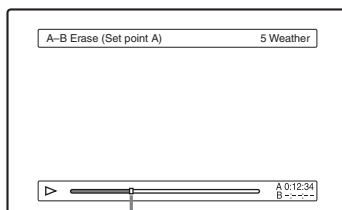

Playback point

2 Select point A by pressing **◀◀/▶▶**, and press **ENTER**.

The display for setting point B appears.

3 Select point B by pressing **◀◀/▶▶**, and press **ENTER**.

The display asks for confirmation.

- To reset either point A or B, select “Change A” or “Change B,” and go to step 2 or 3.
- To preview the title without scenes to be erased, select “Preview” (except for DVD+RWs).

4 Select “OK,” and press **ENTER**.

The scene is erased, and the display asks whether to erase another scene.

- To continue, select “Yes,” and repeat from step 2.
- To finish, select “No.”

Hint

A chapter mark is inserted after the scene was erased. The chapter mark divides the title into separate chapters on either side of the mark.

Notes

- Images or sound may be momentarily interrupted at the point where you erase a section of a title.
- Sections shorter than five seconds may not be erased.
- For DVD+RWs, the erased section may be slightly different from the points you selected.

Erasing multiple titles (Erase Titles)

HDD +RW -RWVR -RWVideo +R -R

You can select and erase more than one title at one time using the TOOLS menu.

1 Press TITLE LIST.

2 Press TOOLS to select “Erase Titles,” and press ENTER.

The display for selecting titles to be erased appears.

3 Select a title, and press ENTER.

A check mark appears in the check box next to the selected title.

- To clear the check mark, press ENTER again.
- To clear all of check marks, select “Reset All.”

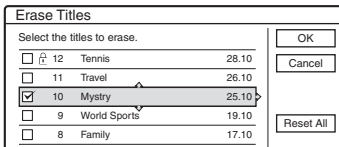

4 Repeat step 3 to select all of the titles you want to erase.

5 When you finish selecting titles, select “OK,” and press ENTER.

The list of the titles to be erased appears for confirmation.

- To change the selection, select “Change,” and repeat from step 3.

6 Select “OK” and press ENTER.

The titles are erased.

Dividing a title (Divide)

HDD -RWVR*

If you want to dub a long title to a disc but do not want to reduce the picture quality, divide the title into two shorter titles. Note that dividing a title cannot be undone.

* Only playlist titles can be divided for DVD-RW (VR mode).

1 Press TITLE LIST.

Press TOOLS and select “Original” or “Playlist” from the TOOLS menu to switch the Title Lists, if necessary.

2 Select a title, and press ENTER.

The sub-menu appears.

3 Select “Divide,” and press ENTER.

The display for setting the dividing point appears. The title starts to play in the background.

- To return to the beginning of the title, press **II** and then press **IIII**.

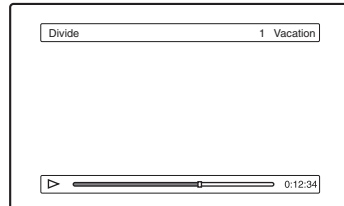

4 Select the dividing point by pressing **IIII** and **IIII**, and press ENTER.

The display asks for confirmation.

- To change the dividing point, select “Change.”

5 Select “OK,” and press ENTER.

The display for entering the title name appears.

- To use the same title name as before, select “No.”

6 Select “Yes,” and press ENTER to enter a new name.

Follow the explanations on page 36. After you enter a new name, the title is divided in two.

Erasing all titles on the disc

HDD +RW -RWVR -RWVideo +R -R

1 Press **TOOLS** to select “Disc Info,” and press **ENTER**.

The “Disc Information” display appears.

2 Select “Erase All,” and press **ENTER**.

3 Select “OK,” and press **ENTER**.

All titles on the disc are erased (except the protected titles).

Erasing titles to open up disc space (Disc Map)

+RW -RWVideo

When recording on a DVD+RW or DVD-RW (Video mode), the recorder searches for the largest open space and records there. Before you start, check the disc status by using Disc Map, and erase titles to create a space large enough for the recording.

1 Insert a disc and press **TITLE LIST**.

2 Press **TOOLS** to select “Disc Map,” and press **ENTER**.

The “Disc Map” display appears.

- To check the open space, select the space by pressing **←/→**.

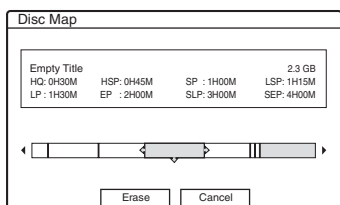

- When **◀** or **▶** appears on either side of the screen, you can scroll sideways by pressing **←/→**.

3 Select a title by pressing **←/→**, and press **ENTER**.

The display for selecting titles to be erased appears.

- To cancel the selection, press **ENTER** again.
- To erase more titles, repeat step 3.

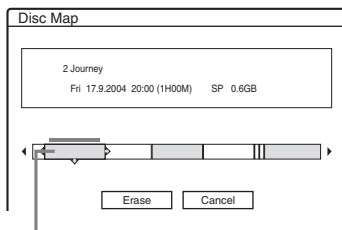

Selected title

4 Select “Erase,” and press **ENTER**.

The display asks for confirmation.

5 Select “OK,” and press **ENTER**.

The selected titles are erased, freeing up disc space.

- To change the selection, select “Change.”

Creating chapters manually

HDD -RWVR

You can manually insert a chapter mark at any point you like during playback or recording.

Press **CHAPTER MARK** at the point where you want to divide the title into chapters.

Each time you press the button, “Marking...” appears on the screen and the scenes to the left and right of the mark become separate chapters.

To erase chapter marks

You can combine two chapters by erasing the chapter mark during playback.

Press **◀◀/▶▶** to search for a chapter number, and while displaying the chapter containing the chapter mark you want to erase, press **CHAPTER MARK ERASE**.

The current chapter combines with the previous chapter.

Notes

- When dubbing, any chapter marks you enter will be erased.
- To insert a chapter mark manually during recording, set “Auto Chapter” in “Features” setup to “Off.”

Creating and Editing a Playlist

HDD **-RWVR**

Playlist edit allows you to edit or re-edit without changing the actual recordings. You can create up to 97 Playlist titles.

Note

Once you create a Playlist title from original titles, you will be unable to erase or edit the original titles.

1 Press TITLE LIST.

2 Press TOOLS to select "Create Playlist," and press ENTER.

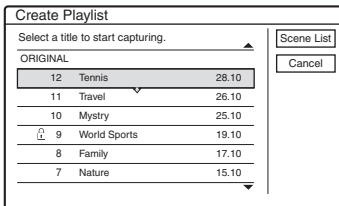

3 Select the title you want to include in the Playlist title, and press ENTER.

The sub-menu appears.

“Capture”: Adds a section of the title to the Playlist title as one scene.

“Capture All”: Adds the entire title to the Playlist title as one scene. After capturing the title, go to step 8.

4 Select "Capture," and press ENTER.

The display for setting the start point (IN) appears. The title starts to play in the background.

- To return to the beginning of the title, press **II** and then press **◀◀**.

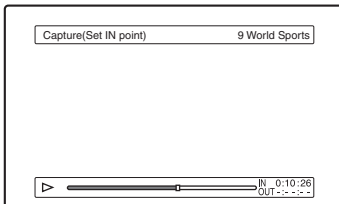

5 Select the IN point by pressing ◀◀/▶▶, and press ENTER.

The display for setting the end point (OUT) appears, and the title continues to play in the background.

6 Select the OUT point by pressing ◀◀/▶▶, and press ENTER.

The display asks for confirmation.

To reset the IN or OUT point, select “Change IN” or “Change OUT” and repeat step 5 or 6. To view the selected scene, select “Preview.”

7 Select "OK," and press ENTER.

The Scene List menu appears with all of the selected scenes.

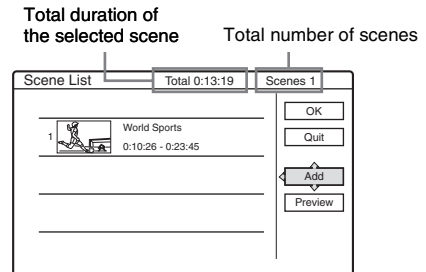

- To add more scenes, select “Add” and go to step 3.
- To preview all of the captured scenes in the listed order, select “Preview.”

8 Select the scene you want to re-edit, and press ENTER.

The sub-menu appears.

“Move”: Changes the scene order.

“Erase”: Erases the scene. The selection is cancelled.

“Preview”: Displays thumbnail pictures of the scenes.

“Change IN”: Allows you to change the IN point, and repeat from step 5.

“Change OUT”: Allows you to change the OUT point, and repeat from step 6.

9 When you finish editing the Scene List, select "OK," and press ENTER.

The display for entering the title name appears.

To enter a new name, select “Enter” (page 36).

10 Select "OK" to use the default name, and press ENTER.

To play the Playlist title

Press TOOLS while the Title List menu is turned on. Then, select “Playlist” and press ENTER. When the Title List (Playlist) menu appears, select a title and press ▷.

Hint

When a Playlist title is created, the IN and OUT points will become chapter marks, and each scene will become a chapter.

Note

The picture may pause when the edited scene is played.

Moving a Playlist title (Change Order)

HDD **-RWVR**

You can change the Playlist title order within the Title List (Playlist).

1 Press TITLE LIST to turn on the Title List (Playlist) menu.

If the Title List (Original) menu appears, press TOOLS and select “Playlist.”

2 Select the title you want to move, and press ENTER.

The sub-menu appears.

3 Select “Change Order,” and press ENTER.

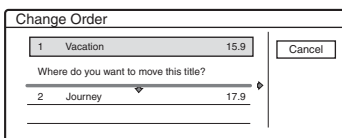

4 Select a new location for the title by pressing ↑/↓, and press ENTER.

The title moves to the new location.

Combining multiple Playlist titles (Combine)

HDD **-RWVR**

1 Press TITLE LIST to turn on the Title List (Playlist) menu.

If the Title List (Original) menu appears, press TOOLS and select “Playlist.”

2 Press TOOLS to select “Combine,” and press ENTER.

The display for selecting titles appears.

3 Select a title, and press ENTER.

A number indicating the order in which you selected the title appears.

To cancel the selection, press ENTER again.

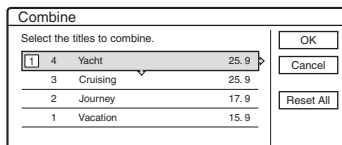

4 Repeat step 3 to select all of the titles you want to combine.

To cancel all of the selections, select “Reset All.”

5 Select “OK,” and press ENTER.

The list of titles to be combined appears.

To change the selection, select “Change” and go to step 3.

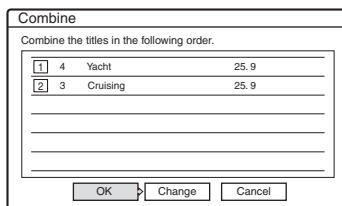

6 Select “OK,” and press ENTER.

The display for selecting a title name from among the selected titles appears.

To enter a new name, select “Enter Text,” and follow the explanations on page 36.

To change the selection, select “Change” and go to step 3.

7 Select a name, and press ENTER.

The titles are combined.

Note

When the number of chapters in the title to be combined exceeds the limit, the chapters at the end are combined into a single chapter.

Dividing a Playlist title (Divide)

HDD **-RWVR**

You can divide a Playlist title. For operations, see page 68.

Before Dubbing

HDD **+RW** **-RW/VR** **-RW_{Video}** **+R** **-R**

In this section, “dubbing” refers to “copying a recorded title on the internal hard disk drive (HDD) to another disc, or vice versa.” You can select to dub one title at a time (Title Dubbing – see “Dubbing a single title (Title Dub)” on page 74), or multiple titles all at once (Multiple Title Dubbing – see “Dubbing multiple titles (Dub Selected Titles)” on page 75).

Before you start, read the following precautions, which are common to both dubbing methods.

If you want to record from a digital video camera connected to the DV IN jack (RDR-HX710/HX910 only), see “DV Dubbing (RDR-HX710/HX910 only)” on page 77. To record from equipment connected to the LINE IN jacks, see “Recording from connected equipment without a timer” on page 52.

Before you start...

- Select the disc type according to your needs (page 8). This recorder can record on various discs.
- You cannot record both the main and sub sound on a DVD+RW, DVD-RW (Video mode), DVD+R, or DVD-R. For bilingual programs, set “DVD Bilingual Rec.” to either “Main” (default) or “Sub” in “Options” setup (page 94).
- Timer recordings and Synchro-Recording do not start during dubbing. Before you start, check the Timer List menu to see if there is any timer recording due to start during dubbing.
- When “Auto Chapter” of “Features” setup is set to “On,” chapter marks are automatically inserted at approximately 6-minute intervals while dubbing from the HDD to a DVD, or when the recorder detects picture and sound changes while dubbing from a DVD to the HDD. The chapter marks in the dubbing source are not retained in the dubbed title.

- For a title whose picture size (16:9 or 4:3) is mixed:
 - When dubbed from the HDD to DVD-RW (Video mode) or DVD-R, the picture size is determined by the setting in “DVD Rec. Picture Size” (page 47).
 - When dubbed from HDD to DVD+RW or DVD+R, the picture size is always 4:3.
 - When dubbed from HDD to DVD-RW (VR mode), the originally recorded picture size is retained.

🔔 Hints

- When you dub a Playlist title, it is recorded as an Original title.
- When dubbed from a DVD to the HDD, the picture size and the sound types originally recorded are retained.

⚡ Notes

- To play a dubbed disc on other DVD equipment, finalize the disc (page 39).
- The recorder may not function as described depending on the disc status. Follow the instructions that appear on the screen.
- You cannot dub from DVD VIDEOS to the HDD.
- Thumbnails that you have set for the originally recorded title (page 34) will not be retained in the dubbed title.

About “Dub Mode”

With this recorder, the recording mode for dubbing is displayed as “Dub Mode.” Two dubbing method are available: High-speed Dubbing and Rec Mode Conversion Dubbing. Read the following and select according to the required time, disc space, and picture quality.

Dubbing at high-speed (High-speed Dubbing)

HDD → **+RW** / **-RW/VR** / **-RW_{Video}** / **+R** / **-R**

Allows you to dub what you have stored in the HDD to a high-speed DVD (8x-speed DVD+RWs/6x-speed DVD-RWs/16x-speed DVD+Rs/16x-speed DVD-Rs, or slower versions of each disc type), without changing the recording mode.

Set “Dub Mode” to “Fast” in “Title Dub” or “Dub Selected Titles” display (page 74). You cannot select “Fast” when titles that cannot be dubbed at high speed are selected (such as the titles displayed in “Notes” below). The minimum required time is as follows (approximate).

Required times for High-speed Dubbing from HDD to DVD (for 60-minute programme)*1

Speed*2	6x	6x*3	8x*4	8x*4	2.4x
Rec. mode	High-speed DVD-RW	High-speed DVD+RW	High-speed DVD-R	High-speed DVD+R	DVD+R (Double Layer)
HQ	10 min.	10 min.	8 min.	8 min.	25 min.
HSP	6 min. 40 sec.	6 min. 40 sec.	5 min.	5 min.	16 min. 40 sec.
SP	5 min.	5 min.	3 min. 45 sec.	3 min. 45 sec.	12 min. 30 sec.
LSP	4 min.	4 min.	3 min.	3 min.	10 min.
LP	3 min. 20 sec.	3 min. 20 sec.	2 min. 30 sec.	2 min. 30 sec.	8 min. 20 sec.
EP	2 min. 30 sec.	2 min. 30 sec.	2 min.	2 min.	6 min. 15 sec.
SLP	1 min. 40 sec.	60 min.*5	1 min. 15 sec.	60 min.*5	60 min.*5
SEP	1 min. 15 sec.	60 min.*5	56 sec.	60 min.*5	60 min.*5

*1 The values in the above table are for reference only. Actual times for dubbing also require time for creating disc's control information and other data.

*2 This is the maximum recording speed of this recorder. The value may vary depending on the disc condition. Also, this recorder may be unable to record at the maximum speed for discs that support recording speeds exceeding the maximum value.

*3 The maximum drive speed of this recorder is 6x when using 6x-speed or faster DVD+RWs.

*4 The maximum drive speed of this recorder is 8x when using 8x-speed or faster DVD+Rs/DVD-Rs.

*5 High-speed dubbing is not available when dubbing titles recorded in SLP and SEP mode to DVD+RWs and DVD+Rs.

Notes

- High-speed Dubbing is not available for the following titles:
 - Titles recorded in HQ+.
 - Titles that contain both main and sub sounds (except DVD-RWs (VR mode)).
 - Titles recorded in mixed picture size (4:3 and 16:9 etc.), (except DVD-RWs (VR mode)).
- When dubbed to a DVD-RW (Video mode)/DVD+RW/DVD+R/DVD-R, remnants of edited titles may remain on the disc. If you edit a title, use the Rec Mode Conversion Dubbing method. This will smooth out the pauses between the scenes.
- When playing a dubbed DVD+R DL disc, the video and audio may be momentarily interrupted at the point where the layers switch.

Rec Mode Conversion Dubbing



Allows you to dub from the HDD to a DVD or vice versa, in a dubbing mode that differs from the original recordings. For example, when you dub an HQ title (data size is large) in SP mode, you can reduce the data size, saving more titles using less space.

Select a mode different from the original recording in "Dub Mode" in the steps of "Dubbing a single title (Title Dub)" on page 74 or "Dubbing multiple titles (Dub Selected Titles)" on page 75.

When a title recorded to HDD in HQ or HQ+ mode is converted to another mode, the recorder automatically assigns an appropriate bit rate, thus retaining the original picture quality as much as possible.

Note

The picture quality will not improve even if a title is converted to a recording mode of better picture quality.

Dubbing restriction

You cannot dub movies and other DVD Videos to the HDD. Also, when dubbing from a DVD to the HDD, a gray, blank screen will be recorded for scenes that contain a copy protection signal.

Copy protection signals Dubbing

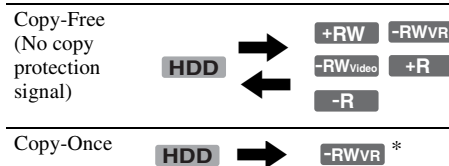

* CPRM-compatible DVD-RWs (VR mode) only
CPRM (Content Protection for Recordable Media) is a coding technology that protects copyrights for images.

Dubbing (HDD ↔ DVD)

Move

HDD → **-RWVR**

Titles containing “Copy-Once” copy protection signals can be moved only from HDD to DVD-RW (VR mode)* (after the title is moved, the original title in the HDD is erased). The “Move” function is performed using the same procedure as dubbing (page 74). Titles containing “Copy-Once” copy protection signals are indicated with **COPY**.

Notes

- The following titles in the HDD cannot be moved.
 - Protected titles
 - Playlist titles
 - Original titles referenced from the playlist
- If the move operation is stopped before completion, the title in the HDD is not erased.

* CPRM-compatible DVD-RWs (VR mode) only.

Dubbing

HDD **+RW** **-RWVR** **-RWVideo** **+R** **-R**

Dubbing a single title (Title Dub)

- 1 Insert the DVD that you are going to dub to or from.**
- 2 Press HDD or DVD to select the source.**
- 3 Press TITLE LIST to turn on the Title List menu.**
- 4 Select a title, and press ENTER.**
The sub-menu appears.
- 5 Select “Dubbing,” and press ENTER.**
The display for selecting the dubbing mode appears.
If a title with **COPY** (page 74) is selected in the title list, a confirmation screen is displayed. To “Move,” select “Yes.”

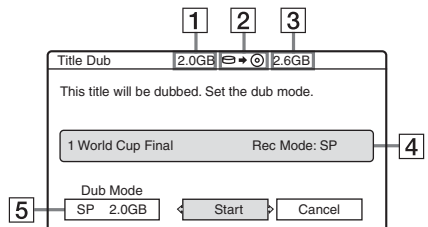

- 1** Size of the title (approximate)
 - 2** Direction of dubbing
 - 3** Available space on the disc to be dubbed (approximate)
 - 4** Information about the title to be dubbed
 - 5** Dubbing mode and the space that remains after dubbing (approximate)
- 6 Select “Dub Mode.”**

7 Select a dubbing mode by pressing \uparrow/\downarrow .

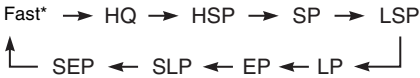

* Appears when High-speed Dubbing is available for the title (page 72).

8 Select "Start," and press ENTER.

The dubbing indication appears in the front panel display (page 35).

To automatically adjust the dubbing mode (Auto Dub Mode)

If there is not enough available space on the target disc, the recorder automatically selects a dubbing mode with lower picture quality according to the available space. If there is insufficient disc space in the selected dubbing mode, the following display appears after step 8.

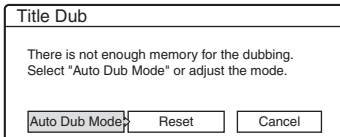

Select "Auto Dub Mode" and press ENTER to start dubbing. To manually select another dubbing mode, select "Reset," and go to step 7.

To stop dubbing

Press TOOLS to select "Stop Dubbing," and press ENTER. When asked for confirmation, select "Yes," and press ENTER.

Hints

- If disc space is still insufficient for the selected dubbing mode, erase unnecessary parts of the title, or free up disc space by erasing titles on the disc (page 69).
- You can turn off the recorder during dubbing. The recorder completes dubbing even after being turned off.

Dubbing multiple titles (Dub Selected Titles)

A maximum of 30 selected titles can be dubbed at once. You can select the dubbing mode for each title.

- 1 Insert the DVD that you are going to dub to or from.
- 2 Press HDD or DVD to select the source.
- 3 Press TITLE LIST to turn on the Title List menu.
- 4 Press TOOLS to select "Dub Selected Titles," and press ENTER.

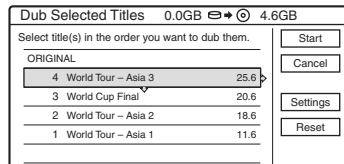

- 5 Select titles in the order you want to dub, and press ENTER.

The titles are numbered in the selected order. To cancel the selection, press ENTER again. If a title with  (page 74) is selected in the title list, a confirmation screen is displayed. To "Move," select "Yes."

- 6 Repeat step 5 to select all of the titles you want to dub.

To make adjustments for each of the titles, select "Settings" (see "To adjust the settings for each title" below). To cancel all of the selections, select "Reset," and go to step 5.

- 7 Select "Start," and press ENTER.

The dubbing indication appears in the front panel display (page 35).

To adjust the settings for each title

You can make detailed settings for each of the selected titles during Multiple Title Dubbing.

- 1 In step 6 of “Dubbing multiple titles (Dub Selected Titles)” on page 75, select “Settings” and press ENTER.
The following display for making the adjustments appears.
To re-select titles, select “Change,” and go to step 5 of “Dubbing multiple titles (Dub Selected Titles)” above. To have the recorder adjust the dubbing mode so all of the selected titles fit in, select “Auto mode.”

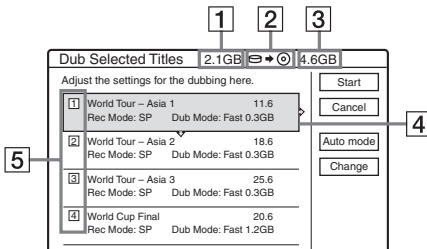

- 1 Total size of the selected titles
- 2 Direction of dubbing
- 3 Available space on the disc to be dubbed (approximate)
- 4 Information about the title to be dubbed (title name, original recording mode, dubbing mode, and data size after dubbing)
- 5 Order of dubbing

- 2 Select the title which you want to adjust, and press ENTER.

The sub-menu appears.

“Dub Mode”: Selects the dubbing mode for each title (page 72).

“Change Order”: Moves the title to change the dubbing order. Press **↑/↓** to select a new location, and press ENTER.

“Cancel”: Cancels the title selection. The title is excluded from dubbing.

- 3 Select an option, and press ENTER.
- 4 When you finish making adjustments, select “Start,” and press ENTER.

To automatically adjust the dubbing mode (Auto Dub Mode)

If there is not enough available space on the target disc, the recorder automatically selects a dubbing mode with lower picture quality according to the available space. The same dubbing mode is set for all of the titles. If disc space is insufficient for the selected dubbing mode, the following display appears after step 7 of “Dubbing multiple titles (Dub Selected Titles)” on page 75.

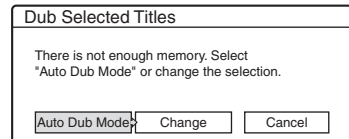

Select “Auto Dub Mode” and press ENTER. If you have selected only one title, select “OK.”

To stop dubbing

Press TOOLS to select “Stop Dubbing,” and press ENTER. When asked for confirmation, select “Yes,” and press ENTER.

🔧 Hints

- You can turn off the recorder during dubbing. The recorder completes dubbing even after being turned off.
- You can start Multiple Title Dubbing by selecting “DUBBING” from the System Menu.

DV Dubbing (RDR-HX710/HX910 only)

Before DV Dubbing

This section explains dubbing with a digital video camera via the DV IN jack on the front panel. If you want to dub by way of the LINE IN jacks, see “Recording from connected equipment without a timer” on page 52.

To record from the DV IN jack

The DV IN jack on this recorder conforms to the i.LINK standard. You can connect any other equipment that has an i.LINK (DV) jack, and record digital signals.

Follow the instructions in “Preparing for DV dubbing,” and then move on to the section on dubbing. For more information about i.LINK, see “About i.LINK (RDR-HX710/HX910 only)” on page 105.

Hint

If you plan to do additional editing on a disc after the initial dub, use the DV IN jack and record on a DVD-RW (VR mode) or HDD.

Preparing for DV dubbing

You can connect a digital video camera to the DV IN jack on the recorder to record or edit from a DV/Digital 8 format tape. Operation is straightforward because the recorder will fast forward and rewind the tape for you – you do not need to operate your digital video camera. Do the following to start using the “DV Edit” functions of this recorder.

See the instruction manual supplied with the digital video camera as well before connecting.

Notes

- The DV IN jack is for input only. It will not output signals.
- You cannot use the DV IN jack when:
 - your digital video camera does not work with this recorder. Connect the camera to the LINE IN jack and follow the instructions of “Recording from connected equipment without a timer” on page 52.
 - the input signal is not in DVC-SD format. Do not connect a MICRO MV format digital video camera even if it has an i.LINK jack.
 - the images on the tape contain copy protection signals, which limit recording.
- If you want to play the disc on other DVD equipment, finalize the disc (page 39).

Hookups

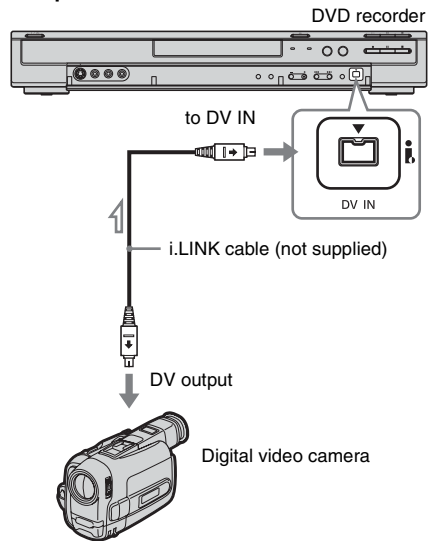

 : Signal flow

1 Press HDD or DVD to select the recording destination.

If you select DVD, insert a disc (see “Inserting a Disc” on page 29).

2 Insert the source DV/Digital 8 format tape into your digital video camera.

For the recorder to record or edit, your digital video camera must be set to video playback mode.

3 Press INPUT SELECT on the remote repeatedly to select “DV.”

The front panel display changes as follows:

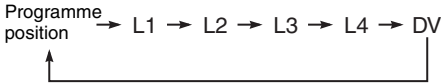

4 Press REC MODE on the remote repeatedly to select the recording mode.

The recording mode changes as follows:

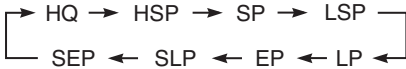

For details about the recording mode, see page 41.

5 Press TOOLS on the remote to select “DV Audio Input,” and press ENTER. Then, select the setting for the audio input.

“Stereo1” (default): Records original sound only. Normally select this when dubbing a DV format tape.

“Mix”: Records both stereo 1 and 2.

“Stereo2”: Records additional audio only.

Select “Mix” or “Stereo2” only if you have added a second audio channel when recording with your digital video camera.

You are ready to start dubbing. Select one of the dubbing methods on the following pages.

Notes

- You cannot connect more than one piece of digital video equipment to the recorder.
- You cannot control the recorder using another device or another recorder of the same model.
- You cannot record date, time, or the contents of the cassette memory onto the disc.
- If you record from a DV/Digital 8 format tape that is recorded in multiple sound tracks, such as a tape with multiple sampling frequencies (48 kHz, 44.1 kHz, or 32 kHz), no sound or an unnatural sound will be output when playing back the sampling frequency switch point on the disc.
- In order to use this recorder’s “Auto Chapter” setting (page 79), be sure to correctly set the clock on your digital video camera before shooting.
- The recorded picture may be momentarily affected if the picture size of the source image changes, or if there is nothing recorded on the tape.

Hints

- You can turn off the recorder during dubbing. The recorder completes dubbing even after being turned off.
- You can adjust the settings for the recording picture before recording. See “Adjusting the recording picture quality and size” on page 47.

Recording an Entire DV Format Tape (One Touch Dubbing)

HDD +RW -RWVR -RWVideo +R -R

You can record the entire contents of a DV/Digital 8 format tape onto a disc with a single press of the ONE-TOUCH DUB button on the recorder. The recorder controls the digital video camera for the whole process, and completes the recording.

◆ How chapters are created

The contents dubbed to the HDD or DVD become a single title. When “Auto Chapter” of “Features” setup is set to “On,” this title is divided into chapters. When dubbing to the HDD or a DVD-RW (VR mode), each shooting session on the tape becomes a chapter on the disc. For other discs, the recorder divides the title into chapters at approximately 6-minute intervals.

Follow steps 1 to 5 of “Preparing for DV dubbing” on page 77, and press ONE-TOUCH DUB on the recorder.

The recorder rewinds the tape and then starts recording the tape contents. When the recording is finished, the recorder rewinds the tape in the digital video camera.

To stop during recording

Open the remote’s cover and press ■ REC STOP. Note that it may take a few seconds for the recorder to stop recording.

💡 Hints

- If you set “Finalize Disc” of “One Touch Dubbing” to “Auto” in “Features” setup (page 93), the recorded disc (except DVD-RW (VR mode)) will automatically be finalized after recording is finished.
- You can play back a previously recorded title on the HDD while One Touch Dubbing is in progress.

🔊 Notes

- When a blank space between the recordings on the tape continues for more than five minutes, One Touch Dubbing ends automatically.
- The recorder records a blank for five minutes before it stops dubbing. To stop the blank recording, press ■ REC STOP.

Program Edit

HDD +RW -RWVR -RWVideo +R -R

You can select scenes from a DV/Digital 8 format tape, and then automatically record selected scenes to the HDD or a DVD.

To use this function, you will do the following:

Connect your digital video camera and prepare for recording



Select and edit the scenes you want to dub

Using the recorder’s remote control, fast forward or rewind the tape to select the scenes. At this point, the selected scenes are not copied to the disc. The recorder only remembers the IN and OUT points of the scenes that you selected for dubbing. You can also reset, erase, or change the order of the scenes.



Dub the selected scenes

After you have selected the scenes, the recorder will fast forward and rewind the tape automatically and record the scenes to the HDD or a DVD.

◆ How chapters are created

The contents dubbed to the HDD or DVD become a single title. When “Auto Chapter” of “Features” setup is set to “On,” this title is divided into chapters. When dubbing to the HDD or a DVD-RW (VR mode), each shooting session on the tape becomes a chapter on the disc. For other discs, the recorder divides the title into chapters at approximately 6-minute intervals.

1 Follow steps 1 to 5 of “Preparing for DV dubbing” on page 77, and press SYSTEM MENU.

2 Select “DV EDIT,” and press ENTER.

The display asks if you want to start selecting scenes.

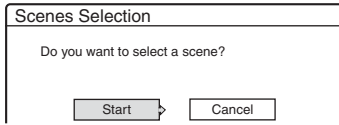

- If you have previously saved a programme, the display asks if you want to edit an existing programme or to create a new programme. To resume editing the existing programme, select “Saved Data,” and go to step 6.

3 Select “Start,” and press ENTER.

The display for setting the IN point (start of the scene) appears.

The scene starts to play in the background.

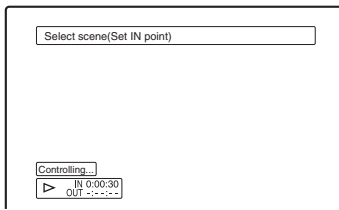

4 Select the IN point by pressing ◀▶, and press ENTER.

The display for setting the OUT point (end of the scene) appears. The scene starts to play in the background from the IN point.

5 Select the OUT point by pressing ◀▶, and press ENTER.

The display asks if you want to add the selected scene to the Scene List menu.

To preview the scene, select “Preview.”

To reset either the IN or OUT point, select “Change IN” or “Change OUT,” and repeat from step 4.

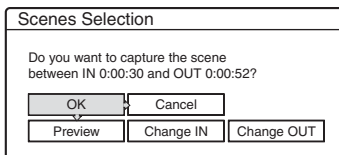

6 Select “OK,” and press ENTER.

A new Scene List menu appears with the selected scene.

To add a scene, select “Add.”

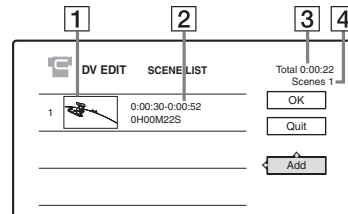

1 Thumbnail picture

2 Time information

3 Total duration of the program

4 Total number of scenes

7 When you finish adding scenes, select the scene you want to edit, and press ENTER.

The sub-menu appears.

“Move”: Changes the scene order. Follow the explanations on the screen to change the order by pressing \uparrow/\downarrow and ENTER.

“Erase”: Erases the scene. When asked for confirmation, select “OK.”

“Preview”: Plays the selected scene.

“Change IN”: Changes the start of the scene.

Repeat from step 4.

“Change OUT”: Changes the end of the scene. Repeat from step 5.

8 When you finish editing the Scene List, select “OK,” and press ENTER.

The display for entering the title name appears.

To enter a new name, select “Enter,” and follow the explanations on page 36.

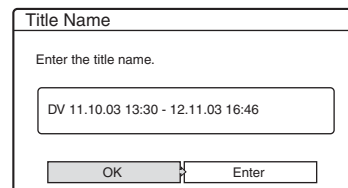

9 Select “OK,” and press ENTER.

The default title name is fixed, and the display asks if you want to start recording.

To change the disc media, select “Media” and press \uparrow/\downarrow . To change the dubbing mode, select “Dub Mode” and press \uparrow/\downarrow .

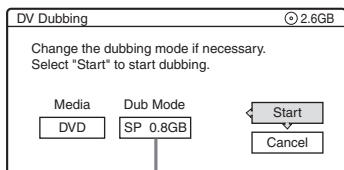

Data capacity required for the dubbing.

10 Select “Start,” and press ENTER.

The recorder starts recording the tape contents as programmed.

- If the recording does not fit due to the dubbing mode you selected, the display asks if you want to continue.

To change the dubbing mode, select “Reset” and repeat from step 9.

To have the recorder adjust the dubbing mode, select “Auto Dub Mode.”

- If there is not enough disc space even after changing the dubbing mode, the display asks if you want to record halfway. To continue, select “OK.”

To stop during recording

Open the remote’s cover and press \blacksquare REC STOP. Note that it may take a few seconds for the recorder to stop recording.

Notes

- Contents recorded to the HDD or a DVD may not be recorded as programmed if the tape’s time code is not sequential or there are blanks between the recordings on the tape. In this case, see “Recording from connected equipment without a timer” on page 52.
- The start and end points of a programme may be different from what you have set if the source DV/Digital 8 format tape is in any of the following conditions:
 - Recording mode was changed during the recording.
 - There is a blank space in the recorded portion of the tape.
- If you set the beginning of the tape as the IN point and the end point as the OUT point, the IN and OUT points may move slightly during dubbing.
- You cannot set a scene to be shorter than one second.

Settings and Adjustments

Aerial Reception and Language Settings (Settings)

The “Settings” setup helps you to make tuner, clock, and programme position settings for the recorder.

1 Press **SYSTEM MENU** while the recorder is in stop mode.

2 Select “**SETUP**,” and press **ENTER**.

3 Select “**Settings**,” and press **ENTER**.

The options of “Settings” appear. The default settings are underlined.

To turn off the display, press **SYSTEM MENU** repeatedly.

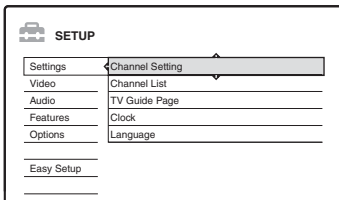

Channel Setting

Presets programme positions manually.

If some programme positions could not be set using the “Easy Setup” function, you can set them manually.

If there is no sound or if the picture is distorted, the wrong tuner system may have been preset during “Easy Setup.” Set the correct tuner system manually in the steps below.

1 Select “**Channel Setting**” in “**Settings**,” and press **ENTER**.

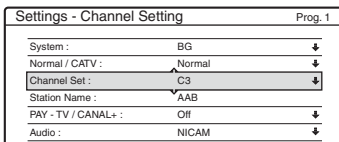

2 Press **PROG +/-** to select the programme position.

Selected programme position

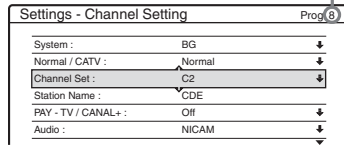

3 Select “**System**,” and press **ENTER**.

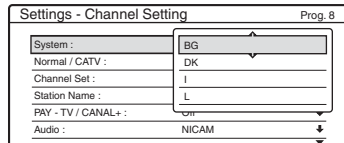

4 Select an available TV system, BG, DK, I, or L, and press **ENTER** (page 83).

BG	Select this when in West European countries, except those listed in “Receivable channels” on page 83.
DK	Select this when in East European countries.
I	Select this when in Great Britain/Ireland.
L	Select this when in France.

5 Select “**Normal/CATV**,” and press **ENTER**.

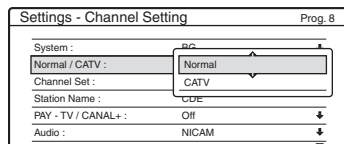

6 Select “**Normal**,” and press **ENTER**. To set **CATV** (Cable Television) channels, select “**CATV**.”

7 Select “**Channel Set**,” and press **ENTER**.

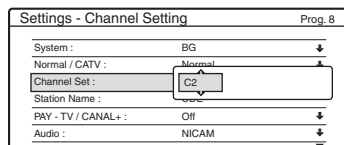

8 Press **↑/↓** repeatedly until the channel you want is displayed, then press **ENTER**. The channels are scanned in the order shown in the table below.

- If you know the number of the channel you want, press the number buttons. For example, for channel 5, first press “0” and then press “5.” Then press **ENTER**.

9 Select “Audio,” and press **ENTER**.

Settings - Channel Setting		Prog. 8
System :	BG	↓
Normal / CATV :	Normal	↓
Channel Set :	C5	↓
Station Name :	CDE	
PAY - TV / CANAL+ :	NICAM	
Audio :	Standard	

NICAM	Normally, select this.
Standard	Select this if the sound from NICAM broadcasts is not clear.

10 Select “NICAM,” and press **ENTER**.

11 Select “AFT” and press **ENTER**.

Settings - Channel Setting		Prog. 8
Normal / CATV :	Normal	↑
Channel Set :	C5	↓
Station Name :	CDE	
PAY - TV / CANAL+ :	Off	
Audio :	On	
AFT :	Off	

On	Turns on the Auto Fine Tuning function. Normally, select this.
Off	Allows you to adjust the pictures manually.

12 Select “On” to turn on AFT, and press **ENTER**.

- If the Auto Fine Tuning function does not work effectively, select “Off” and press **ENTER**. When the fine tuning bar appears, press **←/→** to obtain a clearer picture, and press **ENTER**.
- To preset another channel, repeat from step 2.

◆ Receivable channels

TV system	Channel coverage
BG (West European Countries, except those listed below)	E2 - E12 VHF
	Italia A - H VHF
	E21 - E69 UHF
	S1 - S20 CATV
	S21 - S41 HYPER
S01 - S05 CATV	
DK (East European Countries)	R1 - R12 VHF
	R21 - R69 UHF
	S1 - S20 CATV
	S21 - S41 HYPER
	S01 - S05 CATV
I (Great Britain/Ireland)	Ireland A - J VHF
	South Africa 4 - 13 VHF
	B21 - B69 UHF
	S1 - S20 CATV
	S21 - S41 HYPER
S01 - S05 CATV	
L (France)	F2 - F10 VHF
	F21 - F69 UHF
	B - Q CATV
	S21 - S41 HYPER

◆ Tuning the French CATV channels

This recorder can scan the CATV channels B to Q and the HYPER frequency channels S21 to S41. On the Channel Set menu, the channels are indicated as S1 to S44. For example, channel B is indicated by Channel Set number S1, and channel Q is indicated by Channel Set number S23 (see the table below). If the CATV channel you want to preset is indicated by its frequency (for example, 152.75 MHz), refer to the table below to find the corresponding channel number.

Corresponding channel	Channel Set number	Receivable Frequency range (MHz)
B	S1	116.75-124.75
C	S2	124.75-132.75
D	S3	132.75-140.75
D	S4	140.75-148.75
E	S5	148.75-156.75

Corresponding channel	Channel Set number	Receivable Frequency range (MHz)
F	S6	156.75–164.75
F	S7	164.75–172.75
G	S8	172.75–180.75
H	S9	180.75–188.75
H	S10	188.75–196.75
I	S11	196.75–204.75
J	S12	204.75–212.75
J	S13	212.75–220.75
K	S14	220.75–228.75
L	S15	228.75–236.75
L	S16	236.75–244.75
M	S17	244.75–252.75
N	S18	252.75–260.75
N	S19	260.75–268.75
O	S20	268.75–276.75
P	S21	276.75–284.75
P	S22	284.75–292.75
Q	S23	292.75–300.75
S21	S24	299.25–307.25
S22	S25	307.25–315.25
S23	S26	315.25–323.25
S24	S27	323.25–331.25
S25	S28	331.25–339.25
S26	S29	339.25–347.25
S27	S30	347.25–355.25
S28	S31	355.25–363.25
S29	S32	363.25–371.25
S30	S33	371.25–379.25
S31	S34	379.25–387.25
S32	S35	387.25–395.25
S33	S36	395.25–403.25
S34	S37	403.25–411.25
S35	S38	411.25–419.25
S36	S39	419.25–427.25
S37	S40	427.25–435.25
S38	S41	435.25–443.25

Corresponding channel	Channel Set number	Receivable Frequency range (MHz)
S39	S42	443.25–451.25
S40	S43	451.25–459.25
S41	S44	459.25–467.25

Station Name

Changes or enters a new station name (up to 5 characters). The recorder must receive channel information (for instance, SMARTLINK information) for station names to appear automatically.

- 1 Select “Channel Setting” in “Settings,” and press ENTER.

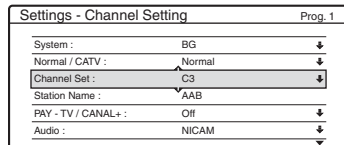

- 2 Press PROG +/- to select the programme position for which you want to change or enter a station name.
- 3 Select “Station Name,” and press ENTER. The display for entering characters appears.

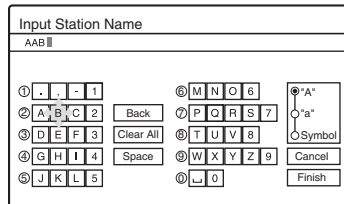

To enter characters, see page 36.

- 4 Select “Finish,” and press ENTER.

PAY-TV/CANAL+

Sets the PAY-TV/Canal Plus channels. For details, see page 27.

Channel List (Changing/Disabling the channels)

Changes or disables the programme positions after setting the channels. If any programme positions are unused or contain unwanted channels, you can disable them.

You can also change station names. If the station names are not displayed, you can enter them manually.

- 1 Select "Channel List" in "Settings," and press ENTER.

Settings - Channel List		
Prog	Channel	Name
1	C3	AAB
2	C5	FGH
3	C12	
4	C21	
5	C23	
6	C24	PQR

- 2 Press \uparrow/\downarrow to select the row containing the programme position you want to change or disable.
To change, press ENTER and go to step 3.
To disable, press CLEAR and go to step 5.
The disabled positions will be skipped when you press PROG +/-.

To display other pages for programme positions 7 to 99, press \uparrow/\downarrow repeatedly.

- 3 Press \uparrow/\downarrow until the selected channel row moves to the desired programme position. The selected channel is inserted at the new programme position.

Settings - Channel List		
Prog	Channel	Name
1	C3	AAB
2	C12	
3	C21	
4	C5	FGH
5	C23	
6	C24	PQR

- 4 Press ENTER to confirm the setting.
- 5 To change or disable the programme position of another station, repeat from step 2.

Note

Be sure to correctly select the programme position you want to disable. If you disable the wrong programme position by mistake, you need to reset that channel manually.

TV Guide Page

Some broadcast systems ensure a Teletext service* in which the complete programmes and their data (title, date, channel, recording start time, etc.) are stored day by day. A TV guide page corresponds to each day of the week. When recording a programme, the recorder automatically takes the programme name from the Teletext pages and stores it as the title name. The TV guide page numbers depend entirely on the broadcast itself and may be subject to change. If so, you may have to set those TV guide page numbers manually in the TV Guide Page menu.

* Not available in some areas.

- 1 Select "TV Guide Page" in "Settings," and press \rightarrow or ENTER.
The TV Guide Page menu appears.
- 2 Select the programme position for which you want to set or change the TV guide page by pressing PROG +/-.

- The TV guide page numbers (Example: P301) appear automatically when the recorder detects them.

Settings - TV Guide Page		Prog. 4
Sun	P 301	\downarrow
Mon	P 302	\downarrow
Tue	P 303	\downarrow
Wed	P 304	\downarrow
Thu	P 305	\downarrow
Fri	P 306	\downarrow
Sat	P 307	\downarrow

- If no page numbers are detected (P000), you have to set the appropriate TV guide page number manually.

Settings - TV Guide Page		Prog. 4
Sun	P 000	\downarrow
Mon	P 000	\downarrow
Tue	P 000	\downarrow
Wed	P 000	\downarrow
Thu	P 000	\downarrow
Fri	P 000	\downarrow
Sat	P 000	\downarrow

- 3 Select the TV guide page number you want to modify, and press ENTER.

Settings - TV Guide Page		Prog. 4
Sun	P 000	\downarrow
Mon	P 000	\downarrow
Tue	P 000	\downarrow
Wed	P 000	\downarrow
Thu	P 000	\downarrow
Fri	P 000	\downarrow
Sat	P 000	\downarrow

- 4 Press the number buttons or $\leftarrow/\uparrow/\downarrow/\rightarrow$ to enter the TV guide page number, and press ENTER to confirm the setting.
- If you make a mistake, press CLEAR to re-enter the correct number.

To set or change another TV guide page number, repeat steps 3 and 4 above.

Hint

To view Teletext information on your TV screen during a broadcast, switch to your TV's tuner by pressing TV/VIDEO .

Notes

- In step 4 above, enter "000" if you do not want to use the TV guide page number for automatic labelling. The recorder will instead store a default title name (programme position, start time - stop time).
- Refer to the Teletext information on your TV screen to obtain the TV guide page number with programme titles and their start times.
- If the Teletext TV guide has a page which always shows the programmes for the current day, this page should be input for all days.
- If you start recording more than three minutes before the programme is scheduled to start, the correct label information may not be transferred.
- Note that this function may not work correctly with programmes broadcast from some stations.
- If the broadcast system updates the Teletext information at the moment recording starts, the title label may not correspond to the recorded programme. In this case, you may have to manually enter the correct title (page 36).

Clock

Auto Adjust

Turns on the Auto Clock Set function when a channel in your local area broadcasts a time signal.

- 1 Select "Clock" in "Settings," and press ENTER.
- 2 Select "Auto Adjust," and press ENTER.

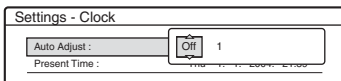

- 3 Select "On," and press \rightarrow .

- 4 Press \uparrow/\downarrow repeatedly until the programme position of the station that carries a time signal appears, and press ENTER.

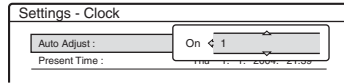

- If the recorder does not receive a time signal from any station, "Auto Adjust" returns to "Off" automatically and the menu for setting the clock manually appears on the screen.

Hint

If you set "Auto Adjust" to "On," the Auto Clock Set function is activated whenever the recorder is turned off.

Note

The Auto Clock Set function does not work while the recorder is standing by for Synchro-Recording.

◆ To set the clock manually

If the Auto Clock Set function did not set the clock correctly for your local area, try another station for the Auto Clock Set function or set the clock manually.

- 1 Select "Clock" in "Settings," and press ENTER.
- 2 Select "Auto Adjust," and press ENTER.

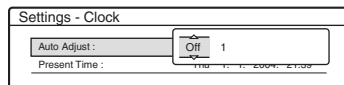

- 3 Select "Off," and press ENTER.
- 4 Select "Present Time," and press ENTER.

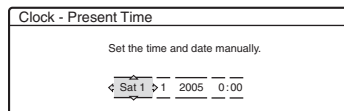

- 5 Press \uparrow/\downarrow to set the day, and press \rightarrow . Set the month, year, hour, and minutes in sequence. Press \leftarrow/\rightarrow to select the item to be set, then press \uparrow/\downarrow to set the numbers. The day of the week is set automatically.

To change the numbers, press \leftarrow to return to the item to be changed, and press \uparrow/\downarrow .

- 6 Press ENTER to start the clock.

Language

OSD (On-Screen Display)

Switches the display language on the screen.

DVD Menu (DVD VIDEO only)

Switches the language for the DVD menu.

Audio (DVD VIDEO only)

Switches the language of the sound track.

When you select "Original," the language given priority in the disc is selected.

Subtitle (DVD VIDEO only)

Switches the language of the subtitles recorded on the disc.

When you select "Audio Follow," the subtitle language changes according to the language you selected for the sound track.

Hint

If you select "Others" in "DVD Menu," "Subtitle," or "Audio," select and enter a language code from "Language Code List" on page 112 using the number buttons.

Note

If you select a language in "DVD Menu," "Subtitle," or "Audio" that is not recorded on the DVD VIDEO, one of the recorded languages will be automatically selected.

Video Settings (Video)

Video settings will adjust items related to the image, such as size and colour.

Choose the settings according to the type of TV, tuner, or decoder connected to the DVD recorder.

1 Press **SYSTEM MENU** while the recorder is in stop mode.

2 Select "**SETUP**," and press **ENTER**.

3 Select "**Video**," and press **ENTER**.

The "Video" setup appears with the following options. The default settings are underlined.

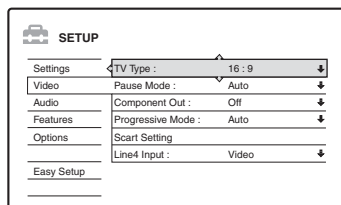

TV Type

Sets the picture size when playing back a title recorded from 16:9 size video (page 47) or a 16:9 size commercial DVD video.

Select the playback picture size according to the type of connected TV (wide-screen/wide mode TV or conventional 4:3 screen TV).

<u>16:9</u>	Select this when connecting to a wide-screen TV or TV with a wide mode function.
4:3 Letter Box	Select this when connecting to a 4:3 screen TV. Displays a wide picture with bands on the upper and lower portions of the screen.
4:3 Pan Scan	Select this when connecting to a 4:3 screen TV. Automatically displays a wide picture on the entire screen and cuts off the portions that do not fit.

16:9



4:3 Letter Box



4:3 Pan Scan

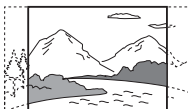

Note

Depending on the disc, “4:3 Letter Box” may be selected automatically instead of “4:3 Pan Scan” or vice versa.

Pause Mode (HDD/DVDs only)

Selects the picture quality in pause mode.

<u>Auto</u>	The picture, including subjects that move dynamically, is output with no jitter. Normally select this position.
Frame	The picture, including subjects that do not move dynamically, is output in high resolution.

Component Out

Selects whether or not to output video signals from the COMPONENT VIDEO OUT jacks.

On	Outputs the component video signals. Select this when you want to view progressive signals.
<u>Off</u>	Outputs no signals.

Notes

- When you set “Line1 Output” to “RGB,” you cannot set “Component Out” to “On.”
- When you connect the recorder to a monitor or projector via only the COMPONENT VIDEO OUT jacks, do not select “Off.” If you select “Off” in this case, the picture may not appear.

Progressive Mode

DVD software can be divided into two types: film based software and video based software. Video based software is derived from TV, such as dramas and sit-coms, and displays images at 30 frames/60 fields (25 frames/50 fields) per second. Film based software is derived from film and displays images at 24 frames per second. Some DVD software contains both Video and Film.

In order for these images to appear natural on your screen when output in PROGRESSIVE mode (50 or 60 frames per second), the progressive video signal needs to be converted to match the type of DVD software that you are watching.

You can fine-tune the progressive 525p/625p video signal that is output when you press PROGRESSIVE (“PROGRESSIVE” lights up). Note that you must connect to a progressive format TV using the COMPONENT VIDEO OUT jacks (page 14).

<u>Auto</u>	Automatically detects the software type (Film-based or Video-based) and selects the appropriate conversion mode. Normally select this position.
Video	Fixes the conversion mode to the mode for Video-based software.

Scart Setting

Sets the method of inputting/outputting signals from the SCART jacks on the rear panel of the recorder. Select an option for each of the items below according to the combination of jacks and methods that you are going to use.

Line1 Output

Selects a method of outputting video signals for the LINE 1 – TV jack.

RGB	Outputs RGB signals.
<u>Video</u>	Outputs video signals.
S Video	Outputs S-video signals.

Notes

- If your TV does not accept S-video or RGB signals, no picture appears on the TV screen even if you select “S Video” or “RGB.” See the instructions supplied with your TV.
- You cannot select “RGB” when “Component Out” above is set to “On.”
- SMARTLINK is available only when “Video” is selected.

◆ Line3 Input

Selects a method of inputting video signals for the LINE 3/DECODER jack. The picture will not be clear if this setting does not match the type of video input signal.

<u>Video/RGB</u>	Inputs video signals or RGB signals.
Decoder	Select this when connecting to a PAY-TV/Canal Plus decoder.
S Video	Inputs S-video signals.

◆ Line3 Output

Selects a method of outputting video signals for the LINE 3/DECODER jack.

<u>Video</u>	Outputs video signals.
S Video	Outputs S-video signals.

Line4 Input

Selects a method of inputting video signals for the LINE 4 IN jack on the rear panel of the recorder.

<u>Video</u>	Inputs video signals.
S Video	Inputs S-video signals.

Audio Settings (Audio)

The “Audio” setup allows you to adjust the sound according to the playback and connection conditions.

1 Press **SYSTEM MENU** while the recorder is in stop mode.

2 Select **“SETUP,”** and press **ENTER**.

3 Select **“Audio,”** and press **ENTER**.

The “Audio” setup appears with the following options. The default settings are underlined.

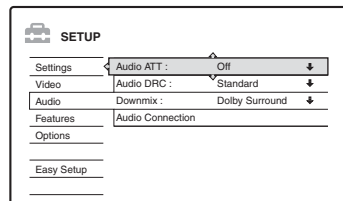

Audio ATT (attenuation)

If the playback sound is distorted, set this item to “On.” The recorder reduces the audio output level. This function affects the output of the following jacks:

- LINE 2 OUT R-AUDIO-L jacks
- LINE 1 – TV jack
- LINE 3/DECODER jack

<u>On</u>	Select this when the playback sound from the speakers is distorted.
<u>Off</u>	Normally select this position.

Audio DRC (Dynamic Range Control) (DVDs only)

Makes the sound clear when the volume is turned down when playing a DVD that conforms to "Audio DRC." This affects the output from the following jacks:

- LINE 2 OUT R-AUDIO-L jacks
- LINE 1 - TV jack
- LINE 3/DECODER jack
- DIGITAL OUT (OPTICAL or COAXIAL) jack only when "Dolby Digital" is set to "D-PCM" (page 90).

<u>Standard</u>	Normally select this position.
TV Mode	Makes low sounds clear even if you turn the volume down.
Wide Range	Gives you the feeling of being at a live performance.

Downmix (DVDs only)

Switches the method for mixing down to two channels when you play a DVD which has rear sound elements (channels) or is recorded in Dolby Digital format. For details on the rear signal components, see "4. Displaying the Playing Time and Play Information" on page 34. This function affects the output of the following jacks:

- LINE 2 OUT R-AUDIO-L jacks
- LINE 1 - TV jack
- LINE 3/DECODER jack
- DIGITAL OUT (OPTICAL or COAXIAL) jack when "Dolby Digital" is set to "D-PCM" (page 90).

<u>Dolby Surround</u>	Normally select this position. Multi-channel audio signals are output to two channels for enjoying surround sounds.
Normal	Multi-channel audio signals are downmixed to two channels for use with your stereo.

Audio Connection

The following setup items switch the method of outputting audio signals when you connect a component such as an amplifier (receiver) with a digital input jack.

For connection details, see "Step 4: Connecting the Audio Cords" on page 17. Select "Dolby Digital," "MPEG," "DTS," and "48kHz/96kHz PCM" after setting "Digital Out" to "On."

If you connect a component that does not accept the selected audio signal, a loud noise (or no sound) will come out from the speakers, and may affect your ears or cause speaker damage.

- 1 Select "Audio Connection" in "Audio," and press ENTER.

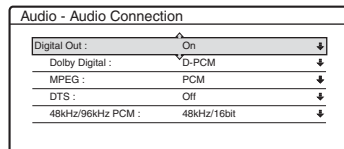

- 2 Select "Digital Out," and press ENTER.

<u>On</u>	Normally select this position.
Off	The influence of the digital circuit upon the analogue circuit is minimal.

- 3 Select "On," and press ENTER.

- 4 Set the digital output signal.

• Dolby Digital (HDD/DVDs only)

Selects the type of Dolby Digital signal.

<u>D-PCM</u>	Select this when the recorder is connected to an audio component lacking a built-in Dolby Digital decoder. The surround effects of output signals are determined by the "Downmix" setting item in "Audio" setup.
Dolby Digital	Select this when the recorder is connected to an audio component with a built-in Dolby Digital decoder.

- DTS (DVD VIDEO only)

Selects whether or not to output DTS signals.

<u>On</u>	Select this when the recorder is connected to an audio component with a built-in DTS decoder.
<u>Off</u>	Select this when the recorder is connected to an audio component without a built-in DTS decoder.

- MPEG (DVD VIDEO only)

Selects the type of MPEG audio signal.

<u>PCM</u>	Select this when the recorder is connected to an audio component without a built-in MPEG decoder. If you play MPEG audio sound tracks, the recorder outputs stereo signals via the DIGITAL OUT (COAXIAL or OPTICAL) jack.
<u>MPEG</u>	Select this when the recorder is connected to an audio component with a built-in MPEG decoder.

- 48kHz/96kHz PCM (DVD VIDEO only)

Selects the sampling frequency of the audio signal.

<u>48kHz/16bit</u>	The DVD video audio signal is converted to 48kHz/16bit and output.
<u>96kHz/24bit</u>	All signals containing 96kHz/24bit are output without conversion. However, the signals are output at 48kHz/16bit if copyright-protected signals are contained.

🔊 Notes

- “48kHz/96kHz PCM” setting has no effect when audio signals are output from the LINE 2 OUT (R-AUDIO-L) jacks. If the sampling frequency is 96kHz, signals are simply converted to 96kHz analog signals and output.
- When you use the DIGITAL OUT (COAXIAL or OPTICAL) jack to listen to MPEG audio signals and set “MPEG” to “MPEG” in “Audio” setup, no sound will come from your speakers if you select one of the TVS modes.

Recording and Parental Control Settings (Features)

The “Features” setup allows you to adjust recording and parental control settings.

1 Press **SYSTEM MENU** while the recorder is in stop mode.

2 Select **“SETUP,”** and press **ENTER.**

3 Select **“Features,”** and press **ENTER.**

The “Features” setup appears with the following options. The default settings are underlined.

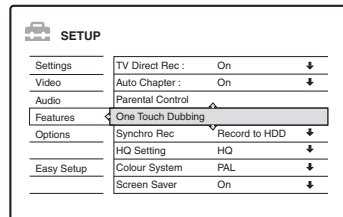

TV Direct Rec (HDD/DVD+RW/DVD-RW/DVD+R/DVD-R only)

<u>On</u>	Allows you to easily record what you are watching on the TV using SMARTLINK.
<u>Off</u>	Turns off the TV Direct Rec function.

Auto Chapter

Selects whether to automatically divide a recording (a title) into chapters during recording or dubbing.

<u>On</u>	For the HDD or a DVD-RW (VR mode), the recorder detects changes in the picture and sound and automatically inserts chapter marks. For other recordable discs, the recorder inserts chapter marks at approximately 6-minute intervals.
<u>Off</u>	No chapter mark is inserted.

Notes

- The actual chapter mark interval may vary depending on the amount of information contained in the video to be recorded.
- Chapter marks are automatically inserted where the recordings start on the tape when "Auto Chapter" is set to "On" during DV dubbing (RDR-HX710/HX910 only) to the HDD or a DVD-RW (VR mode).

Parental Control (DVD VIDEO only)

Playback of some DVD VIDEOS can be limited according to a predetermined level, such as the age of the users. Scenes may be blocked or replaced with different scenes.

- 1 Select "Parental Control" in "Features," and press ENTER.

- If you have not entered a password, the display for registering a new password appears.

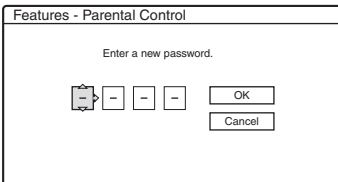

- When you have already registered a password, the display for entering the password appears.

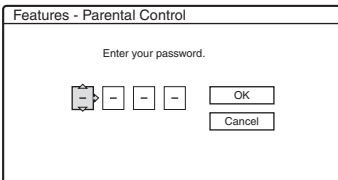

- 2 Enter your four-digit password using the number buttons, then select "OK" and press ENTER.

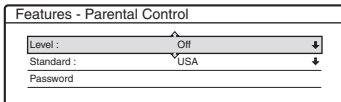

- 3 Select "Standard," and press → or ENTER. The selection items for "Standard" are displayed.

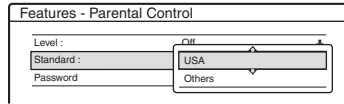

- 4 Select a geographic area as the playback limitation level, and press ENTER. The area is selected.

- When you select "Others," press the number buttons to select and enter an area code in the table (page 112). Then select "OK" and press ENTER.

- 5 Select "Level," and press ENTER.

The selection items for "Level" are displayed.

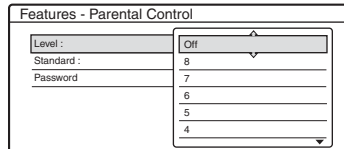

The lower the value, the stricter the limitation. Discs rated higher than the selected level will be restricted.

- 6 Select the level, and press ENTER.

The Parental Control setting is complete.

To cancel the Parental Control setting for the disc, set "Level" to "Off" in step 6.

To change the password, select "Password" in step 3, and press ENTER. When the display for registering a password appears, enter a new four-digit password using the number buttons, then select "OK" and press ENTER.

Notes

- If you forget your password, you will have to reset it by selecting "Parental Control" of "Factory Setup" in "Options" setup (page 94).
- When you play discs which do not have the Parental Control function, playback cannot be limited on this recorder.
- Depending on the disc, you may be asked to change the Parental Control level while playing the disc. In this case, enter your password, then change the level.

One Touch Dubbing (RDR-HX710/HX910 only)

Displays the following options for the One Touch Dub function.

◆ Finalize Disc (for all recordable discs except DVD-RW in VR mode)

Selects whether or not to finalize the disc automatically following One Touch Dubbing (page 79).

Auto	Automatically finalizes the disc following One Touch Dubbing.
<u>Manual</u>	Allows you to finalize the disc manually.

Synchro Rec

Selects the recording destination used for Synchro-Recording (page 50).

<u>Record to HDD</u>	Records to the HDD.
Record to DVD	Records to DVDs.

HQ Setting (HDD only)

Selects the HQ mode used for recording on the HDD (page 41).

HQ+	Records in higher quality (approximate 15 Mbps).
<u>HQ</u>	Records in the standard HQ mode.

Colour System

Selects the colour system when playing VIDEO CDs (including Super VIDEO CDs).

<u>PAL</u>	Plays a disc in PAL colour system.
NTSC	Plays a disc in NTSC colour system.

Screen Saver

The screen saver image appears when you do not use the recorder for more than 10 minutes while an on-screen display, such as the System Menu, is displayed on your TV screen. The screen saver image helps prevent your display device from becoming damaged (ghosting).

<u>On</u>	Turns on the screen saver function.
Off	Turns off the function.

Disc and Remote Control Settings/Factory Settings (Options)

The “Options” setup allows you to set up other operational settings.

- 1 Press **SYSTEM MENU** while the recorder is in stop mode.
- 2 Select **“SETUP,”** and press **ENTER**.
- 3 Select **“Options,”** and press **ENTER**.

The “Options” setup appears with the following options. The default settings are underlined.

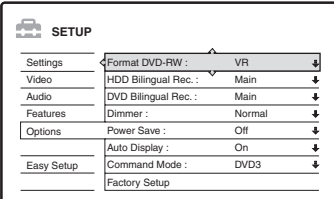

The screenshot shows the 'SETUP' menu with the following options:

Settings	Format DVD-RW : VR
Video	HDD Bilingual Rec. : Main
Audio	DVD Bilingual Rec. : Main
Features	Dimmer : Normal
<u>Options</u>	Power Save : Off
	Auto Display : On
Easy Setup	Command Mode : DVD3
	Factory Setup

Format DVD-RW (DVD-RW only)

The recorder automatically starts formatting in VR mode or Video mode, whichever is selected below, when a new, unformatted DVD-RW is inserted.

<u>VR</u>	Automatically formats the disc in VR mode.
Video	Automatically formats the disc in Video mode.

HDD Bilingual Rec. (HDD only)

Selects the sound to be recorded on the HDD.

<u>Main</u>	Records the main sound for the bilingual programme.
Sub	Records the sub sound for the bilingual programme.
Main+Sub	Records the main and sub sounds for the bilingual programme.

Note

If you set the recording mode to be changed while dubbing from a DVD to the HDD, the sound recorded in the source (DVD) is applied regardless of this setting.

DVD Bilingual Rec. (for all recordable discs except DVD-RW in VR mode)

Selects the sound to be recorded on the recordable disc. This setting is not necessary when recording on DVD-RWs (VR mode) that record both the main and sub sounds.

<u>Main</u>	Records the main sound for the bilingual programme.
<u>Sub</u>	Records the sub sound for the bilingual programme.

Dimmer

Adjusts the lighting of the front panel display.

<u>Normal</u>	Bright lighting.
<u>Power Save</u>	Low lighting. Turns off the lighting when the power is off.

Note

When "Power Save" in "Options" setup is set to "On," the front panel display is turned off during standby regardless of this setting.

Power Save

Selects whether this recorder is in power save mode when the power is turned off (standby).

<u>On</u>	Sets to power save mode. The front panel display is off when the recorder is in standby.
<u>Off</u>	Does not set to power save mode. Normally, select this.

Notes

- Power Save mode does not function in the following cases, even when "Power Save" is set to "On."
 - Synchro Recording is set.
 - there is a timer setting with "PDC/VPS" set to "On" in the Timer List.
- The SMARTLINK features are not available when "Power Save" is set to "On."

Auto Display

<u>On</u>	Automatically displays information on the screen when the recorder is turned on, etc.
<u>Off</u>	Displays information only when DISPLAY is pressed.

Command Mode

Changes the Command Mode of the recorder if other DVD equipment is assigned the same Command Mode. Be sure to match the Command Mode switch on the remote to the setting made here. For details, see "If you have a Sony DVD player or more than one Sony DVD recorder" on page 21.

<u>DVD1</u>	Select this if the default Command Mode conflicts with other DVD equipment.
<u>DVD2</u>	Select this if the default Command Mode conflicts with other DVD equipment.
<u>DVD3</u>	The default Command Mode of the recorder.

Factory Setup

Allows you to select the setup settings by group, and return them to their default settings. Note that all of your previous settings will be lost.

- 1 Select "Factory Setup" in "Options," and press **➡** or ENTER.
The display for selecting a group of settings appears.
- 2 Select the group of settings you want to return to default from "Settings," "Video," "Audio," "Features," "Options," "Parental Control," and "All," and press **➡** or ENTER.
- 3 Select "Start," and press ENTER.
The selected settings return to their default settings.
- 4 Press ENTER when "Finish" appears.

Easy Setup (Resetting the Recorder)

Select this to run the “Easy Setup” programme.

- 1** Press **SYSTEM MENU** while the recorder is in stop mode.
- 2** Select “**SETUP**,” and press **ENTER**.
- 3** Select “**Easy Setup**,” and press **ENTER**.

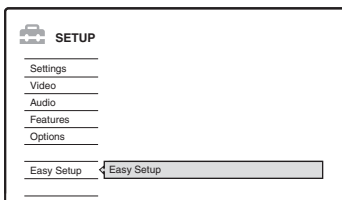

- 4** Press **ENTER**.
- 5** Select “**Start.**”
- 6** Follow the instructions for “**Easy Setup**” (page 22) from step 2.

Troubleshooting

If you experience any of the following difficulties while using the recorder, use this troubleshooting guide to help remedy the problem before requesting repairs. Should any problem persist, consult your nearest Sony dealer.

Power

The power does not turn on.

- ➔ Check that the mains lead is connected securely.

Picture

There is no picture.

- ➔ Re-connect all connecting cords securely.
- ➔ The connecting cords are damaged.
- ➔ Check the connection to your TV (page 13).
- ➔ Switch the input selector on your TV (such as to "VCR") so that the signal from the recorder appears on the TV screen.
- ➔ Check that "Scart Setting" in "Video" setup is set to the appropriate item that conforms to your system (page 88).
- ➔ If you connect the recorder to your TV via only the COMPONENT VIDEO OUT jacks, set "Component Out" in "Video" setup to "On" (page 88).
- ➔ This recorder cannot record NTSC signals.
- ➔ When playing a double-layer DVD, the video and audio may be momentarily interrupted at the point where the layers switch.

Picture noise appears.

- ➔ If the picture output signal from your recorder passes through your VCR to get to your TV, or if you are connected to a combination TV/VIDEO player, the copy-protection signal applied to some DVD programmes could affect picture quality. If you still experience this problem even when you connect your recorder directly to your TV, try connecting your recorder to your TV's S VIDEO input.
- ➔ You have set the recorder to progressive format (the PROGRESSIVE indicator lights up) even though your TV cannot accept the progressive signal. In this case, press PROGRESSIVE until the PROGRESSIVE indicator turns off.
- ➔ Even if your TV is compatible with progressive format (525p/625p) signals, the image may be affected when you set the recorder to progressive format. In this case, press PROGRESSIVE so that the PROGRESSIVE indicator turns off and the recorder is set to normal (interlace) format.
- ➔ You are playing a DVD recorded in a colour system that is different from your TV.
- ➔ Noise may appear in the pictures recorded on the HDD, which is due to the characteristics of HDD, and is not a malfunction.
- ➔ When playing a double-layer DVD, the video and audio may be momentarily interrupted at the point where the layers switch.

TV programme reception does not fill the screen.

- ➔ Set the channel manually in "Channel Setting" in "Settings" setup (page 82).
- ➔ Select the correct source using the INPUT SELECT button, or select a channel of any TV programme using the PROG +/- buttons.

TV programme pictures are distorted.

- ➔ Reorient the TV aerial.
- ➔ Adjust the picture (see the TV's instruction manual).
- ➔ Place the recorder and TV farther apart.
- ➔ Place the TV and any bunched aerial cables farther apart.
- ➔ The RF cable is connected to the AERIAL OUT jack on the recorder. Connect the cable to the AERIAL IN jack.

TV channels cannot be changed.

- ➔ The channel is disabled (page 85).
- ➔ A timer recording started, which changed the channels.

The picture from equipment connected to the recorder's input jack does not appear on the screen.

- ➔ If the equipment is connected to the LINE 1 – TV jack, select “L1” in the front panel display by pressing PROG +/- or INPUT SELECT.
If the equipment is connected to the LINE 2 IN jacks, select “L2” in the front panel display by pressing PROG +/- or INPUT SELECT.
If the equipment is connected to the LINE 4 IN jacks, select “L4” in the front panel display by pressing PROG +/- or INPUT SELECT.
If the equipment is connected to the LINE 3/ DECODER jack, select “L3” in the front panel display by pressing PROG +/- or INPUT SELECT.
If the equipment is connected to the DV IN jack, (this is usually for a digital video camera connection), select “DV” in the front panel display by pressing PROG +/- or INPUT SELECT (RDR-HX710/HX910 only).
- ➔ When an S video cable is connected to the recorder's LINE 4 IN jack, set “Line4 Input” in “Video” setup to “S Video” (page 89).

The playback picture or TV programme from the equipment connected through the recorder is distorted.

- ➔ If the playback picture output from a DVD player, VCR, or tuner goes through your recorder before reaching your TV, the copy-protection signal applied to some programmes could affect picture quality. Disconnect the playback equipment in question and connect it directly to your TV.

The picture does not fill the screen.

- ➔ Set “TV Type” in “Video” setup in accordance with the screen size of your TV (page 87).

The picture does not fill the screen, even though the picture size is set in “TV Type” in “Video” setup.

- ➔ The picture size of the title is fixed.

The picture is black and white.

- ➔ Check that “Line1 Output” of “Scart Setting” in “Video” setup is set to the appropriate item that conforms to your system (page 88).
- ➔ If you are using a SCART cord, be sure to use one that is fully wired (21 pins).

Sound**There is no sound.**

- ➔ Re-connect all connections securely.
- ➔ The connecting cord is damaged.
- ➔ The input source setting on the amplifier or the connection to the amplifier is incorrect.
- ➔ The recorder is in reverse play, fast-forward, slow motion, or pause mode.
- ➔ If the audio signal does not come through the DIGITAL OUT (OPTICAL or COAXIAL) jacks, check the “Audio Connection” settings in “Audio” setup settings (page 90).

Sound distortion occurs.

- ➔ Set “Audio ATT” in “Audio” setup to “On” (page 89).

Sound is noisy.

- ➔ When playing a CD with DTS sound tracks, noise will come from the LINE 2 OUT R-AUDIO-L jacks, LINE 1 – TV jack, or LINE 3/ DECODER jack (page 56).

The sound volume is low.

- ➔ The sound volume is low on some DVDs. The sound volume may improve if you set “Audio DRC” in “Audio” setup to “TV Mode” (page 90).
- ➔ Set “Audio ATT” in “Audio” setup to “Off” (page 89).
- ➔ One of the TVS effects is selected (page 55).

An alternate audio track cannot be recorded.

- ➔ When recording from connected equipment, set “Line Audio Input” in TOOLS menu to “Bilingual” (page 52).
- ➔ Multilingual tracks (main and sub) cannot be recorded on DVD+RWs, DVD-RWs (Video mode), DVD+Rs, or DVD-Rs. To record the language, select “Main” or “Sub” of “DVD Bilingual Rec.” in “Options” setup before recording (page 94). To record both the main and sub sounds, record on a DVD-RW (VR mode).
- ➔ Any discs other than the HDD or DVD-RWs (VR mode) cannot be used for recording both main and sub sounds. To record on the HDD, set “HDD Bilingual Rec.” in “Options” setup to “Main+Sub” (page 93).
- ➔ If you have connected an AV amplifier to the DIGITAL OUT (OPTICAL or COAXIAL) jacks and want to change the audio track for a DVD-RW (VR mode) during playback, set “Dolby Digital” of “Audio Connection” in “Audio” setup to “D-PCM” (page 90).

Playback

The recorder does not play any type of disc (except HDD).

- ➔ The disc is upside down. Insert the disc with the labelled side facing up.
- ➔ The disc is not correctly inserted.
- ➔ Moisture has condensed inside the recorder. Remove the disc and leave the recorder turned on for about half an hour until the moisture evaporates.
- ➔ If the disc was recorded on another recorder, the recorder cannot play the disc if it was not finalized (page 39).

The recorder does not start playback from the beginning.

- ➔ Resume play was activated (page 54).
- ➔ You have inserted a DVD whose Title menu or DVD menu automatically appears on the TV screen when it is first inserted. Use the menu to start playback.

The recorder starts playing automatically.

- ➔ The DVD VIDEO features an auto playback function.

Playback stops automatically.

- ➔ If the DVD has an auto pause signal, the recorder stops playback at the auto pause signal.

Some functions such as Stop, Search, or Slow-motion Play cannot be performed.

- ➔ Depending on the DVD, you may not be able to do some of the operations above. See the instruction manual supplied with the disc.

The language for the sound track cannot be changed.

- ➔ Multilingual tracks are not recorded on the DVD being played.
- ➔ The DVD VIDEO prohibits the changing of the language for the sound track.
- ➔ Try changing the language using the DVD VIDEO's menu.

The subtitle language cannot be changed or turned off.

- ➔ Multilingual subtitles are not recorded on the DVD VIDEO.
- ➔ The DVD VIDEO prohibits changing of the subtitles.
- ➔ Try changing the subtitle using the DVD VIDEO's menu.
- ➔ The subtitles cannot be changed for the titles recorded on this recorder.

The angles cannot be changed.

- ➔ Multi-angles are not recorded on the DVD VIDEO being played.
- ➔ You are trying to change the angles when "⏏" does not appear on the TV screen (page 55).
- ➔ The DVD VIDEO prohibits changing angles.
- ➔ Try changing the angle using the DVD VIDEO's menu.
- ➔ The angles cannot be changed for the titles recorded on this recorder.

The MP3 audio tracks do not play.

- ➔ The MP3 audio tracks are not recorded in a format that the recorder can play (page 63).

The JPEG image files do not play.

- ➔ The JPEG image files are not recorded in a format that the recorder can play (page 63).
- ➔ Progressive JPEG images cannot be played.

TV Pause does not work.

- ➔ You are recording to the HDD or the HDD is full.

**Recording/Timer recording/
Editing**

The programme position cannot be changed from the programme position you are recording.

- ➔ Set the TV's input source to "TV."

Recording does not start immediately after you press ● REC.

- ➔ Operate the recorder only after "LOAD," "FORMAT," or "INFOWRITE" disappears from the front panel display.

Nothing was recorded even though you set the timer setting correctly.

- ➔ There was a power failure during recording.
- ➔ The recorder's internal clock stopped due to a power failure that lasted for more than 1 hour. Reset the clock (page 86).
- ➔ The channel was disabled after the timer recording was set. See "Channel Setting" on page 82.
- ➔ Disconnect the mains lead from the mains, and connect it again.
- ➔ "PDC/VPS Scan Off" was selected in the TOOLS menu (page 44).
- ➔ The programme contains copy protection signals that restrict copying.
- ➔ Other timer setting overlapped the timer setting (page 49).
- ➔ There is no DVD inside the recorder.
- ➔ There is not enough disc space for the recording.
- ➔ The recorder was in the process of DV Dubbing (RDR-HX710/HX910 only).

Recording does not stop immediately after you press ■ REC STOP.

- ➔ It will take a few seconds for the recorder to input disc data before recording can stop.

Recording does not stop after you press ■.

- ➔ Open the remote's cover and press ■ REC STOP.

Timer recording is not complete or did not start from the beginning.

- ➔ There was a power failure during recording. If the power recovers when there is a timer recording, the recorder resumes recording. Should the power failure continue for more than 1 hour, reset the clock (page 86).
- ➔ Other timer setting overlapped the timer setting (page 49).
- ➔ Disc space was not enough.
- ➔ The PDC/VPS function is working.

Contents previously recorded were erased.

- ➔ Data that has been recorded on a DVD with a PC will be erased from the disc when the disc is inserted.
- ➔ "Auto Title Erase" in the TOOLS menu (appears when you press TOOLS while the Timer List menu is turned on) is set to "On" (page 50).
- ➔ The title was updated and recorded over (page 43).

The PDC/VPS function does not operate.

- ➔ Check that the clock and date are set correctly.
- ➔ Check that the PDC/VPS time you set is the correct one (there might be a mistake in the TV programme guide). If the broadcast you wanted to record did not send the good PDC/VPS information, the recorder will not start recording.
- ➔ If the reception is poor, the PDC/VPS signal might be altered and the recorder might not start recording.
- ➔ "PDC/VPS Scan Off" is selected (page 44).

Recording from the equipment with a timer

Nothing was recorded even though you set the Synchro-Rec setting correctly.

- ➔ You forgot to turn off the connected equipment. Turn off the connected equipment and set the recorder to Synchro-Rec standby mode (page 50).
- ➔ The recorder was not set to the Synchro-Recording standby mode. Press SYNCHRO REC to have the recorder stand by for recording. Make sure the SYNCHRO REC indicator lights up on the front panel (page 50).
- ➔ The recorder is connected to the TV output jack of the connected equipment.

Synchro-Recording does not complete.

- ➔ The timer setting for the connected equipment overlapped the recorder's timer setting (page 51).
- ➔ There was a power failure during the recording.

The recorder automatically starts recording when the satellite receiver is turned on.

- ➔ The Synchro-Rec function was activated. Turn off the satellite receiver and cancel the Synchro-Rec function (page 50).

Display

The clock has stopped.

- ➔ Set the clock again (page 86).
- ➔ The clock stopped due to a power failure that lasted for more than 1 hour. Reset the clock (page 86).

The TIMER REC indicator is flashing.

- ➔ The disc does not have enough space.
- ➔ Insert a recordable disc inside the recorder.

The recording mode indication is incorrect.

- ➔ When the recording or dubbing is less than three minutes, the recording mode indication may be displayed incorrectly. The actual recording itself is correctly made in the selected recording mode.
- ➔ After playing titles recorded in SLP and SEP mode, the recording mode indication may change depending on the recorded programme.

The clock does not appear in the front panel display.

- ➔ “Dimmer” in “Options” setup is set to “Power Save” (page 94).
- ➔ The “Power Save” in “Options” setup was set to “On,” and the recorder is in standby (page 94).

Remote control**The remote does not function.**

- ➔ Batteries are weak.
- ➔ The remote is too far from the recorder.
- ➔ The remote’s manufacturer code returned to the default setting when you replaced the batteries. Reset the code (page 19).
- ➔ Turn on the recorder.
- ➔ The remote is not pointed at the remote sensor on the recorder.
- ➔ Different command modes are set for the recorder and remote. Set the same command mode (page 21). The default command mode setting for this recorder and the supplied remote is DVD3.
- ➔ Set the TV/DVD switch to DVD (page 20).

Other Sony equipment responds to the remote.

- ➔ The same command mode is set for both the equipment and recorder. Set a different command mode for the recorder (page 21).

Others**The recorder does not operate properly.**

- ➔ Restart the recorder. Press down **I/⏻** on the recorder for more than ten seconds until “WELCOME” appears in the front panel display.
- ➔ When static electricity, etc., causes the recorder to operate abnormally, turn off the recorder and wait until the clock appears in the front panel display. Then, unplug the recorder and after leaving it off for a while, plug it in again.

Five numbers or letters are displayed in the front panel display.

- ➔ The self-diagnosis function was activated (see the table on page 102).

The disc tray does not open after you press **⏻ (open/close).**

- ➔ It may take a few seconds for the disc tray to open after you have recorded or edited a DVD. This is because the recorder is adding disc data to the disc.

The disc tray does not open and “TRAY LOCKED” appears in the front panel display.

- ➔ Contact your Sony dealer or local authorized Sony service facility.

“RECOVERY” appears in the front panel display.

- ➔ The recorder’s recovery function was activated when the recorder was turned on because the power was turned off or failed during recording. Leave the recorder on until “RECOVERY” disappears from the front panel display.

“HDD ERROR” appears in the front panel display.

- ➔ The hard disk error occurred. Press down **I/⏻** on the recorder for ten seconds until “WELCOME” appears in the front panel display. If this does not resolve the problem, format the recorder’s HDD by pressing down the HDD button on the recorder for more than ten seconds until “FORMAT” appears in the front panel display. Note that all the contents recorded on the HDD will be erased. If this does not fix the problem, contact your nearest Sony dealer.

“FAN ERROR” appears in the front panel display.

- ➔ Check that the vent on the rear of the recorder is not blocked. Then, immediately disconnect the mains lead. Leave the recorder off for a while, then re-connect the mains lead, and press **I/⏻** on the recorder.

Mechanical sound is heard when the recorder is off.

- ➔ While the recorder is adjusting the clock for the Auto Clock Set function or scanning the channels for the PDC/VPS function, operational noises (such as the internal fan) may be heard, even when the power is off. This is not a malfunction.

The disc tray does not open and you cannot remove the disc after you press **⏻ (open/close).**

- ➔ Turn off the recorder. Once the clock appears in the front panel display, disconnect the mains lead. Connect it again while pressing down **⏻** on the recorder, and release the button when the disc tray opens. Then, keep **I/⏻** on the recorder pressed for about ten seconds until “WELCOME” appears in the front panel display.

“LOCKED” appears in the front panel display.

- ➔ The disc tray is locked. Cancel the Child Lock (page 54).

Self-diagnosis Function (When letters/numbers appear in the display)

When the self-diagnosis function is activated to prevent the recorder from malfunctioning, a five-character service number (e.g., C 13 00) with a combination of a letter and four numbers appears in the front panel display. In this case, check the following table.

First three characters of the service number	Cause and/or corrective action
C 13	There is a problem in the HDD. ➔ Contact your nearest Sony dealer or local authorized service facility. The DVD is dirty. ➔ Clean the disc with a soft cloth.
C 31	The DVD/CD is not inserted correctly. ➔ Re-insert the disc correctly.
E XX (xx is a number)	To prevent a malfunction, the recorder has performed the self-diagnosis function. ➔ Contact your nearest Sony dealer or local authorized Sony service facility and give the five-character service number. Example: E 61 10

Notes About This Recorder

On operation

- If the recorder is brought directly from a cold to a warm location, or is placed in a very damp room, moisture may condense on the lenses inside the recorder. Should this occur, the recorder may not operate properly. In this case, remove the disc and leave the recorder turned on for about half an hour until the moisture evaporates.
- When you move the recorder, take out any discs. If you don't, the disc may be damaged.

On adjusting volume

Do not turn up the volume while listening to a section with very low level inputs or no audio signals. If you do, the speakers may be damaged when a peak level section is played.

On cleaning

Clean the cabinet, panel, and controls with a soft cloth slightly moistened with a mild detergent solution. Do not use any type of abrasive pad, scouring powder or solvent such as alcohol or benzine.

About repairing the hard disk drive

- It may be necessary to access data stored on the hard disk for testing purposes; there is no intention to copy or store the data, titles or any other information.
- If replacement or initialization (format) is required, the hard disk will be formatted at our discretion. In this case, please note that all of the contents recorded there will be erased (including any data found to violate copyright law).

On cleaning discs

Do not use a commercially available cleaning disc. It may cause a malfunction.

Notes about the discs

- To keep the disc clean, handle the disc by its edge. Do not touch the surface. Dust, fingerprints, or scratches on the disc may cause it to malfunction.



- Do not expose the disc to direct sunlight or heat sources such as hot air ducts, or leave it in a car parked in direct sunlight as the temperature may rise considerably inside the car.
- After playing, store the disc in its case.
- Clean the disc with a cleaning cloth. Wipe the disc from the centre out.



- Do not use solvents such as benzine, thinner, commercially available cleaners, or anti-static spray intended for vinyl LPs.
- Do not use the following discs.
 - A disc that has a non-standard shape (e.g., card, heart).
 - A disc with a label or sticker on it.
 - A disc that has cellophane tape or sticker adhesive on it.

Specifications

System

Laser: Semiconductor laser

Channel coverage:

PAL/SECAM (B/G, D/K, I, L)
VHF: E2 to E12, R1 to R12, F2 to F10, Italian
A to H, Ireland A to J, South Africa 4 to 13/
UHF: E21 to E69, R21 to R69, B21 to B69,
F21 to F69/CATV: S01 to S05, S1 to S20,
France B to Q/HYPER: S21 to S41

For details, see "Receivable channels" (page 83).
The above channel coverage merely ensures the
channel reception within these ranges. It does not
guarantee the ability to receive signals in all
circumstances.

Video reception: Frequency synthesizer system

Audio reception: Split carrier system

Aerial out: 75-ohm asymmetrical aerial socket

Timer: Clock: Quartz locked/Timer indication:
24-hour cycle (digital)/Power back-up
duration: 1 hour

Video recording format: MPEG Video

**Audio recording format/applicable bit
rate:** Dolby Digital 2 ch/256 kbps

Inputs and outputs

LINE 2 OUT

(AUDIO): Phono jack/2 V_{rms}/10 kilohms

(VIDEO): Phono jack/1.0 V_{p-p}

(S VIDEO): 4-pin pin DIN/Y:1.0 V_{p-p},
C: 0.3 V_{p-p} (PAL)

LINE 2 IN/LINE 4 IN

(AUDIO): Phono jack/2 V_{rms}/more than
22 kilohms

(VIDEO): Phono jack/1.0 V_{p-p}

(S VIDEO): 4-pin mini DIN/Y:1.0 V_{p-p},
C: 0.3 V_{p-p} (PAL)

LINE 1 – TV: 21-pin

CVBS IN/OUT
S-Video/RGB OUT (upstream)

LINE 3/DECODER: 21-pin

CVBS IN/OUT
S-Video/RGB IN
S-Video OUT (downstream)
Decoder

DV IN: 4-pin/i.LINK S100 (RDR-HX710/HX910
only)

DIGITAL OUT (OPTICAL): Optical output jack/
–18 dBm (wave length: 660 nm)

DIGITAL OUT (COAXIAL): Phono jack/
0.5 V_{p-p}/75 ohms

COMPONENT VIDEO OUT

(Y, P_B/C_B, P_R/C_R):

Phono jack/Y: 1.0 V_{p-p}, P_B/C_B: 0.7 V_{p-p},
P_R/C_R: 0.7 V_{p-p}

General

Power requirements: 220-240 V AC, 50/
60 Hz

Power consumption:

RDR-HX510: 52 W

RDR-HX710: 53 W

RDR-HX910: 55 W

Dimensions (approx.): 430 × 65 × 328 mm
(width/height/depth) incl. projecting parts

Hard disk drive capacity:

RDR-HX510: 80 GB

RDR-HX710: 160 GB

RDR-HX910: 250 GB

Mass (approx.):

RDR-HX510: 4.8 kg

RDR-HX710/HX910: 4.9 kg

Operating temperature: 5°C to 35°C

Operating humidity: 25% to 80%

Supplied accessories:

Mains lead (1)

Aerial cable (1)

Remote commander (remote) (1)

R6 (size AA) batteries (2)

Specifications and design are subject to change
without notice.

Compatible colour systems

This recorder is designed to record using the PAL
colour system and play back using the PAL or
NTSC colour systems.

The signals of the SECAM colour system can be
received or recorded but played back in the PAL
colour system only. Recording of video sources
based on other colour systems cannot be
guaranteed.

About i.LINK (RDR-HX710/ HX910 only)

The DV IN jack on this recorder is an i.LINK-compliant DV IN jack. This section describes the i.LINK standard and its features.

What is i.LINK?

i.LINK is a digital serial interface for handling digital video, digital audio and other data in two directions between equipment having the i.LINK jack, and for controlling other equipment.

i.LINK-compatible equipment can be connected by a single i.LINK cable. Possible applications are operations and data transactions with various digital AV equipment. When two or more i.LINK-compatible equipment are connected to this recorder in a daisy chain, operations and data transactions are possible with not only the equipment that this recorder is connected to but also with other devices via the directly connected equipment.

Note, however, that the method of operation sometimes varies according to the characteristics and specifications of the equipment to be connected, and that operations and data transactions are sometimes not possible on some connected equipment.

Note

Normally, only one piece of equipment can be connected to this recorder by the i.LINK cable (DV connecting cable). When connecting this recorder to i.LINK-compatible equipment having two or more i.LINK jacks (DV jacks), see the instruction manual of the equipment to be connected.

About the name “i.LINK”

i.LINK is a more familiar term for IEEE 1394 data transport bus proposed by SONY, and is a trademark approved by many corporations. IEEE 1394 is an international standard standardized by the Institute of Electrical and Electronics Engineers.

i.LINK baud rate

i.LINK's maximum baud rate varies according to the equipment. Three maximum baud rates are defined:

S100 (approx. 100 Mbps*)

S200 (approx. 200 Mbps)

S400 (approx. 400 Mbps)

The baud rate is listed under “Specifications” in the instruction manual of each equipment. It is also indicated near the i.LINK jack on some equipment.

The maximum baud rate of equipment on which it is not indicated such as this unit is “S100.”

When units are connected to equipment having a different maximum baud rate, the baud rate sometimes differs from the indicated baud rate.

* What is Mbps?

Mbps stands for megabits per second, or the amount of data that can be sent or received in one second. For example, a baud rate of 100 Mbps means that 100 megabits of data can be sent in one second.

i.LINK functions on this recorder

For details on how to dub when this recorder is connected to other video equipment having DV jacks, see page 77.

The DV jack on this recorder can only input DVC-SD signals. It cannot output signals. The DV jack will not accept MICRO MV signals from equipment such as a MICRO MV digital video camera with an i.LINK jack.



For further precautions, see the notes on page 77.

For details on precautions when connecting this recorder, also see the instruction manuals for the equipment to be connected.

Required i.LINK cable

Use the Sony i.LINK 4-pin-to-4-pin cable (during DV dubbing).

i.LINK and  are trademarks.

- 23 VISUAL SEARCH button (60)
- 24 ▷ (play) button (53)
 - ▬▬ (pause) button (55)
 - (stop) button (53)The ▷ button has a tactile dot*.
- 25 ● REC button (31)
 - ▬▬ REC PAUSE button (31)
 - REC STOP button (31)
- 26 REC MODE button (31)
- 27 CHAPTER MARK/CHAPTER MARK ERASE buttons (69)
- 28 SYNCHRO REC buttons (50)
- 29  (wide mode) button (19)
- 30  (angle) button (55)
- 31 COMMAND MODE switch (DVD 1,2,3) (21)
- 32 PROGRESSIVE button (16)

* Use the tactile dot as a reference when operating the recorder.

Front panel

RDR-HX510

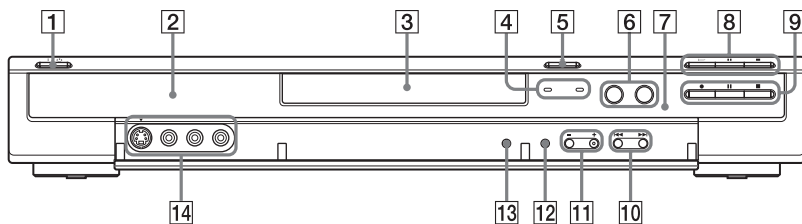

RDR-HX710/HX910

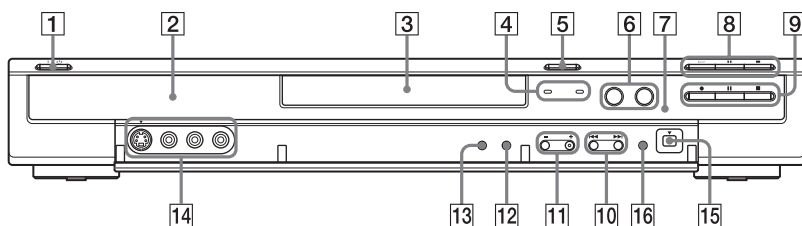

- 1** (on/standby) button (22)
- 2** Front panel display (35, 109)
- 3** Disc tray (29)
- 4** TIMER REC indicator (43)
SYNCHRO REC indicator (50)
- 5** (open/close) button (29)
- 6** HDD button/indicator (31)
DVD button/indicator (29)
- 7** (remote sensor) (19)
- 8** (play) button (53)
 (pause) button (55)
 (stop) button (53)
- 9** REC button (31)
 REC PAUSE button (31)
 REC STOP button (31)
- 10** (previous/next) buttons (55)
- 11** PROGRAM +/- buttons (31)
The + button has a tactile dot*.
- 12** INPUT SELECT button (52, 77)
- 13** REC MODE button (41)
- 14** LINE 2 IN (S VIDEO/VIDEO/AUDIO L (MONO)/R) jacks (24)
- 15** DV IN jack (77)
- 16** ONE-TOUCH DUB button (79)

* Use the tactile dot as a reference when operating the recorder.

Front panel display

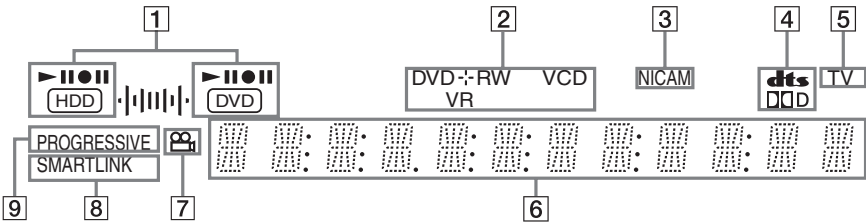

- 1** HDD/DVD indicators
Displays the selected media and the playing/recording/dubbing status.
- 2** Disc type*/recording format
- 3** NICAM indicator (42)
- 4** Audio signal indicators (34)
- 5** TV indicator (31)
- 6** Displays the following (35):
 - Playing time/remaining time
 - Current title/chapter/track/index number
 - Recording time/recording mode
 - Clock
 - Programme position
 - TV Direct Rec indication (31): “TV” appears in the right most two digits.
- 7**  (angle) indicator (55)
- 8** SMARTLINK indicator (14)
- 9** PROGRESSIVE indicator (16)

* Displays DATA CDs as “CD.”

Hint

You can turn off the front panel display when the recorder is turned off by setting “Dimmer” to “Power Save” in “Options” setup (page 94).

Rear panel

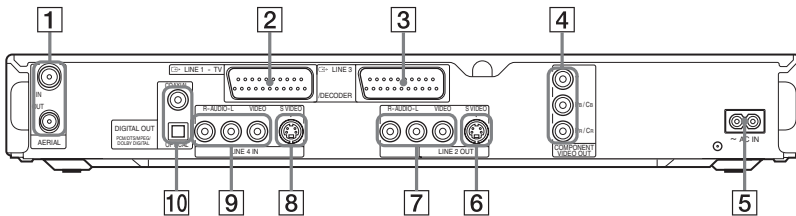

- 1** AERIAL IN/OUT jacks (13)
- 2** LINE 1 - TV jack (14)
- 3** LINE 3/DECODER jack (23)
- 4** COMPONENT VIDEO OUT (Y, Pb/Cb, Pr/Cr) jacks (14)
- 5** AC IN terminal (18)
- 6** LINE 2 OUT (S VIDEO) jack (14)
- 7** LINE 2 OUT (R-AUDIO-L/VIDEO) jacks (14, 17)
- 8** LINE 4 IN (S VIDEO) jack (24)
- 9** LINE 4 IN (R-AUDIO-L/VIDEO) jacks (24)
- 10** DIGITAL OUT (COAXIAL/OPTICAL) jacks (17)

Glossary

Chapter (page 60)

Sections of a picture or a music feature that are smaller than titles. A title is composed of several chapters. Depending on the disc, no chapters may be recorded.

Copy protection signals (page 42)

Copy restriction set by copyright owners, etc. These signals are included in some software or TV programmes and restrict recording on this recorder.

Dolby Digital (page 90)

Digital audio compression technology developed by Dolby Laboratories. This technology conforms to multi-channel surround sound. The rear channel is stereo and there is a discrete subwoofer channel in this format. Dolby Digital provides the same discrete channels of high quality digital audio found in "Dolby Digital" theater surround sound systems.

Good channel separation is realized because all of the channel data is recorded discretely, and little deterioration occurs because all channel data processing is digital.

DTS (page 90)

Digital audio compression technology by Digital Theater Systems, Inc. This technology conforms to multi-channel surround sound. The rear channel is stereo and there is a discrete subwoofer channel in this format. DTS provides the same discrete channels of high quality digital audio.

Good channel separation is realized because all of the channel data is recorded discretely, and little deterioration occurs because all channel data processing is digital.

DVD+R (page 8)

A DVD+R (read "plus R") is a recordable disc that is the same size as a DVD VIDEO. Contents can be recorded only once to a DVD+R, and will have the same format as a DVD VIDEO.

DVD+RW (page 8)

A DVD+RW (read "plus RW") is a recordable and rewritable disc. DVD+RWs use a recording format that is comparable to the DVD VIDEO format.

DVD-R (page 8)

A DVD-R is a recordable disc that is the same size as a DVD VIDEO. Contents can be recorded only once to a DVD-R, and will have the same format as a DVD VIDEO.

DVD-RW (page 8)

A DVD-RW is a recordable and rewritable disc that is the same size as a DVD VIDEO. The DVD-RW has two different modes: VR mode and Video mode. DVDs created in Video mode have the same format as a DVD VIDEO, while discs created in VR (Video Recording) mode allow the contents to be programmed or edited.

DVD VIDEO (page 10)

A disc that contains up to eight hours of moving pictures on a disc the same diameter as a CD. The data capacity of a single-layer and single-sided DVD is 4.7 GB (Giga Byte), which is 7 times that of a CD. The data capacity of a double-layer and single-sided DVD is 8.5 GB, a single-layer and double-sided DVD is 9.4 GB, and double-layer and double-sided DVD is 17 GB. The picture data uses the MPEG 2 format, which is a worldwide standard of digital compression technology. The picture data is compressed to about 1/40 (average) of its original size. The DVD also uses a variable rate coding technology that changes the data to be allocated according to the status of the picture. Audio information is recorded in a multi-channel format, such as Dolby Digital, allowing you to enjoy a more real audio presence.

Furthermore, various advanced functions such as the multi-angle, multilingual, and Parental Control functions are provided on the DVD.

Hard disk drive (page 2)

A hard disk drive is a whole mechanical system that consists of disks and drive. Disks are flat, circular, rigid plates coated with a thin magnetic media. Magnetic heads record data on the rapidly spinning disks, and this enables the speedy and efficient reading and writing of data.

Interlace format (page 16)

Interlace format shows every other line of an image as a single “field” and is the standard method for displaying images on television. The even number field shows the even numbered lines of an image, and the odd numbered field shows the odd numbered lines of an image.

MPEG Audio (page 90)

International standard coding system used to compress audio digital signals authorized by ISO/IEC. MPEG 2, used on DVDs, conforms to up to 7.1-channel surround.

Original (page 65)

Titles actually recorded on a HDD/DVD-RW (VR mode). Erasing original titles frees up disc space.

Playlist (page 65)

Playback information created from the actual recordings on a HDD/DVD-RW (VR mode). A Playlist leaves the original titles as they are, and contains only the information needed to control playback. A Playlist title takes up very little disc space.

Progressive format (page 16)

Compared to the Interlace format that alternately shows every other line of an image (field) to create one frame, the Progressive format shows the entire image at once as a single frame. This means that while the Interlace format can show 25-30 frames/50-60 fields in one second, the Progressive format can show 50/60 frames in one second. The overall picture quality increases and still images, text, and horizontal lines appear sharper.

Title (page 60)

The longest section of a picture or music feature on a DVD, movie, etc., in video software, or the entire album in audio software.

Track (page 60)

Sections of a music feature on a CD/VIDEO CD (the length of a song).

Language Code List

For details, see page 87.

The language spellings conform to the ISO 639: 1988 (E/F) standard.

Code Language	Code Language	Code Language	Code Language
1027 Afar	1183 Irish	1347 Maori	1507 Samoan
1028 Abkhazian	1186 Scots Gaelic	1349 Macedonian	1508 Shona
1032 Afrikaans	1194 Galician	1350 Malayalam	1509 Somali
1039 Amharic	1196 Guarani	1352 Mongolian	1511 Albanian
1044 Arabic	1203 Gujarati	1353 Moldavian	1512 Serbian
1045 Assamese	1209 Hausa	1356 Marathi	1513 Siswati
1051 Aymara	1217 Hindi	1357 Malay	1514 Sesotho
1052 Azerbaijani	1226 Croatian	1358 Maltese	1515 Sundanese
1053 Bashkir	1229 Hungarian	1363 Burmese	1516 Swedish
1057 Byelorussian	1233 Armenian	1365 Nauru	1517 Swahili
1059 Bulgarian	1235 Interlingua	1369 Nepali	1521 Tamil
1060 Bihari	1239 Interlingue	1376 Dutch	1525 Telugu
1061 Bislama	1245 Inupiak	1379 Norwegian	1527 Tajik
1066 Bengali;	1248 Indonesian	1393 Occitan	1528 Thai
Bangla	1253 Icelandic	1403 (Afan)Oromo	1529 Tigrinya
1067 Tibetan	1254 Italian	1408 Oriya	1531 Turkmen
1070 Breton	1257 Hebrew	1417 Punjabi	1532 Tagalog
1079 Catalan	1261 Japanese	1428 Polish	1534 Setswana
1093 Corsican	1269 Yiddish	1435 Pashto;	1535 Tonga
1097 Czech	1283 Javanese	Pushto	1538 Turkish
1103 Welsh	1287 Georgian	1436 Portuguese	1539 Tsonga
1105 Danish	1297 Kazakh	1463 Quechua	1540 Tatar
1109 German	1298 Greenlandic	1481 Rhaeto-	1543 Twi
1130 Bhutani	1299 Cambodian	Romance	1557 Ukrainian
1142 Greek	1300 Kannada	1482 Kirundi	1564 Urdu
1144 English	1301 Korean	1483 Romanian	1572 Uzbek
1145 Esperanto	1305 Kashmiri	1489 Russian	1581 Vietnamese
1149 Spanish	1307 Kurdish	1491 Kinyarwanda	1587 Volapük
1150 Estonian	1311 Kirghiz	1495 Sanskrit	1613 Wolof
1151 Basque	1313 Latin	1498 Sindhi	1632 Xhosa
1157 Persian	1326 Lingala	1501 Sangho	1665 Yoruba
1165 Finnish	1327 Laothian	1502 Serbo-	1684 Chinese
1166 Fiji	1332 Lithuanian	Croatian	1697 Zulu
1171 Faroese	1334 Latvian;	1503 Singhalese	
1174 French	Lettish	1505 Slovak	
1181 Frisian	1345 Malagasy	1506 Slovenian	1703 Not specified

Area Code

For details, see page 92.

Code Area	Code Area	Code Area	Code Area
2044 Argentina	2165 Finland	2362 Mexico	2149 Spain
2047 Australia	2174 France	2376 Netherlands	2499 Sweden
2046 Austria	2109 Germany	2390 New Zealand	2086 Switzerland
2057 Belgium	2248 India	2379 Norway	2528 Thailand
2070 Brazil	2238 Indonesia	2427 Pakistan	2184 United
2079 Canada	2254 Italy	2424 Philippines	Kingdom
2090 Chile	2276 Japan	2436 Portugal	
2092 China	2304 Korea	2489 Russia	
2115 Denmark	2363 Malaysia	2501 Singapore	

Index

Words in quotations appear in the on-screen displays.

Numerics

- 16:9 22, 87
- 4:3 Letter Box 22, 87
- 4:3 Pan Scan 22, 87
- “48kHz/96kHz PCM” 91

A

- “A-B Erase” 67
- Adjusting
 - playback picture 57
 - playback sound 57
 - recording picture 47
- Aerial 13
- “AFT” 83
- Album 35, 64
- Album number 35
- “Album Search” 60
- Angle 55
- Area code 112
- Audio 55, 89
- “Audio Connection” 22
- Audio cord 17
- “Audio DRC” 90
- “Audio Filter” 58
- “Audio” 87
- “Audio Settings” 57
- “Auto Adjust” 86
- “Auto Chapter” 91
- Auto Clock Set 86
- “Auto Display” 94
- “Auto Title Erase” 50
- “AV SYNC” 58

B

- Batteries 19
- “Bilingual” 51, 52
- Bilingual recording 42
- “BNR” 57
- “Brightness” 47, 57

C

- “C NR” 57
- Canal Plus 26
- “Capture All” 70
- “Capture” 70
- “CATV” 82
- CD 10
- “Change IN” 70, 80
- “Change OUT” 70, 80
- “Channel List” 85
- “Channel Setting” 82
- Chapter 35, 48, 69, 110
- CHAPTER MARK 69
- CHAPTER MARK ERASE 69
- Chapter number 35
- “Chapter Search” 60
- Chasing Playback 58
- “Check Overlap” 49
- Checking/changing/
cancelling timer settings
(Timer List) 48
- Child Lock 54
- Cleaning discs 103
- Clock 22, 86
- “Colour” 47, 57
- “Colour System” 93
- Colour systems 104
- “Combine” 71
- “Command Mode” 21, 94
- “Component Out” 88
- Component video input 14
- COMPONENT VIDEO OUT 14
- Connecting 14
 - the aerial cable 13
 - the audio cords 17
 - the video cords 14
- “Contrast” 47, 57
- Controlling TVs with the remote 19
- Copy control signals 42
- Copy protection 110
- Copy-Free 42
- Copy-Never 42
- Copy-Once 42
- CPRM 8
- “Create Playlist” 70
- Creating chapters 69

D

- DATA CD 10
- “Decoder” 27
- “Digital Out” 90
- Digital video camera 77
- “Dimmer” 94
- “Disc Info” 29, 38, 69
- Disc Map 69
- Disc Settings 29, 38, 69, 93
- Disc space 30
- Disc types 8
- Display
 - front panel display 35, 109
- “Divide” 68
- Dolby Digital 17, 90, 110
- “Downmix” 90
- DTS 91, 110
- “Dub Mode” 72, 81
- Dubbing
 - “Dub Mode” 72
 - High-speed Dubbing 72
 - Rec Mode Conversion
Dubbing 73
 - “Settings” 76
- “DV Audio Input” 78
- DV Dubbing 77
 - One Touch Dubbing 79, 93
 - Program Edit 79
- “DV EDIT” 80
- DV IN 77
- “DVD Bilingual Rec.” 94
- “DVD Menu” 87
- “DVD Rec. Picture Size” 47
- DVD VIDEO 10, 110
- DVD+R 8, 110
- DVD+RW 8, 110
- DVD-R 8, 110
- DVD-RW 8, 110
- DVD-RWs (Video mode) 66
- “DVE” 57

E

Easy Setup 22, 95
Editing 65, 70
 DV Edit 77
Enter characters 36
“Erase All” 69
“Erase” 49, 66, 70, 80
“Erase Titles” 68
“Extend Rec” 44

F

“Factory Setup” 94
“Features” 91
“File Search” 60
“Finalize Disc” 93
“Finalize” 39
Finalizing 39
“Format DVD-RW” 93
“Format” 29
Formatting 29
Freeze Frame 56
Front panel 108
Front panel display 35, 109

G

GB 30

H

Handling discs 103
“HDD Bilingual Rec.” 93
“Hue” 57

I

i.LINK 105
INPUT SELECT 52, 78
Interlace 111
Interlace format 111

J

JPEG image files 61

L

Labelling 38
Language 87
LINE 2 IN 24
LINE 3/DECODER 23
LINE 4 IN 24
“Line Audio Input” 51, 52
“Line1 Output” 88
“Line3 Input” 89
“Line3 Output” 89
“Line4 Input” 89

M

Mains Lead 18
Manual Clock Set 86
MENU 53
Menu
 DVD’s Menu 53
 Top menu 53
“Mix” 78
“MNR” 57
“Modify” 49
“Move” 70, 80
MP3 audio tracks 61
MPEG 91, 111

N

NICAM 42, 83
“Normal” 82
Number buttons 37, 45

O

One Touch Dubbing 79, 93
One Touch Menu 54
One Touch Play 54
One Touch Timer 44
On-screen display
 “OSD” language 22, 87
“Options” 93
Original 33, 65, 111

P

Page mode 33
Parental Control 54, 92
Parts and controls 106
“Pause Mode” 88
PAY-TV 26
“PAY-TV/CANAL +” 84
“PB Video Equalizer” 57
PBC 53
PDC 44
Picture quality 47, 57
Picture size 47
“Play Beginning” 54
Play mode 35
Playable discs 10
Playback 10, 35, 53, 55, 56
 fast forward 56
 fast reverse 56
 freeze frame 56
 instant advance 55
 instant replay 55
 JPEG image files 61
 MP3 audio tracks 61
 resume play 54
 scan audio 53
 slow-motion play 56

Playing status bar 35
Playlist 33, 65, 70, 111
“Power Save” 94
“Present Time” 86
“Preview” 70, 80
Program Edit 79
Progressive 16, 111
“Progressive Mode” 88
“Protect Disc” 38
“Protect” 66
Protection
 disc 38
 title 66

Q

Quick guide to disc types 8
Quick Timer 46

- R**
- Rear panel 109
 - REC 31
 - Rec Mode Adjust 44
 - “Rec Mode” 47
 - “Rec NR” 47
 - REC PAUSE 31
 - “Rec Settings” 47
 - REC STOP 79
 - “Rec Video Equalizer” 47
 - Recordable discs 8
 - Recording 41, 50, 91
 - picture adjustment 47
 - recording format 8
 - recording mode 32, 41
 - recording time 32
 - “Update” 43
 - while watching another programme 31
 - Recording time 41
 - RECOVERY 101
 - Region code 11
 - Remaining time 35
 - Remote 19, 106
 - Resetting the recorder 95
 - Resume Play 54
 - “RGB” 22, 88
- S**
- S VIDEO 14
 - “S Video” 22, 88
 - Scan Audio 53
 - “Scart Setting” 88
 - Scene List 70
 - Screen Saver 93
 - “Search” 60
 - Searching
 - fast reverse/fast forward 55
 - locating the beginning of the title/chapter/track 55
 - scan audio 53
 - search mode 60
 - visual search 60
 - SET 20, 37
 - “Set Thumbnail” 66
 - “Settings” 82
 - Simultaneous Rec and Play 59
 - Slow-motion play 56
 - SMARTLINK 15
 - Sort 33
 - Sound quality 57
 - “Station Name” 84
 - “Stereo1” 78
 - “Stereo2” 78
 - Subtitle 55, 87
 - Super VIDEO CD 10
 - Surround 55
 - Synchro Rec 50
 - “System” 82
- T**
- Teletext 32, 85
 - Thumbnail picture 34
 - “Time Search” 60
 - TIME/TEXT 35
 - TIMER 43
 - Timer List 48
 - Timer recording
 - check/change/cancel 48
 - manual setting 43
 - Rec Mode Adjust 44
 - Synchro Rec 50
 - VIDEO Plus+ 45
 - Title 35, 111
 - TITLE LIST 53
 - Title List 32, 53
 - Sort 33
 - Thumbnail 34
 - “Title Name” 66
 - Title number 35
 - “Title Search” 60
 - TOP MENU 53
 - Track 111
 - “Track Search” 60
 - Troubleshooting 96
 - Tuner System 22
 - “TV Direct Rec” 31, 91
 - “TV Guide Page” 85
 - TV Pause 58
 - TV system 82
 - “TV Type” 22, 87
 - TV/DVD switch 19
 - TV/VIDEO 31
 - TVS (TV Virtual Surround) 55
- U**
- “Unfinalize” 40
 - Unfinalizing 40
 - Usable discs 8, 10
- V**
- VIDEO CD 10
 - Video cord 14
 - “Video” 22, 88, 87
 - Video input 14
 - Video mode 8
 - VIDEO Plus+ 45
 - “Video Settings” 57
 - Visual Search 60
 - VPS 44
 - VR mode 8, 65
- Y**
- “Y NR” 57
- Z**
- ZWEITON 42

Free Manuals Download Website

<http://myh66.com>

<http://usermanuals.us>

<http://www.somanuals.com>

<http://www.4manuals.cc>

<http://www.manual-lib.com>

<http://www.404manual.com>

<http://www.luxmanual.com>

<http://aubethermostatmanual.com>

Golf course search by state

<http://golfingnear.com>

Email search by domain

<http://emailbydomain.com>

Auto manuals search

<http://auto.somanuals.com>

TV manuals search

<http://tv.somanuals.com>