

DVD Recorder

Operating Instructions

 To find out useful hints, tips and information about Sony products and services please visit: www.sony-europe.com/myproduct

RDR-HX525/HX725



WARNING

To reduce the risk of fire or electric shock, do not expose this apparatus to rain or moisture.

To avoid electrical shock, do not open the cabinet. Refer servicing to qualified personnel only.

The mains lead must be changed only at a qualified service shop.

CLASS 1 LASER PRODUCT
LASER KLASSE 1
クラス1レーザ製品

This appliance is classified as a CLASS 1 LASER product. The CLASS 1 LASER PRODUCT MARKING is located on the laser protective housing inside the enclosure.

CAUTION



The use of optical instruments with this product will increase eye hazard. As the laser beam used in this DVD recorder is harmful to eyes, do not attempt to disassemble the cabinet.

Refer servicing to qualified personnel only.

CAUTION CLASS 1 LASER AND INVISIBLE LASER RADIATION WHEN OPEN. AVOID EXPOSURE TO THE BEAM.
ATTENTION RAYONS LASER VISIBLE ET INVISIBLES DE CLASSE 1R QUAND OUVERT. ÉVITEZ L'EXPOSITION AU FASCEAU.
ADVANSSEL KLASSE 1B STRÅLOR OG OBTYNLIG LASERSTRÅLING VED ÅPNING. UNNØDIG UTSATTELSE FOR ØYER OG HUD.
VARNING KLASSE 1B STRÅLOR OG OBTYNLIG LASERSTRÅLING NÄR ÖPPEN. ÖNSKA UTSÄTTELSE FÖR ÖGONEN.
VORSICHT KLASSE 1B STRÄHL UND OBTYNLIG LASERSTRÄHLUNG BEI ÖFFNUNG. UNGEWISSER UTSATZ FÜR AUGEN UND HAUT.
PRECAUTION CLASSE 1B RAYONS LASER VISIBLES ET INVISIBLES QUAND LA COFFRETTE EST OUVERTE. ÉVITEZ L'EXPOSITION À LA FIBRE LASER.
VARO! LASERKÄSSE OLET AITAVAIN NÄKYVÄLLÄ JA NÄKYVÄTTOMALLÄ LUOKAN 1B LASERSTRÄLÄLLÄ, JÄLKAUTTO SÄTELETTÄ.
注意 ここ開くとCLASS 1Bの可視レーザー光及び不可視レーザー光が出ます。ビームを直接見たり、触れたりしないで。

This label is located on the laser protective housing inside the enclosure.

Notice for customers in the United Kingdom and Republic of Ireland

A molded plug complying with BS1363 is fitted to this equipment for your safety and convenience. Should the fuse in the plug supplied need to be replaced, a 5 AMP fuse approved by ASTA or BSI to BS1362, (i.e., marked with  or  mark) must be used. If the plug supplied with this equipment has a detachable fuse cover, be sure to attach the fuse cover after you change the fuse. Never use the plug without the fuse cover. If you should lose the fuse cover, please contact your nearest Sony service station.

Precautions

- This unit operates on 220 – 240 V AC, 50/60 Hz. Check that the unit's operating voltage is identical with your local power supply.
- To prevent fire or shock hazard, do not place objects filled with liquids, such as vases, on the apparatus.
- Install this system so that the mains lead can be unplugged from the wall socket immediately in the event of trouble.

GUIDE Plus+, VIDEO Plus+, G-LINK are (1) registered trademarks or trademarks of, (2) manufactured under license from and (3) subject of various international patents and patent applications owned by, or licensed to, Gemstar-TV Guide International, Inc. and/or its related affiliates.

GEMSTAR-TV GUIDE INTERNATIONAL, INC. AND/OR ITS RELATED AFFILIATES ARE NOT IN ANY WAY LIABLE FOR THE ACCURACY OF THE PROGRAM SCHEDULE INFORMATION PROVIDED BY THE GUIDE PLUS+ SYSTEM. IN NO EVENT SHALL GEMSTAR-TV GUIDE INTERNATIONAL, INC. AND/OR ITS RELATED AFFILIATES BE LIABLE FOR ANY AMOUNTS REPRESENTING LOSS OF PROFITS, LOSS OF BUSINESS, OR INDIRECT, SPECIAL, OR CONSEQUENTIAL DAMAGES IN CONNECTION WITH THE PROVISION OR USE OF ANY INFORMATION, EQUIPMENT, OR SERVICES RELATING TO THE GUIDE PLUS+ SYSTEM.



Disposal of Old Electrical & Electronic Equipment (Applicable in the European Union and other European countries with separate collection systems)

This symbol on the product or on its packaging indicates that this product shall not be treated as household waste. Instead it shall be handed over to the applicable collection point for the recycling of electrical and electronic equipment. By ensuring this product is disposed of correctly, you will help prevent potential negative consequences for the environment and human health, which could otherwise be caused by inappropriate waste handling of this product. The recycling of materials will help to conserve natural resources. For more detailed information about recycling of this product, please contact your local Civic Office, your household waste disposal service or the shop where you purchased the product.

Precautions

This equipment has been tested and found to comply with the limits set out in the EMC Directive using a connection cable shorter than 3 metres.

On safety

Should any solid object or liquid fall into the cabinet, unplug the recorder and have it checked by qualified personnel before operating it any further.

About the hard disk drive

The hard disk has a high storage density, which enables long recording durations and quick access to the written data. However, it can easily be damaged by shock, vibration or dust, and should be kept away from magnets. To avoid losing important data, observe the following precautions.

- Do not apply a strong shock to the recorder.
- Do not place the recorder in a location subject to mechanical vibrations or in an unstable location.
- Do not place the recorder on top of a hot surface, such as a VCR or amplifier (receiver).
- Do not use the recorder in a place subject to extreme changes in temperature (temperature gradient less than 10 °C/hour).
- Do not move the recorder with its mains lead connected.
- Do not disconnect the mains lead while the power is on.
- When disconnecting the mains lead, turn off the power and make sure that the hard disk drive is not operating (the clock is displayed in the front panel display and all recording or dubbing has stopped).
- Do not move the recorder for one minute after you have unplugged the mains lead.

- Do not attempt to replace or upgrade the hard disk by yourself, as this may result in malfunction.

If the hard disk drive should malfunction, you cannot recover lost data. The hard disk drive is only a temporary storage space.

About repairing the hard disk drive

- The contents of the hard disk drive may be checked in case of repair or inspection during a malfunction or modification. However, the contents will not be backed up or saved by Sony.
- If the hard disk needs to be formatted or replaced, it will be done at the discretion of Sony. All contents of the hard disk drive will be erased, including contents that violate copyright laws.

On power sources

- The recorder is not disconnected from the AC power source (mains) as long as it is connected to the wall outlet, even if the recorder itself has been turned off.
- If you are not going to use the recorder for a long time, be sure to disconnect the recorder from the wall outlet. To disconnect the AC power cord (mains lead), grasp the plug itself; never pull the cord.
- Before disconnecting the AC power cord (mains lead), check that the recorder's hard disk is not operating (recording or dubbing) on the front panel display.

On placement

- Place the recorder in a location with adequate ventilation to prevent heat build-up in the recorder.
- Do not place the recorder on a soft surface such as a rug that might block the ventilation holes.
- Do not place the recorder in a confined space such as a bookshelf or similar unit.
- Do not place the recorder in a location near heat sources, or in a place subject to direct sunlight, excessive dust, or mechanical shock.
- Do not place the recorder in an inclined position. It is designed to be operated in a horizontal position only.
- Keep the recorder and discs away from equipment with strong magnets, such as microwave ovens, or large loudspeakers.
- Do not place heavy objects on the recorder.

On recording

Make trial recordings before making the actual recording.

On compensation for lost recordings

Sony is not liable and will not compensate for any lost recordings or relevant losses, including when recordings are not made due to reasons including recorder failure, or when the contents of a recording are lost or damaged as a result of recorder failure or repair undertaken to the recorder. Sony will not restore, recover, or replicate the recorded contents under any circumstances.

Copyrights

- Television programmes, films, video tapes, discs, and other materials may be copyrighted. Unauthorized recording of such material may be contrary to the provisions of the copyright laws. Also, use of this recorder with cable television transmission may require authorization from the cable television transmitter and/or programme owner.
- This product incorporates copyright protection technology that is protected by U.S. patents and other intellectual property rights. Use of this copyright protection technology must be authorized by Macrovision, and is intended for home and other limited viewing uses only unless otherwise authorized by Macrovision. Reverse engineering or disassembly is prohibited.

Copy guard function

Since the recorder has a copy guard function, programmes received through an external tuner (not supplied) may contain copy protection signals (copy guard function) and as such may not be recordable, depending on the type of signal.

IMPORTANT NOTICE

Caution: This recorder is capable of holding a still video image or on-screen display image on your television screen indefinitely. If you leave the still video image or on-screen display image displayed on your TV for an extended period of time you risk permanent damage to your television screen. Plasma display panels and projection televisions are especially susceptible to this.

If you have any questions or problems concerning your recorder, please consult your nearest Sony dealer.

About this manual

Check your model name

The instructions in this manual are for 2 models: RDR-HX525 and RDR-HX725. Check your model name by looking at the front panel of the recorder.



- In this manual, the internal hard disk drive is written as "HDD," and "disc" is used as a general reference for the HDD, DVDs, or CDs unless otherwise specified by the text or illustrations.
- Icons, such as , listed at the top of each explanation indicate what kind of media can be used with the function being explained.
- Instructions in this manual describe the controls on the remote. You can also use the controls on the recorder if they have the same or similar names as those on the remote.
- The on-screen display illustrations used in this manual may not match the graphics displayed on your TV screen.
- The explanations regarding DVDs in this manual refer to DVDs created on this recorder. The explanations do not apply to DVDs that are created on other recorders and played back on this recorder.

Table of Contents

WARNING	2
Precautions	3
Quick Guide to Disc Types	8
Recordable and playable discs	8
Playable discs	10
Hookups and Settings	12
Hooking Up the Recorder	12
Step 1: Connecting the Aerial Cable and Set Top Box Controller	13
Using the set top box receiver control function	13
A: Set top box receiver with an aerial output (or aerial and SCART output)	14
B: Set top box receiver with a SCART output only	15
C: No set top box receiver	16
Step 2: Connecting the Video Cords	17
About the SMARTLINK features (for SCART connections only)	18
Step 3: Connecting the Audio Cords	19
Step 4: Connecting the Mains Lead	20
Step 5: Preparing the Remote	21
Controlling TVs with the remote	21
If you have a Sony DVD player or more than one Sony DVD recorder	22
Changing programme positions of the recorder using the remote	23
Step 6: Easy Setup	24
Setting up your set top box receiver for the GUIDE Plus+ [®] system	25
Connecting a VCR or Similar Device	27
Connecting to the LINE 3/DECODER jack	27
Connecting to the LINE 2 IN jacks on the front panel	28
Connecting a PAY-TV/Canal Plus Analogue Decoder	29
Connecting a decoder	29
Setting PAY-TV/Canal Plus analogue programme positions	30

Eight Basic Operations — Getting to Know Your DVD Recorder

















1. Inserting a Disc	32
2. Recording a Programme	32
Checking the disc status while recording	33
3. Playing the Recorded Programme (Title List)	34
4. Displaying the Playing Time and Play Information	36
Checking the remaining disc space	37
5. Changing the Name of a Recorded Programme	38
6. Labelling and Protecting a Disc	39
Labelling a disc	39
Protecting a disc	40
7. Playing the Disc on Other DVD Equipment (Finalise)	40
Finalising the disc using  (open/close) button	41
Finalising the disc using "Disc Information" display	41
Unfinalising a disc	42
8. Reformatting a disc	42

GUIDE Plus+	44
Introduction to the GUIDE Plus+ System	44
Learning the common elements	44
Troubleshooting guide	45
Watching TV using the GUIDE Plus+ System	46
Searching for a Programme using the GUIDE Plus+ System	47
Listing Up Your Favourite Programme Information (My TV)	48
Setting a profile	48
Selecting and watching a programme from My TV	49
Making changes to the GUIDE Plus+ System	49
Changing the basic GUIDE Plus+ settings	49
Changing the GUIDE Plus+ host channel	50
Checking programme positions	51
Disabling programme positions	51
<hr/>	
Timer Recording	52
Before Recording	52
Recording mode	52
Recording stereo and bilingual programmes	53
Unrecordable pictures	53
Timer Recording (GUIDE Plus+/VIDEO Plus+/Manual)	54
One Button Recording (GUIDE Plus+)	54
Recording TV programmes using the VIDEO Plus+ system	55
Setting the timer manually	56
Using the Quick Timer function	57
Adjusting the recording picture quality and size	58
Creating chapters in a title	59
Checking/Changing/Canceling Timer Settings	59
Changing timer settings	59
Canceling timer settings	61
Recording From Connected Equipment	61
Recording from connected equipment with a timer (Synchro Rec)	61
Recording from connected equipment without a timer	63
<hr/>	
Playback	64
Playing	64
Playback options	66
Adjusting the picture quality	67
Adjusting the delay between the picture and sound (AV SYNC)	68
Pausing a TV Broadcast (TV Pause)	68
Playing from the beginning of the programme you are recording (Chasing Playback)	69
Playing a previous recording while making another (Simultaneous Rec and Play)	69
Searching for a Title/Chapter/Track, etc.	70
Playing MP3 Audio Tracks or JPEG Image Files	71
About MP3 audio tracks and JPEG image files	72
MP3 audio tracks or JPEG image files that the recorder can play	72
About playback order of albums, tracks, and files	73

Erasing and Editing	74
Before Editing	74
Erasing and Editing a Title	75
Erasing multiple titles (Erase Titles)	76
Erasing a section of a title (A-B Erase)	76
Dividing a title (Divide)	77
Creating chapters manually	78
Creating and Editing a Playlist	78
Moving a Playlist title (Change Order)	80
Combining multiple Playlist titles (Combine)	81
Dividing a Playlist title (Divide)	81
<hr/>	
Dubbing (HDD ↔ DVD)	82
Before Dubbing	82
About "Dub Mode"	82
Dubbing	85
Dubbing a single title (Title Dubbing)	85
Dubbing multiple titles (Dub Selected Titles)	86
<hr/>	
DV Dubbing	88
Before DV Dubbing	88
Preparing for DV dubbing	88
Recording an Entire DV Format Tape (One Touch Dubbing)	90
Program Edit	91
<hr/>	
Settings and Adjustments	93
Aerial Reception and Language Settings (Basic)	93
Channel Setting	93
Channel Sort	95
Auto Programme Title Labelling (TV Guide Page)	95
Clock	96
OSD (On-Screen Display)	97
Video Settings (Video)	97
Audio Settings (Audio)	100
Recording Settings (Recording)	102
Disc Settings (DVD)	103
Remote Control Settings/Factory Settings (Others)	105
Easy Setup (Resetting the Recorder)	106
<hr/>	
Additional Information	107
Troubleshooting	107
Self-diagnosis Function (When letters/numbers appear in the display) ..	114
Notes About This Recorder	114
Specifications	115
About i.LINK	116
Guide to Parts and Controls	118
Language Code List	121
Area Code	121
Index	122

Quick Guide to Disc Types

Recordable and playable discs

Type		Disc Logo	Icon used in this manual	Formatting (new discs)	Compatibility with other DVD players (finalising)
Hard disk drive (internal)				Formatting unnecessary	Dub HDD contents to a DVD to play on other DVD players
DVD+RW		 DVD + ReWritable  DVD + ReWritable High Speed		Automatically formatted in +VR mode (DVD+RW VIDEO)	Playable on DVD+RW compatible players (automatically finalised)
DVD-RW	VR mode			Format in VR mode (page 32)	Playable only on VR mode compatible players (finalisation unnecessary)
	Video mode	 		Format in Video mode (page 32)	Playable on most DVD players (finalisation necessary) (page 40)
DVD+R				Automatically formatted in +VR mode (DVD+R VIDEO)	Playable on most DVD players (finalisation necessary) (page 40)
DVD+R DL					
DVD-R	VR mode			Format in VR mode (page 32) *1 Formatting is performed using the "Disc Information" display.	Playable only on DVD-R in VR mode compatible players (finalisation necessary) (page 40)
	Video mode			Automatically formatted in Video mode	Playable on most DVD players (finalisation necessary) (page 40)

Usable disc versions (as of March 2006)

- 8x-speed or slower DVD+RWs
- 6x-speed or slower DVD-RWs (Ver.1.1, Ver.1.2 with CPRM^{*2})
- 16x-speed or slower DVD+Rs
- 16x-speed or slower DVD-Rs (Ver.2.0, Ver.2.1 with CPRM^{*2})
- 8x-speed or slower DVD+R DL (Double Layer) discs

“DVD+RW,” “DVD-RW,” “DVD+R,” “DVD+R DL,” and “DVD-R” are trademarks.









^{*1} When an unformatted DVD-R is inserted into this recorder, it is automatically formatted in Video mode. To format a new DVD-R in VR mode, format using the “Disc Information” display (page 32).

^{*2} CPRM (Content Protection for Recordable Media) is a coding technology that protects copyrights for images.

Discs that cannot be recorded on

- 8 cm discs
- DVD-R DL (Dual Layer) discs

Playable discs

Type	Disc Logo	Icon used in this manual	Characteristics
DVD VIDEO			Discs such as movies that can be purchased or rented This recorder also recognizes DVD-R Dual Layer (Video mode) discs as DVD Video compatible discs.
VIDEO CD			VIDEO CDs or CD-Rs/CD-RWs in VIDEO CD/Super VIDEO CD format
CD			Music CDs or CD-Rs/CD-RWs in music CD format
DATA DVD	—		DVD+RWs/DVD+Rs/DVD-RWs/ DVD-Rs/DVD-ROMs containing JPEG image files
DATA CD	—		CD-ROMs/CD-Rs/CD-RWs containing either MP3 audio tracks or JPEG image files
8 cm DVD+RW/ DVD-RW/DVD-R	—	—	8 cm DVD+RW, DVD-RW, and DVD-R recorded with a DVD video camera (Still images recorded with a DVD video camera cannot be played.)

“DVD VIDEO” and “CD” are trademarks.

Discs that cannot be played

- PHOTO CDs
- CD-ROMs/CD-Rs/CD-RWs that are recorded in a format different from the formats mentioned in the table above.
- Data part of CD-Extras
- DVD-ROMs/DVD+RWs/DVD-RWs/
DVD+Rs/DVD-Rs that do not contain DVD Video or JPEG image files.
- DVD Audio discs
- DVD-RAMs
- HD layer on Super Audio CDs
- DVD VIDEOS with a different region code (page 11).
- DVDs that were recorded on a different recorder and not correctly finalised.

Maximum recordable number of titles

Disc	Number of titles*
HDD	300
DVD-RW/DVD-R	99
DVD+RW/DVD+R	49
DVD+R DL	49

* The maximum length for one title is eight hours.

Note on playback operations of DVD VIDEOS/VIDEO CDs

Some playback operations of DVD VIDEOS/VIDEO CDs may be intentionally set by software producers. Since this recorder plays DVD VIDEOS/VIDEO CDs according to the disc contents the software producers designed, some playback features may not be available. See the instructions supplied with the DVD VIDEOS/VIDEO CDs.

Region code (DVD VIDEO only)

Your recorder has a region code printed on the rear of the unit and will only play DVD VIDEOS (playback only) labelled with identical region codes. This system is used to protect copyrights.

DVD VIDEOS labelled  will also play on this recorder.

If you try to play any other DVD VIDEO, the message "Playback prohibited by region code." will appear on the TV screen.

Depending on the DVD VIDEO, no region code indication may be labelled even though playing the DVD VIDEO is prohibited by area restrictions.



Region code

Music discs encoded with copyright protection technologies

This product is designed to play back discs that conform to the Compact Disc (CD) standard.

Recently, various music discs encoded with copyright protection technologies are being marketed by some record companies. Please be aware that among those discs, there are some that do not conform to the CD standard and may not be playable by this product.

Note on DualDiscs

A DualDisc is a two sided disc product which mates DVD recorded material on one side with digital audio material on the other side. However, since the audio material side does not conform to the Compact Disc (CD) standard, playback on this product is not guaranteed.

Notes

- Some DVD+RWs/DVD+Rs, DVD-RWs/DVD-Rs, or CD-RWs/CD-Rs cannot be played on this recorder due to the recording quality or physical condition of the disc, or the characteristics of the recording device and authoring software. The disc will not play if it has not been correctly finalised. For more information, see the operating instructions for the recording device.
- You cannot mix VR mode and Video mode on the same DVD-RW. To change the disc's format, reformat the disc (page 42). Note that the disc's contents will be erased after reformatting.
- You cannot shorten the time required for recording even with high-speed discs.
- It is recommended that you use discs with "For Video" printed on their packaging.
- You cannot add new recordings to DVD+Rs, DVD-Rs, or DVD-RWs (Video mode) that contain recordings made on other DVD equipment.
- In some cases, you may not be able to add new recordings to DVD+RWs that contain recordings made on other DVD equipment. If you do add a new recording, note that this recorder will rewrite the DVD menu.
- You cannot edit recordings on DVD+RWs, DVD-RWs (Video mode), DVD+Rs, or DVD-Rs that are made on other DVD equipment.
- If the disc contains PC data unrecognizable by this recorder, the data may be erased.
- You may not be able to record on some recordable discs, depending on the disc.

Hooking Up the Recorder

Follow steps 1 through 6 to hook up and adjust the settings of the recorder. Do not connect the mains lead until you reach “Step 4: Connecting the Mains Lead” on page 20.

Notes

- See “Specifications” (page 115) for a list of supplied accessories.
- Plug in cords securely to prevent unwanted noise.
- Refer to the instructions supplied with the components to be connected.
- You cannot connect this recorder to a TV that does not have a SCART or video input jack.
- Be sure to disconnect the mains lead of each component before connecting.

Step 1: Connecting the Aerial Cable and Set Top Box Controller

Select one of the following aerial hookups. Do NOT set “Line3 Input” of the “Scart Setting” to “Decoder” in the “Video” setup (page 99) when making connection A or B.

If you have	Hookup
Set top box receiver with an aerial output (or aerial and SCART output)	A (page 14)
Set top box receiver with a SCART output only	B (page 15)
No set top box receiver	C (page 16)

If the set top box receiver can output RGB signals

This recorder accepts RGB signals. If the set top box receiver can output RGB signals, connect the TV SCART connector on the set top box receiver to the LINE 3/DECODER jack, and set “Line3 Input” of “Scart Setting” to “Video/RGB” in the “Video” setup (page 98). Note that this connection and setup disable the SMARTLINK function. If you want to use the SMARTLINK function with a compatible set top box receiver, see the instructions supplied with the set top box receiver.

If you want to use the Synchro Rec function

A SCART connection between the set top box receiver and the recorder is necessary to use the Synchro-Recording function. See “Recording from connected equipment with a timer (Synchro Rec)” on page 61.

Set “Line3 Input” of “Scart Setting” in the “Video” setup (page 98) according to the specifications of your set top box receiver. See your set top box receiver’s instructions for more information.

If you are using a B Sky B tuner, be sure to connect the tuner’s VCR SCART jack to the LINE 3/DECODER jack. Then set “Line3 Input” of “Scart Setting” according to the specifications of the VCR SCART jack on your set top box receiver.

Using the set top box receiver control function

The set top box receiver control function can be used with hookup A or B. It allows the recorder to control a set top box receiver via the supplied set top box controller. The recorder controls programme positions on the set top box receiver for timer recording. You can also use the recorder’s remote control to change programme positions on the set top box receiver whenever the set top box receiver and recorder are turned on.

To use the set top box receiver control function, you need to connect the set top box controller (page 24). After setting up the set top box receiver control, check that the recorder can correctly control the set top box receiver (page 25).

Notes

- If your aerial is a flat cable (300-ohm twin lead cable), use an external aerial connector (not supplied) to connect the aerial to the recorder.
- If you have separate cables for AERIAL antennas, use an AERIAL UHF/VHF band mixer (not supplied) to connect the aerial to the recorder.
- Synchro-Recording does not work with some tuners. For details, see the tuner’s operating instructions.
- If you disconnect the recorder’s mains lead, you will not be able to view the signals from the connected set top box receiver.

A: Set top box receiver with an aerial output (or aerial and SCART output)

With this hookup, you can record any programme position on the set top box receiver. To watch cable programmes, you need to match the programme position on the recorder to the aerial output programme position on the cable box.

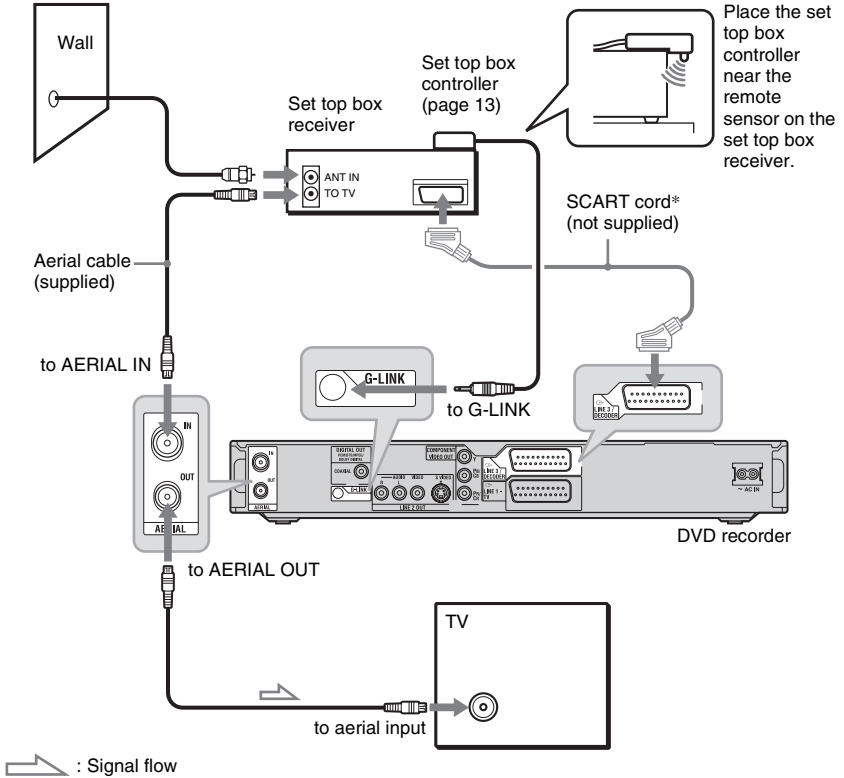

* Connect only if your set top box receiver has a SCART connection.

B: Set top box receiver with a SCART output only

With this hookup, you can record any programme position on the set top box receiver. Be sure that the set top box receiver is turned on.

To watch cable or satellite programmes, you need to match the programme position on the recorder to the input jack connected to the set top box receiver (→ LINE 3/DECODER).

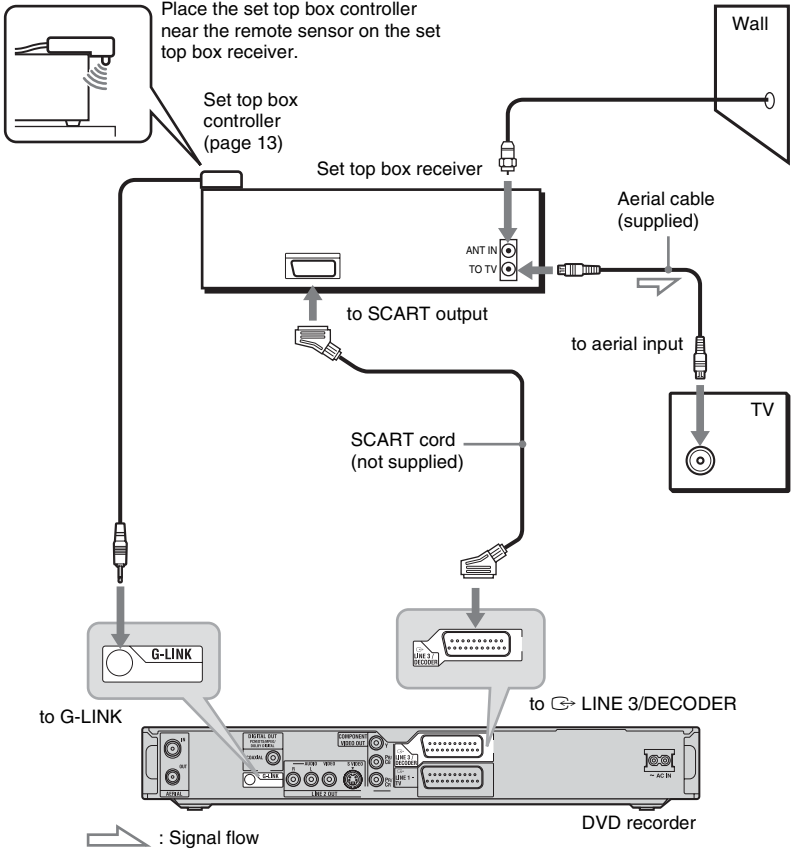

C: No set top box receiver

Use this hookup if you watch cable programme position without a cable box. Also use this hookup if you are connecting just an aerial antenna.

With this hookup, you can record any programme position by selecting the programme position on the recorder.

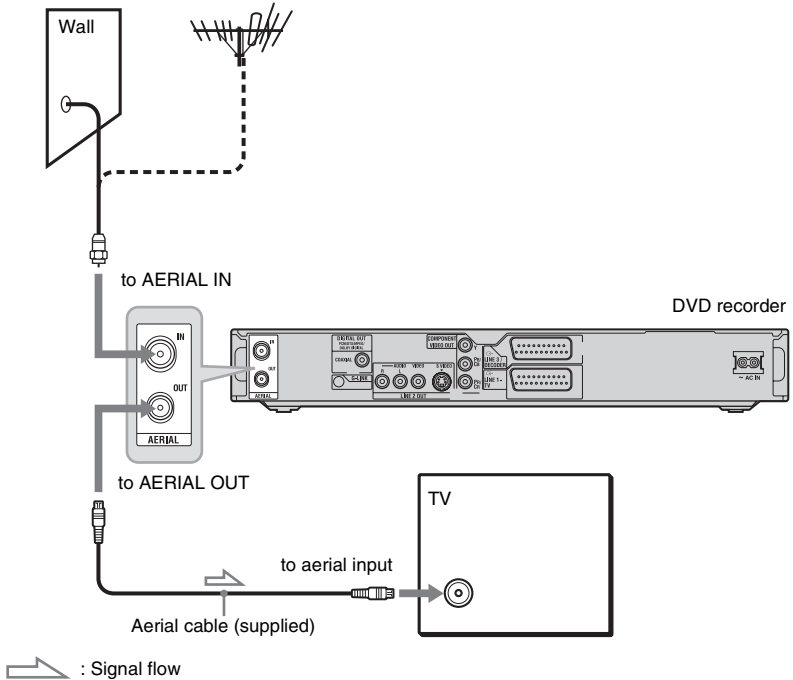

Step 2: Connecting the Video Cords

Select one of the following patterns, **A** through **D**, according to the input jack on your TV monitor, projector, or AV amplifier (receiver). This will enable you to view pictures.

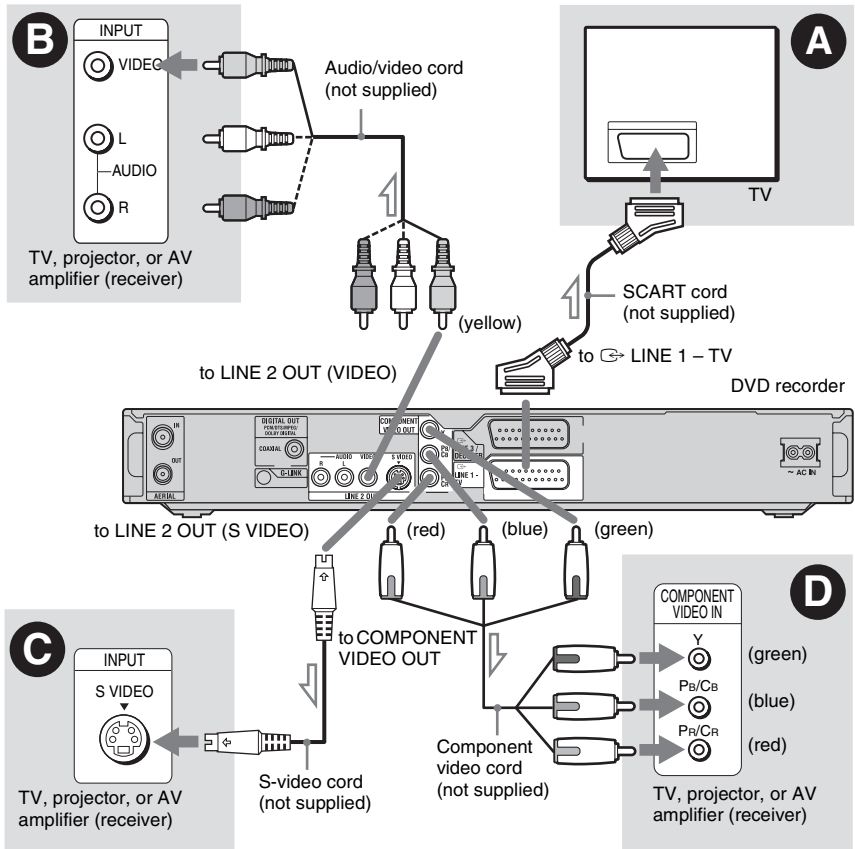

: Signal flow

A SCART input jack

When you set “Easy Setup - Line1 Output” to “S Video” or “RGB” (page 24), use a SCART cord that conforms to the selected signal.

B Video input jack

You will enjoy standard quality images.

C S VIDEO input jack

You will enjoy high quality images.

D Component video input jacks (Y, Pb/Cb, Pr/Cr)

You will enjoy accurate colour reproduction and high quality images.

If your TV accepts progressive 525p/625p format signals, you must use this connection and set “Component Out” in the “Video” setup to “On” (page 98). Then set “Progressive Output” of the “Video Output” to “On” in the “Video” setup to send progressive video signals. For details, see “Progressive Output” on page 98.

When playing “wide screen” images

Some recorded images may not fit your TV screen. To change the picture size, see page 97.

If you are connecting to a VCR

Connect your VCR to the LINE 3/ DECODER jack on the recorder (page 27).

Notes

- Do not connect more than one type of video cord between the recorder and your TV at the same time.
- When you connect the recorder to your TV via the SCART jacks, the TV's input source is set to the recorder automatically when you start playback. If necessary, press TV  to return the input to the TV.
- For correct SMARTLINK connection, you will need a SCART cord that has the full 21 pins. Refer to your TV's instruction manual as well for this connection.
- If you connect this recorder to a TV with SMARTLINK, set “Easy Setup - Line1 Output” to “Video.”

About the SMARTLINK features (for SCART connections only)

If the connected TV (or other connected equipment such as a set top box) complies with SMARTLINK, NexTView Link^{*3}, MEGALOGIC^{*1}, EASYLINK^{*2}, CINEMALINK^{*2}, Q-Link^{*3}, EURO VIEW LINK^{*4}, or T-V LINK^{*5}, you can enjoy the following SMARTLINK features.

- Preset Download
You can download the tuner preset data from your TV to this recorder, and tune the recorder according to that data in “Easy Setup.” This greatly simplifies the “Easy Setup” procedure. Be careful not to disconnect the cables or exit the “Easy Setup” function during this procedure (page 24).
- TV Direct Rec
You can easily record what you are watching on your TV (page 33).
- One Touch Play
You can turn on the recorder and TV, set the TV's input to the recorder, and start playback with one touch of the  (play) button (page 65).

- One Touch Menu
You can turn on the recorder and TV, set the TV to the recorder's programme position, and display the Title List menu with one touch of the TITLE LIST button (page 65).
- One Touch EPG
You can turn on the recorder and TV, set the TV to the recorder's programme position, and display the GUIDE Plus+ system “Home Screen” with one touch of the TV GUIDE button on the remote.
- Automatic Power Off
The recorder will turn off automatically if the recorder is not used after you turn off the TV.
- NexTView Download
You can easily set the timer by using the NexTView Download function on your TV. See your TV's instruction manual.

^{*1} “MEGALOGIC” is a registered trademark of Grundig Corporation.

^{*2} “EASYLINK” and “CINEMALINK” are trademarks of Philips Corporation.

^{*3} “Q-Link” and “NexTView Link” are trademarks of Panasonic Corporation.

^{*4} “EURO VIEW LINK” is a trademark of Toshiba Corporation.

^{*5} “T-V LINK” is a trademark of JVC Corporation.

Hint

SMARTLINK also works with TVs or other equipment having EPG Timer Control, EPG Title Download, and Now Recording functions. For details, refer to the operating instructions supplied with your TV or other equipment.

Notes

- The SMARTLINK features are available only when “Video” is selected in “Line1 Output.”
- The power must be turned on to use all SMARTLINK features except One Touch Play, One Touch Menu and One Touch EPG.
- Not all TVs respond to the functions above.

Step 3: Connecting the Audio Cords

Select one of the following patterns, **A** or **B**, according to the input jack on your TV monitor, projector, or AV amplifier (receiver). This will enable you to listen to sound.

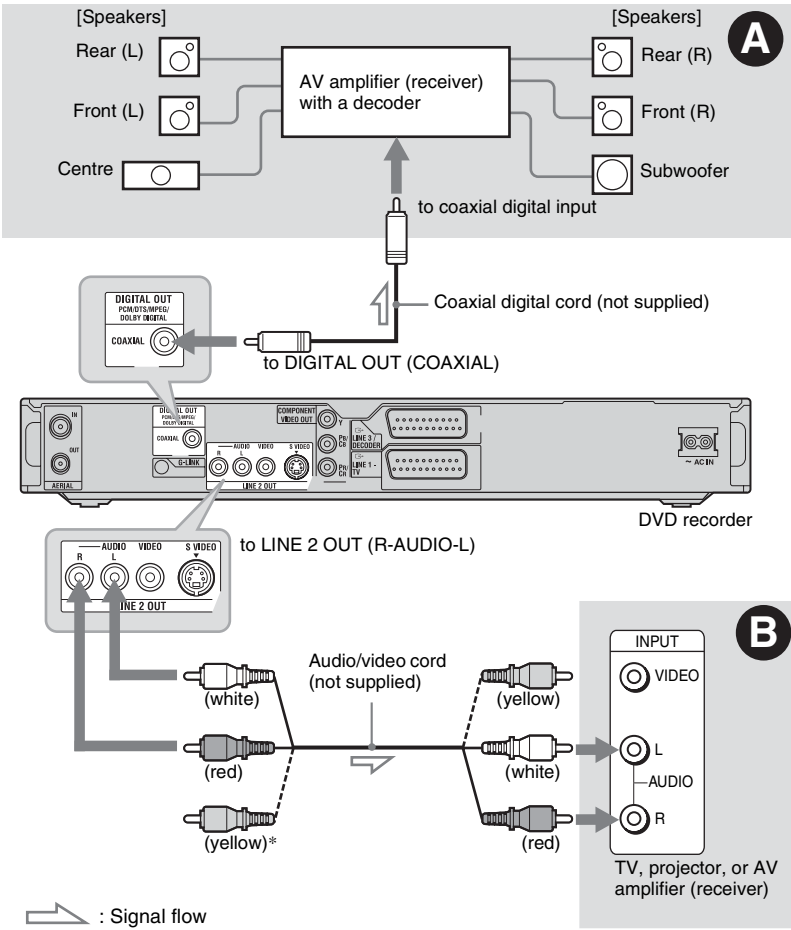

* The yellow plug is used for video signals (page 17).

A Digital audio input jack

If your AV amplifier (receiver) has a Dolby[®] Digital[®], DTS[®], or MPEG audio decoder and a digital input jack, use this connection. You can enjoy Dolby Digital (5.1ch), DTS (5.1ch), and MPEG audio (5.1ch) surround effects.

B Audio L/R (left/right) input jacks

This connection will use your TV's or stereo amplifier's (receiver's) two speakers for sound.

Hint

For correct speaker location, see the operating instructions supplied with the connected components.

⚡ Notes

- Do not connect your TV's audio output jacks to the LINE IN (R-AUDIO-L) jacks at the same time. This will cause unwanted noise to come from your TV's speakers.
- With connection **B**, do not connect the LINE IN (R-AUDIO-L) and LINE 2 OUT (R-AUDIO-L) jacks to your TV's audio output jacks at the same time. This will cause unwanted noise to come from your TV's speakers.
- With connection **A**, after you have completed the connection, make the appropriate settings under "Easy Setup - Audio Connection" (page 24). Otherwise, no sound or a loud noise will come from your speakers.

*1 Manufactured under license from Dolby Laboratories.
"Dolby" and the double-D symbol are trademarks of Dolby Laboratories.

*2 "DTS" and "DTS Digital Out" are trademarks of Digital Theater Systems, Inc.

Step 4: Connecting the Mains Lead

Connect the supplied mains lead to the AC IN terminal of the recorder. Then plug the recorder and TV mains leads (power cords) into the mains. After you connect the mains lead, **you must wait for a short while before operating the recorder.** You can operate the recorder once the front panel display lights up and the recorder enters standby mode.

If you connect additional equipment to this recorder (page 27), be sure to connect the mains lead after all connections are complete.

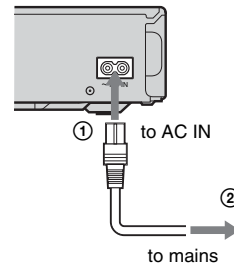

Step 5: Preparing the Remote

You can control the recorder using the supplied remote. Insert two R6 (size AA) batteries by matching the ⊕ and ⊖ ends on the batteries to the markings inside the battery compartment. When using the remote, point it at the remote sensor  on the recorder.

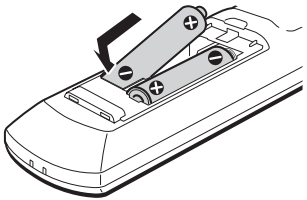

Notes

- If the supplied remote interferes your other Sony DVD recorder or player, change the command mode number for this recorder (page 22).
- Use the batteries correctly to avoid possible leakage and corrosion. Should leakage occur, do not touch the liquid with bare hands. Observe the following:
 - Do not use a new battery with an old battery, or batteries of different manufacturers.
 - Do not attempt to recharge the batteries.
 - If you do not intend to use the remote for an extended period of time, remove the batteries.
 - If battery leakage occurs, wipe out any liquid inside the battery compartment, and insert new batteries.
- Do not expose the remote sensor (marked  on the front panel) to strong light, such as direct sunlight or a lighting apparatus. The recorder may not respond to the remote.

Controlling TVs with the remote

You can adjust the remote's signal to control your TV.

Notes

- Depending on the connected unit, you may not be able to control your TV with some or all of the buttons below.
- If you enter a new code number, the code number previously entered will be erased.
- When you replace the batteries of the remote, the code number may be reset to the default setting. Set the appropriate code number again.

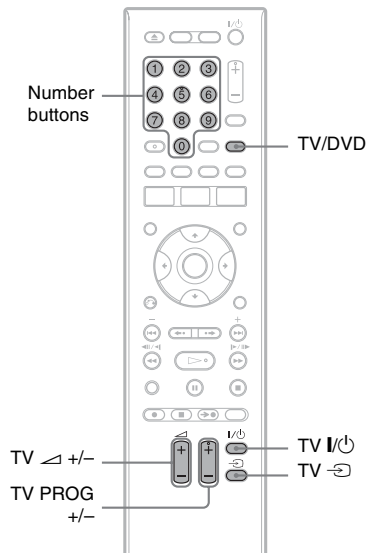

- 1 Hold down the TV I/O button located at the bottom of the remote.**
Do not press the I/O button at the top of the remote.

2 With the TV I/O button pressed down, enter the TV's manufacturer code using the number buttons.

For instance, to enter "09," press "0" then "9." After you enter the last number, release the TV I/O button.

Code numbers of controllable TVs

If more than one code number is listed, try entering them one at a time until you find the one that works with your TV.

Manufacturer	Code number
Sony	01 (default)
Hitachi	24
JVC	33
Panasonic	17, 49
Philips	06, 08
Samsung	71
Sanyo	25
Thomson	43
Toshiba	38

The remote performs the following:

Buttons	Operations
TV I/O	Turns your TV on or off
TV ∇ (volume) +/-	Adjusts the volume of your TV
TV PROG +/-	Selects the programme position on your TV
TV \rightarrow	Switches your TV's input source

To operate the TV/DVD button (for SCART connections only)

The TV/DVD button switches between the recorder and the last input source selected on the TV. Point your remote at the recorder when using this button.

When you connect the recorder to the TV via the SCART jacks, the input source for the TV is set to the recorder automatically when you start playback. To watch another source, press the TV/DVD button to switch the TV's input source.

If you have a Sony DVD player or more than one Sony DVD recorder

If the supplied remote interferes with your other Sony DVD recorder or player, set the command mode number for this recorder and the supplied remote to one that differs from the other Sony DVD recorder or player after you have completed "Step 6: Easy Setup." The default command mode setting for this recorder and the supplied remote is DVD3.

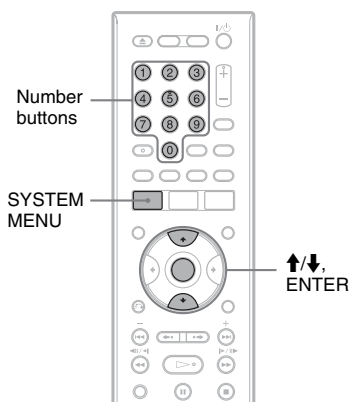

- 1 Check that "Easy Setup" (page 24) has been finished. If "Easy Setup" has not been finished, first perform "Easy Setup."
- 2 Press SYSTEM MENU. The System Menu appears.
- 3 Select "SETUP," and press ENTER.

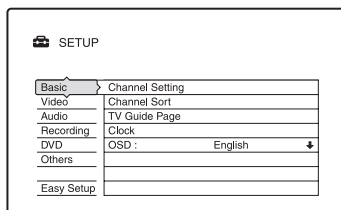

4 Select “Others,” and press ENTER.

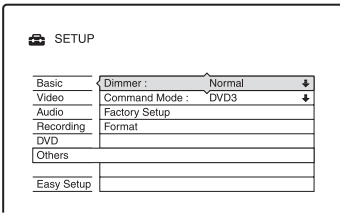

5 Select “Command Mode,” and press ENTER.

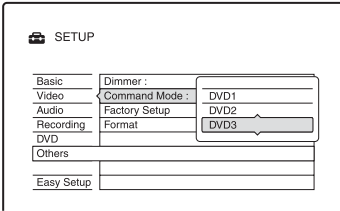

6 Select a Command Mode (DVD1, DVD2, or DVD3), and press ENTER.

7 Set the Command Mode for the remote so it matches the Command Mode for the recorder you set above.

Follow the steps below to set the Command Mode on the remote.

- ① Hold down ENTER.
- ② While holding down ENTER, enter the Command Mode code number using the number buttons.

Command Mode	Code number
DVD1	number button 1
DVD2	number button 2
DVD3	number button 3

- ③ Hold down both the number and ENTER buttons at the same time for more than three seconds.

If the Command Mode for the recorder has not been changed, set the Command Mode for the remote to the default setting of DVD3. If the Command Mode for the remote is changed to DVD1 or DVD2, you will be unable to operate this recorder.

Changing programme positions of the recorder using the remote

You can change programme positions of the recorder using the number buttons.

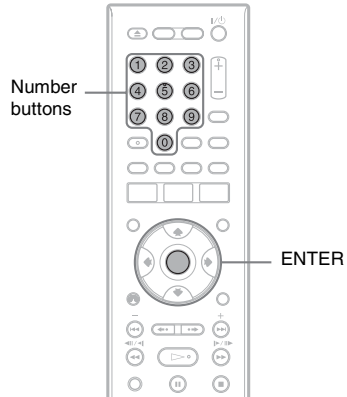

Example: for channel 50
Press “5,” “0,” then press ENTER.

To check the Command Mode for the recorder

Press **■** on the recorder when the recorder is turned off. The Command Mode for the recorder appears in the front panel display.

Step 6: Easy Setup

Make the basic adjustments by following the on-screen instructions in "Easy Setup."

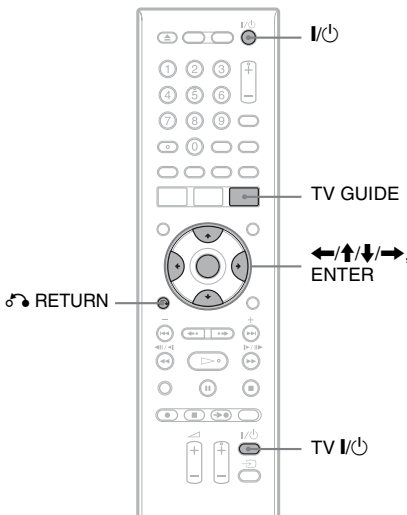

1 Turn on the recorder and your TV. Then switch the input selector on your TV so that the signal from the recorder appears on your TV screen.

The initial settings message appears.

- If this message does not appear, select "Easy Setup" from "SETUP" in the System Menu ("Settings and Adjustments" on page 93).

2 Press ENTER.

Follow the on-screen instructions to make the following settings.

◆ Easy Setup - OSD

Select a language for the on-screen displays.

◆ Easy Setup - Tuner System

Select your country/region or language. The programme position order will be set according to the country/region you set. To set the programme positions manually, see page 93.

- If you live in a French speaking country that is not listed on the display, select "ELSE - English."

◆ Easy Setup - Postal Code

Enter your postal code using the number buttons or $\leftarrow/\uparrow/\downarrow/\rightarrow$, and press ENTER.

To erase a number, move the cursor to the number, and press $\leftarrow/\uparrow/\downarrow/\rightarrow$ RETURN.

Note that the option for entering your Postal Code only appears if you select one of the following tuner systems in the step above:

UK, B, NL, D, E, I, CH, A.

◆ Easy Setup - Clock

The recorder will automatically search for a clock signal. If a clock signal cannot be found, set the clock manually using $\leftarrow/\uparrow/\downarrow/\rightarrow$, and press ENTER.

◆ Easy Setup - TV Type (page 97)

If you have a wide-screen TV, select "16:9." If you have a standard TV, select either "4:3 Letter Box" (shrink to fit) or "4:3 Pan Scan" (stretch to fit). This will determine how "wide-screen" images are displayed on your TV.

◆ Easy Setup - Component Out

If you are using the COMPONENT VIDEO OUT jack, select "On."

◆ Easy Setup - Line3 Input

If you plan to connect a decoder such as a PAY-TV/Canal Plus analogue decoder to the LINE 3/DECODER jack, select "Yes."

◆ Easy Setup - Line1 Output

To output video signals, select "Video."

To output S video signals, select "S Video."

To output RGB signals, select "RGB." Select "Video" to enjoy the SMARTLINK features.

- If you set "Easy Setup - Component Out" to "On," you cannot select "RGB."
- If you set "Easy Setup - Line3 Input" to "Yes," you cannot select "S Video."

◆ Easy Setup - Audio Connection

If you connected an AV amplifier (receiver) using a coaxial cord, select "Yes : DIGITAL OUT" and set the digital output signal (page 100).

- 3 Press ENTER when “Finish” appears.**
“Easy Setup” is finished.

To receive Guide Plus+ system data your recorder must be turned off when not in use. If your recorder is connected to a set top box receiver, be sure to leave the set top box receiver turned on. After initial setup, it may take up to 24 hours to begin receiving TV programme listings.

To return to the previous step



Press  RETURN.

Hints

- If your AV amplifier (receiver) has an MPEG audio decoder, set “MPEG” to “MPEG” (page 100).
- If you want to run “Easy Setup” again, select “Easy Setup” from “SETUP” in the System Menu (page 106).

Setting up your set top box receiver for the GUIDE Plus+® system

Follow the steps below to set up your set top box receiver for the GUIDE Plus+ system. Note that the OSD language, Clock, Country and Postal Code are all set for the GUIDE Plus+ system when Easy Setup is completed.

- 1 Press TV GUIDE.**
The GUIDE Plus+ system “Home Screen” appears.
- 2 Select “Setup” in the Menu Bar using , and press ENTER.**
The GUIDE Plus+ setup menu appears.
- 3 Select “Basic Setup” using , and press ENTER.**
- 4 Select “External Receiver 1,” and press ENTER.**
You can also select “External Receiver 2” or “External Receiver 3” if you have connected additional set top box receivers.

- 5 Press ENTER to select “Continue.”**

- 6 Select the set top box receiver type using , and press ENTER.**

- 7 Select the provider using , and press ENTER.**

If you select “None,” you can select a receiver brand from a list of all available brands.

- 8 Select the receiver brand using , and press ENTER.**

If your receiver brand is not on the list, select “???.”

The receiver brand list is automatically updated, so your receiver may be available at a later date. Select your brand when it becomes available. Until then, use “???.”

- 9 Select the connection you used for your set top box receiver using , and press ENTER.**

When the set top box receiver is connected to the recorder using hookup A or C, select “Antenna.” When the set top box receiver is connected to the recorder using hookup B, select “Line3.” The display asks for confirmation.

- 10 Press ENTER to select “Continue.”**

The Video Window switches to the specified programme position.

- 11 Select “YES” using , and press ENTER.**

The display asks for confirmation.

If the Video Window does not switch to the specified programme position, select “NO” and press ENTER until the Video Window switches to the specified programme position.

If you cannot get the recorder to control your set top box receiver

Check the connection and position of the set top box controller (page 14).

If your set top box receiver still does not operate with this recorder, refer to the instructions supplied with your set top box receiver and contact your cable or satellite company to see if they can provide you with a compatible set top box receiver.

Notes

- The list of external receivers controllable by the GUIDE Plus+ system is updated constantly and is distributed through GUIDE Plus+ system data signals. Since the time your recorder has been produced and the time you installed your recorder for the first time, new external receiver codes might have been added.
- If the external receiver is still not on the list or is not controlled properly by the recorder, please call Customer Support to report the brand and model of your external receiver.

To fix the set top box controller to your set top box receiver

Once you have confirmed that the set top box controller controls your set top box receiver, fix it in place.

- 1 Remove the backing on the double-sided tape.

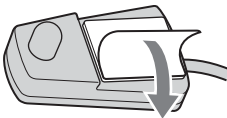

- 2 Attach it so that the set top box controller is directly above the remote control sensor on your set top box receiver.

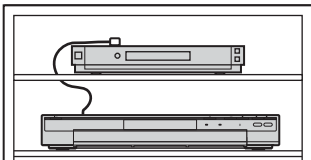

Connecting a VCR or Similar Device

After disconnecting the recorder's mains lead from the mains, connect a VCR or similar recording device to the LINE IN jacks of this recorder.

Use the DV IN jack on the front panel if the equipment has a DV output jack (i.LINK jack) (page 88).

For details, refer to the instruction manual supplied with the connected equipment.

To record on this recorder, see "Recording from connected equipment without a timer" on page 63.

Connecting to the LINE 3/DECODER jack

Connect a VCR or similar recording device to the LINE 3/DECODER jack of this recorder.

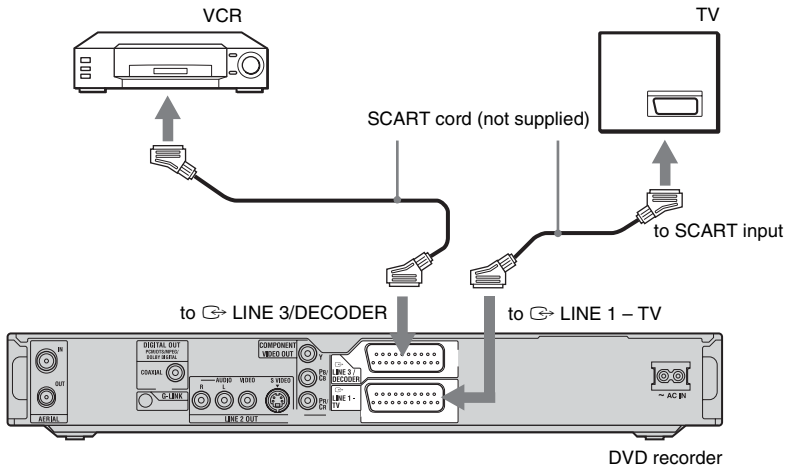

Notes

- Pictures containing copy protection signals that prohibit any copying cannot be recorded.
- If you pass the recorder signals through a VCR, you may not receive a clear image on your TV screen.



Be sure to connect your VCR to the DVD recorder and to your TV in the order shown below. To watch video tapes, watch the tapes through a second line input on your TV.

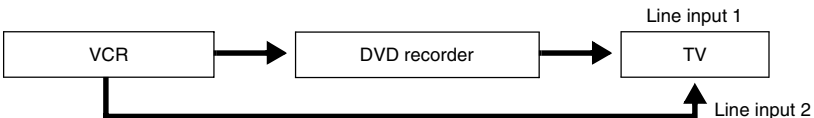

- The SMARTLINK features are not available for devices connected via the DVD recorder's LINE 3/DECODER jack.
- When you record to a VCR from this DVD recorder, do not switch the input source to TV by pressing the TV/DVD button on the remote.
- If you disconnect the recorder's mains lead, you will not be able to view the signals from the connected VCR.

Connecting to the LINE 2 IN jacks on the front panel

Connect a VCR or similar recording device to the LINE 2 IN jacks of this recorder. If the equipment has an S-video jack, you can use an S-video cord instead of an audio/video cord.

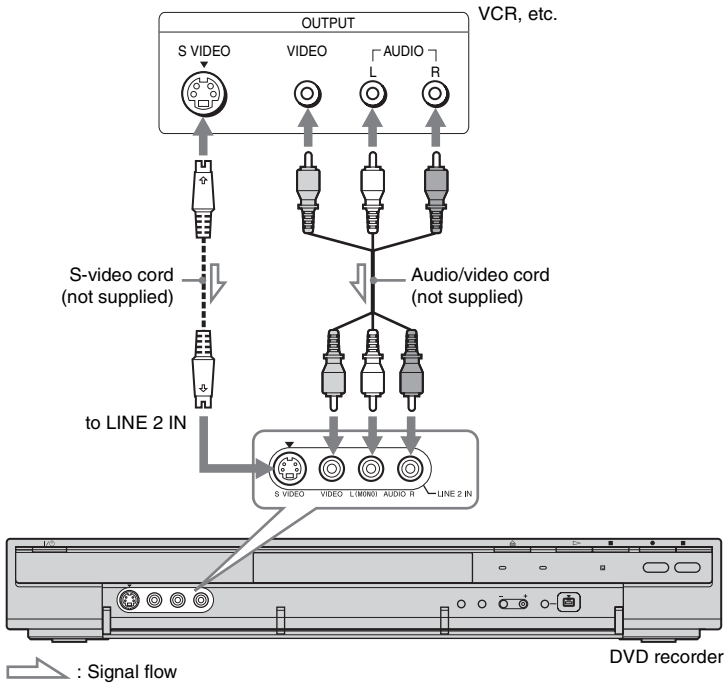

Hint

When the connected equipment outputs only monaural sound, connect to just the L(MONO) and VIDEO input jacks on the front of the recorder. Do not connect the R input jack.

Notes

- Do not connect the yellow LINE IN (VIDEO) jack when using an S-video cord.
- Do not connect the output jack of this recorder to another equipment's input jack with the other equipment's output jack connected to the input jack of this recorder. This may cause noise (feedback).
- Do not connect more than one type of video cord between the recorder and your TV at the same time.

Connecting a PAY-TV/Canal Plus Analogue Decoder

You can watch or record PAY-TV/Canal Plus analogue decoder programmes if you connect a decoder (not supplied) to the recorder. Disconnect the recorder's mains lead from the mains when connecting the decoder. Note that when you set "Line3 Input" to "Decoder" in step 5 of "Setting PAY-TV/Canal Plus analogue programme positions" (page 30), you will not be able to select "L3" because Line 3 will become a dedicated line for the decoder.

Connecting a decoder

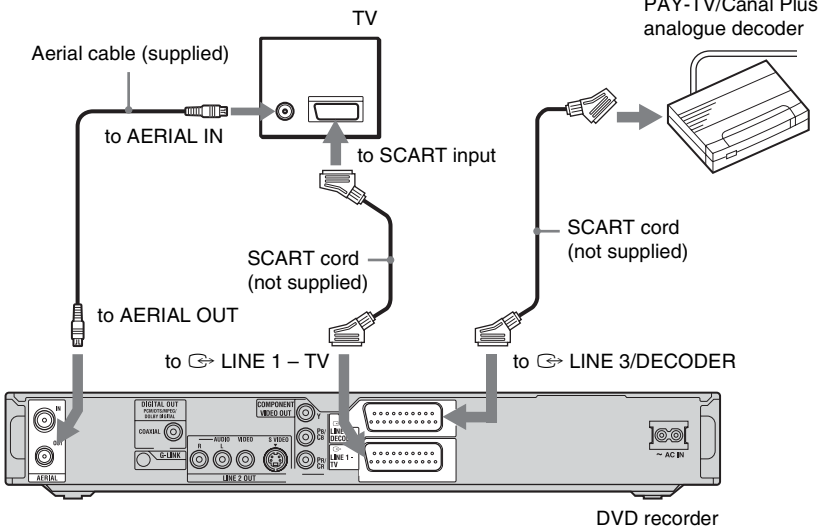

Setting PAY-TV/Canal Plus analogue programme positions

To watch or record PAY-TV/Canal Plus analogue programmes, set your recorder to receive the programme positions using the on-screen display.

In order to set the programme positions correctly, be sure to follow all of the steps below.

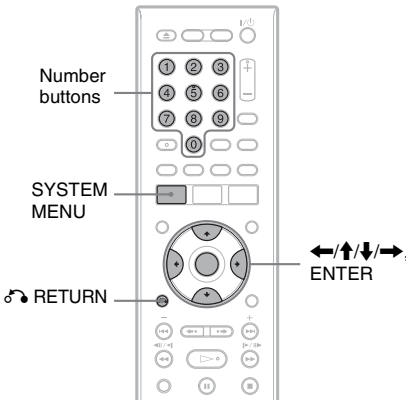

- 1 Press **SYSTEM MENU**.
The System Menu appears.
- 2 Select **"SETUP,"** and press **ENTER**.

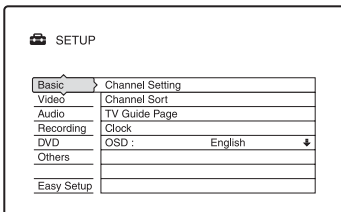

- 3 Select **"Video,"** and press **ENTER**.

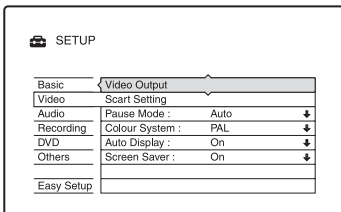

- 4 Select **"Scart Setting,"** and press **ENTER**.

Video - Scart Setting		
Line1 Output	Line3 Input	Line3 Output
Video	Video/RGB	Video
Video	Video/RGB	S Video
Video	Decoder	Video
S Video	S Video	Video
S Video	S Video	S Video
RGB	Video/RGB	Video
RGB	Video/RGB	S Video
RGB	Decoder	Video

- 5 Press **↑/↓** to select **"Video"** or **"RGB"** for **"Line1 Output,"** **"Decoder"** for **"Line3 Input,"** and **"Video"** for **"Line3 Output,"** and press **ENTER**.
The "Video" setup display appears again.

- 6 Press **←** **RETURN** to return the cursor to the left column.

- 7 Select **"Basic,"** and press **ENTER**.

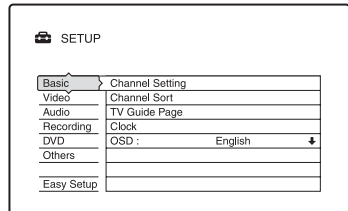

- 8 Select **"Channel Setting,"** and press **ENTER**.

Basic - Channel Setting						
Prog	System	Channel Name	PAY-TV/ CANAL+	Audio	AFT	
1	BG	C1	AAB	Off	NICAM	On -
2	DK	S1	CDE	On	Standard	On -
3	BG	C5	FGH	Off	NICAM	On -

- 9 Press **↑/↓** to select the desired programme position, and press **ENTER**.

Basic - Channel Setting						
Prog	System	Channel Name	PAY-TV/ CANAL+	Audio	AFT	
1	BG	C1	AAB	Off	NICAM	On -
2	DK	S1	CDE	On	Standard	On -
3	BG	C5	FGH	Off	NICAM	On -

10 Select “System” using ←/→.

Basic - Channel Setting



Prog	System	Channel Name	PAY-TV/ CANAL+	Audio	AFT
1	BG	C1	AAB	Off	NICAM On --
2	DK	S1	CDE	On	Standard On --
3	BG	C5	FGH	Off	NICAM On --

11 Press ↑/↓ to select an available TV system, BG, DK or I.

12 Select “Channel” using ←/→.

Basic - Channel Setting



Prog	System	Channel Name	PAY-TV/ CANAL+	Audio	AFT
1	BG	C1	AAB	Off	NICAM On --
2	DK	S1	CDE	On	Standard On --
3	BG	C5	FGH	Off	NICAM On --

13 Select the PAY-TV/Canal Plus analogue programme position using ↑/↓ or number buttons.

14 Select “PAY-TV/ CANAL+” using ←/→.

Basic - Channel Setting



Prog	System	Channel Name	PAY-TV/ CANAL+	Audio	AFT
1	BG	C1	AAB	Off	NICAM On --
2	DK	S1	CDE	On	Standard On --
3	BG	C5	FGH	Off	NICAM On --

15 Select “On” using ↑/↓, and press ENTER.

To return to the previous step

Press ↵ RETURN.

Note

If you disconnect the recorder’s mains lead, you will not be able to view the signals from the connected decoder.

1. Inserting a Disc

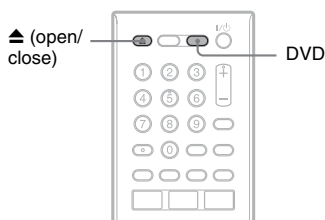

- 1 Press DVD.
- 2 Press (open/close), and place a disc on the disc tray.

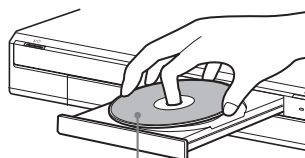

Recording/playing side facing down

- 3 Press (open/close) to close the disc tray.

Wait until "LOAD" disappears from the front panel display.

Unused DVDs are formatted automatically.

- For DVD-RW discs
DVD-RWs are formatted in the recording format (VR mode or Video mode) set by "Format DVD-RW" in the "DVD" setup.
- For DVD-R discs
DVD-Rs are automatically formatted in Video mode. To format an unused DVD-R in VR mode, format the disc using the "Disc Information" display (page 42) **before** you make a recording.

If the disc is recordable on this recorder, you can manually re-format the disc to make a blank disc (page 42).

2. Recording a Programme



This section introduces the basic operation to record a current TV programme to the hard disk (HDD) or to a disc (DVD). For an explanation of how to make timer recordings, see page 52.

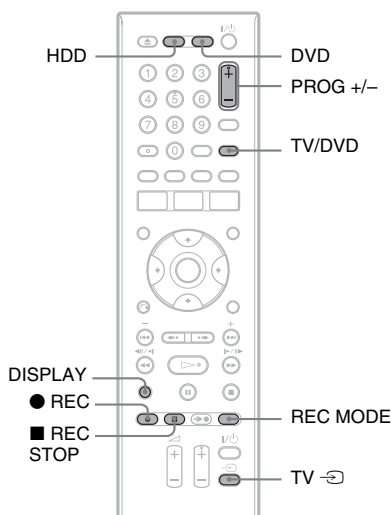

- 1 Press HDD or DVD.
If you want to record to a DVD, insert a recordable DVD.
- 2 Press PROG +/- to select the programme position or input source you want to record.
- 3 Press REC MODE repeatedly to select the recording mode.

Each time you press the button, the display on the TV screen changes as follows:

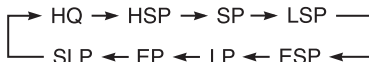

For more details about the recording mode, see page 52.

4 Press ● REC.

Recording starts.

Recording stops automatically after 8 hours of continuous recording or when the HDD or DVD is full.

To record the entire programme (Programme Rec)

Press **OPTIONS** to select “Rec Programme.” The current programme that you are watching will be recorded. Recording automatically stops when the programme ends.

To stop recording

Press **■ REC STOP**.

Note that it may take a few seconds for recorder to stop recording.

To watch another TV programme while recording

If your TV is connected to the **↔ LINE 1** – TV jack, set your TV to the TV input using the TV/DVD button and select the programme you want to watch. If your TV is connected to the **LINE 2 OUT** or **COMPONENT VIDEO OUT** jacks, set the TV to TV input using the TV **↔** button (page 21).

TV Direct Rec

If you are using the SMARTLINK connection, you can easily record what you are watching on your TV.

When the TV is turned on, press ● REC.

Note

If “TV” appears in the front panel display, you cannot turn off the TV or change the programme position during TV Direct Rec. To turn off the function, set “TV Direct Rec” to “Off” in the “Recording” setup (page 102).

About the Teletext function

Some broadcast systems ensure a Teletext service* in which the complete programmes and their data (title, date, programme position, recording start time etc.) are stored day by day. When recording a programme, the recorder automatically takes the programme name from the Teletext pages and stores it as the title name. For details, see “Auto Programme Title Labelling (TV Guide Page)” on page 95.

Note that the Teletext information will not appear on your TV screen. To view the Teletext information on your TV screen, press TV/DVD on the remote to switch the input source to your TV (page 21).

* not available in some areas

Notes

- After pressing ● REC, it may take a short while to start recording.
- You cannot change the recording mode while recording.
- If there is a power failure, the programme you are recording may be erased.
- You cannot watch a PAY-TV/Canal Plus programme while recording another PAY-TV/Canal Plus programme.
- To use the TV Direct Rec function, you must first correctly set the recorder’s clock.

Checking the disc status while recording

You can check the recording information such as recording time or disc type.

Press DISPLAY during recording.

The recording information appears.

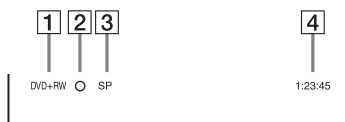

- 1 Disc type/format
- 2 Recording status
- 3 Recording mode
- 4 Recording time

Press **DISPLAY** to turn off the display.

3. Playing the Recorded Programme (Title List)



To play a recorded title, select the title from the Title List.

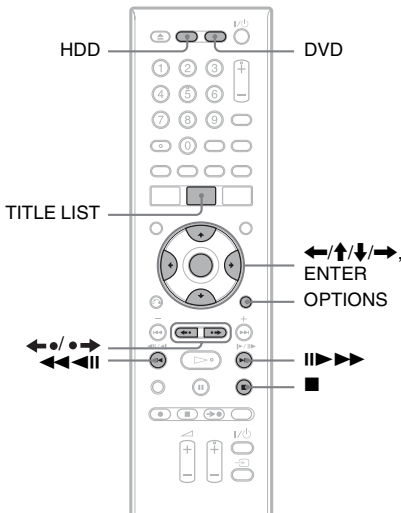

1 Press HDD or DVD.

If you select DVD, insert a DVD (see “1. Inserting a Disc” on page 32). Playback starts automatically depending on the disc.

2 Press TITLE LIST.

To show the extended Title List, press OPTIONS to select “Display List,” and press ENTER.

Title List with Thumbnail Images
(Example: DVD+RW)

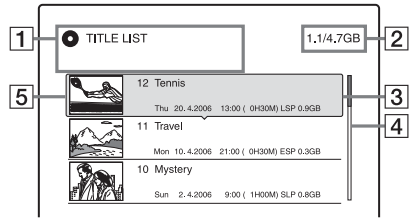

Extended Title List

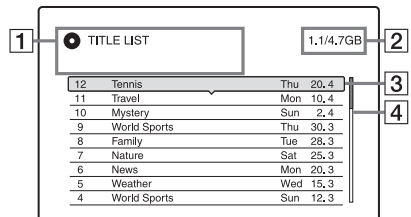

- 1 Disc type:
Displays the media type, HDD or DVD. Also displays the title type (Original or Playlist) for HDD or DVD-RW/DVD-R (VR mode) disc titles.
- 2 Disc space (remainder/total)
- 3 Title information:
Displays the title number, title name, and recording date. Title size is shown in the Thumbnail title list.
 - (red): Indicates that the title is currently being recorded.
 - ⓧ: Indicates that the title is currently being dubbed.
 - Ⓜ: Indicates the protected title.
 - “NEW”: Indicates that the title is newly recorded (not played back) (HDD only).
 - COPY: Indicates titles containing “Copy-Once” copy protection signals (HDD only) (page 84).
- 4 Scroll bar:
Appears when all of the titles do not fit on the list. To view the hidden titles, press ↑/↓.
- 5 Title’s thumbnail picture:
The still images for each title are displayed.

3 Select a title, and press ENTER.

The sub-menu appears.

The sub-menu displays options applicable only to the selected item. The displayed options differ depending upon the model, situation, and disc type.

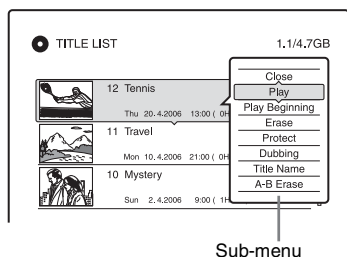

4 Select “Play,” and press ENTER.

Playback starts from the selected title.

To stop playback

Press ■ (stop).

To scroll the list display by page (Page mode)

Press ◀●/●▶ while the list display is turned on. Each time you press ◀●/●▶, the entire Title List changes to the next/previous page of titles.

About the Title List for HDD/DVD-RWs/ DVD-Rs (VR mode)

You can switch the Title List to show Original or Playlist titles.

While the Title List menu is turned on, press ◀/▶.

To change the title order (Sort)

While the Title List menu is turned on, press OPTIONS to select “Sort Titles.” Press ↑/↓ to select the item, and press ENTER.

Order	Sorted
By Date	In order of when the titles were recorded. The title that is recorded most recently is listed at the top.
By Title	In alphabetical order.
By Number	In order of recorded title number.
Unseen Title (HDD only)	In order of when the titles were recorded. The title that is recorded most recently and has not been played is listed at the top. Playlist titles are not displayed.

To change a title thumbnail picture (Thumbnail) (HDD/DVD-RW/DVD-R in VR mode only)

You can select a favourite scene for the thumbnail picture shown in the Title List menu.

- 1 Press TITLE LIST.
Press ◀/▶ to switch the Title Lists, if necessary.
- 2 Select a title, and press ENTER.
The sub-menu appears.
- 3 Select “Set Thumbnail,” and press ENTER.
The display for setting the thumbnail point appears and the title starts to play.
- 4 While watching the playback picture, press ◀◀/▶▶ to select the scene you want to set for a thumbnail picture, and press ENTER.
Playback pauses.
- 5 Press ENTER if the scene is correct. If the scene is incorrect, press ◀◀/▶▶ to select the scene you want to set for a thumbnail picture, and press ENTER.
The display asks for confirmation.
• To change the thumbnail, press ↑.
- 6 Select “OK,” and press ENTER.
The scene is set for the title’s thumbnail picture.

To turn off the Title List

Press TITLE LIST.

Hints

- After recording, the first scene of the recording (the title) is automatically set as the thumbnail picture.
- You can select "TITLE LIST" from the System Menu.

Notes

- The title names may not appear for DVDs created on other DVD recorders.
- It may take a few seconds for the thumbnail pictures to be displayed.
- After editing, the title thumbnail picture may change to the first scene of the recording (title).
- After dubbing, the title thumbnail picture set on the source recording is cancelled.

4. Displaying the Playing Time and Play Information



You can check the playing time of the current title, chapter, track, or disc. Also, you can check the disc name recorded on the DVD/CD.

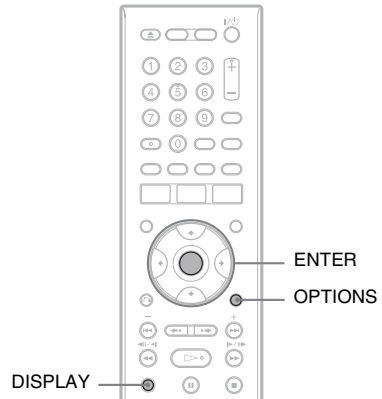

Press DISPLAY.

The displays differ depending on the disc type or playing status.

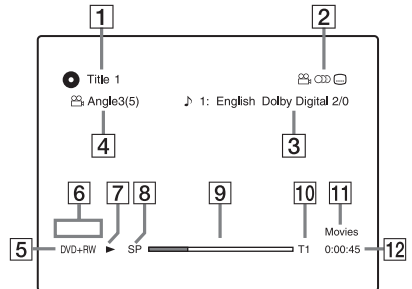

- 1 Title number/name
(Shows either track number, track name, scene number, or file name for CDs, VIDEO CDs, DATA DVDs, or DATA CDs.)

- 2 Available functions for DVD VIDEOS (angle/ audio/ subtitle, etc.), or playback data for DATA DVDs and DATA CDs
- 3 The current selected function or audio setting (appears only temporarily)
Example: Dolby Digital 5.1 ch

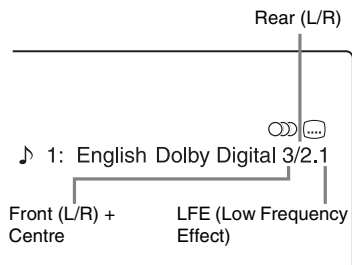

- 4 The current selected angle
- 5 Disc type^{*1}/format (page 8)
- 6 Title type (only appears for Playlists)
- 7 Play mode
- 8 Recording mode (page 52)
- 9 Playing status bar^{*2}
- 10 Title number (page 70)
(Shows either track number, scene number, or file number for CDs, VIDEO CDs, DATA DVDs, or DATA CDs.)
- 11 Album name appears for DATA DVDs or DATA CDs.
- 12 Playing time

^{*1} Displays Super VIDEO CDs as “SVCD,” DATA CDs as “CD” and DATA DVDs as “DVD.”

^{*2} Does not appear with VIDEO CDs, DATA DVDs, and DATA CDs.

💡 Hints

- If “DTS” of “Audio Connection” is set to “Off” in the “Audio” setup, the DTS track selection option will not appear on the screen even if the disc contains DTS tracks (page 100).
- When “Auto Display” is set to “On” (default) in the “Video” setup (page 99), information automatically appears on the screen when the recorder is operated.

📌 Note

Playing time of MP3 audio tracks may not be displayed correctly.

Checking the remaining disc space

You can check the remaining disc space using the “Disc Information” display.

1 Insert a disc.

See “1. Inserting a Disc” on page 32.

2 Press **OPTIONS** to select “Disc Information,” and press **ENTER**.

The “Disc Information” display appears. Available settings differ depending on the disc type.

Example: When a DVD+RW is inserted.

Disc Information	
Media	DVD+RW
Disc Name	
Date	13.10.2006 - 28.10.2006
Title no.	3
Remainder	HQ :0H30M HSP:0H45M SP :1H00M LSP:1H15M ESP:1H30M LP :2H00M EP :3H00M SLP:4H00M 2,3/4,7GB

“Remainder” (approximate)

- The remaining recording time in each of the recording modes
- Disc space bar
- Remaining disc space/total disc space

💡 Hint

To increase disc space, see “To open up disc space” (page 75).

5. Changing the Name of a Recorded Programme



You can label a DVD, title, or programme by entering characters. You can enter up to 64 characters for a title or disc name, but the actual number of characters displayed in the menus such as the Title List will vary. The steps below explain how to change the name of the recorded programme.

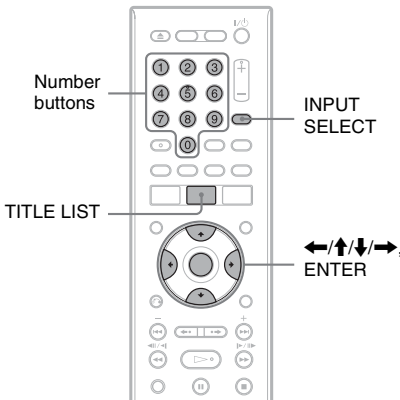

- 1 Press TITLE LIST.**
- 2 Select a title, and press ENTER.**
The sub-menu appears.
- 3 Select "Title Name," and press ENTER.**
The display for entering characters appears.
- 4 Press ←/↑/↓/→ to move the cursor to the right of the display and select "A" (upper-case), "a" (lower-case), or "Symbol," and press ENTER.**
The characters for the selected type are displayed.
- 5 Press ←/↑/↓/→ to select the character you want to enter, and press ENTER.**
The selected character appears at the top of the display.

Example: Input Title Name

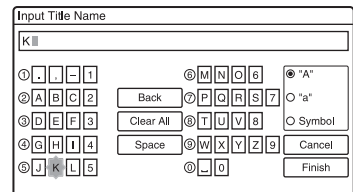

The type of characters will change according to the language you select in "Easy Setup." Some languages allow you to enter an accent mark.

To enter a letter with an accent mark, select an accent followed by the letter. Example: Select " ` " and then "a" to enter "à."

To insert a space, select "Space."

6 Repeat steps 4 and 5 to enter the remaining characters.

Input row

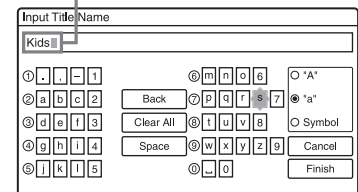

To erase a character, move the cursor to the right of the character at the input row. Select "Back" and press ENTER.

To insert a character, move the cursor to the right of the point where you want to insert the character. Select the character and press ENTER.

To erase all of the characters, select "Clear All" and press ENTER.

7 Select "Finish," and press ENTER.

To cancel the setting, select "Cancel."

To use the number buttons

You can also use the number buttons to enter characters. Refer to the number next to each row of letters on your TV screen.

- In step 5 above, press a number button repeatedly to select a character.
Example:
Press the number 3 button once to enter “D.”
Press the number 3 button three times to enter “F.”
- Press ENTER and select the next character.
- Select “Finish” and press ENTER.

Hint

You can switch between “A” (upper-case), “a” (lower-case), or “Symbol” by pressing INPUT SELECT.

6. Labelling and Protecting a Disc

You can execute options effective for the entire disc using the “Disc Information” display.

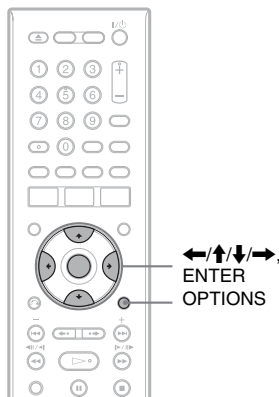

Labelling a disc



- Insert a disc.**
See “1. Inserting a Disc” on page 32.
- Press OPTIONS to select “Disc Information,” and press ENTER.**
The “Disc Information” display appears. Available settings differ depending on the disc type.
Example: When the inserted disc is a DVD+RW.

Disc Information	
Media	DVD+RW
Disc Name	
Date	13. 10.2006 - 28. 10. 2006
Title no.	3
Remainder	HQ :0H30M HSP:0H45M SP :1H00M LSP:1H15M ESP:1H30M LP :2H00M EP :3H00M SLP:4H00M 2,3/4,7GB

- Select “Disc Name,” and press ENTER.**

Enter the disc name in the “Input Disc Name” display (page 38).

Note

You can enter up to 64 characters for a DVD's disc name. The disc name may not appear when the disc is played on other DVD equipment.

Protecting a disc

-RWVR -RVR

1 Insert a disc.

See "1. Inserting a Disc" on page 32.

2 Press **OPTIONS** to select "Disc Information," and press **ENTER**.

The "Disc Information" display appears. Available settings differ depending on the disc type.

Example: When the inserted disc is a DVD-RW (VR mode).

Disc Information	
Media	DVD-RW
Format	VR
Disc Name	
Date	13.10.2006 - 28.10.2006
Title no.	Original 3 / Playlist 5
Remainder	HQ :0H30M HSP:0H45M SP :1H00M LSP:1H15M ESP:1H30M LP :2H00M EP :3H00M SLP:4H00M 2,3/4,7GB

1 "On"/"Off": Indicates whether protection is set (DVD-RW/DVD-R in VR mode only)

2 "Protect Disc"

3 Select "Protect Disc," and press **ENTER**.

4 Select "Protect," and press **ENTER**.

To cancel the protection

Select "Unprotected" in step 4.

Hint

You can set protection for individual titles (page 75).

7. Playing the Disc on Other DVD Equipment (Finalise)

+RW -RWVR -RWVideo +R -RVR
-RVideo

Finalising is necessary when you play discs recorded with this recorder on other DVD equipment.

When you finalise a DVD+RW, DVD-RW (Video mode), DVD+R, or DVD-R (Video mode), a DVD menu will be automatically created, which can be displayed on other DVD equipment.

Before finalising, check the differences between the disc types in the table below.

Differences between the disc types

+RW Discs are automatically finalised when removed from the recorder. However, you may need to finalise the disc for certain DVD equipment, or if the recording time is short. You can edit or record on the disc even after finalising.

-RWVR Finalising is unnecessary when playing a disc on VR format compatible equipment. Even if your other DVD equipment is VR format compatible, you may need to finalise the disc, especially if the recording time is short. You can edit or record on the disc even after finalising.

-RWVideo Finalising is necessary when playing on any equipment other than this recorder. After finalising, you cannot edit or record on the disc. If you want to record on it again, unfinalise (page 42) or reformat the disc (page 42). However, if you reformat the disc, all recorded contents will be erased.

-RVR Finalising is necessary. The disc can be played only on equipment that supports DVD-R in VR mode. After finalising you cannot edit or record on the disc using this recorder.

+R**-RVideo**

Finalising is necessary when playing on any equipment other than this recorder.

After finalising, you cannot edit or record on the disc.

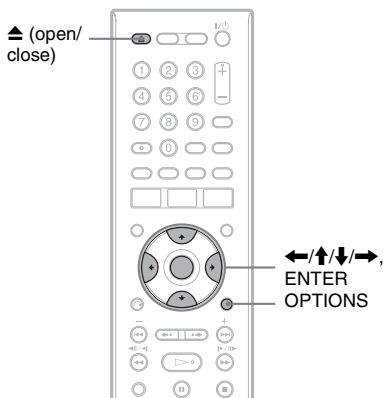

Finalising the disc using ▲ (open/close) button

1 Make a recording.

See “2. Recording a Programme” on page 32.

2 Press ▲ (open/close).

The display shows the approximate time required for finalising and asks for confirmation.

For DVD+RWs, the recorder automatically starts finalising the disc. After finalising, the disc will be ejected automatically.

3 Select “OK,” and press ENTER.

The recorder starts finalising the disc. After finalising, the disc will be ejected automatically.

Finalising the disc using “Disc Information” display

1 Insert a disc.

See “1. Inserting a Disc” on page 32.

2 Press **OPTIONS** to select “Disc Information,” and press **ENTER**.

The “Disc Information” display appears.

3 Select “Finalise,” and press **ENTER**.

The display shows the approximate time required for finalising and asks for confirmation.

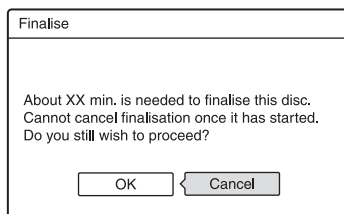

4 Select “OK,” and press **ENTER**.

The recorder starts finalising the disc.

Hint

You can check whether the disc has been finalised or not. If you cannot select “Finalise” in step 3 above, the disc has already been finalised.

Notes

- Depending on the condition of the disc, recording, or the DVD equipment, discs may not play even if the discs are finalised.
- The recorder may not be able to finalise the disc if it was recorded on another recorder.

Unfinalising a disc

-RWVR -RW_{Video}

For DVD-RWs (Video mode)

DVD-RWs (Video mode) that have been finalised to prohibit additional recording or editing can be unfinalised to allow further recording or editing.

For DVD-RWs (VR mode)

If you cannot record or edit on a DVD-RW (VR mode) that has been finalised with other DVD equipment, unfinalise the disc.

Note

The recorder is not able to unfinalise DVD-RWs (Video mode) that have been finalised on another recorder.

1 Insert a disc.

See "1. Inserting a Disc" on page 32.

2 Press **OPTIONS** to select "Disc Information," and press **ENTER**.

The "Disc Information" display appears.

3 Select "Unfinalise," and press **ENTER**.

The recorder starts unfinalising the disc. Unfinalising may take several minutes.

8. Reformatting a disc

+RW -RWVR -RW_{Video}

New discs are automatically formatted when inserted. If necessary, you can manually reformat a DVD+RW or DVD-RW disc to make a blank disc. For DVD-RWs, you can select a recording format (VR mode or Video mode) according to your needs (page 74).

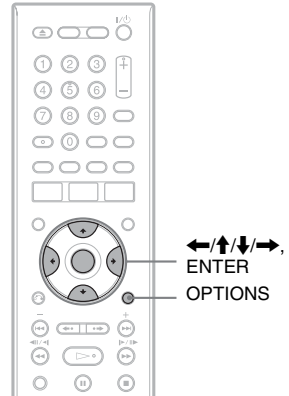

1 Insert a disc.

See "1. Inserting a Disc" on page 32.

2 Press **OPTIONS** to select "Disc Information," and press **ENTER**.

Example: When a DVD+RW is inserted.

Disc Information	
Media	DVD+RW
Disc Name	
Date	13.10.2006 - 28.10.2006
Title no.	3
Remainder	HQ :0H30M HSP:0H45M SP :1H00M LSP:1H15M ESP:1H30M LP :2H00M EP :3H00M SLP:4H00M
	2,3/4,7GB

Buttons: Close, Disc Name, Finalise, Format

3 Select "Format," and press **ENTER**.

4 Select "OK," and press **ENTER**.

For DVD-RWs and unrecorded DVD-Rs (Video mode), select "VR" or "Video," and press **ENTER**.

All contents on the disc are erased.

 **Hint**

By reformatting, you can change the recording format on DVD-RWs, or record again on DVD-RWs that have been finalised.

 **Note**

On this model, 1 GB (read “gigabyte”) is equivalent to 1 billion bytes. The larger the number, the larger the disc space.

Introduction to the GUIDE Plus+ System

The GUIDE Plus+® system is a free interactive programme guide. It displays up to seven days of programme listings, including programme titles, promotions, and broadcast information. GUIDE Plus+ data for the television programme listings are carried by your local broadcast host channel and are received through your aerial, set top box receiver, or direct cable connection from the wall.

Visit www.europe.guideplus.com for a list of all European host channels.

These are just a few of the ways to use the GUIDE Plus+ system.

- Search for a programme by listing them according to category (such as Movies or Sports) or by using the Keyword Search function (page 48).
- Once you have found the programme you are looking for, use the GUIDE Plus+ system to set the timer for recording (page 54).
- You can set the system to display your favourite programmes according to conditions that you set, such as category and keyword (page 48).

For more information, see “Watching TV using the GUIDE Plus+ System” (page 46).

Learning the common elements

Press TV GUIDE.

The GUIDE Plus+ system “Home Screen” appears.

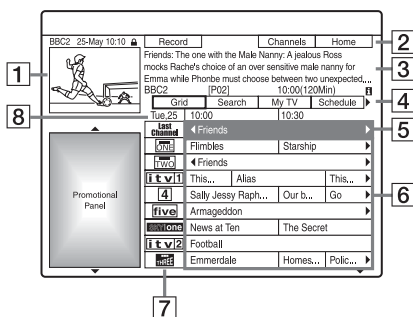



- 1 Video Window: This shows the programme you were watching when you pressed TV GUIDE.
- 2 Action Bar: When the same colour button on the remote is pressed, the Action Bar functions. The Action Bar function differs according to the screen.
- 3 Information Box: Shows information about the selected programme when the “Home Screen” is displayed. Contents will differ according to the displayed screen.
- 4 Menu Bar: Press the blue button (“Home”), and press \uparrow to move the cursor to the Menu Bar. Then, select one of the following features using \leftarrow / \rightarrow , and press ENTER.
 - “Grid”: Shows the programmes for the current time slot and next 7 days.
 - “Search”: Allows you to search for titles by category or by keyword (page 47). The displayed category depends upon the programme data received by this recorder. Movies, Sports, and Children are examples of possible categories.
 - “My TV”: Sets the profile for your favourite programmes (page 48).
 - “Schedule”: Displays the list of timer settings (page 59).

“Info”: Shows information when available.

“Editor”: Allows you to edit the channel lineup and channel display (page 51).

“Setup”: Allows you to change the language, country/region, postal code, input source, or host channel.

- 5 “Home” position: When you press the blue button (“Home”), the cursor returns to the last programme position on the “Grid.”
- 6 Tiles: Shows the programme titles and category; green (sports), purple (movies), blue (children’s), teal (others).
- 7 Broadcast station Logo: Shows the broadcast station logo.
- 8 Time Slot: Indicates the currently selected time slot. Use / to select a different time slot.

Troubleshooting guide

If you are having trouble displaying the television programme list, please check the following:

- Your postal code must be set correctly (page 24).
- The clock must be set correctly. If the clock is not set, set it manually (page 97).
- This recorder downloads the GUIDE Plus+ data several times a day when the recorder is turned off (standby mode). Turn off the recorder when you are not using it (for example, at night). After initial setup (page 24), it may take up to 24 hours for your recorder to start receiving programme listings. It may take up to one day to receive all seven days of TV programme listings.

- Check the following if the programme guide data has not been received after waiting for a day:

- “Easy Setup” (page 24) is finished.
- The host channel is not disabled (see “Disabling programme positions” on page 51).

– The timer is not set.

If the programme guide data still cannot be received after checking the above, search for the host channel at the following website and set the host channel manually (page 50):

www.europe.guideplus.com

- If you made connection “B: Set top box receiver with a SCART output only” (page 15) and did not connect an aerial cable from your set top box receiver to the recorder, do the following:
 - Turn on your set top box receiver.
 - Connect the set top box controller.
 - Follow the steps in “Changing the GUIDE Plus+ host channel” (page 50). Be sure to set your set top box receiver (tuner) as the source.

Notes

- Your set top box receiver’s programme position may suddenly change even if the recorder is turned off. This is because the set top box controller has changed the programme position to receive the GUIDE Plus+ data.
- When you set “Factory Setup” to “All,” the recorder is initialized. When you change the following settings, the GUIDE Plus+ system is reset:
 - Country/region setting in “Easy Setup”
 - “Country” of “Setup” - “Basic Setup” in the Menu Bar
 - Postal code setting in “Easy Setup”
 - “Postal Code” of “Setup” - “Basic Setup” in the Menu Bar
 Note that the GUIDE Plus+ system is also reset when you make changes to the host channel settings or if you set “Factory Setup” to “Basic.”

Watching TV using the GUIDE Plus+ System

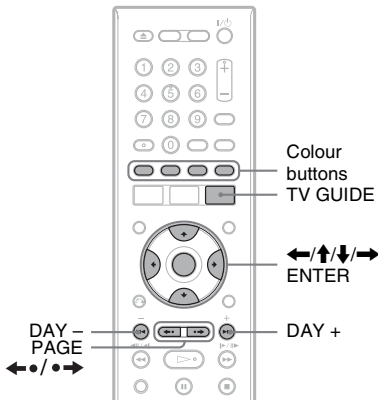

1 Press TV GUIDE.

The GUIDE Plus+ system “Home Screen” appears.

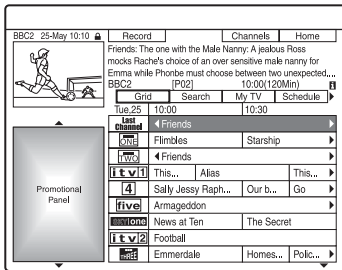

2 Select a programme using ←/↑/↓/→, and press ENTER.

The GUIDE Plus+ system disappears and the programme position changes to the selected programme.

To select a programme position quickly using the TV broadcast station logo

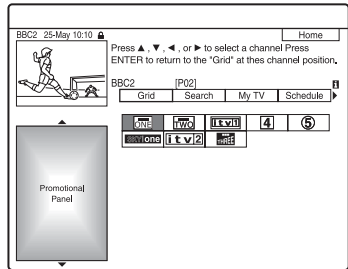

- 1 Press TV GUIDE.
The GUIDE Plus+ system “Home Screen” appears.
- 2 Press the yellow button (“Channels”).



- 3 Select the TV broadcast station logo using ←/↑/↓/→, then press ENTER.
The display returns to “Grid” and the programme currently being broadcast by the selected TV station is selected.
- 4 Select a programme using ←/→, and press ENTER.

To unlock the Video Window

The Video Window is locked so that it does not change programme positions when you move the cursor across other titles.

From “Grid,” select the logo of the programme position that is locked, and press the red button (“Unlock”). “” changes to “” and the Video Window is unlocked. To lock the Video Window, select the logo of the programme position you want to lock and press the red button (“Lock”).

To return to the “Home” position

Press the blue button (“Home”).
The cursor returns to the home position on the “Grid.”

To set a programme for timer recording
See "One Button Recording (GUIDE Plus+)" (page 54).

To close the GUIDE Plus+ system
Press TV GUIDE.

Hints

- Press the PAGE ◀●/●▶ buttons to change the programme list by page.
- Press the DAY +/- buttons to change the programme list by day.

Notes

- The Video Window is locked during recording and the lock indicator appears in the Video Window. You cannot unlock the Video Window while recording.
- If you are watching programmes through a set top box, the Video Window may not change as fast as you move the cursor. In this case, lock the Video Window (page 46).
- The screen saver will appear if no buttons are pressed for more than ten minutes.

Searching for a Programme using the GUIDE Plus+ System

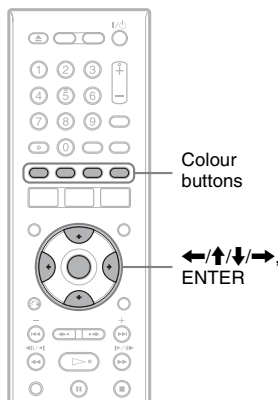

1 Select "Search" in the Menu Bar, and press ENTER.

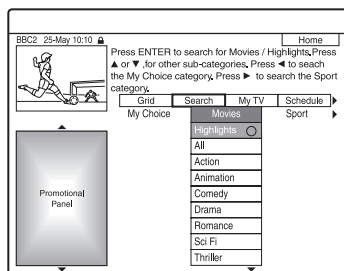

2 Select a category using ◀/▶, and press ENTER.

To search for a programme by keyword, select "My Choice." You can search for all programmes that contain the keyword in the programme's title and in the programme's Information Box. If no keywords are displayed, enter the keyword. See "To enter a new keyword" below.

3 Select a sub-category using ▲/▼, and press ENTER.

Programmes that meet the conditions are listed up.
The sub-categories differ according to country/region.

4 Select a programme using \uparrow/\downarrow , and press ENTER.

To enter a new keyword

- 1 Select "Search" in the Menu Bar, and press ENTER.
- 2 Select "My Choice" using \leftarrow/\rightarrow .
- 3 Press the yellow button ("Add"). The display for entering characters appears.

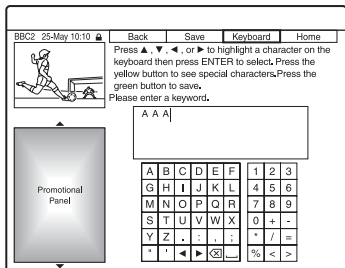

- 4 Select a character on the keyboard using $\leftarrow/\uparrow/\downarrow/\rightarrow$, and press ENTER.

To switch between upper-case, lower-case, or characters with accents, press the yellow button ("Keyboard") repeatedly. To cancel entering a new keyword, press the red button ("Back").

- 5 Repeat step 4 to enter the keyword.

- 6 Press the green button ("Save").

The entered keyword is registered.

To delete the keyword, select the keyword you want to delete, and press the red button ("Delete").

To change the keyword, select the keyword you want to change, and press the green button ("Edit").

To set a programme for timer recording

See "One Button Recording (GUIDE Plus+)" (page 54).

Hint

When two or more keywords are set for "My Choice," you can select "All."

Listing Up Your Favourite Programme Information (My TV)

You can set a profile and list up only your favourite programme information.

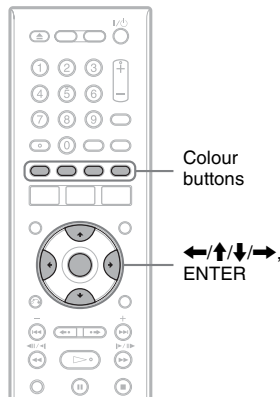

Setting a profile

- 1 Select "My TV" in the Menu Bar.
- 2 Press the yellow button ("Profile").

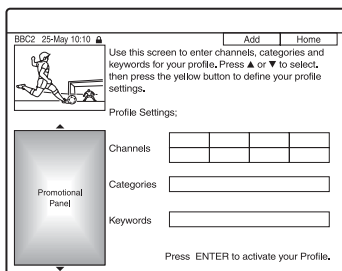

3 Select “Channels,” “Categories,” or “Keywords,” and press the yellow button (“Add”).

“Channels”: Select the programme position using $\leftarrow/\uparrow/\downarrow/\rightarrow$, and press ENTER. To add more programme positions, press the yellow button (“Add”). You can register up to 16 programme positions.

To cancel the registration, select a programme position, and press the red button (“Delete”).

“Categories”: Select the category using $\leftarrow/\uparrow/\downarrow/\rightarrow$, and press ENTER. To add more categories, press the yellow button (“Add”). You can register up to 4 categories.

To cancel the registration, select a category, and press the red button (“Delete”).

“Keywords”: Enter a keyword. See “To enter a new keyword” on page 48. To add more keywords, press the yellow button (“Add”). You can register up to 16 keywords.

To cancel the registration, select a keyword, and press the red button (“Delete”).

4 Press ENTER.

To change the profile settings

- 1 Select “My TV” in the Menu Bar.
- 2 Press the yellow button (“Profile”).
- 3 Repeat from step 3 above.

Selecting and watching a programme from My TV

1 Select “My TV” in the Menu Bar, and press ENTER.

The programmes that match the profile conditions are displayed.

2 Select a programme using $\leftarrow/\uparrow/\downarrow/\rightarrow$, and press ENTER.

To set a programme for timer recording

See “One Button Recording (GUIDE Plus+)” (page 54).

Making changes to the GUIDE Plus+ System

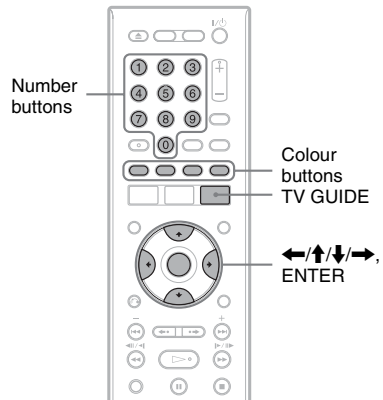

Changing the basic GUIDE Plus+ settings

All necessary settings are made when you complete Easy Setup (page 24). Follow the steps below only if you want to make changes to the current settings. Note that if you change the country/region setting, Easy Setup will begin again when you close the GUIDE Plus+ system.

1 Press TV GUIDE.

The GUIDE Plus+ system appears.

2 Select “Setup” in the Menu Bar.

The GUIDE Plus+ setup menu appears.

3 Select “Basic Setup” using \uparrow/\downarrow , and press ENTER.

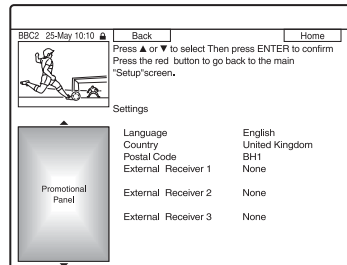

4 Select an item using **↑/↓**, and press **ENTER**.

5 Select a setting using **↑/↓**, and press **ENTER**.

“Language”: Select a language for the on-screen displays using **↑/↓**.

“Country”: Select your country/region using **↑/↓**.

When you exit the GUIDE Plus+ system after changing your country/region, the “Easy Setup” display appears. Follow the instructions for “Step 6: Easy Setup” (page 24) from step 2.

“Postal Code”: Enter your postal code using **←/↑/↓/→**. If “Country” is set to “Others,” you cannot enter a postal code and the GUIDE Plus+ system will not search for a host channel.

“External Receiver 1”/“External Receiver 2”/“External Receiver 3”:

When a set top box receiver is connected to the recorder, set it up for the GUIDE Plus+ system. See “Setting up your set top box receiver for the GUIDE Plus+® system” on page 25.

6 Press **TV GUIDE** to exit the **GUIDE Plus+** system.

To cancel GUIDE Plus+ settings

Press the red button (“Back”).

To return to the “Home” position

Press the blue button (“Home”).

The cursor returns to the home position on the “Grid.”

Note

You cannot set “Easy Setup - Tuner System” in the “Easy Setup” or “OSD” in the “Basic” setup to a country/region or language that is not supported by the GUIDE Plus+ system.

Changing the GUIDE Plus+ host channel

The default host channel setting is set to “Automatic,” so you should not have to change the host channel setting. However, if you are using connection B (page 15) and you want to receive the programme guide data from your set top box receiver, or if there is no sound or if the picture is distorted, search for the host channel on the following website and set it for your area, following the steps below:

www.europe.guideplus.com

1 Press **TV GUIDE**.

The GUIDE Plus+ system appears.

2 Select “Setup” in the Menu Bar.

The GUIDE Plus+ setup menu appears.

3 Select “Host Channel Setup” using **↑/↓**, and press **ENTER**.

4 Press the yellow button (“Change”) twice.

“Manual” appears.

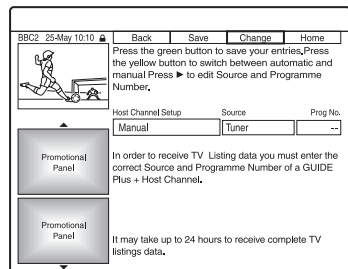

5 Select “Source” using **→**.

6 Press the yellow button (“Source”) repeatedly to select the input source.

7 Select “Prog. No.” using **→**.

8 Enter the programme position number using the number buttons.

9 Press the green button (“Save”).

The display asks for confirmation.

10 Select "Confirm" using \leftarrow/\rightarrow , and press ENTER.

The display returns to the GUIDE Plus+ setup menu.

11 Wait one day until the programme guide data can be received.

To cancel the settings

Press the red button ("Back").

To return to the "Home" position

Press the blue button ("Home").

The cursor returns to the home position on the "Grid."

To check the GUIDE Plus+ system information

- 1 Press TV GUIDE.
- 2 Select "Setup" in the Menu Bar, and press ENTER.
- 3 Select "GUIDE Plus+ system Information" using \uparrow/\downarrow , and press ENTER.

Checking programme positions

Check whether programme position numbers are the same as the programme position numbers set in the "Channel Setting."

If you want to make adjustments to the channel settings or change the channel name, see "Channel Setting" in "Settings and Adjustments" (page 93).

1 Select "Editor" in the Menu Bar, and press ENTER.

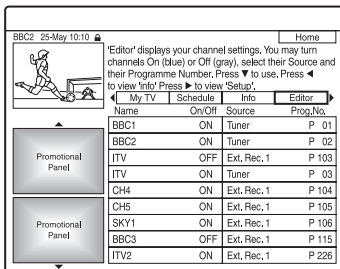

2 Press \rightarrow to move the cursor to the right column.

3 Select the programme position you want to check using \uparrow/\downarrow .

To change the input source, press the red button ("Source").

To change the programme position, see "Channel Setting" on page 93.

Note

To receive from the recorder a programme position that can be received by either the set top box receiver or the recorder, change the input source in step 3.

Disabling programme positions

If any programme positions are unused or contain unwanted channels, you can hide them.

For instance, if you are using your set top box receiver to receive programme data (connection B, page 15), all receivable programme positions are displayed. Use this function to hide any unwanted programme positions.

1 Select "Editor" in the Menu Bar, and press ENTER.

2 In the left column, select the programme position you want to hide or display using \uparrow/\downarrow .

3 Press the red button ("On/Off").

The disabled positions will turn grey.

To show the disabled positions, press the red button ("On/Off") again.

Notes

- You cannot record a programme position, if it is not set in "Channel Setting" of "Settings and Adjustments," even if it is set to "On" in the "Editor" in the Menu Bar.
- If you are using your set top box receiver to receive programmes (connection B, page 15) and are able to receive the same programme with both the set top box and the recorder, change the "Source" to receive the programme with the recorder's tuner.

Before Recording

Before you start recording...

- Check that the disc has enough available space for the recording (page 37). For the HDD, DVD+RWs, and DVD-RWs, you can free up disc space by erasing titles (page 75).
- Adjust the recording picture quality and picture size if necessary (page 58).

Hint

Timer recordings will be made regardless whether or not the recorder is turned on. You can turn off the recorder without affecting the recording even after recording starts.

Note

To play a recorded disc on other DVD equipment, finalise the disc (page 40).

Recording mode

Like the standard x3 recording modes of video tapes, you can select the desired recording mode using the REC MODE button.

Recording modes with higher quality provide a more beautiful recording, but the large data volume also results in a shorter recording time.

Conversely, a longer duration provides a longer recording time, but the lower data volume results in a coarser picture quality.

Press REC MODE repeatedly to switch the recording modes.

To select the HQ+ mode, set "HQ Setting" of the "HDD Rec. Settings" to "HQ+" in the "Recording" setup (page 102). "HQ+" records pictures in higher quality than HQ on the HDD. Note that HQ+ plus appears as HQ in the front panel display and the on screen displays.

Recording mode	Approx. recording time (hours)		
	HDD		DVD*
	RDR-HX525	RDR-HX725	
HQ+ (High quality)	8	20	–
HQ ↑	13	32	1
HSP ↑	19	46	1 hr. 30 min.
SP (Standard mode)	26	61	2
LSP ↓	33	77	2 hr. 30 min.
ESP ↓	39	93	3
LP ↓	53	124	4
EP ↓	79	187	6
SLP (Long duration)	106	249	8

* The recording time for DVD+R DL (Double Layer) discs is as follows:

- HQ: 1 hour 48 minutes
- HSP: 2 hours 42 minutes
- SP: 3 hours 37 minutes
- LSP: 4 hours 31 minutes
- ESP: 5 hours 25 minutes
- LP: 7 hours 14 minutes
- EP: 10 hours 51 minutes
- SLP: 14 hours 28 minutes

Notes

- The maximum continuous recording time for a single title is eight hours.
- Situations below may cause slight inaccuracies with the recording time.
 - Recording a programme with poor reception, or a programme or video source of low picture quality
 - Recording on a disc that has already been edited
 - Recording only a still picture or just sound

Recording stereo and bilingual programmes

The recorder automatically receives and records stereo and bilingual programmes based on the ZWEITON system or the NICAM system.

The HDD and a DVD-RW (VR mode) or DVD-R (VR mode) can record both main and sub sounds. You can switch between main and sub when playing the disc. For the HDD, you can select the sound track before recording. Select “Main,” “Sub,” or “Main+Sub” in “Bilingual Recording” of the “HDD Rec. Settings” in the “Recording” setup (page 102).

A DVD+RW, DVD-RW (Video mode), DVD+R, or DVD-R (Video mode) can record only one sound track (main or sub) at a time. Select the sound track using the Setup Display before recording starts. Set “Bilingual Recording” of the “DVD Rec. Settings” to “Main” (default) or “Sub” in the “Recording” setup (page 102).

ZWEITON (German stereo) system

When a stereo based programme is received, “Stereo” appears.

When a bilingual ZWEITON based programme is received, “Main,” “Sub,” or “Main/Sub” appears.

NICAM system

When a stereo or bilingual NICAM based programme is received, “NICAM” appears in the front panel display.

To record a NICAM programme, be sure to set “Audio” of “Channel Setting” in the “Basic” setup to “NICAM” (default). If the sound is not clear when listening to NICAM broadcasts, set “Audio” to “Standard” (see “Channel Setting” on page 93).

Hint

You can select the audio (main or sub) while recording bilingual programmes using the AUDIO button. This does not affect the recorded sound.

Unrecordable pictures

Pictures with copy protection cannot be recorded on this recorder.

When the recorder receives a copy guard signal, the recorder continues to record but only a blank, grey coloured screen will be recorded.

Copy control signals	Recordable discs
Copy-Free	<div style="display: flex; justify-content: space-around; align-items: center;"> <div style="border: 1px solid black; padding: 2px;">HDD</div> <div style="border: 1px solid black; padding: 2px;">+RW</div> <div style="border: 1px solid black; padding: 2px;">-RWVR</div> </div> <div style="display: flex; justify-content: space-around; align-items: center; margin-top: 5px;"> <div style="border: 1px solid black; padding: 2px;">-RWVideo</div> <div style="border: 1px solid black; padding: 2px;">+R</div> <div style="border: 1px solid black; padding: 2px;">-RVR</div> </div> <div style="display: flex; justify-content: space-around; align-items: center; margin-top: 5px;"> <div style="border: 1px solid black; padding: 2px;">-RVideo</div> </div>
Copy-Once	<div style="display: flex; justify-content: space-around; align-items: center;"> <div style="border: 1px solid black; padding: 2px;">HDD</div> </div> <div style="display: flex; justify-content: space-around; align-items: center; margin-top: 5px;"> <div style="border: 1px solid black; padding: 2px;">-RWVR (CPRM*)</div> </div> <div style="display: flex; justify-content: space-around; align-items: center; margin-top: 5px;"> <div style="border: 1px solid black; padding: 2px;">-RVR (CPRM*)</div> </div>
Copy-Never	None (a blank screen is recorded)

* The recorded disc can be played only on CPRM compatible equipment (page 8).

Timer Recording (GUIDE Plus+/VIDEO Plus+/Manual)



There are three methods to setting the timer within the GUIDE Plus+ system: One Button Recording, VIDEO Plus+, and setting the timer manually.

Notes

- When the recorder is connected to a set top box receiver and you want to record using the GUIDE Plus+ system, turn on the set top box receiver and connect the set top box controller.
- Do not operate your set top box receiver just before or during a timer recording. This may prevent the accurate recording of a programme.

One Button Recording (GUIDE Plus+)

You can use the GUIDE Plus+ system to set the timer to record a programme up to seven days in advance.

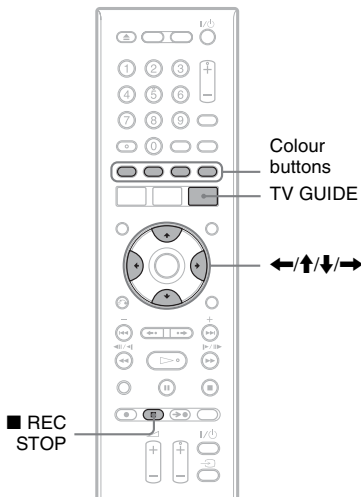

1 Press TV GUIDE.

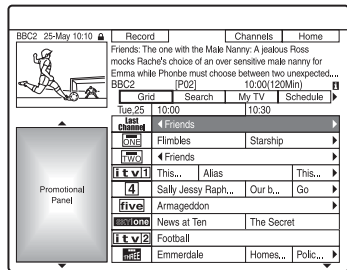

2 Select a programme using ←/↑/↓/→.

To search for a programme by category or by keyword, select “Search” in the Menu Bar. See “Searching for a Programme using the GUIDE Plus+ System” on page 47 for more information about searching for a programme.

You can select a programme from “My TV.”

3 Press the red button (“Record”).

The set programme and Time Slot change colour and the recorder is ready to start recording. When recording from a set top box receiver, be sure to turn it on. Unlike a VCR, there is no need to turn off the recorder before the timer recording starts.

- To record on a DVD See “Checking/Changing/Canceling Timer Settings” on page 59.
- To make more detailed timer settings See “Checking/Changing/Canceling Timer Settings” on page 59.

To confirm, change, or cancel a timer recording

See “Checking/Changing/Canceling Timer Settings” on page 59.

To stop recording during timer recording

Press ■ REC STOP.

Note that it may take a few seconds for the recorder to stop recording, and that the recording cannot be stopped within the first minute of recording.

To adjust the recording quality

See step 3 of “Adjusting the recording picture quality and size” on page 58.

Rec Mode Adjust

If there is not enough available disc space for the recording, the recorder automatically adjusts the recording mode to enable the entire programme to be recorded. Set “Rec Mode Adjust” of the “Timer Settings” to “On” in the “Recording” setup (page 102).

Auto Title Erase (HDD only)

If there is not enough space for a timer recording, the recorder automatically erases old titles recorded on the HDD. The oldest played title is erased. Set “Auto Title Erase” of the “Timer Settings” to “On” in the “Recording” setup (page 102). Protected titles are not erased.

If the timer settings overlap

If one or more timer settings overlap, a message appears. To change the timer settings, see “Checking/Changing/ Cancelling Timer Settings” on page 59.

Hint

If you are recording to the HDD or a DVD-RW (VR mode) at a recording mode that is SP or lower and is a 2x speed or higher disc, you can play the title as it is being recorded by selecting the programme title on the Title List (page 69).

Notes

- If a message indicating that the disc is full appears on the screen, change the disc, or make available space for the recording (HDD/DVD+RW/DVD-RW only) (page 76).
- The last recording mode you selected manually becomes the default recording mode for timer recordings made from the GUIDE Plus+ system.
- You cannot adjust the recording quality (HDD or DVD) once the recording starts.
- The beginning of some recordings may not be made when using the PDC/VPS function.
- You cannot extend the recording duration time when “PDC/VPS” is set to “On” (page 60).

Recording TV programmes using the VIDEO Plus+ system

The VIDEO Plus+ system is a feature that simplifies setting the timer. Just enter the PlusCode programming number listed in the TV programme guide. The date, time, and programme position of that programme are set automatically.

Check that the programme positions are correctly set in “Channel Setting” in the “Basic” setup (page 93).

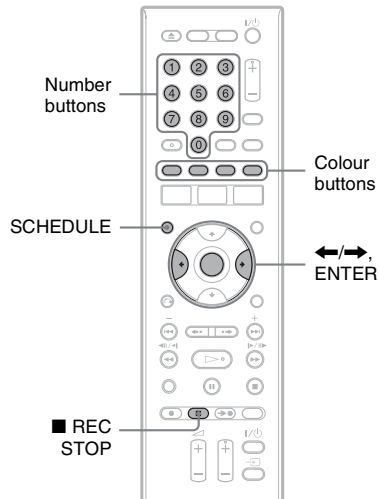

- 1 With the GUIDE Plus+ system turned off, press SCHEDULE.
- 2 Press the red button (“VIDEO Plus+”).

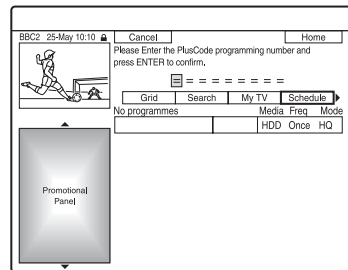

- 3 Press the number buttons to enter the PlusCode programming number.
 - If you make a mistake, press ← and re-enter the correct number.

4 Press ENTER.

The date, start and stop times, programme position, etc. setting appear. The recorder is ready to start recording.

- To record on a DVD
See “Checking/Changing/Canceling Timer Settings” on page 59.
- To make more detailed timer settings
See “Checking/Changing/Canceling Timer Settings” on page 59.

To confirm, change, or cancel a timer recording

See “Checking/Changing/Canceling Timer Settings” on page 59.

To stop recording during timer recording

Press ■ REC STOP.

Note that it may take a few seconds for the recorder to stop recording.

Rec Mode Adjust

If there is not enough available disc space for the recording, the recorder automatically adjusts the recording mode to enable the entire programme to be recorded. Set “Rec Mode Adjust” of the “Timer Settings” to “On” in the “Recording” setup (page 102).

Auto Title Erase (HDD only)

If there is not enough space for a timer recording, the recorder automatically erases old titles recorded on the HDD. The oldest played title is erased. Set “Auto Title Erase” of the “Timer Settings” to “On” in the “Recording” setup (page 102). Protected titles are not erased.

Setting the timer manually

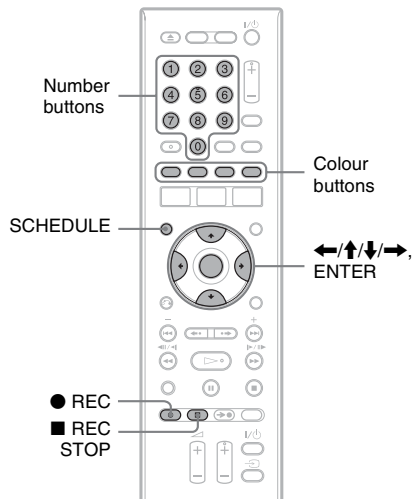

1 With the GUIDE Plus+ system turned off, press SCHEDULE.

2 Press the green button (“Manual”).

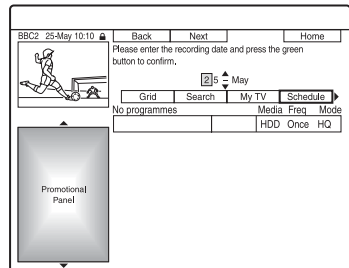

3 Set the date using the number buttons and ←/↑/↓/→. Then press the green button (“Next”).

4 Set the start time using the number buttons and ←/↑/↓/→. Then press the green button (“Next”).

5 Set the stop time using the number buttons and ←/↑/↓/→. Then press the green button (“Next”).

6 Select the input source using \uparrow/\downarrow , and select the programme position using the number buttons or \uparrow/\downarrow .

You can also select the programme position using the yellow button ("Channels").

7 Press the green button ("Next").

The display for entering characters appears.

To change the title name, select a character on the keyboard using $\leftarrow/\uparrow/\downarrow/\rightarrow$, and press ENTER.

To switch between upper-case, lower-case, or characters with accents, press the yellow button ("Keyboard").

8 Press the green button ("Save").

The date, start and stop times, programme position etc. setting appear. The recorder is ready to start recording.

To confirm, change, or cancel a timer recording

See "Checking/Changing/Cancelling Timer Settings" on page 59.

To stop recording during timer recording

Press \blacksquare REC STOP.

Note that it may take a few seconds for the recorder to stop recording.

Rec Mode Adjust

If there is not enough available disc space for the recording, the recorder automatically adjusts the recording mode to enable the entire programme to be recorded. Set "Rec Mode Adjust" in the "Recording" setup to "On" (page 102).

Auto Title Erase (HDD only)

If there is not enough space for a timer recording, the recorder automatically erases old titles recorded on the HDD. Set "Auto Title Erase" in the "Recording" setup to "On" (page 102). The oldest played title is erased. Protected titles are not erased.

If the timer settings overlap

If one or more timer settings overlap, a message appears. To change the timer settings, see "Checking/Changing/Cancelling Timer Settings" on page 59.

Using the Quick Timer function

You can set the recorder to record in 30 minute increments.

Press \bullet REC repeatedly to set the duration.

Each press advances the time in 30 minute increments. The maximum duration is six hours.

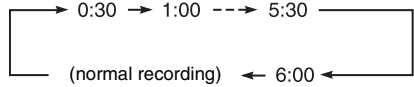

The time counter decreases minute by minute to 0:00, then the recorder stops recording (the power does not turn off). Even if you turn off the recorder during recording, the recorder continues to record until the time counter runs out.

Note that the Quick Timer function does not work if "TV Direct Rec" is set to "On" in the "Recording" setup (page 102).

To cancel the Quick Timer

Press \bullet REC repeatedly until the counter appears in the front panel display. The recorder returns to normal recording mode.

Adjusting the recording picture quality and size

You can adjust the recording picture quality and picture size.

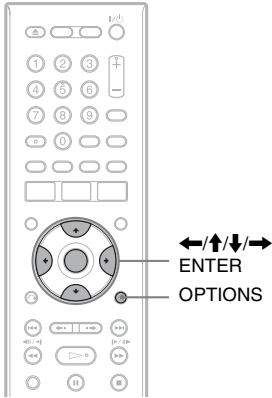

- 1 Before recording starts, press **OPTIONS** to select “Rec Settings,” and press **ENTER**.

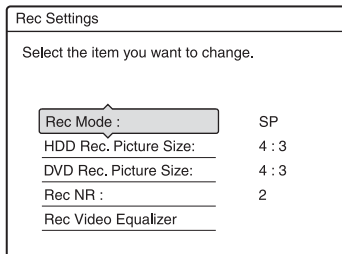

- 2 Select the item you want to adjust, and press **ENTER**.

The adjustment display appears.

Example: Rec NR

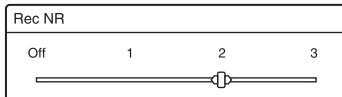

“Rec Mode”:

Selects the recording mode for the desired recording time and picture quality. For more information, see “Recording mode” on page 52.

“HDD Rec. Picture Size”/“DVD Rec. Picture Size”:

Sets the picture size of the programme to be recorded.

- 4:3 (default): Sets the picture size to 4:3.
- 16:9: Sets the picture size to 16:9 (wide mode).
- Auto (HDD only): Automatically selects the actual picture size.

“DVD Rec. Picture Size” works with DVD-RWs/DVD-Rs (Video mode) when the recording mode is set to HQ, HSP, SP, LSP, or ESP. For all other recording modes, the screen size is fixed at “4:3.”

For DVD-Rs/DVD-RWs (VR mode), the actual picture size is recorded regardless of the setting. For example, if a 16:9 size picture is received, the disc records the picture as 16:9 even if “DVD Rec. Picture Size” is set to “4:3.”

For DVD+RWs/DVD+Rs, the screen size is fixed at “4:3.”

“Rec NR” (noise reduction): Reduces noise contained in the video signal.

“Rec Video Equalizer”: Adjusts the picture in greater detail.

Press **↑/↓** to select the item you want to adjust, then press **ENTER**.

- Contrast: Changes the contrast.
- Brightness: Changes the overall brightness.
- Colour: Makes the colours deeper or lighter.

- 3 Adjust the setting using **←/↑/↓/→**, and press **ENTER**.

The default setting is underlined.

“Rec NR”: (weak) Off 1 ~ 2 ~ 3 (strong)

“Rec Video Equalizer”:

- Contrast: (weak) -3 ~ 0 ~ 3 (strong)
- Brightness: (dark) -3 ~ 0 ~ 3 (bright)
- Colour: (light) -3 ~ 0 ~ 3 (deep)

Repeat steps 2 and 3 to adjust any other items.

Notes

- If one programme contains two picture sizes, the selected size is recorded. However, if the 16:9 signal cannot be recorded as 16:9, it is recorded as 4:3.
- When playing a 16:9 size picture recorded as 4:3, the image is fixed to 4:3 Letter Box regardless of the setting in “TV Type” of “Video” setup (page 97).
- Remnants of images may appear on your screen when using “Rec NR.”
- “Rec Video Equalizer” does not affect the input of the DV IN jack and does not work with RGB signals.

Creating chapters in a title

The recorder can automatically divide a recording (a title) into chapters by inserting chapter marks at approximately 6 minute intervals during recording. To disable this function, set “Auto Chapter” in the “Recording” setup to “Off” (page 103). When recording to the HDD, a DVD-R (VR mode) or a DVD-RW (VR mode), you can insert and erase chapter marks manually (page 78).

Note

When dubbing (page 82), the chapter marks in the dubbing source are not retained in the dubbed title.

Checking/Changing/ Cancelling Timer Settings



You can change or cancel timer settings using the SCHEDULE list.

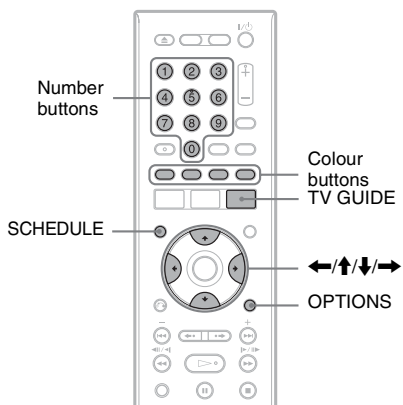

Changing timer settings

- 1 With the **GUIDE Plus+** system turned off, press **SCHEDULE**.

The SCHEDULE list appears.

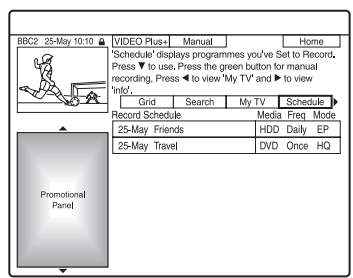

- 2 Select the timer setting you want to change using **↑/↓**.

3 Press the green button (“Edit”).

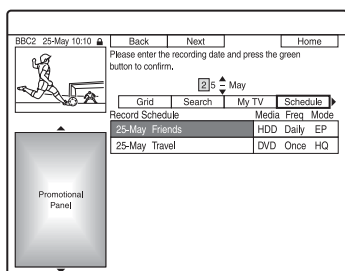

4 In the left column, select an item using the red button (“Back”) or the green button (“Next”), and adjust using the number buttons or ←/↑/↓/→.

You can change the date, start time, stop time, programme position, or input source.

The cursor moves to the right column.

5 Press the corresponding colour button repeatedly to change settings.

- Red button (“Media”): Sets the recording destination to either HDD or DVD.
- Green button (“Frequency”): Selects the recording pattern. The item changes as follows:
Once → Daily → Mon-Fri (Monday to Friday) → Mon-Sat (Monday to Saturday) → Sun (every Sunday) → → Sat (every Saturday) → Once
- Yellow button (“Rec Mode”): Selects the recording mode (page 52).

6 Press → to display “Extend Time.”

7 Press the yellow button (“Extend Time”) repeatedly to select the duration time or to set the PDC/VPS function.

The item changes as follows:

+0 Minutes → +10 Minutes →
+30 Minutes → +60 Minutes → VPS /
PDC → +0 Minutes

See “About the PDC/VPS function”
below.

Hint

You can also extend the recording time while recording by pressing OPTIONS and selecting “Extend Rec.”

Note

The new settings become effective when you exit the GUIDE Plus+ system.

About the PDC/VPS function

PDC/VPS signals are transmitted with TV programmes in some broadcast systems. These signals ensure that timer recordings are made regardless of any broadcast delays, early starts, or broadcast interruptions.

◆ To use the PDC/VPS function

Select “VPS / PDC” in step 7 above.

When you turn on this function, the recorder starts scanning the channels before the timer recording starts. If you are watching TV when scanning starts, a message will appear on the TV screen. If you want to watch TV, switch to your TV’s tuner or turn off the PDC/VPS channel scan function.

Note that if you turn off the PDC/VPS channel scan function, the timer recording will not start.

◆ To temporarily turn off PDC/VPS channel scan

Press OPTIONS and select “PDC/VPS Scan Off.”

To ensure that the PDC/VPS function works properly, turn off the recorder before the timer recording starts. This will automatically turn on the PDC/VPS channel scan function while the recorder remains off.

Canceling timer settings

- 1 With the **GUIDE Plus+** system turned off, press **SCHEDULE**.
The **SCHEDULE** list appears.
- 2 Select the timer setting you want to cancel using **↑/↓**.
- 3 Press the red button (“Delete”).

To close the **SCHEDULE** list

Press **TV GUIDE** or **SCHEDULE**.

When the timer settings overlap

The programme that starts first has priority and the second programme starts recording only after the first programme has finished.

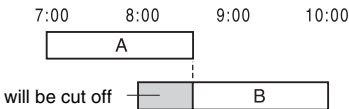

◆ When the recordings start at the same time

The programme that is set last has priority. In this example, timer setting B is set after A, so the first part of timer setting A will not be recorded.

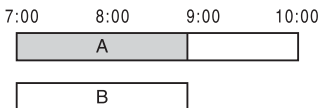

◆ When the end time of one recording and the start time of another are the same

After finishing the previous recording, the other recording may be delayed.

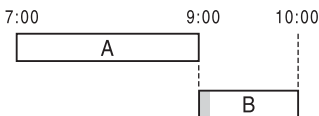

ⓘ Note

When “**PDC/VPS**” is set to “**On**” for one or more timer recordings, the start times may change in the event of a broadcast delay or early start.

Recording From Connected Equipment

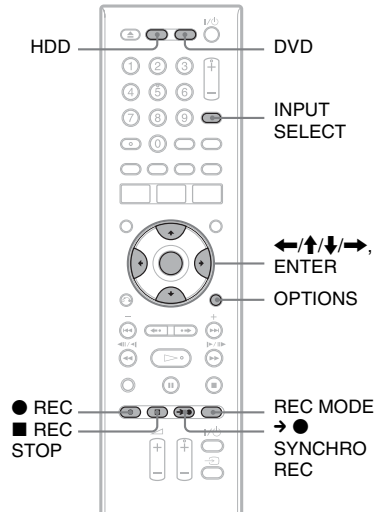

Recording from connected equipment with a timer (Synchro Rec)

You can set the recorder to automatically record programmes from connected equipment that has a timer function (such as a satellite tuner). Connect the equipment to the **LINE 3/DECODER** jack of the recorder (page 27).

When the connected equipment turns on, the recorder starts recording a programme from the **LINE 3/DECODER** jack.

- 1 **Before recording, select **HDD** or **DVD**.**
If you select **DVD**, insert a recordable DVD (see “1. Inserting a Disc” on page 32).
- 2 **Set “Synchro Rec” to “Record to **HDD**” or “Record to **DVD**” in the “Recording” setup (page 103).**

3 Press **INPUT SELECT** repeatedly to select "L3."

4 Select the desired audio signal when recording a bilingual programme to the HDD or DVD-RWs/DVD-Rs (VR mode).

Press **OPTIONS** to select "Line Audio Input," and press **ENTER**. Then select "Bilingual," and press **ENTER**. For details about bilingual recording, see page 53.

5 Press **REC MODE** repeatedly to select the recording mode.

For details about the recording mode, see page 52.

6 Set the timer on the connected equipment to the time of the programme you want to record, and turn it off.

7 Press **→ ● SYNCHRO REC**.

The **SYNCHRO REC** indicator lights up on the front panel. The recorder is ready to start Synchro-Recording. The recorder automatically starts recording when it receives an input signal from the connected equipment. The recorder stops recording when the connected equipment turns off.

⚡ Notes

- The recorder starts recording only after detecting a video signal from the connected equipment. The beginning of the programme may not be recorded regardless of whether or not the recorder's power is on or off.
- During Synchro-Recording, other operations, such as normal recording, cannot be performed.
- To use the connected equipment while the recorder is standing by for Synchro-Recording, cancel Synchro-Recording by pressing **→ ● SYNCHRO REC**. Be sure to turn off the connected equipment and press **→ ● SYNCHRO REC** to reset Synchro-Recording before the timer recording starts.
- The Synchro Rec function does not work when "Line3 Input" of "Scart Setting" is set to "Decoder" in the "Video" setup (page 99).
- The Synchro Rec function does not work with some tuners. For details, see the tuner's operating instructions.
- While the recorder is standing by for Synchro-Recording, the Auto Clock Set function (page 96) does not work.
- To use the Synchro Rec function, you must first set the recorder's clock correctly.

If the timer settings of a Synchro-Recording and another timer recording overlap

Regardless of whether or not the programme is a Synchro Rec programme, the programme that starts first has priority and the second programme starts recording only after the first programme has finished.

To stop recording

Press **■ REC STOP** or **→ ● SYNCHRO REC**.

To cancel Synchro Rec

Press **→ ● SYNCHRO REC**. The **SYNCHRO REC** indicator on the recorder turns off.

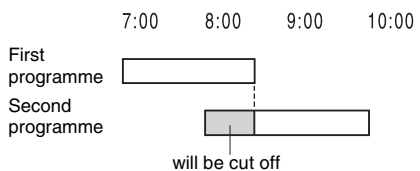

Recording from connected equipment without a timer

You can record from a connected VCR or similar device. To connect a VCR or similar device, see “Connecting a VCR or Similar Device” on page 27. Use the DV IN jack on the front panel if the equipment has a DV output jack (i.LINK jack).

1 Press HDD or DVD.

If you select DVD, insert a recordable DVD (see “1. Inserting a Disc” on page 32).

2 Press INPUT SELECT to select an input source according to the connection you made.

The front panel display changes as follows:

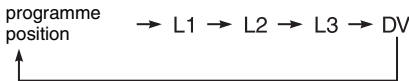

3 Select the desired audio signal when recording a bilingual programme to the HDD or DVD-RWs/DVD-Rs (VR mode).

Press OPTIONS to select “Line Audio Input,” and press ENTER. Then select “Bilingual,” and press ENTER.

For details about bilingual recording, see page 53.

4 Press REC MODE repeatedly to select the recording mode.

For details about the recording mode, see page 52.

5 Insert the source tape into the connected equipment and set to playback pause.

6 Press ● REC.

This recorder starts recording.

7 Press the pause (or play) button on the connected equipment to cancel the playback pause status.

The connected equipment starts playback and the playback image is recorded by this recorder.

To stop recording, press ■ REC STOP on this recorder.

If you connect a digital video camera with a DV IN jack

See “DV Dubbing” on page 88 for an explanation of how to record from the DV IN jack.

💡 Hint

You can adjust the settings for the recording picture before recording. See “Adjusting the recording picture quality and size” on page 58.

📌 Notes

- When recording a video game image, the screen may not be clear.
- Any programme that contains a Copy-Never copy guard signal cannot be recorded. The recorder continues to record, but a blank screen will be recorded.

Playing

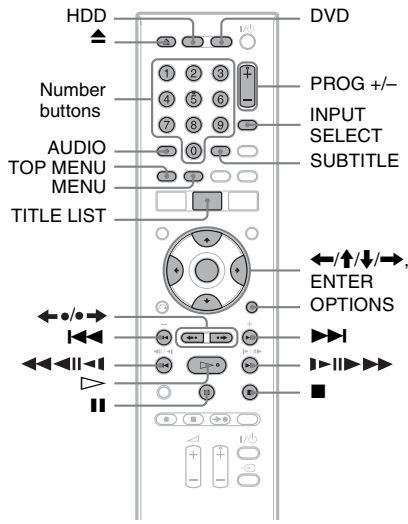

- 1 Press HDD or DVD.**
 - If you select DVD, insert a disc (see “1. Inserting a Disc” on page 32).
 - If you insert a DVD VIDEO, VIDEO CD, or CD, press \triangleright . Playback starts.

- 2 Press TITLE LIST.**

For details about the Title List, see “3. Playing the Recorded Programme (Title List)” on page 34.
Example: DVD+RW

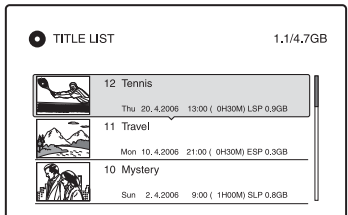

- 3 Select the title, and press ENTER.**
The sub-menu appears.
- 4 Select “Play,” and press ENTER.**
Playback starts from the selected title.

To use the DVD’s Menu
When you play a DVD VIDEO, or a finalised DVD+RW, DVD-RW (Video mode), DVD+R, or DVD-R (Video mode), you can display the disc’s menu by pressing TOP MENU or MENU.

To play VIDEO CDs with PBC functions
PBC (Playback Control) allows you to play VIDEO CDs interactively using the menu on your TV screen.
When you start playing a VIDEO CD with PBC functions, the menu appears.
Select an item using the number buttons and press ENTER. Then, follow the instructions in the menu (press \triangleright when “Press SELECT” appears).

The PBC function of Super VIDEO CDs does not work with this recorder. Super VIDEO CDs are played in continuous play mode only.

To change the angles
If various angles (multi-angles) for a scene are recorded on the disc, $\left[\text{camera icon} \right]$ appears in the front panel display. Press OPTIONS during playback to select “Change Angle,” and press ENTER.

To stop playback
Press \blacksquare .

To playback quickly with sound (Scan Audio)
When you press \gg during playback of a title recorded in the HDD, you can play quickly with dialogue or sound (“x1.3” appears).
No sound is output when you press \gg two or more times to change search speed.

To resume playback from the point where you stopped (Resume Play)

When you press \triangleright again after you stop playback, the recorder resumes playback from the point where you pressed \blacksquare .

To start from the beginning, press **OPTIONS** to select "Play Beginning," and press **ENTER**. Playback starts from the beginning of the title/track/scene.

The point where you stopped playing is cleared when:

- you open the disc tray (except for HDD).
- you play another title (except for HDD).
- you switch the Title List menu to Original or Playlist (HDD/DVD-RWs/DVD-Rs in VR mode only).
- you edit the title after stopping playback.
- you change the settings on the recorder.
- you turn off the recorder (VIDEO CD/CD/DATA DVD/DATA CD only).
- you make a recording (except for HDD/DVD-RWs/DVD-Rs in VR mode).
- you disconnect the mains lead.

Note

You cannot resume playback during TV Pause.

To play restricted DVDs (Parental Control)

If you play a restricted DVD, the message "Do you want to temporarily change the Parental Control level to * ?" appears on your TV screen.

- 1** Select "OK" and press **ENTER**.
The display for entering your password appears.
- 2** Enter your four-digit password using the number buttons.
- 3** Press **ENTER** to select "OK."
The recorder starts playback.

To register or change the password, see "Parental Control (DVD VIDEO only)" on page 103.

To lock the disc tray (Child Lock)

You can lock the disc tray to prevent children from ejecting the disc.

When the recorder is turned on, hold down \blacksquare until "LOCKED" appears in the front panel display. The \blacktriangle (open/close) button does not work while the Child Lock is set.

To unlock the disc tray, hold down \blacksquare until "UNLOCKED" appears in the front panel display when the recorder is turned on.

One Touch Play

If you use the SMARTLINK connection, you can easily start playing.

Press \triangleright . The recorder and your TV automatically turn on and the TV's input is switched to the recorder. Playback starts automatically.

One Touch Menu

If you use the SMARTLINK connection, you can easily display the Title List.

Press **TITLE LIST**. The recorder and your TV automatically turn on and the TV's input is switched to the recorder. The Title List appears.

















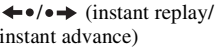







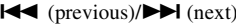

Hints

- You can also use the \triangleright button in step 3 (page 64) to start playback.
- Even if you select "Factory Setup" in the "Others" setup (page 106), the Child Lock remains set.

Playback options

To check the position of the buttons below, see the illustration on page 64.

For MP3 or JPEG operations, see “Playing MP3 Audio Tracks or JPEG Image Files” on page 71.

Buttons	Operations								
AUDIO      	Selects one of the audio tracks recorded on the disc when pressed repeatedly in normal playback mode. DVD : Selects the language. HDD -RWVR -RVR : Selects the main or sub sound. VCD CD : Selects stereo or monaural audio tracks.								
SUBTITLE 	Selects a subtitle language when pressed repeatedly.								
 (instant replay/ instant advance)        	Replays the scene/briefly fast forwards the scene.								
 (previous)/(next)	Goes to the beginning of the previous/next title/chapter/scene/track. For the HDD, you cannot go to the beginning of the previous/next title.								
 (fast reverse/fast forward)	Fast reverses/fast forwards the disc when pressed during playback. Search speed changes as follows: <div style="text-align: center; margin: 10px 0;"> <table style="margin: auto;"> <tr> <td style="text-align: center;">fast reverse</td> <td style="text-align: center;">fast forward</td> </tr> <tr> <td style="text-align: center;">◀◀1 ←</td> <td style="text-align: center;">→ 1▶▶*1</td> </tr> <tr> <td style="text-align: center;">◀◀2 ← ←</td> <td style="text-align: center;">→ → 2▶▶</td> </tr> <tr> <td style="text-align: center;">◀◀3*2 ← ← ←</td> <td style="text-align: center;">→ → → 3▶▶*2</td> </tr> </table> </div> When you press and hold the button, fast forward/fast reverse continues at the selected speed until you release the button. *1 When you press ▶▶ once during playback of a title recorded in the HDD, you can play quickly with sound (“x1.3” appears). *2 ◀◀3 and 3▶▶ are only available for the HDD and DVDs.	fast reverse	fast forward	◀◀1 ←	→ 1▶▶*1	◀◀2 ← ←	→ → 2▶▶	◀◀3*2 ← ← ←	→ → → 3▶▶*2
fast reverse	fast forward								
◀◀1 ←	→ 1▶▶*1								
◀◀2 ← ←	→ → 2▶▶								
◀◀3*2 ← ← ←	→ → → 3▶▶*2								
 (slow, freeze frame)          *	Plays in slow motion when pressed for more than one second in pause mode. Plays one frame at a time when pressed briefly in pause mode.								
* Playback direction only									
 (pause)	Pauses playback.								

To resume normal playback, press ▷.

Notes

- Angles and subtitles cannot be changed with titles recorded on this recorder.
- Slideshows made with a DVD camcorder can only be played. Other play functions, such as fast forward, cannot be used.

Notes on playing DTS sound tracks on a CD

- When playing DTS-encoded CDs, excessive noise will be heard from the analogue stereo jacks. To avoid possible damage to the audio system, the consumer should take proper precautions when the analogue stereo jacks of the recorder are connected to an amplification system. To enjoy DTS Digital Surround™ playback, an external DTS decoder must be connected to the DIGITAL OUT jack of the recorder.
- Set the sound to “Stereo” using the AUDIO button when you play DTS sound tracks on a CD (page 66).

Notes on playing DVDs with a DTS sound track

DTS audio signals are output only through the DIGITAL OUT (COAXIAL) jack.

When you play a DVD with DTS sound tracks, set “DTS” to “On” in the “Audio” setup (page 100).

Adjusting the picture quality



1 Press **OPTIONS** during playback to select “Video Settings,” and press **ENTER**.

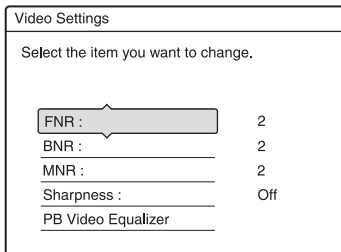

2 Select an item, and press **ENTER**.

The adjustment display appears.

“FNR” (frame noise reduction):

Reduces noise contained in the luminance element of the video signal.

“BNR” (block noise reduction):

Reduces “block noise” or mosaic like patterns in the picture.

“MNR” (mosquito noise reduction):

Reduces the faint noise appearing around the outlines of the images. The noise reduction effects are automatically adjusted within each setting range according to the video bit rate and other factors.

“Sharpness”:

Sharpens the outlines of the images.

“PB Video Equalizer” (Playback video equalizer):

Adjusts the picture in greater detail.

Select an item and press **ENTER**.

• Contrast: changes the contrast.

• Brightness: changes the overall brightness.

• Colour: makes the colours deeper or lighter.

• Hue: changes the colour balance.

3 Press **←/→** to adjust the setting, and press **ENTER**.

The default settings are underlined.

“FNR”: (weak) Off 1 2 3 (strong)

“BNR”: (weak) Off 1 2 3 (strong)

“MNR”: (weak) Off 1 2 3 (strong)

“Sharpness”*: (weak) Off 1 2 3 (strong)

“PB Video Equalizer”:

• Contrast: (weak) -3 ~ 0 ~ 3 (strong)

• Brightness: (dark) -3 ~ 0 ~ 3 (bright)

• Colour: (light) -3 ~ 0 ~ 3 (deep)

• Hue: (red) -3 ~ 0 ~ 3 (green)

Repeat steps 2 and 3 to adjust any other items.

* “1” softens the outlines of the images. “2” enhances the outlines and “3” enhances them more than “2.”

Notes

- If the outlines of the images on your screen become blurred, set “BNR” and/or “MNR” to “Off.”
- Depending on the disc or the scene being played, the above BNR, MNR, or FNR effects may be hard to discern. And, these functions may not work with some screen sizes.
- When using the “Sharpness” function, noise found in the title may become more apparent. In this case, it is recommended that you use the BNR function with the “Sharpness” function. If the condition still does not improve, set the “Sharpness” level to “Off.”

Adjusting the delay between the picture and sound (AV SYNC)



- 1 Press **OPTIONS** during playback to select “Audio Settings,” and press **ENTER**.
- 2 Select “AV SYNC”, and press **ENTER**. “AV SYNC”:
When the video is delayed, this function delays the audio for synchronization with the video (0 to 120 milliseconds). Larger numbers indicate a longer audio delay for synchronization with the video. When dubbing to a VCR or other video recording equipment, be sure to return this setting to 0 ms (default).
- 3 Press **←/→** to adjust the setting, and press **ENTER**.

Pausing a TV Broadcast (TV Pause)

You can pause a current TV broadcast, and then continue watching the programme at a later time. This is useful when you receive an unexpected phone call or visitor while watching TV.

1 While viewing a TV broadcast with this recorder, press **II**.

The picture pauses. You can pause the picture for up to three hours.

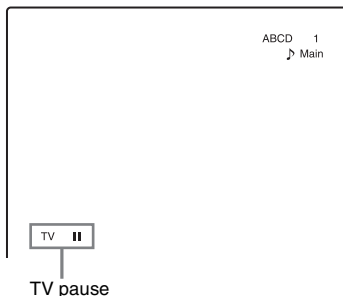

2 Press **II** or **▷** again to resume watching the programme.

Notes

- Paused titles are not saved to the HDD.
- This function is cancelled when:
 - **■** (stop) is pressed.
 - PROG +/- is pressed.
 - DVD is pressed.
 - **▲** (open/close) is pressed.
 - TITLE LIST is pressed.
 - INPUT SELECT is pressed.
 - the recorder is turned off.
 - a timer recording or Synchro-Recording is started.
 - the PDC/VPS function is “On” and channel scan is started.
 - DV dubbing or regular dubbing is started.
- It may take one minute or more to resume playback of the paused programme.
- Even if you fast forward the recorded programme, there will always be a time difference of about one minute or more between the recorded programme and the current TV broadcast.

Playing from the beginning of the programme you are recording (Chasing Playback)

HDD **-RWVR**

“Chasing Playback” allows you to view the recorded part of a programme while the recording is being made. You do not need to wait until the recording finishes.

Press **OPTIONS** while recording to select “Chasing Playback,” and press **ENTER**.

Playback starts from the beginning of the programme you are recording.

When you fast forward to the point that you are recording, Chasing Playback returns to normal playback.

Notes

- For DVD-RWs (VR mode), this function does not work when recording:
 - on a 1x-speed DVD-RW.
 - in the HQ or HSP recording mode.
- The DVD’s picture on your TV screen freezes for a few seconds when you fast forward/fast reverse or instant replay/advance the recording.
- Chasing Playback is possible from one minute or more after recording starts.
- Even if you fast forward the recorded programme, there will always be a time difference of about one minute or more between the recorded programme and the current TV broadcast.

Playing a previous recording while making another (Simultaneous Rec and Play)

HDD **+RW** **-RWVR** **-RWVideo** **+R**
-RVR **-RVideo** **DVD** **VCD** **CD**
DATA DVD **DATA CD**

“Simultaneous Rec and Play” allows you to view a previously recorded programme while recording programmes. Playback continues even if a timer recording starts. Use this function as follows:

- While recording to the HDD:
 Play another title on the HDD.
 Play a previously recorded programme on a DVD by pressing **DVD**.

- While recording to a DVD:
 Play a previously recorded programme on the HDD by pressing **HDD**.
- While recording to a DVD-RW (VR mode)*1:
 Play another title on the same DVD-RW (VR mode) disc.*2

*1 Simultaneous Rec and Play function does not work when you record:

- on a 1x-speed DVD-RW.
- in the HQ or HSP recording mode.

*2 Picture noise may appear depending upon the condition of the recording, or when playing a title recorded in the HQ or HSP recording mode. The picture freezes for a few seconds when you use fast forward/fast reverse or instant replay/advance.

You can also play a DVD VIDEO, VIDEO CD, Super VIDEO CD, CD, DATA DVD, or DATA CD while recording on the HDD.

Example: Play another title on the HDD while recording to the HDD.

- 1 While recording, press **TITLE LIST** to display the HDD Title List.
- 2 Select the title you want to play, and press **ENTER**.
- 3 Select “Play” from the sub-menu, and press **ENTER**.
 Playback starts from the selected title.

Example: Play a DVD while recording to the HDD.

- 1 While recording, press **DVD** and insert the DVD into the recorder.
- 2 Press **TITLE LIST** to display the DVD Title List.
- 3 Select the title you want to play, and press **ENTER**.
- 4 Select “Play” from the sub-menu, and press **ENTER**.
 Playback starts from the selected title.

Note

You cannot play a DVD or VIDEO CD recorded in the NTSC colour system while recording on the HDD. When playing a VIDEO CD, be sure to set “Colour System” to “PAL” in the “Video” setup (page 99).

Searching for a Title/Chapter/Track, etc.



You can search a disc by title, chapter, scene or track. As titles and tracks are assigned individual numbers, select the title or track by entering its number. You can also search for a scene using the time code.

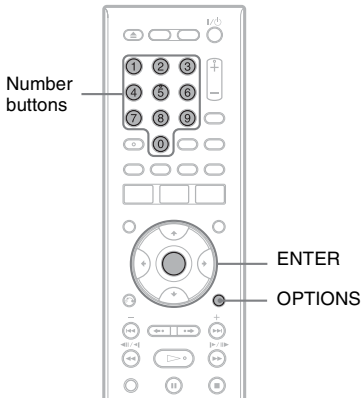

1 Press **OPTIONS** during playback to select a search method, and press **ENTER**.

- “Title Search” (for DVDs)
- “Chapter Search” (for HDD/DVDs)
- “Track Search” (for CDs/DATA CDs)
- “Search” (for VIDEO CDs)
- “Album Search” (for DATA DVDs/DATA CDs)
- “Time Search” (for HDD/DVDs): Searches for a starting point by entering the time code.
- “File Search” (for DATA DVDs/DATA CDs)

The display for entering the number appears.

Example: Title Search



The number in parentheses indicates the total number of titles, tracks, etc.

2 Press the number buttons to select the number of the title, chapter, track, time code, etc., you want.

For example: Time Search

To find a scene at 2 hours, 10 minutes, and 20 seconds, enter “21020.”

If you make a mistake, select another number.

3 Press **ENTER**.

The recorder starts playback from the selected number.

Note

“Title Search” is not applicable to the HDD.

Playing MP3 Audio Tracks or JPEG Image Files

DATA DVD DATA CD

You can play MP3 audio tracks and JPEG image files on DATA CDs (CD-ROMs/CD-Rs/CD-RWs) or JPEG image files on DATA DVDs (DVD-ROMs/DVD+RWs/DVD+Rs/DVD-RWs/DVD-Rs).

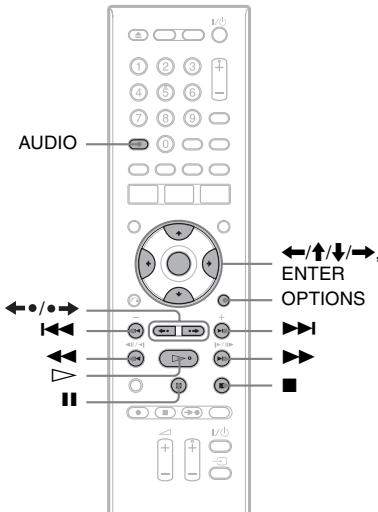

1 Insert a disc.

See “1. Inserting a Disc” on page 32.

2 Press .

For MP3 discs, playback starts from the first MP3 audio track on the disc.

For JPEG files, a slideshow of the pictures on the disc begins.

If the disc contains MP3 audio tracks and JPEG image files, only the JPEG image files are played back when  is pressed.

To stop playback or slideshow

Press .

To pause playback or slideshow

Press .





To play the beginning of the track

Press OPTIONS to select “Play Beginning,” and press ENTER.

To fast forward or review a track

Press  during playback.

To go to the next or previous MP3 audio track or JPEG image file

Press  or  during playback. If you repeatedly press  or , you will go to the next or previous album. (MP3 audio track only)



To go to the next or previous album

Press  or  during playback or slideshow.

To rotate a picture

Press OPTIONS while the JPEG image is displayed to select “Rotate Right” or “Rotate Left,” and press ENTER.

Hints

- Press the AUDIO button to switch between stereo or monaural audio tracks.
- You can rotate a JPEG image by using the  or  buttons when the image is displayed.

Notes

- Some JPEG files, especially files of three million pixels or more, may lengthen the slideshow interval.
- Rotated JPEG images will not be saved when you switch to another folder.
- Images larger than 720 × 480 will be reduced to 720 × 480 when displayed.
- The following images are not displayed:
 - progressive JPEG image files
 - greyscale JPEG image files
 - 4:1:1 JPEG image files
- When you attempt to play a broken file or a file that does not satisfy the play conditions,  appears but the recorder cannot play the file.

About MP3 audio tracks and JPEG image files

MP3 is an audio compression technology that satisfies certain ISO/MPEG regulations.

JPEG is an image compression technology. You can play MP3 (MPEG1 Audio Layer 3) format audio tracks and JPEG image files on DATA CDs (CD-ROMs/CD-Rs/CD-RWs) or JPEG image files on DATA DVDs (DVD-ROMs/DVD+RWs/DVD+Rs/DVD-RWs/DVD-Rs).

DATA CDs must be recorded according to ISO9660 Level 1, Level 2 or Joliet format for the recorder to recognize the MP3 tracks.

You can also play discs recorded in MultiSession/Border.

See the instructions supplied with the disc drives and the recording software (not supplied) for details on the recording format.

Note on MultiSession/Border discs

If audio tracks and images in Music CD format or Video CD format are recorded in the first session/border, only the first session/border will be played back.

Note

The recorder may not be able to play some DATA CDs created in the Packet Write format.

MP3 audio tracks or JPEG image files that the recorder can play

The recorder can play the following tracks and files:

- MP3 audio tracks with the extension “.mp3.”
 - JPEG image files with the extension “.jpeg” or “.jpg.”
 - JPEG image files that conform to the DCF* image file format.
- * “Design rule for Camera File system”: Image standards for digital cameras regulated by JEITA (Japan Electronics and Information Technology Industries Association).

Notes

- The recorder will play any data with the extension “.mp3,” “.jpeg,” or “.jpg,” even if they are not in MP3 or JPEG format. Playing these data may generate a loud noise which could damage your speaker system.
- The recorder does not conform to audio tracks in mp3PRO format.
- Some files cannot be played.
- The letters that cannot be displayed are replaced with “*.”

About playback order of albums, tracks, and files

Albums play in the following order:

Structure of disc contents

Tree 1 Tree 2 Tree 3 Tree 4 Tree 5

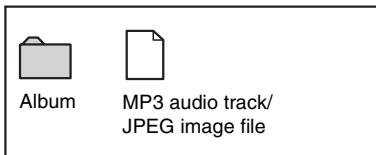
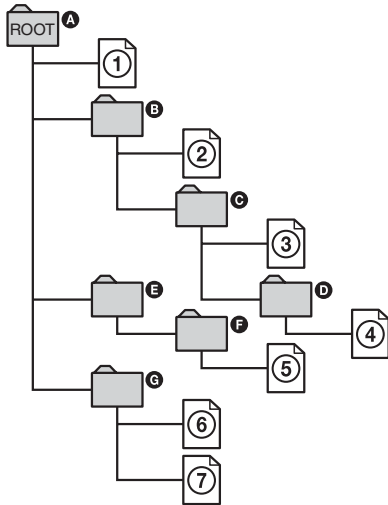

When you insert a DATA CD/DATA DVD and press \triangleright , the numbered tracks (or files) are played sequentially, from ① through ⑦. For JPEG image files, press $\bullet \rightarrow$ to go to the next album. (For instance, when you want to go from ① to ②.) Any sub-albums/tracks (or files) contained within a currently selected album take priority over the next album in the same tree. (Example: C contains D so ④ is played before ⑤.)

Hints

- If you add numbers (01, 02, 03, etc.) to the front of the track/file names when you store the tracks (or files) in a disc, the tracks and files will be played in that order.
- Since a disc with many trees takes longer to start playback, it is recommended that you create albums with no more than two trees.

Notes

- Depending on the software you use to create the DATA DVD/DATA CD, the playback order may differ from the above illustration.
- No more than a total of 999 individual folders can be played. (Folders that do not contain JPEG/MP3 files are counted as well.)
- No more than a total of 999 folders and 9999 files can be played. (Files other than JPEG/MP3 files, and folders that do not contain JPEG/MP3 files are counted as well.)
- No more than 999 folders and files can be recognized in a single folder. (Folders that do not contain JPEG/MP3 files are counted as well.)
- Proceeding to the next or another album may take some time.
- This recorder supports MP3 audio bit rates up to 320 kbps.

Before Editing

This recorder offers various edit options for various disc types.

Notes

- You may lose the edited contents if you remove the disc or a timer recording starts while editing.
- DVD discs created by DVD video cameras cannot be edited on this recorder.
- If a message appears and indicates that the disc's control information is full, erase or edit unnecessary titles.
- When editing a DVD+R or DVD-R, finish all editing before finalising the disc. You cannot edit a finalised disc.

Edit features	HDD		-RWVR -RVR		+RW -RW _{Video} +R -R _{Video}
	Original title	Playlist title	Original title	Playlist title	
Erase (page 75)	Yes	Yes	Yes	Yes	Yes
Protect (page 75)	Yes	Yes	Yes	No	Yes
Title Name (page 75)	Yes	Yes	Yes	Yes	Yes
A-B Erase (page 76)	Yes	Yes	Yes	Yes	Yes*
Erase Titles (page 76)	Yes	Yes	Yes	Yes	Yes
Divide (page 77)	Yes	Yes	No	Yes	No
Set Thumbnail (page 75)	Yes	Yes	Yes	Yes	No
Chapter mark (page 78)	Yes	Yes	Yes	Yes	No
Create a Playlist (page 78)	Yes	No	Yes	No	No
Make a Playlist (page 80)	Yes	No	Yes	No	No
Change Order (page 80)	No	No	No	Yes	No
Combine (page 81)	No	Yes	No	Yes	No

* DVD+RW only

To open up disc space

To open up disc space on a DVD+RW or DVD-RW (Video mode), erase the title with the largest number in the title list.

Largest title number

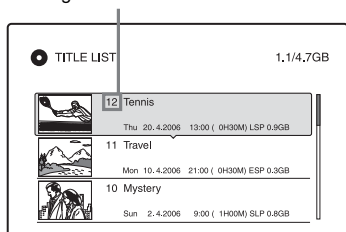

For the HDD and DVD-RWs (VR mode), you can erase any title.

For DVD-Rs and DVD+Rs, the available disc space does not increase even if you erase titles.

See “Erasing and Editing a Title” on page 75 or “Erasing multiple titles (Erase Titles)” on page 76.

To switch between the Playlist and Title List

You can display the Playlist titles in the Title List (Playlist), or the original titles in the Title List (Original). To switch the two Title Lists, press **←/→** while a Title List is displayed. To create and edit a Playlist, see page 78.

Erasing and Editing a Title



This section explains the basic edit functions. Note that editing is irreversible. To edit the HDD or DVD-RWs/DVD-Rs (VR mode) without changing the original recordings, create a Playlist title (page 78).

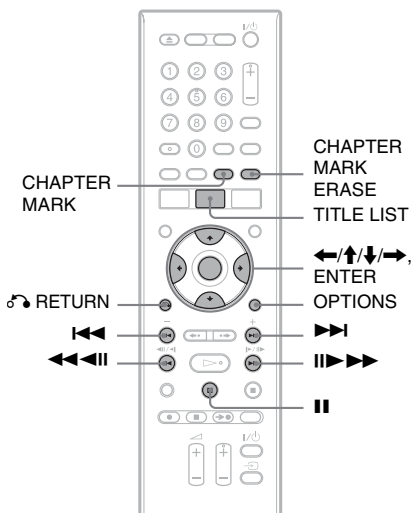

1 Press TITLE LIST.

For HDD titles or DVD-RWs/DVD-Rs in VR mode, press **←/→** to switch the Title Lists, if necessary.

2 Select a title, and press ENTER.

The sub-menu appears.

3 Select an option, and press ENTER.

You can make the following edits to the title.

“Erase”: Erases the selected title. Select “OK” when asked for confirmation.

“Protect”: Protects the title. “” appears next to the protected title.

“Title Name”: Allows you to enter or re-enter a title name (page 38).

“A-B Erase”: Erases a section of the title (page 76).

“Divide”: Divides a title into two titles (page 77).

“Set Thumbnail”: Changes the title’s thumbnail picture that appears in the Title List (page 35).

“Make a Playlist”: Adds the entire title to the Playlist title as one scene (page 80).

Hints

- You can erase multiple titles at one time (page 76).
- You can automatically erase titles that have already played (page 102).
- You can label or re-label DVDs (page 39).

Note

DVD-RW/DVD-R (VR mode) playlist titles cannot be protected.

Erasing multiple titles (Erase Titles)



You can select and erase more than one title at one time using the OPTIONS menu.

1 Press TITLE LIST.

For HDD titles or DVD-RWs/DVD-Rs in VR mode, press \leftarrow/\rightarrow to switch the Title Lists, if necessary.

2 Press OPTIONS to select “Erase Titles,” and press ENTER.

The display for selecting titles to be erased appears.

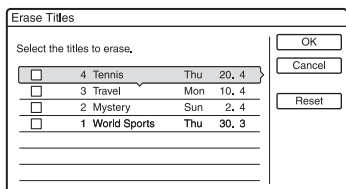

3 Select a title, and press ENTER.

A check mark appears in the check box next to the selected title.

- To clear the check mark, press ENTER again.
- To clear all of check marks, select “Reset.”

4 Repeat step 3 to select all of the titles you want to erase.

5 When you finish selecting titles, select “OK,” and press ENTER.

The list of the titles to be erased appears for confirmation.

- To change the selection, select “Change,” and repeat from step 3.

6 Select “OK” and press ENTER.

The titles are erased.

To erase all titles on the disc

You can reformat the HDD, DVD+RW, or DVD-RW to make the disc or drive blank. To format the HDD, see “Format” on page 106.

To format a DVD+RW or DVD-RW disc, see “8. Reformatting a disc” on page 42.

Erasing a section of a title (A-B Erase)



You can select a section (scene) in a title and erase it. Note that erasing scenes in a title cannot be undone.

1 After step 2 of “Erasing and Editing a Title,” select “A-B Erase” and press ENTER.

The display for setting point A appears. The title starts to play.

- To return to the beginning of the title, press II and then press $\text{II} \leftarrow$.

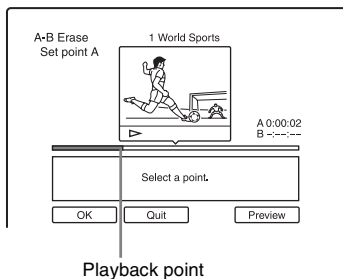

Playback point

2 Select point A using \leftarrow/\rightarrow , and press ENTER.

Playback pauses.

3 Press ENTER if point A is correct.

If point A is incorrect, select point A using ◀II/II▶, and press ENTER. The display for setting point B appears.

4 Select point B using ◀◀/▶▶, and press ENTER.

Playback pauses.

5 Press ENTER if point B is correct.

If point B is incorrect, select point B using ◀II/II▶, and press ENTER. The display asks for confirmation.

- To reset point A, press ↑ and ↻ RETURN, and go to step 2.
- To reset point B, press ↑ and repeat step 4.
- To preview the title without scenes to be erased, select "Preview" (except for DVD+RWs).

6 Select "OK," and press ENTER.

The scene is erased. The display for setting point A appears.

- To continue, go to step 2.
- To finish, select "Quit."

💡 Hint

A chapter mark is inserted after the scene was erased. The chapter mark divides the title into separate chapters on either side of the mark.

🔌 Notes

- Images or sound may be momentarily interrupted at the point where you erase a section of a title.
- Sections shorter than five seconds may not be erased.
- For DVD+RWs, the erased section may be slightly different from the points you selected.

Dividing a title (Divide)

HDD -RWVR* -RVR*

If you want to dub a long title to a disc but do not want to reduce the picture quality, divide the title into two shorter titles. Note that dividing a title cannot be undone.

* Only playlist titles can be divided for DVD-RWs/DVD-Rs (VR mode).

1 Press TITLE LIST.

Press ◀/▶ to switch the Title Lists, if necessary.

2 Select a title, and press ENTER.

The sub-menu appears.

3 Select "Divide," and press ENTER.

The display for setting the dividing point appears, and the title starts to play.

- To return to the beginning of the title, press II and then press ◀◀.

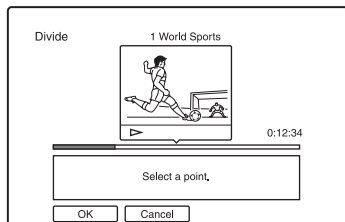
**4 Select the dividing point by pressing ◀◀/▶▶, and press ENTER.**

Playback pauses.

5 Press ENTER if the dividing point is correct.

If the dividing point is incorrect, select the dividing point using ◀II/II▶, and press ENTER. The display asks for confirmation.

- To change the dividing point, press ↑.

6 Select "OK," and press ENTER.

The title is divided in two.

💡 Hint

After a title is divided, the title name prior to division is assigned to both the first and second parts.

Creating chapters manually

HDD -RWVR -RVR

You can manually insert a chapter mark at any point you like during playback or recording.

Press CHAPTER MARK at the point where you want to divide the title into chapters.

Each time you press the button, “Marking ...” appears on the screen and the scenes to the left and right of the mark become separate chapters.

To erase chapter marks

You can combine two chapters by erasing the chapter mark during playback. Press **◀◀/▶▶** to search for a chapter number, and while displaying the chapter containing the chapter mark you want to erase, press CHAPTER MARK ERASE. The current chapter combines with the previous chapter.

⚡ Notes

- When dubbing, any chapter marks you enter will be erased.
- To insert a chapter mark manually during recording, set “Auto Chapter” to “Off” in the “Recording” setup.

Creating and Editing a Playlist

HDD -RWVR -RVR

Playlist edit allows you to edit or re-edit without changing the actual recordings. You can create up to 97 Playlist titles.

Example: You have recorded the final few matches of a football tournament on a DVD-RW/DVD-R (VR mode). You want to create a digest with the goal scenes and other highlights, but you also want to keep the original recording.

Original

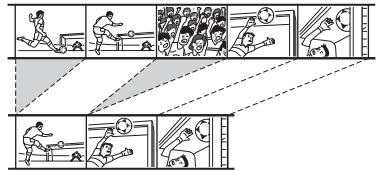

Playlist

In this case, you can compile highlight scenes as a Playlist title. You can even rearrange the scene order within the Playlist title. The Playlist title calls up data from the original titles for playback. When an original title is used for a Playlist title, the original title cannot be edited and erased.

⚡ Note

Playlist titles containing titles recorded with the “Copy-Once” copy protection signal cannot be dubbed or moved (page 84).

- 1 Press TITLE LIST.**
If the Title List (Original) appears, press **←**.
- 2 Press OPTIONS to select “Create a Playlist,” and press ENTER.**

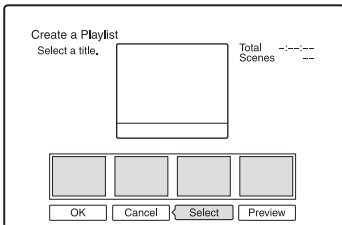

- 3 Select “Select,” and press ENTER.**

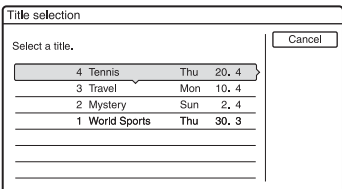

- 4 Select the title you want to include in the Playlist title, and press ENTER.**
The display for setting the start point (IN) appears. The title starts to play.
 - To return to the beginning of the title, press **II** and then press **◀◀**.

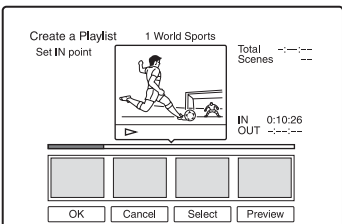

- 5 Select the IN point using ◀◀/▶▶, and press ENTER.**
Playback pauses.
- 6 Press ENTER if the IN point is correct.**
If the IN point is incorrect, select the IN point using **◀II/II▶**, and press ENTER. The display for setting the end point (OUT) appears.

- 7 Select the OUT point using ◀◀/▶▶, and press ENTER.**
Playback pauses.
- 8 Press ENTER if the OUT point is correct.**
If the OUT point is incorrect, select the OUT point using **◀II/II▶**, and press ENTER. The selected scene is added to the scene list.
 - To add more scenes, go to step 5.
- 9 When you finish adding scenes, press ↓.**

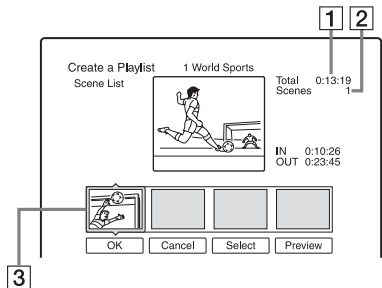

- 1 Total duration of the selected scene**
- 2 Total number of scenes**
- 3 Selected scene**
- 10 Select the scene you want to re-edit, and press ENTER.**
The sub-menu appears.
 - “Move”: Changes the scene order using **◀/▶** and press ENTER.
 - “Erase”: Erases the scene. When asked for confirmation, select “OK.”
 - To add more scenes, press **↑** and go to step 5.
 - To add more scenes from another title, select “Select” and go to step 4.
 - To preview all of the captured scenes in the listed order, select “Preview.”
- 11 When you finish editing the scene list, select “OK,” and press ENTER.**
The title of the created Playlist is added to the Title List (Playlist). The title name is the title name of the first scene.

Hint

When a Playlist title is created, the IN and OUT points will become chapter marks, and each scene will become a chapter.

Note

The picture may pause when the edited scene is played.

To add the entire title to the Playlist title as one scene (Make a Playlist)

- 1 Press TITLE LIST. If the Title List (Playlist) appears, press **→**.
- 2 Select the title and press ENTER. The sub-menu appears.
- 3 Select “Make a Playlist,” and press ENTER. The selected title is added to the Title List (Playlist). The title name is the same as the Original title name.

To play the Playlist title

- 1 Press TITLE LIST. If the Title List (Original) appears, press **←**.
- 2 Select a title, and press ENTER. The sub-menu appears.
- 3 Select “Play,” and press ENTER.

Moving a Playlist title (Change Order)

-RWVR **-RVR**

You can change the Playlist title order within the Title List (Playlist).

- 1 Press TITLE LIST. If the Title List (Original) appears, press **←**.
- 2 Press OPTIONS to select “Change Order,” and press ENTER.

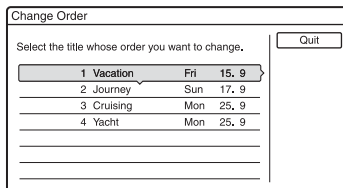

- 3 Select the title you want to move, and press ENTER.
- 4 Select a new location for the title using **↑/↓**, and press ENTER. The title moves to the new location.
 - To move more titles, go to step 3.
 - To finish, select “Quit,” and press ENTER.

Combining multiple Playlist titles (Combine)

HDD -RWVR -RVR

1 Press TITLE LIST.

If the Title List (Original) menu appears, press ←.

2 Press OPTIONS to select “Combine,” and press ENTER.

The display for selecting titles appears.

3 Select a title, and press ENTER.

A number indicating the order in which you selected the title appears.

To cancel the selection, press ENTER again.

Combine

Select the titles to combine.

4	Yacht	Mon	25, 9
3	Cruising	Mon	25, 9
2	Journey	Sun	17, 9
1	Vacation	Fri	15, 9

Buttons: OK, Cancel, Reset

4 Repeat step 3 to select all of the titles you want to combine.

To cancel all of the selections, select “Reset.”

5 Select “OK,” and press ENTER.

The list of titles to be combined appears. To change the selection, select “Change” and go to step 3.

Combine

Combine the titles in the following order.

4	Yacht	Mon	25, 9
3	Cruising	Mon	25, 9

Buttons: OK, Change, Cancel

6 Select “OK,” and press ENTER.

The titles are combined.

Hint

After titles are combined, the title name is the title name of the first title prior to combination.

Note

When the number of chapters in the title to be combined exceeds the limit, the chapters at the end are combined into a single chapter.

Dividing a Playlist title (Divide)

HDD -RWVR -RVR

You can divide a Playlist title. For operations, see page 77.

Dubbing (HDD ↔ DVD)

Before Dubbing

HDD +RW -RWVR -RWVideo +R
-RVR -RVideo

In this section, “dubbing” refers to “copying a recorded title on the internal hard disk drive (HDD) to another disc, or vice versa.” You can select to dub one title at a time (Title Dubbing – see “Dubbing a single title (Title Dubbing)” on page 85), or multiple titles all at once (Multiple Title Dubbing – see “Dubbing multiple titles (Dub Selected Titles)” on page 86).

Before you start, read the following precautions, which are common to both dubbing methods.

If you want to record from a digital video camera connected to the DV IN jack, see “DV Dubbing” on page 88. To record from equipment connected to the LINE IN jacks, see “Recording from connected equipment without a timer” on page 63.

Before you start...

- You cannot record both the main and sub sound on DVD+RWs, DVD-RWs (Video mode), DVD+Rs, or DVD-Rs (Video mode). For bilingual programmes, set “Bilingual Recording” of “DVD Rec. Settings” to either “Main” (default) or “Sub” in the “Recording” setup (page 102).
- The chapter marks in the dubbing source are not retained in the dubbed title. When “Auto Chapter” is set to “On” in the “Recording” setup, chapter marks are automatically inserted at approximately 6 minute intervals.

Hints

- When you dub a Playlist title, it is recorded as an Original title.
- When dubbed from a DVD to the HDD, the picture size and the sound types originally recorded are retained.

Notes

- You cannot make a recording while dubbing.
- To play a dubbed disc on other DVD equipment, finalise the disc (page 40).
- You cannot dub from DVD VIDEOS to the HDD.
- Thumbnails that you have set for the originally recorded title (page 35) will not be retained in the dubbed title.
- When dubbing to a DVD+R DL disc, the video may be momentarily interrupted at the point where the layers switch.

About “Dub Mode”

With this recorder, the recording mode for dubbing is displayed as “Dub Mode.” Three dubbing methods are available: High-speed Dubbing, Original Dubbing, and Rec Mode Conversion Dubbing. Read the following and select according to the required time, disc space, and picture quality.

Dubbing at high-speed (High-speed Dubbing)

HDD → +RW / -RWVR / -RWVideo / +R / -RVR / -RVideo

Allows you to dub what you have stored in the HDD to a high-speed DVD (8x-speed DVD+RWs/6x-speed DVD-RWs/16x-speed DVD+Rs/16x-speed DVD-Rs, or slower versions of each disc type), without changing the recording mode.

Set “Dub Mode” to “Fast” in the steps of “Dubbing a single title (Title Dubbing)” (page 85) or “Dubbing multiple titles (Dub Selected Titles)” (page 86).

When dubbing multiple titles, you can select “Fast” if there are one or more titles that can be dubbed at high speed in the selected titles. However, titles that cannot be dubbed at high speed are dubbed in the Original Dubbing mode.

The minimum required time is as follows (approximate).

Required times for High-speed Dubbing from HDD to DVD (for 60-minute programme)^{*1}

Speed ^{*2}	6x	6x	8x	8x	2.4x
Rec. mode	High-speed DVD-RW	High-speed DVD+RW	High-speed DVD-R	High-speed DVD+R	DVD+R (Double Layer)
HQ	Approx. 10 min.	Approx. 10 min.	Approx. 8 min.	Approx. 8 min.	Approx. 25 min.
HSP	Approx. 6 min. 40 sec.	Approx. 6 min. 40 sec.	Approx. 5 min. 5 min.	Approx. 5 min. 5 min.	Approx. 16 min. 40 sec.
SP	Approx. 5 min.	Approx. 5 min.	Approx. 3 min. 45 sec.	Approx. 3 min. 45 sec.	Approx. 12 min. 30 sec.
LSP	Approx. 4 min.	Approx. 4 min.	Approx. 3 min.	Approx. 3 min.	Approx. 10 min.
ESP	Approx. 3 min. 20 sec.	Approx. 3 min. 20 sec.	Approx. 2 min. 30 sec.	Approx. 2 min. 30 sec.	Approx. 8 min. 20 sec.
LP	Approx. 2 min. 30 sec.	Approx. 2 min. 30 sec.	Approx. 2 min. 2 min.	Approx. 2 min. 2 min.	Approx. 6 min. 15 sec.
EP	Approx. 1 min. 40 sec.	Approx. 60 min.* ³	Approx. 1 min. 15 sec.	Approx. 60 min.* ³	Approx. 60 min.* ³
SLP	Approx. 1 min. 15 sec.	Approx. 60 min.* ³	Approx. 56 sec.	Approx. 60 min.* ³	Approx. 60 min.* ³

^{*1} The values in the above table are for reference only. Actual times for dubbing also require time for creating disc's control information and other data.

^{*2} This is the maximum recording speed of this recorder. The recording speed cannot exceed the value indicated in the above table even when using discs that support higher recording speeds. In addition, depending on the disc condition, the recorder may be unable to record at the maximum recording speed indicated in the table.

^{*3} High-speed dubbing is not available when dubbing titles recorded in EP and SLP mode to DVD+RWs and DVD+Rs.

Notes

- High-speed Dubbing is not available for the following titles:
 - Titles recorded in HQ+.
 - Titles that contain both main and sub sounds (except DVD-RWs/DVD-Rs (VR mode)).
 - Titles recorded in mixed picture size (4:3 and 16:9 etc.) (except DVD-RWs/DVD-Rs (VR mode)).
 - Dubbing from DVD to HDD
 - Dubbing 16:9 size title from HDD to DVD+RW/DVD+R
 - When dubbing a title with a picture size of 16:9 recorded in LP, EP, or SLP mode to a DVD-RW or DVD-R in Video mode.
- When dubbed to a DVD-RW (Video mode)/DVD+RW/DVD+R/DVD-R (Video mode), the "seams" that are left over from editing may remain on the disc. If you edit a title, use the Original Dubbing or Rec Mode Conversion Dubbing method. This will smooth out the "seams."

Original Dubbing



Original Dubbing allows you to make smooth dubbings by de-emphasizing the "seams" that are left over from editing. In this case, the recording mode is set to the same recording mode that the source title was recorded in. To set the "Dub Mode" to "Original," you must make your selection from the "Dub Selected Titles" display (page 86). Note that you cannot select "Original" when using the Dubbing method explained in "Dubbing a single title (Title Dubbing)" (page 85).

Note

If the recording mode of the dubbing source title is unknown when dubbing from a DVD to the HDD, "Dub Mode" is automatically set to "SP" in the "Dub Selected Titles" display (page 86).

Rec Mode Conversion Dubbing



Allows you to dub from the HDD to a DVD or vice versa, in a dubbing mode that differs from the original recordings. For example, when you dub an HQ title (data size is large) in SP mode, you can reduce the data size, saving more titles using less space.

Select a mode different from the original recording in “Dub Mode” in the steps of “Dubbing a single title (Title Dubbing)” (page 85) or “Dubbing multiple titles (Dub Selected Titles)” (page 86). When dubbing multiple titles, all of the selected titles will be recorded in same recording mode.

Hint

Dubbing in the recording mode of the source title smoothes out the “seams” that are left over from editing.

Notes

- For a title whose picture size (16:9 or 4:3) is mixed:
 - When dubbed from the HDD to DVD-RWs/DVD-Rs (Video mode), the picture size is determined by the setting in “DVD Rec. Picture Size” (page 58).
 - When dubbed from the HDD to DVD-RWs/DVD-Rs (Video mode) in LP, EP or SLP mode, the picture size is always 4:3.
 - When dubbed from HDD to DVD+RW or DVD+R, the picture size is always 4:3.
- The picture quality will not improve even if a title is converted to a recording mode of better picture quality.

Dubbing restriction

You cannot dub movies and other DVD VIDEOS to the HDD. Also, when dubbing from a DVD to the HDD, a grey, blank screen will be recorded for scenes that contain a copy protection signal.

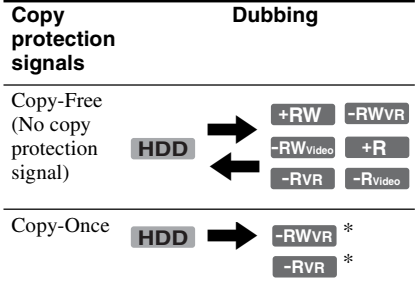

* CPRM-compatible DVD-RWs/DVD-Rs (VR mode) only
CPRM (Content Protection for Recordable Media) is a coding technology that protects copyrights for images.

Move



Titles containing “Copy-Once” copy protection signals can be moved only from HDD to DVD-RW/DVD-R (VR mode)* (after the title is moved, the original title in the HDD is erased). The “Move” function is performed using the same procedure as dubbing (page 85). Titles containing “Copy-Once” copy protection signals are indicated with .

Notes

- The following titles in the HDD cannot be moved.
 - Protected titles
 - Playlist titles
 - Original titles referenced from the playlist
- When dubbing (Move) is stopped partway, no part of the title will be moved to the dubbing target. However, note that this will decrease the free disc space for DVD+Rs/DVD-Rs.
- Even if you erase a scene that contains a copy protection signal, the recording restrictions on that title are retained.

* CPRM-compatible DVD-RWs/DVD-Rs (VR mode) only.

Dubbing



Dubbing a single title (Title Dubbing)

- 1 Insert the DVD that you are going to dub to or from.
- 2 Press **HDD** or **DVD** to select the source.
- 3 Press **TITLE LIST**.
Press **←/→** to switch the Title Lists, if necessary.
- 4 Select a title, and press **ENTER**.
The sub-menu appears.
- 5 Select “Dubbing,” and press **ENTER**.
The display for selecting the dubbing mode appears.
If a title with **COPY** (page 84) is selected in the title list, a confirmation display is displayed.
To “Move,” select “OK.”

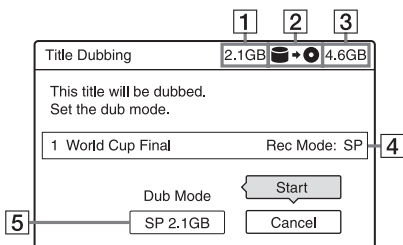

- 1 Size of the title (approximate)
This is displayed in red when the size exceeds the available space on the dubbing target media.
- 2 Direction of dubbing
- 3 Available space on the disc to be dubbed (approximate)
- 4 Information about the title to be dubbed
- 5 Dubbing mode and the space that remains after dubbing (approximate)

6 Select “Dub Mode.”

7 Select a dubbing mode using **↑/↓**.

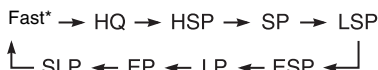

* From the HDD to a DVD only.
Appears when High-speed Dubbing is available for the title (page 82).

8 Select “Start,” and press **ENTER**.

The remaining time of dubbing appears in the front panel display.

To automatically adjust the dubbing mode

If there is not enough available space on the target disc, the recorder automatically selects a dubbing mode with lower picture quality according to the available space. If there is insufficient disc space in the selected dubbing mode, the following display appears after step 8.

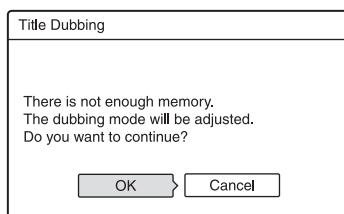

Select “OK” and go to step 8.
To manually select another dubbing mode, select “Cancel,” and go to step 7.

To stop dubbing

Press **OPTIONS** to select “Stop Dubbing,” and press **ENTER**. When asked for confirmation, select “OK,” and press **ENTER**.

When dubbing (Move) is stopped partway, no part of the title will be moved to the dubbing target. However, note that this will decrease the free disc space for DVD+Rs/DVD-Rs.

Hint

You can turn off the recorder during dubbing. The recorder completes dubbing even after being turned off.

Dubbing multiple titles (Dub Selected Titles)

A maximum of 30 selected titles can be dubbed at once.

- 1** Insert the DVD that you are going to dub to or from.
- 2** Press **HDD** or **DVD** to select the source.
- 3** Press **TITLE LIST**.
Press **←/→** to switch the Title Lists, if necessary.
- 4** Press **OPTIONS** to select “Dub Selected Titles,” and press **ENTER**.
- 5** Select titles in the order you want to dub, and press **ENTER**.

The titles are numbered in the selected order.

- To cancel the selection, press **ENTER** again.
- To cancel all of the selections, select “Reset.”

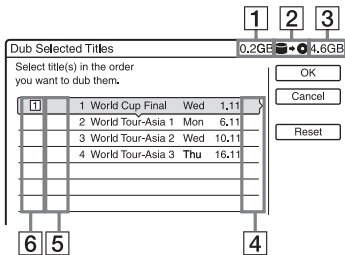

- 1** Total size of the selected titles
This is displayed in red when the size exceeds the available space on the dubbing target media.
- 2** Direction of dubbing
- 3** Available space on the disc to be dubbed (approximate)
- 4** “PL”: Indicates a Playlist title.

5 **COPY** : Indicates titles containing “Copy-Once” copy protection signals (page 84). When you select a title with **COPY**, the display asks for confirmation. To “Move,” select “OK.”

6 Order of dubbing

6 Repeat step 5 to select all of the titles you want to dub.

7 Select “OK,” and press **ENTER**.

The display for selecting the dubbing mode appears.

8 Select a dubbing mode using **↑/↓**.

Fast* → Original → HQ → HSP → SP

↑ SLP ← EP ← LP ← ESP ← LSP ↓

* From the HDD to a DVD only.

Appears when available for the title (page 82).

9 Select “Start,” and press **ENTER**.

The remaining time of dubbing appears in the front panel display.

To automatically adjust the dubbing mode

If there is not enough available space on the target disc, the recorder automatically selects a dubbing mode with lower picture quality according to the available space. The same dubbing mode is set for all of the titles. If disc space is insufficient for the selected dubbing mode, the following display appears after step 9 of “Dubbing multiple titles (Dub Selected Titles)” on page 86.

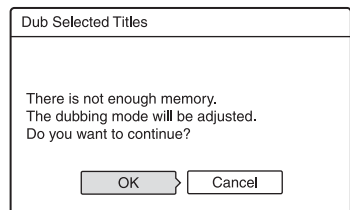

Select “OK” and go to step 9.

To manually select another dubbing mode, select “Cancel,” and go to step 8.

To stop dubbing

Press **OPTIONS** to select “Stop Dubbing,” and press **ENTER**. When asked for confirmation, select “OK,” and press **ENTER**.

When dubbing (Move) is stopped partway, no part of the title will be moved to the dubbing target. However, note that this will decrease the free disc space for DVD+Rs/ DVD-Rs.

Hint

You can turn off the recorder during dubbing. The recorder completes dubbing even after being turned off.

Before DV Dubbing

This section explains dubbing with a digital video camera via the DV IN jack on the front panel. If you want to dub by way of the LINE IN jacks, see “Recording from connected equipment without a timer” on page 63.

The DV IN jack on this recorder conforms to the i.LINK standard.

Follow the instructions in “Preparing for DV dubbing,” and then move on to the section on dubbing. For more information about i.LINK, see “About i.LINK” on page 116.

Preparing for DV dubbing

You can connect a digital video camera to the DV IN jack on the recorder to record or edit from a DV/Digital8 format tape. Operation is straightforward because the recorder will fast forward and rewind the tape for you – you do not need to operate your digital video camera. Do the following to start using the “DV Edit” functions of this recorder.

See the instruction manual supplied with the digital video camera as well before connecting.

Hint

If you plan to do additional editing on a disc after the initial dub, use the DV IN jack and record on a DVD-RW/DVD-R (VR mode) or HDD.

Notes

- You cannot make a recording while DV dubbing.
- The DV IN jack is for input only. It will not output signals.
- You cannot use the DV IN jack when:
 - signal input to the DV IN jack on the front panel or recorder operation cannot be performed correctly when using a digital video camera (see “About i.LINK” on page 116). Connect the camera to the LINE IN jack and follow the instructions of “Recording from connected equipment without a timer” on page 63.
 - the input signal is not in DVC-SD format. Do not connect a MICRO MV format digital video camera even if it has an i.LINK jack.
 - the images on the tape contain copy protection signals, which limit recording.
- If you want to play the disc on other DVD equipment, finalise the disc (page 40).

Hookups

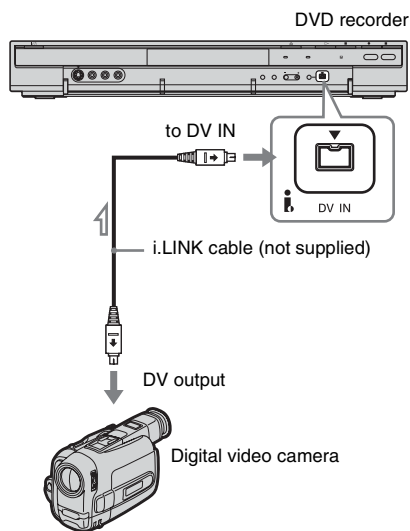

 : Signal flow

1 Press HDD or DVD to select the recording destination.

If you select DVD, insert a disc (see “1. Inserting a Disc” on page 32).

2 Insert the source DV/Digital8 format tape into your digital video camera.

For the recorder to record or edit, your digital video camera must be set to video playback mode.

3 Press INPUT SELECT on the remote repeatedly to select "DV."

The front panel display changes as follows:

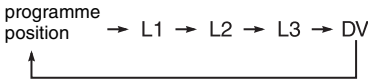

4 Press REC MODE on the remote repeatedly to select the recording mode.

The recording mode changes as follows:



For details about the recording mode, see page 52.

5 Press OPTIONS on the remote to select "DV Audio Input," and press ENTER. Then, select the setting for the audio input.

"Stereo1" (default): Records original sound only. Normally select this when dubbing a DV format tape.

"Mix": Records both stereo 1 and 2.

"Stereo2": Records additional audio only.

Select "Mix" or "Stereo2" only if you have added a second audio channel when recording with your digital video camera. You are ready to start dubbing. Select one of the dubbing methods on the following pages.

6 Adjust the dubbing picture quality and size.

Before dubbing starts, press OPTIONS to select "Rec Settings," and adjust the recording settings (page 58).

Notes

- You cannot connect more than one piece of digital video equipment to the recorder.
- You cannot control the recorder using another device or another recorder of the same model.
- You cannot record date, time, or the contents of the cassette memory onto the disc.
- If you record from a DV/Digital8 format tape that is recorded in multiple sound tracks, such as a tape with multiple sampling frequencies (48 kHz, 44.1 kHz, or 32 kHz), no sound or an unnatural sound will be output when playing back the sampling frequency switch point on the disc.
- In order to use this recorder's "Auto Chapter" setting (page 90, 91), be sure to correctly set the clock on your digital video camera before shooting.
- The recorded picture may be momentarily affected or the start and end points of a programme may be different from what you have set if the source DV/Digital8 format tape is in any of the following conditions. In this case, see "Recording from connected equipment without a timer" (page 63).
 - There is a blank space in the recorded portion of the tape.
 - The tape's time code is not sequential.
 - If the picture size or the recording mode on the tape being dubbed changes.

Hint

You can turn off the recorder during dubbing. The recorder completes dubbing even after being turned off.

Recording an Entire DV Format Tape (One Touch Dubbing)

HDD +RW -RWVR -RWVideo +R
-RVR -RVideo

You can record the entire contents of a DV/Digital8 format tape onto a disc with a single press of the ONE-TOUCH DUB button on the recorder. The recorder controls the digital video camera for the whole process, and completes the recording.

◆ How chapters are created

The contents dubbed to the HDD or DVD become a single title. When “Auto Chapter” is set to “On” in the “Recording” setup, this title is divided into chapters. When dubbing to the HDD or a DVD-RW/DVD-R (VR mode), each shooting session on the tape becomes a chapter on the disc. For other discs, the recorder divides the title into chapters at approximately 6 minute intervals.

Follow steps 1 to 6 of “Preparing for DV dubbing” on page 88, and press ONE-TOUCH DUB on the recorder.

The recorder rewinds the tape and then starts recording the tape contents.

When the recording is finished, the recorder rewinds the tape in the digital video camera.

To stop during recording

Press ■ REC STOP.

Note that it may take a few seconds for the recorder to stop recording.

💡 Hints

- If you set “Finalise Disc” of “One Touch Dubbing” to “Auto” in the “DVD” setup (page 105), the recorded disc (except DVD-RW (VR mode)) will automatically be finalised after recording is finished.
- You can play back a previously recorded title on the HDD while One Touch Dubbing is in progress.

🔊 Notes

- When a blank space between the recordings on the tape continues for more than five minutes, One Touch Dubbing ends automatically.
- The recorder records a blank for five minutes before it stops dubbing. To stop the blank recording, press ■ REC STOP.

Program Edit



You can select scenes from a DV/Digital8 format tape, and then automatically record selected scenes to the HDD or a DVD.

To use this function, do the following:

Connect your digital video camera and prepare for recording



Select and edit the scenes you want to dub

Using the recorder's remote control, fast forward or rewind the tape to select the scenes. At this point, the selected scenes are not copied to the disc. The recorder only remembers the IN and OUT points of the scenes that you selected for dubbing. You can also erase or change the order of the scenes.



Dub the selected scenes

After you have selected the scenes, the recorder will fast forward and rewind the tape automatically and record the scenes to the HDD or a DVD.

◆ How chapters are created

The contents dubbed to the HDD or DVD become a single title. When "Auto Chapter" is set to "On" in the "Recording" setup, this title is divided into chapters. When dubbing to the HDD or a DVD-RW/DVD-R (VR mode), each shooting session on the tape and each selected scene becomes a chapter on the disc. For other discs, the recorder divides the title into chapters at approximately 6 minute intervals.

1 Follow steps 1 to 6 of "Preparing for DV dubbing" on page 88, and press SYSTEM MENU.

2 Select "DV EDIT," and press ENTER.

The display asks if you want to start selecting scenes.

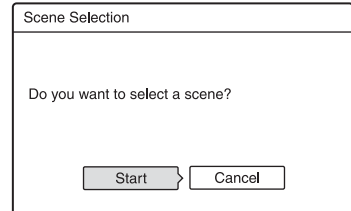

- If you have previously saved a programme, the display asks if you want to edit an existing programme or to create a new programme. To resume editing the existing programme, select "Saved Data," and go to step 9.

3 Select "Start," and press ENTER.

The display for setting the IN point (start of the scene) appears.

The scene starts to play.

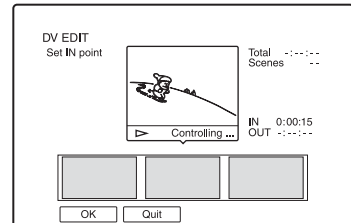

4 Select the IN point using ◀◀/▶▶, and press ENTER.

Playback pauses.

5 Press ENTER if the IN point is correct.

If the IN point is incorrect, select the IN point using ◀◀/▶▶, and press ENTER. The display for setting the OUT point (end of the scene) appears.

6 Select the OUT point using ◀◀/▶▶, and press ENTER.

Playback pauses.

7 Press ENTER if the OUT point is correct.

If the OUT point is incorrect, select the OUT point using ◀◀/▶▶, and press ENTER. The selected scene is added to the scene information block.

- To add more scenes, go to step 4.

8 When you finish adding scenes, press



The scene list is displayed.

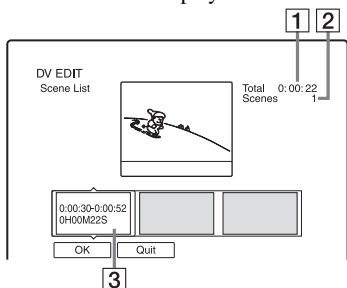

1 Total duration of the programme

2 Total number of scenes

3 Scene information block

9 Select the scene information block you want to edit using \leftarrow/\rightarrow , and press ENTER.

The sub-menu appears.

“Move”: Changes the scene order using \leftarrow/\rightarrow and ENTER.

“Erase”: Erases the scene. When asked for confirmation, select “OK.”

“Preview”: Plays the selected scene.

- To add more scenes, press \uparrow and go to step 4.

10 When you finish editing the scene list, select “OK,” and press ENTER.

The display for entering the title name appears. To enter a new name, select “Enter,” and follow the explanations on page 38.

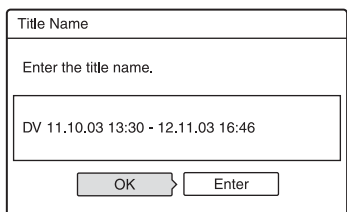

11 Select “OK,” and press ENTER.

The title name is fixed, and the display asks if you want to start recording.

To change the disc media, select “Media” and press \uparrow/\downarrow . To change the dubbing mode, select “Dub Mode” and press \uparrow/\downarrow .

Data capacity required for the dubbing. This is displayed in red when the size exceeds the available space on the dubbing target media.

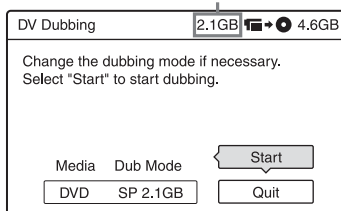

12 Select “Start,” and press ENTER.

The recorder starts recording the tape contents as programmed.

To stop during recording

Press \blacksquare REC STOP.

Note that it may take a few seconds for the recorder to stop recording.

To automatically adjust the dubbing mode

If there is not enough available space on the target disc, the recorder automatically selects a dubbing mode with lower picture quality according to the available space. The same dubbing mode is set for all of the titles. If disc space is insufficient for the selected dubbing mode, the following display appears after step 12.

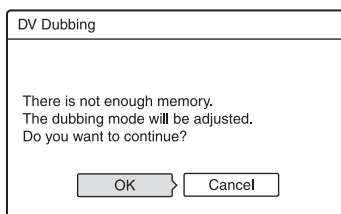

Select “OK” and go to step 12.

If you do not want to change the dubbing mode, select “Cancel.” However, note that dubbing will end before the program is finished.

Notes

- If you set the beginning of the tape as the IN point and the end point as the OUT point, the IN and OUT points may move slightly during dubbing.
- You cannot set a scene to be shorter than one second.

Settings and Adjustments

Aerial Reception and Language Settings (Basic)

The “Basic” setup helps you to make tuner, clock, and programme position settings for the recorder.

- 1 Press **SYSTEM MENU** while the recorder is in stop mode.
- 2 Select “**SETUP**,” and press **ENTER**.
- 3 Select “**Basic**,” and press **ENTER**.

The options for “Basic” appear. The default settings are underlined.

To turn off the display, press **SYSTEM MENU** repeatedly.

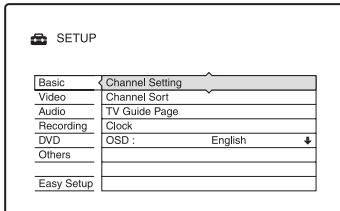

Channel Setting

Presets programme positions manually. If some programme positions could not be set using the “Easy Setup” function, you can set them manually.

If there is no sound or if the picture is distorted, the wrong tuner system may have been preset during “Easy Setup.” Set the correct tuner system manually in the steps below.

- 1 Select “**Channel Setting**” in “**Basic**,” and press **ENTER**.

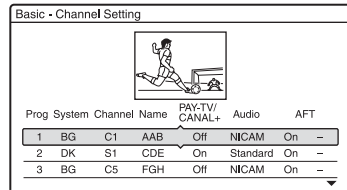

- 2 Press **↑/↓** to select the programme position, and press **ENTER**.

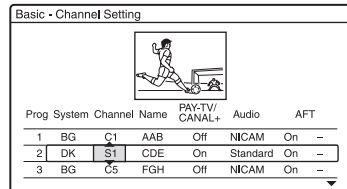

- 3 Select the item you want to change using **←/→**, and change the settings using **↑/↓** and press **ENTER**.

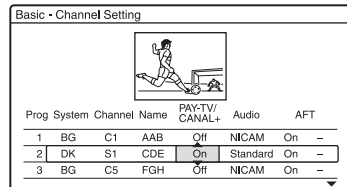

- 4 To preset another programme position, repeat from step 2.

System

Select an available TV system (page 94).

BG	Select this when in West European countries, except those listed in “Receivable channels” on page 94.
DK	Select this when in East European countries.
I	Select this when in Great Britain/Ireland.

Channel

Press \uparrow/\downarrow repeatedly until the programme position you want is displayed.

The programme positions are scanned in the order shown in the table below.

- If you know the number of the programme position you want, press the number buttons. For example, for programme position 5, first press "0" and then press "5."
- To disable a programme position, enter "00." The disabled programme positions will be skipped when you press PROG +/-.
- To select a cable or satellite programme position, press \uparrow/\downarrow until the programme position you want is displayed.

Name

Changes or enters a new station name (up to 5 characters). The recorder must receive programme position information (for instance, SMARTLINK information) for station names to appear automatically.

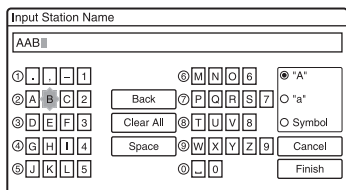

To enter characters, see page 38.

PAY-TV/ CANAL+

Sets the PAY-TV/Canal Plus channels. For details, see page 30.

Audio

Select "NICAM" or "Standard."

NICAM	Normally, select this.
Standard	Select this if the sound from NICAM broadcasts is not clear.

AFT

Select "On" to turn on AFT.

On	Turns on the Auto Fine Tuning function. Normally, select this.
Off	Allows you to adjust the pictures manually.

- If the Auto Fine Tuning function does not work effectively, select "Off" and press \rightarrow . Press \uparrow/\downarrow to obtain a clearer picture, and press \leftarrow .

◆ Receivable channels

TV system	Channel coverage
BG (West European Countries, except those listed below)	E2 – E12 VHF
	Italia A – H VHF
	E21 – E69 UHF
	S1 – S20 CATV
	S21 – S41 HYPER
	S01 – S05 CATV
DK (East European Countries)	R1 – R12 VHF
	R21 – R69 UHF
	S1 – S20 CATV
	S21 – S41 HYPER
	S01 – S05 CATV
I (Great Britain/Ireland)	Ireland A – J VHF
	South Africa 4 – 13 VHF
	B21 – B69 UHF
	S1 – S20 CATV
	S21 – S41 HYPER
	S01 – S05 CATV

Channel Sort

After the programme positions have been set, you can change the order of each programme position in the display list.

- 1 Select "Channel Sort" in "Basic," and press ENTER.

Prog	Channel	Name
1	C1	AAB
2	S1	CDE
3	C5	FGH

- 2 Press \uparrow/\downarrow to select the row containing the programme position you want to move, and press ENTER.
 - To display other pages for programme positions 4 to 99, press \uparrow/\downarrow repeatedly.
- 3 Press \uparrow/\downarrow until the selected programme position row moves to the desired programme position. The selected programme position is inserted at the new programme position.

Prog	Channel	Name
5	C3	-
6	S1	CDE
7	C12	-

- 4 Press ENTER to confirm the setting.
- 5 To change the programme position of another station, repeat from step 2.

Auto Programme Title Labelling (TV Guide Page)

Some broadcast systems provide a Teletext service* in which complete programmes and their data (title, date, programme position, recording start time, etc.) are stored day by day. A TV guide page corresponds to each day of the week. When recording a programme, the recorder automatically takes the programme name from the Teletext pages and stores it as the title name. The TV guide page numbers depend entirely on the broadcast itself and may be subject to change. If so, you may have to set those TV guide page numbers manually in the TV Guide Page menu.

* Not available in some areas.

- 1 Select "TV Guide Page" in "Basic," and press ENTER. The TV Guide Page menu appears.
- 2 Select the programme position for which you want to set or change the TV guide page using PROG +/- or number buttons.
 - The TV guide page numbers (Example: P301) appear automatically when the recorder detects them.

Day	Programme Number
Sun:	P 3 0 1
Mon:	P 3 0 2
Tue:	P 3 0 3
Wed:	P 3 0 4
Thu:	P 3 0 5
Fri:	P 3 0 6
Sat:	P 3 0 7

- If no page numbers are detected (P000), you have to set the appropriate TV guide page number manually.

Day	Programme Number
Sun:	P 0 0 0
Mon:	P 0 0 0
Tue:	P 0 0 0
Wed:	P 0 0 0
Thu:	P 0 0 0
Fri:	P 0 0 0
Sat:	P 0 0 0

- 3 Select the TV guide page number you want to modify, and press ENTER.

Basic - TV Guide Page		Prog,6
Sun:	P 3 0 1	
Mon:	P 3 0 2	
Tue:	P 3 0 3	
Wed:	P 3 0 4	
Thu:	P 3 0 5	
Fri:	P 3 0 6	
Sat:	P 3 0 7	

- 4 Press the number buttons or $\leftarrow/\uparrow/\downarrow/\rightarrow$ to enter the TV guide page number, and press ENTER to confirm the setting.
- If you make a mistake, re-enter the correct number.
 - To return to the original settings, press \rightarrow RETURN.
- 5 To set or change another TV guide page number, repeat steps 3 and 4 above.

Hint

To view Teletext information on your TV screen during a broadcast, switch to your TV's tuner by pressing TV/DVD.

Notes

- In step 4 above, enter "000" if you do not want to use the TV guide page number for automatic labelling. The recorder will instead store a default title name (programme position, start time - stop time).
- Refer to the Teletext information on your TV screen to obtain the TV guide page number with programme titles and their start times.
- If the Teletext TV guide has a page which always shows the programmes for the current day, this page should be input for all days.
- If you start recording more than three minutes before the programme is scheduled to start, the correct label information may not be transferred.
- Note that this function may not work correctly with programmes broadcast from some stations.
- If the broadcast system updates the Teletext information at the moment recording starts, the title label may not correspond to the recorded programme. In this case, you may have to manually enter the correct title (page 38).

Clock

Auto Adjust

Turns on the Auto Clock Set function when a programme position in your local area broadcasts a time signal.

- 1 Select "Clock" in "Basic," and press ENTER.
- 2 Select "Auto Adjust," and press ENTER.

Basic - Clock	
Auto Adjust :	Off 1 AAB
Present Time :	Sun 1.1.2006 0:00

- 3 Select "On," and press \rightarrow .
- 4 Press \uparrow/\downarrow repeatedly until the programme position of the station that carries a time signal appears, and press ENTER.

Basic - Clock	
Auto Adjust :	On 1 AAB
Present Time :	Sun 1.1.2006 0:00

- If the recorder does not receive a time signal from any station, "Auto Adjust" returns to "Off" automatically and the menu for setting the clock manually appears on the screen.

Hint

If you set "Auto Adjust" to "On," the Auto Clock Set function is activated whenever the recorder is turned off.

Note

The Auto Clock Set function does not work while the recorder is standing by for Synchro-Recording.

◆ To set the clock manually

If the Auto Clock Set function did not set the clock correctly for your local area, try another station for the Auto Clock Set function or set the clock manually.

- 1 Select "Clock" in "Basic," and press ENTER.
- 2 Select "Auto Adjust," and press ENTER.

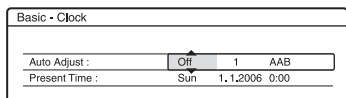

- 3 Select "Off," and press ENTER.
- 4 Select "Present Time," and press ENTER.

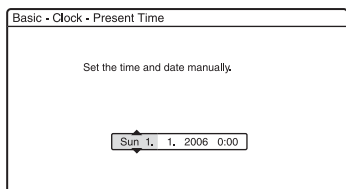

- 5 Press \uparrow/\downarrow to set the day, and press \rightarrow . Set the month, year, hour, and minutes in sequence. Press \leftarrow/\rightarrow to select the item to be set, then press \uparrow/\downarrow to set the numbers. The day of the week is set automatically.

To change the numbers, press \leftarrow to return to the item to be changed, and press \uparrow/\downarrow .

- 6 Press ENTER to start the clock.

OSD (On-Screen Display)

Switches the display language on the screen.

Video Settings (Video)

Video settings will adjust items related to the image, such as size and colour.

Choose the settings according to the type of TV, tuner, or decoder connected to the DVD recorder.

- 1 Press **SYSTEM MENU** while the recorder is in stop mode.
- 2 Select "SETUP," and press ENTER.
- 3 Select "Video," and press ENTER. The "Video" setup appears with the following options. The default settings are underlined>.

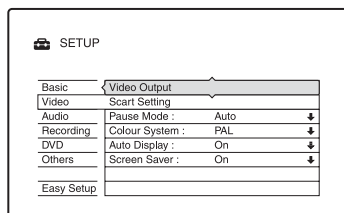

Video Output

◆ TV Type

Sets the picture size when playing back a title recorded from 16:9 size video (page 58) or a 16:9 size commercial DVD video.

Select the playback picture size according to the type of connected TV (wide-screen/wide mode TV or conventional 4:3 screen TV).

16:9	Select this when connecting to a wide-screen TV or TV with a wide mode function.
4:3 Letter Box	Select this when connecting to a 4:3 screen TV. Displays a wide picture with bands on the upper and lower portions of the screen.
4:3 Pan Scan	Select this when connecting to a 4:3 screen TV. Automatically displays a wide picture on the entire screen and cuts off the portions that do not fit.

16:9



4:3 Letter Box



4:3 Pan Scan



Note

Depending on the disc, “4:3 Letter Box” may be selected automatically instead of “4:3 Pan Scan” or vice versa.

◆ Component Out

Selects whether or not to output video signals from the COMPONENT VIDEO OUT jacks.

On	Outputs the component video signals. Select this when you want to view progressive signals.
Off	Outputs no signals.

Notes

- When you set “Line1 Output” to “RGB,” you cannot set “Component Out” to “On.”
- When you connect the recorder to a monitor or projector via only the COMPONENT VIDEO OUT jacks, do not select “Off.” If you select “Off” in this case, the picture may not appear.

◆ Progressive Output

If your TV accepts progressive (525p/625p) format signals, set “Progressive Output” to “On.” You will enjoy accurate colour reproduction and high quality images.

- 1 Select “Progressive Output,” and press ENTER.
- 2 Select “On,” and press ENTER. The display asks for confirmation.
- 3 Select “Start,” and press ENTER. The video switches to a progressive signal for 5 seconds.
- 4 If video signal appears OK, select “Yes,” and press ENTER. If picture is distorted, select “No,” and press ENTER.

◆ Progressive Mode

DVD software can be divided into two types: film based software and video based software. Video based software is derived from TV and displays images at 25 frames/50 fields (30 frames/60 fields) per second. Film based software is derived from film and displays images at 24 frames per second. Some DVD software contains both Video and Film.

In order for these images to appear natural on your screen when output in progressive mode (50 or 60 frames per second), the progressive video signal needs to be converted to match the type of DVD software that you are watching.

You can fine-tune the progressive 525p/625p video signal that is output when you set “Progressive Output” to “On.”

Note that you must connect to a progressive format TV using the COMPONENT VIDEO OUT jacks (page 17).

Auto	Automatically detects the software type (Film-based or Video-based) and selects the appropriate conversion mode. Normally select this position.
Video	Fixes the conversion mode to the mode for Video-based software.

Note

When picture noise appears after you set the recorder to progressive format, hold down **■**, and press PROGRAM – (minus) on the unit.

Scart Setting

Sets the method of inputting/outputting signals from the SCART jacks on the rear panel of the recorder. Select an option for each of the items below according to the combination of jacks and methods that you are going to use.

◆ Line1 Output

Selects a method of outputting video signals for the LINE 1 – TV jack.

RGB	Outputs RGB signals.
Video	Outputs video signals.
S Video	Outputs S-video signals.

Notes

- If your TV does not accept S-video or RGB signals, no picture appears on the TV screen even if you select "S Video" or "RGB." See the instructions supplied with your TV.
- You cannot select "RGB" when "Component Out" above is set to "On."
- SMARTLINK is available only when "Video" is selected.

◆ Line3 Input

Selects a method of inputting video signals for the LINE 3/DECODER jack. The picture will not be clear if this setting does not match the type of video input signal.

<u>Video/ RGB</u>	Inputs video signals or RGB signals.
Decoder	Select this when connecting to a PAY-TV/Canal Plus analogue decoder. If you connect to a cable box/satellite receiver such as CanalSat, do not select this option.
S Video	Inputs S-video signals.

Note

Input signals are recorded in video mode when "Video/RGB" is selected.

◆ Line3 Output

Selects a method of outputting video signals for the LINE 3/DECODER jack.

<u>Video</u>	Outputs video signals.
S Video	Outputs S-video signals.

Pause Mode (HDD/DVDs only)

Selects the picture quality in pause mode.

<u>Auto</u>	The picture, including subjects that move dynamically, is output with no jitter. Normally select this position.
Frame	The picture, including subjects that do not move dynamically, is output in high resolution.

Colour System

Selects the colour system when playing VIDEO CDs (including Super VIDEO CDs).

<u>PAL</u>	Plays a disc in PAL colour system.
NTSC	Plays a disc in NTSC colour system.

Auto Display

<u>On</u>	Automatically displays information on the screen when the recorder is turned on, etc.
Off	Displays information only when DISPLAY is pressed.

Screen Saver

The screen saver image appears when you do not use the recorder for more than 10 minutes while an on-screen display, such as the System Menu, is displayed on your TV screen. The screen saver image helps prevent your display device from becoming damaged (ghosting).

<u>On</u>	Turns on the screen saver function.
Off	Turns off the function.

Audio Settings (Audio)

The “Audio” setup allows you to adjust the sound according to the playback and connection conditions.

1 Press **SYSTEM MENU** while the recorder is in stop mode.

2 Select **“SETUP,”** and press **ENTER.**

3 Select **“Audio,”** and press **ENTER.**

The “Audio” setup appears with the following options. The default settings are underlined.

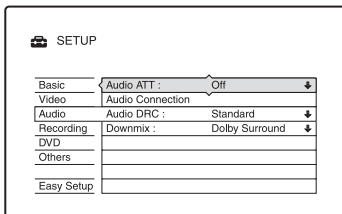

Audio ATT (attenuation)

If the playback sound is distorted, set this item to “On.” The recorder reduces the audio output level.

This function affects the output of the following jacks:

- LINE 2 OUT R-AUDIO-L jacks
- LINE 1 – TV jack
- LINE 3/DECODER jack

<u>On</u>	Select this when the playback sound from the speakers is distorted.
<u>Off</u>	Normally select this position.

Audio Connection

The following setup items switch the method of outputting audio signals when you connect a component such as an amplifier (receiver) with a digital input jack.

For connection details, see “Step 3: Connecting the Audio Cords” on page 19. Select “Dolby Digital,” “MPEG,” “DTS,” and “48kHz/96kHz PCM” after setting “Digital Out” to “On.”

If you connect a component that does not accept the selected audio signal, a loud noise (or no sound) will come out from the speakers, and may affect your ears or cause speaker damage.

1 Select “Audio Connection” in “Audio,” and press **ENTER.**

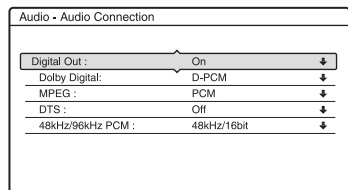

2 Select “Digital Out,” and press **ENTER.**

<u>On</u>	Normally select this position.
Off	The influence of the digital circuit upon the analogue circuit is minimal.

3 Select “On,” and press **ENTER.**

4 Set the digital output signal.

- Dolby Digital (HDD/DVDs only)
Selects the type of Dolby Digital signal.

<u>D-PCM</u>	Select this when the recorder is connected to an audio component lacking a built-in Dolby Digital decoder. The surround effects of output signals are determined by the “Downmix” setting item in the “Audio” setup.
Dolby Digital	Select this when the recorder is connected to an audio component with a built-in Dolby Digital decoder.

- MPEG (DVD VIDEOS only)

Selects the type of MPEG audio signal.

<u>PCM</u>	Select this when the recorder is connected to an audio component without a built-in MPEG decoder. If you play MPEG audio sound tracks, the recorder outputs stereo signals via the DIGITAL OUT (COAXIAL) jack.
MPEG	Select this when the recorder is connected to an audio component with a built-in MPEG decoder.

- DTS (DVD VIDEOS only)

Selects whether or not to output DTS signals.

On	Select this when the recorder is connected to an audio component with a built-in DTS decoder.
<u>Off</u>	Select this when the recorder is connected to an audio component without a built-in DTS decoder.

- 48kHz/96kHz PCM (DVD VIDEOS only)

Selects the sampling frequency of the audio signal.

<u>48kHz/ 16bit</u>	The audio signals of DVD VIDEOS are converted to 48 kHz/16 bit and output.
96kHz/ 24bit	All signals containing 96 kHz/24 bit are output without conversion. However, the signals are output at 48 kHz/16 bit if copyright-protected signals are contained.

 **Note**

“48kHz/96kHz PCM” setting has no effect when audio signals are output from the LINE 2 OUT (R-AUDIO-L) jacks or LINE 1 – TV/LINE 3/ DECODER jack. If the sampling frequency is 96kHz, signals are simply converted to analogue signals and output.

Audio DRC (Dynamic Range Control) (DVDs only)

Selects the dynamic range (difference between soft and loud sounds) setting when playing a DVD that conforms to Audio DRC. This affects the output from the following jacks:

- LINE 2 OUT R-AUDIO-L jacks
- LINE 1 – TV jack
- LINE 3/DECODER jack
- DIGITAL OUT (COAXIAL) jack only when “Dolby Digital” is set to “D-PCM” (page 100).

<u>Standard</u>	Normally select this position.
TV Mode	Makes low sounds clear even if you turn the volume down.
Wide Range	Gives you the feeling of being at a live performance.

Downmix (DVDs only)

Switches the method for mixing down to two channels when you play a DVD which has rear sound elements (channels) or is recorded in Dolby Digital format. For details on the rear signal components, see “4. Displaying the Playing Time and Play Information” on page 36. This function affects the output of the following jacks:

- LINE 2 OUT R-AUDIO-L jacks
- LINE 1 – TV jack
- LINE 3/DECODER jack
- DIGITAL OUT (COAXIAL) jack when “Dolby Digital” is set to “D-PCM” (page 100).

<u>Dolby Surround</u>	Normally select this position. Multi-channel audio signals are output to two channels for enjoying surround sounds.
Normal	Multi-channel audio signals are downmixed to two channels for use with your stereo.

Recording Settings (Recording)

The “Recording” setup allows you to adjust recording settings.

- 1 Press **SYSTEM MENU** while the recorder is in stop mode.
- 2 Select “**SETUP**,” and press **ENTER**.
- 3 Select “**Recording**,” and press **ENTER**.

The “Recording” setup appears with the following options. The default settings are underlined.

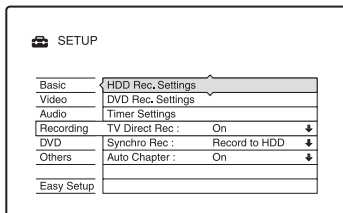

HDD Rec. Settings

◆ Bilingual Recording

Selects the sound to be recorded on the HDD.

<u>Main</u>	Records the main sound for the bilingual programme.
Sub	Records the sub sound for the bilingual programme.
Main+Sub	Records the main and sub sounds for the bilingual programme.

⚡ Note

If you set the recording mode to be changed while dubbing from a DVD to the HDD, the sound recorded in the source (DVD) is applied regardless of this setting.

◆ HQ Setting

Selects the HQ mode used for recording on the HDD (page 52).

<u>HQ+</u>	Records in higher quality (approximate 15 Mbps).
<u>HQ</u>	Records in the standard HQ mode.

DVD Rec. Settings

◆ Bilingual Recording (for all recordable discs except DVD-RWs/DVD-Rs in VR mode)

Selects the sound to be recorded on the recordable disc. This setting is not necessary when recording on DVD-RWs/DVD-Rs (VR mode) that record both the main and sub sounds.

<u>Main</u>	Records the main sound for the bilingual programme.
Sub	Records the sub sound for the bilingual programme.

Timer Settings

◆ Rec Mode Adjust

<u>On</u>	Automatically adjusts the recording mode to enable the entire programme to be recorded (page 55).
<u>Off</u>	Turns off the function.

◆ Auto Title Erase (HDD only)

<u>On</u>	Automatically erases old titles recorded on the HDD (page 55).
<u>Off</u>	Turns off the function.

TV Direct Rec (HDD/DVD+RW/DVD-RW/DVD+R/DVD-R only)

<u>On</u>	Allows you to easily record what you are watching on the TV using SMARTLINK.
Off	Turns off the TV Direct Rec function.

Synchro Rec

Selects the recording destination used for Synchro-Recording (page 61).

<u>Record to HDD</u>	Records to the HDD.
Record to DVD	Records to DVDs.

Auto Chapter

Selects whether to automatically divide a recording (a title) into chapters during recording or dubbing.

<u>On</u>	Inserts chapter marks at approximately 6 minute intervals.
Off	No chapter mark is inserted.

Notes

- The actual chapter mark interval may vary depending on the amount of information contained in the video to be recorded.
- Chapter marks are automatically inserted where the recordings start on the tape when "Auto Chapter" is set to "On" during DV dubbing to the HDD or a DVD-RW/DVD-R (VR mode).

Disc Settings (DVD)

The "DVD" setup allows you to adjust parental control, language and other DVD related settings.

- 1 Press **SYSTEM MENU** while the recorder is in stop mode.
- 2 Select "**SETUP,**" and press **ENTER.**
- 3 Select "**DVD,**" and press **ENTER.**

The "DVD" setup appears with the following options. The default settings are underlined.

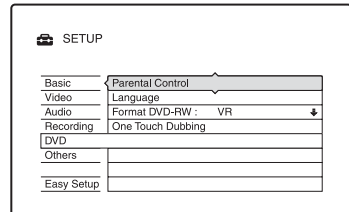

Parental Control (DVD VIDEO only)

Playback of some DVD VIDEOS can be limited according to a predetermined level, such as the age of the users. Scenes may be blocked or replaced with different scenes.

- 1 Select "Parental Control" in "DVD," and press **ENTER.**
 - If you have not entered a password, the display for registering a new password appears.

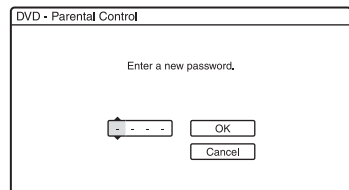

- When you have already registered a password, the display for entering the password appears.

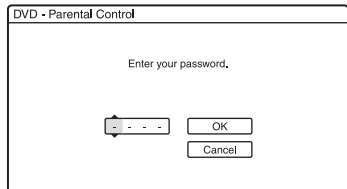

- 2 Enter your four-digit password using the number buttons, then select “OK” and press ENTER.

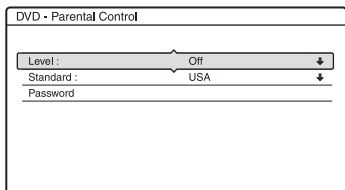

- 3 Select “Standard,” and press ENTER. The selection items for “Standard” are displayed.

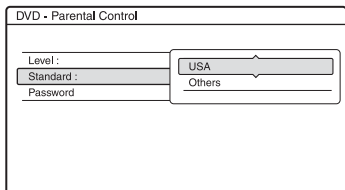

- 4 Select a geographic area as the playback limitation level, and press ENTER. The area is selected.
 - When you select “Others,” press the number buttons to select and enter an area code in the table (page 121). Then select “OK” and press ENTER.

- 5 Select “Level,” and press ENTER. The selection items for “Level” are displayed.

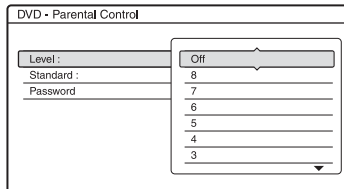

The lower the value, the stricter the limitation.

Discs rated higher than the selected level will be restricted.

- 6 Select the level, and press ENTER. The Parental Control setting is complete.

To cancel the Parental Control setting for the disc, set “Level” to “Off” in step 6.

To change the password, select “Password” in step 3, and press ENTER.

When the display for registering a password appears, enter a new four-digit password using the number buttons, then select “OK” and press ENTER.

⚡ Notes

- If you forget your password, you will have to reset it by selecting “Parental Control” of “Factory Setup” in the “Others” setup (page 106).
- When you play discs which do not have the Parental Control function, playback cannot be limited on this recorder.
- Depending on the disc, you may be asked to change the Parental Control level while playing the disc. In this case, enter your password, then change the level.

Language (DVD VIDEO only)

◆ DVD Menu

Switches the language for the DVD menu.

◆ Audio

Switches the language of the sound track. When you select “Original,” the language given priority in the disc is selected.

◆ Subtitle

Switches the language of the subtitles recorded on the disc.

When you select “Audio Follow,” the subtitle language changes according to the language you selected for the sound track.

Hint

If you select “Others” in “DVD Menu,” “Subtitle,” or “Audio,” select and enter a language code from “Language Code List” on page 121 using the number buttons.

Note

If you select a language in “DVD Menu,” “Subtitle,” or “Audio” that is not recorded on the DVD VIDEO, one of the recorded languages will be automatically selected.

Format DVD-RW (DVD-RW only)

The recorder automatically starts formatting in VR mode or Video mode, whichever is selected below, when a new, unformatted DVD-RW is inserted.

<u>VR</u>	Automatically formats the disc in VR mode.
Video	Automatically formats the disc in Video mode.

One Touch Dubbing

Displays the following options for the One Touch Dub function.

◆ **Finalise Disc (for all recordable discs except DVD-RW in VR mode)**

Selects whether or not to finalise the disc automatically following One Touch Dubbing (page 90).

Auto	Automatically finalises the disc following One Touch Dubbing.
<u>Manual</u>	Allows you to finalise the disc manually.

Remote Control Settings/ Factory Settings (Others)

The “Others” setup allows you to set up other operational settings.

- 1 Press SYSTEM MENU while the recorder is in stop mode.**
- 2 Select “SETUP,” and press ENTER.**
- 3 Select “Others,” and press ENTER.**
The “Others” setup appears with the following options. The default settings are underlined.

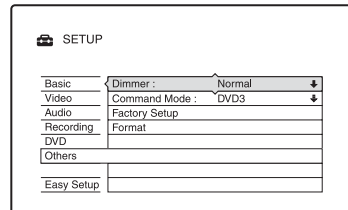

Dimmer

Adjusts the lighting of the front panel display.

<u>Normal</u>	Bright lighting.
Save Power	Low lighting. Turns off the lighting when the power is off.

Command Mode

Changes the Command Mode of the recorder if other DVD equipment is assigned the same Command Mode. For details, see “If you have a Sony DVD player or more than one Sony DVD recorder” on page 22.

Factory Setup

Allows you to select the setup settings by group, and return them to their default settings. Note that all of your previous settings will be lost.

- 1 Select “Factory Setup” in “Others,” and press **→** or ENTER.
The display for selecting a group of settings appears.
- 2 Select the group of settings you want to return to default from “Basic,” “Video,” “Audio,” “Recording,” “DVD,” “Others,” “Parental Control,” and “All,” and press **→** or ENTER.
- 3 Select “Start,” and press ENTER.
The selected settings return to their default settings.
- 4 Press ENTER when “Finish” appears.

Format

You can erase all titles recorded on the HDD.

Easy Setup (Resetting the Recorder)

Select this to run the “Easy Setup” programme.

- 1 Press **SYSTEM MENU** while the recorder is in stop mode.
- 2 Select “SETUP,” and press ENTER.
- 3 Select “Easy Setup,” and press ENTER.

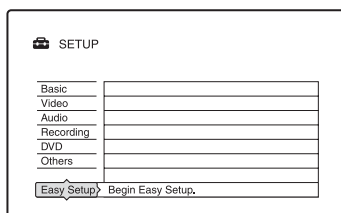

- 4 Select “Start.”
- 5 Follow the instructions for “Easy Setup” (page 24) from step 2.

Troubleshooting

If you experience any of the following difficulties while using the recorder, use this troubleshooting guide to help remedy the problem before requesting repairs. Should any problem persist, consult your nearest Sony dealer.

Power

The power does not turn on.

- ➔ Check that the mains lead is connected securely.

Picture

There is no picture.

- ➔ Re-connect all connecting cords securely.
- ➔ The connecting cords are damaged.
- ➔ Check the connection to your TV (page 13).
- ➔ Switch the input selector on your TV (such as to "VCR") so that the signal from the recorder appears on the TV screen.
- ➔ Check that "Scart Setting" in the "Video" setup is set to the appropriate item that conforms to your system (page 98).
- ➔ If you connect the recorder to your TV via only the COMPONENT VIDEO OUT jacks, set "Component Out" in the "Video" setup to "On" (page 98).
- ➔ This recorder cannot record NTSC signals.
- ➔ When playing a double-layer DVD, the video and audio may be momentarily interrupted at the point where the layers switch.

Picture noise appears.

- ➔ If the picture output signal from your recorder passes through your VCR to get to your TV, or if you are connected to a combination TV/VIDEO player, the copy-protection signal applied to some DVD programmes could affect picture quality. If you still experience this problem even when you connect your recorder directly to your TV, try connecting your recorder to your TV's S VIDEO input.
- ➔ You have set the recorder to progressive format even though your TV cannot accept the progressive signal. In this case, hold down **■**, and press PROGRAM – (minus) on the unit.
- ➔ Even if your TV is compatible with progressive format (525p/625p) signals, the image may be affected when you set the recorder to progressive format. In this case, hold down **■**, and press PROGRAM – (minus) on the unit and the recorder is set to normal (interlace) format.
- ➔ You are playing a DVD recorded in a colour system that is different from your TV.
- ➔ Noise may appear in the pictures recorded on the HDD, which is due to the characteristics of HDD, and is not a malfunction.
- ➔ When playing a double-layer DVD, the video and audio may be momentarily interrupted at the point where the layers switch.

TV programme reception does not fill the screen.

- ➔ Set the channel manually in "Channel Setting" in the "Basic" setup (page 93).
- ➔ Select the correct source using the INPUT SELECT button, or select a channel of any TV programme using the PROG +/- buttons.

TV programme pictures are distorted.

- ➔ Reorient the TV aerial.
- ➔ Adjust the picture (see the TV's instruction manual).
- ➔ Place the recorder and TV farther apart.
- ➔ Place the TV and any bunched aerial cables farther apart.
- ➔ The aerial cable is connected to the AERIAL OUT jack on the recorder. Connect the cable to the AERIAL IN jack.

TV channels cannot be changed.

- ➔ The channel is disabled (page 94).
- ➔ A timer recording started, which changed the channels.

The picture from equipment connected to the recorder's input jack does not appear on the screen.

- ➔ If the equipment is connected to the LINE 1 – TV jack, select “L1” in the front panel display by pressing PROG +/- or INPUT SELECT.
If the equipment is connected to the LINE 2 IN jacks, select “L2” in the front panel display by pressing PROG +/- or INPUT SELECT.
If the equipment is connected to the LINE 3/DECODER jack, select “L3” in the front panel display by pressing PROG +/- or INPUT SELECT.
If the equipment is connected to the DV IN jack, (this is usually for a digital video camera connection), select “DV” in the front panel display by pressing INPUT SELECT.

The playback picture or TV programme from the equipment connected through the recorder is distorted.

- ➔ If the playback picture output from a DVD player, VCR, or tuner goes through your recorder before reaching your TV, the copy-protection signal applied to some programmes could affect picture quality. Disconnect the playback equipment in question and connect it directly to your TV.

The picture does not fill the screen.

- ➔ Set “TV Type” of the “Video Output” in the “Video” setup in accordance with the screen size of your TV (page 97).

The picture does not fill the screen, even though the picture size is set in “TV Type” of the “Video Output” in the “Video” setup.

- ➔ The picture size of the title is fixed.

The picture is black and white.

- ➔ Check that “Line1 Output” of the “Scan Setting” in the “Video” setup is set to the appropriate item that conforms to your system (page 98).
- ➔ If you are using a SCART cord, be sure to use one that is fully wired (21 pins).

GUIDE Plus+ system

GUIDE Plus+ system does not appear.

- ➔ ①Even if you complete “Easy Setup,” TV programme listings do not appear until the recorder receives the GUIDE Plus+ data.
②Turn off the recorder, but do not unplug it. ③Wait for 24 hours. It may take several days for the recorder to receive the GUIDE Plus+ data for all programme positions. If the recorder does not receive the GUIDE Plus+ data after 24 hours, set the host channel manually (page 50).
- ➔ The postal code is incorrect. Correctly set your postal code (page 49).
- ➔ When the recorder is connected to a set top box receiver, the set top box receiver must be turned on to download the GUIDE Plus+ data.
- ➔ Area numbers that cannot be received using GUIDE Plus+ are set. Select “Easy Setup” from “SETUP” in the System Menu, and follow the on-screen instructions to make the settings again (page 24).
- ➔ The “Time Lock” function on your cable box is activated. Set this function to off.

The programme position number in the programme listing does not match the broadcast station.

- ➔ There may be more than one channel lineup for your area. To change the channel lineup, select “Editor” in the Menu Bar of the GUIDE Plus+ system (page 51).

Programme listings for some programme positions are missing.

- ➔ The programme guide data may not be updated. Turn off the recorder and let the recorder receive the programme guide data.
- ➔ Some broadcast stations support only two days of data. For details, see the following website:
www.europe.guideplus.com
- ➔ All of the GUIDE Plus+ data could not be received because the reception is poor.

The programme listing is not up to date.

- ➔ The recorder was in use during the time that the GUIDE Plus+ data was scheduled to be downloaded.
- ➔ All of the GUIDE Plus+ data could not be received because the reception is poor.

Sound

There is no sound.

- ➔ Re-connect all connections securely.
- ➔ The connecting cord is damaged.
- ➔ The input source setting on the amplifier or the connection to the amplifier is incorrect.
- ➔ The recorder is in reverse play, fast-forward, slow motion, or pause mode.
- ➔ If the audio signal does not come through the DIGITAL OUT (COAXIAL) jack, check the "Audio Connection" settings in the "Audio" setup (page 100).

Sound distortion occurs.

- ➔ Set "Audio ATT" in the "Audio" setup to "On" (page 100).

Sound is noisy.

- ➔ When playing a CD with DTS sound tracks, noise will come from the LINE 2 OUT R-AUDIO-L jacks, LINE 1 – TV jack, or LINE 3/DECODER jack (page 67).

The sound volume is low.

- ➔ The sound volume is low on some DVDs. The sound volume may improve if you set "Audio DRC" in the "Audio" setup to "TV Mode" (page 101).
- ➔ Set "Audio ATT" in the "Audio" setup to "Off" (page 100).

An alternate audio track cannot be recorded or played.

- ➔ When recording from connected equipment, set "Line Audio Input" in OPTIONS menu to "Bilingual" (page 63).
- ➔ Multilingual tracks (main and sub) cannot be recorded on DVD+RWs, DVD-RWs (Video mode), DVD-Rs, or DVD-Rs (Video mode). To record the language, set "Bilingual Recording" of the "DVD Rec. Settings" in the "Recording" setup to "Main" or "Sub" before recording (page 102). To record both the main and sub sounds, record on DVD-RWs/DVD-Rs (VR mode).
- ➔ Any discs other than the HDD or DVD-RWs/DVD-Rs (VR mode) cannot be used for recording both main and sub sounds. To record on the HDD, set "Bilingual Recording" of the "HDD Rec. Settings" in the "Recording" setup to "Main+Sub" (page 102).
- ➔ If you have connected an AV amplifier to the DIGITAL OUT (COAXIAL) jack and want to change the audio track for HDD/DVD-RWs/DVD-Rs (VR mode) during playback, set "Dolby Digital" of the "Audio Connection" in the "Audio" setup to "D-PCM" (page 100).

Playback

The recorder does not play any type of disc (except HDD).

- ➔ The disc is upside down. Insert the disc with the labelled side facing up.
- ➔ The disc is not correctly inserted.
- ➔ Moisture has condensed inside the recorder. In this case, if the recorder is on, leave it on (if it is off, leave it off) for about an hour until the moisture evaporates.
- ➔ If the disc was recorded on another recorder and was not finalised (page 40), the recorder cannot play the disc.

The recorder does not start playback from the beginning.

- ➔ Resume play was activated (page 65).
- ➔ You have inserted a DVD whose Title menu or DVD menu automatically appears on the TV screen when it is first inserted. Use the menu to start playback.

The recorder starts playing automatically.

- ➔ The DVD VIDEO features an auto playback function.

Playback stops automatically.

- ➔ If the DVD has an auto pause signal, the recorder stops playback at the auto pause signal.

Some functions such as Stop, Search, or Slow-motion Play cannot be performed.

- ➔ Depending on the DVD, you may not be able to do some of the operations above. See the instruction manual supplied with the disc.

The language for the sound track cannot be changed.

- ➔ Multilingual tracks are not recorded on the DVD being played.
- ➔ The DVD VIDEO prohibits the changing of the language for the sound track.
- ➔ Try changing the language using the DVD VIDEO's menu.

The subtitle language cannot be changed or turned off.

- ➔ Multilingual subtitles are not recorded on the DVD VIDEO.
- ➔ The DVD VIDEO prohibits changing of the subtitles.
- ➔ Try changing the subtitle using the DVD VIDEO's menu.
- ➔ The subtitles cannot be changed for the titles recorded on this recorder.

The angles cannot be changed.

- ➔ Multi-angles are not recorded on the DVD VIDEO being played.
- ➔ You are trying to change the angles when "001" does not appear on the TV screen (page 64).
- ➔ The DVD VIDEO prohibits changing angles.
- ➔ Try changing the angle using the DVD VIDEO's menu.
- ➔ The angles cannot be changed for the titles recorded on this recorder.
- ➔ The angles cannot be changed during slow motion playback or when playback is paused.

The MP3 audio tracks do not play.

- ➔ The MP3 audio tracks are not recorded in a format that the recorder can play (page 71).

The JPEG image files do not play.

- ➔ The JPEG image files are not recorded in a format that the recorder can play (page 71).
- ➔ Progressive JPEG images cannot be played.

TV Pause does not work.

- ➔ You are recording to the HDD or the HDD is full.

**Recording/Timer recording/
Editing**

The programme position cannot be changed from the programme position you are recording.

- ➔ Set the TV's input source to "TV."

Recording does not start immediately after you press ● REC.

- ➔ Operate the recorder only after "LOAD," "FORMAT," or "INFOWRITE" disappears from the front panel display.

Nothing was recorded even though you set the timer setting correctly.

- ➔ There was a power failure during recording.
- ➔ The recorder's internal clock stopped due to a power failure that lasted for more than 1 hour. Reset the clock (page 96).
- ➔ The channel was disabled after the timer recording was set. See "Channel Setting" on page 93.
- ➔ The programme position was hidden after the timer recording was set. (See "Making changes to the GUIDE Plus+ System" on page 49.)
- ➔ Disconnect the mains lead from the mains, and connect it again.
- ➔ "PDC/VPS Scan Off" was selected in the OPTIONS menu (page 60).
- ➔ The programme contains copy protection signals that restrict copying.
- ➔ Other timer setting overlapped the timer setting (page 61).
- ➔ There is no DVD inside the recorder.

- ➔ There is not enough disc space for the recording.
- ➔ The set top box was turned off.
- ➔ The set top box controller was incorrectly connected (page 13).
- ➔ The settings in "Setup" in the Menu bar have been changed (page 49).
- ➔ The recorder was in the process of dubbing (HDD↔DVD).
- ➔ The recorder was in the process of DV Dubbing.

Recording does not stop immediately after you press ■ REC STOP.

- ➔ It will take a few seconds for the recorder to input disc data before recording can stop.

Recording does not stop after you press ■.

- ➔ Press ■ REC STOP.

Timer recording is not complete or did not start from the beginning.

- ➔ There was a power failure during recording. If the power recovers when there is a timer recording, the recorder resumes recording. Should the power failure continue for more than 1 hour, reset the clock (page 96).
- ➔ Other timer setting overlapped the timer setting (page 61).
- ➔ Disc space was not enough.
- ➔ The PDC/VPS function is working.

Contents previously recorded were erased.

- ➔ Data that is not playable on this recorder but was recorded on a DVD with a PC will be erased from the disc when the disc is inserted.
- ➔ "Auto Title Erase" of the "Timer Settings" in the "Recording" setup is set to "On" (page 102).

The PDC/VPS function does not operate.

- ➔ Check that the clock and date are set correctly.
- ➔ Check that the PDC/VPS time you set is the correct one (there might be a mistake in the TV programme guide). If the broadcast you wanted to record did not send the good PDC/VPS information, the recorder will not start recording.
- ➔ If the reception is poor, the PDC/VPS signal might be altered and the recorder might not start recording.
- ➔ "PDC/VPS Scan Off" is selected (page 60).
- ➔ The PDC/VPS function may not work if the GUIDE Plus+ host channel setup is not complete.
- ➔ The PDC/VPS function does not work when the GUIDE Plus+ data is being downloaded.

Recording from the equipment with a timer

Nothing was recorded even though you set the Synchro-Rec setting correctly.

- ➔ You forgot to turn off the connected equipment. Turn off the connected equipment and set the recorder to Synchro-Rec standby mode (page 61).
- ➔ The recorder was not set to the Synchro-Recording standby mode. Press ➔ ● SYNCHRO REC to have the recorder stand by for recording. Make sure the SYNCHRO REC indicator lights up on the front panel (page 61).
- ➔ The equipment is not connected to the LINE 3/DECODER jack of the recorder.
- ➔ The recorder is connected to the TV output jack of the connected equipment.

Synchro-Recording does not complete.

- ➔ The timer setting for the connected equipment overlapped the recorder's timer setting (page 62).
- ➔ There was a power failure during the recording.

The recorder automatically starts recording when the satellite receiver is turned on.

- ➔ The Synchro-Rec function was activated. Turn off the satellite receiver and cancel the Synchro-Rec function (page 61).

Dubbing

You dubbed a title, but the title did not appear in the HDD Title List.

- ➔ The title contained a copy protection signal, so it was moved (page 84).

High-speed dubbing is not possible.

- ➔ The title cannot be dubbed at high-speed (page 83). Even if A-B erasure is performed so that a title does not contain mixed picture sizes, it is still treated as a title with mixed picture sizes.

Display

The clock has stopped.

- ➔ Set the clock again (page 96).
- ➔ The clock stopped due to a power failure that lasted for more than 1 hour. Reset the clock (page 96).

The TIMER REC indicator is flashing.

- ➔ The disc does not have enough space.
- ➔ Insert a recordable disc inside the recorder.
- ➔ The inserted DVD is protected (page 40).

The recording mode indication is incorrect.

- ➔ When the recording or dubbing is less than ten minutes, or if a picture with little movement is displayed for more than ten minutes, the recording mode indication may be displayed incorrectly. Note that the actual recording or dubbing itself was correctly made in the selected recording mode.
- ➔ After playing titles recorded in EP and SLP mode, the recording mode indication may change depending on the recorded programme.

The clock does not appear in the front panel display when the recorder is turned off.

- ➔ “Dimmer” in the “Others” setup is set to “Save Power” (page 105).

Remote control

The remote does not function.

- ➔ Batteries are weak.
- ➔ The remote is too far from the recorder.
- ➔ The remote’s manufacturer code returned to the default setting when you replaced the batteries. Reset the code (page 21).
- ➔ The remote is not pointed at the remote sensor on the recorder.
- ➔ Different command modes are set for the recorder and remote. Set the same command mode (page 22). The default command mode setting for this recorder and the supplied remote is DVD3.
- ➔ Press ■ (stop) on the unit while the recorder is turned off to check the current command mode.

Others

The recorder does not operate properly.

- ➔ Restart the recorder. Press down  on the recorder for more than ten seconds until “WELCOME” appears in the front panel display.
- ➔ When static electricity, etc., causes the recorder to operate abnormally, turn off the recorder and wait until the clock appears in the front panel display. Then, unplug the recorder and after leaving it off for a while, plug it in again.

Five numbers or letters are displayed in the front panel display.

- ➔ The self-diagnosis function was activated (see the table on page 114).

The disc tray does not open after you press  (open/close).

- ➔ It may take a few seconds for the disc tray to open after you have recorded or edited a DVD. This is because the recorder is adding disc data to the disc.



The disc tray does not open and “LOCKED” appears in the front panel display.

- ➔ The disc tray is locked. Cancel the Child Lock (page 65).

The disc tray does not open and “TRAY LOCKED” appears in the front panel display.

- ➔ Contact your Sony dealer or local authorized Sony service facility.

The disc tray does not open and you cannot remove the disc after you press  (open/close).

- ➔ Turn off the recorder. Once the clock appears in the front panel display, disconnect the mains lead. (If the recorder does not turn off or if the clock does not appear in the front panel display, disconnect the mains lead anyway.) Connect the mains lead again while pressing down  on the recorder, and release the button when the disc tray opens. Then, keep  on the recorder pressed for about ten seconds until “WELCOME” appears in the front panel display.

“RECOVERY” appears in the front panel display.

- ➔ The recorder’s recovery function was activated when the recorder was turned on because the power was turned off or failed during recording. Leave the recorder on until “RECOVERY” disappears from the front panel display.

“HDD ERROR” appears in the front panel display.

- ➔ The hard disk error occurred. Press down  on the recorder for ten seconds until “WELCOME” appears in the front panel display. If this does not resolve the problem, format the recorder’s HDD by pressing down the HDD button on the recorder for more than ten seconds until “FORMAT” appears in the front panel display. Note that all the contents recorded on the HDD will be erased. If this does not fix the problem, contact your nearest Sony dealer.

“FAN ERROR” appears in the front panel display.

- ➔ Check that the vent on the rear of the recorder is not blocked. Then, immediately disconnect the mains lead. Leave the recorder off for a while, then re-connect the mains lead, and press  on the recorder.

Mechanical sound is heard when the recorder is off.

- ➔ While the recorder is adjusting the clock for the Auto Clock Set function or scanning the programme positions for the PDC/VPS function, operational noises (such as the internal fan) may be heard, even when the power is off. This is not a malfunction.

Self-diagnosis Function (When letters/numbers appear in the display)

When the self-diagnosis function is activated to prevent the recorder from malfunctioning, a five-character service number (e.g., C 13 00) with a combination of a letter and four numbers appears in the front panel display. In this case, check the following table.

First three characters of the service number	Cause and/or corrective action
C 13	<p>There is a problem in the HDD.</p> <p>➔ Contact your nearest Sony dealer or local authorized service facility.</p> <p>The DVD is dirty.</p> <p>➔ Clean the disc with a soft cloth.</p>
C 31	<p>The DVD/CD is not inserted correctly.</p> <p>➔ Re-insert the disc correctly.</p>
E XX (xx is a number)	<p>To prevent a malfunction, the recorder has performed the self-diagnosis function.</p> <p>➔ Contact your nearest Sony dealer or local authorized Sony service facility and give the five-character service number. Example: E 61 10</p>

Notes About This Recorder

On operation

- If the recorder is brought directly from a cold to a warm location, or is placed in a very damp room, moisture may condense on the lenses inside the recorder. Should this occur, the recorder may not operate properly. In this case, if the recorder is on, leave it on (if it is off, leave it off) for about an hour until the moisture evaporates.
- When you move the recorder, take out any discs. If you don't, the disc may be damaged.

On adjusting volume

Do not turn up the volume while listening to a section with very low level inputs or no audio signals. If you do, the speakers may be damaged when a peak level section is played.

On cleaning

Clean the cabinet, panel, and controls with a soft cloth slightly moistened with a mild detergent solution. Do not use any type of abrasive pad, scouring powder or solvent such as alcohol or benzine.

About repairing the hard disk drive

- It may be necessary to access data stored on the hard disk for testing purposes; there is no intention to copy or store the data, titles or any other information.
- If replacement or initialization (format) is required, the hard disk will be formatted at our discretion. In this case, please note that all of the contents recorded there will be erased (including any data found to violate copyright law).

On cleaning discs, disc/lens cleaners

Do not use a commercially available cleaning disc or disc/lens cleaner (wet or spray type). These may cause the recorder to malfunction.

Notes about the discs

- To keep the disc clean, handle the disc by its edge. Do not touch the surface. Dust, fingerprints, or scratches on the disc may cause it to malfunction.



- Do not expose the disc to direct sunlight or heat sources such as hot air ducts, or leave it in a car parked in direct sunlight as the temperature may rise considerably inside the car.
- After playing, store the disc in its case.
- Clean the disc with a cleaning cloth. Wipe the disc from the centre out.



- Do not use solvents such as benzene, thinner, commercially available cleaners, or anti-static spray intended for vinyl LPs.
- Do not use the following discs.
 - A disc that has a non-standard shape (e.g., card, heart).
 - A disc with a label or sticker on it.
 - A disc that has cellophane tape or sticker adhesive on it.

Specifications

System

Laser: Semiconductor laser

Channel coverage:

PAL (B/G, D/K, I)

VHF: E2 to E12, R1 to R12, Italian A to H, Ireland A to J, South Africa 4 to 13

UHF: E21 to E69, R21 to R69, B21 to B69

CATV: S01 to S05, S1 to S20

HYPER: S21 to S41

The above channel coverage merely ensures the channel reception within these ranges. It does not guarantee the ability to receive signals in all circumstances. For details, see “Receivable channels” (page 94).

Video reception: Frequency synthesizer system

Audio reception: Split carrier system

Aerial out: 75-ohm asymmetrical aerial socket

Timer: Clock: Quartz locked/Timer indication: 24-hour cycle (digital)/Power back-up duration: 1 hour

Video recording format: MPEG-2, MPEG-1

Audio recording format/applicable bit rate: Dolby Digital 2 ch
256 kbps/128 kbps (in EP and SLP mode)

Inputs and outputs

LINE 2 OUT

(AUDIO): Phono jack/2 Vrms/10 kilohms

(VIDEO): Phono jack/1.0 Vp-p

(S VIDEO): 4-pin mini DIN/Y: 1.0 Vp-p,
C: 0.3 Vp-p (PAL)

LINE 2 IN

(AUDIO): Phono jack/2 Vrms/more than 22 kilohms

(VIDEO): Phono jack/1.0 Vp-p

(S VIDEO): 4-pin mini DIN/Y: 1.0 Vp-p,
C: 0.3 Vp-p (PAL)

LINE 1 – TV: 21-pin

CVBS IN/OUT

S-Video/RGB OUT (upstream)

LINE 3/DECODER: 21-pin

CVBS IN/OUT

S-Video/RGB IN

(RGB signals cannot be recorded)

S-Video OUT (downstream)

Decoder

DV IN: 4-pin/i.LINK S100**DIGITAL OUT (COAXIAL):** Phono jack/

0.5 Vp-p/75 ohms

COMPONENT VIDEO OUT**(Y, P_B/C_B, P_R/C_R):**Phono jack/Y: 1.0 Vp-p, P_B/C_B: 0.7 Vp-p,P_R/C_R: 0.7 Vp-p**G-LINK:** mini jack**General****Power requirements:** 220-240 V AC, 50/60 Hz**Power consumption:**

RDR-HX525: 42 W

RDR-HX725: 44 W

Dimensions (approx.):430 × 65 × 328 mm (width/height/
depth) incl. projecting parts**Hard disk drive capacity:**

RDR-HX525: 80 GB

RDR-HX725: 160 GB

Mass (approx.): 4.2 kg**Operating temperature:** 5°C to 35°C**Operating humidity:** 25% to 80%**Supplied accessories:**

Mains lead (1)

Aerial cable (1)

Remote commander (remote) (1)

Set top box controller (1)

R6 (size AA) batteries (2)

Specifications and design are subject to change without notice.

Compatible colour systems

This recorder is designed to record using the PAL colour system and play back using the PAL or NTSC colour systems.

About i.LINK

The DV IN jack on this recorder is i.LINK-compliant for digital video cameras. This section describes the i.LINK standard and its features.

What is i.LINK?

i.LINK is a digital serial interface for handling digital video, digital audio and other data in two directions between equipment having the i.LINK jack, and for controlling other equipment.

i.LINK-compatible equipment can be connected by a single i.LINK cable. Possible applications are operations and data transactions with various digital AV equipment. When two or more i.LINK-compatible equipment are connected to this recorder in a daisy chain, operations and data transactions are possible with not only the equipment that this recorder is connected to but also with other devices via the directly connected equipment.

Note, however, that the method of operation sometimes varies according to the characteristics and specifications of the equipment to be connected, and that operations and data transactions are sometimes not possible on some connected equipment.

Note

Normally, only one piece of equipment can be connected to this recorder by the i.LINK cable (DV connecting cable). When connecting this recorder to i.LINK-compatible equipment having two or more i.LINK jacks (DV jacks), see the instruction manual of the equipment to be connected.

About the name "i.LINK"

i.LINK is a more familiar term for IEEE 1394 data transport bus proposed by SONY, and is a trademark approved by many corporations. IEEE 1394 is an international standard standardized by the Institute of Electrical and Electronics Engineers.

i.LINK baud rate

i.LINK's maximum baud rate varies according to the equipment. Three maximum baud rates are defined:

- S100 (approx. 100 Mbps*)
- S200 (approx. 200 Mbps)
- S400 (approx. 400 Mbps)

The baud rate is listed under "Specifications" in the instruction manual of each equipment. It is also indicated near the i.LINK jack on some equipment.

The maximum baud rate of equipment on which it is not indicated such as this unit is "S100."

When units are connected to equipment having a different maximum baud rate, the baud rate sometimes differs from the indicated baud rate.

* What is Mbps?

Mbps stands for megabits per second, or the amount of data that can be sent or received in one second. For example, a baud rate of 100 Mbps means that 100 megabits of data can be sent in one second.

i.LINK functions on this recorder

For details on how to dub when this recorder is connected to other video equipment having DV jacks, see page 88.

The DV jack on this recorder can only input DVC-SD signals. It cannot output signals. The DV jack will not accept MICRO MV signals from equipment such as a MICRO MV digital video camera with an i.LINK jack.

For further precautions, see the notes on page 88.

For details on precautions when connecting this recorder, also see the instruction manuals for the equipment to be connected.

Required i.LINK cable

Use the Sony i.LINK 4-pin-to-4-pin cable (during DV dubbing).

i.LINK and  are trademarks.

Guide to Parts and Controls

For more information, see the pages in parentheses.

Remote

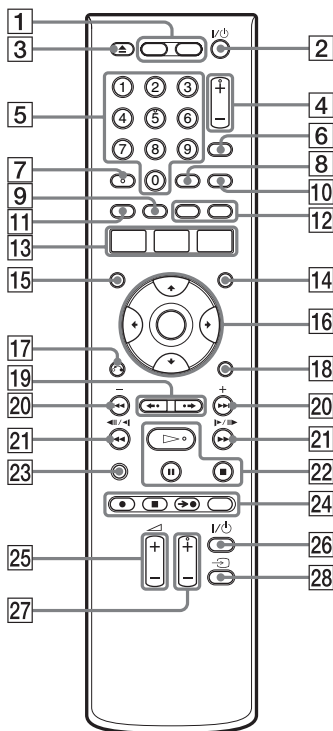

- | | |
|--|---|
| <p>1 HDD button (32)
DVD button (32)</p> <p>2 I/⏻ (on/standby) button (24)</p> <p>3 ▲ (open/close) button (32)</p> <p>4 PROG (programme) +/- buttons (32)
The + button has a tactile dot*.</p> <p>5 Number buttons (55, 70)
The number 5 button has a tactile dot*.</p> <p>6 INPUT SELECT button (63, 88)</p> <p>7 AUDIO button (66)
The AUDIO button has a tactile dot*.</p> <p>8 SUBTITLE button (66)</p> <p>9 MENU/Green button (64)</p> | <p>10 TV/DVD button (21)</p> <p>11 TOP MENU/Red button (64)</p> <p>12 CHAPTER MARK/Yellow button (78)
CHAPTER MARK ERASE/Blue button (78)</p> <p>13 SYSTEM MENU button (91, 93)
TITLE LIST button (34, 64, 75)
TV GUIDE button (44)</p> <p>14 INFO (information) button (44)</p> <p>15 SCHEDULE button (55)</p> <p>16 ←/↑/↓/→/ENTER button (24)</p> <p>17 ↶ RETURN button (59)</p> <p>18 OPTIONS button (42)</p> <p>19 PAGE ◀/•/▶ buttons (34, 71)</p> <p>20 ◀◀/▶▶ (previous/next)/DAY +/- buttons (66)</p> <p>21 ◀◀◀◀ ◀/▶/▶▶▶▶ (search/slow/freeze frame) buttons (66)</p> <p>22 ▷ (play) button (64)
 (pause) button (66)
■ (stop) button (64)
The ▷ button has a tactile dot*.</p> <p>23 DISPLAY button (36)</p> <p>24 ● REC button (32)
■ REC STOP button (32)
→ ● SYNCHRO REC button (61)
REC MODE button (32)</p> <p>25 TV ◀ (volume) +/- buttons (21)</p> <p>26 TV I/⏻ (on/standby) button (21)</p> <p>27 TV PROG (programme) +/- buttons (21)
The + button has a tactile dot*.</p> <p>28 TV ↶ button (21)</p> |
|--|---|

* Use the tactile dot as a reference when operating the recorder.

Front panel

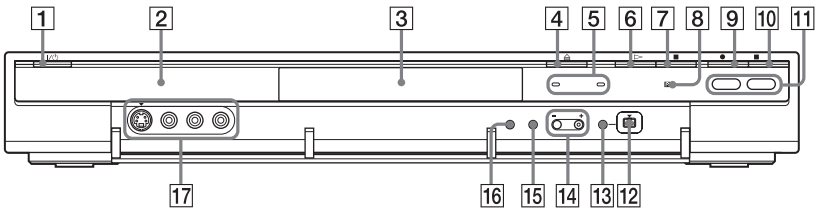

- | | |
|---|--|
| <p>1 I/⏻ (on/standby) button (24)</p> <p>2 Front panel display (120)</p> <p>3 Disc tray (32)</p> <p>4 ⏪ (open/close) button (32)</p> <p>5 TIMER REC indicator (54)
SYNCHRO REC indicator (61)</p> <p>6 ▷ (play) button (64)</p> <p>7 ■ (stop) button (64)</p> <p>8 📡 (remote sensor) (21)</p> <p>9 ● REC button (32)</p> <p>10 ■ REC STOP button (32)</p> | <p>11 HDD button/indicator (32)
DVD button/indicator (32)</p> <p>12 📡 DV IN jack (88)</p> <p>13 ONE-TOUCH DUB button (90)</p> <p>14 PROGRAM +/- buttons (32)
The + button has a tactile dot*.</p> <p>15 INPUT SELECT button (61, 88)</p> <p>16 REC MODE button (32)</p> <p>17 LINE 2 IN (S VIDEO/VIDEO/
L(MONO) AUDIO R) jacks (28)</p> |
|---|--|

* Use the tactile dot as a reference when operating the recorder.

Front panel display

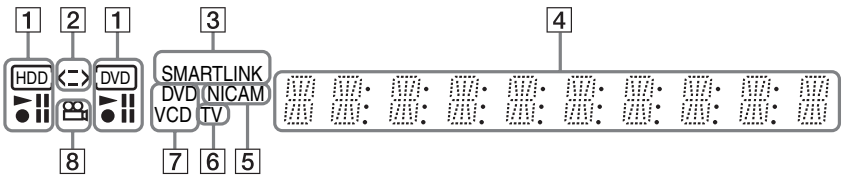

- | | |
|---|---|
| <p>1 HDD/DVD indicators
Displays the selected media and the playing/recording status.</p> <p>2 Dubbing direction indicator</p> <p>3 SMARTLINK indicator (18)</p> <p>4 Displays the following:
• Playing time
• Current title/chapter/track/index number
• Recording time/recording mode</p> | <p>• Clock</p> <p>• Programme position</p> <p>• TV Direct Rec indication (32):
“TV” appears in the right most two digits.</p> <p>5 NICAM indicator (53)</p> <p>6 TV indicator (32)</p> <p>7 Disc type*</p> <p>8 (angle) indicator (64)</p> |
|---|---|

* Displays DATA CDs as “CD.”

Hint

You can turn off the front panel display when the recorder is turned off by setting “Dimmer” to “Save Power” in the “Others” setup (page 105).

Rear panel

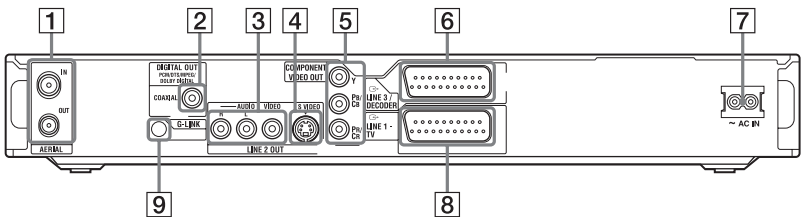

- | | |
|---|--|
| <p>1 AERIAL IN/OUT jacks (13)</p> <p>2 DIGITAL OUT (COAXIAL) jack (19)</p> <p>3 LINE 2 OUT (R-AUDIO-L/VIDEO) jacks (17, 19)</p> <p>4 LINE 2 OUT (S VIDEO) jack (17)</p> | <p>5 COMPONENT VIDEO OUT (Y, Pb/Cb, Pr/Cr) jacks (17)</p> <p>6 LINE 3/DECODER jack (17)</p> <p>7 AC IN terminal (20)</p> <p>8 LINE 1 - TV jack (17)</p> <p>9 G-LINK jack (13)</p> |
|---|--|

Language Code List

For details, see page 104.

The language spellings conform to the ISO 639: 1988 (E/F) standard.

Code Language	Code Language	Code Language	Code Language
1027 Afar	1183 Irish	1347 Maori	1507 Samoan
1028 Abkhazian	1186 Scots Gaelic	1349 Macedonian	1508 Shona
1032 Afrikaans	1194 Galician	1350 Malayalam	1509 Somali
1039 Amharic	1196 Guarani	1352 Mongolian	1511 Albanian
1044 Arabic	1203 Gujarati	1353 Moldavian	1512 Serbian
1045 Assamese	1209 Hausa	1356 Marathi	1513 Siswati
1051 Aymara	1217 Hindi	1357 Malay	1514 Sesotho
1052 Azerbaijani	1226 Croatian	1358 Maltese	1515 Sundanese
1053 Bashkir	1229 Hungarian	1363 Burmese	1516 Swedish
1057 Byelorussian	1233 Armenian	1365 Nauru	1517 Swahili
1059 Bulgarian	1235 Interlingua	1369 Nepali	1521 Tamil
1060 Bihari	1239 Interlingue	1376 Dutch	1525 Telugu
1061 Bislama	1245 Inupiak	1379 Norwegian	1527 Tajik
1066 Bengali;	1248 Indonesian	1393 Occitan	1528 Thai
Bangla	1253 Icelandic	1403 (Afan)Oromo	1529 Tigrinya
1067 Tibetan	1254 Italian	1408 Oriya	1531 Turkmen
1070 Breton	1257 Hebrew	1417 Punjabi	1532 Tagalog
1079 Catalan	1261 Japanese	1428 Polish	1534 Setswana
1093 Corsican	1269 Yiddish	1435 Pashto;	1535 Tonga
1097 Czech	1283 Javanese	Pushto	1538 Turkish
1103 Welsh	1287 Georgian	1436 Portuguese	1539 Tsonga
1105 Danish	1297 Kazakh	1463 Quechua	1540 Tatar
1109 German	1298 Greenlandic	1481 Rhaeto-	1543 Twi
1130 Bhutani	1299 Cambodian	Romance	1557 Ukrainian
1142 Greek	1300 Kannada	1482 Kirundi	1564 Urdu
1144 English	1301 Korean	1483 Romanian	1572 Uzbek
1145 Esperanto	1305 Kashmiri	1489 Russian	1581 Vietnamese
1149 Spanish	1307 Kurdish	1491 Kinyarwanda	1587 Volapük
1150 Estonian	1311 Kirghiz	1495 Sanskrit	1613 Wolof
1151 Basque	1313 Latin	1498 Sindhi	1632 Xhosa
1157 Persian	1326 Lingala	1501 Sangho	1665 Yoruba
1165 Finnish	1327 Laothian	1502 Serbo-	1684 Chinese
1166 Fiji	1332 Lithuanian	Croatian	1697 Zulu
1171 Faroese	1334 Latvian;	1503 Singhalese	
1174 French	Lettish	1505 Slovak	
1181 Frisian	1345 Malagasy	1506 Slovenian	1703 Not specified

Area Code

For details, see page 103.

Code Area	Code Area	Code Area	Code Area
2044 Argentina	2165 Finland	2362 Mexico	2149 Spain
2047 Australia	2174 France	2376 Netherlands	2499 Sweden
2046 Austria	2109 Germany	2390 New Zealand	2086 Switzerland
2057 Belgium	2248 India	2379 Norway	2528 Thailand
2070 Brazil	2238 Indonesia	2427 Pakistan	2184 United Kingdom
2079 Canada	2254 Italy	2424 Philippines	
2090 Chile	2276 Japan	2436 Portugal	
2092 China	2304 Korea	2489 Russia	
2115 Denmark	2363 Malaysia	2501 Singapore	

Index

Words in quotations appear in the on-screen displays.

Numerics

- 16:9 24, 97
- 4:3 Letter Box 24, 97
- 4:3 Pan Scan 24, 97
- “48kHz/96kHz PCM” 101

A

- “A-B Erase” 76
- Adjusting
 - playback picture 67
 - playback sound 68
 - recording picture 58
- Aerial 13
- “AFT” 94
- Album 37, 73
- Album number 37
- “Album Search” 70
- Angle 64
- Area code 121
- AUDIO 66
- “Audio” 100, 104
- “Audio ATT” 100
- “Audio Connection” 24, 100
- Audio cord 19
- “Audio DRC” 101
- “Audio Settings” 68
- “Auto Adjust” 96
- “Auto Chapter” 103
- Auto Clock Set 96
- “Auto Display” 99
- “Auto Title Erase” 55, 56, 57, 102
- “AV SYNC” 68

B

- “Basic” 93
- Batteries 21
- “Bilingual” 62, 63
- “Bilingual Recording” 102
- Bilingual recording 53

- “BNR” 67
- “Brightness” 58, 67

C

- Cable box 14, 15
- Canal Plus 29
- CD 10
- “Change Angle” 64
- “Change Order” 80
- “Channel” 94
- “Channel Setting” 93
- “Channel Sort” 95
- Chapter 37, 59, 78
- CHAPTER MARK 78
- CHAPTER MARK ERASE 78
- Chapter number 37
- “Chapter Search” 70
- Chasing Playback 69
- Checking/changing/cancelling timer settings 59
- Child Lock 65
- Clock 24, 96
- “Colour” 58, 67
- “Colour System” 99
- Colour systems 115
- “Combine” 81
- “Command Mode” 23, 106
- Component Out 24, 98
- COMPONENT VIDEO OUT 17
- Connecting
 - the aerial cable 13
 - the audio cords 19
 - the set top box controller 13
 - the video cords 17
- “Contrast” 58, 67
- Controlling TVs with the remote 21
- Copy control signals 53
- Copy-Free 53
- Copy-Never 53
- Copy-Once 53
- CPRM 9
- “Create a Playlist” 79
- Creating chapters 78

D

- DATA CD 10
- “Decoder” 30
- “Digital Out” 100
- Digital video camera 88
- “Dimmer” 105
- “Disc Information” 37, 39, 42
- Disc Settings 39, 42, 103
- Disc space 37, 75
- Disc types 8, 74
- “Divide” 77
- Dolby Digital 19, 100
- “Downmix” 101
- DTS 101
- “Dub Mode” 82, 92
- Dubbing
 - “Dub Mode” 82
 - High-speed Dubbing 82
 - Original Dubbing 83
 - Rec Mode
 - Conversion Dubbing 84
- “DV Audio Input” 89
- DV Dubbing 88
 - One Touch Dubbing 90, 105
 - Program Edit 91
- “DV EDIT” 91
- DV IN 88
- “DVD” 103
- “DVD Menu” 104
- “DVD Rec. Picture Size” 58
- “DVD Rec. Settings” 102
- DVD VIDEO 10
- DVD+R 8, 74
- DVD+RW 8, 74
- DVD-R 8, 74
- DVD-RW 8, 74

E

- Easy Setup 24, 106
- Editing 74, 78
 - DV Edit 88
- “Editor” 45
- Enter characters 38
- “Erase” 75, 79, 92

Erase all titles 76
"Erase Titles" 76
"Extend Time" 60

F

"Factory Setup" 106
"File Search" 70
"Finalise" 41
"Finalise Disc" 105
Finalising 40
"FNR" 67
"Format" 42, 106
"Format DVD-RW" 105
Formatting 42
Freeze Frame 66
Front panel 119
Front panel display 120

G

GB 43
"Grid" 44
GUIDE Plus+ system 44, 54

H

Handling discs 115
"HDD Rec. Picture Size" 58
"HDD Rec. Settings" 102
"HQ Setting" 102
"Hue" 67

I

i.LINK 116
"Info" 45
INPUT SELECT 63, 89

J

JPEG image files 71

L

Labelling 39
"Language" 104
LINE 2 IN 28
LINE 3/DECODER 27
"Line Audio Input" 62, 63
"Line1 Output" 98

"Line3 Input" 99
"Line3 Output" 99

M

Main sound 53, 66, 102
Mains Lead 20
"Make a Playlist" 80
Manual Clock Set 97
MENU 64
Menu
 DVD's Menu 64
 Top menu 64

"Mix" 89
"MNR" 67
"Move" 79, 92
MP3 audio tracks 71
MPEG 101
"My TV" 44

N

"Name" 94
NICAM 53, 94
Number buttons 39, 55

O

One Touch Dubbing 90, 105
One Touch EPG 18
One Touch Menu 65
One Touch Play 65
Original 35, 74
"OSD" 24, 97
"Others" 105

P

Page mode 35
Parental Control 65, 103
Parts and controls 118
"Pause Mode" 99
PAY-TV 29
"PAY-TV/CANAL+" 94
"PB Video Equalizer" 67
PBC 64
PDC 60
Picture quality 58, 67
Picture size 58
"Play Beginning" 65, 71
Play mode 37

Playable discs 10
Playback 10, 64
 fast forward 66
 fast reverse 66
 freeze frame 66
 instant advance 66
 instant replay 66
 JPEG image files 71
 MP3 audio tracks 71
 resume play 65
 scan audio 64
 slow-motion play 66

Playing status bar 37
Playlist 35, 74, 78
Postal Code 24
"Present Time" 97
"Preview" 79, 92
Program Edit 91
Programme Rec 33
"Progressive Mode" 98
"Progressive Output" 98
"Protect" 75
"Protect Disc" 40
Protection
 disc 40
 title 75

Q

Quick guide to disc types 8
Quick Timer 57

R

Rear panel 120
REC 33
"Rec Mode" 58
"Rec Mode Adjust" 55, 56, 57, 102
"Rec NR" 58
"Rec Settings" 58
REC STOP 33, 90
"Rec Video Equalizer" 58
Recordable discs 8
"Recording" 102

Recording 52
 picture adjustment 58
 recording format 8
 recording mode 33, 52
 recording time 33, 52
 while watching
 another
 programme 33

Recording time 52

Region code 11

Remote 21, 118

Resetting the recorder 106

Resume Play 65

“RGB” 24, 98

S

S VIDEO 17

“S Video” 24, 98

Satellite receiver 15

Scan Audio 64

“Scart Setting” 98

Scene List 79

SCHEDULE 55, 56, 59,
61

“Schedule” 44

“Screen Saver” 99

“Search” 44, 70

Searching

 fast reverse/fast

 forward 66

 locating the beginning

 of the title/

 chapter/track 66

 scan audio 64

 search mode 70

“Set Thumbnail” 76

Set top box controller 13,
26

Setting up the GUIDE

Plus+ system 25

“Setup” 45

“Sharpness” 67

Simultaneous Rec and Play
69

Slow-motion play 66

SMARTLINK 18

Sort 35

“Stereo1” 89

“Stereo2” 89

Sub sound 53, 66, 102

SUBTITLE 66

“Subtitle” 104

Super VIDEO CD 10

Synchro Rec 61

“System” 93

T

Teletext 33, 95

Thumbnail picture 35

“Time Search” 70

Timer recording

 “Auto Title Erase”

 55, 56, 57

 check/change/cancel

 59

 GUIDE Plus+ system

 54

 manual setting 56

 “Rec Mode Adjust”

 55, 56, 57

 Synchro Rec 61

 VIDEO Plus+ 55

“Timer Settings” 102

Title 37

TITLE LIST 64

Title List 34, 64

 Sort 35

 Thumbnail 35

“Title Name” 75

Title number 37

“Title Search” 70

TOP MENU 64

“Track Search” 70

Troubleshooting 107

Tuner System 24

“TV Direct Rec” 33, 102

TV GUIDE 44

“TV Guide Page” 95

TV Pause 68

TV system 93

TV  21, 33

“TV Type” 24, 97

TV/DVD 22, 33

U

“Unfinalise” 42

Unfinalising 42

Usable discs 8, 10

V

“Video” 24, 97, 98

VIDEO CD 10

Video cord 17

Video input 17

Video mode 8

“Video Output” 97

VIDEO Plus+ 55

“Video Settings” 67

VPS 60

VR mode 8

Z

ZWEITON 53



Printed on 100% recycled paper.



1-2672838127

2-672-838-12(1)

Free Manuals Download Website

<http://myh66.com>

<http://usermanuals.us>

<http://www.somanuals.com>

<http://www.4manuals.cc>

<http://www.manual-lib.com>

<http://www.404manual.com>

<http://www.luxmanual.com>

<http://aubethermostatmanual.com>

Golf course search by state

<http://golfingnear.com>

Email search by domain

<http://emailbydomain.com>

Auto manuals search

<http://auto.somanuals.com>

TV manuals search

<http://tv.somanuals.com>