

SONY®

DIGITAL VIDEOCASSETTE COMPACT PLAYER

J-H1

J-H3

i.LINK INTERFACE BOARD

HKJ-101

 **Tele-File**

HDCAM

OPERATION MANUAL English

1st Edition (Revised 1)

WARNING

To prevent fire or shock hazard, do not expose the unit to rain or moisture.

To avoid electrical shock, do not open the cabinet. Refer servicing to qualified personnel only.

WARNING

THIS APPARATUS MUST BE EARTHED.

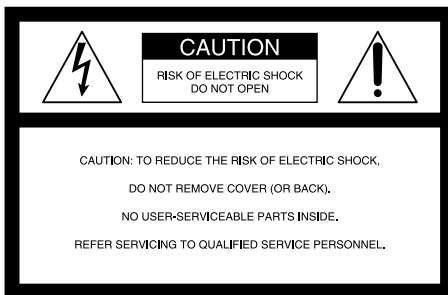

This symbol is intended to alert the user to the presence of uninsulated “dangerous voltage” within the product’s enclosure that may be of sufficient magnitude to constitute a risk of electric shock to persons.



This symbol is intended to alert the user to the presence of important operating and maintenance (servicing) instructions in the literature accompanying the appliance.

Important Safety Instructions

- Read these instructions.
- Keep these instructions.
- Heed all warnings.
- Follow all instructions.
- Do not use this apparatus near water.
- Clean only with dry cloth.
- Do not block any ventilation openings. Install in accordance with the manufacturer’s instructions.
- Do not install near any heat sources such as radiators, heat registers, stoves, or other apparatus (including amplifiers) that produce heat.

- Do not defeat the safety purpose of the polarized or grounding-type plug. A polarized plug has two blades with one wider than the other. A grounding type plug has two blades and a third grounding prong. The wide blade or the third prong are provided for your safety. If the provided plug does not fit into your outlet, consult an electrician for replacement of the obsolete outlet.
- Protect the power cord from being walked on or pinched particularly at plugs, convenience receptacles, and the point where they exit from the apparatus.
- Only use attachments/accessories specified by the manufacturer.
- Use only with the cart, stand, tripod, bracket, or table specified by the manufacturer, or sold with the apparatus. When a cart is used, use caution when moving the cart/apparatus combination to avoid injury from tip-over.



- Unplug this apparatus during lightning storms or when unused for long periods of time.
- Refer all servicing to qualified service personnel. Servicing is required when the apparatus has been damaged in any way, such as power-supply cord or plug is damaged, liquid has been spilled or objects have fallen into the apparatus, the apparatus has been exposed to rain or moisture, does not operate normally, or has been dropped.

WARNING: THIS WARNING IS APPLICABLE FOR USA ONLY.

If used in USA, use the UL LISTED power cord specified below.

DO NOT USE ANY OTHER POWER CORD.

Plug Cap	Parallel blade with ground pin (NEMA 5-15P Configuration)
Cord	Type SJT, three 16 or 18 AWG wires
Length	Minimum 1.5m, Less than 2.5 m (8 ft. 3 in.)
Rating	Minimum 10A, 125V

Using this unit at a voltage other than 120V may require the use of a different line cord or attachment plug, or both. To reduce the risk of fire or electric shock, refer servicing to qualified service personnel.

WARNING: THIS WARNING IS APPLICABLE FOR OTHER COUNTRIES.

1. Use the approved Power Cord (3-core mains lead) / Appliance Connector / Plug with earthing-contacts that conforms to the safety regulations of each country if applicable.
2. Use the Power Cord (3-core mains lead) / Appliance Connector / Plug conforming to the proper ratings (Voltage, Ampere).

If you have questions on the use of the above Power Cord / Appliance Connector / Plug, please consult a qualified service personnel.

CAUTION

Danger of explosion if battery is incorrectly replaced. Replace only with the same or equivalent type recommended by the manufacturer. Dispose of used batteries according to the manufacturer's instructions.

CAUTION

The apparatus shall not be exposed to dripping or splashing and no objects filled with liquid, such as vases, shall be placed on the apparatus.

Do not install the appliance in a confined space, such as book case or built-in cabinet.

CAUTION

The unit is not disconnected from the AC power source (mains) as long as it is connected to the wall outlet, even if the unit itself has been turned off.

For the customers in the USA

This equipment has been tested and found to comply with the limits for a Class A digital device, pursuant to Part 15 of the FCC Rules. These limits are designed to provide reasonable protection against harmful interference when the equipment is operated in a commercial environment. This equipment generates, uses, and can radiate radio frequency energy and, if not installed and used in accordance with the instruction manual, may cause harmful interference to radio communications. Operation of this equipment in a residential area is likely to cause harmful interference in which case the user will be required to correct the interference at his own expense.

You are cautioned that any changes or modifications not expressly approved in this manual could void your authority to operate this equipment.

The shielded interface cable recommended in this manual must be used with this equipment in order to comply with the limits for a digital device pursuant to Subpart B of Part 15 of FCC Rules.

For customers in Canada (for the HKJ-101)

This Class A digital apparatus complies with Canadian ICES-003.

For the customers in Europe (for the J-H1 and J-H3)

This product with the CE marking complies with both the EMC Directive (89/336/EEC) and the Low Voltage Directive (73/23/EEC) issued by the Commission of the European Community.

Compliance with these directives implies conformity to the following European standards:

- EN60065: Product Safety
- EN55103-1: Electromagnetic Interference (Emission)
- EN55103-2: Electromagnetic Susceptibility (Immunity)

This product is intended for use in the following Electromagnetic Environment(s):

E1 (residential), E2 (commercial and light industrial), E3 (urban outdoors) and E4 (controlled EMC environment, ex. TV studio).

For the customers in Europe (for the HKJ-101)

This product with the CE marking complies with the EMC Directive (89/336/EEC) issued by the Commission of the European Community.

Compliance with this directive implies conformity to the following European standards:

- EN55103-1: Electromagnetic Interference (Emission)
- EN55103-2: Electromagnetic Susceptibility (Immunity)

This product is intended for use in the following Electromagnetic Environment:

E1 (residential), E2 (commercial and light industrial), E3 (urban outdoors) and E4 (controlled EMC environment, ex. TV studio).

AVERTISSEMENT

Afin d'éviter tout risque d'incendie ou d'électrocution, ne pas exposer cet appareil à la pluie ou à l'humidité.

Afin d'écartier tout risque d'électrocution, garder le coffret fermé. Ne confier l'entretien de l'appareil qu'à un personnel qualifié.

AVERTISSEMENT

CET APPAREIL DOIT ETRE MIS A LA TERRE.

AVERTISSEMENT:

1. Utiliser le cordon d'alimentation approuvé (conducteur à trois noyaux)/connecteur pour appareils approuvé / fiche avec contacts de mise à la terre approuvée, qui est conforme aux règles de sécurité de chaque pays, si applicable.
2. Utiliser un cordon d'alimentation (conducteur à trois noyaux)/connecteur pour appareils/fiche avec contacts de mise à la terre conforme aux valeurs nominales correctes (tension, ampérage).

Pour toute question concernant l'emploi du cordon d'alimentation/connecteur pour appareils/fiche ci-dessus, consulter un agent de service compétent.

ATTENTION

Il y a un risque d'explosion si la pile est mal insérée. Remplacer la pile uniquement par une pile de même type ou de type équivalent recommandé par le fabricant. Jeter les piles usées conformément aux instructions du fabricant.

ATTENTION

Eviter d'exposer l'appareil à un égouttement ou à des éclaboussures et ne placer aucun objet rempli de liquide, comme un vase, sur l'appareil.

Ne pas installer l'appareil dans un endroit confiné, par exemple une bibliothèque ou un placard encastré.

ATTENTION

Cet appareil n'est pas déconnecté de la source d'alimentation secteur tant qu'il est raccordé à la prise murale, même si l'appareil lui-même a été mis hors tension.

Pour les utilisateurs au Canada (pour la carte HKJ-101)

Cet appareil numérique de la classe A est conforme à la norme NMB-003 du Canada.

Pour les clients européens (pour les modèles J-H1 et J-H3)

Ce produit portant la marque CE est conforme à la fois à la Directive sur la compatibilité électromagnétique (EMC) (89/336/CEE) et à la Directive sur les basses tensions (73/23/CEE) émises par la Commission de la Communauté européenne.

La conformité à ces directives implique la conformité aux normes européennes suivantes:

- EN60065: Sécurité des produits
- EN55103-1: Interférences électromagnétiques (émission)
- EN55103-2: Sensibilité électromagnétique (immunité)

Ce produit est prévu pour être utilisé dans les environnements électromagnétiques suivants:

E1 (résidentiel), E2 (commercial et industrie légère), E3 (urbain extérieur) et E4 (environnement EMC contrôlé ex. studio de télévision).

Pour les clients européens (pour la carte HKJ-101)

Ce produit portant la marque CE est conforme à la Directive sur la compatibilité électromagnétique (EMC) (89/336/CEE) émise par la Commission de la Communauté Européenne.

La conformité à cette directive implique la conformité aux normes européennes suivantes:

- EN55103-1: Interférences électromagnétiques (émission)
- EN55103-2: Sensibilité électromagnétique (immunité)

Ce produit est prévu pour être utilisé dans l'environnement électromagnétique suivant:

E1 (résidentiel), E2 (commercial et industrie légère), E3 (urbain extérieur) et E4 (environnement EMC contrôlé ex. studio de télévision).

WARNUNG

Um Feuergefahr und die Gefahr eines elektrischen Schlages zu vermeiden, darf das Gerät weder Regen noch Feuchtigkeit ausgesetzt werden.

Um einen elektrischen Schlag zu vermeiden, darf das Gehäuse nicht geöffnet werden. Überlassen Sie Wartungsarbeiten stets nur einem Fachmann.

WARNUNG

DIESES GERÄT MUSS GEERDET WERDEN.

WARNUNG:

1. Es ist ein (dreiadriges) Netzkabel/Netzstecker mit Erdungskontakt zu verwenden, der den Sicherheitsbestimmungen vor Ort entspricht.
2. Es ist ein (dreiadriges) Netzkabel/Netzstecker mit ausreichenden Anschlußwerten (Spannung/Strom) zu verwenden.

Bei Fragen zum Gebrauch des obigen Netzkabels/Netzsteckers wenden Sie sich bitte an den technischen Kundendienst.

VORSICHT

Es besteht Explosionsgefahr, wenn die Batterie inkorrekt eingelegt wird.

Es darf nur eine identische oder eine vom Hersteller empfohlene Batterie des gleichen Typs eingesetzt werden. Entladene Batterien sind nach den Anweisungen des Herstellers zu entsorgen.

ACHTUNG

Das Gerät ist nicht tropf- und spritzwassersicher, daher dürfen keine mit Flüssigkeiten gefüllten Gegenstände, z. B. Vasen, darauf abgestellt werden.

Das Gerät nicht an Orten aufstellen, z. B. in Bücherregalen oder Einbauschränken, wo keine ausreichende Belüftung gewährleistet ist.

ACHTUNG

Solange das Netzkabel an eine Netzsteckdose angeschlossen ist, bleibt das Gerät auch im ausgeschalteten Zustand mit dem Stromnetz verbunden.

Für Kunden in Europa (für den J-H1 und J-H3)

Dieses Produkt besitzt die CE-Kennzeichnung und erfüllt die EMV-Direktive (89/336/EMG) der EG-Kommission als auch die Direktive Niederspannung (73/23/EMG).

Angewandte Normen:

- EN60065: Produktsicherheit
- EN55103-1: Elektromagnetische Verträglichkeit (Störaussendung)
- EN55103-2: Elektromagnetische Verträglichkeit (Störfestigkeit)

für die folgenden elektromagnetischen Umgebungen:

E1 (Wohnbereich), E2 (kommerzieller und in beschränktem Maße industrieller Bereich), E3 (Stadtbereich im Freien) und E4 (kontrollierter EMV-Bereich, z.B. Fernsehstudio).

Für Kunden in Europa (für das HKJ-101)

Dieses Produkt besitzt die CE-Kennzeichnung Und erfüllt die EMV-Richtlinie (89/336/EWG) EG-Kommission.

Angewandte Normen:

- EN55103-1: Elektromagnetische Verträglichkeit (Störaussendung)
- EN55103-2: Elektromagnetische Verträglichkeit (Störfestigkeit),

für die folgenden elektromagnetischen Umgebungen:

E1 (Wohnbereich), E2 (kommerzieller und in beschränktem Maße industrieller Bereich), E3 (Stadtbereich im Freien) und E4 (kontrollierter EMV-Bereich, z.B. Fernsehstudio)

Für Kunden in Deutschland

Entsorgungshinweis: Bitte werfen Sie nur entladene Batterien in die Sammelboxen beim Handel oder den Kommunen.

Entladen sind Batterien in der Regel dann, wenn das Gerät abschaltet und signalisiert "Batterie leer" oder nach längerer Gebrauchsdauer der Batterien "nicht mehr einwandfrei funktioniert". Um sicherzugehen, kleben Sie die Batteriepole z.B. mit einem Klebestreifen ab oder geben Sie die Batterien einzeln in einen Plastikbeutel.

Voor de klanten in Nederland



Gooi de batterij niet weg, maar lever hem in als KCA

Table of Contents

Chapter 1 Overview	1-1 Features 1-1 1-2 Sample System Configuration 1-3 1-3 Using the CD-ROM Manual 1-5
Chapter 2 Location and Function of Parts	2-1 Control Panel 2-1 2-1-1 Display Section 2-2 2-1-2 Search Control Section 2-5 2-1-3 Tape Transport Control Section 2-6 2-2 Connector Panel 2-7
Chapter 3 Preparations	3-1 Installation 3-1 3-2 Cassettes 3-2
Chapter 4 Playback	4-1 Preparations for Playback 4-1 4-1-1 Switching System Frequency 4-1 4-1-2 Setting the Audio Monitor Output 4-1 4-1-3 Selecting a Conversion Mode for the Down-Converter 4-1 4-1-4 Time Data Setting (Conversion from 24 to 25-Frame Mode) 4-2 4-1-5 Time Data Setting (Conversion from 23.98 to 29.97-Frame Mode) (J-H3 only) 4-2 4-2 Playback Procedures 4-3 4-2-1 Normal Playback 4-3 4-2-2 Playback in Jog Mode 4-3 4-2-3 Playback in Shuttle Mode 4-4 4-3 Superimposed Character Information 4-5 4-4 Using the Remote Commander 4-7 • Before using the Remote Commander 4-7 • How to change the lithium battery 4-7 • Setting menu 4-7 • Operating the Remote Commander 4-8 4-5 Tele-File and Shot Mark Functions 4-9
Chapter 5 Setup Menu	5-1 Menu System Configuration 5-1 5-2 Menu Operations 5-2 5-3 Basic Menu 5-7 5-4 Extended Menu 5-10
Chapter 6 Maintenance and Inspection	6-1 Removing a Cassette When Tape Slack Occurs 6-1 6-2 Head Cleaning 6-1 6-3 Moisture Condensation 6-2 6-4 Error Messages 6-3 6-5 Digital Hours Meter 6-4
Appendix	Specifications A-1

Overview

1-1 Features

The J-H1 (also referred to as the unit in this manual) is a Digital Videocassette Compact Player based on the HDCAM¹⁾ format.

For monitoring, this unit uses a down-converter so that you can check the recorded images even in the SD environment. This feature allows you to monitor images easily using a commercial TV (HD/SD) or PC display.

HDCAM format

In the HDCAM format, as in the Betacam series, a recorder can record up to two hours of HD high-quality images using a 12.65 mm-width tape. For compressing video signals, this format employs a pre-filter and coefficient recording technology.

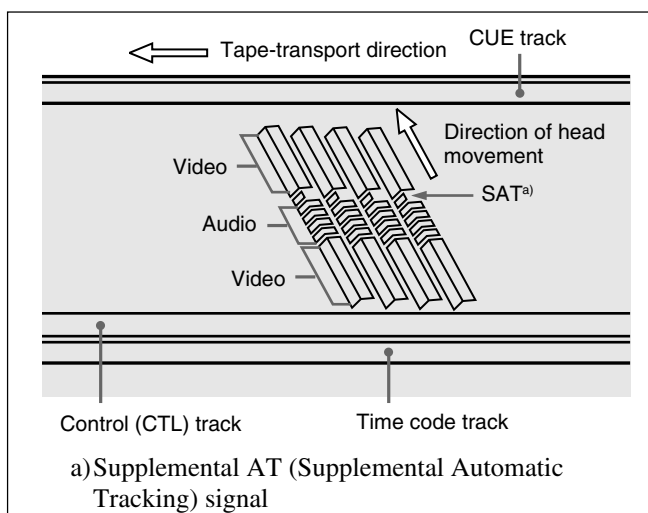

Notes

- Since the unit does not have a dynamic tracking function, the tape may not replay correctly if the recording patterns on the tape are disturbed.
- If you use mobile radio equipment within 50 cm (19 3/4 inches) of this unit, the playback image may be disturbed.

Main features

- Compatible with 50i/25PsF, 59.94i/29.97PsF, 23.98PsF (J-H3 only), 24PsF (J-H3 only) frequencies
- Compatible with playback of the 24PsF tape at 25-system (4% fast-forward)
- Equipped with not only Y/Pb/Pr connectors, but also D3 output connectors, the standard for HD Video output for commercial HDTV receivers in Japan
- Equipped with a computer display interface connector as a standard feature (XGA output)
- Equipped with a down-converter as a standard feature and compatible with composite (BNC & Pin) signals
- Equipped with an RS-232C connector
- Equipped with reference video signal input connectors as a standard feature (J-H3 only)
- Equipped with 2-3 pulldown as a standard feature (Can be used through the system frequency setting) (J-H3 only)
- Compatible with HDSDI SMPTE 292M output (HD digital video/audio 4ch) (J-H3 only)
- Compatible with SDI SMPTE 259M output (component digital video/audio 4ch) (J-H3 only)
- Equipped with a time code output connector as a standard feature (J-H3 only)
- Equipped with an RS-422A connector (J-H3 only)
- Compatible with UMID output (SMPTE 330M, RP223) (HDSDI output of the J-H3 only)

1) HDCAM is a trademark of Sony Corporation.

1-1 Features

Compact design

Since the unit is as compact as a standard desktop personal computer in size, it is ideal for personal use on your desktop. In addition, front loading of both S and L cassettes is standard.

Menu-based setup

Initial settings for the unit's operation, interfaces with connected equipment, and so on, can be made by means of menu operations on the front panel of the unit.

A wide range of status indicators

A large-sized fluorescent display is provided to show numerical values including audio level, time code, user bits, error messages, and setup menu information in addition to the current settings and operating status of this unit.

Minimal maintenance

The unit is designed to need minimal maintenance, and requires no daily maintenance or checks. A drum and other components have reduced maintenance costs.

Vertical installation

This unit can be installed vertically using the supplied vertical installation stands. The unit can be installed either vertically or horizontally, saving space on your desktop.

¹⁾ (DV) output (available only when an HKJ-101 i.LINK¹⁾ Interface Board is installed)

When an optional HKJ-101 i.LINK Interface Board is installed, this unit can output digital video/audio signals in DV format compatible with i.LINK from the DV output connector.

2-3 pulldown sequence (J-H3 only)

If you set the system frequency to 23.98PD, you can output 59.94i video signals while a tape recorded in 23.98PsF is being played back. The following is the 2-3 pulldown sequence.

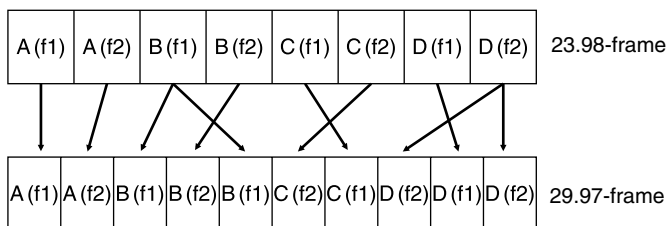

Note

The 2-3 pulldown sequence process is guaranteed only during playback in PLAY mode.

Time code multiplexed to pull down signal output

- The value of the time code multiplexed to pull down HD SDI output signal is determined by the time code preset using 24F TC A-FRAME SELECT, extended menu item 623 and 30F TC A-FRAME SELECT, extended menu item 624, and then converted from 23.98-frame into 29.97-frame time code.
- Time code data of the user's bits area is not output when the 23.98PD system functions. The time code value before conversion (23.98-frame mode) and sequence information of conversion contained in user's bits data are multiplexed to the HD SDI output signal. The following four bits are used for the sequence information to display 0 to 9 repeatedly.
 - MSB:** The first bit of the tens digit of the hour
The second bit of the tens digit of the hour
The first bit of the tens digit of the minute
 - LSB:** The first bit of the tens digit of the second
When the sequence information is masked, the remaining contents of user's bits data are the same as the time code value before conversion (23.98-frame mode).

Note

Since user's bits data multiplexed to the down-converted output signal are updated frame by frame, 23.98-frame time code and sequence information of the down-converted output signal differs from those multiplexed to the HD output signal.

Time code area	User's bits area (HD)
29.97F TC	23.98F TC + sequence information
00:00:00:00	00:00:00:00 A frame
00:00:00:00 *	00:00:80:00
00:00:00:01	00:80:00:01
00:00:00:01 *	00:80:80:01
00:00:00:02	40:00:00:01
00:00:00:02 *	40:00:80:02
00:00:00:03	40:80:00:02
00:00:00:03 *	40:80:80:03
00:00:00:04	80:00:00:03
00:00:00:04 *	80:00:80:03
00:00:00:05	00:00:00:04 A frame
00:00:00:05 *	00:00:80:04

Cycle of conversion

1)  is a trademark of Sony Corporation and indicates that this product is in agreement with IEEE 1394-1995

specifications and their revisions.

1-2 Sample System Configuration

Example for the J-H1

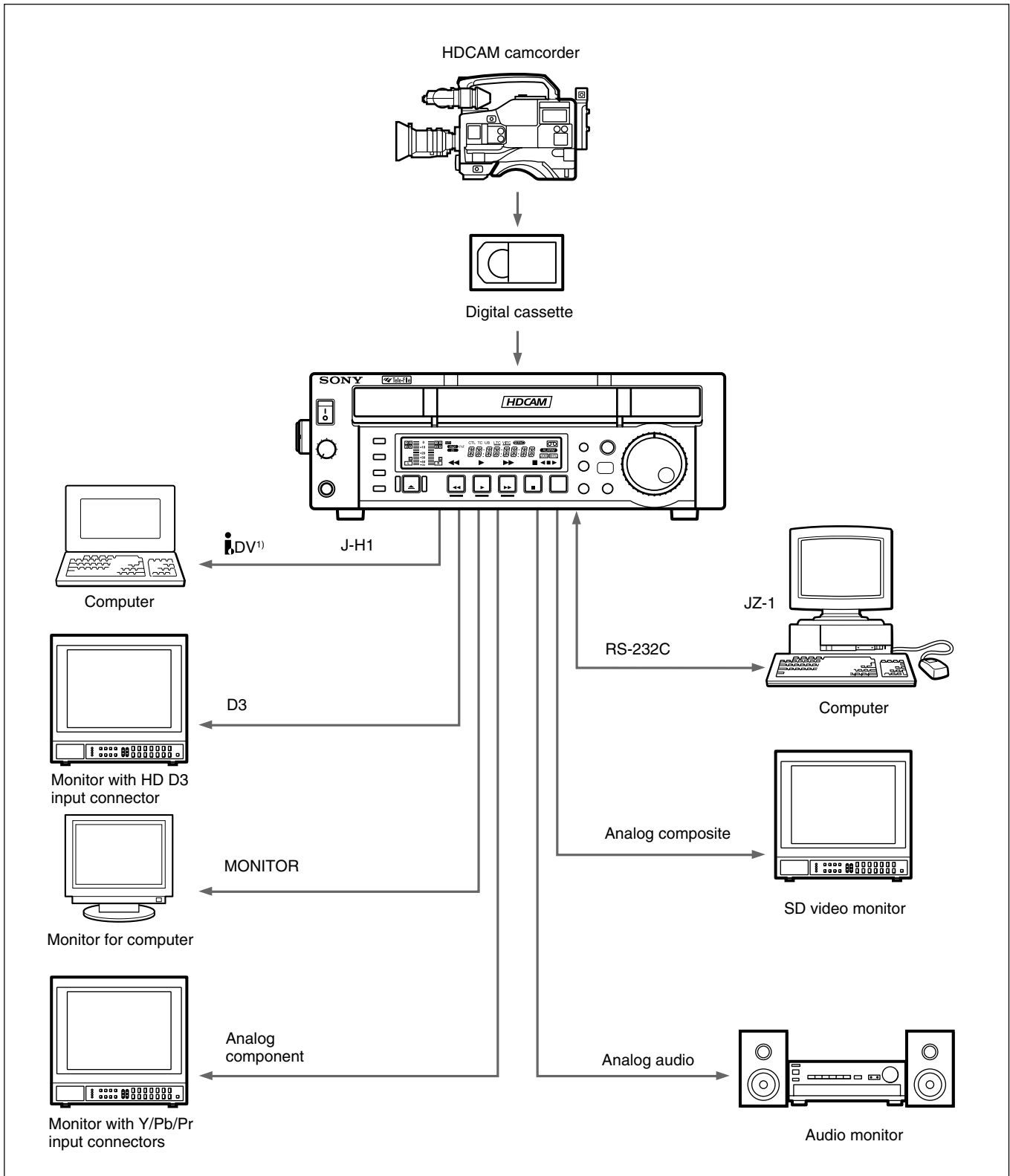

1) When an HKJ-101 i.LINK Interface Board is installed.

1-2 Sample System Configuration

Example for the J-H3

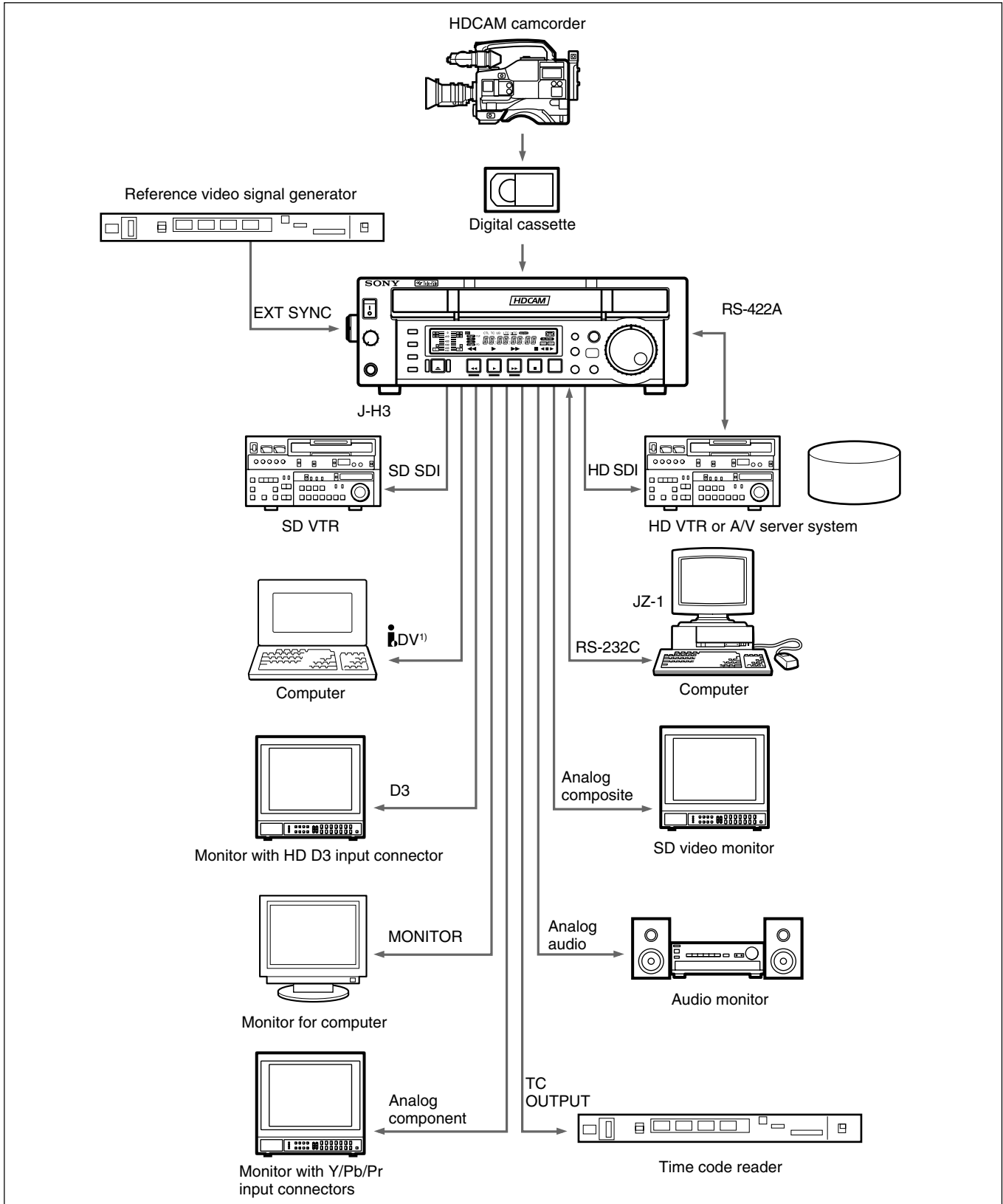

1) When an HKJ-101 i.LINK Interface Board is installed.

1-3 Using the CD-ROM Manual

The supplied CD-ROM includes Operation Manuals for the J-H series of videocassette players (English, Japanese, French, and German versions).

CD-ROM System Requirements

The following are required to access the supplied CD-ROM disc.

- Computer: PC with MMX Pentium 166 MHz or faster CPU, or Macintosh computer with PowerPC CPU
 - Installed memory: 32 MB or more
 - CD-ROM drive: × 8 or faster
- Monitor: Monitor supporting resolution of 800 × 600 or higher

When these requirements are not met, access to the CD-ROM disc may be slow, or not possible at all.

Preparations

The following software must be installed on your computer in order to use the operation manuals included on the CD-ROM disc.

- Microsoft Internet Explorer Version 4.0 or higher, or Netscape Navigator Version 4.0 or higher
- Adobe Acrobat Reader Version 4.0 or higher

Notes

- If Microsoft Internet Explorer is not installed, it may be downloaded from the following URL:
<http://www.microsoft.com/ie>
- If Netscape Navigator is not installed, it may be downloaded from the following URL:
<http://home.netscape.com/>
- If Adobe Acrobat Reader is not installed, it may be downloaded from the following URL:
<http://www.adobe.com/products/acrobat/readstep.html>

-
- MMX and Pentium are registered trademarks of Intel Corporation or its subsidiaries in the United States and other countries.
 - PowerPC is a registered trademark of International Business Machines Corporation.
 - Macintosh is a registered trademark of Apple Computer, Inc.
 - Microsoft is a registered trademark of Microsoft Corporation in the United States and/or other countries.

To Read the CD-ROM Manual

To read the operation manual included on the CD-ROM disc, do the following.

- 1 Insert the CD-ROM disc in your CD-ROM drive.

A cover page appears automatically in your browser window.

If it does not appear automatically in the browser window, double click the index.htm file on the CD-ROM disc.

- 2 Select and click the operation manual that you want to read.

A PDF file containing the operation manual opens.

Note

You can purchase a new CD-ROM disc if you lose or become unable to read the contents of the CD-ROM disc because of a hardware failure or misuse of the CD-ROM disc, or the CD-ROM disc has been lost or damaged.

Contact a Sony service representative.

- Netscape Navigator is a registered trademark of Netscape Communications Corporation in the U.S. and other countries.
- Adobe and Acrobat are registered trademarks of Adobe Systems Incorporated in the United States and/or other countries.

Location and Function of Parts

2-1 Control Panel

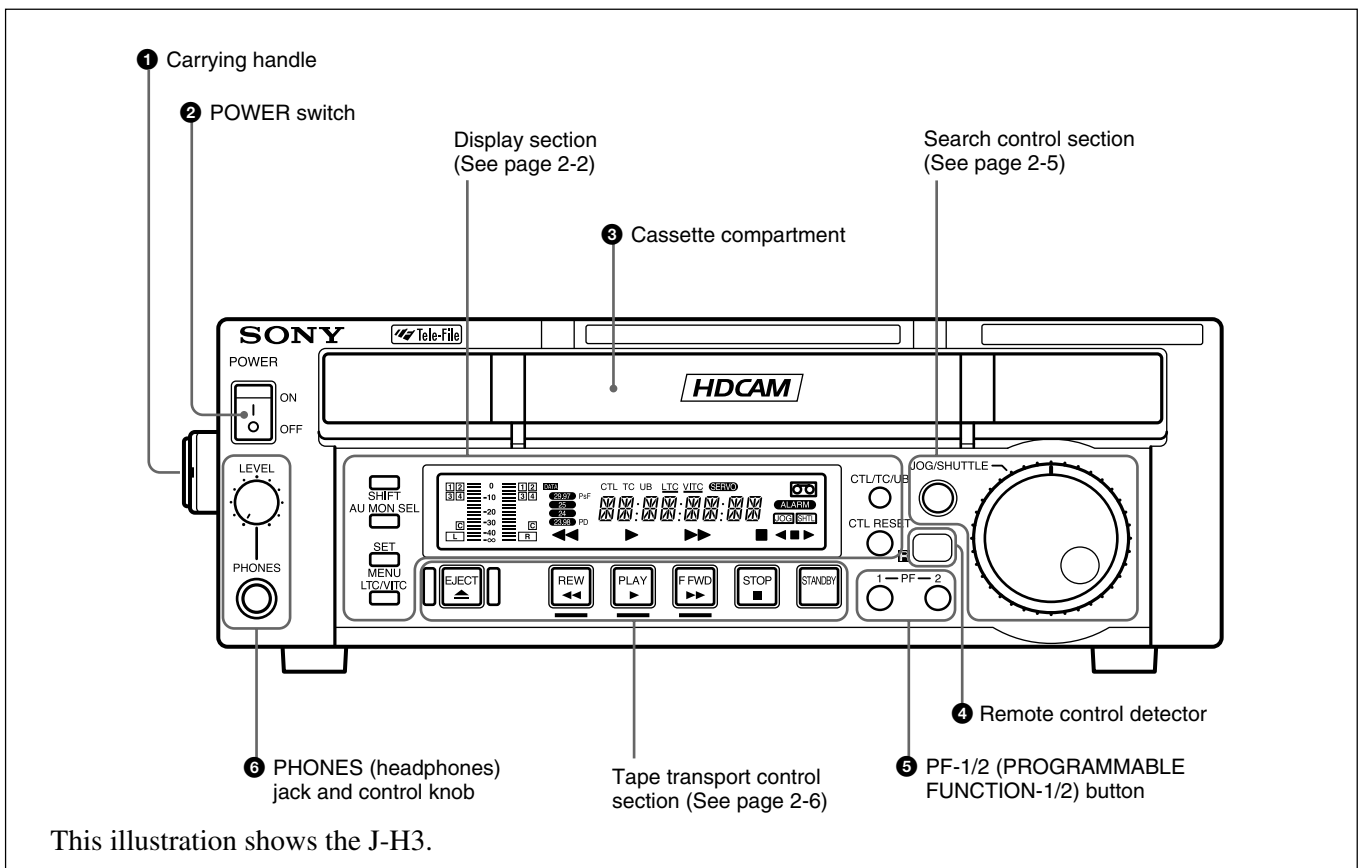

1 Carrying handle

Use this handle to carry the unit or to stand the unit vertically.

2 POWER switch

Press the side of the POWER switch marked "ON" to turn the unit on. The fluorescent display on the control panel lights.

Press the side of the POWER switch marked "OFF" to turn the unit off.

3 Cassette compartment

Insert an S or L cassette into this compartment.

2-1 Control Panel

4 Remote control detector

Receives the infrared signal from the supplied Remote Commander. For details, see “4-4 Using the Remote Commander” on page 4-7.

5 PF-1/2 (PROGRAMMABLE FUNCTION-1/2) button

You can assign the function that is set in PF2 KEY SELECT, basic menu item 022 of the setup menu, to the PF-2 button. “Tape Remain Time” is assigned to the PF-2 button as the factory default setting.

While you are pressing the PF-1 or PF-2 button, the system frequency in playback or the remaining tape time is displayed in the FL display according to the button that is being pressed.

For details of the assignment, see “Menu bank operations (menu items B01 to B12)” on page 5-5.

6 PHONES (headphones) jack and control knob

Connect stereo headphones with an impedance of 8 ohms to monitor the sound during playback.

The control knob adjusts the volume.

It is possible to make a setting so that the output volume from the AUDIO MONITOR connectors is controlled simultaneously.

Set AUDIO MONITOR OUTPUT LEVEL, extended menu item 114, on “VAR” to enable the above feature.

2-1-1 Display Section

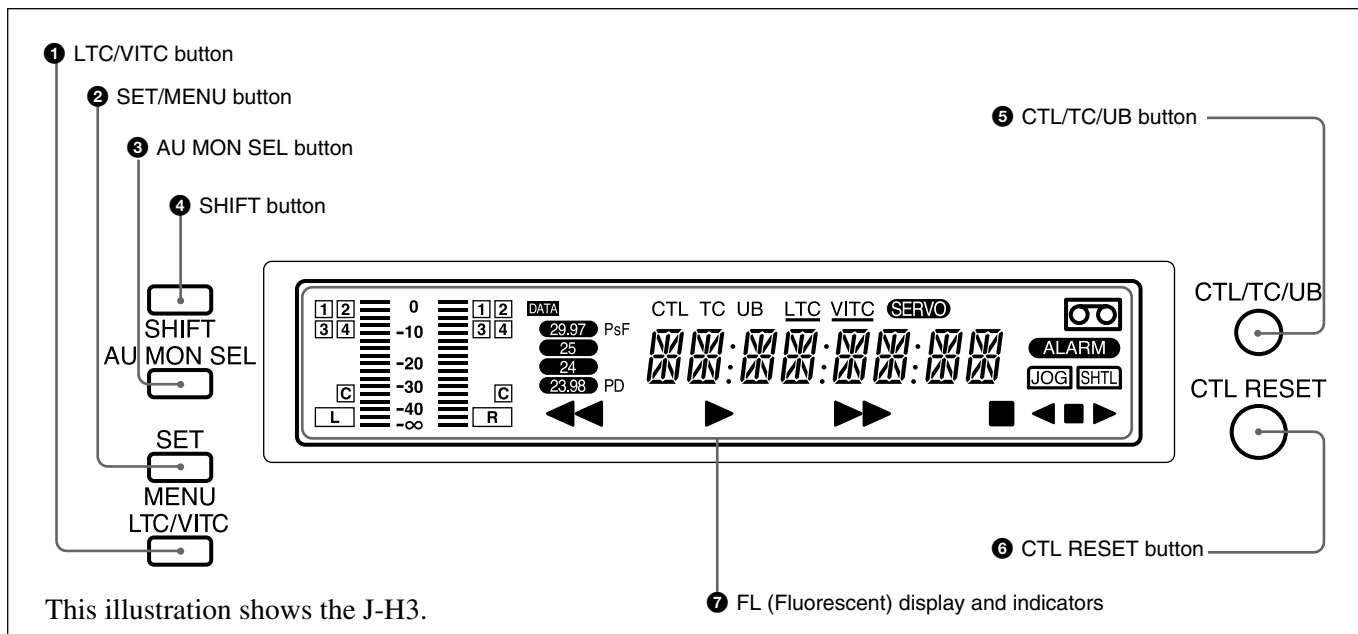

1 LTC/VITC button

This selects the time code displayed in the FL display in the following sequence: LTC¹⁾, VITC²⁾. The underline for the LTC or VITC time code setting indicators lights corresponding to the selection.

Note

In this unit, VITC may not be displayed correctly except during normal playback.

2 SET/MENU button

Use this button for setup menu operations and settings. Press the SET/MENU button while holding down the SHIFT button to display the contents of the setup menu items on the FL display. When the setting is finished, press only the SET/MENU button to fix the settings and return to the normal display.

For details of setup menu settings and operations, see Chapter 5, “Setup Menu.”

1) LTC: abbreviation of Longitudinal Time code. This time code is recorded on a longitudinal track on the tape. Reading is unreliable at low speeds, and not possible at all during still playback.

2) VITC: abbreviation of Vertical Interval Time code. This time code is inserted in the vertical blanking interval and recorded on the video tracks.

3 AU MON SEL button

Each press of this button switches the audio channel as listed below. The selected channels are displayed in the FL display.

When basic menu item 026 is set to STEREO

AUDIO CHANNEL	L	R
One press	CH-1	CH-2
Two presses	CH-3	CH-4
Three presses	CH-1,2	CH-1,2
Four presses	CH-3,4	CH-3,4
Five presses	CUE	
Six presses	After this, each press of this button switches the channel as in the sequence above.	

The latest setting of each channel is saved in the memory regardless of whether the power has been turned on/off. Therefore, regardless of the system frequency set on the unit, the last channel setting saved will be loaded automatically.

Using AUDIO MONITOR MODE, basic menu item 026 of the setup menu, you can change the assignment of the audio output. You can choose setting from among ALL, MONO, and STEREO. For details, see "5-3 Basic Menu" on page 5-7.

Press the AU MON SEL button while holding down the SHIFT button to invert the order of the options.

4 SHIFT button

Hold down this button and press the SET/MENU button to enable the menu function.

Press the F FWD or REW button while holding down the SHIFT button to do the forward or reverse cue-up of the Shot marks¹⁾ or STOP CODE points. These marks are located before and after the current tape position.

5 CTL/TC/UB (display switching) button

This selects the time data displayed in the fluorescent display in the following sequence: CTL, TC, UB. As the display changes, the corresponding indicators over the fluorescent display also light/go off.

Time data display selection and display contents

Display selection	Value displayed	Indicator status
CTL	Tape running time (hours, minutes, seconds, frames) computed from the CTL (control) signal recorded on the tape during playback.	CTL indicator lights.
TC	Playback time code read by the internal time code reader. ^{a)}	The TC indicator lights.
UB	User bit value inserted in the playback time code. ^{a)}	The UB indicator lights.

a) The LTC/VITC button switches between LTC and VITC.

6 CTL RESET button

Press this button to reset a CTL value displayed in the FL display area.

1) Shot marks

If you use a camcorder which allows you to use Shot marks, you can insert REC START markers or Shot markers in the user bits area in advance for easy editing. This is called inserting Shot marks.

2-1 Control Panel

7 FL (Fluorescent) display and indicators

These comprise a time data display area, an audio monitor display area and a number of indicators.

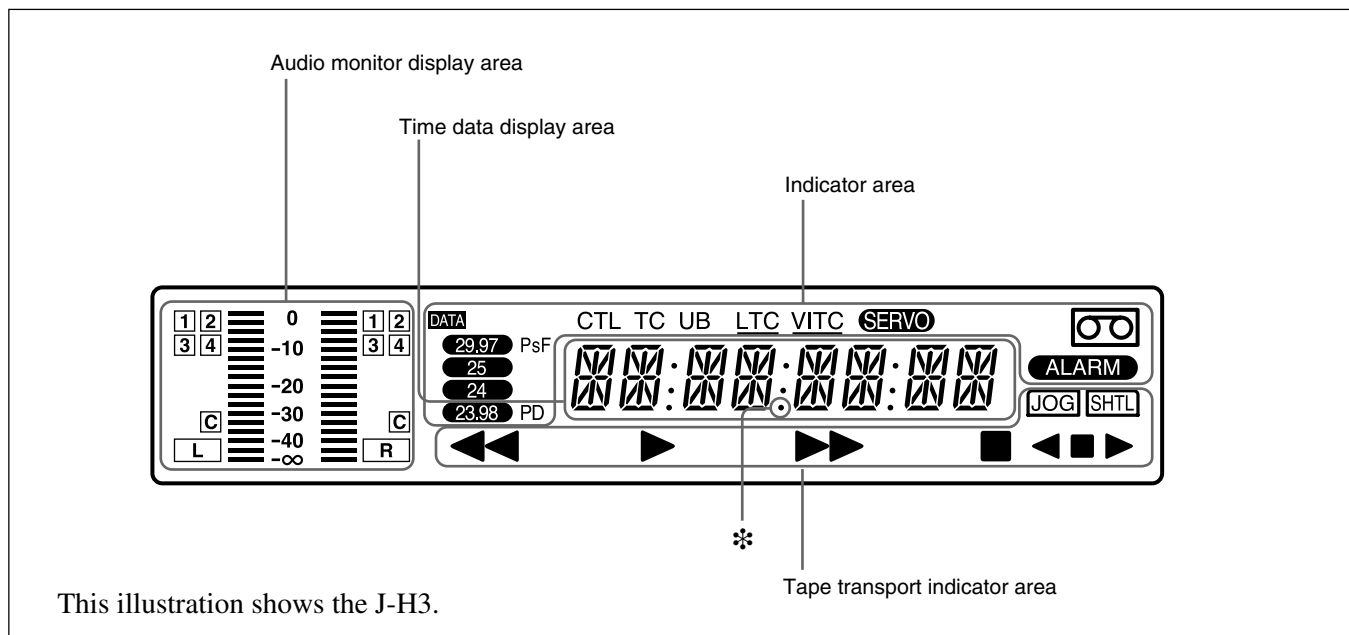

Audio monitor display area

- **L/R audio level meter**
Indicates the audio levels of the 2 optionally selected channels making up L/R (Left/Right).
- **L/R audio channel display**
Indicates the optionally selected channel numbers.

Time data display area

Normally this displays a CTL count, time code value, or user bit value according to the selection of the CTL/TC/UB button or LTC/VITC button. When a cassette recorded in the DF mode is played back, the dot by the * mark in the illustration above lights. At this time, the two dots (:) located above the dot disappear. It is also used to display error messages and the setup menus.

For details of the display of the CTL count, time code value, or user bit value, see the explanation given in "CTL/TC/UB (display switching) button" on page 2-3.

Indicator area

This includes the following indicators.

- **CTL, TC, UB indicators:** The time data selected using the CTL/TC/UB (display switching) button lights. Selected time data will be displayed on the time data display area.
- **LTC, VITC indicators:** Regardless of the display in the time data display area, these indicators light when the corresponding time code values are being read.
- **SERVO indicator:** This lights when the servo lock is functioning.
- **ALARM indicator:** This lights when a hardware error is detected on the unit, and goes off when the error is resolved. When this indicator is lit, an error message appears in the time data display area.
- **Cassette-in indicator** : This lights when a cassette is loaded in the unit.
- **DATA indicator:** This lights when a tape, containing audio data such as Dolby-E and AC-3 on its DIGITAL AUDIO track, is played back.
- **PsF indicator:** This lights when a tape, which is recorded in PsF, is played back.
- **System frequency indicator:** The system frequency selected in SYSTEM FREQUENCY SELECT, basic menu item 013 of the setup menu, lights. When the selected frequency and the frequency of the tape being played back are incompatible, this indicator flashes.
- **PD indicator (J-H3 only):** This lights when the system frequency is set to 23.98PD.

Tape transport indicator area

- Tape transport indicator
When you press each button in the tape transport control section, the corresponding indicators light.
 - ◀◀: REW (rewind) indicator
 - ▶: PLAY indicator
When AUTO TRACKING (the automatic tape loading function) is in operation, this indicator flashes.
 - ▶▶: F FWD (fast forward) indicator
 - : STOP indicator
- JOG/SHTL (jog/shuttle) indicator
The “JOG” indicator lights when playback is carried out in jog mode, and the “SHTL” indicator lights when playback is carried out in shuttle mode.
- JOG/SHTL (jog/shuttle) transport indicator
 - ◀: Jog/shuttle reverse indicator (green)
 - ▶: Jog/shuttle forward indicator (green)
 - : Jog/shuttle still indicator (red)

2-1-2 Search Control Section

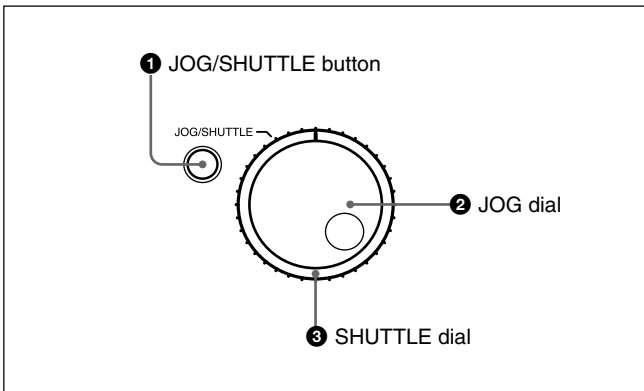

1 JOG/SHUTTLE button

Use this button to toggle between jog mode and shuttle mode when using the JOG dial or SHUTTLE dial. Press this button once for playback in jog mode, or press this button twice for playback in shuttle mode during playback or F FWD/REW. The corresponding “JOG” indicator or “SHTL” indicator lights in the FL display area.

2 JOG dial

Turn this to carry out playback in the modes shown in the following table. Turn the dial clockwise for forward playback and counterclockwise for reverse playback.

3 SHUTTLE dial

Turn this to carry out playback in the modes shown in the following table. Turn the dial clockwise for forward playback and counterclockwise for reverse playback.

After pressing the JOG/SHUTTLE button, turn the JOG dial for playback in jog mode and the SHUTTLE dial for playback in shuttle mode.

Playback modes using the JOG/SHUTTLE dial

Playback mode	Operations and functions
Jog	Press the JOG/SHUTTLE button once to light “JOG,” then turn the JOG dial, or simply turn the JOG dial without lighting “JOG.” Playback is carried out at a speed corresponding to the rotating speed of the JOG dial. The playback speed range is from -1 to +1 times normal speed. The JOG dial has no detents.
Shuttle	Press the JOG/SHUTTLE button twice to light “SHTL,” then turn the SHUTTLE dial, or simply turn the SHUTTLE dial without lighting “SHTL.” Playback is carried out at a speed corresponding to the angular position of the SHUTTLE dial. The playback speed range is from -21 to +21 times normal speed. The SHUTTLE dial has detents at the center position, and at that point a still picture is displayed.

Notes

- Normally, you turn the SHUTTLE dial after setting the jog/shuttle mode by pressing the JOG/SHUTTLE button. However, you can also set the jog/shuttle mode simply by turning the dial. (This feature is available when SELECTION FOR JOG/SHUTTLE DIAL ENABLE, extended menu item 101 of the setup menu, is set to DIAL.) In this case, you must reset the SHUTTLE dial to the center position after turning it, otherwise the dial may be moved by vibration and the tape may start running in the shuttle mode during playback.
- If the unit carries out reverse playback in the shuttle mode at -0.5 times or less normal speed for 20 consecutive minutes, the reel motor heat protection circuit automatically functions and the unit enters still mode.

2-1 Control Panel

2-1-3 Tape Transport Control Section

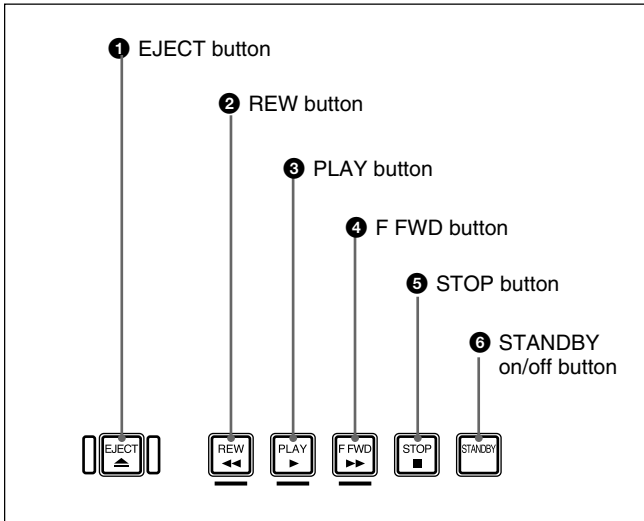

1 EJECT button

Press this button to eject the cassette.

2 REW (rewind) button

To rewind the tape, press this button. The REW indicator lights. When you are using a tape containing shot marks, press this button while holding down the SHIFT button to cue-up the shot mark position located just before the current position.

3 PLAY button

To start playback, press this button. The PLAY indicator lights. When you are using a tape containing UMID data, press this button while holding down the SHIFT button to display UMID data on the monitor.

UMID	INFORMATION	
INSTANCE	①	②
MATERIAL	③	
	④	
	⑤	
DATE/TIME		⑥
⑦		⑧
ALTITUDE	⑨	⑩⑪⑫
LONGITUDE		⑬
LATITUDE		⑭
ORGANIZATION		⑮
USER	⑯	COUNTRY ⑰

- ① Instance Number Generation Method
- ② Instance Number
- ③ Material Number Generation Method
- ④, ⑤ Material Number
- ⑥ Year/Month/Date
- ⑦ Hour:Minute:Second
- ⑧ Time Zone
- ⑨ GPS Altitude
- ⑩ Number of Satellites
- ⑪ Auxiliary Device
(“-”: not equipped, “+”: equipped)
- ⑫ PDOP (Position Dilution Of Precision value)
- ⑬ Longitude (E: east/W: west)
- ⑭ Latitude (S: south/N: north)
- ⑮ Organization Code
- ⑯ User Code
- ⑰ Country Code

4 F FWD (fast forward) button

To start fast forwarding the tape, press this button. The F FWD indicator lights. When you are using a tape containing shot marks, press this button while holding down the SHIFT button to cue-up the shot mark position located just after the current position.

5 STOP button

To stop playback, press this button. The STOP indicator lights.

If REFERENCE SYSTEM ALARM, extended menu item 105 of the setup menu, has been set to ON, this button flashes when abnormalities about the external reference video signals are detected (J-H3 only). Those abnormalities are described below.

- Reference video signals are not input.
- The system frequency set in this unit does not match with the frequency of the reference video signals being input.

6 STANDBY on/off button

When a cassette is inserted in the unit and the unit is in the Stop mode, you can toggle the VTR standby mode on and off by pressing this button.

In standby mode, the drum rotates and the tape sticks to the drum. As a result, playback starts immediately. If the unit is set to 8 minutes elapse (this value can be varied using STILL TIMER extended menu item 501 of the setup menu) in standby mode, it automatically switches out of standby mode to protect the tape.

2-2 Connector Panel

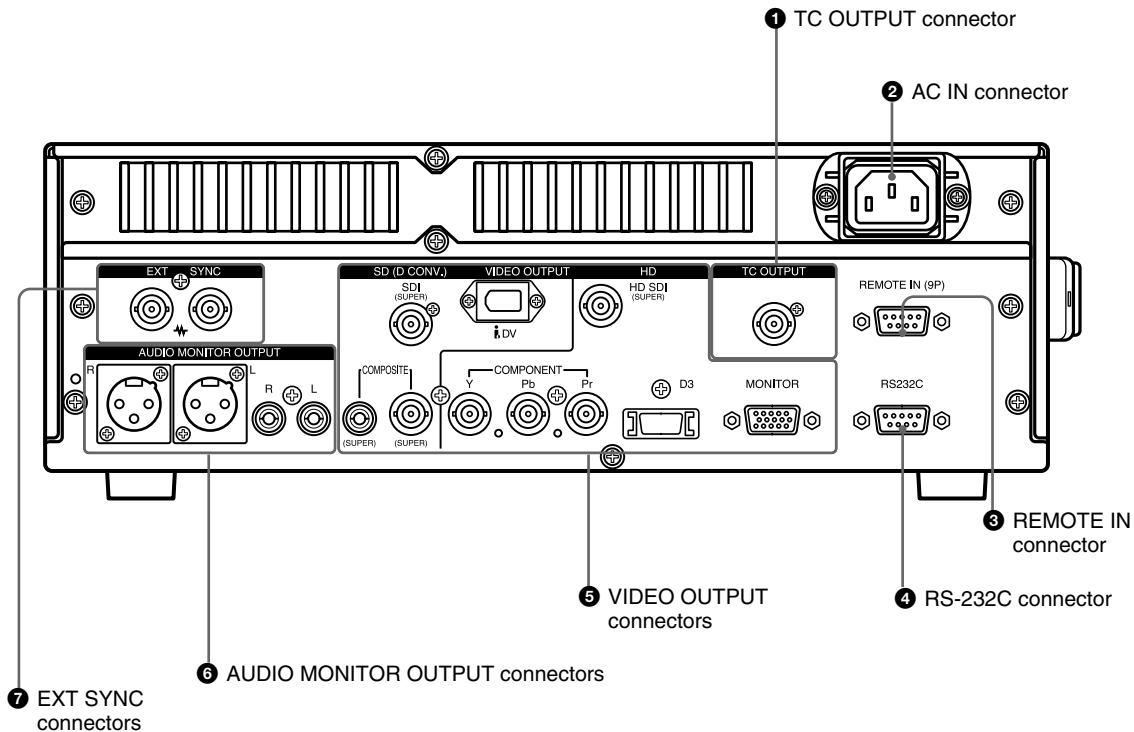

This illustration shows the J-H3 equipped with an HKJ-101 i.LINK Interface Board.

1 TC OUTPUT (time code output) connector (BNC type ×1) (J-H3 only):

Outputs the playback time code.

2 AC IN connector

Connects to an AC outlet using the power cord (not supplied).

Notes

- Place the unit near the AC outlet for easier reach of the breaker.
- Make sure to perform a ground connection for the unit before you plug the unit into the wall outlet. If you disconnect the grounding, unplug the unit from the wall outlet first.

3 REMOTE IN (9P) (remote control signal input) connector (D-sub 9-pin, female) (J-H3 only):

Connects to a BVE series editor or other VTR using a 9-pin remote control cable (not supplied) to externally control the unit.

4 RS-232C (RS-232C serial interface) connector (D-sub 9-pin, male)

Exchanges the RS-232C serial remote control signal and the VTR status signal with external devices such as a computer installed JZ-1.

5 VIDEO OUTPUT connectors

SD (D CONV.) (SD output) connectors

COMPOSITE (SUPER) (analog composite video output) connector (Phono jack ×1): Outputs an analog composite video signal.

COMPOSITE (SUPER) (analog composite video output) connector (BNC type ×1): Outputs an analog composite video signal.

SDI (SUPER) (serial digital interface output) connector (BNC type ×1) (J-H3 only): Outputs video/audio signals in D1 format.

2-2 Connector Panel

i DV (i.LINK DV output) connector (IEEE1394 type, 6-pin) (available only when an HKJ-101 i.LINK Interface Board (not supplied) is installed):

This is a connector located on the optional HKJ-101 i.LINK Interface Board. Outputs video/audio signals in DV format.

Notes

- Through the **i** DV connector, only one DV device can be connected to this unit. If you intend to connect multiple DV devices, refer to the manuals of them.
- The i.LINK (DV) output of this unit is used to provide materials to a computer on which non-linear editing software is installed. You can use a Sony VTR equipped with an i.LINK (DV) connector with this unit, though, the auto dubbing function and editing function will not be available.

HD (HD output) connectors

COMPONENT (Y/Pb/Pr) connectors (BNC type ×3): Output analog HD component video signals (Y/Pb/Pr).

D3 output connector: Outputs analog HD component video signals (Y/Pb/Pr).

MONITOR connector (D-sub 15-pin): Outputs video signals using the XGA system. The monitor and projector of the signal receiver should be set to XGA.

HD SDI (SUPER) (HD serial digital interface output) connector (BNC type ×1) (J-H3 only): Outputs video/audio signals in HD format.

When basic menu item 005, “DISPLAY INFORMATION SELECT,” of the setup menu is set to anything other than OFF, the connector outputs superimposed character information such as time code, menu settings, or alarm messages.

6 AUDIO MONITOR OUTPUT connectors Audio monitor (L/R) output connectors (XLR 3-pin, male):

Outputs two (L and R) audio monitor signals according to the setting of the AU MON SEL button on the control panel.

Audio monitor (L/R) output connectors (Phono jack ×2):

Outputs two (L and R) audio monitor signals according to the setting of the AU MON SEL button on the control panel.

7 EXT SYNC (reference video signal input) connectors (BNC type ×2) (J-H3 only):

Input reference video signals.

These connectors input the positive/negative bipolarity ternary sync signal and the Video Burst Sync (VBS) signal, in other words, the composite video signal including chroma burst. They also input the Video Sync (VS) signal, that is, the composite monochrome video signal. When a bridge connection is made, the terminator is automatically set to OFF (75 Ω).

Note

This unit performs on SYNC LOCK. It does not perform on burst LOCK.

Preparations

3-1 Installation

Installation of the unit

You can install this unit horizontally as well as vertically. However, it is necessary to use the supplied vertical installation stands to prepare the unit for vertical installation as shown in the figure.

Notes

- When you install this unit vertically, be sure that the handle faces up.
- Regardless of whether you install the unit horizontally or vertically, make sure there is a space of 5 cm (2 inches) or more around the unit.

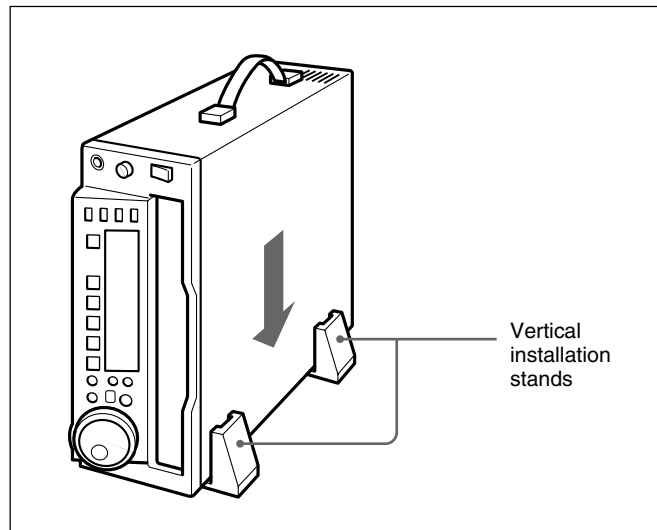

3-2 Cassettes

Cassette types

This unit uses a tape with 1/2-inch tape width. It plays HD DIGITAL VIDEO cassettes.

Inserting and ejecting cassettes

Insert or eject a cassette while the unit is powered on.

Inserting a cassette

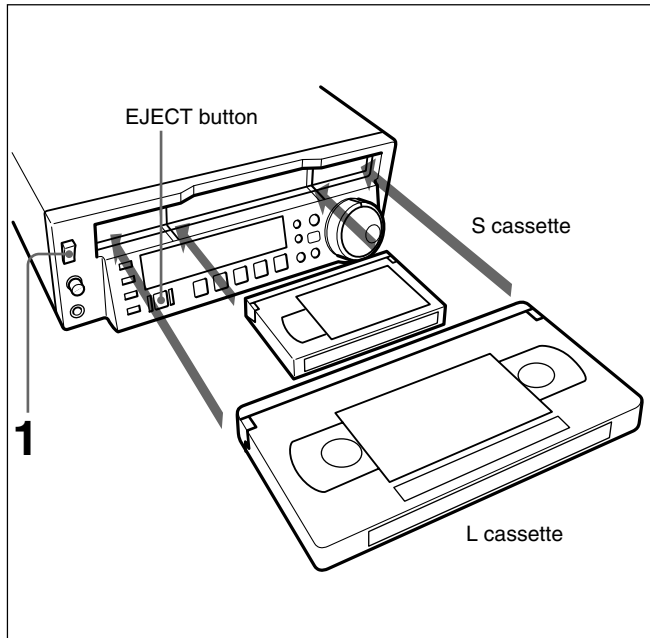

- 1 Turn the POWER switch on.
- 2 Check the following points before inserting the cassette with the orientation shown in the figure.
 - Check that there is no slack in the tape.
 - Check that the message “E10-0000” is not shown in the time data display area.

The cassette is drawn into the unit.

If the message “E10-0000” appears in the time data display area, there is moisture condensation in the unit. For steps to take when “E10-0000” is displayed, see “6-3 Moisture Condensation” on page 6-2.

Removing slack from the tape

Press one of the reels in with a finger, and turn gently in the direction shown by the arrows until there is no slack in the tape.

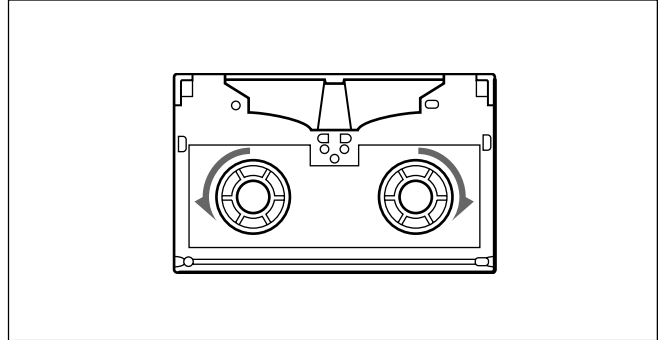

Ejecting a cassette

Press the EJECT button.
The cassette is ejected.

Playback

4-1 Preparations for Playback

4-1-1 Switching System Frequency

Switch a setting of this unit to correspond with the system frequency of a using cassette. (This is set to 29.97 system at the factory.)

For details, see “Switching system frequency (menu item 013)” on page 5-4.

4-1-2 Setting the Audio Monitor Output

Press AU MON SEL button to assign the channels to L/R outputs.

For details of channel setting and operation, see “AU MON SEL button” on page 2-3.

4-1-3 Selecting a Conversion Mode for the Down-Converter

Select a conversion mode from CONVERTER MODE (DC), extended menu item 930.

- EDGE-CROP mode (CROP)

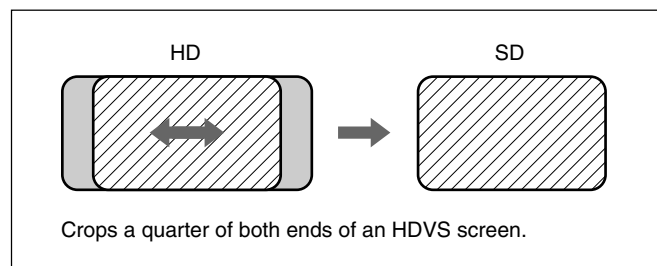

To adjust the horizontal position of the edge-cropped screen

Use H CROP POSITION (DC), extended menu item 932.

- LETTER BOX mode (LETTER BOX)

When LETTER BOX is selected, you can choose an aspect ratio for the down-converted screen from among the following 3 conversion modes included in LETTER BOX MODE (DC), extended menu item 931.

When “16:9” is selected

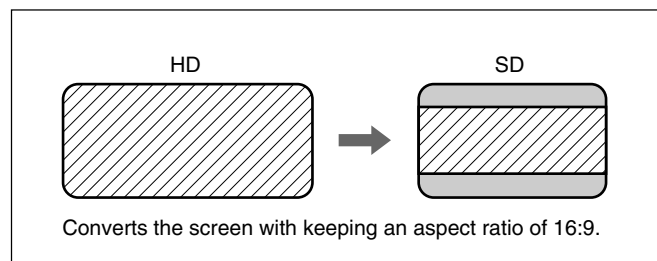

4-1 Preparations for Playback

When "14:9" is selected

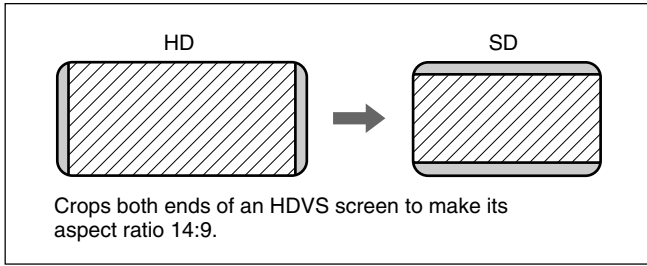

When "13:9" is selected

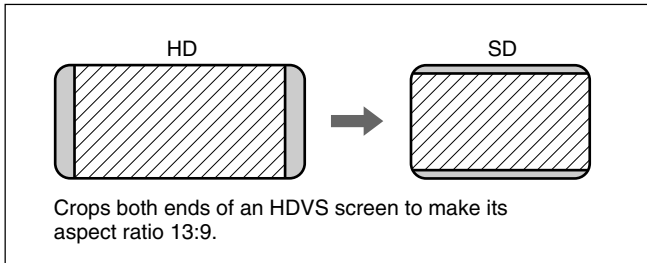

• Squeeze mode (SQUEEZE)

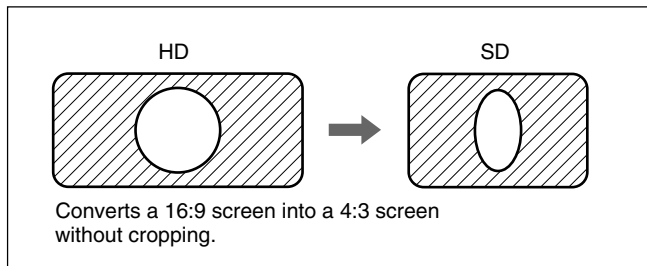

4-1-4 Time Data Setting (Conversion from 24 to 25-Frame Mode)

Displayed time data

Use the CTL/TC/UB button to select one of the CTL (control), time code, or user bit values. When time code is selected, the displayed data is determined by the setting of the LTC/VITC button (LTC/VITC) as follows.

LTC/VITC button setting	Displayed data
LTC	LTC recorded on tape
VITC	VITC recorded on tape

Time code conversion for 25-frame mode playback (TC CONV)

When you play back a tape that was originally recorded in 24-frame mode in 25-frame mode (off-speed playback), you can convert 24-frame time code into 25-frame time code.

To convert 24-frame time code into 25-frame time code, set the following menu items as shown below.

Basic menu item 005 "TIME"
 Extended menu item 620 "ON"
 Extended menu item 621 Set "STARTING TC"

These settings display 25-frame time code on the time data display area of the FL display, and superimpose both 24-frame and 25-frame time codes on the monitor.

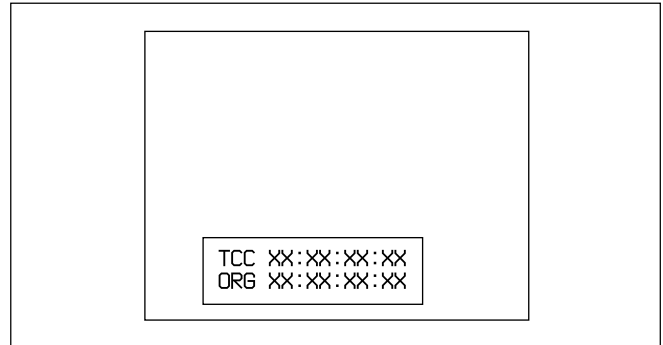

4-1-5 Time Data Setting (Conversion from 23.98 to 29.97-Frame Mode) (J-H3 only)

If you set the system frequency to 23.98PD and are about to playback a tape recorded in 23.98-frame mode, you can convert the time code into 29.97-frame time code.

To display the converted 29.97-frame time code, set the following menu items as shown below.

Basic menu item 005 "TIME"
 Extended menu item 623 Set 24F TC A-FRAME SELECT
 Extended menu item 624 Set 30F TC A-FRAME SELECT

These settings display 29.97-frame time code on the time data display area of the FL display, and superimpose both 23.98-frame and 29.97-frame time codes on the monitor.

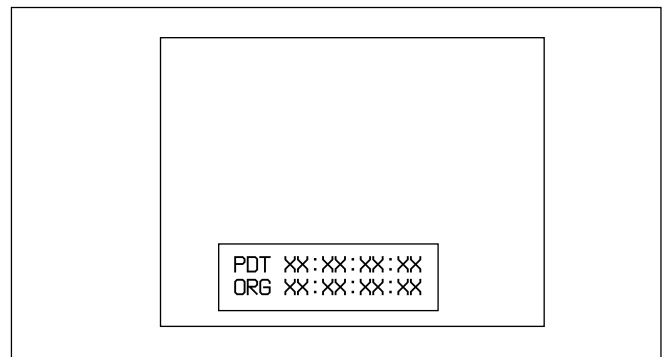

4-2 Playback Procedures

4-2-1 Normal Playback

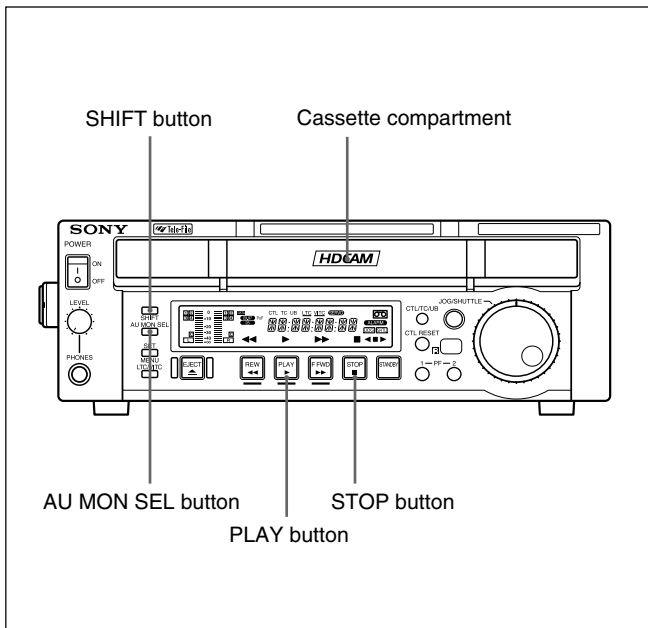

Insert a cassette beforehand.

For details of how to insert a cassette, see “Inserting and ejecting cassettes” on page 3-2.

To start playback

Press the PLAY button.

To stop playback

Press the STOP button.

If you play back to the end of the tape

The tape is automatically rewound, and stops. (When AUTO REWIND, extended menu item 125, is set to ENA)

Note

This unit uses an auto-tracking function. The factory setting for the auto-tracking is on (AUTO TRACKING ON). You can turn auto-tracking off. For details on how to change the setting, contact your nearest Sony dealer. While this unit is pulling the tape in, the PLAY button indicator ► flashes.

4-2-2 Playback in Jog Mode

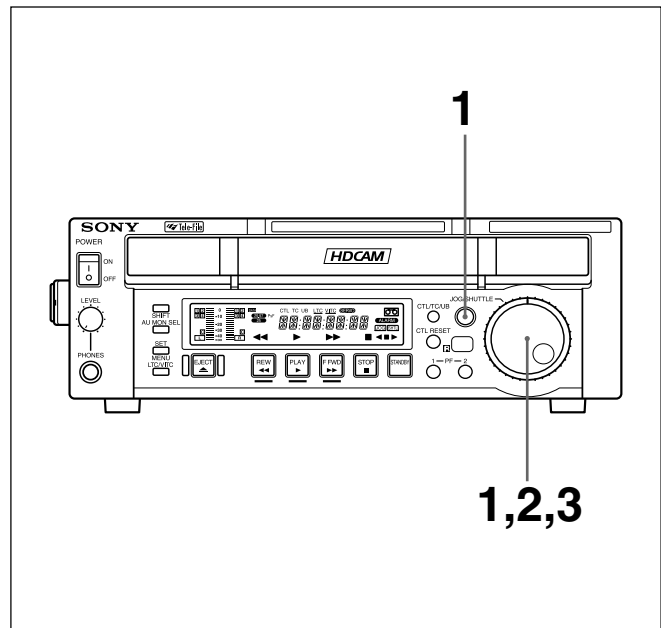

In jog mode, the JOG dial controls the playback speed based on the speed at which the dial is turned. The playback speed range is ± 1 times normal speed. Use the following procedure to carry out playback in shuttle mode.

- 1 Turn the JOG dial directly or press the JOG/SHUTTLE button to light the JOG indicator.

Pressing the JOG/SHUTTLE button toggles between jog mode and shuttle mode.

- 2 Turn the JOG dial in the desired direction, at a speed corresponding to the desired playback speed.

Playback in jog mode starts.

- 3 To stop playback in jog mode, stop turning the JOG dial.

It is possible to make pressing the JOG/SHUTTLE button to switching between JOG and SHUTTLE mode.

Select “KEY” in SELECTION FOR JOG/SHUTTLE DIAL ENABLE, extended menu item 101, to enable the above feature. (This is the default setting.)

4-2 Playback Procedures

4-2-3 Playback in Shuttle Mode

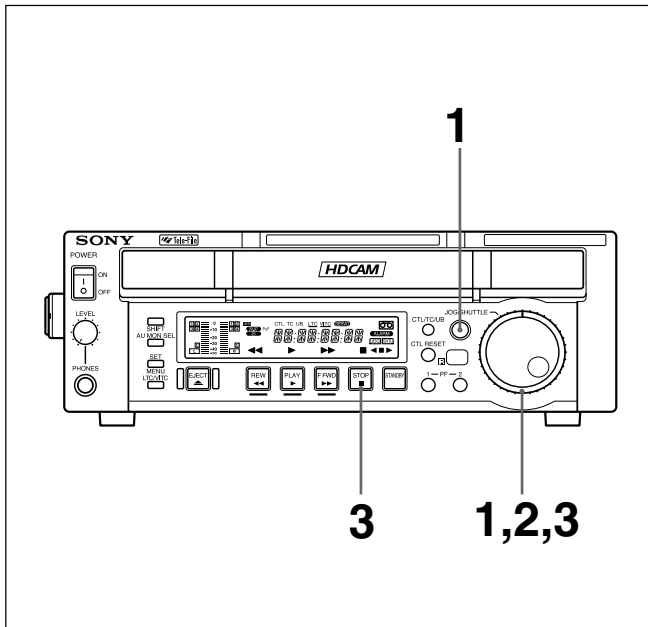

In shuttle mode, the SHUTTLE dial controls the playback speed based on the angular position of the dial. There are seven playback speeds: ± 0.03 times, ± 0.12 times, ± 0.5 times, ± 1 times, ± 2 times, ± 5 times, ± 21 times.

+ indicates forward direction speed, – indicates reverse direction speed.

The SHUTTLE dial has detents at the center position, move the SHUTTLE dial to the center indent to display a still picture.

Use the following procedure to carry out playback in shuttle mode.

- 1 Turn the SHUTTLE dial directly or press the JOG/SHUTTLE button twice to light the SHTL indicator.

If the SHUTTLE dial points to a position other than the center, playback in shuttle mode starts at a speed corresponding to the angular position of the dial.

Pressing the JOG/SHUTTLE button toggles between jog mode and shuttle mode.

- 2 Turn the SHUTTLE dial to the angle corresponding to the desired playback speed.

Playback in shuttle mode starts.

- 3 Return the SHUTTLE dial to the center indent position or press the STOP button to cancel shuttle mode playback.

It is possible to make pressing the JOG/SHUTTLE button to switching between JOG and SHUTTLE mode.

Select “KEY” in SELECTION FOR JOG/SHUTTLE DIAL ENABLE, extended menu item 101, to enable the above feature. (This is the default setting.)

To return to normal-speed playback
Press the PLAY button.

To alternate between normal-speed playback and shuttle mode playback

Set the SHUTTLE dial to the position corresponding to the desired shuttle playback speed first. Press the PLAY button, and then press the JOG/SHUTTLE button twice.

For intermittent shuttle mode playback, press the STOP button first and then press the JOG/SHUTTLE button twice.

Normally, you turn the SHUTTLE dial after setting the jog/shuttle mode by pressing the JOG/SHUTTLE button. You can also set the jog/shuttle mode, however, by directly turning the dial. (This is available when SELECTION FOR JOG/SHUTTLE DIAL ENABLE, extended menu item 101, is set to DIAL.) In this case, you must reset the SHUTTLE dial to the center position after turning it, otherwise the dial is moved by vibration and the tape may start running in the shuttle mode during playback.

4-3 Superimposed Character Information

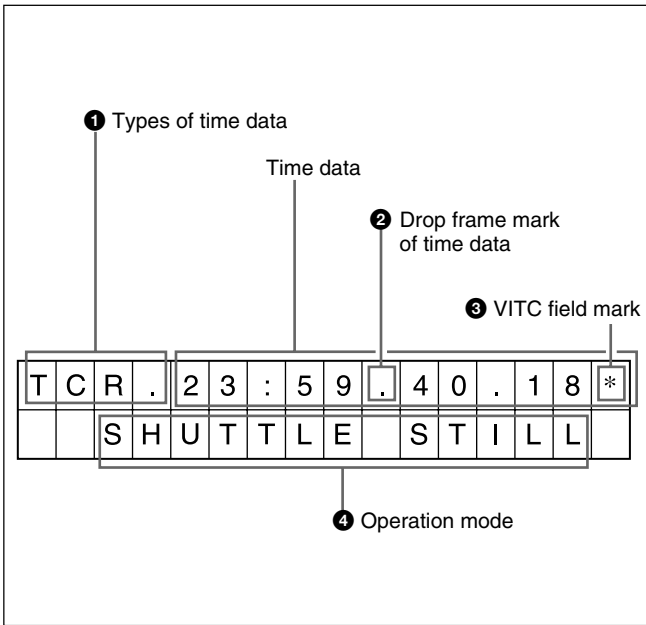

Video signal output from the SDI (J-H3 only), HD SDI (J-H3 only), COMPOSITE, COMPONENT (Y/Pb/Pr), D3 or MONITOR connectors contains superimposed character information (overlaid display), including time code, menu settings, or alarm messages.

For details on the settings for superimposed display, see “DISPLAY INFORMATION SELECT,” basic menu item 005 on page 5-7, “SD CHARACTER,” basic menu item 027 on page 5-8, and “HD CHARACTER,” basic menu item 028 on page 5-8.

Adjusting the character display

The basic menu adjusts the position, size and type of the superimposed characters.

For details of the basic menu, see “5-3 Basic Menu” on page 5-7.

Note

The display shown on the left corresponds to the factory default settings of the unit.

Changing the setting of DISPLAY INFORMATION SELECT in basic menu item 005 allows different time data to be displayed in the bottom line of the display.

For details, see “Items in the basic menu” on page 5-7.

Displayed items

1 Types of time data

Display	Meaning
CTL	CTL counter data
TCR	LTC reader time code
UBR	LTC reader user bit
TCR.	VITC reader time code
UBR.	VITC reader user bit

Note

If the time data or user bit cannot be read correctly, they will be displayed with an asterisk. For example, “T*R”, “U*R”, “T*R.” or “U*R.”.

2 Drop frame mark of time data

- “.”: Drop frame mode
- “:”: Non-drop frame mode

3 VITC field mark

- “ ” **blank**: When displaying Field 1 and 3
- “* ”: When displaying Field 2 and 4

4-3 Superimposed Character Information

4 Operation mode

The field is divided into two blocks, A and B.

- **Block A:** displays the operation mode.
- **Block B:** displays the servo lock status or tape speed.

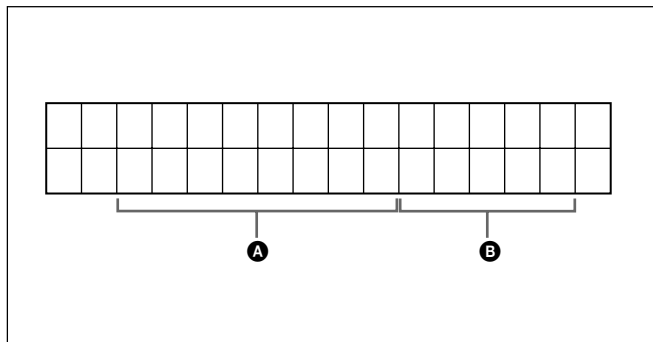

Display		Operation mode
Block A	Block B	
TAPE UNTHREAD		Cassette is not loaded.
STANDBY OFF		Standby off mode
STOP		Stop mode
F.FWD		Fast forward mode
REW		Rewind mode
PLAY		Playback mode (servo unlocked)
PLAY	LOCK	Playback mode (servo locked)
JOG	STILL	A still picture in jog mode
JOG	FWD	Jog mode in forward direction
JOG	REV	Jog mode in reverse direction
SHUTTLE	STILL	A still picture in shuttle mode
SHUTTLE	(Speed)	Shuttle mode

4-4 Using the Remote Commander

Before using the Remote Commander

Pull off the transparent film covering the battery parts.

How to change the lithium battery

- 1 Pull out the lithium battery case.

Pull the battery case toward you while releasing the lock by plucking it with your fingernail.

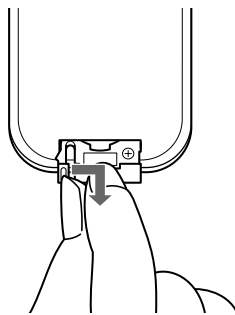

- 2 Set lithium battery in the case.

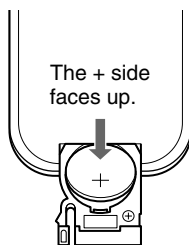

- 3 Push the lithium battery case back into its original position.

Notes on the Remote Commander

- If there is an obstacle between the Remote Commander and the remote control detector, the Remote Commander sometimes does not work properly. Point the Remote Commander at the remote control detector on the front side of the unit.
- The effective remote control area is limited. It becomes easier to control the unit the closer you get and if you point the Remote Commander directly at the front of the unit.
- Change the battery when the Remote Commander does not work properly.

Setting menu

When a Remote Commander is used, WIRELESS REMOTE CONTROL, extended menu item 213, must be set to ON. (It is set to OFF at the factory.) (The following operation is an example of how WIRELESS REMOTE CONTROL is switched from OFF to ON.)

- 1 Select WIRELESS REMOTE CONTROL, extended menu item 213, to display it.

The illustration shows the information displayed in the time data display area and on the monitor connected to the VIDEO OUTPUT connectors.

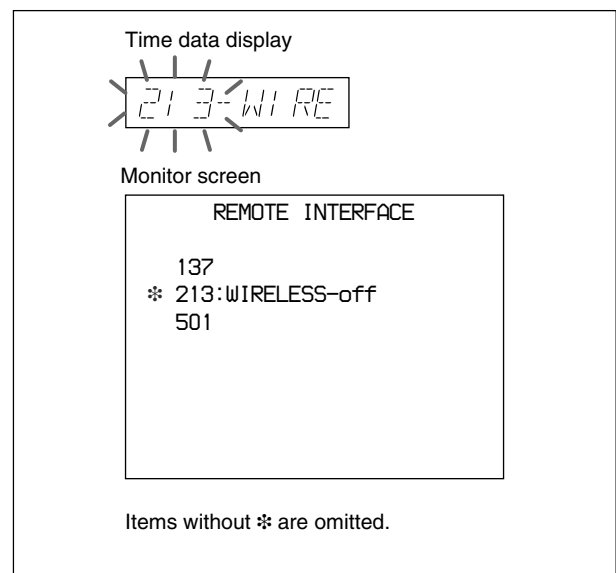

4-4 Using the Remote Commander

- Turn the JOG/SHUTTLE dial to change the setting from “OFF” to “ON” while holding down the JOG/SHUTTLE button, and then release the JOG/SHUTTLE button.

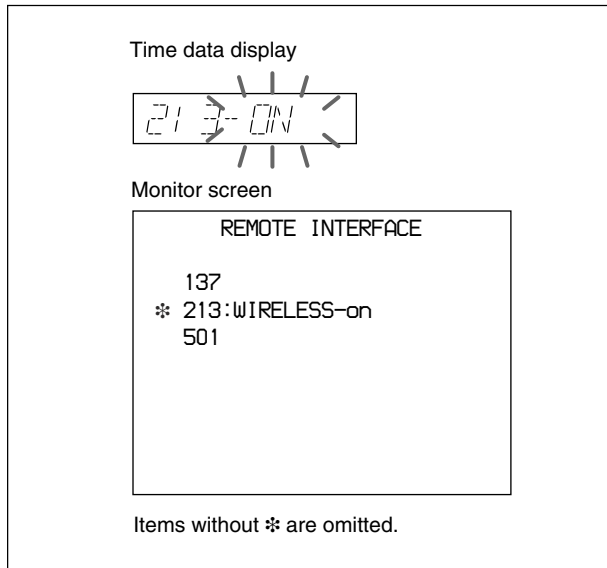

(ON flashes while the JOG/SHUTTLE button is being pressed.)

- Press the SET/MENU button.

Time data display area and monitor go back to the original views.

Note

When two or more J-H1s or J-H3s are placed close to each other, the Remote Commander may affect more than one unit. In this case, select OFF in WIRELESS REMOTE CONTROL, extended menu item 213, of the other units you do not want to operate.

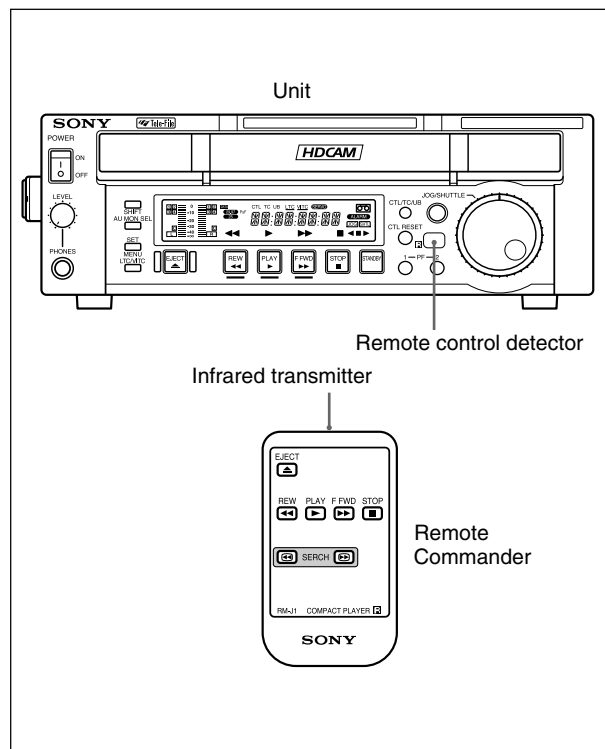

Operating the Remote Commander

Press the function keys while pointing the infrared transmitter of the Remote Commander at the remote control detector.

Each key functions same as the corresponding key on the control panel attached to the unit.

Note

For the SEARCH key, is 5 times forward speed, is 5 times reverse speed.

4-5 Tele-File¹⁾ and Shot Mark Functions

The following operations will be available when using the unit connected to a personal computer (PC) with the optional JZ-1 software installed.

For details on installation and software operation, refer to the "Readme" file and the "Help" file supplied with the JZ-1 software.

Basic Operations Such as PLAY, F FWD, REW, STOP, SHUTTLE, and JOG.

You can perform basic operations such as PLAY, F FWD, REW, STOP, SHUTTLE, and JOG via your PC.

Reading Tele-File Data and Shot Mark Data

If Shot mark data or Tele-File data have been recorded, you can automatically read image and related data based on the Shot mark or Tele-File data. (You will need to install a video capture card in your PC.)

An image that has been read will be displayed as a thumbnail image. Double-clicking the thumbnail image quickly finds the beginning of the segment. Based on the thumbnail image position (cue point), you can set an IN point and OUT point.

Writing Data in Tele-File

You can write the IN/OUT point set in the PC in Tele-File.

1) Tele-File

This is a system that can write and read material recorded on the tape using the non-contact IC memory built into the back label of the cassette.

Tele-File is a trademark of Sony Corporation.

Setup Menu

5-1 Menu System Configuration

The principal setup operations required before operating this unit can be carried out using setup menus.

The menu system of this unit is comprised of a basic menu and an extended menu.

- Basic menu

This menu is used to make the following settings:

- the digital hours meter
- the character information superimposed on the output to the monitor
- settings for switching system frequency
- settings for the menu banks for retaining menu settings

- Extended menu

This menu is used to make the following wide range of settings on this unit:

- the control panel functions
- tape protection
- video and audio control
- digital data processing

This unit allows up to two menu settings to be stored in menu banks 1 and 2.

The stored menu settings can be called up to use as required.

For more information, see “Menu bank operations (menu items B01 to B12)” on page 5-5.

5-2 Menu Operations

This section describes the basic menu displays and how to change the settings.

For information about how to use basic menu item 013, see "Switching system frequency (menu item 013)" on page 5-4, and for information about how to operate items B01 to B12, see "Menu bank operations (menu items B01 to B12)" on page 5-5.

Displaying the menus

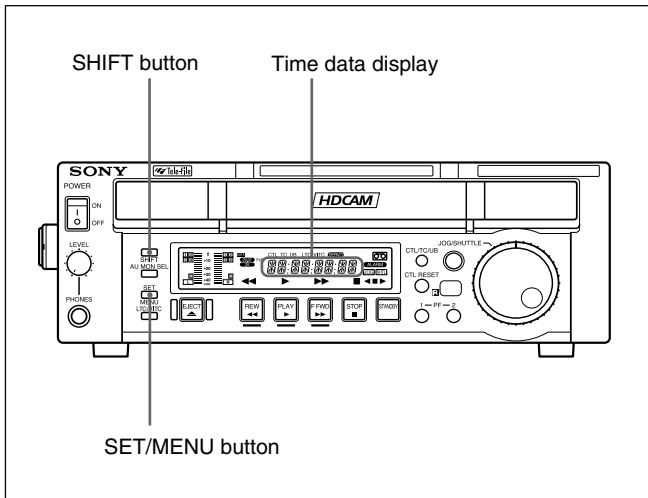

Press the SET/MENU button while holding down the SHIFT button.

The setting of the currently selected menu item appears in the time data display.

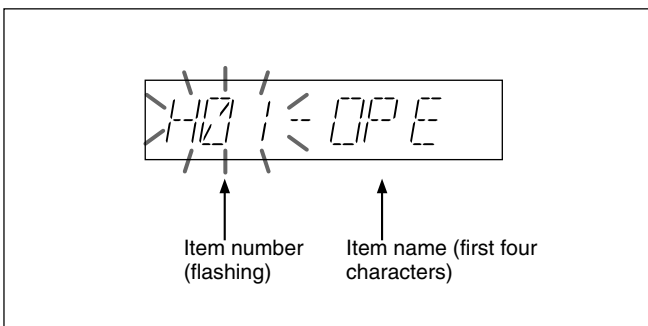

Displaying the menus on the monitor

Menu setting can be done on the monitor while superimposing is set to ON.

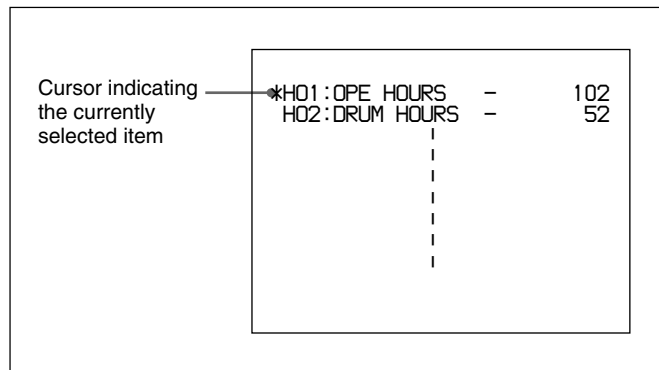

Changing the currently displayed menu item

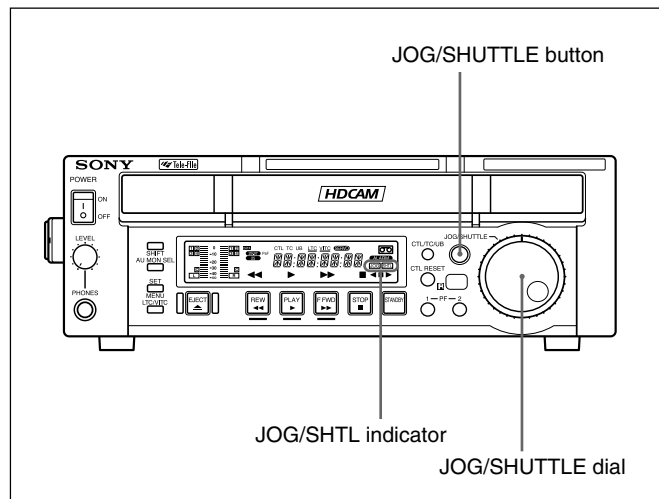

Turn the JOG/SHUTTLE dial.

Turning the JOG/SHUTTLE dial to the right increments the item number and turning it to the left decrements the item number.

The item number changes at a rate depending on the JOG/SHUTTLE dial position (when the SHTL indicator is lit) or on the JOG/SHUTTLE dial rotation rate (when the JOG indicator is lit).

Changing a menu item setting value

To change the setting value of the currently displayed menu item, use the following procedure.

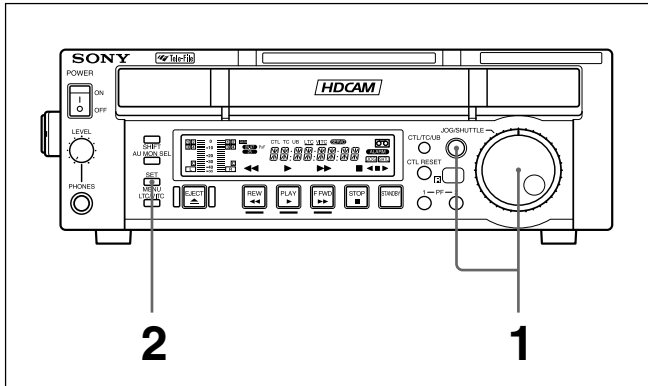

- 1 Holding down the JOG/SHUTTLE button, turn the JOG/SHUTTLE dial.

The setting value changes at a rate based on the SHUTTLE dial position or on the JOG dial rotation rate.

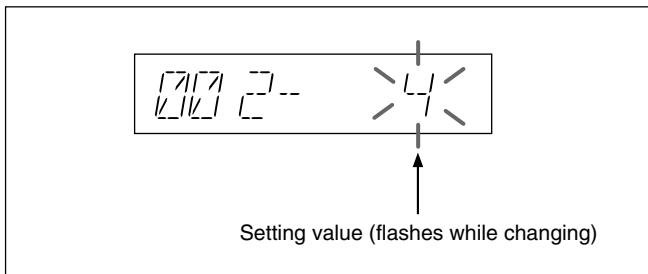

- 2 When the desired setting value is displayed, press the SET/MENU button.

This saves the new setting value, and the menu display disappears from the time data display.

To cancel the change

Press the SET/MENU button while holding down the SHIFT button before pressing the SET/MENU button only.

The menu display disappears from the time data display without saving the new setting value.

Resetting the menu settings to their factory default values (menu item B20)

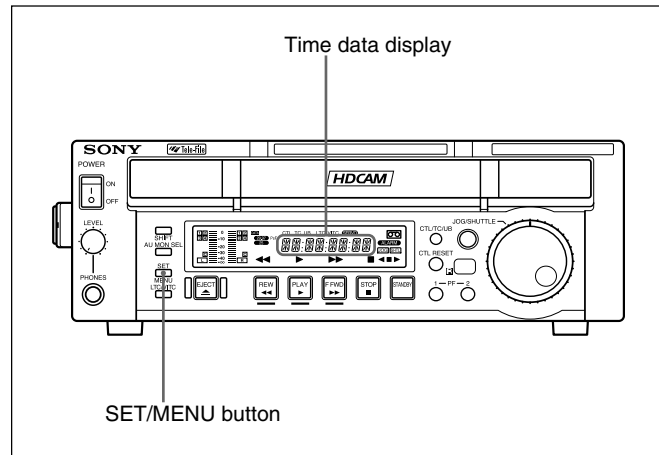

- 1 Set RESET SETUP, basic menu item B20, to ON.

“PUSH SET” appears in the time data display, and “Push SET button” appears on the monitor screen.

- 2 Press the SET/MENU button.

The current active menu settings (see “Menu bank operations (menu items B01 to B12)”) are reset to their factory default settings.

- 3 Press the SET/MENU button again.

The settings are saved and the menu display disappears from the time data display.

5-2 Menu Operations

Switching system frequency (menu item 013)

Using the following procedure, you can set SYSTEM FREQUENCY SELECT, basic menu item 013, to "ON," and then switch the system frequencies between 29.97, 25, 24 (J-H3 only), 23.98 (J-H3 only), and 23.98PD (J-H3 only).

(The following procedure is an example of switching from a 29.97 system to a 25 system.)

- 1 Select SYSTEM FREQUENCY SELECT, basic menu item 013, and display it.

The time data display and the monitor screen connected to VIDEO OUTPUT connectors show the following displays.

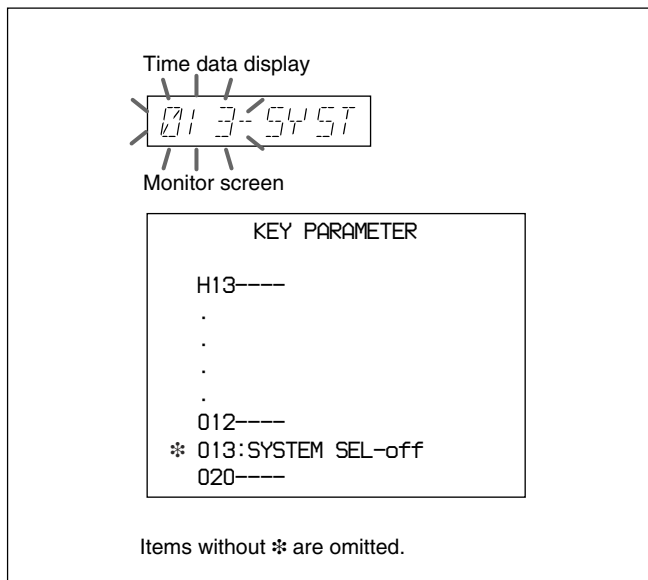

- 2 Holding down the JOG/SHUTTLE button, turn the JOG/SHUTTLE dial to change the setting from "OFF" to "ON," then release the JOG/SHUTTLE button.

The displays change as follows.

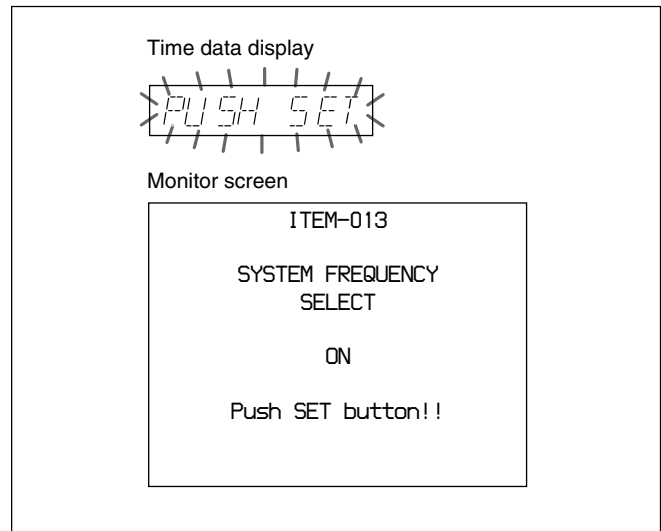

- 3 Press the SET/MENU button.

The displays change as shown below.

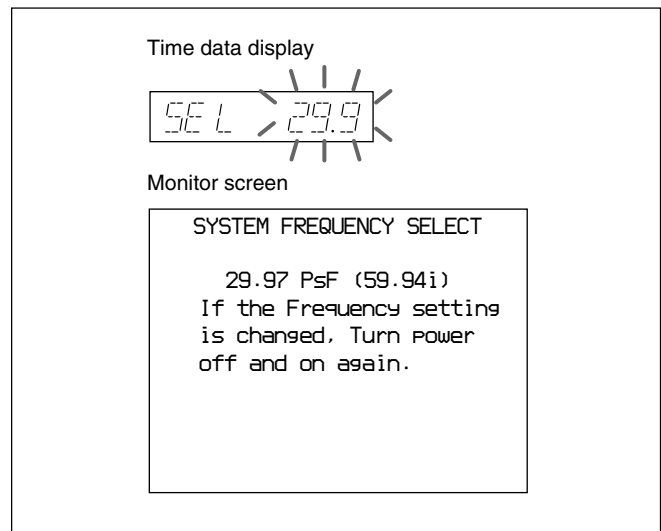

- 4** Holding down the JOG/SHUTTLE button, turn the JOG/SHUTTLE dial to change the setting to 25, then release the JOG/SHUTTLE button.

The displays change as shown below.

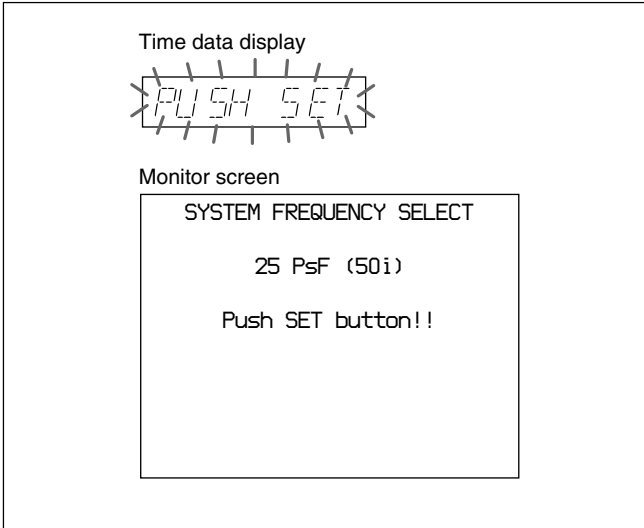

To cancel switching of the system frequency

Holding down the SHIFT button, press the SET/MENU button the required number of times to exit from the menu.

- 5** Press the SET/MENU button.

The displays change as shown below.

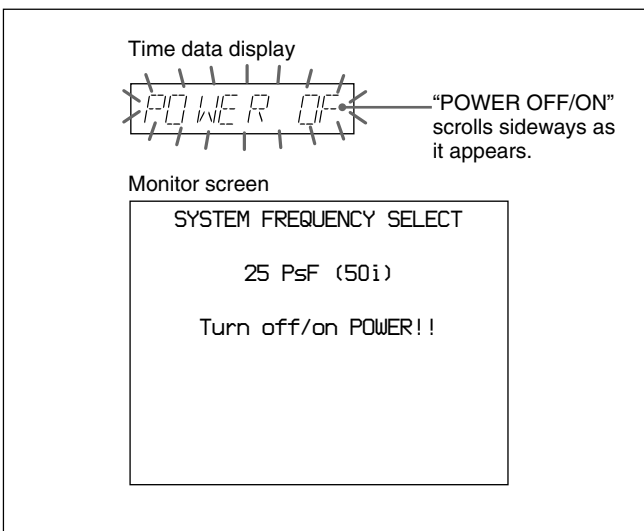

- 6** Turn the POWER switch off momentarily, then turn it on again.

This switches from the 29.97 to the 25 system; the 29.97 indicator goes off, and the 25 indicator lights.

The menu settings disappear from the time data display, and it returns to the normal indicators.

Menu bank operations (menu items B01 to B12)

This unit allows two different complete sets of menu settings to be saved in what are termed "menu banks," numbered 1 and 2. Saved sets of menu settings are recalled for use as required.

To jump to menu item B01 or H01

The unit recalls any required menu items when you turn the JOG/SHUTTLE dial after pressing the SET/MENU button while holding down the SHIFT button. Press the SET/MENU button while holding down the SHIFT button, then press the CTL/TC/UB button. Every time you press the CTL/TC/UB button, menu item H01 or B01 is recalled alternately.

Saving the current active menu settings

Set menu item SAVE BANK 1, basic menu item B11, or SAVE BANK 2, basic menu item B12, to ON, depending on which of the menu banks you wish to use to save the setting, then press the SET/MENU button.

Recalling settings from a menu bank

Set menu item RECALL BANK 1, basic menu item B01, or RECALL BANK 2, basic menu item B02, to ON, depending on which of the menu banks you wish to recall settings from, then press the SET/MENU button.

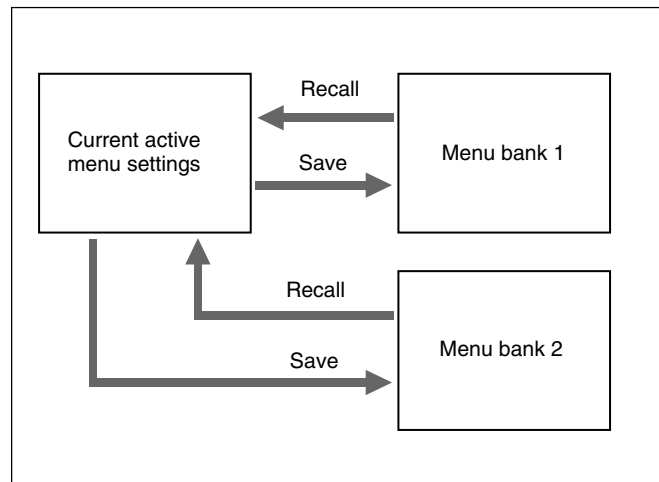

5-2 Menu Operations

Extended menu operations

You can control the extended menu in the same way as that described in the previous pages (Menu Operations).

For details of menu operation, see “5-2 Menu Operations” on page 5-2.

Note

To access the extended menu, it is required to set MENU GRADE, basic menu item 099, to “ENHAN.”

5-3 Basic Menu

Items in the basic menu

The basic menu contains the following items.
In the “Settings” column of the table, the factory

default settings are indicated by an enclosing box.

Item number	Item name	Settings								
002 ^{a)}	CHARACTER H-POSITION	Adjusts the horizontal screen position of the character information output from the VIDEO OUTPUT connectors for superimposed display on the monitor. 0 ... 4 ... 8 : The value 0 is for the far left of the screen and 8 for the far right. Increasing the value moves the position of the characters to the right.								
003 ^{a), b)}	CHARACTER V-POSITION	Adjusts the vertical screen position of the first line of the character information output from the VIDEO OUTPUT connectors for superimposed display on the monitor. 0 ... 13 ... 16 (29.97/23.98PD system (J-H3 only)) / 0 ... 14 ... 17 (25/24 (J-H3 only) / 23.98 system (J-H3 only)) : The value 0 is for the top of the screen and increasing the value lowers the position of the characters.								
005	DISPLAY INFORMATION SELECT	Determines the kind of character information to be output from the VIDEO OUTPUT connectors. OFF : Displays no character information. T&STA : Time data display information and the unit's status T&UB : Time data display information and the user bits T&CTL : Time data display information and CTL T&T : Time data display information and time code (LTC or VITC) TIME : Time data display information only When the system frequency is set to 23.98PD, 29.97-frame time code and 23.98-frame time code are displayed in two rows as shown below (J-H3 only). <table border="1" style="margin: 10px auto; border-collapse: collapse;"> <tr> <td style="padding: 2px;">PDT</td> <td style="padding: 2px;">XX:XX:XX:XX</td> <td style="padding: 2px;">—</td> <td style="padding: 2px;">29.97-frame time code</td> </tr> <tr> <td style="padding: 2px;">ORG</td> <td style="padding: 2px;">XX:XX:XX:XX</td> <td style="padding: 2px;">—</td> <td style="padding: 2px;">23.98-frame time code</td> </tr> </table> If there is an overlap between the setting of this item and the character information selected by the setting of the control panel, output of the overlapped information is automatically avoided. For example, if CTL is selected on the control panel and this menu item setting is T&CTL, CTL and LTC will be output.	PDT	XX:XX:XX:XX	—	29.97-frame time code	ORG	XX:XX:XX:XX	—	23.98-frame time code
PDT	XX:XX:XX:XX	—	29.97-frame time code							
ORG	XX:XX:XX:XX	—	23.98-frame time code							
007	TAPE TIMER DISPLAY	Determines whether to display the CTL counter in 12-hour mode or 24-hour mode. + -12H : 12-hour mode 24H : 24-hour mode								
009 ^{a)}	CHARACTER TYPE	Determines the type of characters, such as time code, output from the VIDEO OUTPUT connectors for superimposed display on the monitor. WHITE : White letters on a black background BLACK : Black letters on a white background W/OUT : White letters with black outlines B/OUT : Black letters with white outlines								
012	CONDITION DISPLAY ON VIDEO MONITOR	Determines whether or not to display the channel status in addition to the characters being superimposed. DIS : Disables display. ENA : Enables display. Displayed channel status The channel statuses are displayed under the timer or status display line. e.g. V — A — The letters that follow “V” indicate the status of the video channels of the rotation head. The letters that follow “A” indicate the status of the audio channels of the rotation head. Character patterns —: Good condition *: Acceptable condition ■: Bad condition								

a) When setting items 002, 003 and 009, watch the monitor screen, and adjust to the required state.

b) When displaying time code values, there is a slight time delay. Therefore, when creating a tape for off-line editing, the information inserted in the upper half of the screen may be delayed by one frame.

5-3 Basic Menu

Item number	Item name	Settings
013	SYSTEM FREQUENCY SELECT	<p>Specifies whether to enable switching the system frequencies.</p> <p>OFF: Do not enable system switching. ON: Enable system switching.</p> <p>You can switch the system frequencies of this unit between 29.97, 25, 24 (J-H3 only), 23.98 (J-H3 only) and 23.98PD (J-H3 only).</p> <p><i>For information on how to switch the system or other details, see "Switching system frequency (menu item 013)" on page 5-4.</i></p>
020	DROP-FRAME MODE SELECT (J-H1:29.97 system only) (J-H3: 29.97/23.98PD system only)	<p>Determines the drop-frame mode of the CTL counter.</p> <p>DF: Drop-frame mode NDF: Non-drop-frame mode</p> <p>Note When the unit operates in the 23.98PD system, the setting of this item determines the advancement mode (DF/NDF) of the output time code.</p>
022	PF2 KEY SELECT	<p>Determines the function assigned to the PF2 button.</p> <p>REM: Displays the remaining tape time in minutes. RUN: Displays the total number of times that the tape has been running up until that time.</p>
024	MENU CHARACTER TYPE	<p>Selects the type of characters to superimpose on the video signal (overlaid display) output from the VIDEO OUTPUT connectors.</p> <p>WHITE: White letters on a black background BLACK: Black letters on a white background W/OUT: White letters with black outlines B/OUT: Black letters with white outlines</p>
026	AUDIO MONITOR MODE	<p>Select a mode of AUDIO MONITOR.</p> <p>MONO: Monaural STEREO: Stereo + mix All: Monaural + stereo + mix</p>
027	SD CHARACTER (J-H3: 29.97/25/23.98PD system only)	<p>Select whether or not to superimpose the type of characters on the video signal (overlap display) output from the SD (D CONV.) connectors.</p> <p>Setting for the J-H1 OFF: Does not superimpose. ON: Superimposes.</p> <p>Setting for the J-H3 OFF: Does not superimpose on any of the SD output. COMPOSITE: Superimposes on the COMPOSITE (SUPER) connector output only. SDI: Superimposes on the SDI (SUPER) connector output only. ALL: Superimposes on all the SD output.</p>
028	HD CHARACTER	<p>Selects whether or not to superimpose characters on the video signal (overlap display) output from the HD connectors.</p> <p>Setting for the J-H1 OFF: Does not superimpose. ON: Superimposes.</p> <p>Setting for the J-H3 OFF: Does not superimpose on any of the HD output. ANALOG: Superimposes on the COMPONENT/D3/MONITOR connectors output only. SDI: Superimposes on the HD SDI (SUPER) connector output only. ALL: Superimposes on all the HD output.</p>
030	I.LINK CHARACTER (available only with the HKJ-101 i.LINK Interface Board) (J-H3: 29.97/25/23.98PD system only)	<p>Selects whether or not to superimpose characters on the video signal (overlap display) output from the iDV connector.</p> <p>OFF: Does not superimpose. ON: Superimposes.</p>

Item number	Item name	Settings
099	MENU GRADE	Determines the menus that can be changed. BASIC : Basic menu ENHAN : Basic menu + Extended menu
B01	RECALL BANK 1	Set to ON to recall menu settings from menu bank 1.
B02	RECALL BANK 2	Set to ON to recall menu settings from menu bank 2.
B11	SAVE BANK 1	Set to ON to save current menu settings to menu bank 1.
B12	SAVE BANK 2	Set to ON to save current menu settings to menu bank 2.
B20	RESET SETUP	Set to ON to reset current menu settings to factory default values.

5-4 Extended Menu

Items in the extended menu

The extended menu contains the following items. default settings are indicated by an enclosing box. In the “Settings” column of the table, the factory

Item number	Item name	Settings
101	SELECTION FOR JOG/SHUTTLE DIAL ENABLE	Selects how the unit enters the jog/shuttle mode. DIAL : Turning the JOG/SHUTTLE dial puts the unit in the jog/shuttle mode. KEY : Pressing the JOG/SHUTTLE button puts the unit in the jog/shuttle mode.
104	AUDIO MUTING TIME	Selects the length of time for which audio muting occurs when the unit switches to playback either from stopped or from still playback in the jog/shuttle mode. OFF : Set the audio muting time to zero (i.e. no muting). LOCK : Mute the audio output signal until the servo lock functions.
105	REFERENCE SYSTEM ALARM (J-H3 only)	Selects whether or not to display an alarm when the reference video signal is not input from outside or the frequency of the reference video signal which is being input does not match with the system frequency of this unit. OFF : Does not display an alarm. ON : Displays an alarm by flashing the STOP button.
114	AUDIO MONITOR OUTPUT LEVEL	Selects whether or not to permit changes in the audio monitor output level from the control panel (which can simultaneously be monitored via the headphones jack) using the volume control knob on the control panel. VAR : Output level changes permitted. FIXED : Output level changes not permitted.
125	AUTO REWIND	Selects whether or not to rewind the tape automatically when playback reaches the end of a tape. DIS : Do not rewind automatically. ENA : Rewind automatically.
130	TIMER DISPLAY DIMMER CONTROL	Sets the brightness of the time data/menu display. 0 to 3 : The brightness can be set within this range. 3 is the brightest and 0 is the darkest.
137	TRACKING CONTROL VIA JOG/SHUTTLE DIAL	Selects the tracking control in the JOG/SHUTTLE dial. OFF : Disables tracking control. ON : Enables tracking control by turning the JOG/SHUTTLE dial in the PLAY mode.
140	AREA MARKER (J-H3: 29.97/25/23.98PD system only)	Selects whether or not to display the output area of the SD output down-converted to HD output. OFF : Do not display. ON : Display.
141	MONITOR FREQUENCY	Selects the output frequency to the computer display. Setting for the J-H1 60HZ 59.94HZ (In 29.97 system)/50HZ (In 25 system) Setting for the J-H3 60HZ 59.94HZ (In 29.97/23PD system)/50HZ (In 25 system) /48HZ (In 24/23.98 system) Note Some computer displays may not synchronize the frequencies if you set the output frequency to 59.94 Hz, 50 Hz, or 48 Hz.
213	WIRELESS REMOTE CONTROL	Selects control mode with the infrared Remote Commander. OFF : Do not operate. ON : Operate.
501	STILL TIMER	Sets the time interval from the tape stop mode to the tape protection mode. In order to protect the video heads and the tape, this unit enters the tape protection mode automatically after a certain amount of time has elapsed since the unit entered the tape stop mode (STOP mode or a still picture in jog/shuttle mode). 0.5S ... 8M ... 30M : Set the value in the range 0.5 seconds to 30 minutes.

Item number	Item name	Settings
601	VITC POSITION SEL-1 (J-H1: No item) (J-H3: 29.97/25/23.98PD system only)	<p>In 29.97/23.98PD system Selects a line to be inserted by the VITC signal (SD output). 12H ... [16H] ... 20H: Select a line from line 12 to line 20.</p> <p>Note You can insert the VITC signals into two places. When you insert the signals into those two places, set VITC POSITION SEL-1, extended menu item 601, and VITC POSITION SEL-2, extended menu item 602, beforehand.</p> <p>In 25 system Selects a line to be inserted by the VITC signal (SD output). 9H ... [19H] ... 22H: Select a line from line 9 to line 22.</p> <p>Note You can insert the VITC signals into two places. When you insert those signals into two places, set VITC POSITION SEL-1, extended menu item 601, and VITC POSITION SEL-2, extended menu item 602, beforehand.</p>
602	VITC POSITION SEL-2 (J-H1: No item) (J-H3: 29.97/25/23.98PD system only)	<p>In 29.97/23.98PD system Selects a line to be inserted by the VITC signal (SD output). 12H ... [18H] ... 20H: Select a line from line 12 to line 20.</p> <p>Note You can insert the VITC signals into two places. When you insert the signals into those two places, set VITC POSITION SEL-1, extended menu item 601, and VITC POSITION SEL-2, extended menu item 602, beforehand.</p> <p>In 25 system Selects a line to be inserted by the VITC signal (SD output). 9H ... [21H] ... 22H: Select a line from line 9 to line 22.</p> <p>Note You can insert the VITC signals into two places. When you insert those signals into two places, set VITC POSITION SEL-1, extended menu item 601, and VITC POSITION SEL-2, extended menu item 602, beforehand.</p>
619	VITC (J-H1: No item) (J-H3: 29.97/25/23.98PD system only)	<p>Selects whether or not to insert the VITC signal into the output signals of the SD (D CONV.) connectors.</p> <p>ON: Insert. OFF: Do not insert.</p>
620	TC CONVERSION AT 24F (25 system only)	<p>Selects whether or not to convert a 24-frame time code into a 25-frame time code when you play back a tape in 25-frame mode (off-speed playback), which was originally recorded in 24-frame mode with the system frequency set to 25.</p> <p>OFF: Do not convert time code. ON: Convert time code.</p>
621	STARTING TC SELECT	Selects the time code standard before converting 24-frame time code into 25-frame time code.
623	24F TC A-FRAME SELECT (J-H1: No item) (J-H3: 23.98PD system only)	<p>Sets a reference value for the playback time code (the time code to be designated as A-FRAME) when 2-3 pulldown playback is performed.</p> <p>Sets the reference value for the output time code (the time code to be designated as A-FRAME) using 30F TC A-FRAME SELECT, extended menu item 624.</p> <p>Using the difference between the value set in this item and the value set in extended menu item 624, converts 23.98-frame time code into 29.97-frame time code and outputs it.</p>
624	30F TC A-FRAME SELECT (J-H1: No item) (J-H3: 23.98PD system only)	<p>Sets a reference value for the output time code (the time code to be designated as A-FRAME) when 2-3 pulldown playback is performed.</p> <p>Sets the reference value for the playback time code (the time code to be designated as A-FRAME) using 24F TC A-FRAME SELECT, extended menu item 623.</p> <p>Using the difference between the value set in this item and the value set in extended menu item 623, converts 23.98-frame time code into 29.97-frame time code and outputs it.</p>

5-4 Extended Menu

Item number	Item name	Settings
710	INTERNAL VIDEO SIGNAL GENERATOR	Selects the test signal to be output from the VTR's internal test signal generator. OFF : No test signal is generated. (The VTR operates normally.) CB : 100% color bar signal
713	VIDEO SETUP REFERENCE LEVEL (J-H1: 29.97 system only) (J-H3: 29.97/23.98PD system only)	Sets the setup amount to be added to the composite output signal. 0% 7.5%
718	SETUP LEVEL (SD) (J-H1: No item) (J-H3: 29.97/25/23.98PD system only)	Adjusts the setup level of the SD video signal output from the SD (D CONV.) connectors. 0 ... 40H ... 7FH
734	MASTER LEVEL (SD) (J-H1: No item) (J-H3: 29.97/25/23.98PD system only)	Adjusts the levels of the components of the SD video signal output from the SD (D CONV.) connectors. Y, Pb, and Pr change in same value. 0 ... 1000 ... 1400
735	Y LEVEL (SD) (J-H1: No item) (J-H3: 29.97/25/23.98PD system only)	Adjusts the Y level of the SD video signal output from the SD (D CONV.) connectors. 0 ... 1000 ... 1400
736	PB LEVEL (SD) (J-H1: No item) (J-H3: 29.97/25/23.98PD system only)	Adjusts the Pb level of the SD video signal output from the SD (D CONV.) connectors. 0 ... 1000 ... 1400
737	PR LEVEL (SD) (J-H1: No item) (J-H3: 29.97/25/23.98PD system only)	Adjusts the Pr level of the SD video signal output from the SD (D CONV.) connectors. 0 ... 1000 ... 1400
740	MASTER LEVEL (HD) (J-H1: No item) (J-H3: 29.97/25/23.98PD system only)	Adjusts the levels of the components of the HD video signal output from the HD connectors. Y, Pb, and Pr change in same value. 0 ... 1000 ... 1400
741	Y LEVEL (HD) (J-H1: No item) (J-H3: 29.97/25/23.98PD system only)	Adjusts the Y level of the HD video signal output from the HD connectors. 0 ... 1000 ... 1400
742	PB LEVEL (HD) (J-H1: No item) (J-H3: 29.97/25/23.98PD system only)	Adjusts the Pb level of the HD video signal output from the HD connectors. 0 ... 1000 ... 1400
743	PR LEVEL (HD) (J-H1: No item) (J-H3: 29.97/25/23.98PD system only)	Adjusts the Pr level of the HD video signal output from the HD connectors. 0 ... 1000 ... 1400
745	SET UP LEVEL (HD) (J-H1: No item) (J-H3: 29.97/25/23.98PD system only)	Adjusts the setup level of the HD video signal output from the HD connectors. 0 ... 110H ... 220H
802	DIGITAL AUDIO MUTE IN SHUTTLE MODE	Sets the digital audio muting conditions during shuttle playback. OFF : Not muted. CUEUP : Muted during cue-up or preroll operations. FULL : Muted in shuttle mode. SLOW : Muted at ± 0.2 times or slower.
808	INTERNAL AUDIO SIGNAL GENERATOR	Selects the operation of the internal audio test signal generator. OFF : No operation. 1KHZ : At 1 kHz, -20 dB FS sine wave is supplied to all audio input channels.

Item number	Item name	Settings
831	I.LINK AUDIO OUTPUT SELECT (available only with the HKJ-101 i.LINK Interface Board) (J-H3: 29.97/25/23.98PD system only)	Selects audio channels output from the i.LINK DV connector. CH1/2 : Outputs audio signals recorded in CH-1/2. CH3/4 : Outputs audio signals recorded in CH-3/4. 4CH : Outputs audio signals recorded in CH-1/2/3/4.
901	VIDEO OUTPUT DATA (J-H1: No item) (J-H3: 29.97/25/23.98PD system only)	Set the number of bits of the signal output from the SD SDI connector. 10 BIT 8 BIT
921	ASPECT FLAG (DC) (J-H1: 29.97 system only) (J-H3: 29.97/23.98PD system only)	Selects whether or not to attach a 16:9/Squeeze identification signal regulated by ARIB TR-B17 on SD output down-converted while an HDCAM tape is playing. OFF : Does not attach a 16:9/Squeeze identification signal on SD output down-converted from HD. ON : Attaches a 16:9/Squeeze identification signal on the SD output down-converted from HD in Squeeze mode.
930	CONVERTER MODE (DC) (J-H3: 29.97/25/23.98PD system only)	Selects mode while down-converting. EDGE-CROP : Selects EDGE-CROP MODE. LETTER BOX : Selects LETTER BOX MODE. SQUEEZE : Selects SQUEEZE MODE.
931	LETTER BOX MODE (DC) (J-H3: 29.97/25/23.98PD system only)	When LETTER BOX is selected in CONVERTER MODE (DC), extended menu item 930, selects the aspect ratio of the down-convert output. 16:9 : Specifies aspect ratio 16:9 for HD-SD converter output. 14:9 : Specifies aspect ratio 14:9 for HD-SD converter output. 13:9 : Specifies aspect ratio 13:9 for HD-SD converter output.
932	H CROP POSITION (DC) (J-H3: 29.97/25/23.98PD system only)	Adjusts H CROP (horizontal direction of the extracted portion of the image using EDGE-CROP MODE) of the down-converted output while EDGE-CROP is selected in CONVERTER MODE (DC), extended menu item 930. -120 ... 0 ... 120
934	CROSS COLOR (DC) (J-H3: 29.97/25/23.98PD system only)	Adjusts CROSS COLOR of the Down Converter. 0 ... 8 ... 15
935	DETAIL GAIN (DC) (J-H3: 29.97/25/23.98PD system only)	Adjusts the image enhancer of the Down Converter. Adjusts the sharpness of the contour adjustment. 0 ... 20H ... 7FH
936	LIMITER (DC) (J-H3: 29.97/25/23.98PD system only)	Adjusts the image enhancer of the Down Converter. Adjusts the maximum level of the detail that will be added to enhance the source signal. 0 ... 20H ... 3FH
937	CRISP THRESHOLD (DC) (J-H3: 29.97/25/23.98PD system only)	Adjusts the image enhancer of the Down Converter. Sets the amplitude level that a small amplitude signal does not enhance. 0 to 15
938	LEVEL DEPEND THRESHOLD (DC) (J-H3: 29.97/25/23.98PD system only)	Adjusts the image enhancer of the Down Converter. Adjusts the range of brightness of the contour adjustment. 0 ... 8 ... 15
939	H.DETAIL FREQUENCY (DC) (J-H3: 29.97/25/23.98PD system only)	Adjusts the image enhancer of the Down Converter. Sets a center frequency of the contour adjustment. 2.6MHZ ... 3.4MHZ ... 3.9MHZ ... 4.6MHZ
940	H/V RATIO (DC) (J-H3: 29.97/25/23.98PD system only)	Adjusts the image enhancer of the Down Converter. Sets the direction ratio (vertically and horizontally) of the contour adjustment. 0 ... 3 ... 7

5-4 Extended Menu

Item number	Item name	Settings
941	GAMMA LEVEL (DC) (J-H3: 29.97/25/23.98PD system only)	Adjusts the image enhancer of the Down Converter. Adjusts the angle of the compensation curve. 0 ... 80H ... 100H
942	V FILTER SELECT (DC) (J-H3: 29.97/25/23.98PD system only)	Specifies perpendicular interpolation filtering factor for the down-converted output. A bigger number indicates higher perpendicular resolution. 1 to 3
943	CROSS COLOR CRISP (DC) (J-H3: 29.97/25/23.98PD system only)	Sets the crisp level of the cross color for the down-converted output. 0 ... 4 ... 7

Maintenance and Inspection

6-1 Removing a Cassette When Tape Slack Occurs

If tape slack occurs in the unit, it is necessary to remove the top and bottom plates. This job should always be entrusted to a technician who has undergone service training.

6-2 Head Cleaning

To clean the video heads and audio heads, always use the special-purpose Sony BCT-HD12CL cleaning cassette.

Follow the instructions with the cleaning cassette carefully, as inappropriate use of the cleaning cassette can damage the heads.

To carry out head cleaning, use the following procedure.

- 1** Insert the cleaning cassette.

Head cleaning starts.
- 2** After an automatic head cleaning operation which lasts for about 3 seconds, the cleaning cassette is automatically ejected.

6-3 Moisture Condensation

When the unit is suddenly moved from a cold to a warm location, or used in a very humid place, moisture from the air can condense on the head-drum. This is called moisture condensation. If the tape is run in this state, it can adhere to the drum. To prevent such a condition from occurring, the unit is provided with a moisture condensation detecting function.

If moisture condenses on the head-drum while the unit is in use, the ALARM indicator flashes and “E10-0000” is displayed in the time data display.

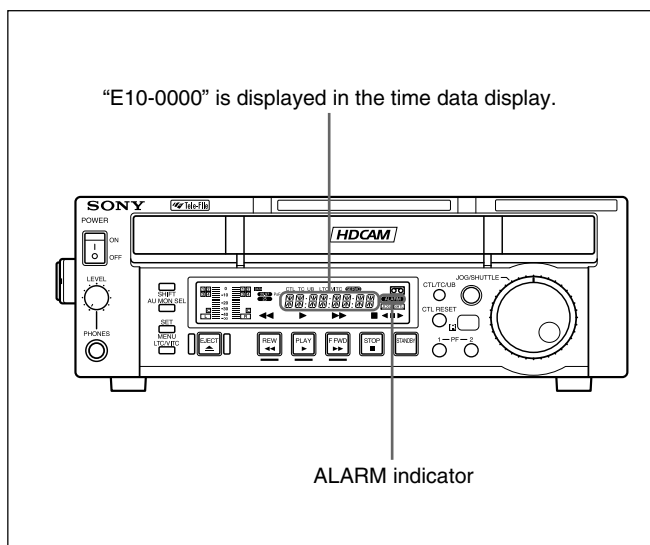

If this happens, the drum and capstan motors stop and the cassette is automatically ejected. Then, the drum starts to rotate again to dry its surface. In this state, the unit is not operable. When the moisture has evaporated, the ALARM indicator goes off and the “E10-0000” message disappears.

If the ALARM indicator lights and “E10-0000” appears immediately after powering the unit on

Leave the unit powered on and wait until the ALARM indicator goes off and the error message disappears. Do not insert a cassette while the indicator is lit. Use the unit when the indicator goes off and the error message disappears.

If you move the unit from a cold to a warm location

Leave the unit powered off for about 10 minutes, in order to give the unit time to detect moisture condensation.

6-4 Error Messages

CODE	MESSAGE	ERRORS
01	REEL TROUBLE	Detected "tape slack" during threading or unthreading.
02	REEL TROUBLE	Detected "tape slack" or "tape break" during search, fast-forward, or rewind.
03	REEL TROUBLE	Detected "tape slack," "tape break," or "reel rock in the S-side or T-side" during playback.
04	REEL TROUBLE	Detected abnormal tape speed during fast-forward or rewind.
05	REEL TROUBLE	Detected abnormal operation on the S-side or T-side reel during cassette compartment operation.
06	TAPE TENSION	Detected excessive tape tension during playback.
07	CAPSTAN TROUBLE	Detected abnormal operation of capstan motor.
08	DRUM TROUBLE	Detected abnormal operation of drum motor.
09	TH/UNTH MOTOR	Detected abnormal operation during threading or unthreading.
0A	THREADING	Detected incorrect ending of process for tape top when threading.
10	HUMID	Detected moisture condensation.
11	TAPE T/E SENSOR	Detected tape top and tape end simultaneously.
12	TAPE TOP SENSOR	Detected abnormal condition in tape top sensor.
13	TAPE END SENSOR	Detected abnormal condition in tape end sensor.
14 ¹⁾	FAN MOTOR	Detected abnormal operation in the cooling fan motor.
20	CASS COMP MOTOR	Detected abnormal condition during cassette compartment operation.
92	INTERNAL I/F ERROR	Detected abnormal condition in communication between SYS CPU and other CPU/MPUs.
96	SY NV-RAM ERROR	Detected abnormal operation in a system control device, NV-RAM.
97	SV NV-RAM ERROR	Detected abnormal operation in a servo system device, NV-RAM.
98	RF NV-RAM ERROR	Detected abnormal operation in an RF system device, NV-RAM.

1) J-H3 only

6-5 Digital Hours Meter

The digital hours meter can display nine items of information, in corresponding display modes, about the operational history of the unit. Use it as a guide in scheduling periodic maintenance.

Display modes of the digital hours meter

The digital hours meter has the following nine modes.

H01: OPERATION mode

Displays the total number of hours the unit has been powered on in units of 1 hour.

H02: DRUM RUNNING mode

Displays the total number of hours the drum has run with tape threaded in units of 1 hour.

H03: TAPE RUNNING mode

Displays the total number of hours the unit has been in fast forward, rewind, playback, or search (except for stop and still) mode in units of 1 hour.

H04: THREADING mode

Displays the total number of times the tape has been threaded/unthreaded.

H06: REEL SHIFT mode

Displays the total number of times that the reel has been shifted according to the size of the cassette (L cassette or S cassette) in use.

H12: DRUM RUNNING mode (resettable)

Same as H02 except that the count is resettable. By resetting the cumulative drum running time after changing the rotating head drum, this count can be used as a guide in determining when to replace the drum.

H13: TAPE RUNNING mode (resettable)

Same as H03 except that the count is resettable. This count can be used as a guide in determining when to replace such components as fixed heads and pinch rollers.

H14: THREADING mode (resettable)

Same as H04 except that the count is resettable. This can be used as a guide in determining when to replace, for example, the threading motor.

H16: REEL SHIFT mode (resettable)

Same as H06 except that the count is resettable.

Displaying the digital hours meter

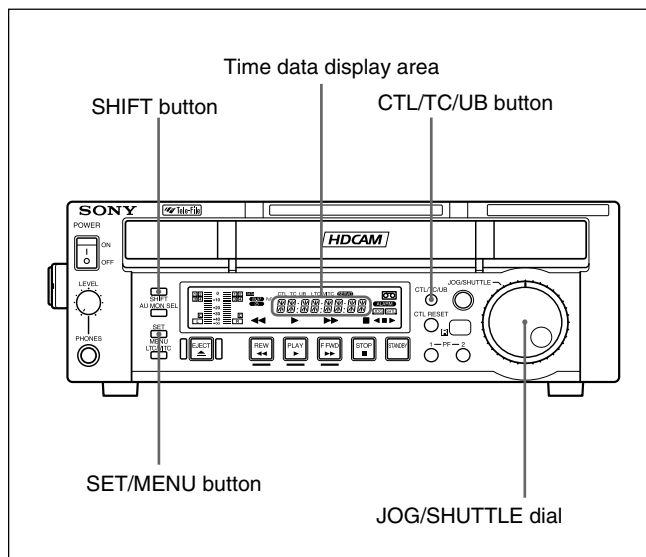

To display the digital hours meter

Press the SET/MENU button while holding down the SHIFT button, then turn the JOG/SHUTTLE dial to display the required item in the time data display.

To jump to H01

Press the SET/MENU button while holding down the SHIFT button, then press the CTL/TC/UB button. Every time you press the CTL/TC/UB button, menu item H01 or B01 is recalled alternately.

To exit from the digital hours meter

Press the SET/MENU button.

Appendix

Specifications

General

Power requirements	100 to 240 VAC, 50/60 Hz
Power consumption	J-H3: 70 W J-H1: 50 W
Rated current	J-H3: 0.7 A J-H1: 0.5 A
Peak inrush current	(1) Power ON, current probe method: 35 A (240 V), 10 A (100 V) (2) Hot switching inrush current, measured in accordance with European standard EN55103-1: 8 A (230 V)
Operating temperature	5°C to 40°C (41°F to 104°F)
Storage temperature	-20°C to +60°C (-4°F to +140°F)
Humidity	25% to 80%
Mass	J-H3: 8.1 kg (17 lb. 14 oz.) J-H1: 7.5 kg (16 lb. 9 oz.)
Dimensions (w/h/d)	307 × 100 × 397 mm (12 1/8 × 4 × 15 3/4 inches)

Tape transport system

Tape speed	HDCAM: 96.7 mm/s (29.97 Hz) 80.7 mm/s (25 Hz) 77.4 mm/s (24 Hz) (J-H3 only)
Playback time	29.97 Hz: 124 minutes (BCT-124HDL cassette) 25 Hz: 149 minutes (BCT-124HDL cassette) 24 Hz (J-H3 only): 155 minutes (BCT-124HDL cassette)
Fast forward/rewind time	Approx. 6 minutes with BCT-124HDL cassette
Search speed	Shuttle mode Still to ±21 times normal playback speed Jog mode Still to ±1 times normal playback speed
Servo lock time (from standby)	1.0 second or less
Load/unload time	7 seconds or less
Recommended tape	HDCAM cassette (S or L) BCT-6HD/12HD/22HD/40HD BCT-34HDL/64HDL/124HDL

Specifications

Digital video system

HD analog response (BNC output)

Output level Y: 700 mV ($\pm 5\%$)
Pb/Pr: ± 350 mV ($\pm 5\%$)
Sync signal: ± 300 mV (added to Y component) ($\pm 5\%$)

Frequency response Y: 0 to 20 MHz +1.0 dB/-3.0 dB
Pb/Pr: 0 to 7 MHz +1.0 dB/-3.0 dB

S/N 56 dB or more

Output impedance

Y, Pb, Pr: 75 Ω ($\pm 5\%$)

Y/C Delay Y, Pb/Pr: ± 15 nS or less

SD composite response (Down-converter output)

Output level Y: 59.94i; 714 mV ($\pm 5\%$)
50i; 700 mV ($\pm 5\%$)
Sync: 59.94i; 286 mV ($\pm 5\%$)
50i; 300 mV ($\pm 5\%$)
Burst: 59.94i; 286 mV ($\pm 5\%$)
50i; 300 mV ($\pm 5\%$)

Frequency response 0.5 to 5.75 MHz +0.5 dB/-3.0 dB

S/N 53.5 dB or more

K-Factor 1.0% or less

Y/C Delay 20 nS or less

HD analog response (VGA output)

Output level R: 700 mV ($\pm 5\%$)
G: 700 mV ($\pm 5\%$)
B: 700 mV ($\pm 5\%$)

Resolution XGA

Refresh/rate J-H3: 60 Hz/50 Hz/48 Hz
J-H1: 60 Hz/50 Hz

H-Frequency J-H3: 48.4 kHz/40.3 kHz/38.7 kHz
J-H1: 48.4 kHz/40.3 kHz

HD analog response (D connector; complies with EIAJ CP-4120)

Output level Y: 700 mV ($\pm 5\%$)
Pb/Pr: ± 350 mV ($\pm 5\%$)
Sync signal: ± 300 mV (added to Y component) ($\pm 5\%$)

Frequency response Y: 0 to 20 MHz +1.0 dB/-3.0 dB
Pb/Pr: 0 to 7 MHz +1.0 dB/-3.0 dB

S/N 56 dB or more

Output impedance Y, Pb, Pr: 75 Ω ($\pm 5\%$)

Y/C Delay Y, Pb/Pr: ± 15 nS or less

Analog audio system

Analog audio response

Output level XLR: +4 ± 0.5 dBm, -20 dBFS,
600 Ω terminated
PIN: -10 ± 0.5 dBu, -20 dBFS,
47 k Ω terminated

Frequency response 20 Hz to 20 kHz +1.0 dB/-1.5 dB,
Emphasis OFF Ref: 1 kHz

Dynamic range 85 dB or more, Emphasis ON at
1 kHz

Distortion 0.1% or less, Emphasis ON at
1 kHz/-20 dBFS

Wow and flutter Below measurable level

Cue audio response

Frequency response 100 Hz to 10 kHz ± 3.0 dB,
Ref: 1 kHz/-10 dB

S/N 43.5 dB or more
DIN AUDIO RMS, 3% distortion

Distortion (THD) 2% or less, at 1 kHz/0 VU

Wow and flutter 0.18% or less, JIS weighted

Output connectors

HDSDI OUTPUT (J-H3 only)

BNC (1), Including character
superimposition
Serial digital (1.485 Gbits/second)
SMPTE 292M

SDI OUTPUT (J-H3 only)

BNC (1), Including character
superimposition
Serial digital (270 Mbits/second)
SMPTE 259M

i.LINK (available only when an HKJ-101

i.LINK Interface Board is installed)

IEEE1394 (1), 6-pin

COMPOSITE VIDEO OUTPUT

BNC (1), Phono jack (1)
Including character
superimposition
1.0 Vp-p, 75 Ω , Sync negative

ANALOG HD COMPONENT VIDEO OUTPUT

BNC (3), Including character
superimposition
Y: 1.0 Vp-p, Sync negative, 75 Ω ,
unbalanced
Pb/Pr: 0.7 Vp-p, 75 Ω , unbalanced

D3 OUTPUT	D connector (1), 14-pin Y: 1.0 Vp-p, Sync negative, 75 Ω , unbalanced Pb/Pr: 0.7 Vp-p, 75 Ω , unbalanced Including character superimposition
COMPUTER DISPLAY OUTPUT	D-sub 15-pin, female (1) R/G/B: 0.7 Vp-p, 75 Ω , unbalanced
AUDIO MONITOR OUTPUT (L/R)	Phono jack (2) XLR 3-pin, male (2) +4 dBm at 600 Ω load, low impedance, balanced
PHONES	JM-60 stereo phone jack $-\infty$ to -12 dBu at 8 Ω load, unbalanced
TIME CODE OUTPUT (J-H3 only)	BNC (1), 1.0 Vp-p, 75 Ω

Remote connector

RS232C	D-sub 9-pin, male, Sony 9-pin Remote Interface
REMOTE IN (9P) (J-H3 only)	D-sub 9-pin, female

Input connectors

EXT SYNC (J-H3 only)	BNC (2), loop through HD: Trilevel SYNC, 0.6 Vp-p, 75 Ω , Sync negative SD: Black burst or Composite Sync (frame locked), 0.3 Vp-p, 75 Ω , Sync negative
----------------------	--

Accessories supplied

Operation Manual (CD-ROM) (1)
 Operation Manual (1)
 Vertical installation stands (2)
 Remote Commander (RM-J1), CR2025 lithium battery included

Optional accessories

- AC power cord:
- For customers in the U.S.A. and Canada
Part No. 1-557-377-11
Plug holder 2-990-242-01
 - For customers in the United Kingdom
Part No. 1-551-631-15
Plug holder 3-613-640-01
 - For customers in European countries other than the United Kingdom
Part No. 1-782-929-11
Plug holder 3-613-640-01
- BCT-HD12CL Cleaning Cassette Tape
 HKJ-101 i.LINK Interface Board

Design and specifications are subject to change without notice.

このマニュアルに記載されている事柄の著作権は当社にあり、説明内容は機器購入者の使用を目的としています。
従って、当社の許可なしに無断で複写したり、説明内容（操作、保守等）と異なる目的で本マニュアルを使用することを禁止します。

The material contained in this manual consists of information that is the property of Sony Corporation and is intended solely for use by the purchasers of the equipment described in this manual.

Sony Corporation expressly prohibits the duplication of any portion of this manual or the use thereof for any purpose other than the operation or maintenance of the equipment described in this manual without the express written permission of Sony Corporation.

Le matériel contenu dans ce manuel consiste en informations qui sont la propriété de Sony Corporation et sont destinées exclusivement à l'usage des acquéreurs de l'équipement décrit dans ce manuel.

Sony Corporation interdit formellement la copie de quelque partie que ce soit de ce manuel ou son emploi pour tout autre but que des opérations ou entretiens de l'équipement à moins d'une permission écrite de Sony Corporation.

Das in dieser Anleitung enthaltene Material besteht aus Informationen, die Eigentum der Sony Corporation sind, und ausschließlich zum Gebrauch durch den Käufer der in dieser Anleitung beschriebenen Ausrüstung bestimmt sind. Die Sony Corporation untersagt ausdrücklich die Vervielfältigung jeglicher Teile dieser Anleitung oder den Gebrauch derselben für irgendeinen anderen Zweck als die Bedienung oder Wartung der in dieser Anleitung beschriebenen Ausrüstung ohne ausdrückliche schriftliche Erlaubnis der Sony Corporation.

J-H1
J-H3 (SY)
3-748-147-02(1)

Sony Corporation
B & P Company
<http://www.sony.net/>

2003.06
© 2003

Free Manuals Download Website

<http://myh66.com>

<http://usermanuals.us>

<http://www.somanuals.com>

<http://www.4manuals.cc>

<http://www.manual-lib.com>

<http://www.404manual.com>

<http://www.luxmanual.com>

<http://aubethermostatmanual.com>

Golf course search by state

<http://golfingnear.com>

Email search by domain

<http://emailbydomain.com>

Auto manuals search

<http://auto.somanuals.com>

TV manuals search

<http://tv.somanuals.com>