

DVD Player/ Video Cassette Recorder

Operating Instructions



Hi-Fi

VIDEO *Plus+*®



SLV-D900G

WARNING

To prevent fire or shock hazard, do not expose the unit to rain or moisture.

To avoid electrical shock, do not open the cabinet. Refer servicing to qualified personnel only. Mains lead must only be changed at a qualified service shop.

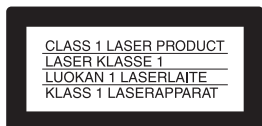

This appliance is classified as a CLASS 1 LASER product. The CLASS 1 LASER PRODUCT MARKING is located on the rear exterior.

CAUTION

The use of optical instruments with this product will increase eye hazard. As the laser beam used in this DVD player/Video Cassette Recorder is harmful to eyes, do not attempt to disassemble the cabinet.

Refer servicing to qualified personnel only.

Notice for customers in the United Kingdom and Republic of Ireland

A moulded plug complying with BS1363 is fitted to this equipment for your safety and convenience.

Should the fuse in the plug supplied need to be replaced, a 5 AMP fuse approved by ASTA or BSI to BS1362, (i.e., marked with ⚡ or ⚡ mark) must be used.

If the plug supplied with this equipment has a detachable fuse cover, be sure to attach the fuse cover after you change the fuse. Never use the plug without the fuse cover. If you should lose the fuse cover, please contact your nearest Sony service station.

Precautions

Safety

- This unit operates on 220 – 240 V AC, 50 Hz. Check that the unit's operating voltage is identical with your local power supply.
- To prevent fire or shock hazard, do not place objects filled with liquids, such as vases, on the apparatus.
- The player is not disconnected from the AC power source (mains) as long as it is connected to the wall outlet, even if the player itself has been turned off.

Installing

- Do not install the unit in an inclined position. It is designed to be operated in a horizontal position only.
- Keep the unit and discs away from equipment with strong magnets, such as microwave ovens, or large loudspeakers.
- Do not place heavy objects on the unit.
- Do not place the unit on surfaces (rugs, blankets, etc.) or near materials (curtains, draperies) that may block the ventilation slots.

VIDEO Plus+ and PlusCode are registered trademarks of Gemstar Development Corporation. The VIDEO Plus+ system is manufactured under license from Gemstar Development Corporation.

Welcome!

Thank you for purchasing this Sony DVD Player/Video Cassette Recorder. Before operating this player, please read this manual thoroughly and retain it for future reference.

Caution

For use of the VCR

Television programmes, films, video tapes and other materials may be copyrighted. Unauthorized recording of such material may be contrary to the provisions of the copyright laws. Also, use of this recorder with cable television transmission may require authorization from the cable television transmitter and/or programme owner.

For use of the DVD player

This product incorporates copyright protection technology that is protected by method claims of certain U.S. patents, other intellectual property rights owned by Macrovision Corporation, and other rights owners. Use of this copyright protection technology must be authorized by Macrovision Corporation, and is intended for home and other limited viewing uses only unless otherwise authorized by Macrovision Corporation. Reverse engineering or disassembly is prohibited.

Table of contents

- 2 WARNING
 - 2 Welcome!
 - 3 Caution
 - 6 About this manual
 - 6 This player can play the following discs
 - 7 Notes about discs
-

Getting Started

- 8 Step 1 : Unpacking
 - 9 Step 2 : Setting up the remote commander
 - 11 Step 3 : Connecting the DVD-VCR
 - 14 Step 4 : Setting up the DVD-VCR with the Auto Set Up function
 - 16 Step 5 : Selecting a language
 - 17 Step 6 : Setting the clock
 - 19 Step 7 : Presetting channels
-

Basic Operations

- 27 Playing discs
- 30 Guide to the on-screen display
- 31 Playing a tape
- 34 Recording TV programmes
- 38 Recording TV programmes using the VIDEO Plus+[®] system
- 43 Recording TV programmes using the timer
- 47 Checking/changing/cancelling timer settings

Advanced Hookups

- 49 A/V Receiver hookup
- 51 S-Video hookup

DVD Settings and Adjustments

- 52 Audio Setup
- 55 Screen Setup
- 58 Setting the display or sound track language
- 60 Parental Control (limiting playback by children)

DVD Additional Operations

- 63** Using the DVD's menu
- 65** Zooming into a scene
- 66** Changing the angles
- 67** Displaying the subtitle
- 68** Picture navigation
- 69** Various play mode functions
(Programme play, Random play,
Repeat play)
- 73** Changing the sound
- 74** Virtual surround setting
- 76** Playing an MP3 audio track
- 79** Playing VIDEO CDs with "MENU
ON/OFF" Functions

VCR Additional Operations





- 81** Playing a tape with SQPB function
- 82** Setting the recording duration time
- 84** Recording stereo and bilingual
programs
- 86** Searching using index function
- 88** Adjusting the picture (tracking)
- 90** Changing menu options
- 92** Editing

Additional Information

- 95** General setup information
- 97** Troubleshooting
- 102** Specifications
- 104** Index to parts and controls
- 109** DVD AUDIO/SUBTITLE
LANGUAGE
- 110** Index



About this manual

- The meaning of the icons used in this manual is described below:

Icon	Meaning
	Functions available for DVD VIDEOS or DVD-Rs/DVD-RWs in video mode
	Functions available for VIDEO CDs, Super VCDs or CD-Rs/CD-RWs in video CD format
	Functions available for DATA CDs (CD-ROMs/CD-Rs/CD-RWs containing MP3* audio tracks)
	Functions available for music CDs or CD-Rs/CD-RWs in music CD format
	Functions available for VHS VIDEOS

* MP3 (MPEG 1 Audio Layer 3) is a standard format defined by ISO/MPEG which compresses audio data.

This player can play the following discs

Format of discs	
DVD VIDEO	
VIDEO CD	
Music CD	

The "DVD VIDEO" logo is a trademark.

Region code

Your player has a region code printed on the back of the unit and only will play DVD VIDEO discs (playback only) labelled with identical region codes. This system is used to protect copyrights.

DVDs labelled  will also play on this player.

If you try to play any other DVD, the message "Playback prohibited by area limitations." will appear on the TV screen. Depending on the DVD, no region code indication may be labelled even though playing the DVD is prohibited by area restrictions.



Example of discs that the player cannot play

- The player cannot play the following discs:
- All CD-ROMs (including PHOTO CDs)/CD-Rs/CD-RWs other than those recorded in the following formats:
 - music CD format
 - video CD format
 - MP3 format that conforms to ISO9660* Level 1/Level 2, or its extended format, Joliet
 - Data part of CD-Extras
 - DVD-RWs in VR mode
 - DVD-ROMs
 - DVD Audio discs
 - HD layer on Super Audio CDs
- * A logical format of files and folders on CD-ROMs, defined by ISO (International Standard Organization).

Also, the player cannot play the following discs:

- A DVD with a different region code.
- A disc that has a non-standard shape (e.g., card, heart).
- A disc with paper or stickers on it.
- A disc that has the adhesive of cellophane tape or a sticker still left on it.

Note

Some CD-Rs, CD-RWs, DVD-Rs, or DVD-RWs (in video mode) cannot be played on this player due to the recording quality or physical condition of the disc, or the characteristics of the recording device.

Furthermore, the disc will not play if it has not been correctly finalized. For more information, see the operating instructions for the recording device.

Note that discs created in the Packet Write format cannot be played.

Note on playback operations of DVDs and VIDEO CDs

Some playback operations of DVDs and VIDEO CDs may be intentionally set by software producers. Since this player plays DVDs and VIDEO CDs according to the disc contents the software producers designed, some playback features may not be available. Also, refer to the instructions supplied with the DVDs or VIDEO CDs.

Notes about discs

- To keep the disc clean, handle the disc by its edge. Do not touch the surface.



- Do not expose the disc to direct sunlight or heat sources such as hot air ducts, or leave it in a car parked in direct sunlight as the temperature may rise considerably inside the car.
- After playing, store the disc in its case.
- Clean the disc with a cleaning cloth. Wipe the disc from the center out.



Do not use solvents such as benzine, thinner, commercially available cleaners, or anti-static spray intended for vinyl LPs.

Step 1 : Unpacking

Check that you have received the following items with the DVD-VCR:

- Remote commander

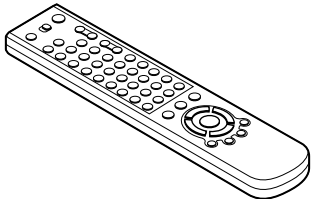

- R6 (Size AA) batteries

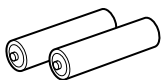

- Aerial cable

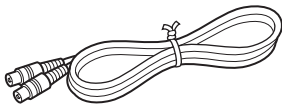

- Audio cord
(pinplug ×2 ↔ pinplug ×2)

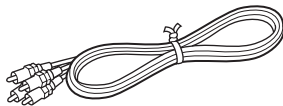

- Video cord
(pinplug ×1 ↔ pinplug ×1)

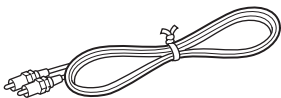

Step 2 : Setting up the remote commander

Inserting the batteries

Insert two size AA (R6) batteries by matching the + and – on the batteries to the diagram inside the battery compartment.

Insert the negative (–) end first, then push in and down until the positive (+) end clicks into position.

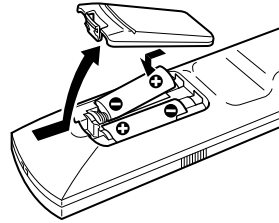

Using the remote commander

You can use this remote commander to operate this DVD-VCR and a Sony TV. Buttons on the remote commander marked with a dot (•) can be used to operate your Sony TV.

If the TV does not have the  symbol near the remote sensor, this remote commander will not operate the TV.

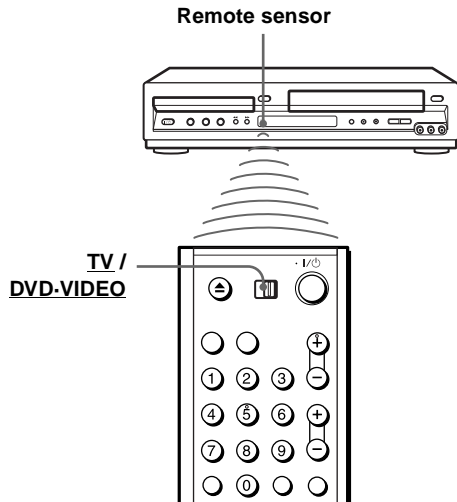

To operate	Set TV / DVD-VIDEO to
the DVD player	<u>DVD-VIDEO</u> , then press SELECT DVD and point at the remote sensor at the DVD-VCR
the VCR	<u>DVD-VIDEO</u> , then press SELECT VIDEO and point at the remote sensor at the DVD-VCR
your TV	<u>TV</u> and point at the remote sensor at your TV

Notes

- With normal use, the batteries should last about three to six months.
- If you do not use the remote commander for an extended period of time, remove the batteries to avoid possible damage from battery leakage.
- Do not use a new battery with an old one.
- Do not use different types of batteries.

continued

Controlling other TVs with the remote commander

The remote commander is preprogrammed to control non-Sony TVs. If your TV is listed in the following table, set the appropriate manufacturer's code number.

- 1 Set **TV / DVD-VIDEO** at the top of the remote commander to **TV**.
- 2 Hold down **I/⏻**, and enter your TV's code number using the number buttons. Then release **I/⏻**.

Now you can use the **I/⏻**, **VOL +/-**, **PROG +/-**, **MUTING***, **TV/VIDEO**, **0-9** and **-/--*** buttons to control your TV. You can also use the buttons marked with a dot (•) to control a Sony TV. To control the DVD-VCR, reset **TV / DVD-VIDEO** to **DVD-VIDEO**.

* for Sony TV only

Code numbers of controllable TVs

If more than one code number is listed, try entering them one at a time until you find the one that works with your TV.

Manufacturer	Code number
Sony	01, 02
Akai	68
Ferguson	52
Grundig	10, 11
Hitachi	24
JVC	33
Loewe	45
Mivar	09, 70
NEC	66
Nokia	15, 16, 69

Manufacturer	Code number
Panasonic	17, 49
Philips	06, 07, 08
Saba	12, 13
Samsung	22, 23
Sanyo	25
Sharp	29
Telefunken	36
Thomson	43
Toshiba	38

Notes

- If you enter a new code number, the code number previously entered will be erased.
- If the TV uses a different remote control system from the one programmed to work with the DVD-VCR, you cannot control your TV with the remote commander.
- When you replace the batteries of the remote commander, the code number may change. Set the appropriate code number every time you replace the batteries.

Step 3 : Connecting the DVD-VCR

Note that “Advanced Hookups” (page 49) explains additional hookup methods that will optimize the picture and sound for a true “hometheater” experience.

If your TV has a Scart (EURO-AV) connector, see page 12.

If your TV does not have a Scart (EURO-AV) connector

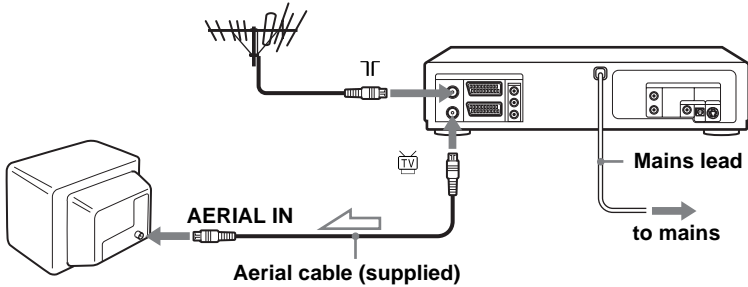

 : Signal flow

1

Disconnect the aerial cable from your TV and connect it to  on the rear panel of the DVD-VCR.

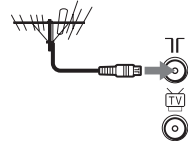

2

Connect  of the DVD-VCR and the aerial input of your TV using the supplied aerial cable.

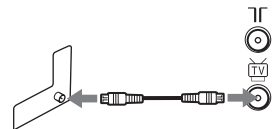

3

Connect the mains lead to the mains.

Note

- When you connect the DVD-VCR and your TV only with an aerial cable, you have to tune your TV to the DVD-VCR (see page 14).

continued

If your TV has a Scart (EURO-AV) connector

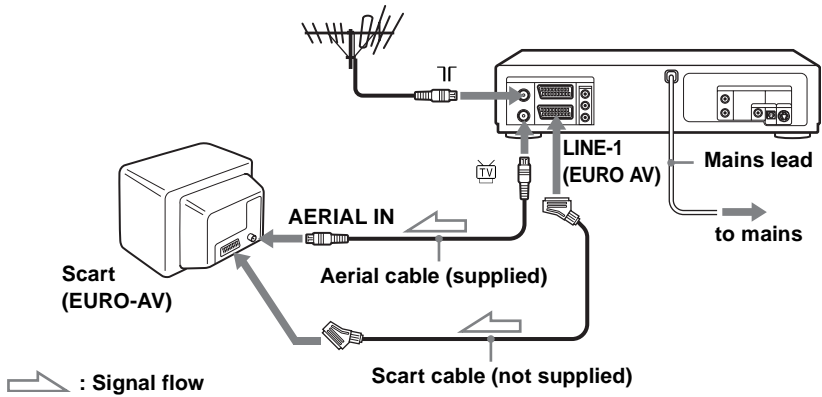

1

Disconnect the aerial cable from your TV and connect it to on the rear panel of the DVD-VCR.

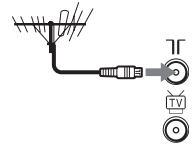

2

Connect of the DVD-VCR and the aerial input of your TV using the supplied aerial cable.

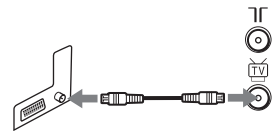

3

Connect LINE-1 (EURO AV) on the DVD-VCR and the Scart (EURO-AV) connector on the TV with the optional Scart cable.

This connection improves picture and sound quality. Whenever you want to watch the DVD-VCR picture, press TV/VIDEO to display the VIDEO indicator in the display window.

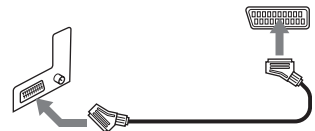

4

Connect the mains lead to the mains.

Additional connections

To a satellite or digital tuner with Line Through

Using the Line Through function, you can watch programmes from a satellite or digital tuner connected to this DVD-VCR on the TV even when the DVD-VCR is turned off. When you turn on the satellite or digital tuner, this DVD-VCR automatically sends the signal from the satellite or digital tuner to the TV without turning itself on.

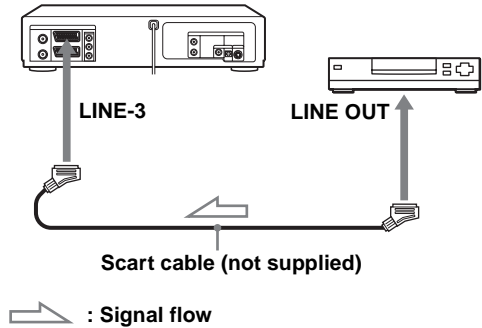

- 1 Connect the satellite or digital tuner to the LINE-3 connector as shown above.
- 2 Turn off the DVD-VCR.
To watch a programme, turn on the satellite or digital tuner and the TV.

Notes

- This function may not work with some types of satellite or digital tuners.
- When the DVD-VCR is turned off, set the TV to the video channel.

Step 4 : Setting up the DVD-VCR with the Auto Set Up function

Before using the DVD-VCR for the first time, set up the DVD-VCR using the Auto Set Up function. With this function, you can set TV channels, guide channels for the VIDEO Plus+ system, and DVD-VCR clock automatically.

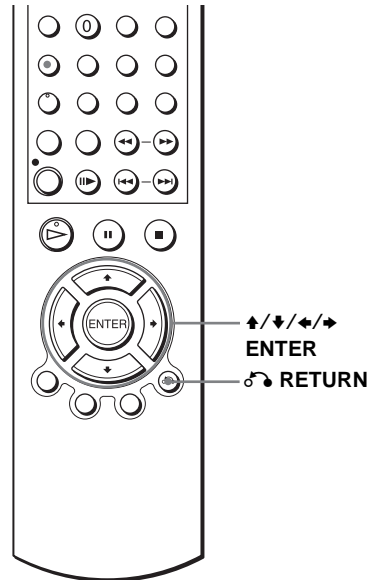

1

Turn on your TV and set it to the video channel.

If your TV does not have a Scart (EURO-AV) connector, tune the TV to channel 21 (the initial RF channel for this DVD-VCR). Refer to your TV manual for TV tuning instructions. If the picture does not appear clearly, see "To change the RF channel" on page 15.

2



Connect the mains lead to the mains. The DVD-VCR automatically turns on and the DVD-VCR starts searching for all of the receivable channels and presets them (in the appropriate order for your local area).

If you want to change the order of the channels or disable unwanted programme positions, see "Changing/disabling programme positions" on page 21.

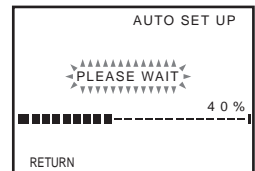

After the search is complete, the current time appears for any stations that transmit a time signal. If the time does not appear, set the clock manually. See "Setting the clock" on page 17.



To cancel the Auto Set Up function

Press  RETURN.





To change the RF channel

If the picture does not appear clearly on the TV, change the RF channel on the DVD-VCR and TV. Select  (INSTALLATION) from the menu, then press  to select VIDEO OUTPUT CH. Select the RF channel by pressing the  buttons. Then, tune the TV to the new RF channel so that a clear picture appears.

Tip

- If you want to change the language for the on-screen display from the one preset in the Auto Set Up function, see page 16.

Notes

- Whenever you operate the Auto Set Up function, some of the settings (VIDEO Plus+, timer, etc.) will be reset. If this happens, you have to set them again.
- Auto preset starts automatically only when you plug in the mains lead for the first time after you purchase the DVD-VCR.
- If you want to use the Auto Set Up function again, press SET UP, then press / to select  (INSTALLATION) and press ENTER. Press  to select AUTO SET UP.
- Auto preset can be performed by pressing  on the DVD-VCR continuously for 5 seconds or more during power off with no tape inserted.

Step 5 : Selecting a language

You can change the on-screen display language.

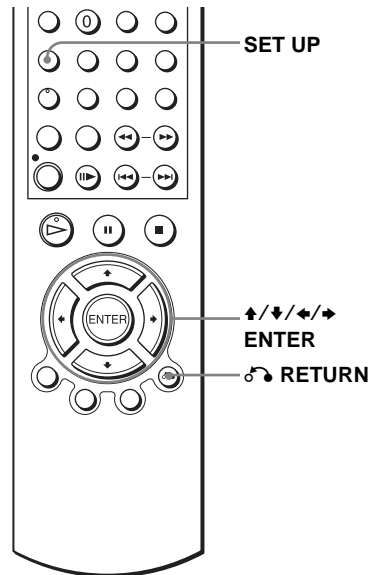

Before you start...

- Turn on the DVD-VCR and your TV.
- Set your TV to the video channel so that the signal from the player appears on the TV screen.
- If the DVD player is in play mode, you cannot display the "SETUP MENU." Stop DVD playback.



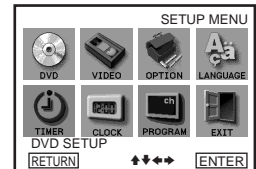

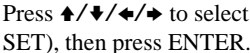
- 1**  Press SET UP.
The "SETUP MENU" appears.

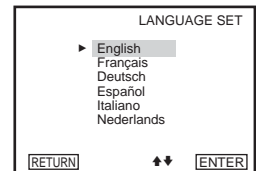

- 2**  Press  to select  (LANGUAGE SET), then press ENTER.
The "LANGUAGE SET" menu appears.

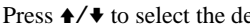

- 3**  Press  to select the desired language, then press ENTER.

- 4**  Press  RETURN to exit the menu.

Step 6 : Setting the clock

You must set the time and date on the DVD-VCR to use the timer features properly.

The Auto Clock Set function works only if a station in your area is broadcasting a time signal.

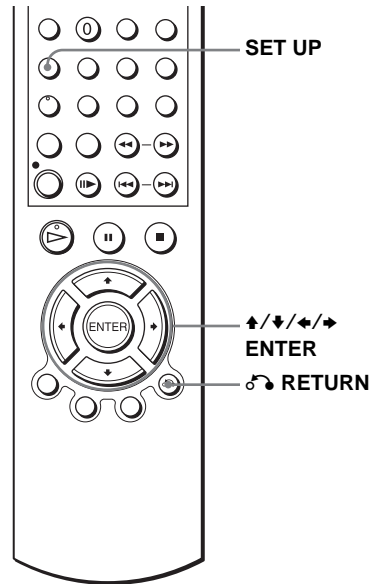

Before you start...

- Turn on the DVD-VCR and your TV.
- Set your TV to the video channel so that the signal from the player appears on the TV screen.
- If the DVD player is in play mode, you cannot display the "SETUP MENU." Stop DVD playback.



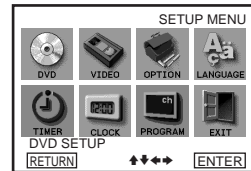

- 1**  Press SET UP.
The "SETUP MENU" appears.

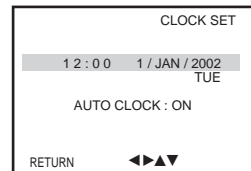

- 2**  Press  to select  (CLOCK SET), then press ENTER.
The "CLOCK SET" menu appears.



- 3**  Press  to set the hour.

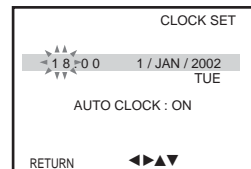

continued

4



Press **▶** to select the minutes and set the minutes by pressing **▲/▼**.

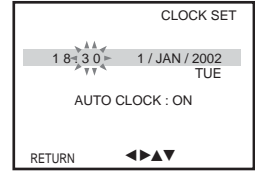

5



Set the day, month, and year in sequence by pressing **▶** to select the item to be set, and press **▲/▼** to select the digits, then press **▶**. The day of the week is set automatically.

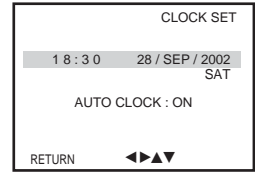

6



Press **▲/▼** to select "ON" for the setting of the Auto Clock Set function. The DVD-VCR automatically sets the clock according to the time signal broadcast between the channels PR 1 to PR 5. If you do not need the Auto Clock Set function, select OFF.

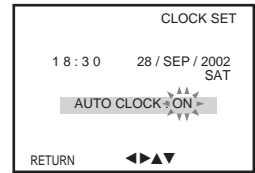

7



RETURN

Press **↻** RETURN repeatedly to exit the menu.

Tips

- If you set "AUTO CLOCK" to "ON", the Auto Clock Set function is activated whenever the DVD-VCR is turned off. The time is adjusted automatically by making reference to the time signal from the station.
- To change the digits while setting, press **◀** to return to the item to be changed, and select the digits by pressing **▲/▼**.

Step 7 : Presetting channels

If some channels could not be preset using the Auto Set Up function, you can preset them manually.

Before you start...

- Turn on the DVD-VCR and your TV.
- Set your TV to the video channel so that the signal from the player appears on the TV screen.
- If the DVD player is in play mode, you cannot display the "SETUP MENU." Stop DVD playback.

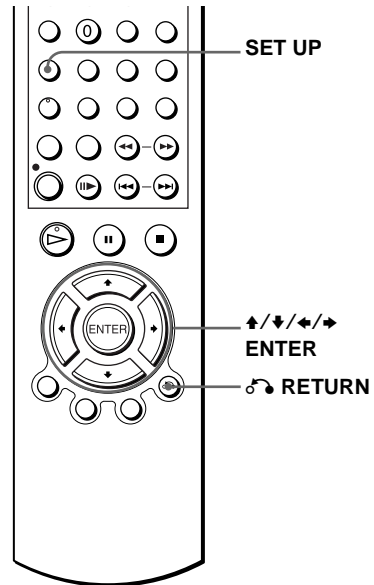

- 1**  Press SET UP.
The "SETUP MENU" appears.

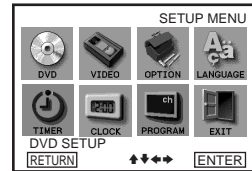

- 2**  Press  to select (INSTALLATION), then press ENTER.
The "INSTALLATION" menu appears.

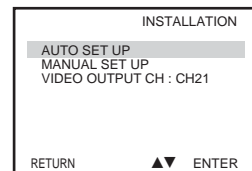

continued

3



Press \uparrow/\downarrow to select "MANUAL SET UP," then press ENTER.

TV STATION TABLE		
PR	CH	NAME
1	27	A A B -
2	29	L M N -
3	30	C D E -
4	32	I J K -
5		

$\blacktriangle\blacktriangleright$ SWAPPING : ENTER
 $\blacktriangle\blacktriangleleft$ RETURN DELETE : CLEAR

4



Press \uparrow/\downarrow to select the row which you want to preset, then press \rightarrow .

To display other pages for programme positions 6 to 80, press \uparrow/\downarrow repeatedly.

MANUAL TUNING	
PR	: $\uparrow\downarrow$ 5 \leftarrow
CH	: $\uparrow\downarrow$ 27 \leftarrow
MFT	: -
NAME	: - - - -

$\blacktriangle\blacktriangleleft$ MEMORY : ENTER
 $\blacktriangle\blacktriangleleft$ RETURN

5



Press \leftarrow/\rightarrow repeatedly until the channel you want is displayed.

MANUAL TUNING	
PR	: $\uparrow\downarrow$ 5 \leftarrow
CH	: 33
MFT	: -
NAME	: - - - -

$\blacktriangle\blacktriangleleft$ MEMORY : ENTER
 $\blacktriangle\blacktriangleleft$ RETURN

6



Press \uparrow/\downarrow to select "NAME," then press \rightarrow .

MANUAL TUNING	
PR	: 5
CH	: 33
MFT	: -
NAME	: * * * * - -

$\blacktriangle\blacktriangleleft$ MEMORY : ENTER
 $\blacktriangle\blacktriangleleft$ RETURN

7



Enter the station name.

- Press \uparrow/\downarrow to select a character. Each time you press \uparrow , the character changes as shown below.
A \rightarrow **B** \rightarrow ... \rightarrow **Z** \rightarrow **0** \rightarrow **1** \rightarrow ... \rightarrow **9**
 \rightarrow **A**

- Press \rightarrow to set the next character. The next space flashes. To correct a character, press \leftarrow/\rightarrow until the character you want to correct flashes, then reset it. You can set up to 4 characters for the station name.

MANUAL TUNING	
PR	: 5
CH	: 33
MFT	: -
NAME	: * O * * - -

$\blacktriangle\blacktriangleleft$ MEMORY : ENTER
 $\blacktriangle\blacktriangleleft$ RETURN

8





Press ENTER to confirm the station name.



RETURN

Press  RETURN repeatedly to exit the menu.

If the picture is not clear

If the picture is not clear, you may use the Manual Fine Tuning (MFT) function. After step 5, press  to select "MFT." Press  to get a clear picture, then press  RETURN to exit the menu.

Tip

- The DVD-VCR must receive channel information for station names to appear automatically.

Note

- When adjusting MFT, the menu may become difficult to read due to interference from the picture being received.

Changing/disabling programme positions

After setting the channels, you can change the programme positions as you like. If any programme positions are unused or contain unwanted channels, you can disable them.

You can also change the station names. If the station names are not displayed, you can enter them manually.

Changing programme positions

Before you start...

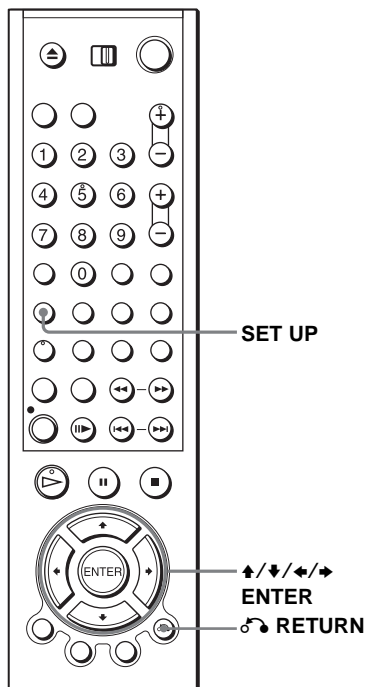

- Turn on the DVD-VCR and your TV.
- Set your TV to the video channel so that the signal from the player appears on the TV screen.
- If the DVD player is in play mode, you cannot display the "SETUP MENU." Stop DVD playback.



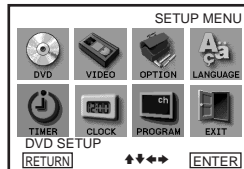

continued

- 1** **SET UP** Press SET UP.
The "SETUP MENU" appears.



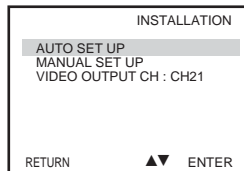

- 2**  Press  to select  (INSTALLATION), then press ENTER.
The "INSTALLATION" menu appears.



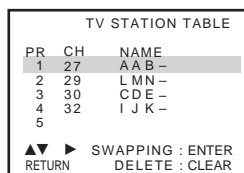

- 3**  Press  to select "MANUAL SET UP," then press ENTER.



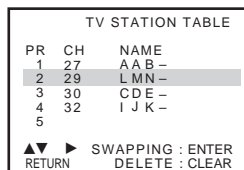

- 4**  Press  to select the row containing the programme position you want to change.
To display other pages for programme positions 6 to 80, press  repeatedly.

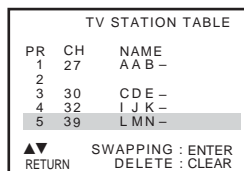

- 5**  Press ENTER, then press  to move to the desired programme position.



- 6**  Press ENTER to confirm the setting.
To change the programme position of another station, repeat steps 4 through 6.

- 7**  Press  RETURN repeatedly to exit the menu.

Disabling unwanted programme positions

After presetting channels, you can disable unused programme positions. The disabled positions will be skipped later when you press the PROG +/- buttons.

Before you start...

- Turn on the DVD-VCR and your TV.
- Set your TV to the video channel so that the signal from the player appears on the TV screen.
- If the DVD player is in play mode, you cannot display the "SETUP MENU." Stop DVD playback.

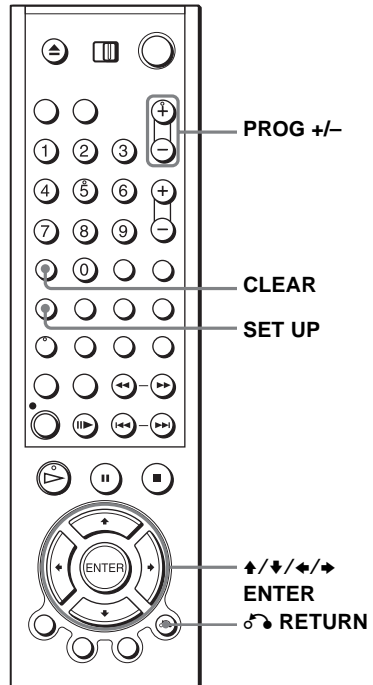

- 1**  Press SET UP.
The "SETUP MENU" appears.

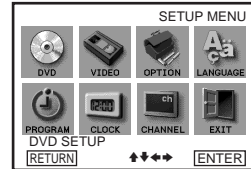

- 2**  Press  to select (INSTALLATION), then press ENTER.
The "INSTALLATION" menu appears.

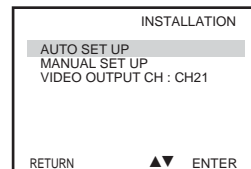

continued

3



Press $\blacktriangle/\blacktriangledown$ to select "MANUAL SET UP," then press ENTER.

TV STATION TABLE		
PR	CH	NAME
1	27	A A B -
2	29	L M N -
3	30	C D E -
4	32	I J K -
5		

$\blacktriangle/\blacktriangledown$ SWAPPING : ENTER
RETURN DELETE : CLEAR

4



Press $\blacktriangle/\blacktriangledown$ to select the row which you want to disable.

To display other pages for programme positions 6 to 80, press $\blacktriangle/\blacktriangledown$ repeatedly.

TV STATION TABLE		
PR	CH	NAME
1	27	A A B -
2	29	L M N -
3	30	C D E -
4	32	I J K -
5		

$\blacktriangle/\blacktriangledown$ SWAPPING : ENTER
RETURN DELETE : CLEAR

5

CLEAR



Press CLEAR.

The selected row will be cleared as shown on the right.

TV STATION TABLE		
PR	CH	NAME
1	27	A A B -
2		
3	30	C D E -
4	32	I J K -
5		

$\blacktriangle/\blacktriangledown$ SWAPPING : ENTER
RETURN DELETE : CLEAR

6

Repeat steps 4 and 5 for any other programme positions you want to disable.

7



RETURN

Press \curvearrowright RETURN repeatedly to exit the menu.

Note

- Be sure to select the programme position you want to disable correctly. If you disable a programme position by mistake, you need to reset that channel manually.

Changing the station names

You can change or enter the station names (up to 4 characters). The DVD-VCR must receive channel information for station names to appear automatically.

Before you start...

- Turn on the DVD-VCR and your TV.
- Set your TV to the video channel so that the signal from the player appears on the TV screen.
- If the DVD player is in play mode, you cannot display the "SETUP MENU." Stop DVD playback.

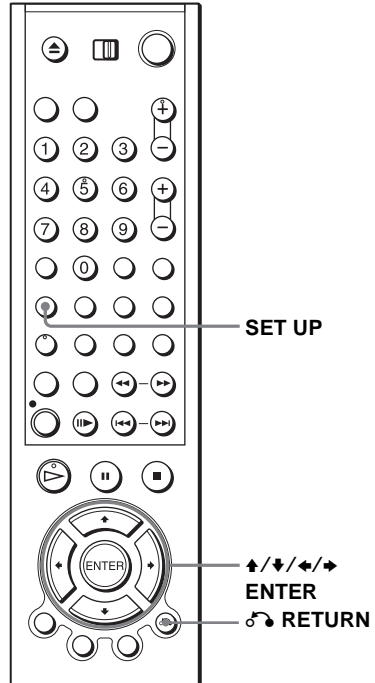

- 1**  Press SET UP.
The "SETUP MENU" appears.

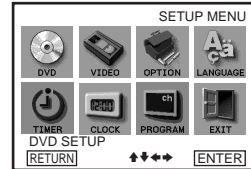

- 2**  Press  to select  (INSTALLATION), then press ENTER.
The "INSTALLATION" menu appears.

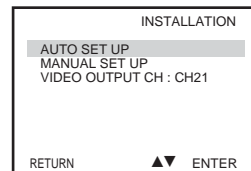

continued

3



Press \uparrow/\downarrow to select "MANUAL SET UP," then press ENTER.

TV STATION TABLE		
PR	CH	NAME
1	27	A A B -
2	29	L M N -
3	30	C D E -
4	32	I J K -
5		- - - -

\blacktriangleleft \blacktriangleright SWAPPING : ENTER
RETURN DELETE : CLEAR

4



Press \uparrow/\downarrow to select the row which you want to change or enter the station name, then press \blacktriangleright .

To display other pages for programme positions 6 to 80, press \downarrow/\uparrow repeatedly.

MANUAL TUNING		
PR	:	5
CH	:	33
MFT	:	-
NAME	:	- - - -

\blacktriangleleft \blacktriangleright MEMORY : ENTER
RETURN

5



Press \uparrow/\downarrow to select "NAME," then press \blacktriangleright .

MANUAL TUNING		
PR	:	5
CH	:	33
MFT	:	-
NAME	:	* * * * - -

\blacktriangleleft \blacktriangleright MEMORY : ENTER
RETURN

6



Enter the station name.

1 Press \uparrow/\downarrow to select a character.

Each time you press \uparrow , the character changes as shown below.

A \rightarrow B \rightarrow ... \rightarrow Z \rightarrow 0 \rightarrow 1 \rightarrow ... \rightarrow 9
 \rightarrow A

2 Press \blacktriangleright to set the next character.

The next space flashes.

To correct a character, press $\blacktriangleleft/\blacktriangleright$ until the character you want to correct flashes, then reset it.

You can set up to 4 characters for the station name.

MANUAL TUNING		
PR	:	5
CH	:	33
MFT	:	-
NAME	:	* O * * - -

\blacktriangleleft \blacktriangleright MEMORY : ENTER
RETURN

7



Press ENTER to confirm the new name.

8



RETURN

Press \curvearrowright RETURN repeatedly to exit the menu.

Playing discs **DVD** **VCD** **CD** **DATA-CD**

Depending on the disc, some operations may be different or restricted. Refer to the operating instructions supplied with your disc.

Before you start...

- Turn on the DVD-VCR and your TV.
- Set your TV to the video channel so that the signal from the player appears on the TV screen.
- Press **SELECT DVD** to control the DVD player.

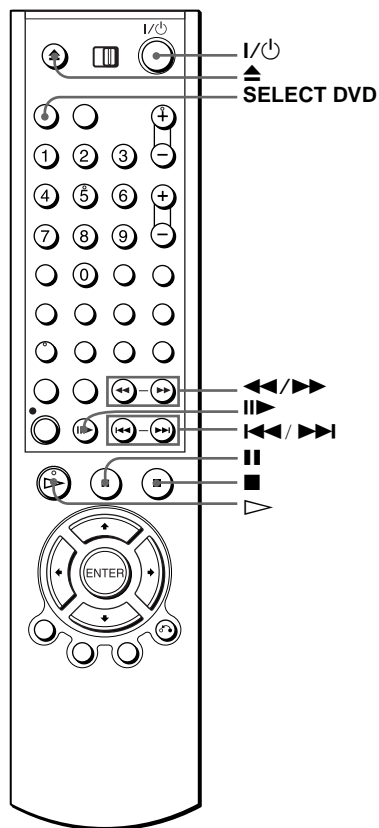

1

Press  to open the disc tray and place a disc on the disc tray.

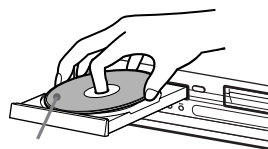

with the playback side facing down

continued

2



Press .

The disc tray closes and the DVD player starts playback.

The display window shows the playback time.

Depending on the disc, a menu may appear on the TV screen.

For DVDs, see page 63. For VIDEO CDs, see page 79.



Additional tasks

To	Press
Stop	■
Pause	 To resume playback, press .
Advance by frame in pause mode	▶
Go to the next chapter, track, or scene in continuous play mode	▶▶ on the remote
Go back to the previous chapter, track, or scene in continuous play mode	◀◀ on the remote
Stop play and remove the disc	▲

To Resume playback for the current disc (Resume Play)

The DVD player remembers the point where you stopped the disc even if the DVD player enters standby mode by pressing .

1 While playing a disc, press ■ to stop playback.

2 Press .

The DVD player starts playback from the point where you stopped the disc in Step 1.

To locate a point quickly by playing a disc in fast forward or fast reverse in continuous play mode

Press ◀◀ or ▶▶. With each press, the playback speed changes as follows.

×2 → ×4 → ×8 → ×16 → ×32 → ×128

Release the button at the desired speed.

When you find the point you want, press .

To watch slow motion in continuous play mode

Press ||, then press ▶▶ SLOW ▶▶. With each press, the playback speed changes as follows.

1/8 → 1/4 → 1/2

To resume normal playback, press .

Tip

- You can listen to the sound during $\times 2$ fast forward playback. However, you cannot listen to DTS (Only Digital Out), MPEG audio and LPCM sound.
- To make a video timer reservation during DVD playback, we recommend performing the operations under “Setting the recording duration time” (page 82).

Notes

- You can change the screen type using the “SCREEN SETUP” menu. (See “Screen Setup” on page 55)
- Do not perform VIDEO playback while playing back a disc.
- The VIDEO CD playback speed changes as follows.
 $\times 4 \rightarrow \times 8$
- You cannot change the CD or DATA-CD playback speed.

Notes on playing DTS* sound tracks on a CD

- When playing DTS-encoded CDs, excessive noise will be heard from the analog stereo jacks. To avoid possible damage to the audio system, the consumer should take proper precautions when the analog stereo jacks of the DVD player are connected to an amplification system. To enjoy DTS Digital Surround™ playback, an external 5.1-channel decoder system must be connected to the digital jack of the DVD player.
- Set the sound to “STEREO” using the AUDIO button when you play DTS sound tracks on a CD (page 73).
- Do not play DTS sound tracks without first connecting the DVD player to an audio component having a built-in DTS decoder. The DVD player outputs the DTS signal via the DIGITAL AUDIO OUT (COAXIAL or OPTICAL) jack even if “DTS” is set to “Off” in “AUDIO SETUP” menu (page 53), and may affect your ears or cause your speakers to be damaged.

Notes on playing DVDs with a DTS sound track

- DTS audio signals are output only through the DIGITAL AUDIO OUT (COAXIAL or OPTICAL) jack.
- When you play a DVD with DTS sound tracks, set “DTS” to “On” in “AUDIO SETUP” menu (page 53).
- If you connect the player to audio equipment without a DTS decoder, do not set “DTS” to “On” in “AUDIO SETUP” menu (page 53). A loud noise may come out from the speakers, affecting your ears or causing the speakers to be damaged.

* “DTS” and “DTS Digital Out” are trademarks of Digital Theater Systems, Inc.

Guide to the on-screen display

DVD **VCD** **CD** **DATA-CD**

You can check disc information during playback.

The displayed contents differ according to the type of disc being played.

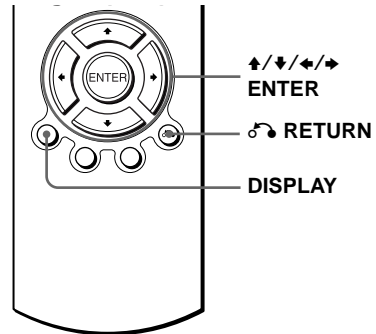

Press DISPLAY. The following information appears; type of disc, current title/track, chapter, counter position, voice language and subtitle language. Refer to “DVD AUDIO/SUBTITLE LANGUAGE” on page 109 for the abbreviation of the language.

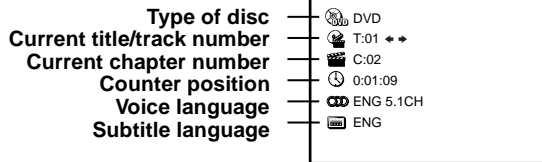

You can playback the desired title/track, chapter or counter position using this menu.

To playback the desired title/track or chapter

- 1 Press **▲/▼** to select the desired item.
- 2 Press **◀/▶** to change the item.
- 3 Press **ENTER** to start playback.
- 4 Press **DISPLAY** or **RETURN** to turn off the menu.

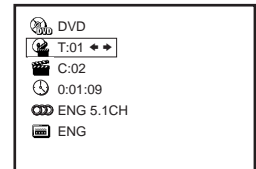

The title/track or chapter icon will appear on the DVD playback screen followed by the current title/track or chapter number and the counter position.

To playback from the desired counter position

- 1 Press **▲/▼** to select the counter position icon.
- 2 Enter the desired position using the number buttons.
- 3 Press **ENTER** to start playback.
- 4 Press **DISPLAY** or **RETURN** to turn off the menu.

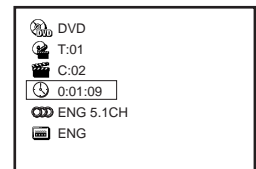

Note

- The display may not change as operated depending on the disc.

Playing a tape **VHS**

Before you start...

- Turn on the DVD-VCR and your TV.
- Set your TV to the video channel so that the signal from the player appears on the TV screen.
- Press SELECT VIDEO to control the VCR.

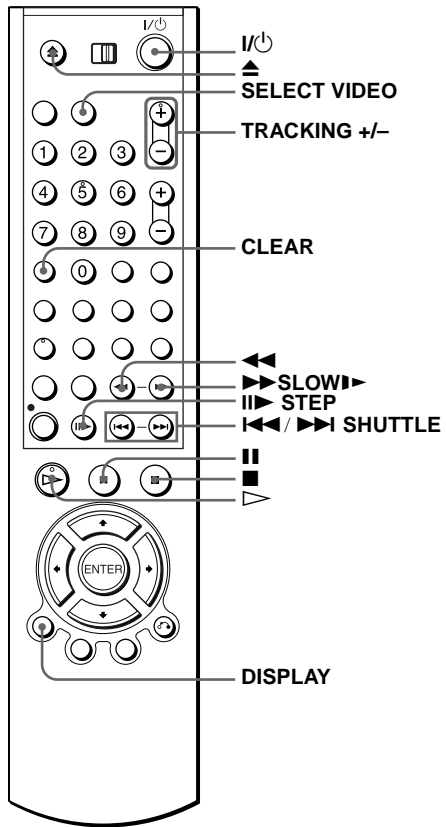

1

Insert a tape.

The VCR starts playing automatically if you insert a tape with its safety tab removed.

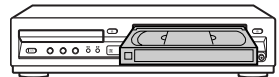

2



Press .

The display window shows the playback time.

When the tape reaches the end, it will rewind automatically.

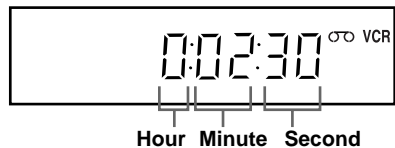

continued

Additional tasks

To	Press
Stop play	■
Pause play	
Resume play after pause	or ▷
Fast-forward the tape	▶▶ during stop
Rewind the tape	◀◀ during stop
Eject the tape	▲

To turn off the power while rewinding (Rewind Shut Off)

Press I/⏻ while the tape is rewinding. The power will turn off but the tape will keep rewinding until it reaches the end.

To play/search at various speeds

Playback options	Operation
View the picture during fast-forward or rewind	During fast-forward, hold down ▶▶. During rewind, hold down ◀◀.
Play at high speed	<ul style="list-style-type: none"> • During playback, briefly press ▶▶ or ◀◀. The tape continues to play at 5 times normal speed. • During playback, hold down ▶▶ or ◀◀. The tape continues to play at 5 times normal speed. When you release the button, normal playback resumes.
Play in slow motion	During pause, press ▶▶SLOW ▶▶.
Play frame by frame	During pause, press ▶ STEP.
Play at various speeds (Shuttle play)	During playback, press ◀◀ or ▶▶ SHUTTLE. You can change the playback speed as follows. REVIEW ↔ -x2 ↔ -x1 ↔ -SLOW ↔ STILL ↔ SLOW ↔ PLAY ↔ x2 ↔ CUE

To resume normal playback

Press ▷.

To use the time counter

Press CLEAR at the point on the tape that you want to find later. The counter in the display window resets to "0:00:00."



To display the counter on the TV screen, press DISPLAY.

Tip

- Adjust the picture using the TRACKING +/- buttons if:
 - Streaks appear while playing in slow motion.
 - Bands appear at the top or bottom while pausing.
 - The picture shakes during pause.

Notes

- Tapes recorded in the LP mode on other VCRs can be played back on this VCR but the picture quality cannot be guaranteed.
- The counter resets to “0:00:00” whenever a tape is reinserted.
- The counter stops counting when it comes to a portion with no recording.
- Depending on your TV, the following may occur while playing an NTSC-recorded tape:
 - The picture becomes black and white.
 - The picture shakes.
 - No picture appears on the TV screen.
 - Black streaks appear horizontally on the TV screen.
 - The colour density increases or decreases.
- When 10 hours have passed, the counter in the display window returns to “0:00:00” and the count starts over again.
- The sound is muted during playback at various speeds.
- The picture may show noise when playing at high speed in reverse.
- While playing a tape, you can display the “SETUP MENU” but the remote commander’s function switches to DVD automatically. Press  RETURN repeatedly to exit the menu.
- Stop disc playback while playing back a video.
- The picture returns to normal playback from slow motion in reverse in 30 seconds.

Recording TV programmes **VHS**

Before you start...

- Turn on the DVD-VCR and your TV.
- Switch the input selector on your TV so that the signal from the player appears on the TV screen.
- Press SELECT VIDEO to control the VCR.
- To record from a satellite or digital tuner, turn it on.
- Make sure the tape is longer than the total recording time.

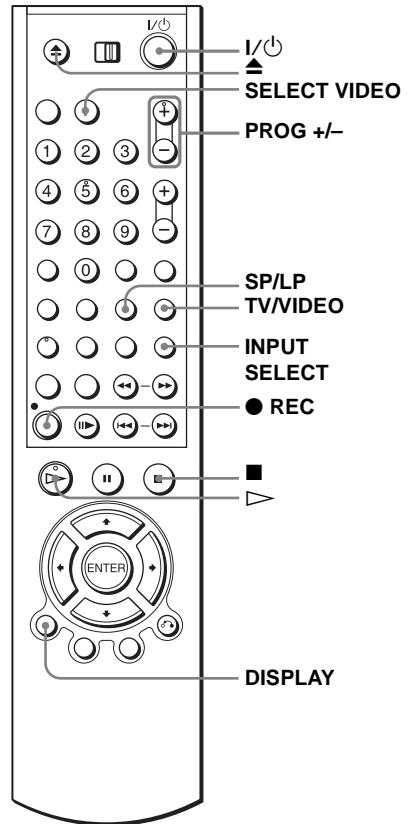

1

Insert a tape with its safety tab in place.

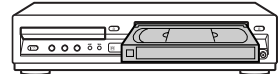

2

• PROG/
TRACKING



- To record a normal channel, press PROG +/- until the programme position number you want appears in the display window.



INPUT
SELECT



- To record from other equipment connected to one or more of the LINE inputs, press INPUT SELECT until the connected line appears in the display window.



3

SP / LP



Press SP/LP to select the tape speed, SP or LP.

LP (Long Play) provides recording time twice as long as SP. However, SP (Standard Play) produces better picture and audio quality.



4

• REC



Press ● REC to start recording.

The recording indicator lights up red in the display window.



Recording indicator

To stop recording

Press ■.

To check the remaining time

Press DISPLAY twice. With the display on, press DISPLAY again to check the remaining time.



Time counter

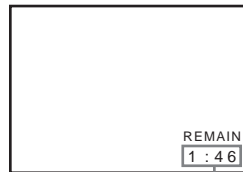

Remaining tape length

continued

In order to get an accurate remaining time indication, be sure “Tape Select” in the “VIDEO FUNCTION SETUP” menu is set according to the tape type you use (see page 90).

Maximum Recording Time

Tape Length	SP	LP
E-180	3 hrs	6 hrs
E-240	4 hrs	8 hrs
E-260	4 hrs 20 mins	8 hrs 40 mins
E-300	5 hrs	10 hrs

To watch another TV programme while recording

- 1 Press TV/VIDEO to display “TV” in the display window.

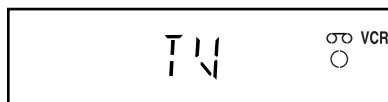

- 2 Select another channel on the TV.

To watch a DVD while recording

- 1 Press SELECT DVD to control the DVD player.

- 2 Press  and place the disc on the disc tray.

- 3 Press .

The disc tray closes and the DVD player starts playback. The TV screen will automatically change to the DVD playback screen.

To save a recording

To prevent accidental erasure, break off the safety tab as illustrated. To record on the tape again, cover the tab hole with adhesive tape.

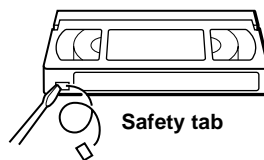

Tips

- To select a programme position, you can use the number buttons on the remote commander. For two-digit numbers, for example, press 2 and 3 to select “PR 23.”
- If you connect additional equipment to a LINE connector or jack, you can select the input signal using the INPUT SELECT or PROG +/- buttons.
- The DISPLAY information appears on the TV screen indicating information about the tape, but the information will not be recorded on the tape.
- If you do not want to watch TV while recording, you can turn off the TV. When using a decoder, make sure to leave it on.

Notes

- The DISPLAY information does not appear during still (pause) mode or slow-motion playback.
- If a tape has portions recorded in both PAL and NTSC systems, the time counter reading will not be correct. This discrepancy is due to the difference between the counting cycles of the two video systems.
- When you insert a non-standard commercially available tape, the remaining time may not be correct.
- The remaining time is intended for rough measurement only.
- About 30 seconds after the tape begins playback, the tape remaining time will be displayed.
- You cannot record a DVD to a VCR tape.
- To watch a TV programme during video recording, stop disc playback.

Recording TV programmes using the VIDEO Plus+® system **VHS**

The VIDEO Plus+ system is the feature that simplifies programming the VCR to make timer recordings. Just enter the PlusCode number listed in the TV programme guide. The date, times, and programme position of that programme are set automatically. You can preset a total of eight programmes, including settings made with other timer methods.

Before you start...

- Check that the DVD-VCR clock is set to the correct time.
- Turn on the DVD-VCR and your TV.
- Set your TV to the video channel so that the signal from the player appears on the TV screen.
- Press SELECT VIDEO to control the VCR.
- To record from a satellite or digital tuner, turn it on.
- Insert a tape with its safety tab in place. Make sure the tape is longer than the total recording time.
- Set "TIMER METHOD" to "VIDEOPLUS" or "VARIABLE" in the "USER SET" menu (see page 95).

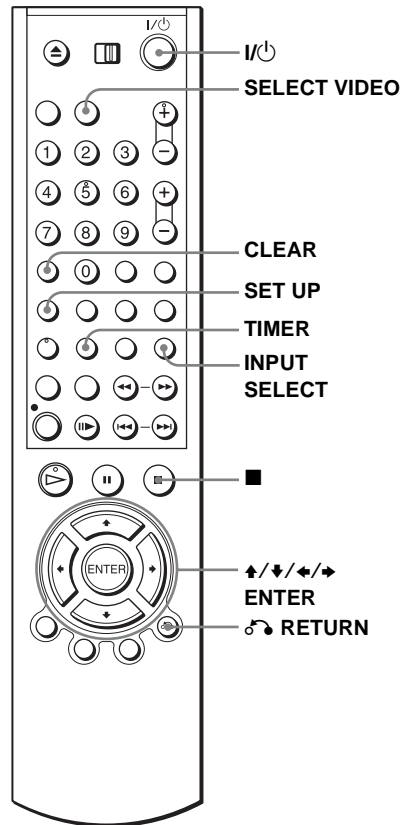

1

SUBTITLE/
TIMER



Press **TIMER**.

- When you set “**TIMER METHOD**” to “**VARIABLE**”:
The “**TIMER METHOD**” menu appears on the TV screen. Press **▲/▼** to select “**VIDEOPLUS**,” then press **ENTER**.
- When you set “**TIMER METHOD**” to “**VIDEOPLUS**”:
The “**VIDEOPLUS**” menu appears on the TV screen.

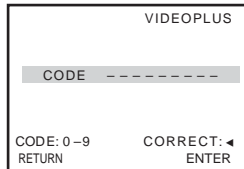
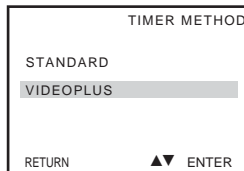

2

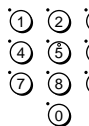

CLEAR



Press the number buttons to enter the PlusCode number.

If you make a mistake, press **CLEAR** and re-enter the correct number.

You can also press **◀** to delete the last entered number.

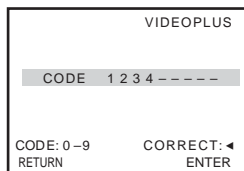

3



INPUT
SELECT



CLEAR



Press **ENTER**.

The date, start and stop times, programme position, tape speed and PDC (Programme Delivery Control) setting appear on the TV screen.

- If “- -” appears in the “**PR**” (programme) column (this may happen for local broadcasts), you have to set the appropriate programme position manually.
Press **▲/▼** to select the desired programme position.
- To record from other equipment connected to one or more of the **LINE** inputs, press **INPUT SELECT** to display the connected line in the “**PR**” position.

You will only have to do this operation once for the referred channel. The VCR will then store your setting.

If the information is incorrect, press **CLEAR** to cancel the setting.

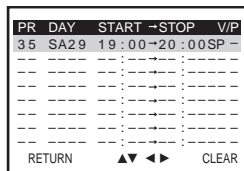

continued

4



If you want to change the date, tape speed and the PDC setting:

- 1 Press ←/→ to select the item you want to change.
- 2 Press ↑/↓ to reset it.
 - To record the same programme every day or the same day every week, see “Daily/weekly recording” on page 40.
 - To use the PDC function, set V/P to ON. For details about the PDC function, see “Timer recording with PDC signals” on page 40.

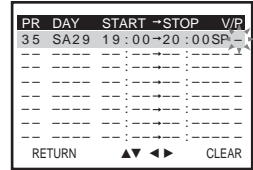

5



RETURN

Press RETURN to confirm the setting.

6



RETURN

Press RETURN to exit the menu.

7



RETURN

Press I/O to turn off the DVD-VCR.

The indicator appears in the display window and the VCR stands by for recording.

To record from other equipment, leave the connected equipment switched on.

To stop recording

To stop the DVD-VCR while recording, press SELECT VIDEO and then press .

Daily/weekly recording

In step 4 above, press ↓ to select the recording pattern. Each time you press ↓, the indication changes as shown below. Press ↑ to change the indication in reverse order.

today → **DLY (Monday to Sunday)** → **W-SA (every Saturday)** → **W-SU (every Sunday)** → **1 month later** → **(dates count down)** → **today**

Timer recording with PDC signals

Some broadcast systems transmit PDC signals with their TV programmes. These signals ensure that your timer recordings are made regardless of broadcast delays, early starts, or broadcast interruptions.

To use the PDC function, set V/P to ON in step 4 above. You can also use the PDC function for a source connected to one or more of the LINE inputs.

To record satellite broadcasts

If you connect the satellite tuner and the VCR, you can record satellite programmes.

- 1** Turn on the satellite tuner.
- 2** On the satellite tuner, select the satellite programme for which you want to make a timer setting.
- 3** Keep the satellite tuner turned on until the VCR finishes recording the satellite programme for which you have made a timer setting.

To watch another TV programme after setting the timer

- 1** Press TV/VIDEO to display “TV” in the display window.



- 2** If your TV is connected to the VCR using A/V connections, set the TV to the TV's aerial input; if not, skip this step.
- 3** Select another channel on the TV.

To watch a DVD after setting the timer

- 1** Press SELECT DVD to control the DVD player.
- 2** Press ▲ and place the disc on the disc tray.
- 3** Press ▷.

The disc tray closes and the DVD player starts playback. The TV screen will automatically change to the DVD playback screen.

Tips

- To set the channel, you can also use the ▲/▼ or number buttons.
- If the ○ indicator appears, this means that the VCR is currently recording this programme.
- You can also do the following tasks while the VCR is recording:
 - Reset the counter (page 32).
 - Display tape information on the TV screen (page 35).

To use the Auto Tape Speed function

In step 4 above, press ▼ to select “AUTO.” When you are recording a programme in the SP mode and the remaining tape length becomes shorter than the recording time, the recording tape speed is automatically changed to the LP mode. Note that some noise will appear on the picture when the tape speed is changed. To operate this function correctly, the “Tape Select” setting in the “VIDEO FUNCTION SETUP” menu must be accurate (see page 90).

continued

Tips

- To set the line input video source, you can also use the INPUT SELECT button.
- You can set the extended time for the VIDEO Plus+ setting by 10, 20, 30, 40, 50, or 60 minutes. Set "VIDEOPLUS EXTEND" in the "USER SET" menu to the desired extended time on page 95.
- To check, change, or cancel the programme setting, see "Checking/changing/cancelling timer settings" on page 47.

Notes

- If the PDC signal is too weak or the broadcasting station failed to transmit PDC signals, the VCR will start recording at the set time without using the PDC function.
- The ⊖ indicator flashes in the display window when you press I/⏻ with no tape inserted.
- When you set "TIMER METHOD" to "STANDARD" in the "USER SET" menu, the "VIDEOPLUS" menu does not appear on the TV screen. Select "VIDEOPLUS" or "VARIABLE."

Recording TV programmes using the timer

VHS

You can preset up to eight programmes at a time.

Before you start...

- Check that the DVD-VCR clock is set to the correct time.
- Turn on the DVD-VCR and your TV.
- Switch the input selector on your TV so that the signal from the player appears on the TV screen.
- Press SELECT VIDEO to control the VCR.
- To record from a satellite or digital tuner, turn it on.
- Insert a tape with its safety tab in place. Make sure the tape is longer than the total recording time.
- If the DVD player is in play mode, you cannot display the "SETUP MENU." Stop the DVD playback.
- Set "TIMER METHOD" to "STANDARD" or "VARIABLE" in the "USER SET" menu (see page 95).

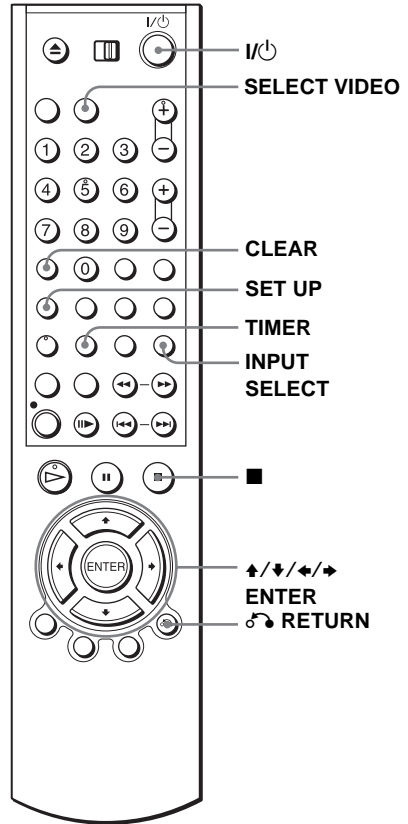

continued

1SUBTITLE/
TIMERPress **TIMER**.

- When you set “TIMER METHOD” to “VARIABLE”:
The “TIMER METHOD” menu appears on the TV screen. Press **▲/▼** to select “STANDARD”, then press **ENTER**.

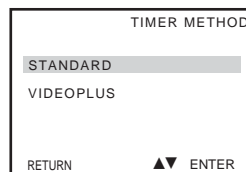

- When you set “TIMER METHOD” to “STANDARD”:
The “TIMER PROGRAMMING” menu appears on the TV screen.

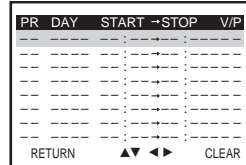
**2**

Set the date, start and stop times, programme position, tape speed and PDC function:

- 1 Press **➡** to select each item in turn.
- 2 Press **▲/▼** to set each item.

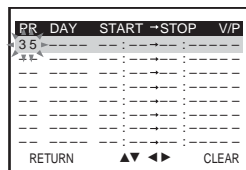
To correct a setting, press **⬅** to return to that setting and reset.

- To record the same programme every day or the same day every week, see “Daily/weekly recording” on page 45.
- To use the PDC function, set V/P to ON. For details about the PDC function, see “Timer recording with PDC signals” on page 40.
- To record from other equipment connected to one or more of the LINE inputs, press **INPUT SELECT** to display the connected line in the “PR” position.

INPUT
SELECT**3**

RETURN

Press **↻** **RETURN** to confirm the setting.The **⊖** indicator appears in the display window.To enter another setting, press **▲/▼** to select the next row and repeat step 2.

CLEAR

Press **CLEAR** to cancel the setting.**4**

RETURN

Press **↻** **RETURN** to exit the menu.**5**Press **I/O** to turn off the DVD-VCR.The **⊖** indicator appears in the display window and the VCR stands by for recording.

To record from other equipment, leave the connected equipment switched on.

To stop recording

To stop the DVD-VCR while recording, press SELECT VIDEO and then press ■.

Daily/weekly recording

In step 2 above, press ↓ to select the recording pattern. Each time you press ↓, the indication changes as shown below. Press ↑ to change the indication in reverse order.

today → **DLY (Monday to Sunday)** → **W-SA (every Saturday)** → **W-SU (every Sunday)** → **1 month later** → **(dates count down)** → **today**

To use the Auto Tape Speed function

In step 2 above, press ↓ to select “AUTO.” When you are recording a programme in the SP mode and the remaining tape length becomes shorter than the recording time, the recording tape speed is automatically changed to the LP mode. Note that some noise will appear on the picture when the tape speed is changed. To operate this function correctly, the “Tape Select” setting in the “VIDEO FUNCTION SETUP” menu must be accurate (see page 90).

Tips

- To set the line input video source, you can also use the INPUT SELECT button.
- Even if you set “TIMER METHOD” to “VIDEOPLUS” in the “USER SET” menu, you can set the timer manually. Press SET UP to select TIMER PROGRAMMING, then go to step 2.
- To check, change, or cancel the programme setting, see “Checking/changing/cancelling timer settings” on page 47.

Notes

- When setting the timer with PDC signals, enter the start times exactly as indicated in the TV programme guide. Otherwise, the PDC function will not work.
- If the PDC signal is too weak or the broadcasting station failed to transmit PDC signals, the VCR will start recording at the set time without using the PDC function.
- The ⊖ indicator flashes in the display window when you press I/⏻ with no tape inserted.

To watch another TV programme after setting the timer

- 1 Press TV/VIDEO to display “TV” in the display window.



- 2 If your TV is connected to the VCR using A/V connections, set the TV to the TV's aerial input; if not, skip this step.
- 3 Select another channel on the TV.

continued

To watch a DVD after setting the timer

1 Press SELECT DVD to control the DVD player.

2 Press ▲ and place the disc on the disc tray.

3 Press ▷.

The disc tray closes and the DVD player starts playback. The TV screen will automatically change to the DVD playback screen.

Tips

- To set the channel, you can also use the ▲/▼ or number buttons.
- If the ○ indicator appears, this means that the VCR is currently recording this programme.
- You can also do the following tasks while the VCR is recording:
 - Reset the counter (page 32).
 - Display tape information on the TV screen (page 35).

Checking/changing/cancelling timer settings **VHS**

Before you start...

- Check that the DVD-VCR clock is set to the correct time.
- Turn on the DVD-VCR and your TV.
- Switch the input selector on your TV so that the signal from the player appears on the TV screen.
- Press SELECT VIDEO to control the VCR.
- To record from a satellite or digital tuner, turn it on.
- Insert a tape with its safety tab in place. Make sure the tape is longer than the total recording time.
- If the DVD player is in play mode, you cannot display the "SETUP MENU." Stop the DVD playback.
- Set "TIMER METHOD" to "STANDARD" or "VARIABLE" in the "USER SET" menu (see page 95).

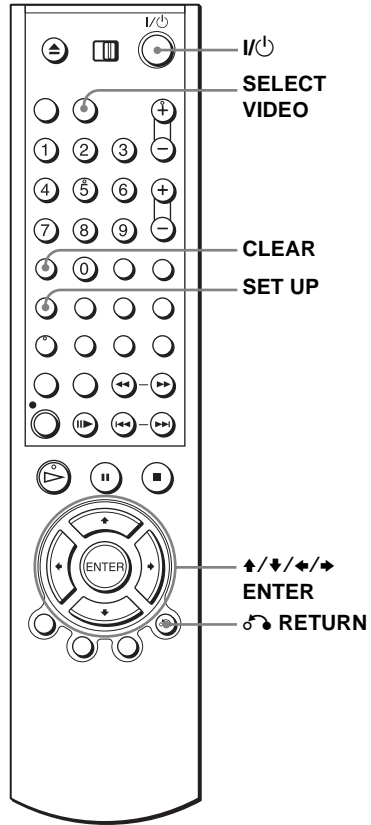

1



Press SET UP when the DVD player is in stop mode.
The "SETUP MENU" appears.

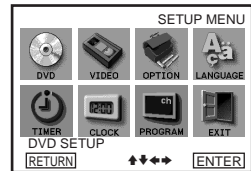

continued

A/V Receiver hookup **DVD** **VCD** **CD** **DATA-CD** **VHS**

A Use this hookup if your A/V receiver has a Dolby* Surround (Pro Logic) decoder and 3 to 6 speakers

You can enjoy the Dolby Surround effects only when playing Dolby Surround audio or multi-channel audio (Dolby Digital) discs.

* Manufactured under license from Dolby Laboratories. "Dolby," "Pro Logic," and the double-D symbol are trademarks of Dolby Laboratories.

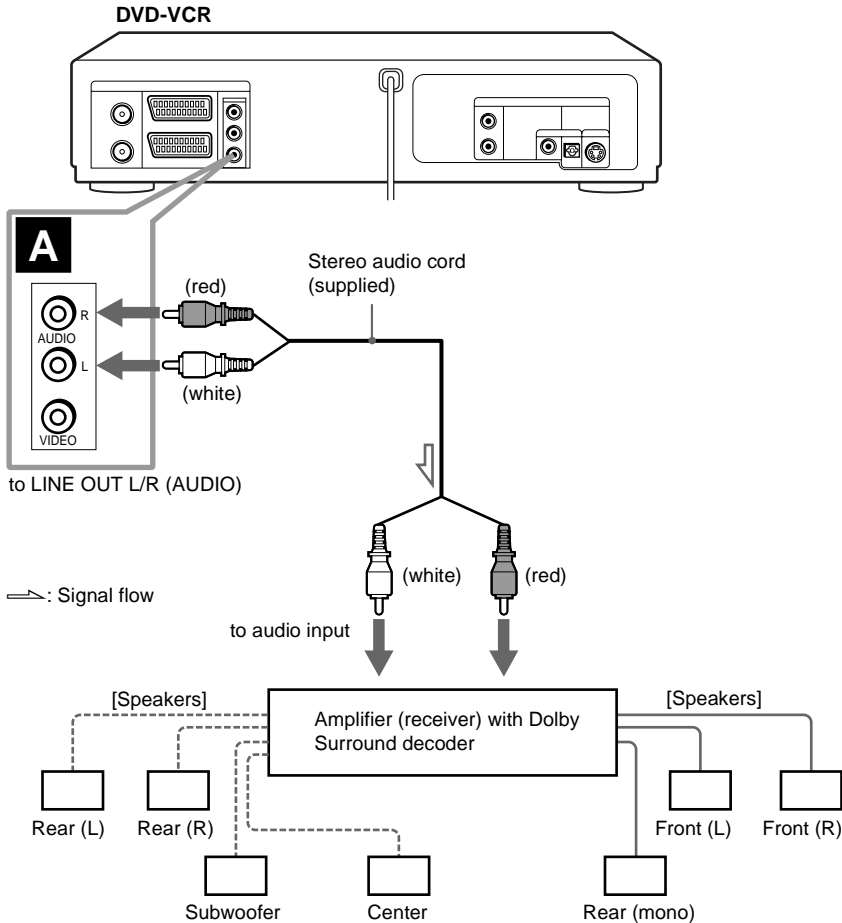

Note

- When connecting 6 speakers, replace the monaural rear speaker with a center speaker, 2 rear speakers and a subwoofer.

B Use this hookup if your A/V receiver has a Dolby Digital, MPEG audio or DTS* decoder, a digital input jack and 6 speakers

This connection will allow you to use the Dolby Digital, MPEG audio or DTS decoder function of your AV amplifier (receiver). You are not able to enjoy the surround sound effects of this player. You must make connections using **B-1** and **B-2**.

* "DTS" and "DTS Digital Out" are trademarks of Digital Theater Systems, Inc.

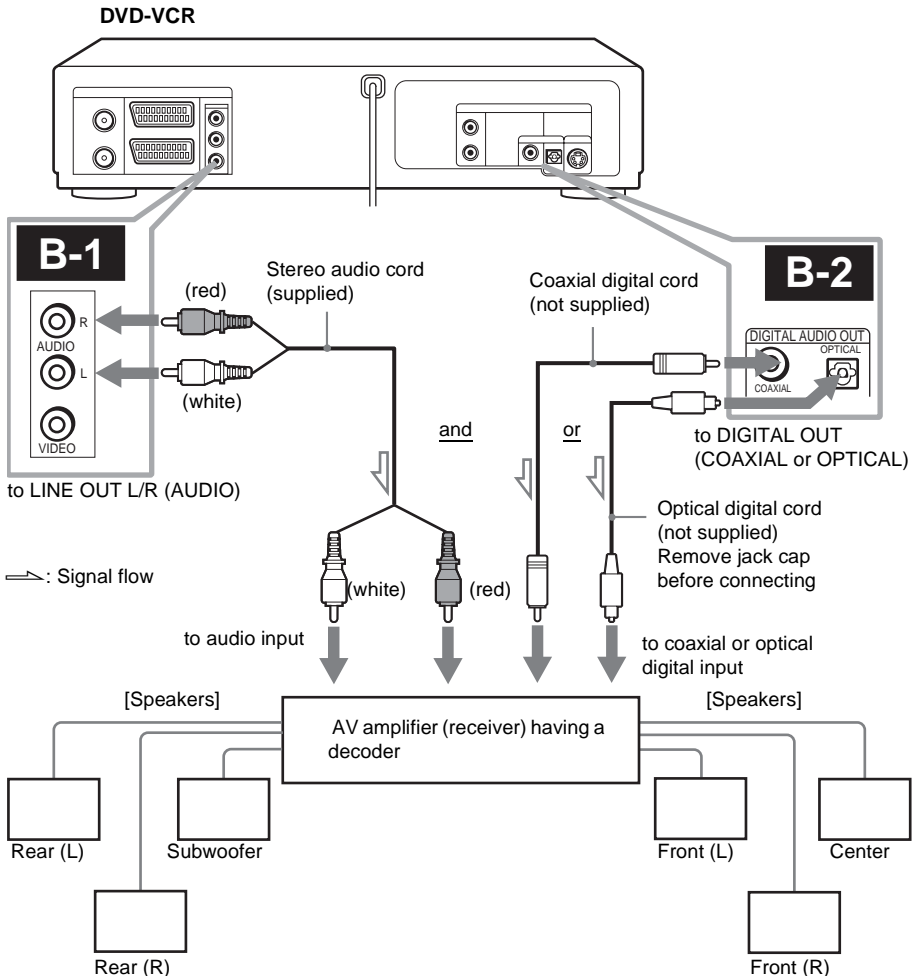

Note

- After you have completed the connection, be sure to set "Dolby Digital" to "Dolby Digital" and "DTS" to "On" in "Audio Setup" (page 52). If your AV amplifier (receiver) has an MPEG audio decoder function, set "MPEG" to "MPEG" (page 52). Otherwise, no sound or a loud noise will come from the speakers.

S-Video hookup **DVD** **VCD**

Make audio connections using the LINE OUT AUDIO L/R jacks or DIGITAL AUDIO OUT (OPTICAL or COAXIAL) jacks on the right side of the DVD-VCR when you use S-VIDEO hookup.

Use this hookup if your TV has an S VIDEO input jack

- Connect an S VIDEO cord (not supplied). You will enjoy high quality images.

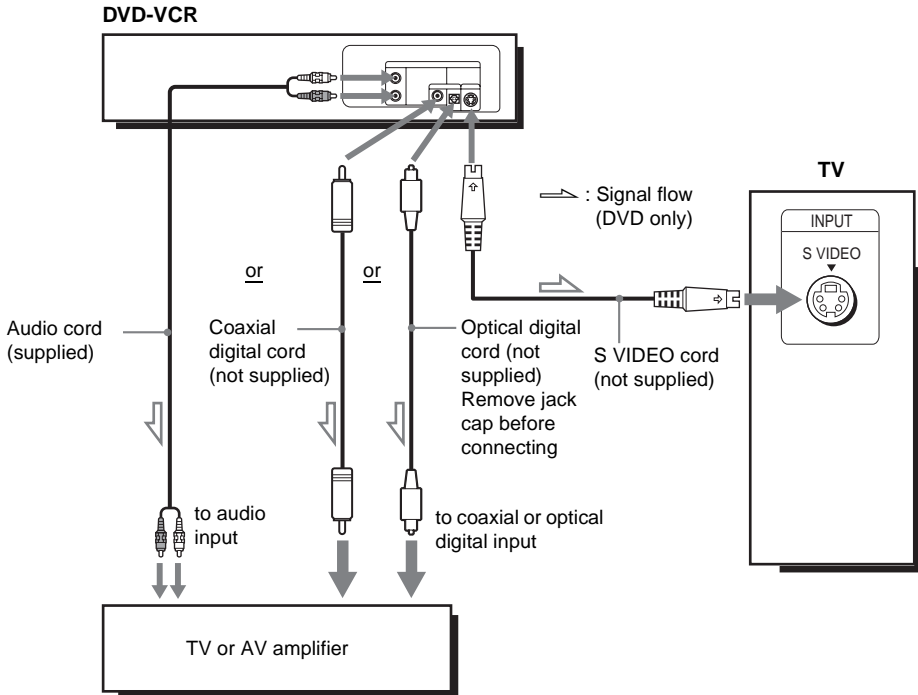



Notes

- Set "DVD Video Out" to "S-Video" in the "SCREEN SETUP" menu (page 55) to view pictures from the S VIDEO jack.
- The connection using S VIDEO OUT jack is only for the DVD player.

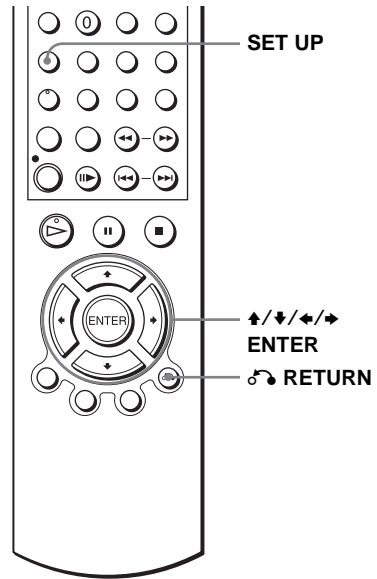

Audio Setup

“Audio Setup” allows you to set the sound according to the playback and connection conditions.



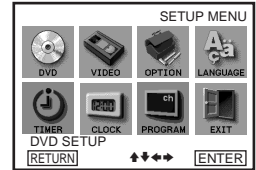

- 1**  Press SET UP when the DVD player is in stop mode.
The “SETUP MENU” appears.

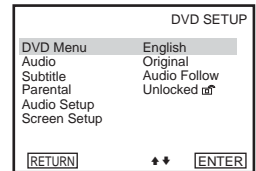

- 2**  Press  to select  (DVD Setup), then press ENTER.
The “DVD SETUP” menu appears.



- 3**  Press  to select “Audio Setup,” then press ENTER.

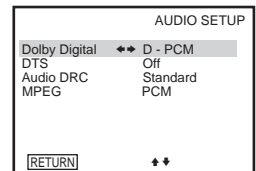

4



Press **↑/↓** to select the setup item from the displayed list: “Dolby Digital,” “DTS,” “Audio DRC,” or “MPEG.”

5



Press **←/→** to select an item, then press **↶** RETURN to confirm the setting.



RETURN

6



Press **↶** RETURN repeatedly to exit the menu.

RETURN

Menu choices

- **Dolby Digital**

Selects the type of Dolby Digital signal.

The default setting is indicated in bold print.

D-PCM	Select this when the player is connected to an audio component lacking a built-in Dolby Digital decoder.
Dolby Digital	Select this when the player is connected to an audio component with a built-in Dolby Digital decoder.

- **DTS**

Selects whether or not to output DTS signals.

The default setting is indicated in bold print.

Off	Select this when the player is connected to an audio component lacking a built-in DTS decoder.
On	Select this when the player is connected to an audio component with a built-in DTS decoder.

- **Audio DRC (Dynamic Range Control)**

Makes the sound clear when the volume is turned down when playing a DVD that conforms to “Audio DRC.” This affects the output from the following jacks:

- LINE OUT AUDIO L/R jacks
- DIGITAL AUDIO OUT (OPTICAL or COAXIAL) jack only when “Dolby Digital” is set to “D-PCM.”

The default setting is indicated in bold print.

Standard	Normally select this position.
TV Mode	Makes the low sounds clear even if you turn the volume down.

continued

- **MPEG**

Selects the type of MPEG audio signal.

The default setting is indicated in bold print.

PCM	Select this when the player is connected to an audio component lacking a built-in MPEG decoder. If you play MPEG audio sound tracks, the player outputs stereo signals via the DIGITAL OUT (OPTICAL or COAXIAL) jack.
MPEG	Select this when the player is connected to an audio component with a built-in MPEG decoder.

Notes

- If you select the surround setting while playing a DVD, the player does not output the following signals from the DIGITAL AUDIO OUT (OPTICAL or COAXIAL) jack.
 - Dolby Digital signals (when you set “Dolby Digital” in “AUDIO SETUP” to “D-PCM”)
 - MPEG audio signals
- If you connect a component that does not conform to the selected audio signal, a loud noise (or no sound) will come out from the speakers, affecting your ears or causing the speakers to be damaged.

Screen Setup

“Screen Setup” allows you to set the screen according to the playback and connection conditions.

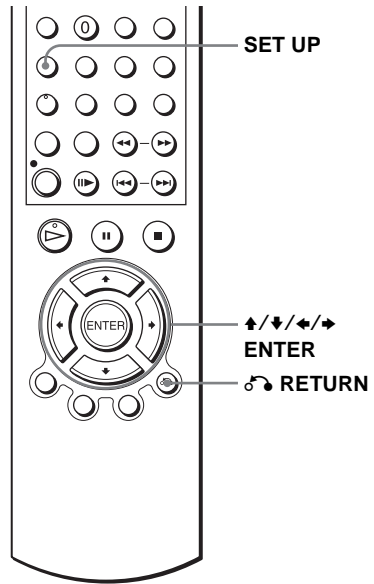

- 1** **SET UP** Press SET UP when the DVD player is in stop mode.
The “SETUP MENU” appears.

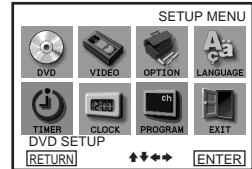

- 2** Press **↑/↓/←/→** to select  (DVD SETUP), then press **ENTER**.
The “DVD SETUP” menu appears.

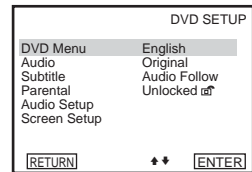

- 3** Press **↑/↓** to select “Screen Setup,” then press **ENTER**.

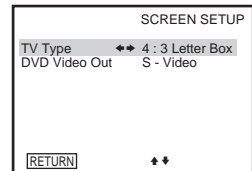

continued

4



Press **↑/↓** to select the setup item from the displayed list: “TV Type,” or “DVD Video Out.”

5



Press **←/→** to select an item, then press **↶** RETURN to confirm the setting.



RETURN

6



Press **↶** RETURN repeatedly to exit the menu.

RETURN

Menu choices

- TV Type

Selects the aspect ratio of the connected TV (4:3 standard or wide). The default setting is indicated in bold print.

4:3 Letter Box	Select this when you connect a 4:3 screen TV. Displays a wide picture with bands on the upper and lower portions of the screen.
4:3 Pan Scan	Select this when you connect a 4:3 screen TV. Automatically displays the wide picture on the entire screen and cuts off the portions that do not fit.
16:9	Select this when you connect a wide-screen TV or a TV with a wide mode function.

4:3 Letter Box



4:3 Pan Scan



16:9

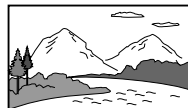

- DVD Video Out

Selects the method of outputting video signals from the LINE (RGB)-TV jack on the rear panel of the player.

The default setting is indicated in bold print.

S-Video	Outputs S video signals.
RGB (LINE)	Outputs RGB signals.

Notes

- Playback settings stored in the disc take priority over the “DVD SETUP” menu settings and not all the functions described may work.
- Depending on the DVD, “4:3 Letter Box” may be selected automatically instead of “4:3 Pan Scan” or vice versa.
- The connection using S VIDEO OUT jack is only for the DVD player.
- When “RGB (LINE)” is selected, S video signals cannot be output.

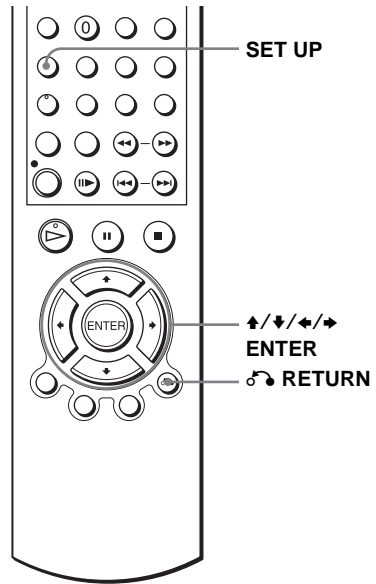

Setting the display or sound track language **DVD**

You can set various languages for the disc's menu, sound track or subtitle.



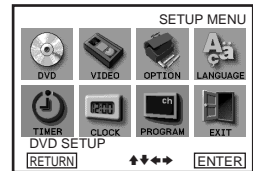

- 1**  Press SET UP when the DVD player is in stop mode.
The "SETUP MENU" appears.

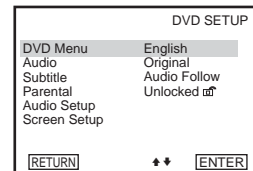

- 2**  Press  (DVD SETUP), then press ENTER.
The "DVD SETUP" menu appears.



- 3**  Press  to select the language setup item from the displayed list: "DVD Menu," "Audio," or "Subtitle."
Then press ENTER.

4



Press $\blacktriangle/\blacktriangledown$ to select the desired language, then press ENTER.

- **DVD MENU LANGUAGE**
You can select the desired language for the disc's menu.



- **AUDIO LANGUAGE**
Switches the language of the sound track. When you select "Original," the language given priority in the disc is selected.



- **SUBTITLE LANGUAGE**
Switches the language of the subtitle recorded on the DVD. When you select "Audio Follow," the language for the subtitles changes according to the language you selected for the sound track.

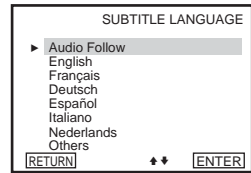

5



RETURN

Press $\blacktriangle/\blacktriangledown$ RETURN repeatedly to exit the menu.

Tip

- If you select "Others" in step 4, an additional language menu appears. Press $\blacktriangle/\blacktriangledown/\blacktriangleleft/\blacktriangleright$ to select the desired language, then press ENTER.

Notes

- When you select a language that is not recorded on the DVD in step 4, one of the recorded languages will be automatically selected.
- Playback settings stored in the disc take priority over the DVD SETUP settings and not all the functions described may work.



Parental Control (limiting playback by children)

DVD

Playback of some DVDs can be limited according to a predetermined level such as the age of the users. The "PARENTAL CONTROL" function allows you to set a playback limitation level.

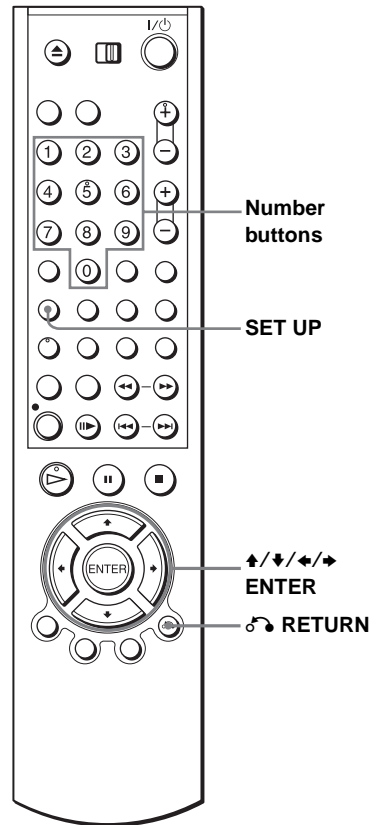

1

SET UP



Press SET UP when the DVD player is in stop mode.

The "SETUP MENU" appears.

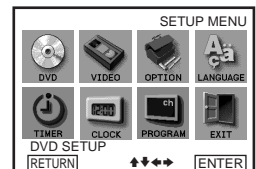

2



Press **▲/▼/◀/▶** to select  (DVD Setup), then press **ENTER**.
The “DVD SETUP” menu appears.

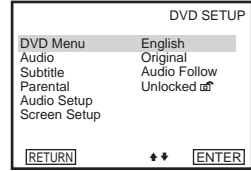

3



Press **▲/▼** to select “Parental,” then press **ENTER**.

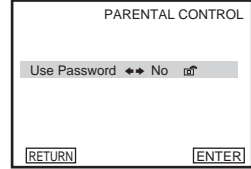

4



Press **▶** to select “Yes.”

- If you have not entered a password
The display for registering a new password appears.
Enter a 4-digit password using the number buttons.
The display for confirming the password appears.
Re-enter the password.

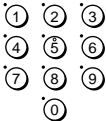

- When you have already registered a password
The display for entering the password appears.
Enter a 4-digit password using the number buttons.

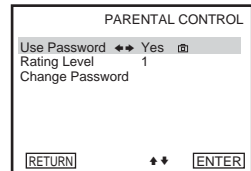
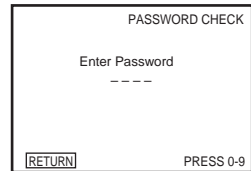
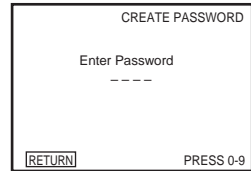

5



Press **▲/▼** to select “Rating Level,” then press **ENTER**.

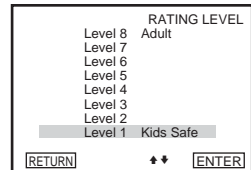

continued

6



Press \uparrow/\downarrow to select the level you want, then press ENTER.

The options are as follows.

Level 8 (Adult) \leftrightarrow Level 7 \leftrightarrow Level 6 \leftrightarrow
Level 5 \leftrightarrow Level 4 \leftrightarrow Level 3 \leftrightarrow Level 2
 \leftrightarrow Level 1 (Kids Safe)

The higher the value, the stricter the limitation.

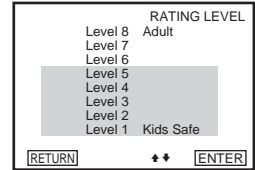

7



RETURN

Press \rightarrow RETURN repeatedly to exit the menu.

To change the password

- 1 Select “Change Password” in step 4.
The display for entering a new password appears.
- 2 Enter a new 4-digit password using the number buttons.
The display for confirming the password appears.
- 3 Re-enter the new password.

To turn off the Parental Control function

Set “Use Password” to “No” in Step 4.

To play a disc for which Parental Control is set

- 1 Insert the disc, then press \triangleright .
The display for entering your password appears.
- 2 Enter your 4-digit password using the number buttons.
The player starts playback.

If you forget your password

- 1 Remove the disc and turn off the DVD-VCR.
- 2 Turn on the DVD-VCR again with no disc in the unit.
- 3 Hold down \lll and \ggg on the front panel simultaneously for 5 seconds.
“reset ok” appears on the screen.
- 4 Turn off the DVD-VCR.
The password is cleared.

Notes

- When you play DVDs which do not have the Parental Control function, playback cannot be limited on this player.
- All the ratings higher than the level you select will be blocked.
- Write your password down and keep it in a safe place in case you forget it.

Using the DVD's menu **DVD**

A DVD is divided into long sections of a picture or a music feature called "titles." When you play a DVD which contains several titles, you can select the title you want using the TOP MENU button.

When you play DVDs that allow you to select items such as the language for the subtitles and the language for the sound, select these items using the MENU button.

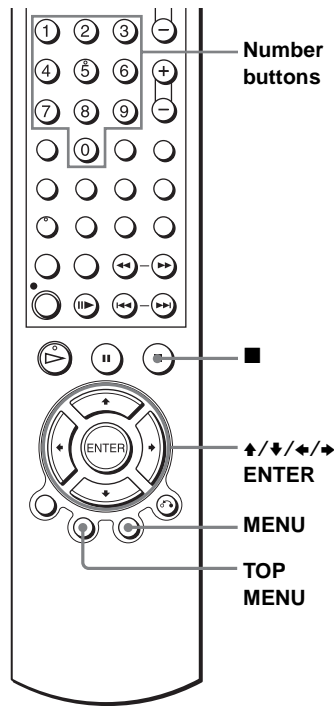

1



Press TOP MENU or MENU.
The disc's menu appears on the TV screen.
The contents of the menu vary from disc to disc.

2



Press $\uparrow/\downarrow/\leftarrow/\rightarrow$ to select the item you want to play or change.
You can also use the number buttons to select the item.

continued

3



Press ENTER.

To turn off the DVD's menu

Press ■.

Note

- Depending on the DVD, you may not be able to use the TOP MENU button.

Zooming into a scene **DVD** **VCD**

You can zoom into a scene during playback or still mode.

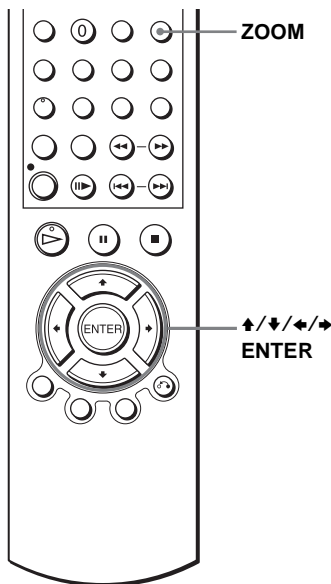

1

MUTING/
ZOOM



Press ZOOM.
“” appears.

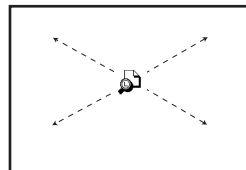

2



Press  to move “” to the position where you want to zoom in.

3



Press ENTER repeatedly to change the magnification.

Each time you press the button, the magnification changes as shown below.

2× → 4× → 2× → normal magnification

Notes

- You cannot use 4× magnification when you play VIDEO CDs.
- The zoom function may not work depending on the DVD.
- You cannot use the zoom function on still images.

Changing the angles **DVD**

If various angles (multi-angles) for a scene are recorded on the DVD, “” appears in the display when you press ANGLE during playback. This means that you can change the viewing angle.

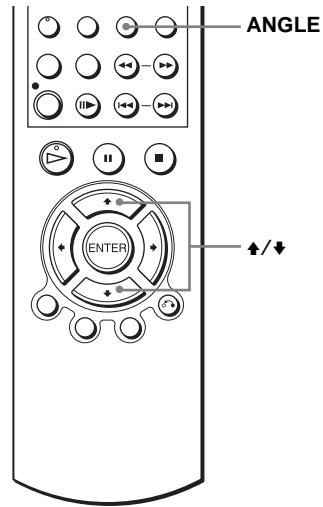

1

ANGLE/
SQPB



Press ANGLE during playback.

The angle number appears on the display.

The number after the slash indicates the total number of angles.

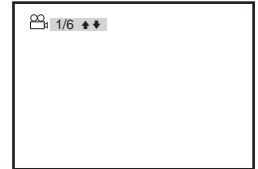

2



Press  repeatedly to select the angle number.

The scene changes to the selected angle.

Note

- Depending on the DVD, you may not be able to change the angles even if multi-angles are recorded on the DVD.

Displaying the subtitle **DVD**

If subtitles are recorded on the disc, you can change the subtitles or turn them on and off whenever you want while playing a DVD.

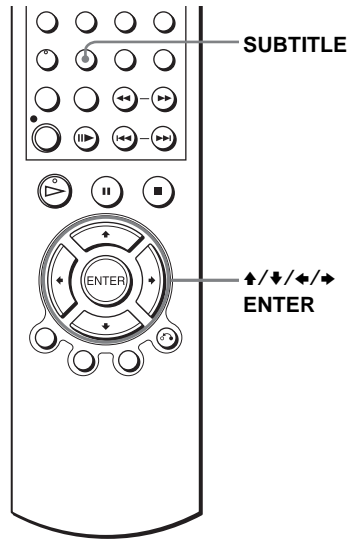

- 1** **SUBTITLE/TIMER** Press SUBTITLE during playback.

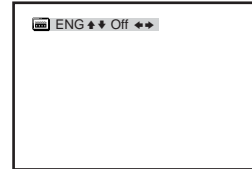

- 2** Press **↑/↓** repeatedly to select the language, then press ENTER.
Depending on the DVD, the choice of language varies.
Refer to "DVD AUDIO/SUBTITLE LANGUAGE" on page 109 for the abbreviation of the language.



- 3** Press **←/→** repeatedly to select "On," then press ENTER.



To turn off the subtitles

Select "Off" in step 3, then press ENTER.

Note

- Depending on the DVD, you may not be able to change the subtitles even if multilingual subtitles are recorded on it. You also may not be able to turn them off.

Picture navigation **DVD**

You can divide the screen into 9 subscreens and display the first scene of each chapter.

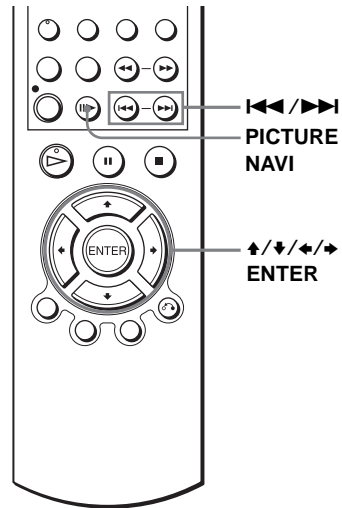

1 PICTURE NAVI/STEP Press PICTURE NAVI during playback.



The 9 subscreens appear.

The scenes represent each of the chapters on the DVD.

The displayed subscreens differ depending on the DVD.

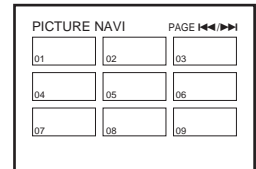

2 Press $\uparrow/\downarrow/\leftarrow/\rightarrow$ repeatedly to select the scene you want, then press ENTER.



You can start playback from the desired chapter.

Notes

- If the DVD has more than 9 chapters, press \lll/\ggg to view the following subscreens.
- The picture navigation function may not work depending on the DVD.
- The picture navigation function does not work with DVD-RW.
- When DTS is selected, you cannot listen to the audio.

Various play mode functions (Programme play, Random play, Repeat play) **DVD** **CD**

You can set the following play modes:

- Programme play (page 69)
- Random play (page 71)
- Repeat play (page 72)

Note

- The play mode is cancelled when:
 - you open the disc tray
 - the player enters standby mode by pressing I/⏻.

Creating your own programme (Programme play) **DVD** **CD**

You can play the contents of a disc in the order you want by arranging the order of the chapters or tracks on the disc to create your own programme. You can programme up to 20 chapters and tracks.

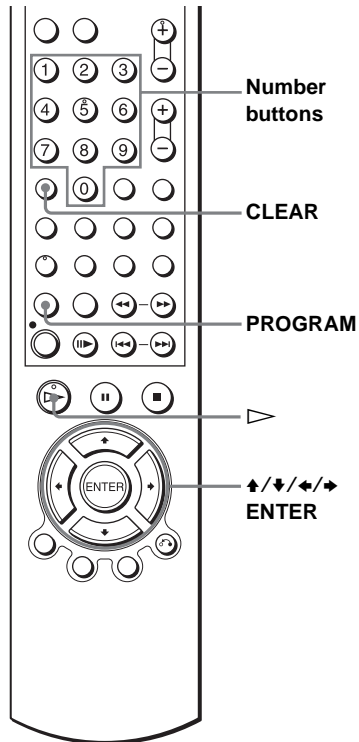

continued

- 1** **REPEAT/
PROGRAM** Press PROGRAM when the DVD player is in stop mode.

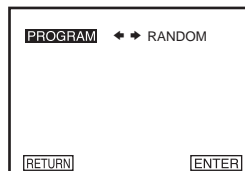

- 2** Press ◀/▶ to select “PROGRAM,” then press ENTER.

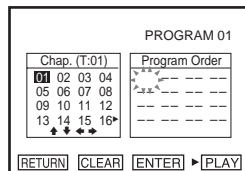

- 3** Press ▲/▼/◀/▶ to select the chapter/track number you want to programme, then press ENTER.



You can also use the number buttons to enter the chapter/track number.

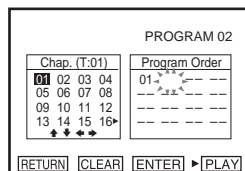
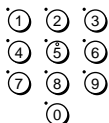

- 4** To programme other chapters/tracks, repeat step 3.

The programmed title, chapter and track numbers are displayed in the selected order.

- 5** Press ▷ to start programme play.

Programme play starts.

When the programme ends, you can restart the same programme again by pressing ▷.

To stop programme play

Press CLEAR during programme play.

To change or cancel a programme

- 1** Follow steps 1 and 2 of “Creating your own programme (Programme play).”
- 2** Press CLEAR.
The last programmed number is cancelled.
- 3** Follow step 3 for new programming.

Playing in random order (Random play) **DVD CD**

You can shuffle the playback order of titles, chapters, or tracks. Subsequent “shuffling” may produce a different playing order.

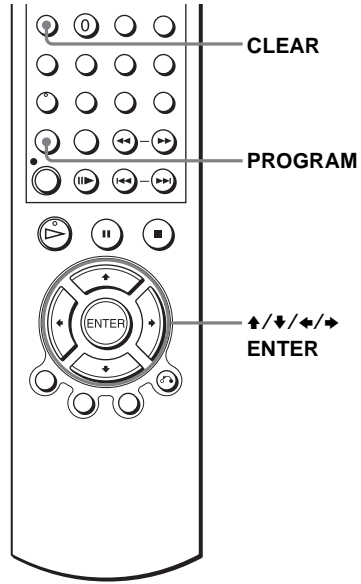

- 1** **REPEAT/PROGRAM** Press PROGRAM when the DVD player is in stop mode.

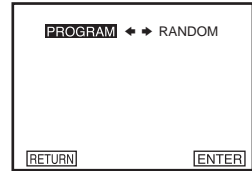

- 2** Press \leftarrow/\rightarrow to select “RANDOM,” then press ENTER.

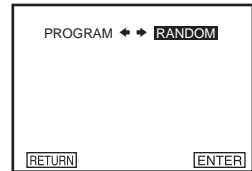

To return to normal play

Press CLEAR during random play.

continued

Playing repeatedly (Repeat play) **DVD** **VCD** **CD** **DATA-CD**

You can play all of the titles or tracks on a disc or a single title, chapter, or track repeatedly.

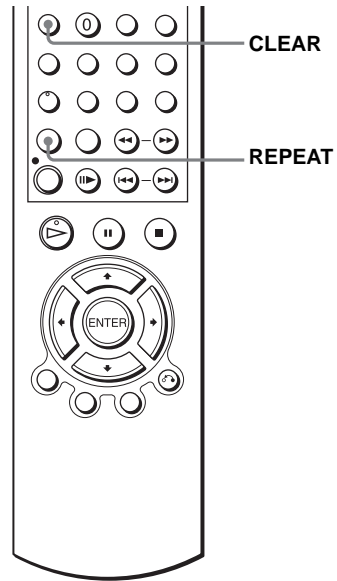

1

REPEAT/
PROGRAM



Press REPEAT during playback.

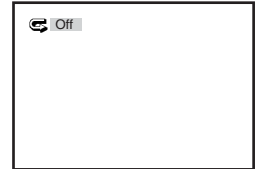

2

REPEAT/
PROGRAM



Press REPEAT repeatedly to select the item to be repeated.

When playing a DVD

- Chapter: repeats the current chapter.
- Title: repeats the current title on a disc.

When playing a VIDEO CD or CD

- Track: repeats the current track.
- Disc: repeats all of the tracks.

When playing a DATA CD (MP3 audio)

- Track: repeats the current track.

To return to normal play

Select "Off" or press CLEAR during repeat play in step 2.

Tip

- When playing a DATA CD, press REPEAT again to cancel repeat play.

Changing the sound **DVD** **VCD** **CD**

When playing a DVD recorded in multiple audio formats (PCM, Dolby Digital, MPEG or DTS), you can change the audio format. If the DVD is recorded with multilingual tracks, you can also change the language.

With CDs, DATA CDs, or VIDEO CDs, you can select the sound from the right or left channel and listen to the sound of the selected channel through both the right and left speakers. For example, when playing a disc containing a song with the vocals on the right channel and the instruments on the left channel, you can hear the instruments from both speakers by selecting the left channel.

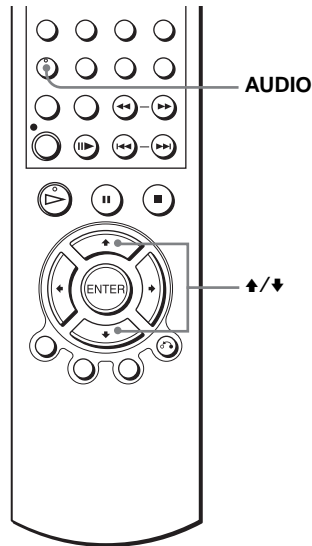

1 **AUDIO** Press **AUDIO** during playback.

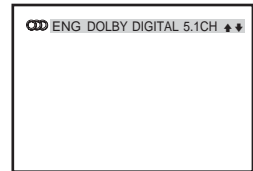

2 Press **↑/↓** repeatedly to select the desired language/audio setting.



- When playing a DVD
Depending on the DVD, the choice of language varies. Refer to “DVD AUDIO/SUBTITLE LANGUAGE” on page 109 for the abbreviation of the language.
- When playing a VIDEO CD, CD, or DATA CD (MP3 audio)
The default setting is indicated in bold print.

STEREO	The standard stereo sound
Left	The sound of the left channel (monaural)
Right	The sound of the right channel (monaural)

Virtual surround setting **DVD** **VCD**

When you connect a stereo TV or 2 front speakers, SURROUND lets you enjoy surround sound effects by using sound imaging to create virtual rear speakers from the sound of the front speakers without using actual rear speakers.

This function is designed to work with the LINE OUT AUDIO L/R jacks.

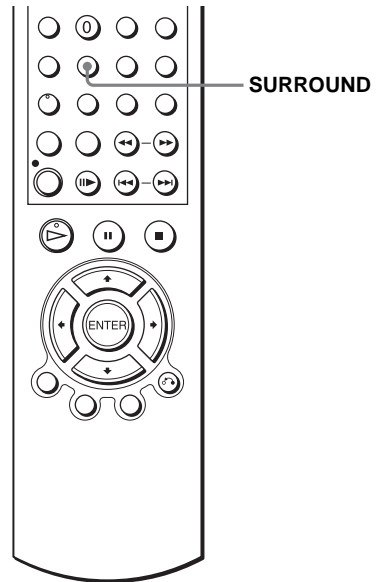

1 SURROUND Press SURROUND during playback.

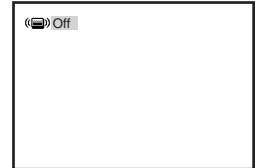

2 SURROUND Press SURROUND repeatedly to select "On."



To cancel the setting

Select "Off" in step 2.

Notes

- Surround effects cannot be obtained for DTS, linear PCM or MP3 audio.
- When the playing signal does not contain a signal for the rear speakers, the surround effects will be difficult to hear.
- When you activate the surround effect, turn off the surround setting of the connected TV or amplifier (receiver).
- Make sure that your listening position is between and at an equal distance from your speakers, and that the speakers are located in similar surroundings.
- If you use the DIGITAL AUDIO OUT (OPTICAL or COAXIAL) jack and set “Dolby Digital” to “Dolby Digital” or “DTS” to “On” in “AUDIO SETUP” menu, sound will come from your speakers but it will not have the surround effect.
- Portions of this product are licensed from Desper Products, Inc., a subsidiary of Spatializer Audio Laboratories, Inc. Copyright ©1997-2001 Spatializer®, N-2-2™, and the circle-in-square device are trademarks of Desper Products, Inc.

Playing an MP3 audio track **DATA-CD**

You can play back DATA CDs (CD-ROMs/ CD-Rs/CD-RWs) recorded in MP3 (MPEG1 Audio Layer 3) format.

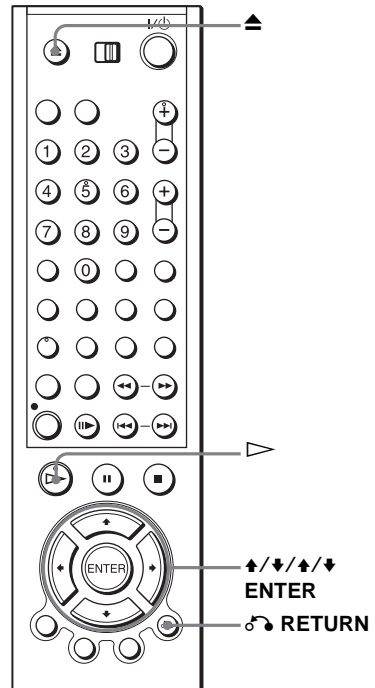

1



Press and place a DATA CD on the disc tray, then press to close the tray.

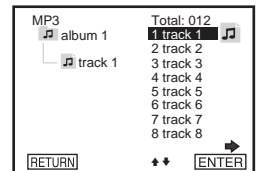

2



Press to select the desired track, then press ENTER.



The selected track starts playing.

When a track or album is being played, its title is shaded.

3

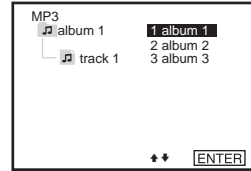
To change the album, press  RETURN.

**4**

Press / to select an album, then press ENTER.

The list of tracks contained in the album appears.

To select a track, repeat step 2.

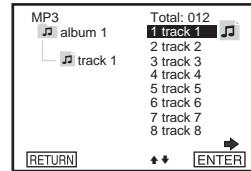

To go to the next or previous page

Press  or .

To return to the previous display

Press  RETURN.

To turn off the display

Press , then press  RETURN.

Notes

- Only the letters in the alphabet and numbers can be used for album or track names. Anything else is displayed as an asterisk.
- Up to 8 alphanumeric characters can be displayed for album or track names.
- ID3 tags cannot be displayed.

About MP3 audio tracks

You can play MP3 audio tracks on CD-ROMs, CD-Rs, or CD-RWs. However, the discs must be recorded according to ISO9660 level 1, level 2, or Joliet format for the player to recognize the tracks.

You can also play discs recorded in Multi Session.

See the instructions of the CD-R/RW device or recording software (not supplied) for details on the recording format.

To play a Multi Session CD

This player can play Multi Session CDs when an MP3 audio track is located in the first session. Any subsequent MP3 audio tracks, recorded in the later sessions, can also be played back. When audio tracks and images in music CD format or video CD format are recorded in the first session, only the first session will be played back.

Notes

- If you put the extension “.MP3” to data not in MP3 format, the player cannot recognize the data properly and will generate a loud noise which could damage your speaker system.
- The player cannot play audio tracks in MP3PRO format.
- This player supports MP3 audio tracks recorded with a bit rate of 128 kbps and a sampling frequency of 44.1 kHz. Attempting to play MP3 audio tracks recorded with different specifications may result in loud noise, sound skipping or speaker damage.
- Depending on the disc, playback may take some time to start.

continued

The Playback order of MP3 audio tracks

The playback order of albums and tracks recorded on a DATA CD is as follows.

- Structure of disc contents

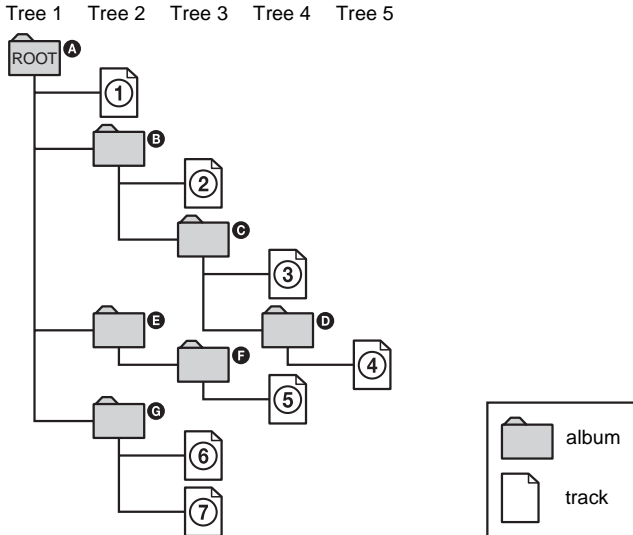

When you insert a DATA CD and press \triangleright , the numbered tracks are played sequentially, from ① through ⑦. Any sub-albums/tracks contained within a currently selected album take priority over the next album in the same tree. (Example: ③ contains ④ so ④ is played before ⑤.)

When you press \curvearrowright RETURN and the list of MP3 albums appears (page 77), the albums are arranged in the following order: A → B → C → D → F → G. Albums that do not contain tracks (such as album E) do not appear in the list.

Tips

- If you add numbers (01, 02, 03, etc.) to the front of the track file names, the tracks will be played in that order.
- Since a disc with many trees takes longer to start playback, place your albums within the first two trees.

Notes

- Depending on the software you use to create the DATA CD, the playback order may differ from the illustration above.
- The playback order above may not be applicable if there are more than a total of 200 albums and tracks in the DATA CD.
- The player can recognize up to 100 albums (the player will count just albums, including albums that do not contain MP3 audio tracks). The player will not play any albums beyond the first 100 albums. Of the first 100 albums, the player will play no more than a combined total of 200 albums and tracks.

Playing VIDEO CDs with “MENU ON/OFF” Functions **VCD**

The PBC (Playback control) function allows you to search and perform other operations interactively. PBC playback follows a selection menu displayed on your TV screen.

The “MENU ON” function is the PBC function.

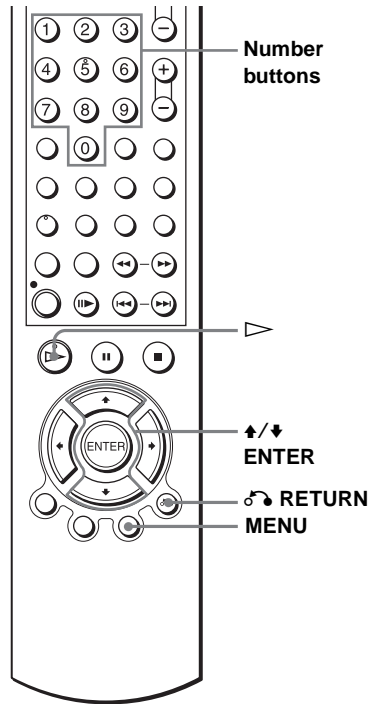

DVD Additional Operations

1 Start playing a VIDEO CD with “MENU ON.”
The menu for your selection appears.

2 Press **↑/↓** to select the item number you want.
You can also use the number buttons to select the item number and track.



continued

3



Press ENTER.

4

Follow the instructions in the menu for interactive operations.

Refer to the instructions supplied with the disc, as the operating procedure may differ depending on the VIDEO CD.

To return to the menu

Press  RETURN.

To play using “MENU OFF”

Press MENU to select “MENU OFF.”

When “MENU OFF” is selected, the DVD player starts continuous play. You cannot play still pictures such as a menu.

To return to “MENU ON,” press MENU to select “MENU ON.”

Note

- Depending on the VIDEO CD, “Press ENTER” in step 3 may appear as “Press SELECT” in the instructions supplied with the disc. In this case, press .

Playing a tape with SQPB function **VHS**

The SQPB(Super VHS Quasi Playback) function is only for playing a Super VHS format tape.

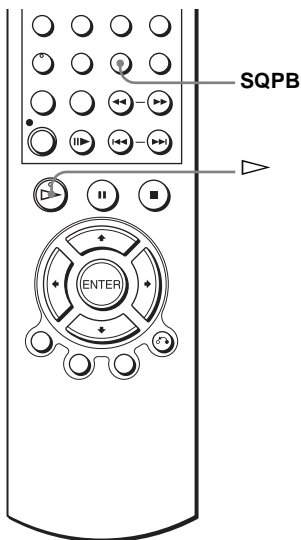

1 Insert a Super VHS format tape.

2  Press .

3  Press SQPB to start SQPB.

Notes

- You cannot use the SQPB function for recording.
- The playback display will be distorted if you use the SQPB function with a normal VHS format tape.
- When you eject the tape, the VCR automatically returns to normal mode.
- Playback of tapes recorded in EP (Extended Play) mode on an NTSC system is not guaranteed.

Setting the recording duration time **VHS**

After you have started recording, you can have the VCR stop recording automatically after a specified duration.

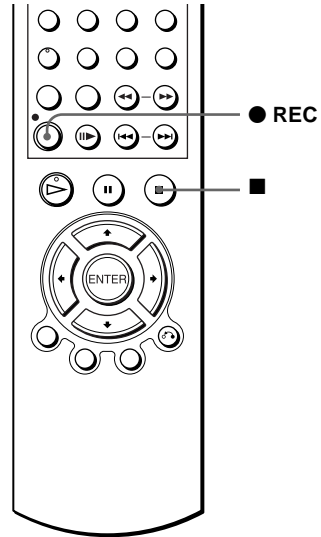

- 1** ●REC While recording, press ● REC.



- 2** ●REC Press ● REC repeatedly to set the duration time.
In SP mode



Each press advances the time in increments of 30 minutes.

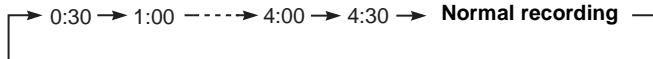

In LP mode

Each press advances the time as shown below.

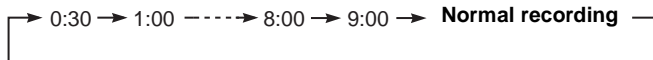

The tape counter decreases minute by minute to 0:00, then the VCR stops recording.

To extend the duration

Press ● REC repeatedly to set a new duration time.

To cancel the duration

Press ● REC repeatedly until the ⊖ indicator disappears and the VCR returns to normal recording mode.

To stop while recording

Press ■.

Note

- You cannot display the current tape time in the display window when setting the recording duration time.

Recording stereo and bilingual programs

VHS

In the NICAM system

This VCR receives and records stereo and bilingual programmes based on the NICAM system (NICAM appears on the TV screen). When a stereo or bilingual programme is received, the STEREO indicator appears in the display window.

To record a NICAM programme, "NICAM" in the "USER SET" menu should be set to ON (initial setting). To check the menu setting, see page 95 for details.

To select the sound while recording

Press AUDIO to select the sound you want.

Stereo programmes

To listen to	On-screen display	Display window
Stereo	NICAM, STEREO	STEREO
Left channel	NICAM, LCH	STEREO
Right channel	NICAM, RCH	STEREO
Left and right channels*	NICAM, LCH + RCH	STEREO

* Usually the mixed sound of left and right channels

Bilingual programmes

To listen to	On-screen display	Display window
Main	NICAM, MAIN	STEREO
Sub	NICAM, SUB	STEREO
Main and sub	NICAM, MAIN/SUB	STEREO
Standard sound*	NICAM, MONO	STEREO

* Usually the main sound (monaural)

Selecting the sound during Hi-fi playback

Press AUDIO to select the sound you want.

To listen to	On-screen display	Display window
Stereo	STEREO	STEREO
Left channel	LCH	STEREO
Right channel	RCH	STEREO
Mix sound*	MIX	STEREO
Mono sound	MONO	No indicator

* The mixed sound of left and right channels, and the normal mono audio track

How sound is recorded on a video tape

The VCR records sound onto two separate tracks. Hi-fi audio is recorded onto the main track along with the picture. Monaural sound is recorded onto the normal audio track along the edge of the tape.

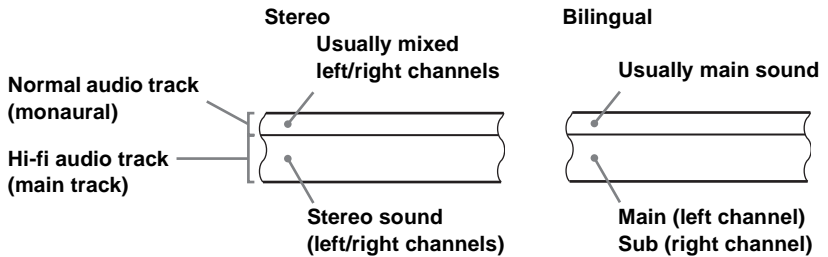

Notes

- To listen to playback sounds in stereo, you must use the Scart or AUDIO OUT connections.
- When you play a tape recorded in monaural, the sound is heard in monaural regardless of the AUDIO setting.

Searching using index function **VHS**

The VCR automatically marks the tape with an index signal at the point where each recording begins. Use these signals as references to find a specific recording.

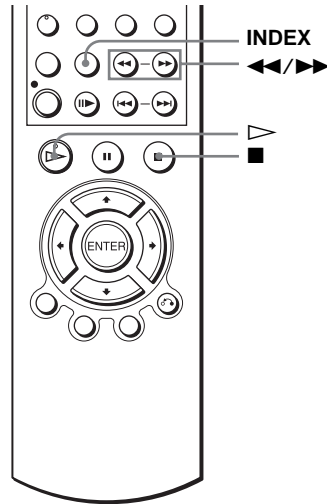

To find a specific recording by scanning (Index scan)

1 Insert an indexed tape into the tape compartment.

2 Press INDEX, then press ◀▶. The VCR starts scanning each recording for five seconds in the corresponding direction.



3 Press ▷ to start playback when you find the desired point.



To search a specific recording (Index search)

1 Insert an indexed tape into the VCR.

2 Press INDEX, then press ◀◀/▶▶ twice.

INDEX



- To search ahead, press ▶▶ twice.

- To search backwards, press ◀◀ twice.



3 Press ◀◀/▶▶ depending on the direction where your desired programme is located.



Each time you press the button, the number increases or decreases up to ± 20 , respectively.



4 The VCR starts searching, and playback starts automatically from that point.

To stop searching

Press ■.

Note

- No index signal will be added when recording starts from recording pause. However, an index signal will be marked if you change the programme position during recording pause.

Adjusting the picture (tracking) **VHS**

Adjusting the tracking

Although the VCR automatically adjusts the tracking when playing a tape, distortion may occur if the recording is in poor condition. In this case, manually adjust the tracking.

During playback, press TRACKING +/- to display the tracking meter. The distortion should disappear as you press one of the two buttons. To resume automatic tracking adjustments, eject the tape and re-insert it.

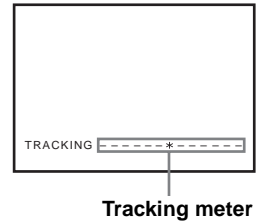

Adjusting the picture sharpness (Smart trilogic)



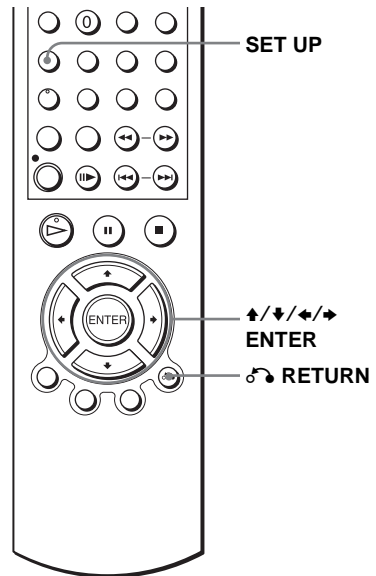

You can automatically adjust the sharpness of the picture.



1

SET UP



During playback, press SET UP, then press /// to select  (USER SET) and press ENTER.



2



Press **▲/▼** to select “SMART TRILOGIC,” then press **➡**.

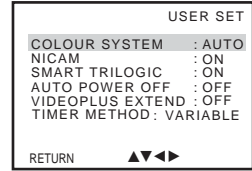

3



Press **▲/▼** to set “SMART TRILOGIC” to “ON” or “OFF.”

- ON: Picture sharpness is automatically adjusted.
- OFF: Adjust the picture sharpness manually.

To soften the picture, press **◀**.

To sharpen the picture, press **▶**.

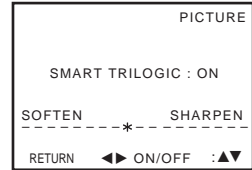

4



RETURN

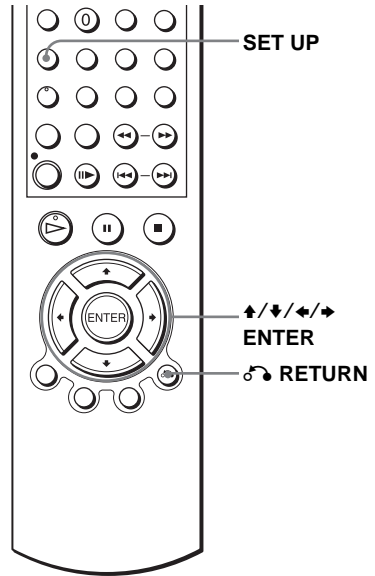

Press **↻** RETURN to return to the original screen.

Changing menu options **VHS**



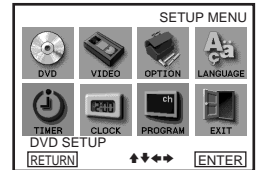

1  Press SET UP when the DVD player is in stop mode.

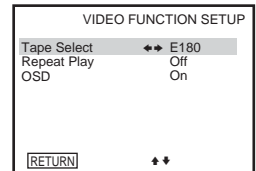

2  Press  (Video Function Setup), then press ENTER. The "VIDEO FUNCTION SETUP" menu appears.



3  Press  to select the option to change.

4

Press to change the setting.

5

RETURN

Press RETURN repeatedly to exit the menu.

Menu choices

The default settings are indicated in bold print.

Menu option	Set this option to
Tape Select	<ul style="list-style-type: none">• E180 to use an E-180 or shorter type tape.• E240 to use an E-240 type tape.• E260 to use an E-260 type tape.• E300 to use an E-300 type tape.
Repeat Play	<ul style="list-style-type: none">• On to play back a tape repeatedly. The VCR rewinds a tape to the beginning and restarts playback automatically.• Off to turn off Auto repeat.
OSD	<ul style="list-style-type: none">• On to display the menu on the TV screen.• Off to disappear the menu from the TV screen.

Editing **VHS**

How to connect to record on this VCR

Connect the line outputs of the other VCR to the input connector of this VCR. Refer to the examples A through C and choose the connection that best suits your VCR.

Example A

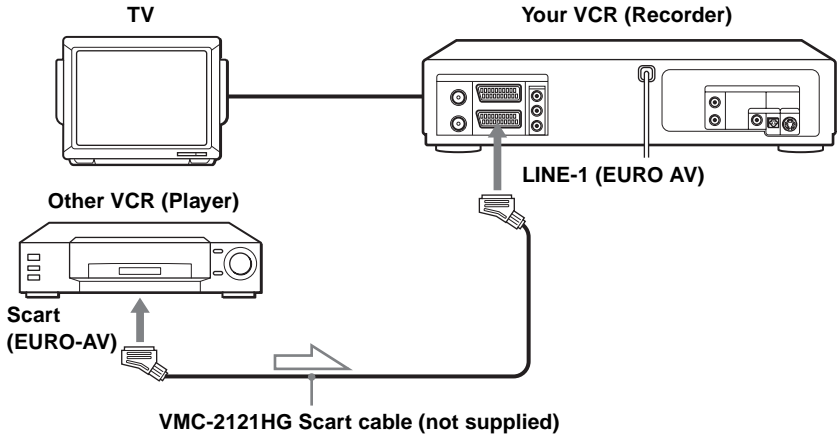



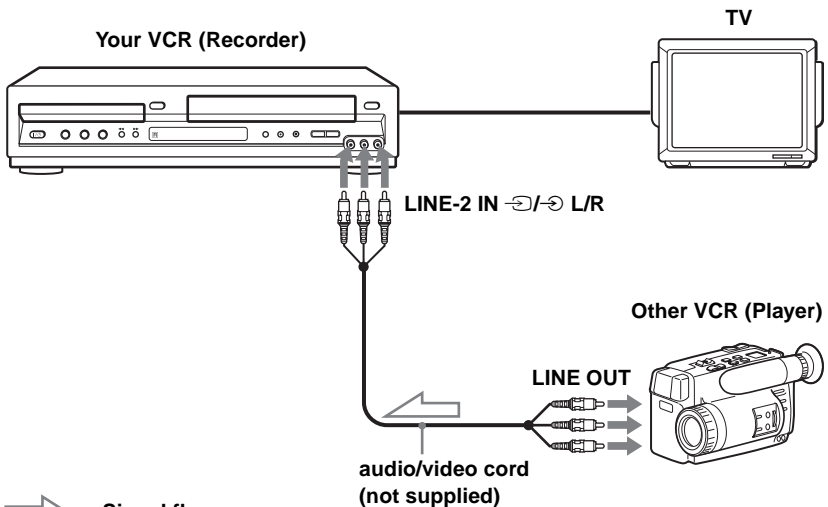

 : Signal flow

Example B



 : Signal flow

-
- 1** Insert a source tape with its safety tab removed into the other (playback) VCR. Search for the point to start playback and set it to playback pause.
-
- 2**  Insert a tape with its safety tab in place into this (recording) VCR. Search for the point to start recording and press **■** to set it to playback pause.
-
- 3**  Press REC  on this VCR to set it to recording pause.
-
- 4**  To start editing, press the **■** buttons on both VCRs at the same time.
-

To stop editing

Press the **■** buttons on both VCRs.

Tip

- To cut out unwanted scenes while editing, press **■** on this VCR when an unwanted scene begins. When it ends, press **■** again to resume recording.

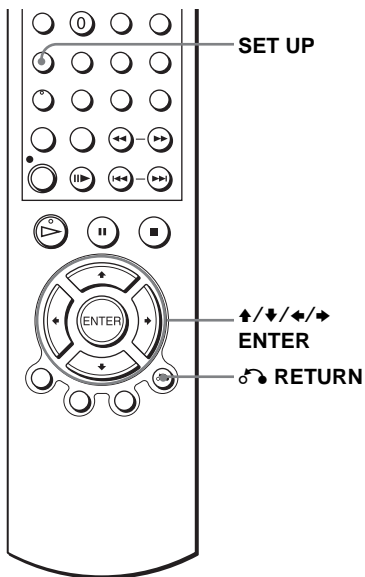

General setup information

Changing setup options



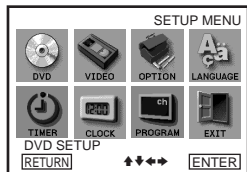

1  Press SET UP when the DVD player is in stop mode.

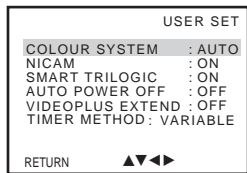

2  Press  to select  (USER SET), then press ENTER. The "USER SET" menu appears.



3  Press  to select the option to change.

continued

4



Press to change the setting.

5



RETURN

Press RETURN repeatedly to exit the menu.

Menu choices

Initial settings are indicated in bold print.

Menu option	Set this option to
COLOUR SYSTEM	<ul style="list-style-type: none"> • AUTO to select the colour system automatically. • PAL to use the tape recorded in the PAL colour system. • B/W to use the tape recorded in black and white.
NICAM	<ul style="list-style-type: none"> • ON to record NICAM broadcasts on the hi-fi audio track. • OFF to record standard sound on the hi-fi audio track. For details, see page 84.
SMART TRILOGIC	<ul style="list-style-type: none"> • ON to automatically adjust the sharpness of the picture. • OFF to manually adjust the sharpness of the picture.
AUTO POWER OFF	<ul style="list-style-type: none"> • OFF to deactivate the Auto Power Off function. • 2HOUR/3HOUR to turn the VCR off automatically if no signal is received and you do not press any of the buttons during this time.
VIDEOPLUS EXTEND	<ul style="list-style-type: none"> • OFF to deactivate the VIDEOPLUS Extend function. • 10/20/30/.../60 (minutes) to extend the time of the VIDEOPLUS setting by the selected amount of time.
TIMER METHOD	<ul style="list-style-type: none"> • VARIABLE to display the "TIMER METHOD" menu for selecting "STANDARD" or "VIDEOPLUS" when pressing the TIMER button. • STANDARD to display the "TIMER PROGRAMMING" menu when pressing the TIMER button. • VIDEOPLUS to display the "VIDEOPLUS" menu when pressing the TIMER button. For details, see pages 38 and 43.

Troubleshooting

If you have any questions or problems not covered below, please consult your nearest Sony service facility.

General Troubleshooting

	Symptom	Remedy
Power	The I/⏻ (on/standby) switch does not function.	<ul style="list-style-type: none"> Connect the mains lead to the mains securely.
	The power is turned on but the DVD-VCR does not operate.	<ul style="list-style-type: none"> Moisture condensation has occurred. Turn the power off, unplug the mains lead and leave the DVD-VCR to dry for over three hours.
Clock	The clock has stopped and "--:--" appears in the display window.	<ul style="list-style-type: none"> The clock stops if the DVD-VCR is disconnected from the mains. Reset the clock (and timer).
Others	The remote commander does not function.	<ul style="list-style-type: none"> Make sure you are pointing the remote commander at the remote sensor on the DVD-VCR. Replace all the batteries in the remote commander with new ones if they are weak. Make sure the TV / DVD-VIDEO switch is set correctly. Select correctly VIDEO or DVD with the SELECT DVD/VIDEO button.
	The tracking meter does not appear on the screen.	<ul style="list-style-type: none"> The recording condition of the tape is very poor and tracking cannot be adjusted.
	You cannot control other TVs.	<ul style="list-style-type: none"> Set your TV's code number. The code number may change when you replace the batteries of the remote commander.

DVD Troubleshooting

	Symptom	Remedy
Picture	There is no picture/picture noise appears.	<ul style="list-style-type: none"> Re-connect the connecting cord securely. The connecting cords are damaged. Check the connection to your TV (page 11) and switch the input selector on your TV so that the signal from the player appears on the TV screen. The disc is dirty or flawed. If the picture output from your player goes through your VCR to get to your TV or if you are connected to a combination TV/VIDEO player, the copy-protection signal applied to some DVD programs could affect picture quality. If you still experience problems even when you connect your player directly to your TV, please try connecting your player to your TV's S VIDEO input (page 51).

continued

	Symptom	Remedy
Picture	Even though you set the aspect ratio in "TV Type" of the "SCREEN SETUP" menu the picture does not fill the screen.	<ul style="list-style-type: none"> The aspect ratio of the disc is fixed on your DVD.
	There is no picture from your VCR connected to the LINE IN jacks.	<ul style="list-style-type: none"> The DVD player must be in standby mode to view pictures from your VCR.
Sound	There is no sound.	<ul style="list-style-type: none"> Re-connect the connecting cord securely. The connecting cord is damaged. The player is connected to the wrong input jack on the amplifier (receiver) (page 49). The amplifier (receiver) input is not correctly set. The player is in pause mode or in Slow-motion Play mode. The player is in fast forward or fast reverse mode. If the audio signal does not come through the DIGITAL AUDIO OUT (OPTICAL or COAXIAL) jack, check the audio settings (pages 49, 50).
	Sound is noisy.	<ul style="list-style-type: none"> When playing a CD with DTS sound tracks, noise will come from the LINE OUT L/R (AUDIO) jacks (page 29) or DIGITAL OUT (OPTICAL or COAXIAL) jack.
	The sound volume is low.	<ul style="list-style-type: none"> The sound volume is low on some DVDs. The sound volume may improve if you set "Audio DRC" to "TV Mode" (page 53).
Operation	The disc does not play.	<ul style="list-style-type: none"> The disc is turned over. Insert the disc with the playback side facing down on the disc tray. The disc is skewed. The player cannot play certain discs (page 6). The region code on the DVD does not match the player. Moisture has condensed inside the player. The player cannot play CD-Rs, CD-RWs, DVD-Rs or DVD-RWs that are not finalized (page 7). Make sure the <u>TV / DVD-VIDEO</u> switch is set correctly. Select correctly VIDEO or DVD with SELECT DVD/VIDEO button.
	The MP3 audio track cannot be played (page 76).	<ul style="list-style-type: none"> The DATA CD is not recorded in the MP3 format that conforms to ISO9660 Level 1/Level 2 or Joliet. The MP3 audio track does not have the extension ".MP3." The data is not formatted in MP3 even though it has the extension ".MP3." The data is not MPEG1 Audio Layer 3 data. The player cannot play audio tracks in MP3PRO format.
	The title of the MP3 audio album or track is not correctly displayed.	<ul style="list-style-type: none"> The player can only display numbers and alphabet. Other characters are displayed as asterisks.
	The disc does not start playing from the beginning.	<ul style="list-style-type: none"> Programme play, random play, or repeat play, has been selected (pages 69, 71, 72). Resume play has taken effect (page 28).
	The player starts playing the disc automatically.	<ul style="list-style-type: none"> The disc features an auto playback function.

	Symptom	Remedy
Operation	Playback stops automatically.	<ul style="list-style-type: none"> While playing discs with an auto pause signal, the player stops playback at the auto pause signal.
	You cannot perform some functions such as stop, search, slow-motion play, repeat play, random play, or programme play.	<ul style="list-style-type: none"> Depending on the disc, you may not be able to do some operations. See the operating manual that comes with the disc.
	The language for the sound track cannot be changed.	<ul style="list-style-type: none"> Try using the DVD's menu instead of the direct selection button on the remote (page 63). Multilingual tracks are not recorded on the DVD being played. The DVD prohibits the changing of the language for the sound track.
	The subtitle language cannot be changed or turned off.	<ul style="list-style-type: none"> Try using the DVD's menu instead of the direct selection button on the remote (page 63). Multilingual subtitles are not recorded on the DVD being played. The DVD prohibits the changing of the subtitles.
	The angles cannot be changed.	<ul style="list-style-type: none"> Try using the DVD's menu instead of the direct selection button on the remote (page 63). Multi-angles are not recorded on the DVD being played. The DVD prohibits changing of the angles.
	The player does not operate properly.	<ul style="list-style-type: none"> When static electricity, etc., causes the player to operate abnormally, unplug the player.

VCR Troubleshooting

	Symptom	Remedy
Playback	The playback picture does not appear on the TV screen.	<ul style="list-style-type: none"> Make sure the TV is set to the channel for the VCR. If you are using a monitor, set it to video input. If the VCR is connected to the TV with the Scart cable, make sure the VIDEO indicator is lit in the display window. Use the TV/VIDEO button on the remote commander to light up the VIDEO indicator.
	The picture is not clear.	<ul style="list-style-type: none"> Existing broadcasts may interfere with the VCR. Reset the RF channel output of your VCR (page 15). Adjust the tracking with the TRACKING +/- buttons. The video heads are dirty (see the last page of Troubleshooting). Clean the video heads using the Sony T-25CLD, E-25CLDR, or T-25CLW video head cleaning cassette. If these cleaning cassettes are not available in your area, have the heads cleaned at your nearest Sony service facility (a standard service charge will be required). Do not use a commercially available liquid type cleaning cassette other than Sony's, as it may damage the video heads. The video heads may have to be replaced. Consult your local Sony service facility for more information.
	The picture rolls vertically during picture search.	<ul style="list-style-type: none"> Adjust the vertical hold control on the TV or monitor.

continued

	Symptom	Remedy
Playback	The picture has no sound.	<ul style="list-style-type: none"> The tape is defective. If you made A/V connections, check the audio cord connection.
	The sound from a tape recorded with the VCR is not in stereo or the STEREO indicator in the display window is flashing.	<ul style="list-style-type: none"> Adjust the tracking. The video heads are dirty. Clean the video heads using the Sony T-25CLD, E-25CLDR, or T-25CLW video head cleaning cassette as explained above.
Recording	No TV programme appears on the TV screen.	<ul style="list-style-type: none"> Make sure the TV is set to the video channel. If you are using a monitor, set it to video input. Existing broadcasts may interfere with the VCR. Reset the RF channel output of your VCR (page 15). Select the correct source with the INPUT SELECT button. Select a programme position when recording TV programmes; select a line input when recording from other equipment.
	TV reception is poor.	<ul style="list-style-type: none"> Make sure the aerial cable is connected securely. Adjust the TV aerial.
	The tape starts playing as soon as it is inserted.	<ul style="list-style-type: none"> The safety tab has been removed. To record on this tape, cover the tab hole.
	The tape is ejected when you press ● REC.	<ul style="list-style-type: none"> The safety tab has been removed. To record on this tape, cover the tab hole.
	Nothing happens when you press ● REC.	<ul style="list-style-type: none"> Make sure the tape is not at its end.
Timer recording	The timer does not operate.	<ul style="list-style-type: none"> Check that the clock is set. Make sure a tape has been inserted. Check that the safety tab has not been removed. Make sure the tape is not at its end. Make sure a programme has been set for timer recording. Make sure your timer settings are past the current time. Check that the decoder is turned on. Check that the satellite tuner is turned on. The clock stops if the DVD-VCR is disconnected from the mains for more than one minute. Reset the clock and timer. Turn the power off and unplug the mains lead.
	The VIDEOPLUS menu or the TIMER PROGRAMMING menu does not appear.	<ul style="list-style-type: none"> Check that TIMER METHOD in the USER SET menu is set correctly (page 95).
	The PDC function does not operate properly.	<ul style="list-style-type: none"> Check that the clock and the date are set correctly. Check that the PDC time you set is the correct one (there might be a mistake in the TV programme guide). If the broadcast you wanted to record did not send the good PDC information, the VCR will not start recording. If the reception is poor, the PDC signal might be altered and the VCR might not start recording.

	Symptom	Remedy
Others	A tape cannot be inserted.	<ul style="list-style-type: none"> • Check that a tape is not already in the tape compartment.
	The selected input line connector number does not appear in the display window.	<ul style="list-style-type: none"> • Press INPUT SELECT to display the connected line.
	The VCR mechanism needs to be cleaned.	<ul style="list-style-type: none"> • Clean the cabinet, panel and controls with a dry, soft cloth, or a soft cloth slightly moistened with a mild detergent solution. Do not use any type of solvent, such as alcohol or benzine.

Symptoms caused by contaminated video heads

• Normal picture



• Rough picture

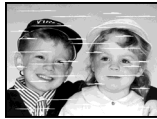

initial
contamination

• Unclear picture



• No picture (or
black & white
screen appears)



terminal



Specifications

System

- Laser
 - Semiconductor laser
- Signal format system
 - PAL/(NTSC)
- Channel coverage
 - PAL (I)
 - UHF B21 to B69
- RF output signal
 - UHF channels 21 to 69
- Aerial out
 - 75-ohm asymmetrical aerial socket
- Tape speed
 - SP: PAL 23.39 mm/s (recording/playback)
 - NTSC 33.35 mm/s (playback only)
 - LP: PAL 11.70 mm/s (recording/playback)
 - NTSC 16.67 mm/s (playback only)
 - EP: NTSC 11.12 mm/s (playback only)
- Maximum recording/playback time
 - 10 hrs. in LP mode (with E300 tape)
- Rewind time
 - Approx. 1 min. (with E180 tape)

Audio characteristics

Frequency response

- DVD VIDEO (PCM 96 kHz): 2 Hz to 44 kHz (± 1.0 dB)/DVD VIDEO (PCM 48 kHz): 2 Hz to 22 kHz (± 0.5 dB)/CD: 2 Hz to 20 kHz (± 0.5 dB)

Signal-to-noise ratio (S/N ratio)

- 100 dB (min.) (DVD LINE OUT L/R (AUDIO) jacks only)

Harmonic distortion

- 0.003 %

Dynamic range

- DVD VIDEO: 103 dB/CD: 99 dB

Wow and flutter

- Less than detected value ($\pm 0.001\%$ W PEAK)

The signals from LINE OUT L/R (AUDIO) jacks are measured. When you play PCM sound tracks with a 96 kHz sampling frequency, the output signals from the DIGITAL OUT (OPTICAL or COAXIAL) jack are converted to 48 kHz sampling frequency.

Inputs and outputs

LINE-1 (EURO AV)

- 21-pin
- Video input: pin 20
- Audio input: pins 2 and 6
- Video output: pin 19
- Audio output: pins 1 and 3

LINE-3

- 21-pin
- Video input: pin 20
- Audio input: pins 2 and 6

LINE-2 IN \rightarrow / \rightarrow L/R

- VIDEO IN, phono jack (1)
- Input signal: 1 V_{p-p}, 75 ohms, unbalanced, sync negative
- AUDIO IN, phono jack (2)
- Input level: 327 mV_{rms}
- Input impedance: more than 47 kilohms

LINE OUT

- VIDEO OUT, phono jack (1)
- Output signal: 1 V_{p-p}, 75 ohms, unbalanced, sync negative
- AUDIO OUT, phono jacks (2)
- Standard output: 327 mV_{rms}
- Load impedance: 47 kilohms
- Output impedance: less than 10 kilohms

LINE OUT (AUDIO)

- Phono jack (2)
- Standard output: 327 mV_{rms}
- Load impedance: 47 kilohms
- Output impedance: less than 10 kilohms

DIGITAL OUT (OPTICAL)

- Optical output jack/-18 dBm (wave length 660 nm)

DIGITAL OUT (COAXIAL)

- Phono jack/0.5 V_{p-p}/75 ohms

LINE OUT (VIDEO)

- Phono jack/1.0 V_{p-p}/75 ohms

S VIDEO OUT

- 4-pin mini DIN/Y: 1.0 V_{p-p}, C: 0.3 V_{p-p} (PAL), 0.286 V_{p-p} (NTSC)/75 ohms

Timer section

Clock

- Quartz locked

Timer indication

- 12-hour cycle

Timer setting

- 8 programs (max.)

General

Power requirements

220 – 240 V AC, 50 Hz

Power consumption

29 W

Operating temperature

5°C to 40°C

Storage temperature

-20°C to 60°C

Dimensions including projecting parts and controls
(w/h/d)

Approx. 430 × 100 × 330 mm

Mass

Approx. 4.5 kg

Supplied accessories

Remote commander (1)

R6 (size AA) batteries (2)

Aerial cable (1)

Audio cord (pinplug ×2 ↔ pinplug ×2) (1)

Video cord (pinplug ×1 ↔ pinplug ×1) (1)

Design and specifications are subject to change without notice.

Index to parts and controls

Refer to the pages indicated in parentheses () for details.

Front panel

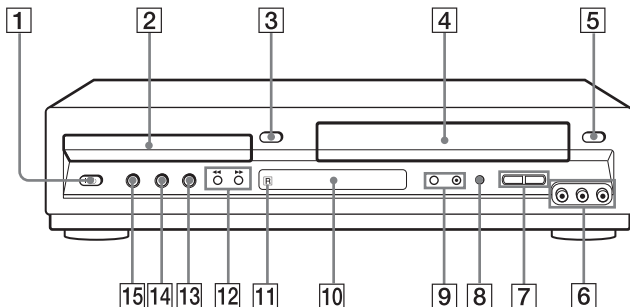

- | | |
|--|--|
| 1 I/⏻ (on/standby) switch (10) (32) | 9 PROGRAM +/- buttons (35) |
| 2 Disc tray (27) | 10 Display window (28) (31) |
| 3 ≡ (open/close) button (27) (28) | 11 📡 Remote sensor |
| 4 Tape compartment (31) | 12 ◀◀ (rewind)/▶▶ (fast-forward) button (28) (32) |
| 5 ≡ (eject) button (32) | 13 ■ (stop) button (28) (32) |
| 6 LINE-2 IN ↻/↻ L/R jacks (92) | 14 (pause) button (28) (32) |
| 7 SELECT DVD/VIDEO (9) | 15 ▷ (play) button (28) (31) |
| 8 ● REC (record) button (35) | |

Display window

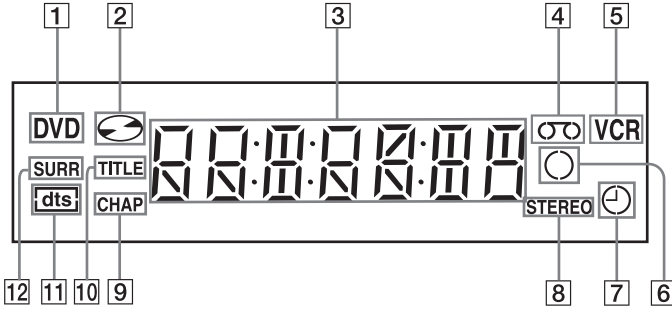

- 1 DVD indicator (28)
- 2 Disc indicator (28)
- 3 Playing time/clock/current status indicator (28)
- 4 Tape indicator (31)
- 5 VCR indicator (31)
- 6 RECORD indicator (35)
- 7 TIMER indicator (40)
- 8 STEREO indicator (84)
- 9 CHAPTER indicator
- 10 TITLE indicator
- 11 DTS indicator (53)
- 12 SURROUND indicator (74)

continued

Rear panel

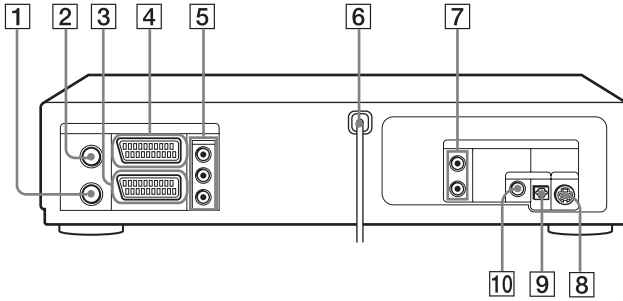

DVD player and VCR

- 1  (out to tv) connector (11)
- 2 Υ (in from aerial) connector (11)
- 3 LINE-1 (EURO AV) connector (12)
- 4 LINE-3 connector (13)
- 5 LINE OUT VIDEO/AUDIO L/R jacks (49)

DVD player only

- 6 Mains lead (11)
- 7 LINE OUT AUDIO L/R jacks (51)
- 8 S VIDEO OUT jacks (51)
- 9 DIGITAL AUDIO OUT jack (OPTICAL) (50)
- 10 DIGITAL AUDIO OUT jack (COAXIAL) (50)

Remote commander for DVD

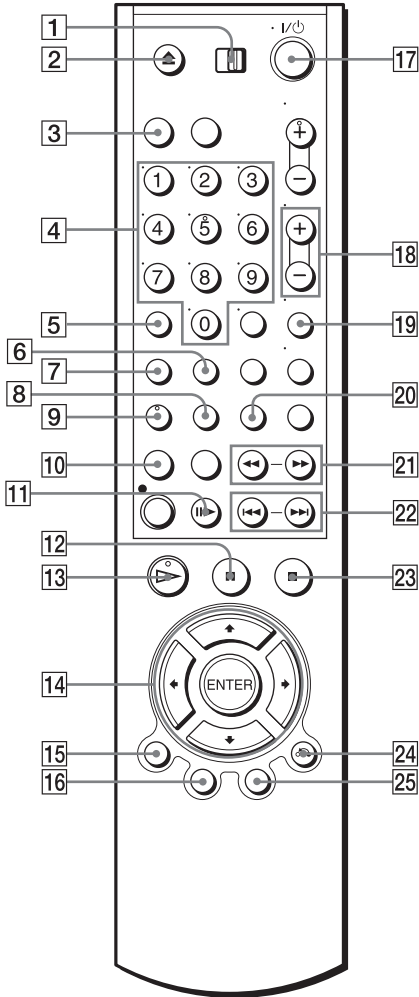

- 1 TV / DVD•VIDEO switch (9)
- 2 (open/close) button (27) (28)
- 3 SELECT DVD button (9)
- 4 Number buttons* (10) (61)
- 5 CLEAR button (70)
- 6 SURROUND button (74)
- 7 SET UP button (15)
- 8 SUBTITLE button (67)
- 9 AUDIO button* (73)
- 10 PROGRAM button (70)
- 11 PICTURE NAVI button (28) (68)
- 12 (pause) button (28)
- 13 (play) button* (28)
- 14 (up/down/left/right) buttons
ENTER button (14)
- 15 DISPLAY button (30) (35)
- 16 TOP MENU button (63)
- 17 I/⏻ (on/standby) switch (10)
- 18 VOL (volume) +/- buttons (10)
- 19 ZOOM button (65)
- 20 ANGLE button (66)
- 21 (left/right) SCAN/SLOW buttons (28)
- 22 (left/right) PREV/NEXT buttons (28)
- 23 (stop) button (28)
- 24 RETURN button (16)
- 25 MENU button (63)

* Number 5, AUDIO and (play) buttons have a tactile dot. Use the tactile dot as a reference when operating the DVD-VCR.

continued

Remote commander for VCR

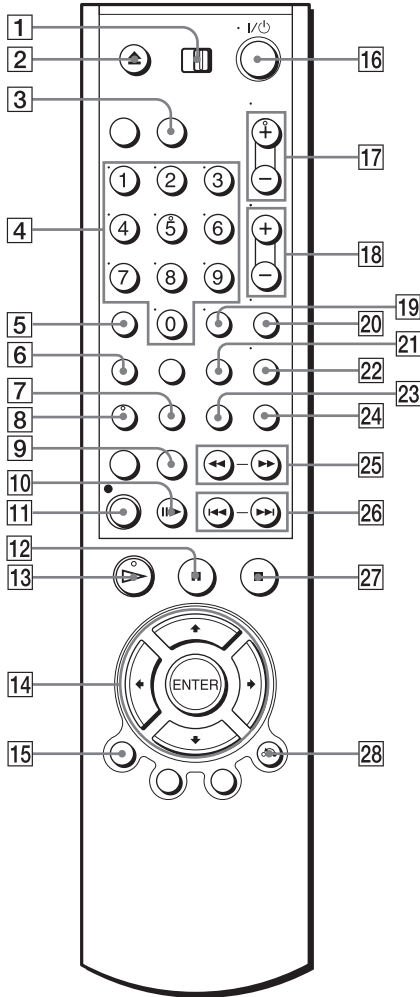

- 1 TV / DVD•VIDEO switch (9)
- 2 ▲ (eject) button (32)
- 3 SELECT VIDEO button (9)
- 4 Number buttons*1 (10)
- 5 CLEAR button (24)
- 6 SET UP button (15)
- 7 TIMER button (44)
- 8 AUDIO*1 button (84)
- 9 INDEX button (86)
- 10 I/⏻ (on/standby) switch (10) (32)
- 11 ● REC (record) button (35)
- 12 ⏸ (pause) button (32)
- 13 ▷ (play) button*1 (31)
- 14 ⬆/⬇/⬅/➡ buttons ENTER button (14)
- 15 DISPLAY button (35)
- 16 I/⏻ (on/standby) switch (10) (32)
- 17 PROG (programme)/TRACKING +/- buttons*2 (33) (35)
- 18 VOL (volume) +/- buttons (10)
- 19 -/- (ten's digit) button (10)
- 20 MUTING button (10)
[for Sony TV only] MUTING button
- 21 SP (Standard Play)/LP (Long Play) button (35)
- 22 TV/VIDEO button (36)
- 23 SQPB button (81)
- 24 INPUT SELECT button (35)
- 25 ◀◀ (rewind)/▶▶ (fast-forward) buttons
SLOW ▶▶ button (32)
- 26 ◀◀/▶▶ SHUTTLE button (32)
- 27 ■ button (32)
- 28 ↶ RETURN button (16)

*1 Number 5, AUDIO and ▷ buttons have a tactile dot. Use the tactile dot as a reference when operating the DVD-VCR.

*2 PROG/TRACKING + button has a tactile dot. Use the tactile dot as a reference.

DVD AUDIO/SUBTITLE LANGUAGE

Language	Abbreviation
Korean	KOR
English	ENG
Chinese	CHI
Japanese	JPN
Russian	RUS
French	FRA
Spanish	ESP
German	DEU
Dutch	NLD
Italian	ITA
Hindi	IND
Arabic	ARA
Danish	DAN
Finish	FIN
Icelandic	ISL
Hebrew	IWR
Norwegian	NOR
Portuguese	POR
Swedish	SVE
Turkish	TUR
Afrikaans	ZAF
Croatian	CRO
Czech	CZK
Greek	GRE
Hungarian	HUN
Indonesian	IDN
Malay	MAL
Polish	POL
Thai	THA
Vietnamese	VIE

Index

Numerics

16:9 56
4:3 Letter Box 56
4:3 Pan Scan 56

A

Adjusting
 picture 88
 tracking 88
Aerial hookup 11
Angle 66
Audio track 85
Auto Clock Set 14
Auto Set Up 14

C

Changing menu option 90
Changing the programme
 position 21
Changing the station name 25
Clock setting 17
Connecting
 the DVD-VCR and your
 TV 11
 to a TV with a Scart
 (EURO-AV) connector 12
 to video equipment 92
Counter 32

D

DATA CD 6, 76
Disabling the programme
 positions 23
DOLBY DIGITAL 49, 73
DTS 50, 73
Dubbing. *see* Editing
DVD 6

E

Editing 92

H

Handling discs 7
Hi-fi audio track 85

I

Index scan 86

L

Language selecting 16
LP mode 35

M

Manual fine tuning 21
Monaural 84
Monitoring
 during playback 84
 during recording 84
MP3 6, 76

N

NICAM broadcasts 84
Normal audio track 85

P

Parental Control 60
PBC (Playback control) 79
PDC (Programme Delivery
Control) 40
Picture adjustment 88
Picture navigation 68
Playback 27, 31
 at various speeds 28, 32
 frame by frame 28, 32
 MP3 audio track 76
 programme play 69
 random play 71
 repeat play 72
 selecting the sound 84
 slow motion 28, 32
 VIDEO CDs 79
Presetting channels 19
Programme play 69

R

Random play 71
Recording
 saving 36
 using the VIDEO Plus+
 system 38
 while watching another
 programme 36, 41, 45
Repeat play 72
RF channel 14, 15

S

Safety tab 36
Scart connection 12
Searching
 at various speeds 28, 32
Smart trilogic 88
SP mode 35
STEREO 73, 84
Subtitle 67

T

Timer setting
 daily/weekly recording 40,
 45
 using the VIDEO Plus+
 system 38
Tracking adjustment. *see*
Adjusting

U

Usable discs 6

V

VIDEO CD 6
VIDEO Plus+
 recording 38

Z

Zoom 65

Free Manuals Download Website

<http://myh66.com>

<http://usermanuals.us>

<http://www.somanuals.com>

<http://www.4manuals.cc>

<http://www.manual-lib.com>

<http://www.404manual.com>

<http://www.luxmanual.com>

<http://aubethermostatmanual.com>

Golf course search by state

<http://golfingnear.com>

Email search by domain

<http://emailbydomain.com>

Auto manuals search

<http://auto.somanuals.com>

TV manuals search

<http://tv.somanuals.com>