

Quick Start Guide



English
PCH-1002 / PCH-1102
PCH-1003 / PCH-1103

Using your PlayStation®Vita system for the first time

To use your PS Vita system, you need the following types of card media:

PlayStation®Vita card
This card contains PlayStation®Vita format software.

3G SCH-1102/1103 Series
SIM card
You need a compatible SIM card to access a mobile network.

Memory card for the PlayStation®Vita system
This card stores applications downloaded from PlayStation®Store, saved data from games, and other content, including your photos and music.

Notices

- Some models of the PS Vita system come with card media included. Refer to the package for content details.
- Some games may require a PS Vita memory card. Refer to the game package or online compatibility notices for details.
- Before you insert or remove a memory card or SIM card, check that the power is off. This helps prevent data corruption or loss.

Rear view of the system

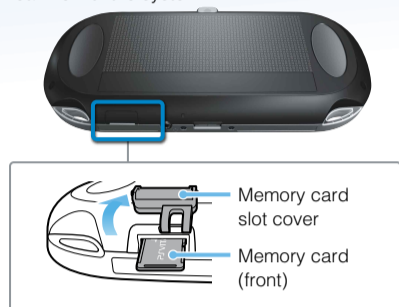

1 Insert the memory card.

Turn your PS Vita system over, open the memory card slot cover, and then insert a memory card.

2 Turn on your PS Vita system.

When turning on your system for the first time, press and hold down the (power) button for five seconds. When the power comes on, the (PS) button will light up blue.
If you need to charge the system, see "Charging" on the back of this guide.

3G PCH-1102/1103 Series

After completing step 1, insert the SIM card.

Rear view of the system

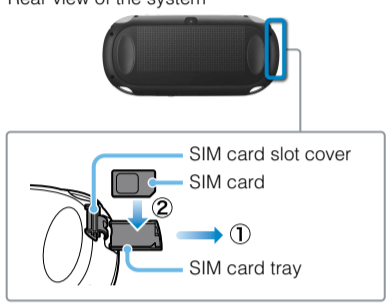

3 Begin to set up your PS Vita system.

To start making initial settings, drag your finger from the top right to the bottom left of the touchscreen (peel the screen) as shown in the figure on the left.

Touchscreen gestures

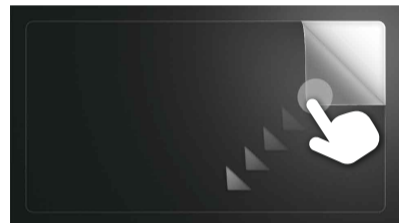

4 Select your language, time zone, and the date and time.

Drag lists of items to scroll and find your choice. Tap an item to select it, and then tap [Next]. To scroll quickly, flick the list of items.



5 Link your Sony Entertainment Network account to your PS Vita system.

If you already have an account
You need an Internet connection to link your Sony Entertainment Network account to your PS Vita system and access PlayStation®Network services. If you cannot connect to the Internet, you must set up your system as explained in "If you do not have an account".

- Tap [Yes, I do], [Use], and then tap [Next].
- Connect to the Internet by selecting an access point on the Wi-Fi settings screen.
- Enter your Sony Entertainment Network account information. Tap the text entry field, and then enter text using the keyboard that appears.

3G PCH-1102/1103 Series

After completing step 4, set up your PS Vita system to use a mobile network.

With a SIM card installed, your PS Vita system connects to a mobile network. Set up the mobile network connection by following the on-screen instructions. If several APN settings are displayed or if a PIN code is required to unlock your SIM card, refer to the SIM card's manual.

To make these settings at a later time, after completing initial setup, tap (Network Operator) on the home screen.

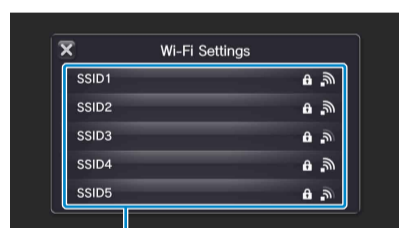

Access points found

3G PCH-1102/1103 Series

Connecting to the Internet using a mobile network

If you cannot connect to a Wi-Fi access point, close the Wi-Fi Settings screen. If the SIM card allows Internet access without additional steps, your system automatically connects to the Internet via the mobile network. Refer to the manual in the SIM package for details.

If a system software update is required after step ②, select [Set Later] and tap [Next]. Follow the on-screen instructions to continue the setup.

Connecting to the Internet

When an Internet connection is required, your system automatically searches for Wi-Fi access points, and then the Wi-Fi settings screen appears. Find a location where you can connect to a Wi-Fi access point. For details about connecting to a Wi-Fi access point, refer to the access point documentation or contact the service provider or person who set it up.

If you do not have an account

Set up your PS Vita system for trial use of PlayStation®Network services. To make full use of PlayStation®Network features, you must sign up for a Sony Entertainment Network account.

- Tap [No, I don't], and then tap [Next]. Follow the on-screen instructions.

6 Complete initial setup.

Tap [OK] to complete initial setup of your PS Vita system. An introductory video will play. If you entered your Sony Entertainment Network account information in step 5, a Sony Entertainment Network sign-in screen appears after the introductory video. Follow the on-screen instructions to sign in.

You can access applications for the PS Vita system from the home screen.

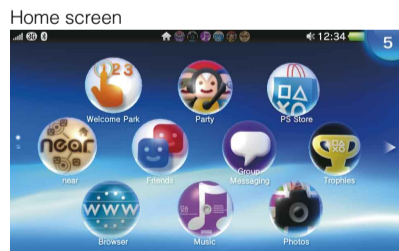

Playing games and learning in Welcome Park

In Welcome Park, have fun playing games while learning the basic features of your PS Vita system.



Digit Chase

Test your touchscreen skills with this number game.



Snap + Slide

Create puzzles from your photos and solve them.



4-408-547-32(1)

PlayStation and PlayStation Store are subject to terms of use and are not available in all countries and languages. See eu.playstation.com/legal for details. A wireless or mobile internet connection is required. Users are responsible for broadband internet connection fees. Users must be 7 years or older and users under 18 require parental consent. Charges apply for some content and/or services. If you are setting up the PS Vita system for a child, please use a sub-account and the parental control features.

"PS VITA" and "LIVEAREA" are registered trademarks of Sony Computer Entertainment Inc. "SONY" and "PS VITA" are registered trademarks of Sony Corporation. "Sony Entertainment Network" is a trademark of the same company.

Design and specifications are subject to change without notice. Information about system functionality and images published in this document may vary from those for your PS Vita system, depending on the system software version in use. Also, the illustrations and screen images used in this guide may vary from the actual product.



Using the screen

When you tap the icon for an application on the home screen, the application's LiveArea™ screen appears. On the LiveArea™ screen, tap the gate to start the application. You can run multiple applications at the same time. The home screen can have a maximum of 10 pages.

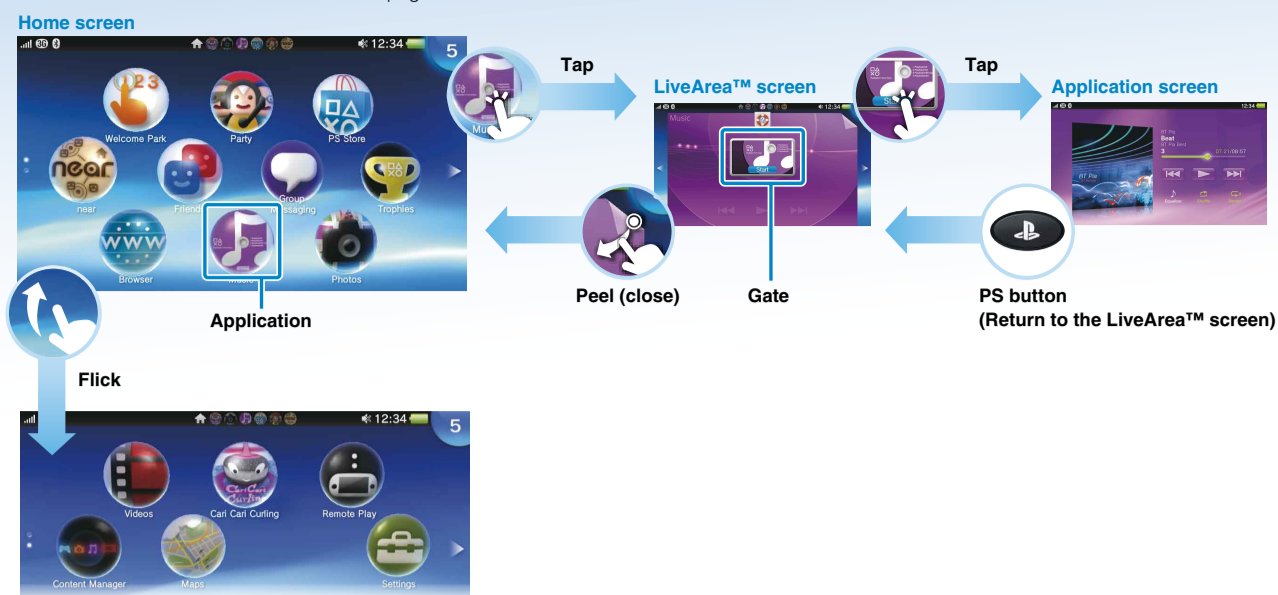

Info bar

You can check the status of your PS Vita system on the top of the home screen.

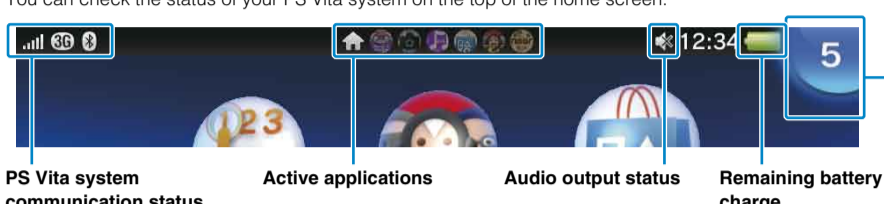

Notification indicator
When a notification or other new information such as a message arrives, the (PS) button blinks slowly in blue. Tap the notification indicator to see the new information.

Customizing the home screen

To enter edit mode, touch and hold somewhere on the home screen.

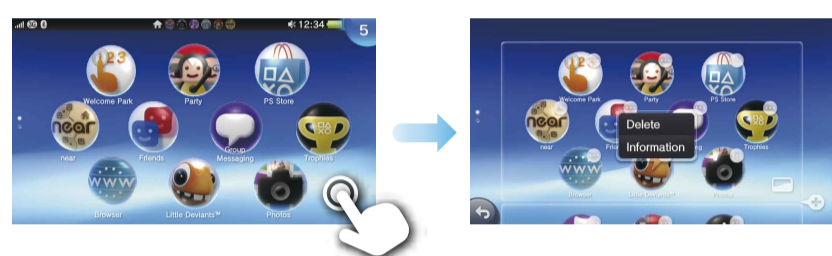

Rearranging icons

Drag each icon you want to move to the desired location and then raise your finger.

Customizing the page background

Tap (Background Settings) in the lower right of the page for which you want to change the background. Choose the background on the screen that appears.

Deleting applications

Tap the icon for the application you want to delete and select [Delete] from the menu. Depending on the application type, all data related to the application may also be deleted.

Playing games

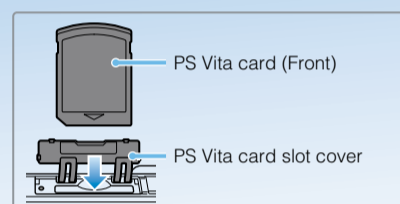

1 Insert the PlayStation®Vita card.

Your PS Vita card contains PS Vita format software. For some games, the PS Vita card also stores saved data and additional content. When the PS Vita card is inserted, the icon for the game appears on the home screen.

Gameplay may require a PS Vita memory card. Insert a memory card before playing games.

Downloading (purchasing) games from PlayStation®Store

PlayStation®Store has a wide variety of content you can't buy anywhere else, such as games, including free trial versions of the latest releases, and game add-ons that make the games you have even more fun to play. To use PlayStation®Store, you need a Sony Entertainment Network account, an Internet connection and a memory card.



2 Start the game.

On the home screen, tap the icon for the game. The LiveArea™ screen for the game appears. If you are connected to the Internet, various details, such as the latest information about the game, appear on the LiveArea™ screen.

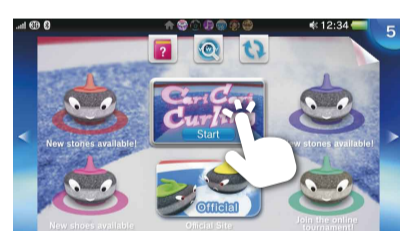

3 Start playing the game.

Tap [Start] on the gate on the LiveArea™ screen.

Saving data for a game

How to save data depends on the game. For details, see the instructions for the game.

If you use the saved data on the memory card or the PS Vita card on a different PS Vita system, there may be times when you cannot earn trophies or save the data. See the User's Guide for details about saved data and trophies.

Pausing a game



Press the (PS) button to pause a game and return to the LiveArea™ screen. To resume playing the game, tap [Continue] on the LiveArea™ screen.

Quitting a game

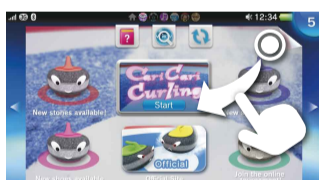

Press the (PS) button to return to the LiveArea™ screen, and then peel the screen.

Removing the PS Vita card

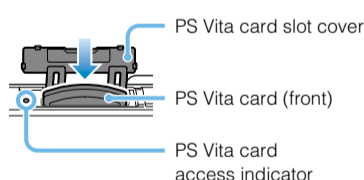

Press on the PS Vita card to release it, and then remove the card. Do not remove the PS Vita card when the access indicator is blinking.

Standby mode and turning off the power completely

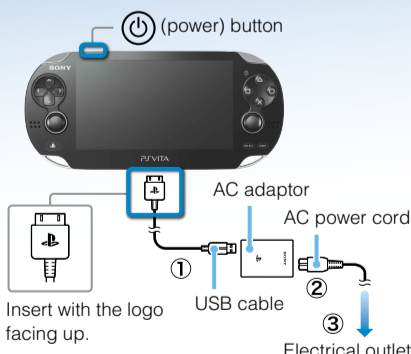

Turning off the screen while the application is still active (standby mode)

Press the (power) button. The (PS) button will blink in blue, and the system will then enter standby mode.

To exit standby mode, press the (power) button again or press the (PS) button.

Turning the power off completely

Press and hold the (power) button for two seconds, and then tap [Power Off]. When turning on the system the next time, press and hold the (power) button for two seconds.

Charging

To charge your PS Vita system, connect it to a power source as shown in the diagram on the left. While the system is charging, the (PS) button lights up orange. When the (PS) button blinks orange during charging, the battery charge is too low to turn on your PS Vita system. Wait until the (PS) button stops blinking and lights up solid orange before turning on your system. If the battery is nearly discharged, it may take up to 30 minutes of charging with the AC Adaptor before the (PS) button turns solid orange. For details including approximate charging times, refer to the User's Guide.

Supporting documentation for your PS Vita system

Safety Guide

Contains precautions for the safe use of your PS Vita system, system specifications, and service information. Before using this product, carefully read the Safety Guide and retain it for future reference.

User's Guide

To read the User's Guide, tap [User's Guide] on the (Settings) LiveArea™ screen. An Internet connection is needed to read the User's Guide.

You can also read the User's Guide by visiting the following website:

eu.playstation.com/psvita/support/manuals/

Support Website

eu.playstation.com/psvita/support/

Visit the Support website for additional information about using your PS Vita system and for answers to technical questions.

System Update Website

eu.playstation.com/psvita/support/system-software/

Visit the System Update website for information about PS Vita system software updates.

Free Manuals Download Website

<http://myh66.com>

<http://usermanuals.us>

<http://www.somanuals.com>

<http://www.4manuals.cc>

<http://www.manual-lib.com>

<http://www.404manual.com>

<http://www.luxmanual.com>

<http://aubethermostatmanual.com>

Golf course search by state

<http://golfingnear.com>

Email search by domain

<http://emailbydomain.com>

Auto manuals search

<http://auto.somanuals.com>

TV manuals search

<http://tv.somanuals.com>