

Wireless Stereo Headset

Operating Instructions
DR-BT100CX



WARNING

To reduce the risk of fire or electric shock, do not expose this apparatus to rain or moisture.

To reduce the risk of electrical shock, do not open the cabinet. Refer servicing to qualified personnel only.

Do not install the appliance in a confined space, such as a bookcase or built-in cabinet.

Do not expose the batteries (battery pack or batteries installed) to excessive heat such as sunshine, fire or the like for a long time.

Excessive sound pressure from headphones can cause hearing loss.

The *Bluetooth* word mark and logos are owned by the Bluetooth SIG, Inc. and any use of such marks by Sony Corporation is under license.

Microsoft, Windows and Windows Vista are registered trademarks or trademarks of Microsoft Corporation in the United States and/or other countries.

Macintosh and Mac OS are trademarks of Apple Inc., registered in the U.S. and other countries.

MPEG Layer-3 audio coding technology and patents licensed from Fraunhofer IIS and Thomson.

Other trademarks and trade names are those of their respective owners.

Notice for customers: the following information is only applicable to equipment sold in countries applying EU directives

The manufacturer of this product is Sony Corporation, 1-7-1 Konan, Minato-ku, Tokyo, Japan. The Authorized Representative for EMC and product safety is Sony Deutschland GmbH, Hedelfinger Strasse 61, 70327 Stuttgart, Germany. For any service or guarantee matters please refer to the addresses given in separate service or guarantee documents.



Hereby, Sony Corp., declares that this equipment is in compliance with the essential requirements and other relevant provisions of Directive 1999/5/EC.

For details, please access the following URL : <http://www.compliance.sony.de/>

Use of this radio equipment is not allowed in the geographical area within a radius of 20 km from the centre of Ny-Alesund, Svalbard in Norway.



**Disposal of Old Electrical & Electronic Equipment
(Applicable in the European Union and other European countries with separate collection systems)**

This symbol on the product or on its packaging indicates that this product shall not be treated as household waste. Instead it shall be handed over to the applicable collection point for the recycling of electrical and electronic equipment. By ensuring this product is disposed of correctly, you will help prevent potential negative consequences for the environment and human health, which could otherwise be caused by inappropriate waste handling of this product. The recycling of materials will help to conserve natural resources. For more detailed information about recycling of this product, please contact your local Civic Office, your household waste disposal service or the shop where you purchased the product.



**Disposal of waste batteries
(applicable in the European Union and other European countries with separate collection systems)**

This symbol on the battery or on the packaging indicates that the battery provided with this product shall not be treated as household waste.

By ensuring these batteries are disposed of correctly, you will help prevent potentially negative consequences for the environment and human health which could otherwise be caused by inappropriate waste handling of the battery. The recycling of the materials will help to conserve natural resources.

In case of products that for safety, performance or data integrity reasons require a permanent connection with an incorporated battery, this battery should be replaced by qualified service staff only.

To ensure that the battery will be treated properly, hand over the product at end-of-life to the applicable collection point for the recycling of electrical and electronic equipment.

For all other batteries, please view the section on how to remove the battery from the product safely. Hand the battery over to the applicable collection point for the recycling of waste batteries.

For more detailed information about recycling of this product or battery, please contact your local Civic Office, your household waste disposal service or the shop where you purchased the product.

Table Of Contents

What is <i>Bluetooth</i> wireless technology?	6
Welcome!.....	7
3 steps to <i>Bluetooth</i> function	8
Location and Function of Parts.....	9
Charging the unit	10
Pairing	12
What is pairing?	12
Procedures of pairing	12
Wearing the unit.....	14
Indications of <i>Bluetooth</i> function	15
Listening to music	16
Controlling the audio device – AVRCP.....	17
Calling.....	19
Controlling the <i>Bluetooth</i> mobile phone – HFP, HSP	21
Calling while playing back music	22
Precautions	23
Troubleshooting.....	25
Common	25
When charging.....	26
When listening to music	26
When calling.....	27
Initializing the unit	27
Specifications.....	28
General	28
Headset.....	29
System requirements for battery charge using USB.....	29

What is *Bluetooth* wireless technology?

Bluetooth[®] wireless technology is a short-range wireless technology that enables wireless data communication between digital devices, such as a computer or digital camera. *Bluetooth* wireless technology operates within a range of about 10 metres. Connecting two devices as necessary is common, but some devices can be connected to multiple devices at the same time.

You do not need to use a cable for connection, nor is it necessary for the devices to face one another, such is the case with infrared technology. For example, you can use such a device in a bag or pocket.

Bluetooth standard is an international standard supported by thousands of companies all over the world, and employed by various companies worldwide.

Communication System and Compatible *Bluetooth* Profiles of this unit

Profile is standardization of the function for each *Bluetooth* device specification. This unit supports the following *Bluetooth* version and profiles:

Communication System :

Bluetooth Specification version 2.1 + EDR^{*1}

Compatible *Bluetooth* Profiles:

- A2DP (Advanced Audio Distribution Profile): Transmitting or receiving audio content of high-quality.
- AVRCP (Audio Video Remote Control Profile): Controlling A/V equipment; pausing, stopping, starting playback, volume control, etc.

- HSP (Headset Profile)^{*2}: Talking on the phone/Operating the phone.
- HFP (Hands-free Profile)^{*2}: Talking on the phone/Operating the phone by hands-free.

^{*1} Enhanced Data Rate

^{*2} When you use a *Bluetooth* mobile phone supported by both HFP (Hands-free Profile) and HSP (Headset Profile), set to HFP.

Notes

- To be able to use the *Bluetooth* function, the *Bluetooth* device to be connected requires the same profile as the unit's. Note also that even if the same profile exists, devices may vary in function depending on their specifications.
- Due to the characteristic of *Bluetooth* wireless technology, the sound played on this unit is slightly delayed from the sound played on the *Bluetooth* device during talking on the telephone or listening to the music.

Welcome!

Thank you for purchasing this Sony Wireless Stereo Headset. This unit uses *Bluetooth* wireless technology.

- Enjoy music wirelessly from *Bluetooth* Stereo-enabled music players and mobile phones.*¹
- Embedded microphone enables hands-free conversation from *Bluetooth*-enabled mobile phone.*²
- Enjoy basic remote control operation (play, stop, etc.) of music player functions via *Bluetooth* connection.*³
- *Bluetooth* version 2.1 + EDR*⁴ for higher quality audio with less interference, lower power consumption and easy connection.
- USB rechargeable function.
- Noise suppression and echo cancellation functions for superior conversation sound quality.

For details on *Bluetooth* wireless technology, see page 6.

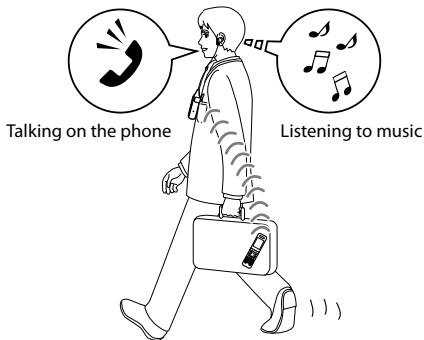

*¹ The connected *Bluetooth* device is required to support A2DP (Advanced Audio Distribution Profile).

*² The connected *Bluetooth* device is required to support HFP (Hands-free Profile) or HSP (Headset Profile).

*³ The connected *Bluetooth* device is required to support AVRCP (Audio Video Remote Control Profile).

*⁴ Enhanced Data Rate

3 steps to *Bluetooth* function

Pairing

First, register (“pair”) a *Bluetooth* device (mobile phone, etc.) and this unit with each other. Once pairing is established, there is no need for pairing again.

Bluetooth
mobile phone,
etc.



Wireless Stereo
Headset

→ Page 12-13

Listening to music

Bluetooth connection

Operate the *Bluetooth* device to make the *Bluetooth* connection.

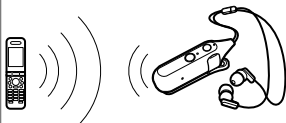

Connection

A2DP

AVRCP

→ Page 16

Calling

Bluetooth connection

When the unit is turned on, the unit starts making the *Bluetooth* connection to the recognized mobile phone automatically.



Connection

HFP

HSP

→ Page 19-20

Listening to music

You can listen to music played on the *Bluetooth* device. Playback, stop, or pause is possible from this unit.

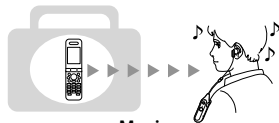

Music

→ Page 17-18

Talking on the phone

You can make and receive a call by operating this unit.

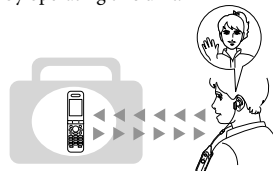

Voice

→ Page 21-22

Location and Function of Parts

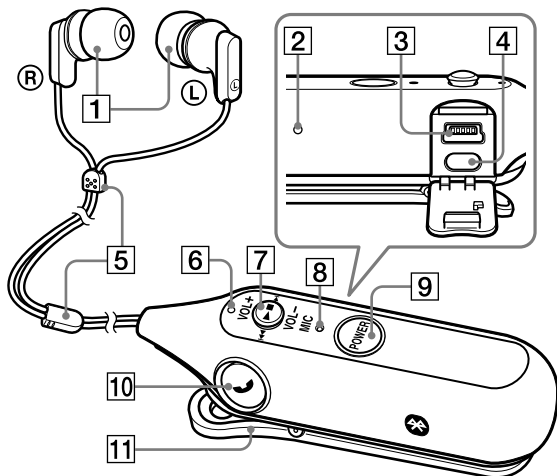

1 Headphones

2 RESET button

3 USB(ψ) jack

4 PAIRING button

5 Cord slider

6 Indicator (blue) (red)

Indicate the communication status (blue) or power status (red) of the unit.

7 Jog switch

Controls various functions when listening to music.
Adjust the volume of this unit when talking over the telephone.

8 Microphone

9 POWER button

10 Multi function button
Controls various call functions.

11 Clip

Charging the unit

The unit contains a rechargeable Lithium-Ion battery, which should be charged before using for the first time.

1 Open the cover of the USB (ψ) jack.

2 Connect the supplied USB (ψ) cable to the unit, and then connect the other end to a computer.

When connecting, insert the connector with ψ facing down.

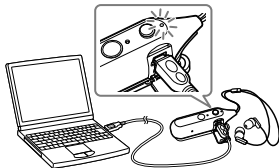

Charging starts when the unit and the computer are connected.

Make sure that the indicator (red) lights up. Charging is completed in about 2.5 hours* and the indicator (red) goes off automatically.

* Time required for empty battery to recharge.

Notes

- If this unit is not used for a long time, the indicator (red) may not light up when you connect the USB cable to charge this unit. In this case, do not disconnect the USB cable from the unit and wait until the indicator (red) lights up.
- When you close the cover of the USB (ψ) jack after charging, push the cover thoroughly until the tab is full inserted.
- For system requirements for a personal computer that can charge the battery using USB, see the “Specifications” (page 29).

Tips

- If the USB cable is connected to a computer while the unit is turned on, the unit will be turned off automatically.
- To charge the unit from an AC outlet, use the USB charging AC power adaptor AC-U50A (sold separately*). For details, refer to the manuals supplied with the USB charging AC power adaptor.
- This unit cannot be turned on while charging.

* The above optional accessory is not provided in some areas.

Caution

If this unit detects a problem while charging, the indicator (red) may turn off, although charging is not complete. Check for the following causes:

- Ambient temperature exceeds the range of 0 °C – 40 °C.
- There is a problem with the battery.

In this case, charge again within the above-mentioned temperature range. If the problem persists, consult your nearest Sony dealer.

Notes

- If the battery is not used for a long time, battery may be quickly depleted, however, after a few recharges, battery life will improve.
- If the life of the built-in rechargeable battery drops to half the normal length, the battery should be replaced. Consult your nearest Sony dealer for replacement of the rechargeable battery.
- Avoid exposure to temperature extremes, direct sunlight, moisture, sand, dust or mechanical shock. Never leave in a car parked in the sun.
- Use only the supplied USB cable. Do not use any other USB cable.
- If the computer enters into hibernation mode while connected to the unit, charging will not be completed properly. Check the setting of the computer before charging. The indicator (red) will go off automatically even if the computer enters into hibernation mode. Charge the unit again in this case.
- Use the supplied USB cable only, and connect directly to a computer. Charging will not be completed properly by an indirect connection, such as via a USB hub.

Usage hours*

Status	Approx. usage hours
Communication time (including music playback time) (up to)	8 hours
Standby time (up to)	120 hours

* Time stated above may vary, depending on ambient temperature or conditions of use.

Checking the remaining battery

When pressing the POWER button while the unit is turned on, the indicator (red) flashes. You can check the remaining battery by the number of times the indicator (red) flashes.

Indicator (red)	Status
3 times	Full
2 times	Mid
1 time	Low (needs to charge)

Note

You cannot check the remaining battery immediately after the unit is turned on, or while pairing.

When the battery is almost empty

Indications of the *Bluetooth* function that are stated by the indicator (blue) changes to the indicator (red). When the battery becomes empty, a beep sounds and the unit will turn off automatically.

Pairing

What is pairing?

Bluetooth devices need to be “paired” with each other beforehand.

Once *Bluetooth* devices are paired, there is no need for pairing again, except in the following cases:

- Pairing information is deleted after repair, etc.
- This unit is paired with 9 or more devices. This unit can be paired with up to 8 devices; if a new device is paired after 8 devices have been paired, the device whose latest connection time is the oldest among the 8 paired devices is replaced by the new one.
- When recognition of the unit by the device to be connected is deleted.
- This unit is initialized (page 27). All pairing information is deleted.

Procedures of pairing

- 1 Place the *Bluetooth* device within 1 m of this unit.**
- 2 Press and hold the PAIRING button for 2 seconds or more to standby for pairing while the unit is turned off.**

The indicator (blue) and indicator (red) flash in turn and the unit enters into pairing mode.

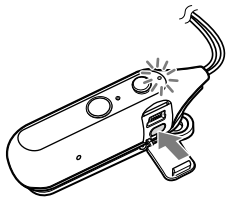

Note

If pairing is not established within about 5 minutes, pairing mode will be cancelled and this unit will turn off. In this case, start over from step 1.

3 Perform pairing procedure on the *Bluetooth* device to detect this unit.

The list of detected devices appears on the display of the *Bluetooth* device. This unit is displayed as “DR-BT100CX.” If “DR-BT100CX” is not displayed, repeat from step 1.

Notes

- For details, refer to the operating instructions supplied with the *Bluetooth* device.
- When pairing with a *Bluetooth* device that cannot display a list of detected devices or that has no display, you may pair the device by setting both this unit and the *Bluetooth* device to pairing mode. At this time, if passcode is set besides “0000” on the *Bluetooth* device, pairing cannot be done with this unit.

4 Select “DR-BT100CX” on the display of the *Bluetooth* device.

5 If Passcode* input is required on the display of a *Bluetooth* device, input “0000.”

Pairing is complete when the indicator (blue) flashes slowly. The message standing for “Pairing complete” appears on the display of some *Bluetooth* devices.

* Passcode may be called “Passkey,” “PIN code,” “PIN number,” or “Password.”

Note

Passcode may be not required depending on the connected *Bluetooth* device. For details, refer to the operating instructions supplied with the *Bluetooth* device.

6 Start the *Bluetooth* connection from the *Bluetooth* device.

This unit memorizes the device as the last connected device. Some *Bluetooth* devices may connect with the unit automatically when pairing is complete.

Tips

- To pair with other *Bluetooth* devices, repeat steps 1 to 5 for each device.
- To delete all pairing information, see “Initializing the unit” (page 27).

Wearing the unit

To use the clip

- 1 **Clip this unit to a pocket, etc., of your clothes and then wear the headphones.**

Wear the earphone marked **L** in your left ear, and the one marked **R** in your right ear.

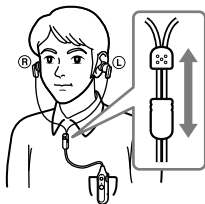

Tip

Move the cord slider to change the split position of the cord, to prevent the headphones coming apart when the unit is not in use.

How to install the earbuds correctly

If the earbuds do not fit your ears correctly, low-bass sound may not be heard. To enjoy better sound quality, change the earbuds to another size, or adjust the earbuds position to sit on your ears comfortably and fit your ears snugly. If the earbuds do not fit your ears, try another size. Confirm the size of the earbuds by checking the colour inside. When you change the earbuds, install them firmly on the headphones to prevent the earbud from detaching and remaining in your ear.

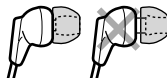
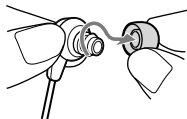

Indications of *Bluetooth* function

B : Indicator (blue)

R : Indicator (red)

Status	Flashing patterns	
Pairing	Searching	B ● — ● — ● — ● — ● — ● — ● — ● — ... R — ● — ● — ● — ● — ● — ● — ● — ● — ...
	Connectable	B ● — — ● — — ● — — ● — — ● — — ● — ... R —
Connecting	Connecting	B ●● — ●● — ●● — ●● — ●● — ●● — ●● — ... R —
	HFP/HSP or A2DP (standby for receiving audio signal)	B ● — — — — — ● — — — — — ... R —
Connected	HFP/HSP and A2DP (standby for receiving audio signal)	B ● — ● — — — — — ● — ● — — — — — ... R —
	Listening	B ●● — — — — — ●● — — — — — ... R —
Music	Listening during standby for telephone call	B ●●● — — — — — ●●● — — — — — ... R —
	Incoming call	B ●●●●● — — — — — ... R —
Phone	Talking	B ●● — — — — — ●● — — — — — ... R —
	Calling while playing back music	B ●●● — — — — — ●●● — — — — — ... R —

Listening to music

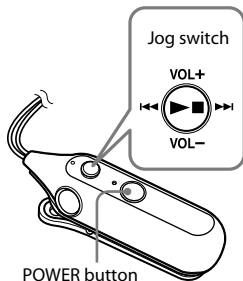

This unit supports SCMS-T content protection. You can enjoy music, etc., from a device such as a mobile phone or portable TV that supports SCMS-T content protection.

Check the following before operating the unit.

- The *Bluetooth* device is turned on.
- Pairing of this unit and the *Bluetooth* device is complete.
- The *Bluetooth* device supports the transmitting music function (profile: A2DP*).

1 Press and hold the POWER button for about 2 seconds while the unit is turned off.

The indicator (blue) flashes twice and the unit is turned on.

Note

After the unit is turned on, the unit attempts to connect to the last connected *Bluetooth* device automatically with HFP or HSP. When not calling with this unit, do not make the last connected *Bluetooth* device ready for HFP or HSP connection. To make or receive a call while playing back music, see page 22.

2 Make the *Bluetooth* connection (A2DP) from a *Bluetooth* device to this unit.

Refer to the operating instructions supplied with the *Bluetooth* device on how to operate it.

3 Start playback on the *Bluetooth* device.

Tip

Bluetooth connection of A2DP (Advanced Audio Distribution Profile) can also be operated with the jog switch from this unit to the *Bluetooth* device except when making a call on this unit.

Notes

- When you play music by connecting the unit to a *Bluetooth* device using HSP (Headset Profile), sound quality will not be high. For better sound, change the *Bluetooth* connection to A2DP by operating the *Bluetooth* device.
- If this unit is turned off while an A2DP *Bluetooth* connection is established, operate the unit again from step 1 to make the A2DP *Bluetooth* connection again.

* For detail on profiles, see page 6.

To adjust the volume

Push the jog switch up or down while listening to music to adjust the volume.

Tips

- Depending on the connected device, it may be necessary to adjust the volume on the connected device as well.
- Volume for calling and listening to music can be adjusted independently. Even if you change the volume while calling, the volume for music playback does not change.

To stop use

1 Terminate the *Bluetooth* connection by operating the *Bluetooth* device.

2 Press and hold the **POWER** button for about 2 seconds.

The indicator (blue) lights up, and the unit turns off.

Tip

When you finish playing music, the *Bluetooth* connection may terminate automatically, depending on the *Bluetooth* device.



Controlling the audio device – AVRCP

If the *Bluetooth* audio device connected with this unit supports AVRCP (Audio Video Remote Control Profile), you can control by using the unit buttons. Refer to the operating instructions supplied with the *Bluetooth* device on how to operate it.

Note



Operation of the *Bluetooth* connecting device by this unit will vary depending on its specification.

Status: In stop or pause mode

	Short Press	Long Press
	①	②
	③	④

- ① Starts playback*¹
- ② Stop
- ③ Skip to next/previous
- ④ Fast-forward/Fast-rewind*²

Status: In play mode

	Short Press	Long Press
	⑤	⑥
	⑦	⑧

- ⑤ Pause*¹
- ⑥ Stop
- ⑦ Skip to next/previous
- ⑧ Fast-forward/Fast-rewind*²

*¹ You may need to press the button twice depending on the *Bluetooth* device.

*² Some *Bluetooth* devices may not operate.

Note

You cannot adjust the volume of the *Bluetooth* device by pushing the jog switch of this unit up or down.

Tip

Depending on the *Bluetooth* device, the fast-forward or fast-rewind operation can be done by performing the following procedures on this unit.

- 1 Press and hold the POWER button for about 2 seconds to turn off the unit.**
- 2 Press and hold the POWER button and jog switch (▶■) for about 7 seconds. The indicator (blue) flashes once. The setting can be released by repeating the above procedures. At this time, the indicator (blue) flashes twice.**

Note

You cannot adjust the volume of the *Bluetooth* device by pushing the jog switch of this unit up or down.

Calling

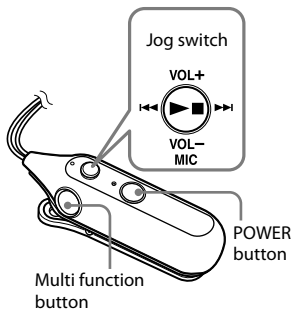

Check the following before operating the unit.

- The *Bluetooth* function is active on the mobile phone.
- Pairing of this unit and the *Bluetooth* mobile phone is complete.

1 Press and hold the **POWER** button for about 2 seconds while the unit is turned off.

The indicator (blue) flashes twice, the unit turns on and then this unit tries to connect to the last *Bluetooth* mobile phone that was used.

Tip

This unit will stop trying to connect to the *Bluetooth* mobile phone after 1 minute. In such a case, press the multi function button to try to connect again.

When this unit does not connect to a *Bluetooth* mobile phone automatically

You can make a connection by operating *Bluetooth* mobile phone or by operating this unit to connect the last connected *Bluetooth* device.

A To make a connection by operating *Bluetooth* mobile phone

1 Make the *Bluetooth* connection (HFP or HSP*) from the *Bluetooth* mobile phone to this unit.

Refer to the manual supplied with your *Bluetooth* mobile phone for operation details.

The list of recognized devices appears on the display of the *Bluetooth* mobile phone. This unit is displayed as "DR-BT100CX."

When you use the *Bluetooth* mobile phone features both HFP (Hands-free Profile) and HSP (Headset Profile), set to HFP.

Note

When connecting to a *Bluetooth* mobile phone which is different from the last connected one, make the connection following the above procedure.

* For details on profiles, see page 6.

B To make a connection with the last connected Bluetooth device by operating this unit

1 Press the multi function button.

The indicator (blue) starts flashing, and the unit performs the connection operation for about 5 seconds.

Note

When listening to music with this unit, a Bluetooth connection cannot be made with the multi function button.

To call

1 Use the buttons on your mobile phone when making a call.

If no dialing tone is heard on this unit, press and hold the multi function button for about 2 seconds.

Tip

You can call in the following way, depending on the Bluetooth mobile phone. Refer to the manual supplied with your mobile phone on operating details.

- When not communicating, you can call using the voice-dial function by pressing the multi function button.
- You can call the last dialed number by pressing the multi function button for about 2 seconds.

To receive a call

When an incoming call arrives, a ring tone will be heard from the unit.

1 Press the multi function button on the unit.

The ring tone differs in the following ways, depending on your mobile phone.

- ring tone set on the unit
- ring tone set on the mobile phone
- ring tone set on the mobile phone only for Bluetooth connection

Note

If you received a call by pressing the button on the Bluetooth mobile phone, some Bluetooth mobile phones may have handset use priority. In this case, set to talk with the unit by pressing and holding the multi function button for about 2 seconds, or by operating the Bluetooth mobile phone. For details, refer to the manual supplied with your Bluetooth mobile phone.

To adjust the volume

Push the jog switch up or down to adjust the volume.

Tips

- You cannot adjust the volume when not communicating.
- Volume for calling and listening to music can be adjusted independently. Even if you change the volume while playing back the music, the volume of a call does not change.

To terminate a call

You can end a call by pressing the multi function button on the unit.

To stop use

1 Terminate Bluetooth connection by the Bluetooth mobile phone.

2 Press and hold the POWER button for about 2 seconds to turn off the power.

The indicator (blue) lights up, and the unit turns off.

Controlling the Bluetooth mobile phone – HFP, HSP

The operation of the buttons on this unit varies depending on your mobile phone.

HFP (Hands-free Profile) or HSP (Headset Profile) is used for *Bluetooth* mobile phone. Refer to the operating instructions supplied with your *Bluetooth* mobile phone on supported *Bluetooth* profiles or how to operate.

HFP (Hands-free Profile)

Status	Multi function button	
	Short Press	Long Press
Standby	Start Voice Dial* ¹	Last number redial
Voice Dial active	Cancel Voice Dial* ¹	—
Outgoing call	End outgoing call	Change call device
Incoming call	Answer	Reject
During call	End call	Change call device

HSP (Headset Profile)

Status	Multi function button	
	Short Press	Long Press
Standby	—	Dial
Outgoing call	End outgoing call* ¹	End outgoing call or change call device to headset* ²
Incoming call	Answer	—
During call	End call* ³	Change call device to headset

- *¹ Some functions may not be supported depending on the *Bluetooth* mobile phone. Refer to the operating instructions supplied with your mobile phone.
- *² This may vary, depending on the *Bluetooth* mobile phone.
- *³ Some functions may not be supported when calling using the *Bluetooth* mobile phone.

Calling while playing back music

The *Bluetooth* connection using HFP or HSP as well as A2DP is necessary to make a call while playing back music.

For example, to make a call using a *Bluetooth* mobile phone while listening to music on a *Bluetooth* compatible music player, this unit needs to be connected to the mobile phone using HFP or HSP.

Make a *Bluetooth* connection between this unit and the device in use following the procedures outlined below.

- 1 Make a *Bluetooth* connection between this unit and the mobile phone in use with HFP or HSP following the procedures outlined in “Calling” (page 19).**
- 2 Operate the *Bluetooth* device (music player or mobile phone) used for playing the music to make a *Bluetooth* connection to this unit using A2DP.**

To make a call while playing back music

- 1 Press the multi function button while playing back music (page 21), or operate your *Bluetooth* mobile phone to make a telephone call.**

If no dialing tone is heard on this unit, press and hold the multi function button for about 2 seconds.

To receive a call while playing back music

When an incoming call arrives, the music pauses and the ring tone is heard from this unit.

- 1 Press the multi function button and talk.**

After finishing the call, press the multi function button. This unit is switched back to music playback.

When no ring tone is heard even if an incoming call arrives

- 1 Stop music playback.**
- 2 When ringing, press the multi function button and talk.**

Precautions

On Bluetooth communication

- *Bluetooth* wireless technology operates within a range of about 10 metres. Maximum communication range may vary depending on obstacles (human body, metal, wall, etc.) or electromagnetic environment.
- The aerial is built into the unit as illustrated in the dotted line. The sensitivity of the *Bluetooth* communication will improve by turning the direction of the built-in aerial to the connected *Bluetooth* device.
The communication distance shortens when the obstacles are between the aerial of the connected device and this unit.

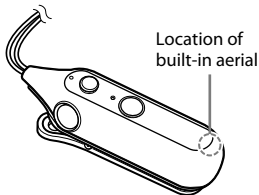

- The following conditions may affect the sensitivity of *Bluetooth* communication.
 - There is an obstacle such as a human body, metal, or wall between this unit and *Bluetooth* device.
 - A device using 2.4 GHz frequency, such as a wireless LAN device, cordless telephone, or microwave oven, is in use near this unit.
- Because *Bluetooth* devices and wireless LAN (IEEE802.11b/g) use the same frequency, microwave interference may occur and resulting in communication speed deterioration, noise, or invalid connection if this unit is used near a wireless LAN device. In such as case, perform the following.
 - Use this unit at least 10 m away from the wireless LAN device.
 - If this unit is used within 10 m of a wireless LAN device, turn off the wireless LAN device.
 - Install this unit and *Bluetooth* device as near to each other as possible.
- Microwaves emitting from a *Bluetooth* device may affect the operation of electronic medical devices. Turn off this unit and other *Bluetooth* devices in the following locations, as it may cause an accident:
 - where inflammable gas is present, in a hospital, train, airplane, or a petrol station
 - near automatic doors or a fire alarm
- This unit supports security capabilities that comply with the *Bluetooth* standard to provide a secure connection when the *Bluetooth* wireless technology is used, but security may not be enough depending on the setting. Be careful when communicating using *Bluetooth* wireless technology.
- We do not take any responsibility for the leakage of information during *Bluetooth* communication.
- Connection with all *Bluetooth* devices cannot be guaranteed.
 - A device featuring *Bluetooth* function is required to conform to the *Bluetooth* standard specified by Bluetooth SIG, Inc. and be authenticated.
 - Even if the connected device conforms to the above mentioned *Bluetooth* standard, some devices may not be connected or work correctly, depending on the features or specifications of the device.
 - While talking on the phone hands free, noise may occur, depending on the device or communication environment.
- Depending on the device to be connected, it may require some time to start communication.

Continued

Note on static electricity

In particularly dry air conditions, mild tingling may be felt on your ears. This is a result of static electricity accumulated in the body, and not a malfunction of the headphones. The effect can be minimized by wearing clothes made from natural materials.

Others

- Do not place this unit in a place exposed to humidity, dust, soot or steam, subject to direct sunlight, or in a car waiting at a traffic signal. It may cause a malfunction.
- Using the *Bluetooth* device may not function on mobile phones, depending on radio wave conditions and location where the equipment is being used.
- If you experience discomfort after using the *Bluetooth* device, stop using the *Bluetooth* device immediately. Should any problem persist, consult your nearest Sony dealer.
- Listening with this unit at high volume may affect your hearing. For traffic safety, do not use this unit while driving or cycling.
- Do not put weight or pressure on this unit as it may cause the unit to deform during long storage.
- Do not subject the headphones to excessive shock.
- Clean the headphones with a soft dry cloth.
- If you have any questions or problems concerning this unit that are not covered in this manual, please consult your nearest Sony dealer.

EP-EX10A is available (sold separately*) as optional replacement earbuds. EP-EX10A offers 4 types of the earbuds: SS, S, M and L.

* The optional accessory is not provided in some areas.

Troubleshooting

If you run into any problems using this unit, use the following checklist and read the product support information on our website.

Should any problem persist, consult your nearest Sony dealer.

Common

The unit is not turned on.

- ➔ Charge the battery of the unit.
- ➔ The unit cannot be turned on while charging. Remove the USB cable from the unit, and then turn on the power.

Pairing cannot be done.

- ➔ Bring this unit and the *Bluetooth* device closer together.

Cannot make the *Bluetooth* connection.

- ➔ Check that this unit is turned on.
- ➔ Check that the *Bluetooth* connecting device is turned on and the *Bluetooth* function is on.
- ➔ Connection with the *Bluetooth* device may not be memorized on this unit. Make the *Bluetooth* connection from the *Bluetooth* device to this unit soon after pairing is complete.
- ➔ This unit or *Bluetooth* connecting device is in sleep mode.
- ➔ The *Bluetooth* connection is terminated. Make the *Bluetooth* connection again (when listening to music: see page 16, when calling: see page 19).

Distorted sound

- ➔ Ensure that this unit is not receiving interference from a wireless LAN, other 2.4 GHz wireless device, or microwave oven.

The correspondence distance is short. (Sound skips.)

- ➔ If a device that generates electromagnetic radiation, such as a wireless LAN, other *Bluetooth* device(s), or a microwave oven is nearby, move away from such sources.
- ➔ Point the aerial of this unit (page 23) towards the *Bluetooth* device. Make sure no obstacles blocks the communication.

The unit does not operate properly.

- ➔ Reset the unit. Pairing information is not deleted by this operation. Insert a small pin, etc., into the hole, and push until you feel a click.

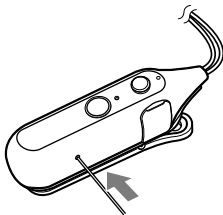

When charging

Charging cannot be done.

- Check that the unit and the computer are firmly connected by the USB cable.
- Check that the computer is turned on.
- Check that the computer is not in standby, sleep or hibernation mode.

Charging time is too long.

- Check that the unit and the computer are directly connected, not via a USB hub.

The unit cannot be recognized by a computer.

- The USB cable is not connected properly to the USB port of the computer. Connect the USB cable again.
- Check that the unit and the computer are directly connected, not via a USB hub.
- A problem may occur with the connected USB port of the computer. Connect to another USB port if it is available.
- Try the USB connection procedure again in cases other than those stated above.

When listening to music

No sound

- *Bluetooth* device are turned on.
- A2DP *Bluetooth* connection is not made between this unit and the *Bluetooth* device. Make an A2DP *Bluetooth* connection (page 16).
- Check that music is being played back by the *Bluetooth* device.
- Check that the volume of the unit is not set too low.
- Turn up the volume on the connected device if necessary.
- Pair this unit and *Bluetooth* device again (page 12).

Low sound level

- Turn up the volume of this unit.
- Turn up the volume on the connected device if necessary.

Low sound quality

- Switch the *Bluetooth* connection to A2DP (Advanced Audio Distribution Profile) when HSP (Headset Profile) is set.

Sound skips frequently during playback.

- Reception condition of this unit may have become unstable due to improper matching of the bit-rate setting for the music transmitted from the *Bluetooth* device and the environment in which this unit is used. *1
Terminate A2DP *Bluetooth* connection by operating the *Bluetooth* device. While this unit is turned on, press and hold  for about 7 seconds to lower the setting of receivable bit rate. *2

*1 Bit rate is a numerical value which represents data transmission volume per second. The higher the bit rate, in general, the better quality the sound will be. This unit can receive high bit rate music but sound skipping may occur depending on the usage environment.

*2 When bit rate setting is completed, the indicator (blue) flashes once. The above operations may not reduce the sound skip depending on the usage environment. To reset to the original setting, press and hold  again for about 7 seconds. The indicator (blue) flashes twice.

When calling

The recipient's voice cannot be heard.

- ➔ Check that both this unit and the *Bluetooth* mobile phone are turned on.
- ➔ Check the connection between this unit and the *Bluetooth* mobile phone. Make a *Bluetooth* connection (HFP or HSP) again (page 19).
- ➔ Check that output of the *Bluetooth* mobile phone is set for this unit.
- ➔ Check that the volume of the unit is not set too low.
- ➔ Turn up the volume on the connected *Bluetooth* mobile phone if necessary.
- ➔ If you are listening to music using this unit, stop playback, press the multi function button and talk.

Low sound from recipient

- ➔ Turn up the volume of this unit.
- ➔ Turn up the volume on the connected *Bluetooth* mobile phone if necessary.

Initializing the unit

You can reset this unit to its default (such as volume setting) and delete all pairing information.

- 1 If this unit is turned on, press and hold the POWER button for about 2 seconds to turn off this unit.**
- 2 Press and hold the POWER button and multi function button together for about 7 seconds.**

The indicator (blue) flashes four times, and this unit is reset to the default setting. All pairing information is deleted.

Specifications

General

Communication System

Bluetooth Specification version 2.1 + EDR (Enhanced Data Rate)

Output

Bluetooth Specification Power Class 2

Maximum communication range

Line of sight approx. 10 m^{*1}

Frequency band

2.4 GHz band (2.4000 GHz – 2.4835 GHz)

Modulation method

FHSS

Compatible Bluetooth Profiles^{*2}

A2DP (Advanced Audio Distribution

Profile)

AVRCP (Audio Video Remote Control

Profile)

HSP (Headset Profile)

HFP (Hands-free Profile)

Supported Codecs^{*3}

SBC^{*4}, MP3

Supported content protection method

SCMS-T

Transmission range (A2DP)

20 - 20,000 Hz (Sampling frequency

44.1 kHz)

Supplied accessories

USB (ψ) cable (1)

Earbuds (S×2, M×2, L×2)

Operating instructions (this book) (1)

Recommended accessories

Spare Earbuds: EP-EX10A (not supplied)^{*5}

USB charging AC power adaptor: AC-U50A (not supplied)^{*5}

^{*1} The actual range will vary depending on factors such as obstacles between devices, magnetic fields around a microwave oven, static electricity, reception sensitivity, aerial's performance, operating system, software application, etc.

^{*2} Bluetooth standard profiles indicate the

purpose of Bluetooth communication between devices.

^{*3} Codec: Audio signal compression and conversion format

^{*4} Subband Codec

^{*5} The optional accessories are not provided in some areas.

Headset

Power source

DC 3.7 V: Built-in lithium-ion rechargeable battery

Dimension (w/h/d) (excluding projection parts and controls)

Approx. 19.5 × 74.0 × 17.5 mm

Cord (from unit to earpiece)

Approx. 0.6 m

Mass

Approx. 26 g (including headphones: 4g)

Rated power consumption

1.3 W

Receiver

Type

Closed, dynamic

Driver unit

9 mm, dome type (CCAW voice coil)

Frequency response

6 – 23,000 Hz

Microphone

Type

Electret condenser

Direction characteristic

Omni directional

Effective frequency range

100 – 4,000 Hz

Operating temperature

0 °C to 45 °C

System requirements for battery charge using USB

Personal Computer with pre-installed with any of the following operating systems and USB port:

Operating Systems

(when using Windows)

Microsoft Windows Vista® Home Basic / Home Premium / Business / Ultimate / Windows® XP Home Edition / Professional / Media Center Edition (Service Pack2 or later) / Media Center Edition 2004 & 2005 (Service Pack2 or later)

(when using Macintosh)

Mac OS X (version.10.3 or later)

Design and specifications are subject to change without notice.

<http://www.sony.net/>

Printed in Thailand

Download from [Www.Somanuals.com](http://www.Somanuals.com). All Manuals Search And Download.

Free Manuals Download Website

<http://myh66.com>

<http://usermanuals.us>

<http://www.somanuals.com>

<http://www.4manuals.cc>

<http://www.manual-lib.com>

<http://www.404manual.com>

<http://www.luxmanual.com>

<http://aubethermostatmanual.com>

Golf course search by state

<http://golfingnear.com>

Email search by domain

<http://emailbydomain.com>

Auto manuals search

<http://auto.somanuals.com>

TV manuals search

<http://tv.somanuals.com>