

■ Home Theatre ■ System

Operating Instructions

HT-SF1300

HT-SS1300

WARNING

To reduce the risk of fire or electric shock, do not expose this apparatus to rain or moisture.

To reduce the risk of fire, do not cover the ventilation opening of the apparatus with newspapers, tablecloths, curtains, etc. Do not place the naked flame sources such as lighted candles on the apparatus.

To reduce the risk of fire or electric shock, do not expose this apparatus to dripping or splashing, and do not place objects filled with liquids, such as vases, on the apparatus.

Do not expose batteries or apparatus with battery-installed to excessive heat such as sunshine, fire or the like.

Do not install the appliance in a confined space, such as a bookcase or built-in cabinet.

As the main plug is used to disconnect the unit from the mains, connect the unit to an easily accessible AC outlet. Should you notice an abnormality in the unit, disconnect the main plug from the AC outlet immediately.

For customers in Europe



Disposal of Old Electrical & Electronic Equipment (Applicable in the European Union and other European countries with separate collection systems)

This symbol on the product or on its packaging indicates that this product shall not be treated as household waste. Instead it shall be handed over to the applicable collection point for the recycling of electrical and electronic equipment. By ensuring this product is disposed of correctly, you will help prevent potential negative consequences for the environment and human health, which could otherwise be caused by inappropriate waste handling of this product. The recycling of materials will help to conserve natural resources. For more detailed information about recycling of this product, please contact your local Civic Office, your household waste disposal service or the shop where you purchased the product.



Disposal of waste batteries (applicable in the European Union and other European countries with separate collection systems)

This symbol on the battery or on the packaging indicates that the battery provided with this product shall not be treated as household waste.

By ensuring these batteries are disposed of correctly, you will help prevent potentially negative consequences for the environment and human health which could otherwise be caused by inappropriate waste handling of the battery. The recycling of the materials will help to conserve natural resources.

In case of products that for safety, performance or data integrity reasons require a permanent connection with an incorporated battery, this battery should be replaced by qualified service staff only. To ensure that the battery will be treated properly, hand over the product at end-of-life to the applicable collection point for the recycling of electrical and electronic equipment.

For all other batteries, please view the section on how to remove the battery from the product safely. Hand the battery over to the applicable collection point for the recycling of waste batteries.

For more detailed information about recycling of this product or battery, please contact your local Civic Office, your household waste disposal service or the shop where you purchased the product.

Notice for the customer in the countries applying EU Directives

The manufacturer of this product is Sony Corporation, 1-7-1 Konan Minato-ku Tokyo, 108-0075 Japan. The Authorized Representative for EMC and product safety is Sony Deutschland GmbH, Hedelfinger Strasse 61, 70327 Stuttgart, Germany. For any service or guarantee matters please refer to the addresses given in separate service or guarantee documents.

About This Manual

- The instructions in this manual are for model HT-SF1300 and HT-SS1300. In this manual, models of area code CEL is used for illustration purposes unless stated otherwise. Any difference in operation is clearly indicated in the text, for example, “Models of area code CEL only”.

The HT-SF1300 consists of:

- Receiver STR-KS1300
- Speaker system^{a)}
 - Front speaker SS-MSP23F
 - Center speaker SS-CNP23
 - Surround speaker SS-SRP23F
 - Subwoofer SS-WP23

The HT-SS1300 consists of:

- Receiver STR-KS1300
- Speaker system^{a)}
 - Front speaker SS-MSP23S
 - Center speaker SS-CNP23
 - Surround speaker SS-SRP23S
 - Subwoofer SS-WP23

^{a)} Be sure to use only the supplied speakers.

- The instructions in this manual describe the controls on the supplied remote. You can also use the controls on the receiver if they have the same or similar names as those on the remote.

About area codes

The area code of the receiver you purchased is shown on the lower portion of the rear panel (see the illustration below).

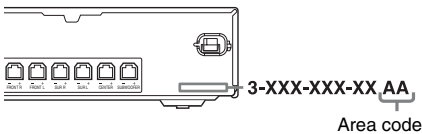

Any differences in operation, according to the area code, are clearly indicated in the text, for example, “Models of area code AA only”.

This receiver incorporates Dolby* Digital and Pro Logic Surround and the DTS** Digital Surround System.

- * Manufactured under license from Dolby Laboratories.
Dolby, Pro Logic and the double-D symbol are trademarks of Dolby Laboratories.
- ** Manufactured under license under U.S. Patent #'s: 5,451,942; 5,956,674; 5,974,380; 5,978,762; 6,487,535 & other U.S. and worldwide patents issued & pending. DTS and DTS Digital Surround are registered trademarks and the DTS logos and Symbol are trademarks of DTS, Inc.
© 1996-2007 DTS, Inc. All Rights Reserved.

This receiver incorporates High-Definition Multimedia Interface (HDMI™) technology. HDMI, the HDMI logo and High-Definition Multimedia Interface are trademarks or registered trademarks of HDMI Licensing LLC.

“x.v.Colour” and “x.v.Colour” logo are trademarks of Sony Corporation.

“BRAVIA” and BRAVIA are trademarks of Sony Corporation.

Table of Contents

Getting Started

Description and location of parts.....	5
1: Installing the speakers	11
2: Connecting the speakers	14
3: Connecting the audio/video components.....	16
4: Connecting the antennas.....	21
5: Preparing the receiver and the remote	22
6: Calibrating the appropriate settings automatically (AUTO CALIBRATION).....	23
7: Adjusting the speaker levels and balance (TEST TONE)	28

Playback

Selecting a component.....	30
Listening/Watching a component	31

Amplifier Operations

Navigating through menus.....	33
Adjusting the level (LEVEL menu).....	37
Adjusting the tone (TONE menu)	38
Settings for the surround sound (SUR menu).....	38
Settings for the tuner (TUNER menu).....	39
Settings for the audio (AUDIO menu).....	39
Settings for the video (VIDEO menu).....	40
Settings for the system (SYSTEM menu).....	41

Enjoying Surround Sound

Enjoying Dolby Digital and DTS Surround sound (AUTO FORMAT DIRECT)	43
Selecting a pre-programmed sound field.....	44
Using only the front speakers and subwoofer (2CH STEREO).....	46
Resetting sound fields to the initial settings.....	46

Tuner Operations

Listening to FM/AM radio.....	47
Presetting radio stations	48
Using the Radio Data System (RDS).....	50

Control for HDMI

Using the Control for HDMI function for “BRAVIA” Sync	52
Preparing Control for HDMI function	54
Watching a DVD (One-Touch Play)	55
Enjoying the TV sound from the speakers connected to the receiver (System Audio Control).....	56
Turning off the receiver with the TV (System Power Off)	57

Other Operations

Switching between digital and analog audio (IN MODE).....	58
Enjoying the DIGITAL MEDIA PORT (DMPORT)	58
Using the Sleep Timer	60

Using the Remote

Changing button assignments	61
-----------------------------------	----

Additional Information

Glossary	62
Precautions	63
Troubleshooting	65
Specifications.....	69
Index	Back cover

Description and location of parts

Receiver

Front panel

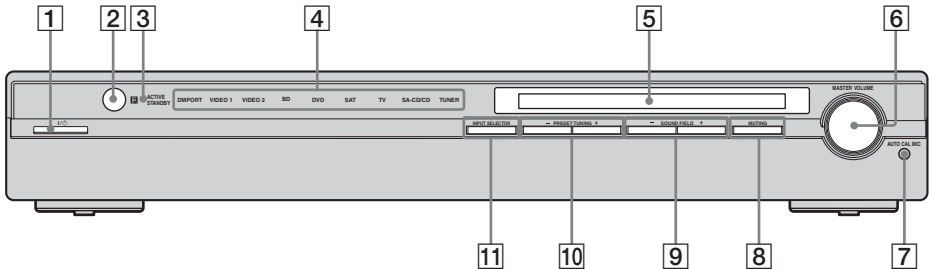

Name	Function
1 I/ON (on/standby)	Press to turn the receiver on or off (page 22, 31, 32).
2 Remote sensor	Receives signals from remote commander.
3 ACTIVE STANDBY lamp	Lights up in amber when the CONTROL FOR HDMI is set to on and the receiver is on standby mode.
4 Input lamps	The lamp of the chosen input source lights up (page 30).
5 Display	The current status of the selected component or a list of selectable items appears here (page 6).
6 MASTER VOLUME	Turn to adjust the volume level of all speakers at the same time (page 29, 30, 31, 32).
7 AUTO CAL MIC jack	Connects to the supplied optimizer microphone for the Auto Calibration function (page 24).

Name	Function
8 MUTING	Press to turn off the sound temporarily. Press MUTING again to restore the sound (page 30).
9 SOUND FIELD +/-	Press to select a sound field (page 43, 44, 46).
10 PRESET TUNING +/-	Press to select a preset station (page 49).
11 INPUT SELECTOR	Press to select the input source to playback (page 30, 31, 32, 47, 48, 49, 65).

About the indicators on the display

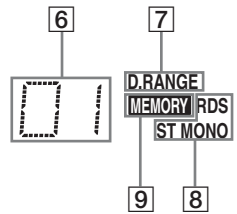
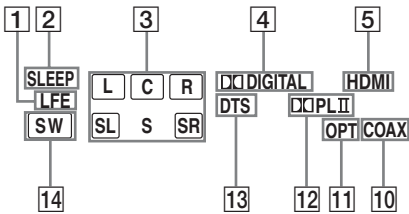

Name	Function
1 LFE	Lights up when the disc being played back contains an LFE (Low Frequency Effect) channel and the LFE channel signal is actually being reproduced.
2 SLEEP	Lights up when the sleep timer is activated (page 60).
3 Playback channel indicators	The letters (L, C, R, etc.) indicate the channels being played back. The boxes around the letters vary to show how the receiver downmixes the source sound. L Front Left R Front Right C Center (monaural) SL Surround Left SR Surround Right S Surround (monaural or the surround components obtained by Pro Logic processing) Example: Recording format (Front/ Surround): 3/2.1 Sound Field: A.F.D. AUTO
4 DIGITAL	Lights up when receiver is decoding Dolby Digital signals. Note When playing a Dolby Digital format disc, be sure that you have made digital connections and that IN MODE is set to "AUTO".
5 HDMI	Lights up when a playback component is connected to this receiver using a HDMI jack (page 17).

Name	Function
6 Preset station indicators	Lights up when using the receiver to tune in radio stations you have preset. For details on presetting radio stations, see page 48.
7 D.RANGE	Lights up when dynamic range compression is activated (page 34).
8 Tuner indicators	Lights up when using the receiver to tune in radio stations (page 47), etc.
9 MEMORY	Lights up when a memory function, such as Preset Memory (page 49), etc., is activated.
10 COAX	Lights up when DVD input is selected and the source signal is a digital signal being input through the COAX IN jack.
11 OPT	Lights up when IN MODE is set to "AUTO" and the source signal is a digital signal being input through the OPT IN jack.
12 DOLBY PL/ DOLBY PLII	"DOLBY PL" lights up when the receiver applies Pro Logic processing to 2 channel signals in order to output the center and surround channel signals. "DOLBY PLII" lights up when the Pro Logic II Movie/Music decoder is activated.
13 DTS	Lights up when the receiver is decoding DTS signals. Note When playing a DTS format disc, be sure that you have made digital connections and that IN MODE is set to "AUTO".
14 SW	Lights up when the audio signal is output from the SUBWOOFER jack.

Rear panel

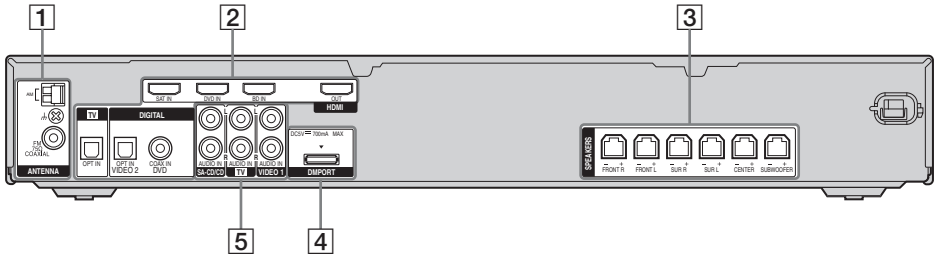



1 ANTENNA section

 **FM ANTENNA jack** Connects to the FM wire antenna supplied with this receiver (page 21).

 **AM ANTENNA terminals** Connects to the AM loop antenna supplied with this receiver (page 21).

2 DIGITAL INPUT/OUTPUT section

 **OPT IN jack** Connects to a DVD player, etc. The COAX IN jack provides a better quality of loud sound (page 19).

 **COAX IN jack**

 **HDMI IN/OUT jack** Connects to a DVD player, Blu-ray disc player, etc. The image is output to a TV or a projector while the sound can be output from a TV or/and speakers connected to this receiver (page 17).

3 SPEAKERS section

 Connects to the supplied speakers and subwoofer (page 14).

4 DMPORT section

 **DMPORT jack** Connects to a DIGITAL MEDIA PORT adapter (page 59).

5 AUDIO INPUT section

 **White (L) AUDIO IN jack** Connects to a Super Audio CD player, CD player, etc. (page 16, 19).

 **Red (R)**

Remote commander

You can use the supplied RM-AAU023 Remote Commander to operate the receiver and to control the Sony audio/video components that the remote is assigned to operate. For details, see “Changing button assignments” (page 61).

RM-AAU023

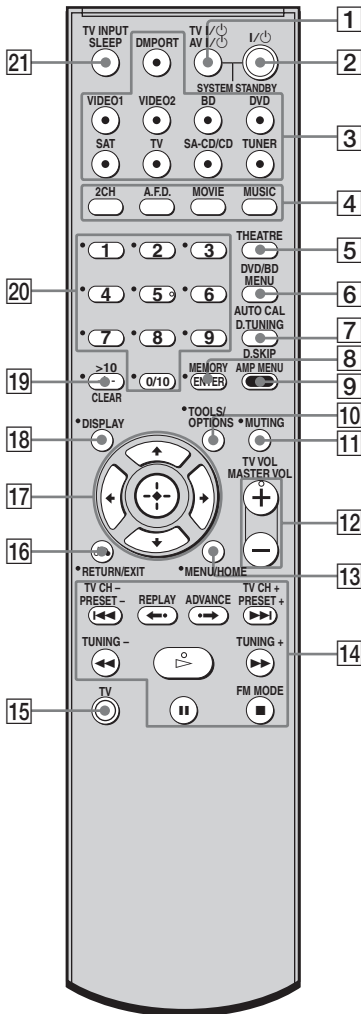











Name	Function
1 TV I/O (on/standby)	Press TV I/O and TV (15) at the same time to turn the TV on or off.
AV I/O (on/standby)	Press to turn on or off the Sony audio/video components that the remote is assigned to operate (page 61). If you press I/O (2) at the same time, it will turn off the receiver and other Sony components (SYSTEM STANDBY). Note The function of the AV I/O switch changes automatically each time you press the input buttons (3).
2 I/O (on/standby)	Press to turn the receiver on or off. To turn off all Sony components, press I/O and AV I/O (1) at the same time (SYSTEM STANDBY).
3 Input buttons	Press one of the buttons to select the component you want to use. When you press any of the input buttons, the receiver turns on. The buttons are factory assigned to control Sony components. You can change the button assignments following the steps in “Changing button assignments” on page 61.
4 2CH A.F.D. MOVIE MUSIC	Press to select a sound field.
5 THEATRE	Press to enjoy optimal image suited for movies and to output the sound from the speakers connected to this receiver automatically. Note This button will only function if your TV is compatible with Theatre Mode. Refer to the operating instructions supplied with the TV for details.

Name	Function
6 DVD/BD MENU	Press to display the menu of the DVD or Blu-ray disc on the TV screen. Then, use ▲ , ▼ , ◀ , ▶ and ⊕ (17) to perform menu operations.
AUTO CAL	Press to activate the Auto Calibration function.
7 D.TUNING	Press to enter direct tuning mode.
D.SKIP	Press to skip a disc when using a multi-disc changer.
8 ENTER	Press to enter the value after selecting a channel, disc or track using the numeric buttons of the TV, VCR or satellite tuner.
MEMORY	Press to store a station.
9 AMP MENU	Press to display the menu of the receiver. Then, use ▲ , ▼ , ◀ , ▶ and ⊕ (17) to perform menu operations.
10 TOOLS/OPTIONS	Press to display and select the options of the DVD player or Blu-ray disc player. Press TOOLS/OPTIONS and TV (15) at the same time to display the options applicable to the Sony TV.
11 MUTING	Press to turn off the sound temporarily. Press MUTING again to restore the sound. Press MUTING and TV (15) at the same time to activate the TV's muting function.
12 TV VOL +^a/-	Press TV VOL +/- and TV (15) at the same time to adjust the volume level of the TV.
MASTER VOL +^a/-	Press to adjust the volume level of all speakers at the same time.

Name	Function
13 MENU/HOME	Press to display the menu of the VCR, DVD player, satellite tuner or Blu-ray disc player on the TV screen. Press MENU/HOME and TV (15) at the same time to display the TV's menu. Then, use ▲ , ▼ , ◀ , ▶ and ⊕ (17) to perform menu operations.
14 ◀◀/▶▶^b	Press to skip a track of the CD player, DVD player or Blu-ray disc player.
REPLAY ◀-/ADVANCE ▶-	Press to replay the previous scene or fast forward the current scene of the VCR, DVD player or Blu-ray disc player.
◀◀/▶▶^b	Press to <ul style="list-style-type: none"> - search tracks in the forward/reverse direction of the DVD player. - start fast forward/rewind of the VCR, CD player or Blu-ray disc player.
▷^a)^b	Press to start playback of the VCR, CD player, DVD player, or Blu-ray disc player.
 ^b	Press to pause playback or recording of the VCR, CD player, DVD player or Blu-ray disc player. (Also starts recording with components in recording standby.)
■^b	Press to stop playback of the VCR, CD player, DVD player or Blu-ray disc player.
TV CH +/-	Press TV CH +/- and TV (15) at the same time to select preset TV channels.
PRESET +/-	Press to select <ul style="list-style-type: none"> - preset stations. - preset channels of the VCR or satellite tuner.
TUNING +/-	Press to scan a station.
FM MODE	Press to select the FM monaural or stereo reception.

continued

Name	Function
15 TV	Press TV and the button with orange printing at the same time to enable TV operation.
16 RETURN/ EXIT 	Press to – return to the previous menu. – exit the menu while the menu or on-screen guide of the VCR, DVD player, satellite tuner or Blu-ray disc player is displayed on the TV screen. Press RETURN/EXIT  and TV (15) at the same time to return to the previous menu or exit the TV's menu while the menu is displayed on the TV screen.
17  ,  , 	After pressing AMP MENU (9), DVD/BD MENU (6), or MENU/HOME (13), press  ,  ,  or  to select the settings. Then, press  to enter the selection if you have pressed DVD/BD MENU or MENU/HOME previously. Press  also to enter the selection of the receiver, VCR, satellite tuner, CD player, DVD player or Blu-ray disc player.
18 DISPLAY	Press to select information displayed on the TV screen of the VCR, satellite tuner, CD player, DVD player or Blu-ray disc player. Press DISPLAY and TV (15) at the same time to display TV's information on the TV screen.
19 -/--	Press to select the channel entry mode, either one or two digit of the VCR. Press -/-- and TV (15) at the same time to select the channel entry mode, either one or two digits of the TV.
>10	Press to select the track numbers over 10 of the CD player.
CLEAR	Press to clear a mistake when you press the incorrect numeric button.

Name	Function
20 Numeric buttons (number 5 ^{a)})	Press to – preset/tune to preset stations. – select track numbers of the CD player, DVD player or Blu-ray disc player. Press 0/10 to select track number 10. – select channel numbers of the VCR or satellite tuner. Press the numeric buttons and TV (15) at the same time to select the TV channels.
21 TV INPUT	Press TV INPUT and TV (15) at the same time to select the input signal (TV input or video input).
SLEEP	Press to activate the Sleep Timer function and the duration which the receiver turns off automatically.

^{a)}The number 5, TV VOL +/MASTER VOL + and  buttons have tactile dots. Use the tactile dots as references when operating the receiver.

^{b)}This button is also available for DIGITAL MEDIA PORT adapter operation. For details on the function of the button, see the operating instructions supplied with the DIGITAL MEDIA PORT adapter.

Notes

- Some functions explained in this section may not work depending on the model.
- The above explanation is intended to serve as an example only. Therefore, depending on the component, the above operation may not be possible or may operate differently than described.

1: Installing the speakers

This receiver allows you to use a 5.1 channel speaker system. To fully enjoy theater-like multi channel surround sound, be sure to connect all the speakers (two front speakers, a center speaker, and two surround speakers) and a subwoofer (5.1 channel).

HT-SF1300 only

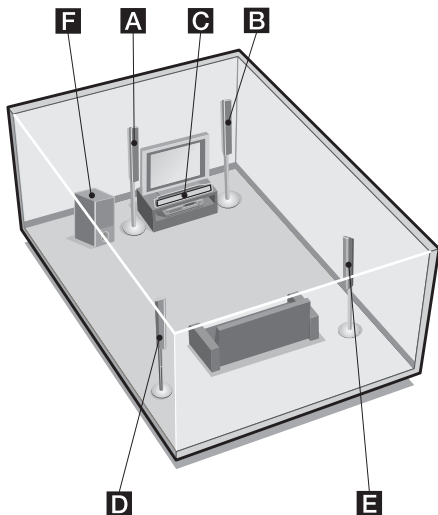

- A** Front speaker (left)
- B** Front speaker (right)
- C** Center speaker
- D** Surround speaker (left)
- E** Surround speaker (right)
- F** Subwoofer

HT-SS1300 only

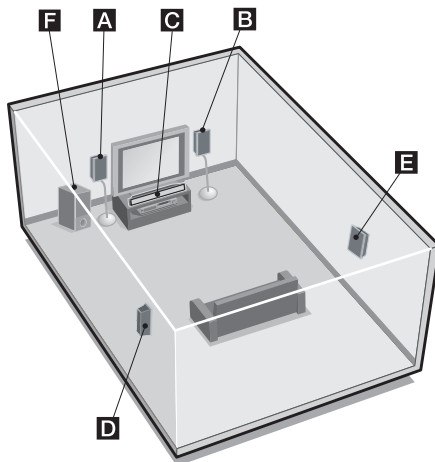

- A** Front speaker (left)
- B** Front speaker (right)
- C** Center speaker
- D** Surround speaker (left)
- E** Surround speaker (right)
- F** Subwoofer

Tip

Since the subwoofer does not emit highly directional signals, you can place it wherever you want.

Installing the speakers on a flat surface

Before you install the speaker and subwoofer, be sure to attach the supplied foot pads to prevent vibration or movement as shown in the illustration below.

Example of HT-SS1300 front speaker

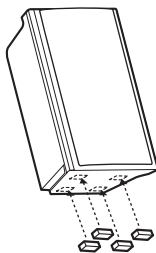

HT-SF1300 only

You need to attach the supplied foot pads to the center speaker and subwoofer only.

HT-SS1300 only

You need to attach the supplied foot pads to all the speakers and subwoofer.

Installing the speakers on the speaker stand

HT-SS1300 only

For greater flexibility in positioning the speakers, use the optional WS-FV11 or WS-FV10D speaker stand (available only in certain countries). For details, refer to operating instructions supplied with the speaker stand.

HT-SF1300 only

For greater flexibility in positioning the speakers, use the supplied speaker stand. For details, refer to supplied speaker stand installation guide.

Installing the speakers on the wall

You can install your speakers on the wall.

- 1 Prepare screws (not supplied) that are suitable for the hook on the back of each speaker. See the illustrations below.**

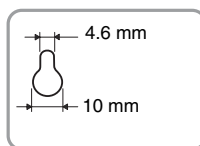
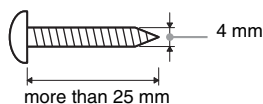

Hook on the back of the speaker

- 2 Fasten the screws to the wall. The screws should protrude 5 to 7 mm.**

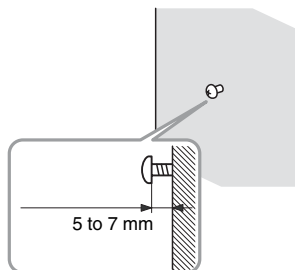

3 Hang the speakers on the screws.

Example of installing the speakers on the wall

Hook on the back of the speaker

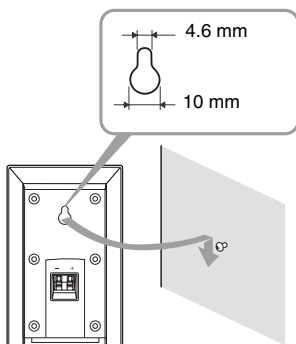

Notes

- Use screws that are suitable for the wall material and strength. As a plaster board wall is especially fragile, attach the screws securely to a beam and fasten them to the wall. Install the speakers on a vertical and flat wall where reinforcement is applied.
- Contact a screw shop or installer regarding the wall material or screws to be used.
- Sony is not responsible for accident or damage caused by improper installation, insufficient wall strength or improper screw installation, natural calamity, etc.
- For HT-SF1300, if you install the speakers on the wall, you do not need to attach the supplied speaker stand.

2: Connecting the speakers

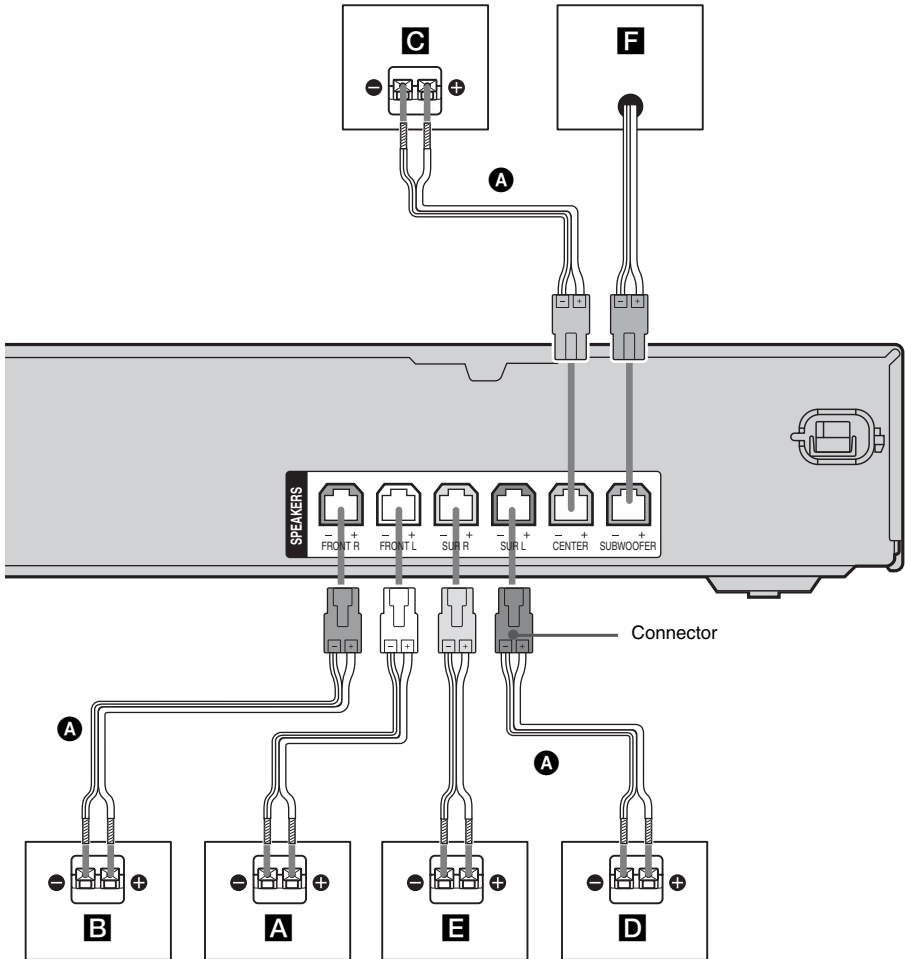

A Speaker cord (supplied)

A Front speaker (left)

B Front speaker (right)

C Center speaker

D Surround speaker (left)

E Surround speaker (right)

F Subwoofer

Note on speaker cords

The connector of the speaker cords are the same color as the speaker jack to be connected. When connecting a speaker cord, be sure to match the colored connector to the speaker jack on the receiver:

Connector	Speaker jack
Red	FRONT R
White	FRONT L
Grey	SUR R
Blue	SUR L
Green	CENTER
Purple	SUBWOOFER

To connect the speakers correctly

Check the speaker type by referring to the speaker label* at the rear panel or bottom of the speakers.

Character on speaker label	Speaker type
L	Front left
R	Front right
SL	Surround left
SR	Surround right

* The center speaker and subwoofer do not have the character on the speaker label. For details on the speaker type, see page 3.

3: Connecting the audio/video components

How to hook up your components

This section describes how to hook up your components to this receiver. Before you begin, refer to “Component to be connected” below for the pages which describe how to connect the audio/video components.

After hooking up all your components, proceed to “4: Connecting the antennas” (page 21).

Component to be connected

To connect	See
Audio components <ul style="list-style-type: none">• Super Audio CD player/CD player	page 16
Components with HDMI jack	page 17
Video components <ul style="list-style-type: none">• TV• DVD player/DVD recorder• VCR	page 19

Connecting the audio components

The following illustration shows how to connect audio components such as Super Audio CD player or CD player.

Before connecting cords, make sure to disconnect the AC power cord (mains lead).

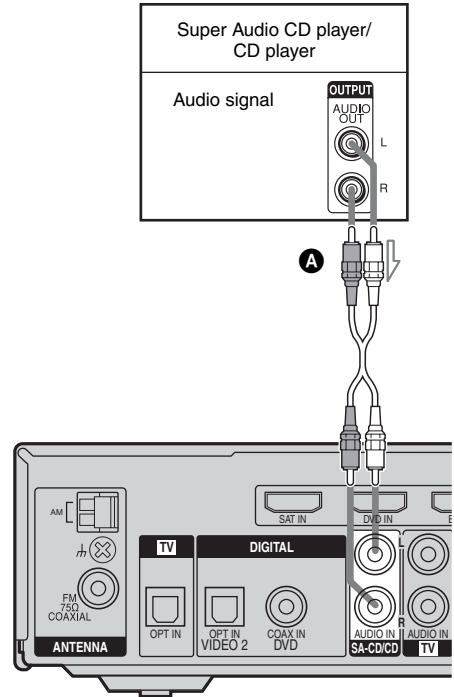

A Audio cord (not supplied)

Connecting components with HDMI jacks

HDMI is the abbreviated name for High-Definition Multimedia Interface. It is an interface which transmits video and audio signals in digital format.

Before connecting cords, make sure to disconnect the AC power cord (mains lead).

Note

Be sure to change the factory setting of the DVD input button on the remote so that you can use the button to control your DVD player. For details, see “Changing button assignments” (page 61).

HDMI feature

- A digital audio signals transmitted by HDMI can be output from the speakers connected to the receiver. This signal supports Dolby Digital, DTS and linear PCM.
- This receiver supports xvYCC transmission.
- This receiver supports the Control for HDMI function. For details, see “Control for HDMI” (page 52).

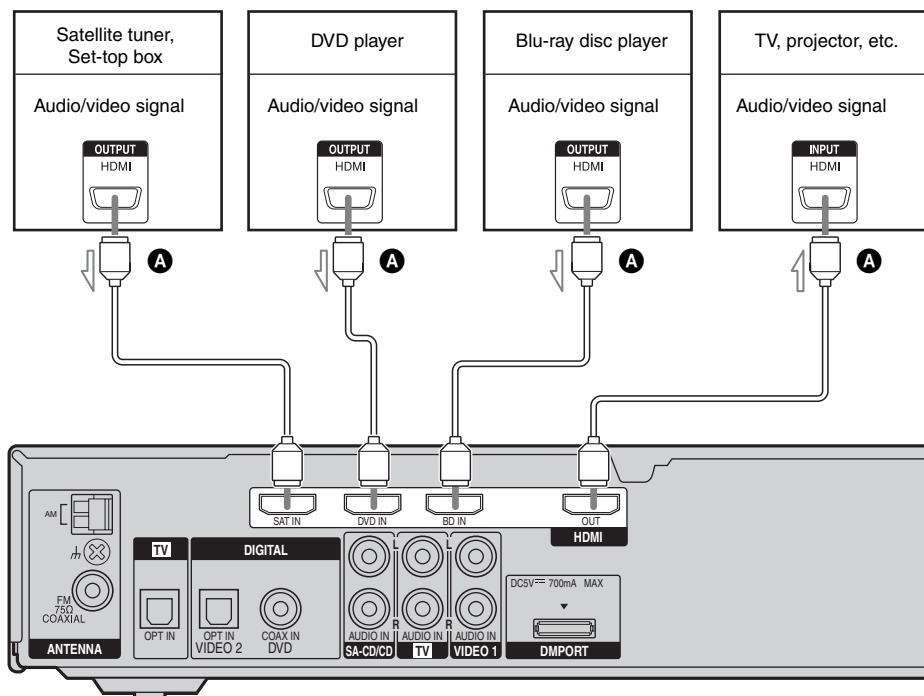

A HDMI cable (not supplied)
 We recommend that you use a Sony HDMI cable.

continued

Notes on HDMI connections

- Use a HDMI cable with the HDMI logo (made by Sony).
- An audio signal input to the HDMI IN jack is output from the SPEAKERS jacks and HDMI OUT jack. It is not output from any other audio jacks.
- Video signals input to the HDMI IN jack can only be output from the HDMI OUT jack.
- When you want to listen to the sound from the TV speaker, set “AUDIO FOR HDMI” to “TV+AMP” in the VIDEO menu (page 40). If you cannot play back multi channel software, set to “AMP”. However, the sound will not output from the TV speaker.
- The multi/stereo area audio signals of a Super Audio CD are not output.
- Be sure to turn on the receiver when the video and audio of a playback component are being output to a TV via the receiver. If the power supply of the receiver is not turned on, neither video nor audio is transmitted.
- Audio signals (sampling frequency, bit length, etc.) transmitted from a HDMI jack may be suppressed by the connected component. Check the setup of the connected component if the image is poor or the sound does not come out of a component connected via the HDMI cable.
- Sound may be interrupted when the sampling frequency or the number of channels of audio output signals from the playback component is switched.
- When the connected component is not compatible with copyright protection technology (HDCP), the image and/or the sound from the HDMI OUT jack may be distorted or may not be output. In this case, check the specification of the connected component.
- You can enjoy multi channel Linear PCM only with an HDMI connection.
- Set the resolution of the image of the playback component to 720p, 1080i or 1080p when you output 96 kHz multi channel sound over a HDMI connection.
- We do not recommend using a HDMI-DVI conversion cable. When you connect a HDMI-DVI conversion cable to a DVI-D component, the sound and/or the image may not be output.
- You may need to make certain settings on the image resolution of the player before you can enjoy multi channel Linear PCM. Refer to the operating instructions of the player.
- For details on HDMI setup of the connected component, refer to the operating instructions supplied with the connected component.

Connecting the video components

Before connecting the cords, make sure to disconnect the AC power cord (mains lead).

The following illustration shows how to connect video components such as DVD player, DVD recorder or VCR.

It is not necessary to connect all the cords. Connect audio and video cords according to the jacks of your components.

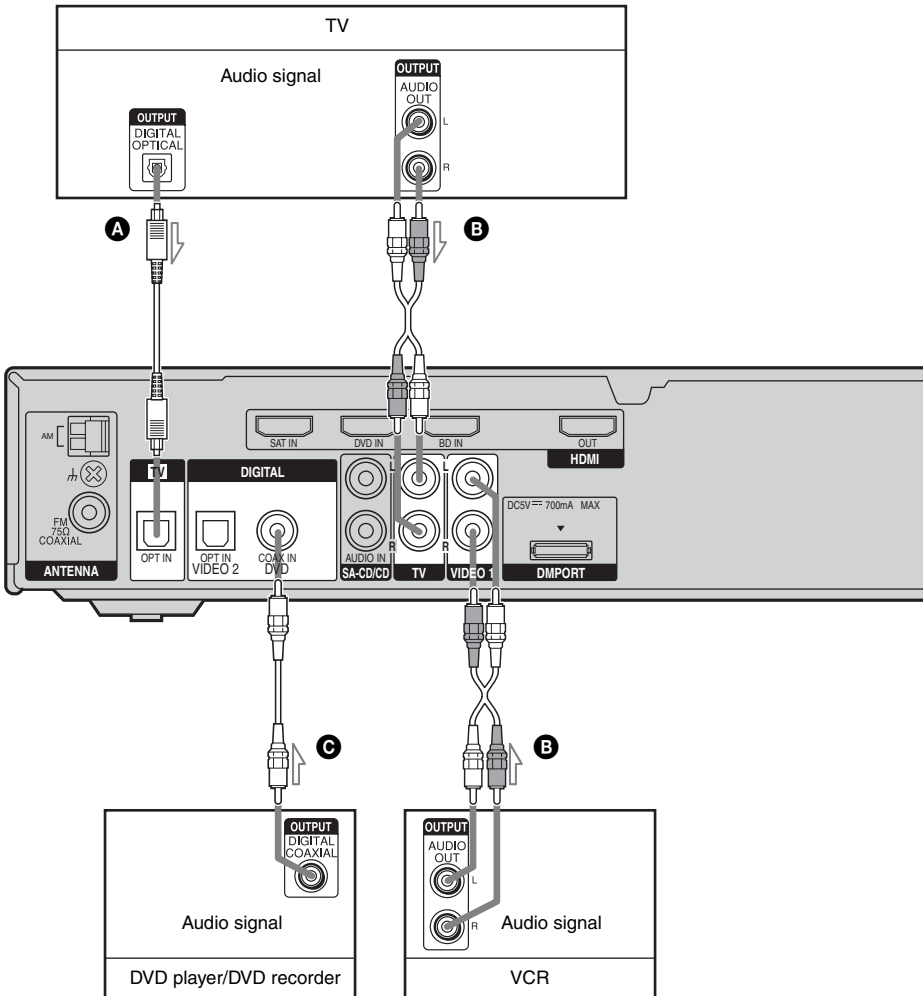

- A** Optical digital cord (not supplied)
- B** Audio cord (not supplied)
- C** Coaxial digital cord (not supplied)

If you connect a DVD player

Be sure to change the factory setting of the DVD input button on the remote so that you can use the button to control your DVD player. For details, see “Changing button assignments” (page 61).

Notes

- You cannot do recording on the DVD recorder or VCR via this receiver. For details, refer to the operating instructions supplied with the DVD recorder or VCR.
- To input multi channel digital audio from the DVD player, set the digital audio output setting on the DVD player. Refer to the operating instructions supplied with the DVD player.
- To output sound from the front speakers and the subwoofer only when you select DVD input, be sure to:
 - connect your DVD player to the DVD COAX IN jack on the receiver.
 - press 2CH.
- Be sure to connect the video output of the DVD player, DVD recorder and VCR to the TV, so that the image is displayed on the TV. Refer to the operating instructions of each component connected for details.
- When connecting optical digital cords, insert the plugs straight in until they click into place.
- Do not bend or tie optical digital cords.

Tips

- All the digital audio jacks are compatible with 32 kHz, 44.1 kHz, 48 kHz, and 96 kHz sampling frequencies
- To output the sound of the TV from the speakers connected to the receiver, be sure to:
 - connect the audio output jacks of the TV to the TV AUDIO IN jacks of the receiver.
 - turn off TV’s volume or activate the TV’s muting function.

4: Connecting the antennas

Connect the supplied AM loop antenna and FM wire antenna.

Before connecting the antennas, make sure to disconnect the AC power cord (mains lead).

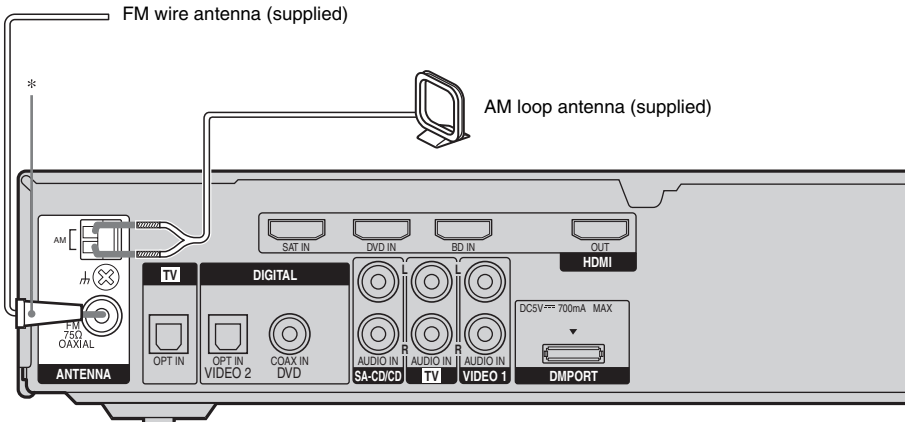

* The shape of the connector varies depending on the area code of this receiver.

Notes

- To prevent noise pickup, keep the AM loop antenna away from the receiver and other components.
- Be sure to fully extend the FM wire antenna.
- After connecting the FM wire antenna, keep it as horizontal as possible.

5: Preparing the receiver and the remote

Connecting the AC power cord (mains lead)

Connect the AC power cord (mains lead) to a wall outlet.

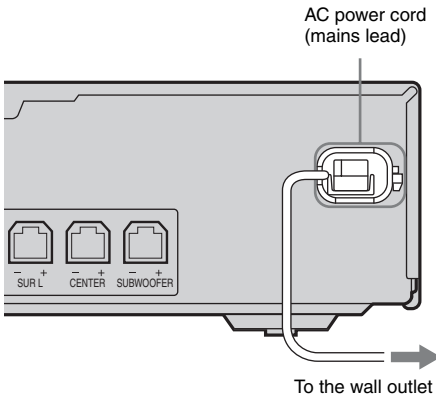

Performing initial setup operations

Before using the receiver for the first time, initialize the receiver by performing the following procedure. This procedure can also be used to return settings you have made to their factory defaults.

Be sure to use the buttons on the receiver for this operation.

1,2



1 Press I/⏻ to turn off the receiver.

2 Hold down I/⏻ for 5 seconds.

“CLEARING” appears on the display for a while, then “CLEARED” appears.

All the settings you have changed or adjusted are reset to the initial settings.

Inserting batteries into the remote

Insert two R6 (size-AA) batteries in the RM-AAU023 Remote Commander. Observe the correct polarity when installing batteries.

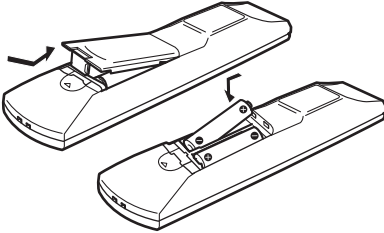

Notes

- Do not leave the remote in an extremely hot or humid place.
- Do not use a new battery with old ones.
- Do not mix manganese batteries and other kinds of batteries.
- Do not expose the remote sensor to direct sunlight or lighting apparatuses. Doing so may cause a malfunction.
- If you do not intend to use the remote for an extended period of time, remove the batteries to avoid possible damage from battery leakage and corrosion.
- When you replace the batteries, the remote buttons may be reset to their factory settings. If this happens, reassign the buttons again (page 61).

Tip

Under normal conditions, the batteries should last for about 3 months. When the remote no longer operates the receiver, replace all the batteries with new ones.

6: Calibrating the appropriate settings automatically (AUTO CALIBRATION)

This receiver is equipped with DCAC (Digital Cinema Auto Calibration) Technology which allows you to perform automatic calibration as follows:

- Check the connection between each speaker and the receiver.
- Adjust the speaker level.
- Measure the distance of each speaker to your listening position.
- Measure the speaker polarity.
- Measure the frequency characteristics.*

* The measurement result is not utilized for signals with a sampling frequency of more than 96 kHz.

The DCAC is designed to obtain proper sound balance in your room. However, you can adjust the speaker levels and balance manually according to your preference. For details, see “7: Adjusting the speaker levels and balance (TEST TONE)” (page 28).

Before you perform Auto Calibration

Before you perform the Auto Calibration, set up and connect the speakers (page 11, 14).

- The AUTO CAL MIC jack is used for the supplied optimizer microphone only. Do not connect other microphones to this jack. Doing so may damage the receiver and the microphone.
- During the calibration, the sound that comes out of the speakers is very loud. The volume of the sound cannot be adjusted. Pay attention to the presence of children or to the effect on your neighborhood.
- Perform the Auto Calibration in a quiet environment to avoid the effect of noise and to get a more accurate measurement.
- If there are any obstacles in the path between the optimizer microphone and the speakers, the calibration cannot be performed correctly. Remove any obstacles from the measurement area to avoid measurement error.

Note

If the muting function has been activated before you perform Auto Calibration, the muting function will be set to off automatically.

Example: HT-SS1300

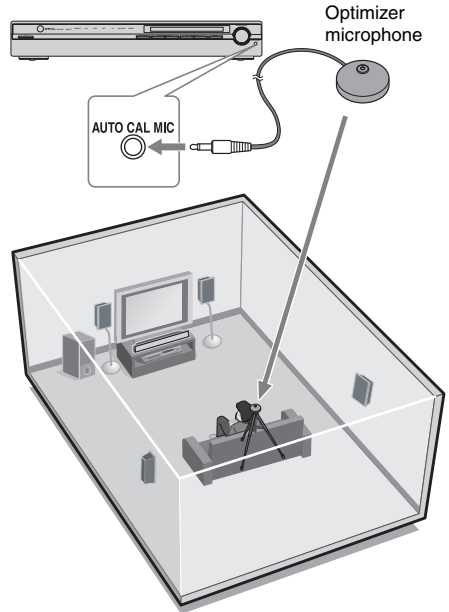

1 Connect the supplied optimizer microphone to the AUTO CAL MIC jack.

2 Set up the optimizer microphone.

Place the optimizer microphone at your listening position. You can also use a stool or tripod so that the optimizer microphone remains at the same height as your ears.

Tip

When you face the speaker towards the optimizer microphone, you will get a more accurate measurement.

Performing Auto Calibration

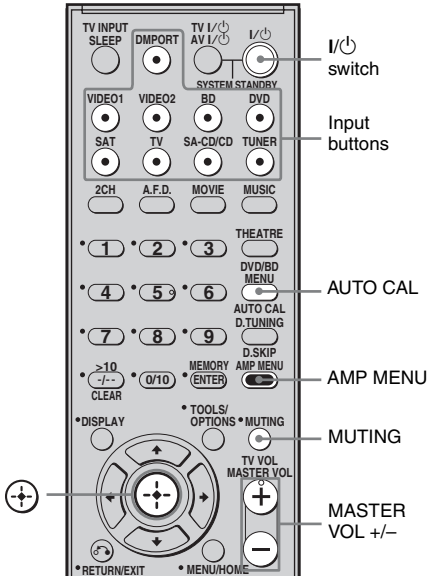

Press AMP MENU, then press AUTO CAL.

You can also select “A.CAL YES” in the A. CAL menu.

The following appears on the display.
A.CAL [5] → A.CAL [4] → A.CAL [3] →
A.CAL [2] → A.CAL [1]

The measurement process will take approximately 30 seconds to complete. The table below shows the display when measurement starts.

Measurement for	Display
Speaker existance	TONE
Speaker gain, distance, frequency response	T.S.P.
Subwoofer gain and distance	WOOFER

Note

You cannot measure the speaker height of the surround speakers. Set this value using “SUR POS.” parameters in the SYSTEM menu (page 35).

Tip

When Auto Calibration starts:

- Stand some distance from the speakers and the listening position to avoid measurement failure. This is because test signals are output from the speakers during measurement.
- Avoid making noise to get a more accurate measurement.

To cancel Auto Calibration

The Auto Calibration function will be canceled when you do the following during the measurement process:

- Press I/Power or MUTING.
- Press input buttons on the remote or INPUT SELECTOR on the receiver.
- Change the volume level.
- Press AUTO CAL again.

Confirming/saving the measurement results

1 Confirm the measurement result.

When the measurement ends, a beep sounds and the measurement result appears on the display.

Measurement result	Display	Explanation
When the measurement process completes properly	SAVE	Proceed to step 2.
When the measurement process fails	ERROR XXXX	See “When error codes appear” (page 26).

continued

25GB

2 Press \uparrow/\downarrow repeatedly to select the item. Then, press \oplus .

Item	Explanation
RETRY	Performs the Auto Calibration again.
SAVE	Saves the measurement results and exits the setting process.
WARN CHK	Displays warning concerning the measurement results. See "When you select "WARN CHK"" (page 27).
PHASE	Displays the phase of each speaker (in phase/out of phase). See "When you select "PHASE"" (page 27).
DISTANCE	Displays the measurement result for speaker distance.
LEVEL	Displays the measurement result for speaker level.
EXIT	Exits the setting process without saving the measurement results.

3 Save the measurement result.

Select "SAVE" in step 2.
The measurement results are saved.

When error codes appear

Try the remedies and perform the Auto Calibration again.

Error code	Cause and remedies
ERROR 32	None of the speakers were detected. Make sure that the optimizer microphone is connected properly and perform the Auto Calibration again. If the optimizer microphone is connected properly but the error code appears, the optimizer microphone cable may be damaged or improperly connected.
ERROR F 33	<ul style="list-style-type: none"> None of the front speakers are connected or only one front speaker is connected. The optimizer microphone is not connected.
ERROR SR 33	Either the left or right surround speakers is not connected.
ERROR SW 33	Subwoofer is not connected. Connect the subwoofer to the SUBWOOFER terminal.
ERROR 33	Wrong speaker detection due to noise. Make sure the environment is quiet during Auto Calibration.
ERROR 35	A sound similar to the beep sound from the speakers while performing Auto Calibration is detected. Perform the Auto Calibration again.

To rectify the error

- Record down the error code.
- Press \oplus , "RETRY Y" appears on the display.
- Rectify the error.
For details, see "When error codes appear" above.
- Press \oplus to perform Auto Calibration again.

When you select “WARN CHK”

If a warning on the measurement result is present, detailed information is displayed.

Press **⊕** to return to step 2 of “Confirming/saving the measurement results”.

Warning code	Explanation
WARN 40	The Auto Calibration has completed. However, the noise level is high. You may be able to perform the Auto Calibration properly if you try it again, even though the measurement cannot be performed in all environments. Try to perform the Auto Calibration in a quiet environment.
WARN 41	The sound input from the optimizer microphone is out of the acceptable range. It is louder than the loudest sound that can be measured. Try to perform the Auto Calibration when the environment is quiet enough to allow proper measurement.
WARN 42	The volume of the receiver is out of the acceptable range. Try to perform the Auto Calibration when the environment is quiet enough to allow proper measurement.
WARN 43	The distance and position of a subwoofer cannot be detected. This may be caused by noise. Try to perform the Auto Calibration in a quiet environment.
NO WARN	There is no warning information.

When you select “PHASE”

You can check the phase of each speaker (in phase/out of phase).

Press **↑/↓** repeatedly to select a speaker, then press **⊕** to return to step 2 in “Confirming/saving the measurement results”.

Display	Explanation
■ ■ * IN	The speaker is in phase.
■ ■ * OUT	The speaker is out of phase. The “+” and “-” terminals of the speaker may be connected the other way around.

* ■ ■ represent a speaker channel

FL	Front left
FR	Front right
C	Center
SL	Surround left
SR	Surround right
SW	Subwoofer

Tip

Depending on the position of the subwoofer, the measurement results for polarity may vary. However, there will be no problems even if you continue to use the receiver with that value.

After you have finished

Disconnect the optimizer microphone from the receiver.

Note

If you have changed the position of the speakers, it is recommended you to perform Auto Calibration again in order to enjoy the surround sound.

A. CAL menu parameters

You can use the A. CAL menu to make settings for the Auto Calibration function to suit your preference.

Select “8-A. CAL” in the amplifier menus. For details on adjusting the parameters, see “Navigating through menus” (page 33) and “Overview of the menus” (page 34).

■ AUTO CAL (Auto Calibration no/yes)

- A.CAL NO
The Auto Calibration function is not activated.
- A.CAL YES
The Auto Calibration function starts.

■ CAL LOAD (Calibration load)*

- LOAD YES
Select this when you want to load the saved Auto Calibration result.
- LOAD NO
Select this when you do not want to load the saved Auto Calibration result.

* You can select this parameter only when you have performed the Auto Calibration and saved the settings.

7: Adjusting the speaker levels and balance (TEST TONE)

You can adjust the speaker levels and balance while listening to the test tone from your listening position.

Tip

The receiver employs a test tone with a frequency centered at 800 Hz.

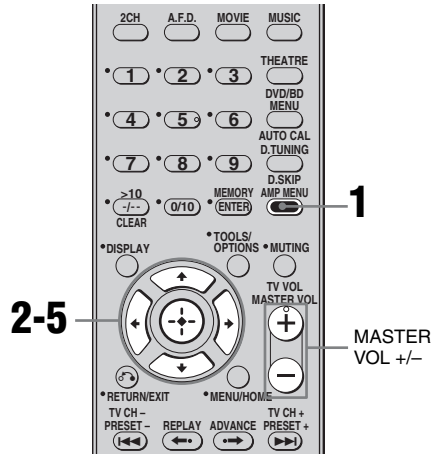

1 Press AMP MENU.

“1-LEVEL” appears on the display.

2 Press \oplus or \rightarrow to enter the menu.

3 Press \uparrow/\downarrow repeatedly to select “T. TONE”.

4 Press \oplus or \rightarrow to enter the parameter.

5 Press \uparrow/\downarrow repeatedly to select “T. TONE Y”.

The test tone is output from each speaker in sequence as follows:

Front left → Center → Front right →
Surround right → Surround left →
Subwoofer

6 Adjust the speaker levels and balance using the LEVEL menu so that the level of the test tone sounds the same from each speaker.

For details, see “Adjusting the level (LEVEL menu)” (page 37).

Tips

- To adjust the level of all speakers at the same time, press MASTER VOL +/- . You can also use MASTER VOLUME on the receiver.
- The adjusted value are shown on the display during adjustment.

To turn off the test tone

Repeat steps 1 to 5 above. Then, select “T. TONE N” in step 5.

Selecting a component

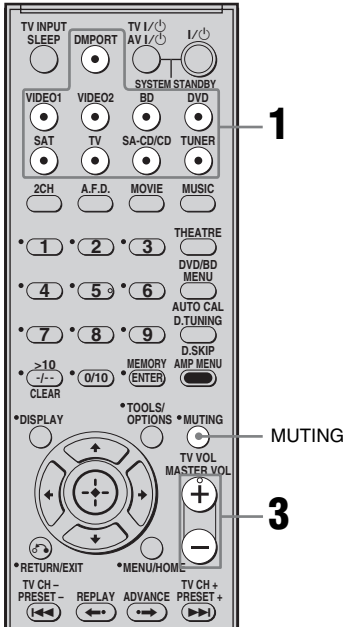

1 Press the input button to select a component.

You can also use INPUT SELECTOR on the receiver.

The selected input appears on the display.

Selected input [Display]	Components that can be played back
DMPORT [DMPORT]	DIGITAL MEDIA PORT adapter connected to DMPORT jack
VIDEO 1 or VIDEO 2 [VIDEO 1 or VIDEO 2]	VCR, etc., connected to the VIDEO 1 or VIDEO 2 jack
BD [BD]	Blu-ray disc player, etc., connected to the BD jack
DVD [DVD]	DVD player, etc., connected to DVD jack
SAT [SAT]	Satellite tuner, set-top box, etc., connected to SAT jack
TV [TV]	TV, etc., connected to TV jack
SA-CD/CD [SA-CD/CD]	Super Audio CD/CD player, etc., connected to the SA-CD/CD jack
TUNER [FM or AM band]	Built-in radio tuner

2 Turn on the component and start playback.

3 Press MASTER VOL +/- to adjust the volume.

You can also use MASTER VOLUME on the receiver.

To activate the muting function

Press MUTING.

The muting function will be canceled when you do the following.

- Press MUTING again.
- Increase the volume.
- Turn off the receiver.

To avoid damaging your speakers

Before you turn off the receiver, be sure to turn down the volume level.

Listening/Watching a component

Listening to a Super Audio CD/CD

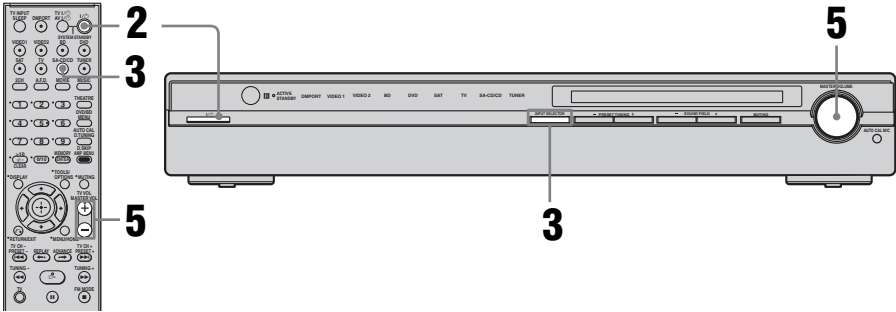

Notes

- The operation is described for a Sony Super Audio CD player.
- Refer to the operating instructions supplied with the Super Audio CD player or CD player.

Tips

- You can select the sound field to suit the music. Refer to page 44 for details.
Recommended sound fields:
Classical: HALL
Jazz: JAZZ
Live concert: CONCERT
- You can listen to the sound that was recorded in the 2 channel format from all speakers (multi channel). Refer to page 43 for details.

1 Turn on the Super Audio CD player/CD player, then place the disc on the tray.

2 Turn on the receiver.

3 Press SA-CD/CD.

You can also use INPUT SELECTOR on the receiver to select "SA-CD/CD".

4 Playback the disc.

5 Adjust to a suitable volume.

6 After you have finished listening to the Super Audio CD/CD, eject the disc and turn off the receiver and Super Audio CD player/CD player.

Watching a DVD/Blu-ray disc

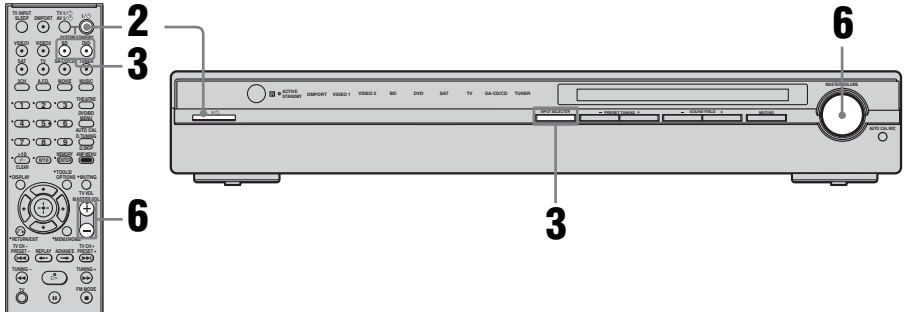

Notes

- Refer to the operating instructions supplied with the TV and DVD player or Blu-ray disc player.
- Check the following if you cannot listen to multi channel sound.
 - Be sure this receiver is connected to the DVD player or Blu-ray disc player via a digital connection.
 - Be sure the digital audio output of the DVD player or Blu-ray disc player is set up properly.

Tips

- Select the audio format of the disc to be played, if necessary.
- You can select the sound field to suit the movie/music. Refer to page 44 for details.
Recommended sound fields:
Movie: C.ST.EX
Music: CONCERT

1 Turn on the TV and DVD player or Blu-ray disc player.

2 Turn on the receiver.

3 Press DVD or BD.

You can also use INPUT SELECTOR on this receiver to select “DVD” or “BD”.

Be sure to change the factory setting of the DVD input button on the remote so that you can use the button to control your DVD player. For details, see “Changing button assignments” (page 61).

4 Switch the input of the TV so that an image of the DVD/Blu-ray disc is displayed.

If no image is displayed on the TV screen, make sure that the video output of the DVD player or Blu-ray disc player is connected to the TV.

5 Playback the disc.

6 Adjust to a suitable volume.

7 After you have finished watching the DVD, eject the disc and turn off the receiver, TV and DVD player or Blu-ray disc player.

Amplifier Operations

Navigating through menus

By using the amplifier menus, you can make various adjustments to customize the receiver.

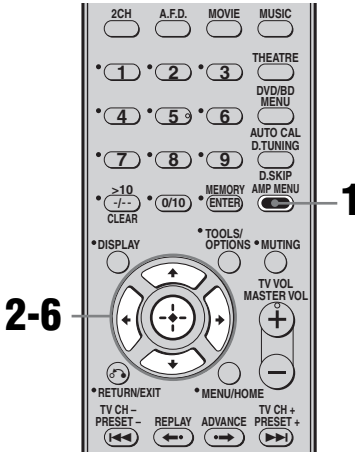

To return to the previous display

Press ←.

To exit the menu

Press AMP MENU.

Note

Some parameters and settings may appear dimmed on the display. This means that they are either unavailable or fixed and unchangeable.

1 Press AMP MENU.

“1-LEVEL” appears on the display.

2 Press ↑/↓ repeatedly to select the menu you want.

3 Press ⊕ or → to enter the menu.

4 Press ↑/↓ repeatedly to select the parameter you want to adjust.

5 Press ⊕ or → to enter the parameter.

6 Press ↑/↓ repeatedly to select the setting you want.

The setting is entered automatically.

Overview of the menus

The following options are available in each menu. For details on navigating through menus, see page 33.

Menu [Display]	Parameters [Display]	Settings	Initial setting
LEVEL [1-LEVEL] (page 37)	Test tone ^{a)} [T. TONE]	T. TONE N, T. TONE Y	T. TONE N
	Front speaker balance ^{a)} [FRT BAL]	BAL. L +1 to BAL. L +10, BALANCE, BAL. R +1 to BAL. R +10	BALANCE
	Center speaker level [CNT LVL]	CNT -10 dB to CNT +10 dB (1 dB step)	CNT 0 dB
	Surround left speaker level [SL LVL]	SUR L -10 dB to SUR L +10 dB (1 dB step)	SUR L 0 dB
	Surround right speaker level [SR LVL]	SUR R -10 dB to SUR R +10 dB (1 dB step)	SUR R 0 dB
	Subwoofer level [SW LVL]	SW -10 dB to SW +10 dB (1 dB step)	SW 0 dB
	Dynamic range compressor ^{a)} [D. RANGE]	COMP. OFF, COMP. STD, COMP. MAX	COMP. OFF
TONE [2-TONE] (page 38)	Front speaker bass level [BASS LVL]	BASS -10 dB to BASS +10 dB (0.5 dB step)	BASS 0 dB
	Front speaker treble level [TRE LVL]	TRE -10 dB to TRE +10 dB (0.5 dB step)	TRE +1 dB
SUR [3-SUR] (page 38)	Sound field selection ^{a)} [S.F. SELCT]	For details, see “Enjoying Surround Sound” (page 43).	A.F.D. AUTO
	Effect level ^{a)b)} [EFFECT]	EFCT. MIN, EFCT. STD, EFCT. MAX	EFCT. STD
TUNER [4-TUNER] (page 39)	FM station receiving mode ^{a)} [FM MODE]	FM AUTO, FM MONO	FM AUTO

Menu [Display]	Parameters [Display]	Settings	Initial setting
AUDIO [5-AUDIO] (page 39)	Digital audio input decoding priority ^{a)} [DEC. PRI.]	DEC. PCM, DEC. AUTO	DEC. AUTO for: VIDEO 1, VIDEO 2, BD, DVD, SAT, TV; DEC. PCM for: SA-CD/CD
	Digital broadcast language selection ^{a)} [DUAL]	DUAL M/S, DUAL M, DUAL S, DUAL M+S	DUAL M
	Synchronizes audio with video output ^{a)} [A.V. SYNC.]	A.V.SYNC. 0 to A.V.SYNC. 20	A.V.SYNC. 0
	Switching the audio input mode ^{a)} [IN MODE]	For details, see “Switching between digital and analog audio (IN MODE)” (page 58).	
VIDEO [6-VIDEO] (page 40)	Audio for HDMI ^{a)c)} [AUDIO FOR HDMI]	AMP, TV+AMP	AMP
	Control for HDMI ^{a)c)} [CONTROL FOR HDMI]	CTRL ON, CTRL OFF	CTRL OFF
SYSTEM [7-SYSTEM] (page 41)	Front left speaker distance ^{a)d)} [FL DIST.]	DIST. 1.0 m to DIST. 7.0 m (0.1 m step)	DIST. 3.0 m
	Front right speaker distance ^{a)d)} [FR DIST.]	DIST. 1.0 m to DIST. 7.0 m (0.1 m step)	DIST. 3.0 m
	Center speaker distance ^{a)d)} [CNT DIST.]	DIST. 1.0 m to DIST. 7.0 m (0.1 m step)	DIST. 3.0 m
	Surround left speaker distance ^{a)d)} [SL DIST.]	DIST. 1.0 m to DIST. 7.0 m (0.1 m step)	DIST. 3.0 m
	Surround right speaker distance ^{a)d)} [SR DIST.]	DIST. 1.0 m to DIST. 7.0 m (0.1 m step)	DIST. 3.0 m
	Subwoofer distance ^{a)d)} [SW DIST.]	DIST. 1.0 m to DIST. 7.0 m (0.1 m step)	DIST. 3.0 m
	Surround speaker position ^{a)} [SUR POS.]	BEHD/HI, BEHD/LO, SIDE/HI, SIDE/LO	SIDE/LO
	Brightness of the display ^{a)} [DIMMER]	0% dim, 40% dim, 70% dim	0% dim

continued

35GB

Menu [Display]	Parameters [Display]	Settings	Initial setting
A. CAL [8-A. CAL] (page 28)	Auto calibration no/yes ^{a)e)} [AUTO CAL]	A.CAL NO, A.CAL YES	A.CAL NO
	Calibration load ^{a)d)} [CAL LOAD]	LOAD NO, LOAD YES	LOAD YES

a) For details, refer to the page in the parentheses.

b) The surround effect is not available for 2CH STEREO and A.F.D. mode.

c) "AUDIO FOR HDMI" and "CONTROL FOR HDMI" scroll across the display, then "AUDIO" and "CONTROL" appear respectively.

d) When you set "CAL LOAD" in A. CAL menu to "LOAD YES", the setting is displayed as ■.■■ m and you can adjust the setting in 0.01 meter increment.

e) After you select the setting, press ⊕ to confirm the selection.

Adjusting the level

(LEVEL menu)

You can use the LEVEL menu to adjust the balance and level of each speaker. Select “1-LEVEL” in the amplifier menus. For details on adjusting the parameters, see “Navigating through menus” (page 33) and “Overview of the menus” (page 34).

LEVEL menu parameters

■ T. TONE (Test tone)

Lets you adjust the speaker levels and balance while listening to the test tone from your listening position. For details, see “7: Adjusting the speaker levels and balance (TEST TONE)” (page 28).

■ FRT BAL (Front speaker balance)

Lets you adjust the balance between front left and right speakers.

■ CNT LVL (Center speaker level)

■ SL LVL (Surround left speaker level)

■ SR LVL (Surround right speaker level)

■ SW LVL (Subwoofer level)

■ D. RANGE (Dynamic range compressor)

Lets you compress the dynamic range of the sound track. This may be useful when you want to watch movies at low volumes late at night. Dynamic range compression is possible with Dolby Digital sources only.

- COMP. OFF
The dynamic range is not compressed.
- COMP. STD
The dynamic range is compressed as intended by the recording engineer.
- COMP. MAX
The dynamic range is compressed dramatically.

Tip

Dynamic range compressor lets you compress the dynamic range of the soundtrack based on the dynamic range information included in the Dolby Digital signal. “COMP. STD” is the standard setting, but it only enacts light compression. Therefore, we recommend using the “COMP. MAX” setting. This greatly compresses the dynamic range and lets you view movies late at night at low volumes. Unlike analog limiters, the levels are predetermined and provide a very natural compression.

Adjusting the tone (TONE menu)

You can use the TONE menu to adjust the tonal quality (bass/treble level) of the front speakers.

Select “2-TONE” in the amplifier menus. For details on adjusting the parameters, see “Navigating through menus” (page 33) and “Overview of the menus” (page 34).

TONE menu parameters

- **BASS LVL (Front speaker bass level)**
- **TRE LVL (Front speaker treble level)**

Settings for the surround sound (SUR menu)

You can use the SUR menu to select the sound field you want for your listening pleasure.

Select “3-SUR” in the amplifier menus. For details on adjusting the parameters, see “Navigating through menus” (page 33) and “Overview of the menus” (page 34).

SUR menu parameters

■ **S.F. SELCT (Sound field selection)**

Lets you select the sound field you want. For details, see “Enjoying Surround Sound” (page 43).

Note

The receiver lets you apply the last selected sound field to an input whenever it is selected (Sound Field Link). For example, if you select “HALL” for the SA-CD/CD input, then change to a different input and then return to SA-CD/CD, “HALL” will automatically be applied again.

■ **EFFECT (Effect level)**

Lets you adjust the “presence” of the surround effect for sound fields selected with the MOVIE or MUSIC button.

- **EFCT. MIN**
The surround effect is minimum.
- **EFCT. STD**
The surround effect is standard.
- **EFCT. MAX**
The surround effect is maximum.

Settings for the tuner (TUNER menu)

You can use the TUNER menu to set the FM station receiving mode.

Select “4-TUNER” in the amplifier menus. For details on adjusting the parameters, see “Navigating through menus” (page 33) and “Overview of the menus” (page 34).

TUNER menu parameters

■ FM MODE (FM station receiving mode)

- FM AUTO
This receiver will decode the signal as stereo signal when the radio station is broadcast in stereo.
- FM MONO
This receiver will decode the signal as mono signal regardless of the broadcast signal.

Settings for the audio (AUDIO menu)

You can use the AUDIO menu to make settings for the audio to suit your preference. Select “5-AUDIO” in the amplifier menus. For details on adjusting the parameters, see “Navigating through menus” (page 33) and “Overview of the menus” (page 34).

AUDIO menu parameters

■ DEC. PRI. (Digital audio input decoding priority)

Lets you specify the input mode for the digital signal input to the DIGITAL IN and HDMI IN jacks.

- DEC. PCM
PCM signals are given priority (to prevent interruption when playback starts). However, when other signals are input, there may be no sound depending on the format. In this case, set to “DEC. AUTO”. When signals from the HDMI IN jack are selected, only PCM signals are output from the connected player. When signals in other format are received, set to “DEC. AUTO”.
- DEC. AUTO
Automatically switches the input mode between DTS, Dolby Digital, or PCM.

Note

When set to “DEC. AUTO” and the sound from the digital audio jacks (for CD, etc.) is interrupted when playback starts, set to “DEC. PCM”.

■ DUAL (Digital broadcast language selection)

Lets you select the language you want to listen to during digital broadcast. This feature only functions for Dolby Digital sources.

- DUAL M/S (Main/Sub)
Sound of the main language will be output through the front left speaker and sound of the sub language will be output through the front right speaker simultaneously.
- DUAL M (Main)
Sound of the main language will be output.
- DUAL S (Sub)
Sound of the sub language will be output.
- DUAL M+S (Main + Sub)
Mixed sound of both the main and sub languages will be output.

■ A.V. SYNC. (Synchronizes audio with video output)

Lets you delay the audio output so that the time gap between the audio output and visual display is minimized. You can adjust from 0 (0 ms) to 20 (200 ms) in 1 (10 ms) steps.

Notes

- This parameter is useful when you use a large LCD or plasma monitor or a projector.
- This function does not work when
 - signals with a sampling frequency of more than 48 kHz are input.
 - multi channel Linear PCM signals are received via an HDMI jack.

■ IN MODE (Switching the audio input mode)

Lets you set the audio input mode of inputs. For details, see “Switching between digital and analog audio (IN MODE)” (page 58).

Settings for the video (VIDEO menu)

You can use the VIDEO menu to make various adjustments for HDMI settings.

Select “6-VIDEO” in the amplifier menus. For details on adjusting the parameters, see “Navigating through menus” (page 33) and “Overview of the menus” (page 34).

VIDEO menu parameters

■ AUDIO FOR HDMI (Audio for HDMI)

Lets you set the audio output for HDMI from the playback component connected to the receiver via an HDMI connection.

- AMP
The HDMI audio signals from the playback component is only output to speakers connected to the receiver. Multi-channel sound can be played back as it is.

Note

Audio signals are not output from the TV’s speakers when “AUDIO FOR HDMI” is set to “AMP”.

- TV+AMP

The sound is output from TV’s speaker and the speakers connected to the receiver.

Notes

- The sound quality of the playback component depends on the TV’s sound quality, such as the number of channels, and the sampling frequency, etc. When the TV has stereo speakers, the sound output from the receiver is also stereo as that of the TV, even if you play multi-channel software.
- When you connect the receiver to a video component (projector, etc.), sound may not be output from the receiver. In this case, select “AMP”.

■ CONTROL FOR HDMI (Control for HDMI)

Lets you turn the Control for HDMI function on or off. For details, see “Control for HDMI” (page 52).

Settings for the system (SYSTEM menu)

You can use the SYSTEM menu to set the distance of the speakers connected to this system.

Select “7-SYSTEM” in the amplifier menus. For details on adjusting the parameters, see “Navigating through menus” (page 33) and “Overview of the menus” (page 34).

SYSTEM menu parameters

■ FL DIST. (Front left speaker distance)

■ FR DIST. (Front right speaker distance)

Lets you set the distance from your listening position to the front speaker (A). If both front speakers are not placed an equal distance from your listening position, set the distance to the closest speaker.

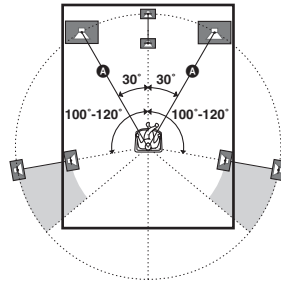

■ CNT DIST. (Center speaker distance)

Lets you set the distance from your listening position to the center speaker.

■ SL DIST. (Surround left speaker distance)

■ SR DIST. (Surround right speaker distance)

Lets you set the distance from your listening position to the surround speakers.

continued

■ SW DIST. (Subwoofer distance)

Lets you set the distance from your listening position to the subwoofer.

Tip

If you set "CAL LOAD" in A. CAL menu to "LOAD YES", you can adjust the speakers distance in 0.01 meter increment.

■ SUR POS. (Surround speaker position)

Lets you specify the location of your surround speakers for proper implementation of the surround effects in the CINEMA STUDIO EX modes (page 45).

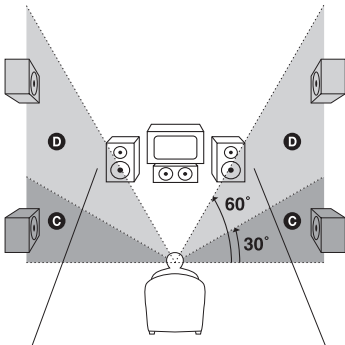
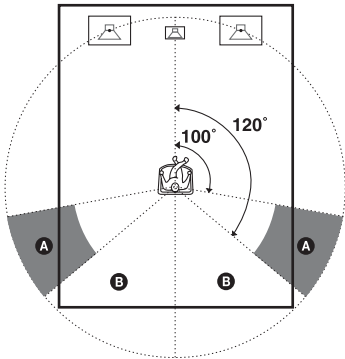

- BEHD/HI
Select if the location of your surround speakers corresponds to sections **B** and **D**.
- BEHD/LO
Select if the location of your surround speakers corresponds to sections **B** and **C**.

- SIDE/HI
Select if the location of your surround speakers corresponds to sections **A** and **D**.
- SIDE/LO
Select if the location of your surround speakers corresponds to sections **A** and **C**.

Tip

Surround speaker position is designed specifically for implementation of the CINEMA STUDIO EX modes. For other sound fields, speaker position is not so critical.

Those sound fields were designed under the premise that the surround speakers would be located behind the listening position, but presentation remains fairly consistent even with the surround speakers positioned at a rather wide angle. However, if the speakers are pointing toward the listener from the immediate left and right of the listening position, the surround effects become unclear unless set to "SIDE/LO" or "SIDE/HI".

Nevertheless, each listening environment has many variables, such as wall reflections, and you may obtain better results using "BEHD/HI" if your speakers are located high above the listening position, even if they are located to the immediate left and right.

Therefore, although it may result in a setting contrary to the above explanation, we recommend that you playback multi channel surround encoded software and select the setting that provides a good sense of spaciousness and that best succeeds in forming a cohesive space between the surround sound from the surround speakers and the sound of the front speakers. If you are not sure which sounds best, select "BEHD/LO" or "BEHD/HI" and then use the speaker distance parameter and speaker level adjustments to obtain proper balance.

■ DIMMER (Brightness of the display)

Lets you adjust the brightness in 3 steps.

Enjoying Dolby Digital and DTS Surround sound (AUTO FORMAT DIRECT)

The Auto Format Direct (A.F.D.) mode allows you to listen to higher fidelity sound and select the decoding mode for listening to a 2 channel stereo sound as multi channel sound.

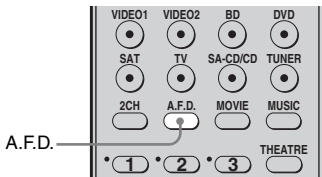

Press A.F.D. repeatedly to select the sound field you want.

You can also use SOUND FIELD +/- on the receiver.

For details, see “Types of A.F.D. mode” (page 43).

Types of A.F.D. mode

A.F.D. mode [Display]	Multi channel audio after decoding	Effect
A.F.D. AUTO [A.F.D. AUTO]	(Detecting automatically)	Presents the sound as it was recorded/encoded without adding any surround effects. However, this receiver will generate a low frequency signal for output to the subwoofer when there is no LFE signals.
PRO LOGIC [DOLBY PL]	4 channel	Performs Dolby Pro Logic decoding. The source recorded in 2 channel format is decoded into 4.1 channels.
PRO LOGIC II MOVIE [PLII MV]	5 channel	Performs Dolby Pro Logic II Movie mode decoding. This setting is ideal for movies encoded in Dolby Surround. In addition, this mode can reproduce sound in 5.1 channel for watching videos of overdubbed or old movies.
PRO LOGIC II MUSIC [PLII MS]	5 channel	Performs Dolby Pro Logic II Music mode decoding. This setting is ideal for normal stereo sources such as CDs.
MULTI STEREO [MULTI ST.]	(Multi Stereo)	Outputs 2 channel left/right signals from all speakers.

Selecting a pre-programmed sound field

You can take advantage of surround sound simply by selecting one of the receiver's pre-programmed sound fields. They bring the exciting and powerful sound of movie theaters and concert halls into your home.

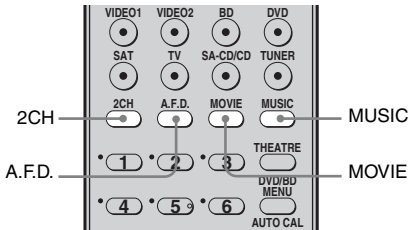

Press MOVIE repeatedly to select a sound field for movies or press MUSIC repeatedly to select a sound field for music.

You can also use SOUND FIELD +/- on the receiver.

For details, see “Types of sound field available” (page 45).

Types of sound field available

Sound field for	Sound field [Display]	Effect
Movie	CINEMA STUDIO EX A DCS [C.ST.EX A]	Reproduces the sound characteristics of the Sony Pictures Entertainment "Cary Grant Theater" cinema production studio. This is a standard mode, great for watching almost any type of movie.
	CINEMA STUDIO EX B DCS [C.ST.EX B]	Reproduces the sound characteristics of the Sony Pictures Entertainment "Kim Novak Theater" cinema production studio. This mode is ideal for watching science-fiction or action movies with lots of sound effects.
	CINEMA STUDIO EX C DCS [C.ST.EX C]	Reproduces the sound characteristics of the Sony Pictures Entertainment scoring stage. This mode is ideal for watching musicals or films where orchestra music is featured in the soundtrack.
Music	HALL [HALL]	Reproduces the acoustics of a classical concert hall.
	JAZZ CLUB [JAZZ]	Reproduces the acoustics of a jazz club.
	LIVE CONCERT [CONCERT]	Reproduces the acoustics of a 300-seat live house.
	STADIUM [STADIUM]	Reproduces the feeling of a large open-air stadium.
	SPORTS [SPORTS]	Reproduces the feeling of sports broadcasting.
	PORTABLE AUDIO ENHANCER [PORTABLE]	Reproduces a clear enhanced sound image from your portable audio device. This mode is ideal for MP3 and other compressed music.

Notes

- The effects provided by the virtual speakers may cause increased noise in the playback signal.
- When listening with sound fields that employ the virtual speakers, you will not be able to hear any sound coming directly from the surround speakers.
- This function does not work when
 - signals with a sampling frequency of more than 48 kHz are input.
 - multi channel Linear PCM signals are received via an HDMI jack.

Tips

- You can identify the encoding format of DVD software, etc., by looking at the logo on the package.
- Sound fields with **DCS** mark use DCS technology. For details on Digital Cinema Sound (DCS), see "Glossary" (page 62).

To turn off the surround effect for movie/music

Press 2CH to select "2CH ST." or press A.F.D. repeatedly to select "A.F.D. AUTO".

Using only the front speakers and subwoofer (2CH STEREO)

In this mode, the receiver outputs the sound from the front left/right speakers and subwoofer only.

When multi channel surround formats are input, the signals are downmixed to 2 channel with bass frequencies being output from the subwoofer.

When standard 2 channel stereo sources are input, the receiver's bass redirection circuitry will be activated. The front channel bass frequencies will be output from the subwoofer.

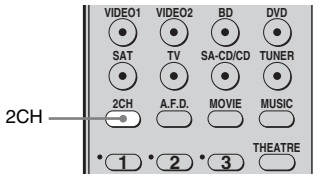

Press 2CH.

You can also use SOUND FIELD +/- on the receiver.

Resetting sound fields to the initial settings

Be sure to use the buttons on the receiver for this operation.

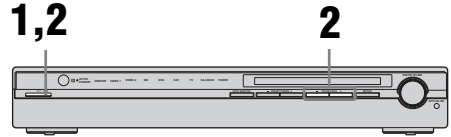

1 Press I/⏻ to turn off the receiver.

2 While holding down SOUND FIELD +, press I/⏻.

“S.F. CLR.” appears on the display and all sound fields are reset to their initial setting.

Tuner Operations

Listening to FM/AM radio

You can listen to FM and AM broadcasts through the built-in tuner. Before operation, make sure you have connected the FM and AM antennas to the receiver (page 21).

Tip

The tuning scale for direct tuning differs depending on the area code as shown in the following table. For details on area codes, see page 3.

Area code	FM	AM
CEL, CEK	50 kHz	9 kHz

Automatic tuning

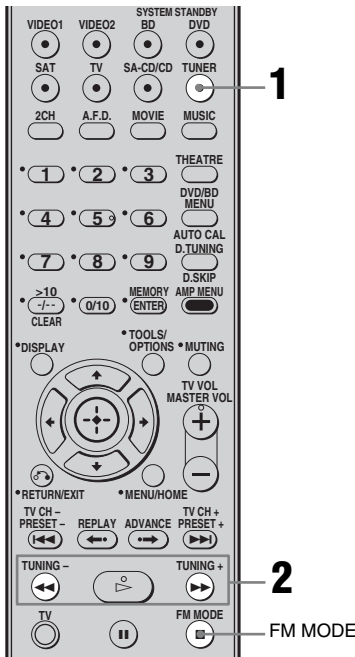

1 Press TUNER repeatedly to select the FM or AM band.

You can also use INPUT SELECTOR on the receiver.

2 Press TUNING + or TUNING -.

Press TUNING + to scan from low to high; press TUNING - to scan from high to low.

The receiver stops scanning whenever a station is received.

In case of poor FM stereo reception

If the FM stereo reception is poor and “ST” flashes on the display, select monaural audio so that the sound will be less distorted.

To select monaural audio, you can – press FM MODE repeatedly until the “MONO” indicator lights up on the display. – set “FM MODE” in TUNER menu to “FM MONO” (page 39).

To return to stereo mode, you can – press FM MODE repeatedly until the “MONO” indicator on the display do not light up. – set “FM MODE” in TUNER menu to “FM AUTO” (page 39).

Direct tuning

You can enter the frequency of a station directly by using the numeric buttons.

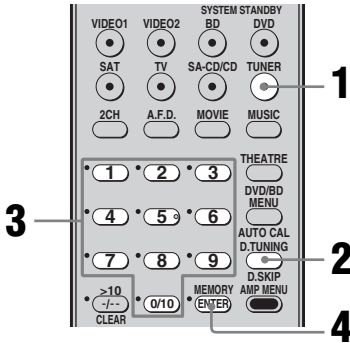

- 1 Press TUNER repeatedly to select the FM or AM band.**

You can also use INPUT SELECTOR on the receiver.

- 2 Press D.TUNING.**

- 3 Press the numeric buttons to enter the frequency.**

Example 1: FM 102.50 MHz

Select 1 → 0 → 2 → 5 → 0

Example 2: AM 1,350 kHz

Select 1 → 3 → 5 → 0

If you have tuned in an AM station, adjust the direction of the AM loop antenna for optimum reception.

- 4 Press ENTER.**

If you cannot tune in a station

Make sure you have entered the right frequency. If not, repeat steps 2 to 4. If you still cannot tune in a station, the frequency is not used in your area.

Presetting radio stations

You can preset up to 30 FM stations and 30 AM stations. Then you can easily tune in the stations you often listen to.

Presetting radio stations

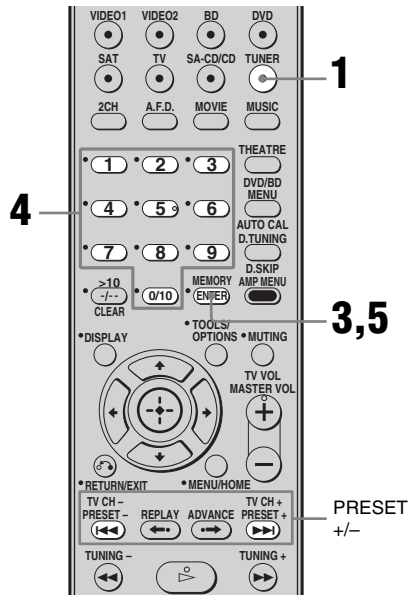

- 1 Press TUNER repeatedly to select the FM or AM band.**

You can also use INPUT SELECTOR on the receiver.

- 2 Tune in the station that you want to preset using automatic tuning (page 47) or direct tuning (page 48).**

Switch the FM reception mode, if necessary (page 47).

- 3 Press MEMORY.**

“MEMORY” lights up for a few seconds. Perform steps 4 and 5 before “MEMORY” goes out.

Tuning to preset stations

4 Press the numeric buttons to select a preset number.

You can also press the PRESET + or PRESET - to select a preset number. If "MEMORY" goes out before you select the preset number, start again from step 3.

5 Press ENTER.

The station is stored as the selected preset number. If "MEMORY" goes out before you press ENTER, start again from step 3.

6 Repeat steps 1 to 5 to preset another station.

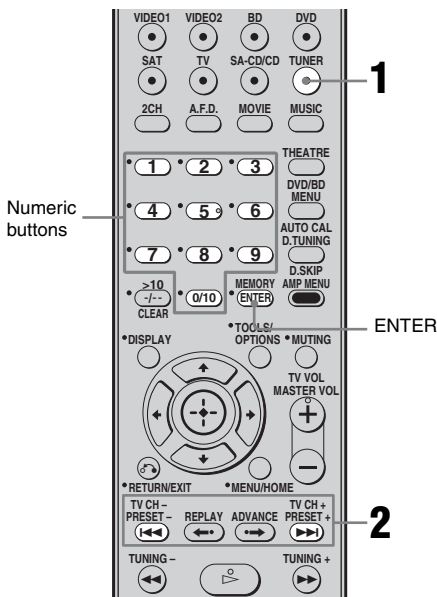

1 Press TUNER repeatedly to select the FM or AM band.

2 Press PRESET + or PRESET - repeatedly to select the preset station you want.

Each time you press the button, you can select a preset station as follows:

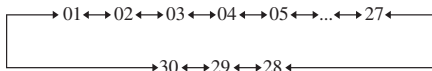

You can also press the numeric buttons to select the preset station you want. Then, press ENTER to enter the selection.

Using the controls on the receiver

1 Press INPUT SELECTOR repeatedly to select the FM or AM band.

2 Press PRESET TUNING + or PRESET TUNING - repeatedly to select the preset station you want.

Using the Radio Data System (RDS)

This receiver also allows you to use RDS (Radio Data System), which enables radio stations to send additional information along with the regular program signal. You can display RDS information.

Notes

- RDS is operable only for FM stations.
- Not all FM stations provide RDS service, nor do they provide the same type of services. If you are not familiar with the RDS services in your area, check with your local radio stations for details.

Receiving RDS broadcasts

Simply select a station on the FM band using direct tuning (page 48), automatic tuning (page 47), or preset tuning (page 49).

When you tune in a station that provides RDS services, “RDS” lights up and the program service name appears on the display.

Note

RDS may not work properly if the station you tuned to is not transmitting the RDS signal properly or if the signal strength is weak.

Displaying RDS information

While receiving an RDS station, press DISPLAY repeatedly.

Each time you press the button, RDS information on the display changes cyclically as follows:

Program Service name → Frequency → Program Type indication^{a)} → Radio Text indication^{b)} → Current Time indication (in 24-hour system mode) → Sound field currently applied → Volume level

^{a)}Type of program being broadcast (page 51).

^{b)}Text messages sent by the RDS station.

Notes

- If there is an emergency announcement by government authorities, “ALARM” flashes in the display.
- When the message consists of 9 characters or more, the message scrolls across the display.
- If a station does not provide a particular RDS service, “NO XXXX” (such as “NO TEXT”) appears on the display.

Description of program types

Program type indication	Description
NEWS	News programs
AFFAIRS	Topical programs that expand on current news
INFO	Programs offering information on a wide spectrum of subjects, including consumer affairs and medical advice
SPORT	Sports programs
EDUCATE	Educational programs, such as "how-to" and advice programs
DRAMA	Radio plays and serials
CULTURE	Programs about national or regional culture, such as language and social concerns
SCIENCE	Programs about the natural sciences and technology
VARIED	Other types of programs such as celebrity interviews, panel games, and comedy
POP M	Popular music programs
ROCK M	Rock music programs
EASY M	Easy Listening
LIGHT M	Instrumental, vocal, and choral music
CLASSICS	Performances of major orchestras, chamber music, opera, etc.
OTHER M	Music that does not fit into any categories above, such as Rhythm & Blues and Reggae
WEATHER	Weather information
FINANCE	Stock market reports and trading, etc.
CHILDREN	Programs for children
SOCIAL	Programs about people and the things that affect them
RELIGION	Programs of religious content
PHONE IN	Programs where members of the public express their views by phone or in a public forum

Program type indication	Description
TRAVEL	Programs about travel. Not for announcements that are located by TP/TA.
LEISURE	Programs on recreational activities such as gardening, fishing, cooking, etc.
JAZZ	Jazz programs
COUNTRY	Country music programs
NATION M	Programs featuring the popular music of the country or region
OLDIES	Programs featuring oldies music
FOLK M	Folk music programs
DOCUMENT	Investigative features
NONE	Any programs not defined above

Using the Control for HDMI function for “BRAVIA” Sync

To use “BRAVIA” Sync, set the Control for HDMI function as explained below.

By connecting Sony components that are compatible with the Control for HDMI function with an HDMI cable (not supplied), operation is simplified as follows:

- **One-Touch Play:** When you play back a component such as a DVD/Blu-ray disc player, the receiver and the TV are turned on automatically and switched to the appropriate HDMI input.
- **System Audio Control:** While watching TV, you can select to output the sound from the TV speaker or the speakers connected to the receiver.
- **System Power Off:** When you turn off the TV, the receiver and connected components are also turned off simultaneously.

Control for HDMI is a mutual control function standard used by HDMI CEC (Consumer Electronics Control) for HDMI (High-Definition Multimedia Interface).

The Control for HDMI function does not work in the following cases:

- When you connect the receiver to a component which does not correspond with Sony Control for HDMI function.
- When you connect the receiver and components using other than HDMI connection.

We recommend that you connect the receiver to products featuring “BRAVIA” Sync.

Note

Depending on the connected component, the Control for HDMI function may not work. Refer to the operating instructions of the component.

Connecting a TV and other components

Before connecting the cords, be sure to disconnect the AC power cord.

To enjoy TV multi channel surround sound broadcasting

You can listen to TV multi channel surround sound broadcasting from the speakers connected to the receiver.

Connect the OPTICAL output jack of the TV to the TV OPT IN jack of the receiver.

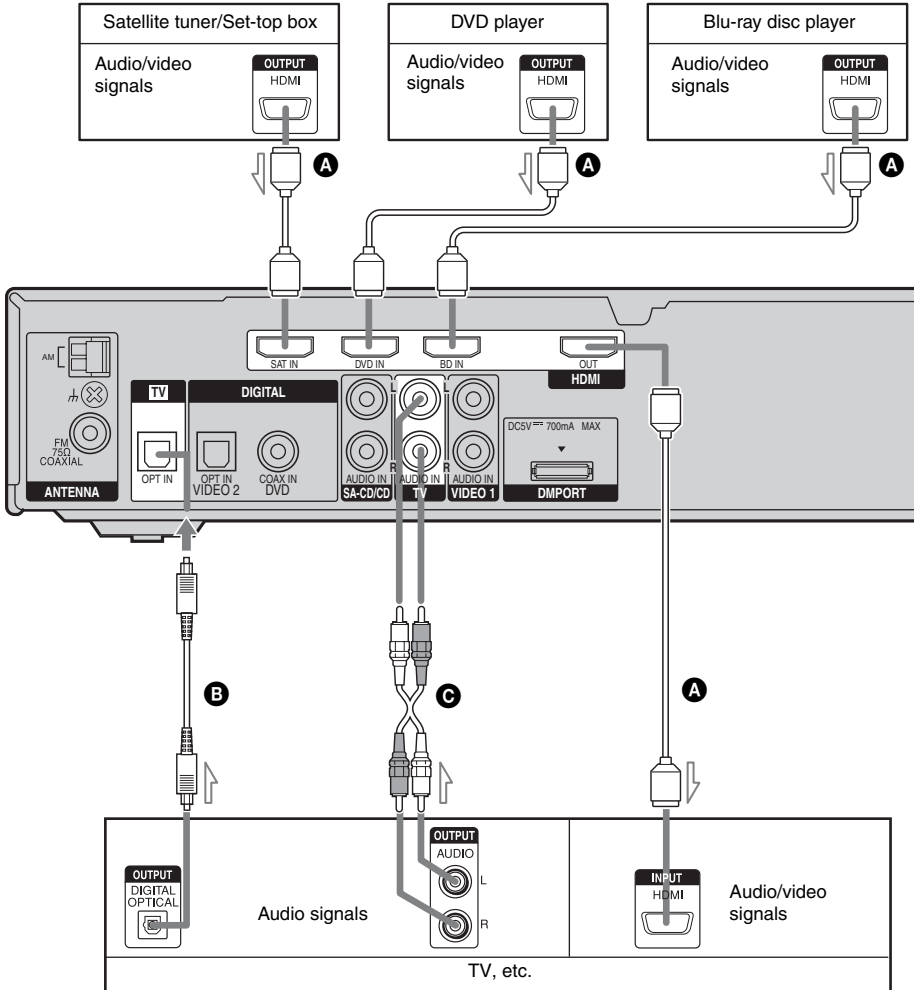

- A** HDMI cable (not supplied)
We recommend that you use a Sony HDMI cable.
- B** Optical digital cord (not supplied)^{a)}
- C** Audio cord (not supplied)^{a)}

^{a)} Connect at least one of the audio cords (**B** or **C**).

Preparing Control for HDMI function

This receiver supports the Control for HDMI-Easy Setting function.

This function is only available for certain types of TV. When you perform the Control for HDMI-Easy Setting from the TV, the Control for HDMI setting on this receiver will automatically change accordingly.

During Control for HDMI-Easy Setting operation, “CONTROL”, “SCAN FOR” and “HDMI” appear sequentially in the display. This receiver will automatically change the input to HDMI input. When the setting is completed, “COMPLETE” appears on the display.

For details, refer to the operating instructions of the TV.

If your TV does not support the Control for HDMI-Easy Setting function, do the following procedures. For details on setting the TV and connected components, refer to the operating instructions of the respective components.

- 1** Make sure that the receiver is connected to the TV and components (compatible with Control for HDMI function) via HDMI connection.
- 2** Turn on the receiver, TV and connected components.
- 3** Set the respective Control for HDMI function for the receiver and TV to on. See “To set Control for HDMI” (page 55). For details on setting the TV, refer to the operating instructions of the TV.
- 4** Select the HDMI input of the receiver and TV to match the HDMI input of the connected component, so that the image from the connected component is displayed.

- 5** Set the Control for HDMI function for the connected component to on.
If the Control for HDMI function for the connected component is already set to on, you do not need to change the setting.
- 6** Repeat steps 4 and 5 for other components that you want to use the Control for HDMI function.

Notes

- If you unplug and reconnect the HDMI cable, be sure to repeat steps 1 to 6 above.
- You cannot perform One-Touch Play and System Audio Control during Control for HDMI-Easy Setting operation.
- Before you do the Control for HDMI-Easy Setting from the TV, be sure to turn on the TV, connected components and receiver.
- If the playback components cannot function after you have made the settings for Control for HDMI-Easy Setting, check the Control for HDMI setting on your TV.
- If the connected components do not support Control for HDMI-Easy Setting, you need to set the Control for HDMI function for the connected components to on before you perform the Control for HDMI-Easy Setting from the TV.

To set Control for HDMI

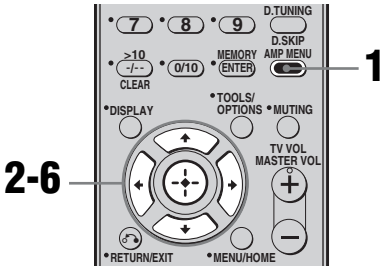

- 1 Press AMP MENU.**
“1-LEVEL” appears on the display.
- 2 Press ↑/↓ repeatedly to select “6-VIDEO”.**
- 3 Press ⊕ or → to enter the menu.**
- 4 Press ↑/↓ repeatedly to select “CONTROL FOR HDMI”.**
“CONTROL FOR HDMI” scrolls across the display, then “CONTROL” appears.
- 5 Press ⊕ or → to enter the parameter.**
- 6 Press ↑/↓ repeatedly to select “CTRL ON”.**
Control for HDMI function is activated.

Watching a DVD (One-Touch Play)

You can enjoy sound and image from the components connected to the receiver via HDMI connections by a simple operation.

Play back a connected component.

The receiver and the TV are turned on automatically and switched to the appropriate HDMI input.

Watching a DVD by simple operation

You can also select a connected component, such as a DVD/Blu-ray disc player using the TV menu. In this case, the receiver and the TV switch to the appropriate HDMI input.

Note

Depending on the TV, the start of the content may not be output.

Tip

You can enjoy the components that are connected to the HDMI jacks, even if you turn the receiver off. The ACTIVE STANDBY indicator lights up in amber.

Enjoying the TV sound from the speakers connected to the receiver (System Audio Control)

You can enjoy the TV sound from the speakers connected to the receiver by a simple operation.

You can operate System Audio Control function using the TV menu. For details, refer to the operating instructions of the TV. When System Audio Control function is turned on, the receiver will turn on and switches to the appropriate input automatically.

TV sound is output from the speakers connected to the receiver, and the volume of the TV is minimized simultaneously.

You can use the System Audio Control function as follows.

- If you turn on the receiver while the TV is turned on, the System Audio Control function will automatically be set to on and the TV sound will output from the speakers connected to the receiver. However, if you turn off the receiver, the sound will output from the TV speakers.
- You can adjust the receiver's volume when you adjust the TV volume.

Notes

- If System Audio Control does not function according to your TV setting, refer to the operating instructions of the TV.
- When "CONTROL FOR HDMI" is set to "CTRL ON", the "AUDIO FOR HDMI" settings in the VIDEO menu will set automatically depending on the System Audio Control settings.
- When you connect a TV that does not have System Audio Control function, the System Audio Control function does not work.
- If the TV is turned on before turning on the receiver, the TV sound will not be output for a moment.
- When you switch to an input other than HDMI or TV, the System Audio Control function will automatically be set to off.
- If you switch from other input to HDMI or TV input, the System Audio Control function will automatically be set to on.

Turning off the receiver with the TV

(System Power Off)

When you turn the TV off by using the POWER button on the TV's remote, the receiver and the connected components turn off automatically.

You can also use the receiver's remote to turn off the TV.

Notes

- Set the TV Standby Synchro to "ON" before using the System Power Off function. For details, refer to the operating instructions of the TV.
- Depending on the status, the connected components may not be turned off. For details, refer to the operating instructions of the connected components.

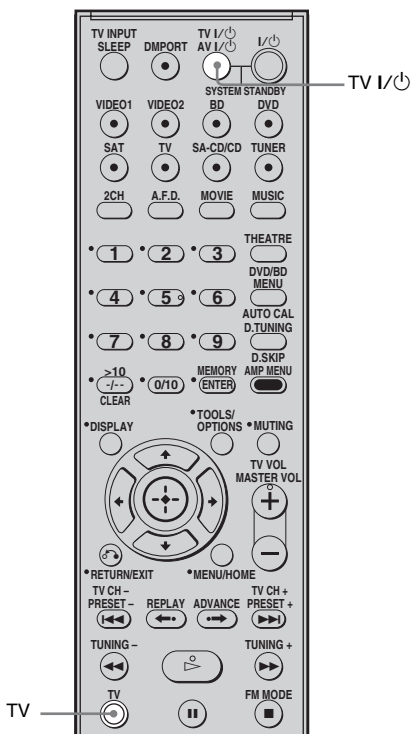

Press TV and TV I/⏻ at the same time.

The TV, receiver and the components connected via HDMI are turned off.

Switching between digital and analog audio (IN MODE)

You can select the audio input mode setting when you connect components to both digital and analog audio input jacks on the receiver.

- 1 Press AMP MENU.**
“1-LEVEL” appears on the display.
- 2 Press \uparrow/\downarrow repeatedly to select “5-AUDIO”.**
- 3 Press \odot or \rightarrow to enter the menu.**
- 4 Press \uparrow/\downarrow repeatedly to select “IN MODE”.**
- 5 Press \odot or \rightarrow to enter the parameter.**
- 6 Press \uparrow/\downarrow repeatedly to select the audio input you want.**

Audio input modes

■ AUTO

Gives priority to digital audio signals when there are both digital and analog connections. If there are more than one digital connection, HDMI audio signals have priority over COAXIAL and OPTICAL audio signals. If there are no digital audio signals, analog audio signals are selected.

■ ANALOG

Specifies the analog audio signals input to the AUDIO IN (L/R) jacks.

Note

Some audio input modes may not be set up depending on the input.

Enjoying the DIGITAL MEDIA PORT (DMPORT)

The DIGITAL MEDIA PORT (DMPORT) allows you to enjoy sound from a network system such as a portable audio source or computer.

By connecting a DIGITAL MEDIA PORT adapter (not supplied), you can enjoy sound from the connected component on the receiver.

For details, see the operating instructions supplied with the DIGITAL MEDIA PORT adapter.

Notes

- Do not connect an adapter other than the DIGITAL MEDIA PORT adapter.
- Do not connect or disconnect the DIGITAL MEDIA PORT adapter while the receiver is turned on.
- Before connecting cords, make sure to disconnect the AC power cord (mains lead).
- Depending on the DIGITAL MEDIA PORT adapter, video output may not be possible.
- The DIGITAL MEDIA PORT adapters are available for purchase depending on the area.

Connecting the DIGITAL MEDIA PORT adapter

You can listen to the sound from the component connected through the DIGITAL MEDIA PORT adapter to the DMPORT jack on the receiver.

You can also view the images on the TV screen by connecting the video output of the DIGITAL MEDIA PORT adapter to the video input of the TV.

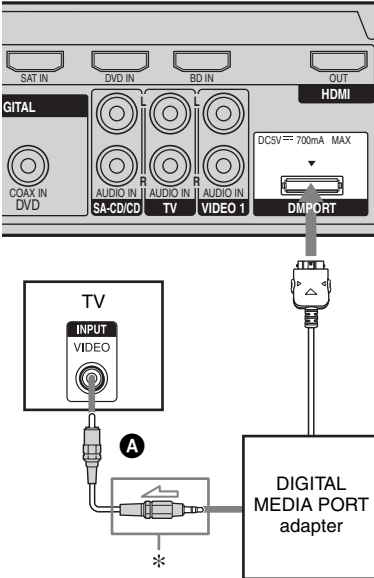

* The type of connector varies depending on the DIGITAL MEDIA PORT adapter.
For details, see the operating instructions supplied with the DIGITAL MEDIA PORT adapter.

A Video cord (not supplied)

To detach the DIGITAL MEDIA PORT adapter from DMPORT jack

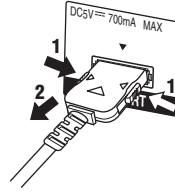

Press and hold both sides of the connector and then pull out the connector.

Notes

- When connecting the DIGITAL MEDIA PORT adapter, be sure the connector is inserted with the arrow mark facing toward the arrow on the DMPORT jack.
- Be sure to make DMPORT connections firmly, insert the connector straight in.
- As the connector of the DIGITAL MEDIA PORT adapter is fragile, be sure to handle with care when placing or moving the receiver.

Listening/watching a connected component through DMPORT connection

1 Press DMPORT.

You can also use the INPUT SELECTOR on the receiver to select “DMPORT”.

2 Start playback of the connected component.

The sound is played back on the receiver and the image appears on the TV.

For details, refer to the operating instructions supplied with the DIGITAL MEDIA PORT adapter.

Notes

- Depending on the type of DIGITAL MEDIA PORT adapter, you can operate the connected component by using the remote. For details on remote button operation, see page 8.
- Be sure you have made the video connection from DIGITAL MEDIA PORT adapter to the TV (page 59).
- Depending on the DIGITAL MEDIA PORT adapter, video output may not be possible.

Tip

When listening to MP3 or other compressed music using a portable audio source, you can enhance the sound. Press MUSIC repeatedly to select “PORTABLE” (page 44).

Using the Sleep Timer

You can set the receiver to turn off automatically at a specified time.

Press SLEEP repeatedly while the power is on.

Each time you press the button, the display changes cyclically as follows:

2-00-00 → 1-30-00 → 1-00-00 → 0-30-00
→ OFF

When sleep timer is activated, the display dims and “SLEEP” indicator lights up.

Note

If you press any buttons on the remote or receiver after the display dims, the display brightens up. After a while, the display dims again if no button is pressed.

Tip

To check the remaining time before the receiver turns off, press SLEEP. The remaining time appears on the display. If you press SLEEP again, the sleep timer will be canceled.

Changing button assignments

You can change the factory settings of the input buttons to suit the components in your system. For example, if you connect a DVD recorder to the VIDEO 1 jacks on the receiver, you can set the VIDEO 1 button on this remote to control the DVD recorder.

1 Hold down the input button of which you want to change the assignment.

Example: Hold down VIDEO 1.

2 Referring to the table below, press the corresponding button for the category you want.

Example: Press 4.

Now you can use the VIDEO 1 button to control the DVD recorder.

Categories and the corresponding buttons

Categories	Press
VCR (command mode VTR 3) ^{a)}	1
VCR (command mode VTR 2) ^{a)}	2
DVD player/DVD recorder (command mode DVD1) ^{b)}	3
DVD recorder (command mode DVD3) ^{b)}	4
CD player	5
Euro Digital Satellite Receiver	6
DVR (Digital CATV terminal)	7
DSS (Digital Satellite Receiver)	8
Blu-ray disc player (command mode BD1) ^{c)}	9
Blu-ray disc recorder (command mode BD3) ^{c)}	0/10
TV	-/--
Not assigned	ENTER/ MEMORY

^{a)} Sony VCRs are operated with a VTR 2 or VTR 3 setting which correspond to 8 mm and VHS respectively.

^{b)} Sony DVD recorders are operated with a DVD1 or DVD3 setting. For details, refer to the operating instructions supplied with the DVD recorders.

^{c)} For details on the BD1 or BD3 setting, refer to the operating instructions supplied with the Blu-ray disc player or Blu-ray disc recorder.

To clear all remote button assignments

Press I/⏪, DMPORT and MASTER VOL – at the same time.

The remote is reset to its factory settings.

Glossary

■ Cinema Studio EX

A surround sound mode that can be regarded as the compilation of Digital Cinema Sound technology, delivers the sound of a dubbing theater using three technologies: “Virtual Multi Dimensions”, “Screen Depth Matching”, and “Cinema Studio Reverberation”.

“Virtual Multi Dimensions”, the virtual speaker technology, creates a virtual multi-surround environment with actual speakers up to 7.1 channels, and brings the surround sound experience of a theater with the latest facilities into your home.

“Screen Depth Matching” reproduces treble attenuation, fullness, and depth of sound usually created in a theater using sound emission from behind the screen. This is then added to the front and center channels.

“Cinema Studio Reverberation” reproduces the sound characteristics of state-of-the-art dubbing theaters and recording studios, including Sony Pictures Entertainment’s dubbing studios. There are three modes, A/B/C, available according to the studio type.

■ Digital Cinema Sound (DCS)

A unique sound reproduction technology for home theater developed by Sony, in cooperation with Sony Pictures Entertainment, for enjoying the exciting and powerful sound of movie theaters at home. With this “Digital Cinema Sound” developed by integrating a DSP (Digital Signal Processor) and measured data, the ideal sound field intended by filmmakers can be experienced at home.

■ Dolby Digital

Digital audio encoding/decoding technology developed by Dolby Laboratories, Inc. It consists of front (Left/Right), center, surround (Left/Right) and subwoofer channels. It is a designated audio standard for DVD-video and also known as 5.1 channel surround. Since surround information is recorded and reproduced in stereo, more realistic sound with fuller presence is delivered than with Dolby surround.

■ Dolby Pro Logic II

This technology converts 2 channel stereo recorded audio into 5.1 channel for playback. There is a MOVIE mode for movies and MUSIC mode for stereo sources such as music. Old movies encoded in the traditional stereo format can be enhanced with 5.1 channel surround sound.

■ Dolby Surround (Dolby Pro Logic)

Audio processing technology developed by Dolby Laboratories, Inc. Center and mono surround information is matrixed into two stereo channels. When reproduced, audio is decoded and output in 4 channel surround sound. This is the most common audio processing method for DVD-video.

■ DTS Digital Surround

Digital audio encoding/decoding technology for theaters developed by DTS, Inc. It compresses audio less than Dolby Digital, delivering a higher quality sound reproduction.

■ HDMI (High-Definition Multimedia Interface)

HDMI (High-Definition Multimedia Interface) is an interface that supports both video and audio on a single digital connection, allowing you to enjoy high quality digital picture and sound. The HDMI specification supports HDCP (High-bandwidth Digital Contents Protection), a copy protection technology that incorporates coding technology for digital video signals.

■ L.F.E. (Low Frequency Effects)

Sound effects of low frequencies which are output from a subwoofer in Dolby Digital or DTS, etc. By adding a deep bass with a frequency between 20 to 120 Hz, audio becomes more powerful.

■ Sampling frequency

To convert analog audio to digital, analog data should be quantified. This process is called sampling, and the number of times per second the analog data is quantified is called the sampling frequency. A standard music CD stores data quantified at 44,100 times per second, which is expressed as a sampling frequency of 44.1 kHz. Generally speaking, a higher sampling frequency means better sound quality.

■ TSP (Time Stretched Pulse)

A TSP signal is a highly precise measuring signal that utilizes impulse energy, measuring a wide band, from low to high, in a short period.

The amount of energy used to measure signals is important to ensure measurement accuracy in a normal indoor environment. Using TSP signals makes it possible to measure signals effectively.

■ x.v.Colour

x.v.Colour is a more familiar term for the xvYCC standard proposed by Sony, and is a trademark of Sony. xvYCC is an international standard for colour space in video.

This standard can express a wider colour range than the currently used broadcast standard.

Precautions

On safety

Should any solid object or liquid fall into the cabinet, unplug the receiver and have it checked by qualified personnel before operating it any further.

On power sources

- Before operating the receiver, check that the operating voltage is identical with your local power supply.
The operating voltage is indicated on the nameplate on the back of the receiver.
- The unit is not disconnected from the AC power source (mains) as long as it is connected to the wall outlet, even if the unit itself has been turned off.
- If you are not going to use the receiver for a long time, be sure to disconnect the receiver from the wall outlet. To disconnect the AC power cord, grasp the plug itself; never pull the cord.
- The AC power cord must be changed only at a qualified service shop.

On heat buildup

Although the receiver heats up during operation, this is not a malfunction. If you continuously use this receiver at a large volume, the cabinet temperature of the top, side and bottom rises considerably. To avoid burning yourself, do not touch the cabinet.

On placement

- Place the receiver in a location with adequate ventilation to prevent heat buildup and prolong the life of the receiver.
- Do not place the receiver near heat sources, or in a place subject to direct sunlight, excessive dust, or mechanical shock.
- Do not place anything on top of the cabinet that might block the ventilation holes and cause malfunctions.
- Do not place the receiver near equipment such as a TV, VCR, or tape deck. (If the receiver is being used in combination with a TV, VCR, or tape deck, and is placed too close to that equipment, noise may result, and picture quality may suffer. This is especially likely when using an indoor antenna. Therefore, we recommend using an outdoor antenna).
- Use caution when placing the receiver or speakers on surfaces that have been specially treated (with wax, oil, polish, etc.) as staining or discoloration of the surface may result.

On operation

Before connecting other components, be sure to turn off and unplug the receiver.

If you encounter color irregularity on a nearby TV screen

The front speakers and the center speaker are magnetically shielded to allow it to be installed near a TV set. However, color irregularities may still be observed on certain types of TV sets. As the surround speakers and the subwoofer are not magnetically shielded, we recommend that you place the surround speakers and the subwoofer slightly further away from TV set (page 11).

If color irregularity is observed...

Turn off the TV set, then turn it on again after 15 to 30 minutes.

If color irregularity is observed again...

Place the speaker further away from the TV set.

If howling occurs

Reposition the speakers or turn down the volume on the receiver.

On cleaning

Clean the cabinet, panel, and controls with a soft cloth slightly moistened with a mild detergent solution. Do not use any type of abrasive pad, scouring powder, or solvent, such as alcohol or benzine.

If you have any questions or problems concerning your receiver, please consult your nearest Sony dealer.

Troubleshooting

If you experience any of the following difficulties while using the receiver, use this troubleshooting guide to help you remedy the problem.

Audio

There is no sound, no matter which component is selected, or only a very low-level sound is heard.

- Check that the speakers and components are connected securely.
- Check that both the receiver and all components are turned on.
- Check that MASTER VOLUME is not set to “VOL MIN”.
- Press MUTING to cancel the muting function.
- Check that you have selected the correct component with the input buttons on the remote or INPUT SELECTOR on the receiver.
- The protective device on the receiver has been activated. Turn off the receiver, eliminate the short-circuit problem, and turn on the power again.
- Check that the IN MODE setting is correct.

There is no sound from a specific component.

- Check that the component is connected correctly to the audio input jacks for that component.
- Check that the cord(s) used for the connection is (are) fully inserted into the jacks on both the receiver and the component.
- Check that you have selected the correct component with the input buttons on the remote or INPUT SELECTOR on the receiver.

There is no sound from one of the front speakers.

- Make sure you have connected to both the L and R jacks of an analog component, and not only to either the L or R jack. Use an audio cord (not supplied)

The left and right sounds are unbalanced or reversed.

- Check that the speakers and components are connected correctly and securely.
- Adjust the balance parameters using the LEVEL menu (page 37).

There is severe hum or noise.

- Check that the speakers and components are connected securely.
- Check that the connecting cords are away from a transformer or motor, and at least 3 m away from a TV set or fluorescent light.
- Move your audio components away from the TV.
- The plugs and jacks are dirty. Wipe them with a cloth slightly moistened with alcohol.

There is pop noise from a specific component connected to this receiver when you turn on the component.

- Check that the IN MODE is set to “AUTO” for the selected input (page 58).

There is no sound, or only a very low-level sound is heard from the center/surround speakers.

- Select a CINEMA STUDIO EX mode (page 45).
- Adjust the speaker level (page 28).
- Check that the speakers are connected securely.

There is no sound from the subwoofer.

- Check that the subwoofer is connected correctly and securely.

The surround effect cannot be obtained.

- Make sure you have selected a sound field with MOVIE or MUSIC button.
- Sound fields do not function for signals with a sampling frequency of more than 48 kHz.

Dolby Digital or DTS multi channel sound is not reproduced.

- Check that the DVD, etc. you are playing is recorded in Dolby Digital or DTS format.
- When connecting the DVD player, etc., to the digital input jacks of this receiver, check the audio setting (the settings for the audio output) of the connected component.

There is no sound from the component connected to the DIGITAL MEDIA PORT adapter.

- Adjust the volume of this receiver.
- The DIGITAL MEDIA PORT adapter and/or component is not connected correctly. Turn off the receiver, then reconnect the DIGITAL MEDIA PORT adapter and/or component.
- Check the DIGITAL MEDIA PORT adapter and/or component device to make sure it supports this receiver.

Video

There is no picture or an unclear picture appears on the TV screen or monitor.

- Make sure you have connected the video output of your video component to the TV.
- Move your audio components away from the TV

HDMI

The source sound input to the HDMI jack on the receiver is not output from the TV speaker.

- Check the setting of “AUDIO FOR HDMI” in the VIDEO menu (page 40).
- Check the HDMI connection.
- You cannot listen to the Super Audio CD by connecting HDMI.
- Depending on the playback component, you may need to set up the component. Refer to the operating instructions supplied with each component.

The source image input to the HDMI jack on the receiver is not output from the TV.

- Check the HDMI connection.
- Depending on the playback component, you may need to set up the component. Refer to the operating instructions supplied with each component.

The Control for HDMI function does not work.

- Check the HDMI connection (page 53).
- Make sure “CONTROL FOR HDMI” is set to “CTRL ON” in the VIDEO menu.
- Make sure the connected component is compatible with the Control for HDMI function.
- Check the Control for HDMI settings on the connected component. Refer to the operating instructions of the connected component.
- Repeat the procedures of “Preparing Control for HDMI function” if you change the HDMI connection, connect/disconnect the AC power cord, or when there is a power failure (page 54).

No sound is output from the receiver and TV speaker while using the System Audio Control function.

- Make sure the TV is compatible with the System Audio Control function.
 - If the TV does not have System Audio Control function, set the “AUDIO FOR HDMI” settings in VIDEO menu to
 - “TV+AMP” if you want to listen to the sound from the TV speaker and receiver.
 - “AMP” if you want to listen to the sound from the receiver.
 - If you cannot listen to the sound of a component connected to the receiver
 - Select the appropriate input when you want to watch a program on a component connected via HDMI connection to the receiver.
 - Change the TV channel when you want to watch a TV broadcast.
 - Select the component or input you want to watch when you watch a program on the component connected to the TV.Refer to the operating instructions of the TV on this operation.
-

Tuner

The FM reception is poor.

- Use a 75-ohm coaxial cable (not supplied) to connect the receiver to an outdoor FM antenna as shown below. If you connect the receiver to an outdoor antenna, ground it against lightning. To prevent a gas explosion, do not connect the ground wire to a gas pipe.

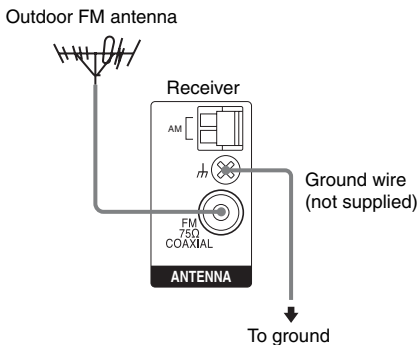

Radio stations cannot be tuned in.

- Check that the antennas are connected securely. Adjust the antennas and connect an external antenna, if necessary.
- The signal strength of the stations is too weak (when tuning in with automatic tuning). Use direct tuning (page 48).
- Make sure you set the tuning interval correctly (when tuning in AM stations with direct tuning).
- No stations have been preset or the preset stations have been cleared (when tuning by scanning preset stations). Preset the stations (page 48).

RDS does not work.

- Make sure that you are tuned to an FM RDS station.
- Select a stronger FM station.

The RDS information that you want does not appear.

- Contact the radio station and find out whether they actually provide the service in question. If so, the service may be temporarily out of order.
-

Remote control

The remote does not function.

- For receiver operation, you can only use the DISPLAY button when the TUNER input is selected.
 - Point the remote at the remote sensor on the receiver.
 - Remove any obstacles in the path between the remote and the receiver.
 - Replace all the batteries in the remote with new ones, if they are weak.
 - Make sure you select the correct input on the remote.
-

Error messages

If there is a malfunction, the display shows a message. You can check the condition of the system by the message. Refer to the following table to solve the problem. If any problem persists, consult your nearest Sony dealer.

If an error message appears while you perform Auto Calibration, see “When error codes appear” (page 26) to solve the problem.

PROTECT

Irregular current is output from the speakers. The receiver will automatically turn off after a few seconds. Check the speaker connection and turn on the power again.

If you are unable to remedy the problem using the troubleshooting guide

Clearing the receiver’s memory may remedy the problem (page 22). However, note that all memorized settings will be reset to their factory settings and you will have to readjust all settings on the receiver.

If the problem persist

Consult your nearest Sony dealer. Note that if service personnel changes some parts during repair, these parts may be retained.

Reference sections for clearing the receiver’s memory

To clear	See
All memorized settings	page 22
Customized sound fields	page 46

Specifications

Amplifier section

Power Output¹⁾

Stereo mode (rated) 108 W + 108 W
(3 ohms at 1 kHz,
THD 1%)

Surround mode (reference)

RMS Output
(3 ohms at 1 kHz,
THD 10%)
FRONT²⁾: 143 W/ch
CENTER²⁾: 143 W
SUR²⁾: 143 W/ch
(1.5 ohms at 80 Hz,
THD 10%)
SUBWOOFER²⁾: 285 W

¹⁾Measured under the following conditions:

Area code	Power requirements
CEL, CEK	230 V AC, 50 Hz

²⁾Reference power output for front, center, surround speakers and subwoofer. Depending on the sound field settings and the source, there may be no sound output.

Inputs

Analog Sensitivity: 1 V/50 kohms
Digital (Coaxial) Impedance: 75 ohms

Tone

Gain levels ±10 dB, 0.5 dB step

Reproduction frequency range:

28 – 20,000 Hz

FM tuner section

Tuning range 87.5 – 108.0 MHz
Antenna FM wire antenna
Antenna terminals 75 ohms, unbalanced
Intermediate frequency
10.7 MHz

AM tuner section

Tuning range

Models of area code CEL, CEK

With 9-kHz tuning scale:

531 – 1,602 kHz

Antenna Loop antenna

Intermediate frequency
450 kHz

General

Power requirements

Area code	Power requirements
CEL, CEK	230 V AC, 50/60 Hz

Power output (DIGITAL MEDIA PORT)

DC OUT: 5 V, 700 mA MAX

Power consumption

Area code	Power consumption
CEL, CEK	165 W

Power consumption (during standby mode)

0.3 W (When “CONTROL FOR HDMI” in VIDEO menu is set to “CTRL OFF”)

Dimensions (w/h/d) (Approx.)

430 × 66.5 × 335 mm
including projecting parts
and controls

Mass (Approx.) 3.6 kg

Speaker section

HT-SF1300 only

- Front speaker (SS-MSP23F)
- Surround speaker (SS-SRP23F)
- Center speaker (SS-CNP23)

Front/Center speaker	Full range, magnetically shielded
Surround speaker	Full range
Speaker unit	
Front/Surround speaker	65 mm, cone type
Center speaker	30 × 60 mm, cone type
Enclosure type	
Front/Surround speaker	Bass reflex
Center speaker	Acoustic suspension
Rated Impedance	3.0 ohms
Dimension (w/h/d) (Approx.)	
Front speaker	113 × 830 × 83 mm (without stand) 315 × 1,015 - 1,345 × 315 mm (with stand)
Surround speaker	108 × 540 × 78 mm (without stand) 290 × 1,045 - 1,235 × 290 mm (with stand)
Center speaker	380 × 50 × 64 mm (with foot)
Mass (Approx.)	
Front speaker	1.7 kg (without stand) 3.5 kg (with stand)
Surround speaker	1.1 kg (without stand) 2.8 kg (with stand)
Center speaker	0.38 kg

• Subwoofer (SS-WP23)

Speaker unit	160 mm, cone type
Enclosure type	Bass reflex
Rated Impedance	1.5 ohms
Dimensions (w/h/d) (Approx.)	220 × 395 × 325 mm (with foot)
Mass (Approx.)	5.9 kg

HT-SS1300 only

- Front speaker (SS-MSP23S)
- Surround speaker (SS-SRP23S)
- Center speaker (SS-CNP23)

Front/Center speaker	Full range, magnetically shielded
Surround speaker	Full range
Speaker unit	
Front/Surround speaker	65 mm, cone type
Center speaker	30 × 60 mm, cone type
Enclosure type	
Front/Surround speaker	Bass reflex
Center speaker	Acoustic suspension
Rated Impedance	3.0 ohms
Dimension (w/h/d) (Approx.)	
Front/surround speaker	102 × 163 × 77 mm (with foot)
Center speaker	380 × 50 × 64 mm (with foot)
Mass (Approx.)	
Front speaker	0.55 kg
Surround speaker	0.45 kg
Center speaker	0.38 kg
• Subwoofer (SS-WP23)	
Speaker unit	160 mm, cone type
Enclosure type	Bass reflex
Rated Impedance	1.5 ohms
Dimensions (w/h/d) (Approx.)	220 × 395 × 325 mm (with foot)
Mass (Approx.)	5.9 kg

Supplied speakers

Front speakers (2)
Center speaker (1)
Surround speakers (2)
Subwoofer (1)

Supplied accessories

Operating Instruction (this manual)
Quick Setup Guide (1)
Speaker Stand Installation Guide (HT-SF1300 only) (1)
FM wire antenna (1)
AM loop antenna (1)
Remote commander RM-AAU023 (1)
R6 (size-AA) batteries (2)
Optimizer microphone (ECM-AC2) (1)
Speaker cords (5)
Foot pads

- Speakers
 - HT-SS1300 only (20)
 - HT-SF1300 only (4)
- Subwoofer (4)

Screws (small) (HT-SF1300 only) (12)
Screws (large) (HT-SF1300 only) (8)

For details on the area code of the component you are using, see page 3.
--

Design and specifications are subject to change without notice.

Index

Numerics

- 2 channel 46
- 2CH STEREO 46
- 5.1 channel 11

A

- AUTO CALIBRATION 23
- AUTO FORMAT DIRECT (A.F.D.) 43

B

- Blu-ray disc player
 - connecting 17
 - playback 32

C

- CD player
 - connecting 16
 - playback 31
- Control for HDMI
 - connecting 53
 - preparing 54

D

- Digital Cinema Sound (DCS) 45
- DIGITAL MEDIA PORT
 - connecting 59
- Dolby Digital 62
- DVD player
 - connecting 19
 - playback 32
- DVD recorder
 - connecting 19

E

- Error messages 68

H

- HDMI
 - connecting 17

I

- IN MODE 58
- Initial setup 22

M

- Menu
 - A. CAL 28
 - AUDIO 39
 - LEVEL 37
 - SUR 38
 - SYSTEM 41
 - TONE 38
 - TUNER 39
 - VIDEO 40
- Muting 30

O

- One-Touch Play 55

R

- RDS 50

S

- Selecting
 - component 30
 - sound field 44
- Sleep Timer 60
- Sound fields
 - resetting 46
 - selecting 44
- Speakers
 - connecting 14
 - installing 11
- Super Audio CD player
 - connecting 16
 - playback 31
- System Audio Control 56
- System Power Off 57

T

- TEST TONE 28
- Tuner
 - connecting 21
- Tuning
 - automatically 47
 - directly 48
 - to preset stations 49
- TV
 - connecting 19

V

- VCR
 - connecting 19



* 3 2 9 5 9 4 6 1 2 * (1)

Free Manuals Download Website

<http://myh66.com>

<http://usermanuals.us>

<http://www.somanuals.com>

<http://www.4manuals.cc>

<http://www.manual-lib.com>

<http://www.404manual.com>

<http://www.luxmanual.com>

<http://aubethermostatmanual.com>

Golf course search by state

<http://golfingnear.com>

Email search by domain

<http://emailbydomain.com>

Auto manuals search

<http://auto.somanuals.com>

TV manuals search

<http://tv.somanuals.com>