

DAV-IS50

DVD Home Theatre System

Operating Instructions



WARNING

To reduce the risk of fire or electric shock, do not expose this apparatus to rain or moisture.

Do not install the appliance in a confined space, such as a bookcase or built-in cabinet.

To reduce the risk of fire, do not cover the ventilation opening of the apparatus with newspapers, tablecloths, curtains, etc.

Do not place the naked flame sources such as lighted candles on the apparatus.

To reduce the risk of fire or electric shock, do not expose this apparatus to dripping or splashing, and do not place objects filled with liquids, such as vases, on the apparatus.

Do not expose batteries or apparatus with battery-installed to excessive heat such as sunshine, fire or the like.

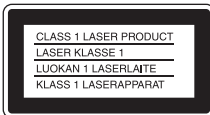

This appliance is classified as a CLASS 1 LASER product. This label is located at the bottom of the exterior.

For customers in Europe



Disposal of Old Electrical & Electronic Equipment (Applicable in the European Union and other European countries with separate collection systems)

This symbol on the product or on its packaging indicates that this product shall not be treated as household waste. Instead it shall be handed over to the applicable collection point for the recycling of electrical and electronic equipment. By ensuring this product is disposed of correctly, you will help prevent potential negative consequences for the environment and human health, which could otherwise be caused by inappropriate waste handling of this product. The recycling of materials will help to conserve natural resources. For more detailed information about recycling of this product, please contact your local Civic Office, your household waste disposal service or the shop where you purchased the product.

For customers in Europe



Disposal of waste batteries (applicable in the European Union and other European countries with separate collection systems)

This symbol on the battery or on the packaging indicates that the battery provided with this product shall not be treated as household waste.

On certain batteries this symbol might be used in combination with a chemical symbol. The chemical symbols for mercury (Hg) or lead (Pb) are added if the battery contains more than 0.0005% mercury or 0.004% lead.

By ensuring these batteries are disposed of correctly, you will help prevent potentially negative consequences for the environment and human health which could otherwise be caused by inappropriate waste handling of the battery. The recycling of the materials will help to conserve natural resources.

In case of products that for safety, performance or data integrity reasons require a permanent connection with an incorporated battery, this battery should be replaced by qualified service staff only.

To ensure that the battery will be treated properly, hand over the product at end-of-life to the applicable collection point for the recycling of electrical and electronic equipment.

For all other batteries, please view the section on how to remove the battery from the product safely. Hand the battery over to the applicable collection point for the recycling of waste batteries.

For more detailed information about recycling of this product or battery, please contact your local Civic Office, your household waste disposal service or the shop where you purchased the product.

Notice for the customer in the countries applying EU Directives

The manufacturer of this product is Sony Corporation, 1-7-1 Konan Minato-ku Tokyo, 108-0075 Japan. The Authorized Representative for EMC and product safety is Sony Deutschland GmbH, Hedelfinger Strasse 61, 70327 Stuttgart, Germany. For any service or guarantee matters please refer to the addresses given in separate service or guarantee documents.

Precautions

On power sources

- AC power cord must be changed only at a qualified service shop.
- The unit is not disconnected from the AC power source (mains) as long as it is connected to the wall outlet (mains), even if the unit itself has been turned off.
- As the main plug is used to disconnect the unit from the mains, connect the unit to an easily accessible AC outlet. Should you notice an abnormality in the unit, disconnect the main plug from the AC outlet immediately.

About This Operating Instructions

- The instructions in this Operating Instructions describe the controls on the remote. You can also use the controls on the control unit if they have the same or similar names as those on the remote.
- The Control Menu items may be different depending on the area.
- “DVD” may be used as a general term for a DVD VIDEO, DVD+RW/DVD+R, and DVD-RW/DVD-R.
- The default setting is underlined.

About the S-AIR function

The system is compatible with the S-AIR function, which allows transmission of sound between S-AIR products wirelessly.

The following S-AIR products can be used with the system:

- Surround amplifier (supplied): You can enjoy surround speaker sound wirelessly.
- S-AIR receiver (optional): You can enjoy system sound in another room.

The S-AIR receiver can be purchased as an option (the S-AIR product lineup differs depending on the area).

Notes or instructions for the surround amplifier or S-AIR receiver in this operating instructions refer only to when the surround amplifier or S-AIR receiver is used.

For details on the S-AIR function, see “Using an S-AIR Product” (page 74).

Table of Contents

About This Operating Instructions.....	3
About the S-AIR function.....	3
Playable Discs.....	6
Getting Started	
Step 1: Positioning the Speakers.....	12
Step 2: Connecting the System.....	19
Step 3: Setting up the Wireless System.....	32
Step 4: Performing the Quick Setup.....	34
Basic Operations	
Playing a Disc.....	38
Enjoying the Radio or Other Components.....	41
Enjoying Sound from all Speakers.....	43
Various Functions for Playing Discs	
Searching for a Title/Chapter/Track/ Scene, etc.....	44
Resuming Playback from the Point Where You Stopped the Disc.....	45
(Resume Play)	
Creating Your Own Program.....	46
(Program Play)	
Playing in Random Order.....	47
(Shuffle Play)	
Playing Repeatedly.....	48
(Repeat Play)	
Using the DVD's Menu.....	49
Changing the Sound.....	50
Selecting [ORIGINAL] or [PLAY LIST] on a DVD-VR.....	51
Viewing Information About the Disc ...	52
Changing the Angles.....	54
Displaying the Subtitles.....	55
Adjusting the Delay Between the Picture and Sound.....	55
(A/V SYNC)	
Playing MP3 Files/JPEG Image Files ..	56
Playing MP3 Files and JPEG Image Files as a Slide Show with Sound.....	59
Enjoying DivX® Videos.....	60
Playing a VIDEO CD with PBC Functions (Ver.2.0).....	62
(PBC Playback)	
Sound Adjustments	
Enjoying Surround Sound by Using Decoding Mode.....	63
Selecting the Sound Mode.....	65
Adjusting the Bass, Middle, and Treble Level.....	66
Tuner Functions	
Presetting Radio Stations.....	67
Listening to the Radio.....	68
Using the Radio Data System (RDS) ...	70
Control for HDMI/External Audio Device	
Using the Control for HDMI Function for "BRAVIA" Sync.....	70
Using the DIGITAL MEDIA PORT Adapter.....	73
Using an S-AIR Product.....	74

Other Operations

Controlling the TV with the Supplied Remote	80
Enjoying Multiplex Broadcast Sound... (DUAL MONO)	82
Enjoying the Sound at Low Volume..... (NIGHT MODE)	83
Using the Sleep Timer	83
Changing the Brightness of the Front Panel Display	84
Changing the Display Mode	84
(INFORMATION MODE)	
Changing the Display Appearance of the Soft-touch Buttons.....	85
(ILLUMINATION MODE)	











Advanced Settings and Adjustments

Restricting Playback of the Disc..... (PARENTAL CONTROL)	86
Calibrating the Appropriate Settings Automatically	88
(AUTO CALIBRATION)	
Using the Setup Display.....	90
Setting the Display or Sound Track Language	91
[LANGUAGE SETUP]	
Settings for the Display	91
[VIDEO SETUP]	
Settings for the HDMI	93
[HDMI SETUP]	
Settings for the Audio	94
[AUDIO SETUP]	
Other Settings.....	95
[SYSTEM SETUP]	
Settings for the Speakers.....	96
[SPEAKER SETUP]	
Returning to the Default Settings.....	99

Additional Information

Precautions.....	100
Notes about the Discs	101
Troubleshooting	102
Self-diagnosis Function	110
(When letters/numbers appear in the display)	
Specifications.....	111
Glossary	112
Language Code List.....	114
Index to Parts and Controls	115
Guide to the Control Menu Display ...	121
Index	124

Playable Discs

Type	Disc logo	Characteristics	Icon
DVD VIDEO	     	<ul style="list-style-type: none"> DVD VIDEO DVD-R/DVD-RW in DVD VIDEO format or video mode DVD+R/DVD+RW in DVD VIDEO format 	DVD-V
VR (Video Recording) mode	 	<ul style="list-style-type: none"> DVD-R/DVD-RW in VR (Video Recording) mode (except for DVD-R DL) 	DVD-VR
VIDEO CD		<ul style="list-style-type: none"> VIDEO CD (Ver. 1.1 and 2.0 discs) Super VCD CD-R/CD-RW/CD-ROM in video CD format or Super VCD format 	VIDEO CD
CD		<ul style="list-style-type: none"> Audio CD CD-R/CD-RW in audio CD format 	CD
DATA CD	–	<ul style="list-style-type: none"> CD-R/CD-RW/CD-ROM in DATA CD format, containing MP3 files¹⁾, JPEG image files²⁾, and DivX video files³⁾⁴⁾, and conforming to ISO 9660⁵⁾ Level 1/Level 2, or Joliet (extended format) 	DATA-CD
DATA DVD	–	<ul style="list-style-type: none"> DVD-ROM/DVD-R/DVD-RW/DVD+R/DVD+RW in DATA DVD format, containing MP3 files¹⁾, JPEG image files²⁾, and DivX video files³⁾⁴⁾, and conforming to UDF (Universal Disk Format) 	DATA DVD

- ¹)MP3 (MPEG 1 Audio Layer 3) is a standard format defined by ISO/MPEG which compresses audio data. MP3 files must be in MPEG 1 Audio Layer 3 format.
 - ²)JPEG image files must conform to the DCF image file format. (DCF “Design rule for Camera File system”: Image standards for digital cameras regulated by Japan Electronics and Information Technology Industries Association (JEITA)).
 - ³)DivX[®] is a video file compression technology, developed by DivX, Inc.
 - ⁴)DivX, DivX Certified and associated logos are trademarks of DivX, Inc. and are used under license.
 - ⁵)A logical format of files and folders on CD-ROMs, defined by ISO (International Organization for Standardization).
- “DVD-RW”, “DVD+RW”, “DVD+R”, “DVD VIDEO”, and the “CD” logos are trademarks.

Example of discs that the system cannot play

The system cannot play the following discs:

- CD-ROM/CD-R/CD-RW other than those recorded in the formats listed on page 6
- CD-ROM recorded in PHOTO CD format
- Data part of CD-Extra
- CD Graphics disc
- DVD Audio
- Data DVD that does not contain MP3 files, JPEG image files or DivX video files
- DVD-RAM
- Super Audio CD

Also, the system cannot play the following discs:

- A DVD VIDEO with a different region code (page 8).
- A disc that has a non-standard shape (e.g., card shaped, heart shaped).
- A disc that has a commercially available accessory attached, such as a label or ring.

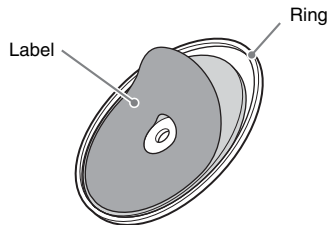

- An adapter to convert an 8 cm disc to standard size.

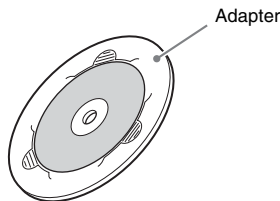

- A disc with paper or stickers on it.
- A disc that has the adhesive of cellophane tape or a sticker still left on it.

Notes about CD-R/CD-RW/DVD-R/DVD-RW/DVD+R/DVD+RW

In some cases, CD-R/CD-RW/DVD-R/DVD-RW/DVD+R/DVD+RW cannot be played on this system due to the recording quality or physical condition of the disc, or the characteristics of the recording device and authoring software.

The disc will not play if it has not been correctly finalized. For more information, refer to the operating instructions for the recording device.

Note that some playback functions may not work with some DVD+RWs/DVD+Rs, even if they have been correctly finalized. In this case, view the disc by normal playback. Also some DATA-CDs/ DATA-DVDs created in Packet Write format cannot be played.

Music discs encoded with copyright protection technologies

This product is designed to play back discs that conform to the Compact Disc (CD) standard.

Recently, various music discs encoded with copyright protection technologies are marketed by some record companies. Please be aware that among those discs, there are some that do not conform to the CD standard and may not be playable by this product.

Note on DualDiscs

A DualDisc is a two sided disc product which mates DVD recorded material on one side with digital audio material on the other side.

However, since the audio material side does not conform to the Compact Disc (CD) standard, playback on this product is not guaranteed.

About Multi Session CD

- This system can play a Multi Session CD when an MP3 file is contained in the first session. Any subsequent MP3 files recorded in later sessions can also be played back.
- This system can play a Multi Session CD when a JPEG image file is contained in the first session. Any subsequent JPEG image files recorded in later sessions can also be played back.
- If MP3 files and JPEG image files in music CD format or video CD format are recorded in the first session, only the first session will be played back.

Region code

Your system has a region code printed on the bottom of the control unit and will only play a DVD labeled with the same region code.

A DVD VIDEO labeled  will also play on this system.

If you try to play any other DVD VIDEO, the message [Playback prohibited by area limitations.] will appear on the TV screen. Depending on the DVD VIDEO, no region code indication may be given even though playing the DVD VIDEO is prohibited by area restrictions.

Note about playback operations of a DVD and VIDEO CD

Some playback operations of a DVD and VIDEO CD may be intentionally set by software producers. Since this system will play a DVD or VIDEO CD according to the disc contents the software producers designed, some playback features may not be available. Be sure to read the operating instructions supplied with the DVD or VIDEO CD.

Copyrights

This product incorporates copyright protection technology that is protected by U.S. patents and other intellectual property rights. Use of this copyright protection technology must be authorized by Macrovision, and is intended for home and other limited viewing uses only unless otherwise authorized by Macrovision. Reverse engineering or disassembly is prohibited.

This system incorporates with Dolby* Digital and Dolby Pro Logic (II) adaptive matrix surround decoder and the DTS** Digital Surround System.

* Manufactured under license from Dolby Laboratories. Dolby, Pro Logic, and the double-D symbol are trademarks of Dolby Laboratories.

** Manufactured under license under U.S. Patent #'s: 5,451,942; 5,956,674; 5,974,380; 5,978,762; 6,487,535 & other U.S. and worldwide patents issued & pending. DTS and DTS Digital Surround are registered trademarks and the DTS logos and Symbol are trademarks of DTS, Inc. © 1996-2007 DTS, Inc. All Rights Reserved.

This system incorporates High-Definition Multimedia Interface (HDMI™) technology. HDMI, the HDMI logo and High-Definition Multimedia Interface are trademarks or registered trademarks of HDMI Licensing LLC.

“BRAVIA” is a trademark of Sony Corporation.

“S-AIR” and its logo are trademarks of Sony Corporation.

Getting Started

Unpacking

- Control unit (1)

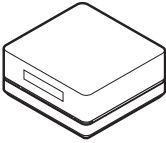

- Speakers

- Front left speaker (white connector) (for wired connection only)

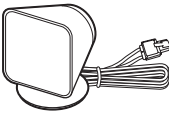

- Front right speaker (red connector) (for wired connection only)

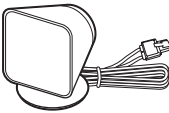

- Center speaker (green connector) (for wired connection only)

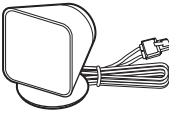

- Surround left speaker (blue connector) (for wireless connection only)

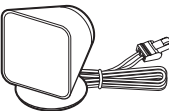

- Surround right speaker (gray connector) (for wireless connection only)

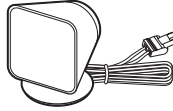

- Subwoofer (1)

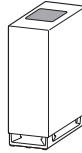

- AM loop antenna (aerial) (1)



- FM wire antenna (aerial) (1)



- Video Cord (1)



- Remote Commander (remote) (1)

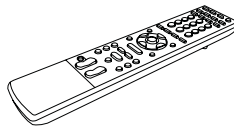

- R6 (size AA) batteries (2)



- Calibration microphone (1)



- Surround amplifier (TA-SA100WR) (1)

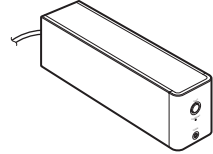

- Speaker cord cover (1)



- Speaker cord holder (1)



- Wireless adapters

- Wireless transceiver (EZW-RT10) (1)



- Wireless transmitter (EZW-T100) (1)



- Speaker cords (2) (for surround speakers wired connection only)



- Brackets (5)

- Wrench (1)

- Operating Instructions

- Quick Start Guide (card) (1)

Inserting batteries into the remote

You can control the system using the supplied remote. Insert two R6 (size AA) batteries by matching the \oplus and \ominus ends on the batteries to the markings inside the compartment. To use the remote, point it at the remote sensor on the control unit.

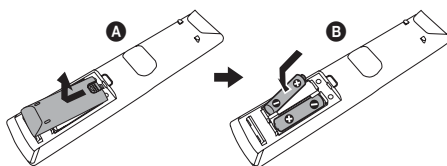

Note

- Do not leave the remote in an extremely hot or humid place.
- Do not use a new battery with an old one.
- Do not drop any foreign object into the remote casing, particularly when replacing the batteries.
- Do not expose the remote sensor to direct sunlight or lighting apparatus. Doing so may cause a malfunction.
- If you do not intend to use the remote for an extended period of time, remove the batteries to avoid possible damage from battery leakage and corrosion.

Step 1: Positioning the Speakers

For the best possible surround sound, all the speakers other than the subwoofer should be placed at the same distance from the listening position (①). It is recommended that the subwoofer should be placed (②).

Place speakers and subwoofer as illustrated below.

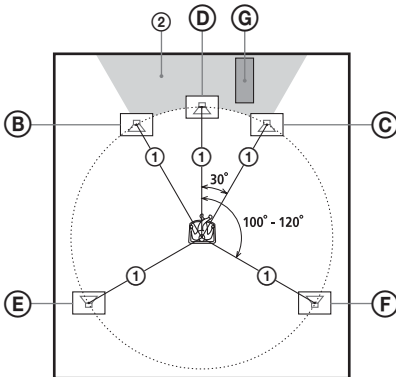
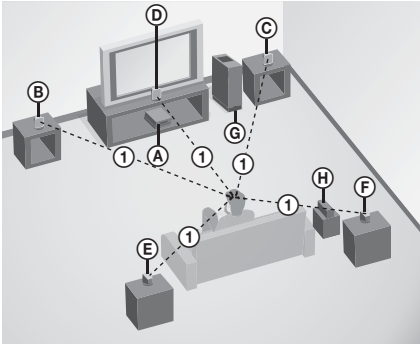

- ① Control unit
- ② Front speaker (L)
- ③ Front speaker (R)
- ④ Center speaker
- ⑤ Surround speaker (L)
- ⑥ Surround speaker (R)
- ⑦ Subwoofer
- ⑧ Surround amplifier

Tip

- You can also place the subwoofer either side, facing the listening position.
- When you install the speaker, the speaker face may be unstable. In this case, use a commercially available wire clammer or a commercially available tape, etc., to secure the speaker cord.

Using the subwoofer efficiently

To reinforce the bass sound, place the subwoofer possible close to a wall.

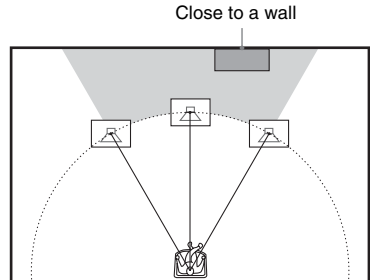

Note

- If the subwoofer is to be placed ahead of the front speaker, the distance should be less than 0.5 m.*

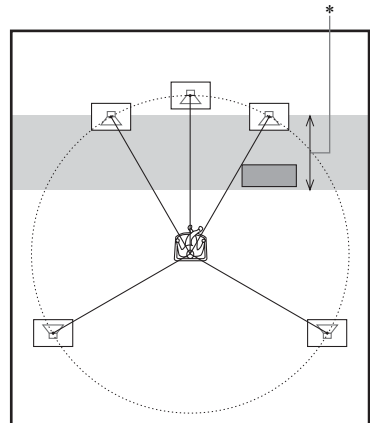

- You may not get the bass sound efficiently when the subwoofer is placed outside (③). You need to adjust the setting of the distance from the listening position.

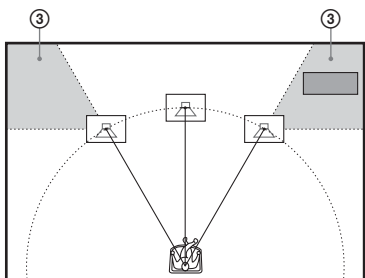

- Do not place objects on the top of the subwoofer where the speaker unit is installed.

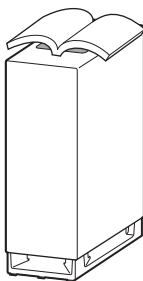

- Do not place the subwoofer under a desk or in a cabinet, etc.

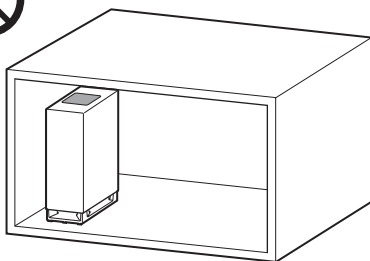
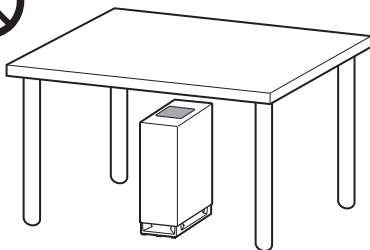

- Do not place the subwoofer back of the obstruction, such as TV, etc. Middle range sound will fall.

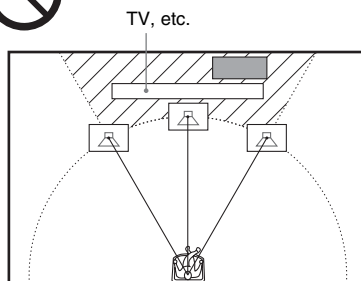

Note

- Do not set the speakers in an inclined position.
- Do not place the speakers in locations that are:
 - Extremely hot or cold
 - Dusty or dirty
 - Very humid
 - Subject to vibrations
 - Subject to direct sunlight
- Use caution when placing the speakers and/or speaker stands (not supplied) that are attached to the speakers on a specially treated (waxed, oiled, polished, etc.) floor, as staining or discoloration may result.
- When cleaning, use a soft cloth such as a cleaning cloth for glasses.
- Do not use any type of abrasive pad, scouring powder, or solvent such as alcohol or benzene.
- Image distortion on the TV screen may occur depending on the location of the subwoofer. In this case, place the subwoofer away from the TV.

Tip

- When you change the position of the speakers, Sony recommends that you change the settings. For details, see “Calibrating the Appropriate Settings Automatically” (page 88).

Note on handling the subwoofer

- Do not place your hand into the slit of the subwoofer when lifting it. The speaker driver may be damaged. When lifting, hold the bottom of the subwoofer.

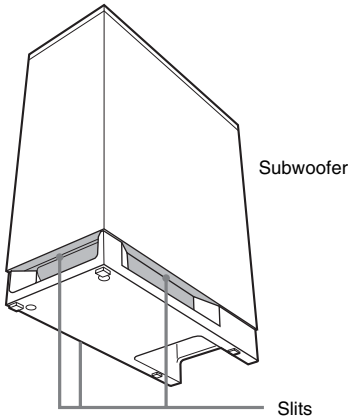

- Do not hold the EZW-T100 slot when lifting the subwoofer.
- Do not push the top of the subwoofer where the speaker unit is installed.

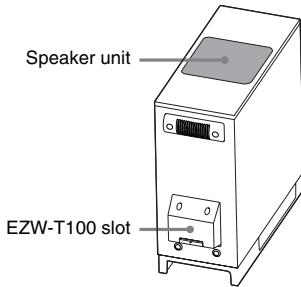

Installing the speakers on the wall

Before installing the speakers on the wall, you need to decide which surround speakers connection you want. You can connect your surround speakers in 2 different ways.

- Ⓐ Connect surround speakers to S-AIR surround amplifier (wireless connection)
- Ⓑ Connect surround speakers to subwoofer (wired connection)

Sony recommends you to use wireless connection for this system. For details, see “Step 2: Connecting the System” (page 19).

The surround speakers supplied are for wireless connection. If you want to change to wired connection, you need to change the surround speaker cords. For details on changing the speaker cords, see step 2 to 4 of “Installing the speakers to the wall” below.

Caution

- Contact a screw shop or installer regarding the wall material or screws to be used.
- Use screws that are suitable for the wall material and strength. As a plaster board wall is especially fragile, attach the screws securely to a beam and fasten them to the wall. Install the speakers on a vertical and flat wall where reinforcement is applied.
- Sony is not responsible for accident or damage caused by improper installation, insufficient wall strength or improper screw installation, natural calamity, etc.

- 1 Prepare screws (not supplied) that are suitable for the holes of the bracket.**
- 2 Secure the bracket to the wall using hole ①.**

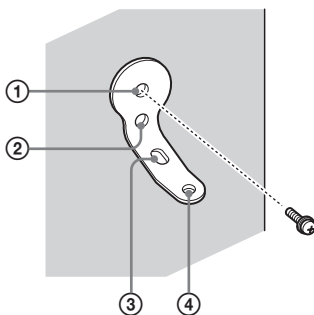

Tip

- To prevent the speaker from rotating, use the hole ②, too.

- 3** Remove the rear cap using the wrench (supplied), and remove the speaker pedestal using a screwdriver (+) (not supplied).

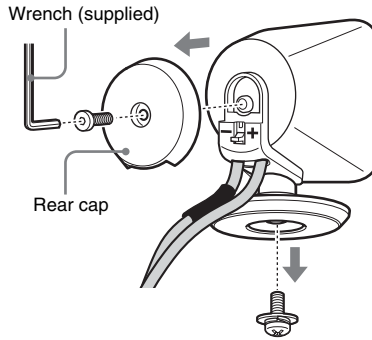

- 4** Push **A** with the supplied wrench (1), and then remove the speaker cords (2).

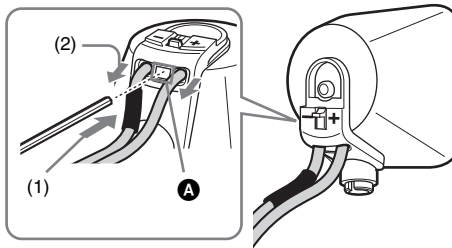

When the lever is down, the speaker cords are locked.

When the lever is up, the speaker cords can be removed.

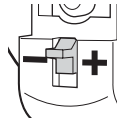
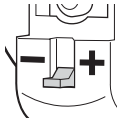

- 5** Thread the speaker cords through hole **3**.

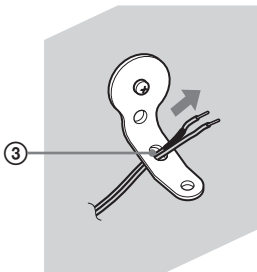

- 6** Reconnect the detached speaker cords, matching \oplus/\ominus to the appropriate speaker terminals (1), and then push the lever down completely (2).

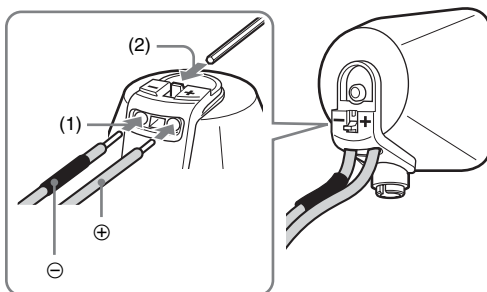

Tip

- If it is difficult to push the lever down, use the wrench (supplied).

- 7** Reattach the rear cap using the wrench (supplied).

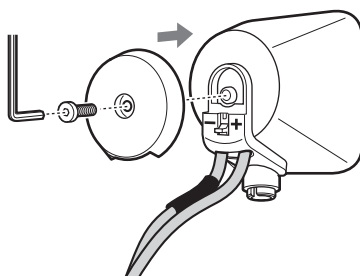

- 8** Secure the speaker to the bracket with the screw in Step 3 using hole (4).

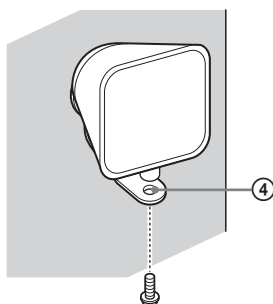

About connecting speaker cord

The connectors of the speaker cords are the same colour as the jacks to be connected.

There are 2 types of speaker cord for surround speaker. You can change the surround speaker cord depending on the type of speaker connection.

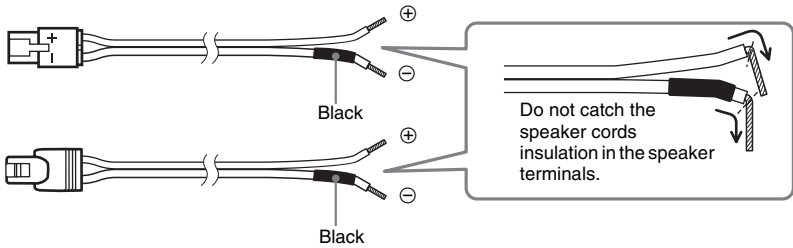

Tip

- You can remove the speaker cords (for wired connection) from the connector. With the catch facing down, press and hold the connector down against a flat surface (1) and remove the speaker cords from the connector (2).

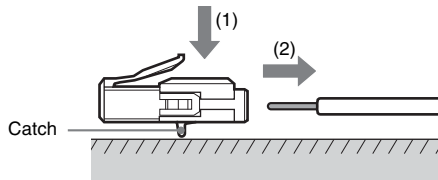

- You cannot remove the speaker cords (for wireless connection) from the connector.

To avoid short-circuiting the speakers

Short-circuiting of the speakers may damage the system. To prevent this, be sure to follow these precautions when connecting the speakers. Make sure the bare wire of each speaker cord does not touch another speaker terminal or the bare wire of another speaker cord, such as shown below.

Stripped speaker cord is touching another speaker terminal.



Stripped cords are touching each other due to excessive removal of insulation.

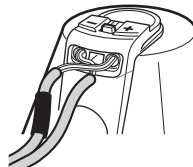

Note

Be sure to match the speaker cords to the appropriate speaker terminals: \oplus to +, and \ominus to -. If the cords are reversed, the sound will lack bass and may be distorted.

Step 2: Connecting the System

See the connection diagram below, and read the additional information from ① to ⑦ on the following pages.

Note

- Be sure to make connection securely to avoid hum and noise.
- When you connect another component with a volume control, turn up the volume of the other components to a level where sound is not distorted.

You can connect your surround speakers in 2 different ways.

- Ⓐ Connect surround speakers to S-AIR surround amplifier (wireless connection)
- Ⓑ Connect surround speakers to subwoofer (wired connection)

Sony recommends you to use wireless connection for this system.

Ⓐ Connect surround speakers to S-AIR surround amplifier (wireless connection)

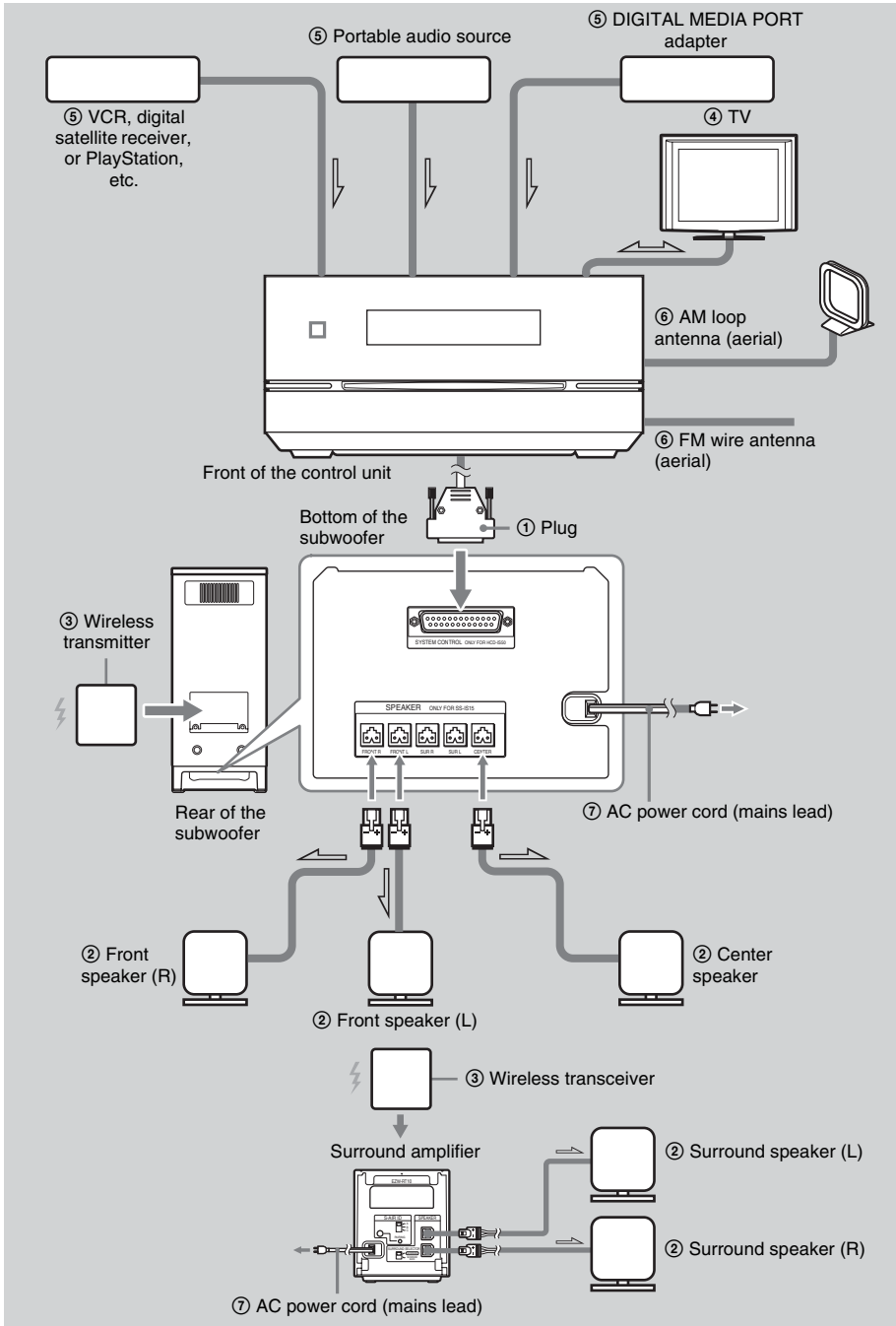

Ⓑ Connect surround speakers to subwoofer (wired connection)

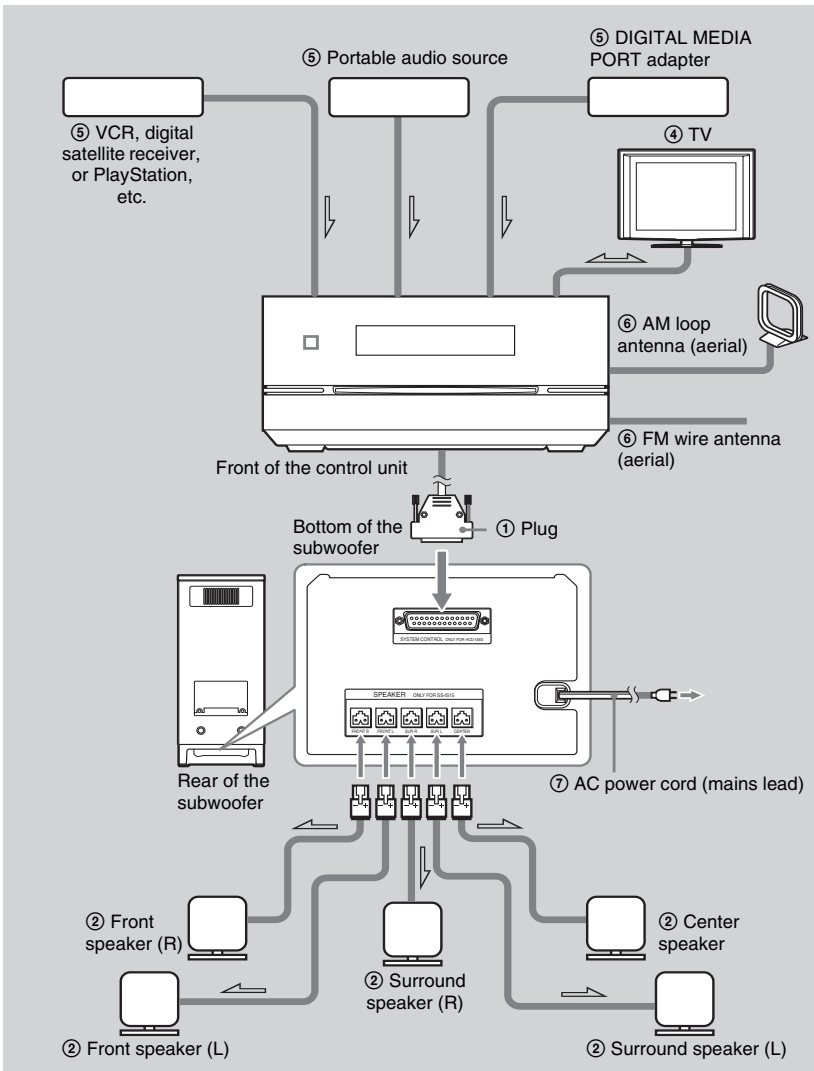

① Connecting the Control unit

Connect the system connector of the control unit to the SYSTEM CONTROL terminal on the bottom of the subwoofer.

Insert the plug of the SYSTEM CONTROL cord, then secure the screws of the plug.

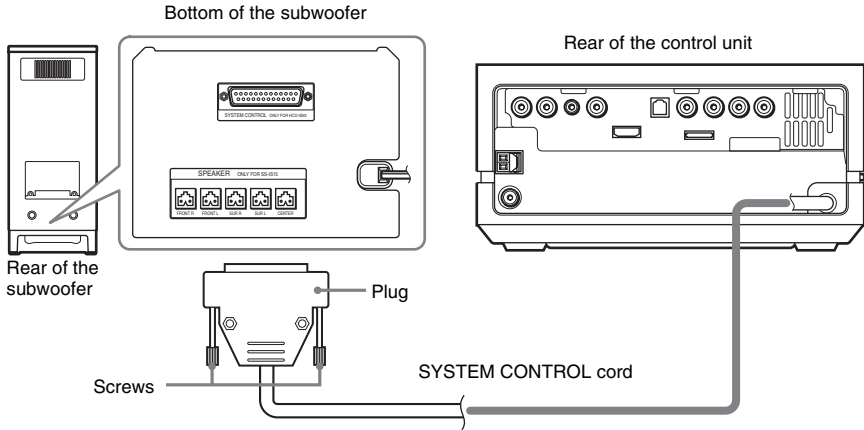

Note

- Before connecting the control unit, place the subwoofer on a stable work surface that is larger than the subwoofer.
- Be sure to place a soft cloth on the work surface to avoid damaging the surface of the subwoofer.

② Connecting the Speakers

Ⓐ Connect surround speakers to S-AIR surround amplifier (wireless connection)

Insert the speaker connector of the front and center speakers into the FRONT L, FRONT R, and CENTER jacks on the bottom of the subwoofer respectively, and insert the speaker connector of the surround speakers into the SPEAKER L and SPEAKER R jacks on the rear of the surround amplifier respectively.

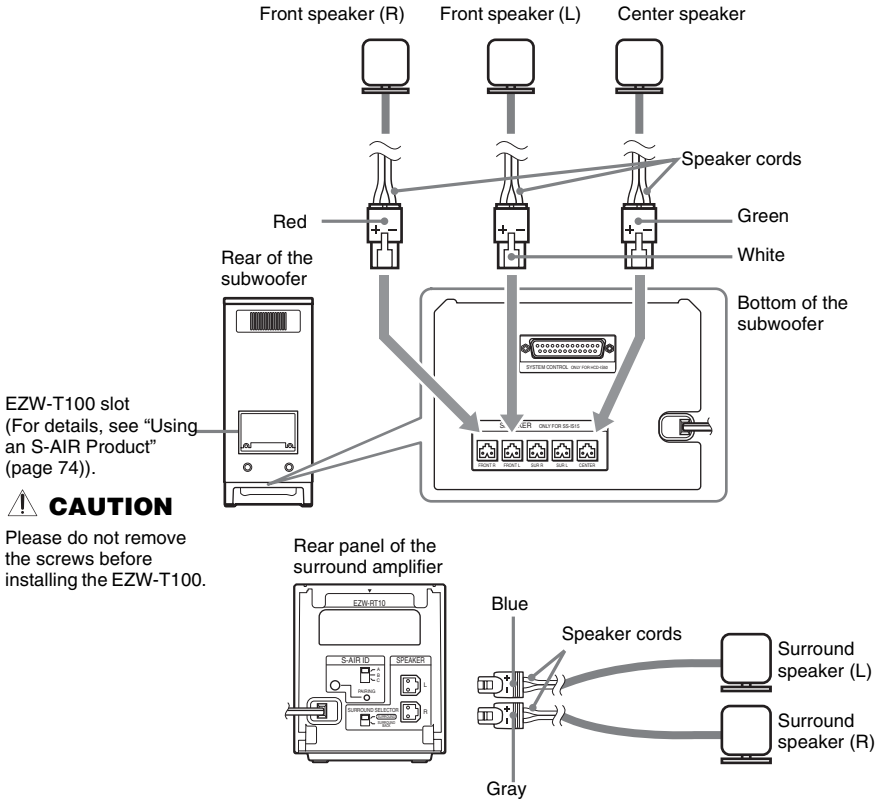

Ⓑ Connect surround speakers to subwoofer (wired connection)

Connect the connectors of the speaker cords to the corresponding SPEAKER jacks. The connectors of the speaker cords have the same colour as the jacks to be connected.

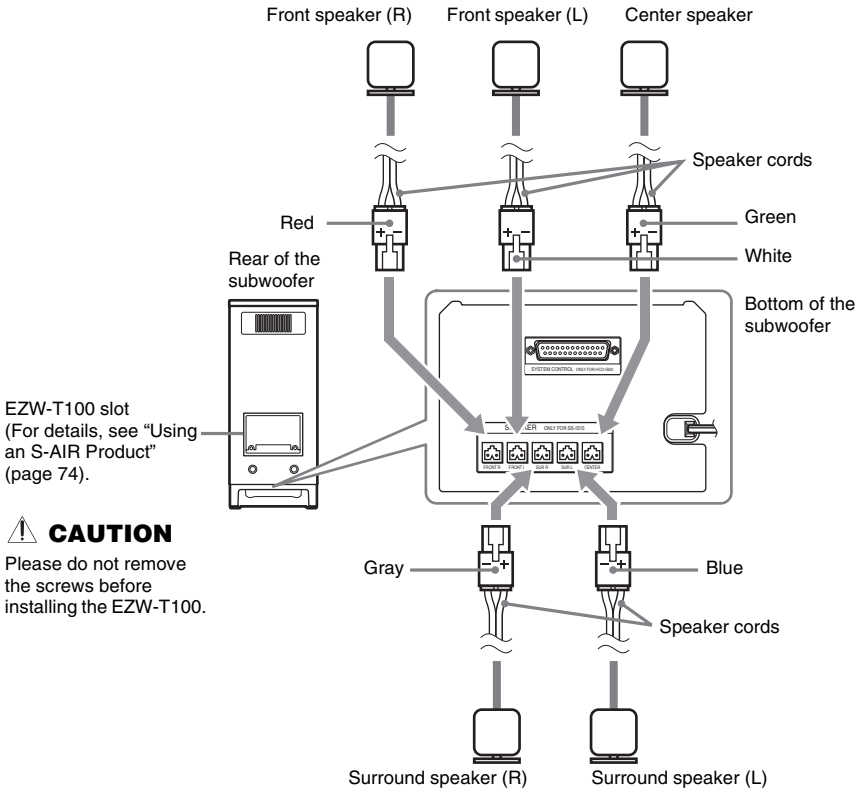

③ Inserting the wireless transmitter/transceiver

You can transmit sound from the S-AIR main unit to an S-AIR product, such as a surround amplifier or S-AIR receiver.

An S-AIR product is a component that is compatible with the S-AIR function.

To use the S-AIR function, you need to insert the wireless transmitter/transceiver into the subwoofer, surround amplifier and S-AIR receiver.

For details of the S-AIR function, see “Using an S-AIR Product” (page 74).

Note

- When you insert the wireless transmitter/transceiver, make sure that the AC power cord (mains lead) is not connected to a wall outlet (mains).
- Do not touch the terminals of the wireless transmitter/transceiver.
- Insert the wireless transmitter/transceiver with the S-AIR logo facing up.
- Insert the wireless transmitter/transceiver so that the ▼ marks are aligned.
- Do not insert other than the wireless transceiver into the EZW-RT10 slot.
- Do not insert other than the wireless transmitter into the EZW-T100 slot.

To insert the wireless transmitter into the S-AIR main unit (subwoofer)

1 Remove the screws and detach the slot cover.

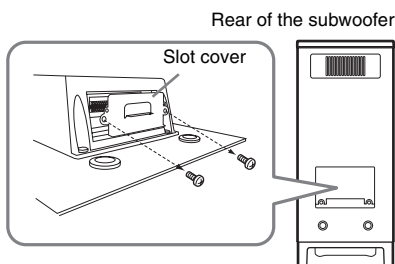

Note

- Remove the screws from the slot cover bearing the caution mark. Do not remove other screws.
- The slot cover is no longer necessary; however, keep it after detaching.

2 Insert the wireless transmitter.

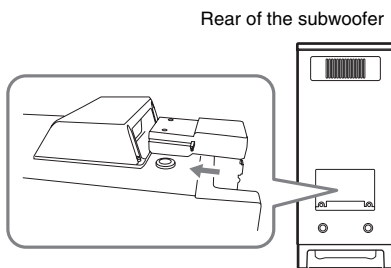

3 Make sure to use the same screws to secure the wireless transmitter.

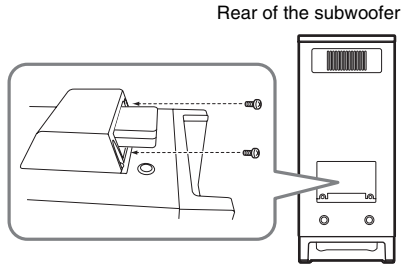

Note

- Do not use other screws to fasten the wireless transmitter.

To insert the wireless transceiver into the S-AIR sub unit (surround amplifier)

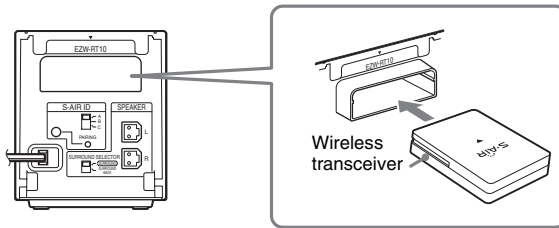

4 Connecting the TV

Use the parts as follows:

- Video cord (1)

To listen to TV sound from the speakers of the system, connect the TV and the system with the audio cord (not supplied) (A).

For video output to your TV, check the video input jacks of the TV, and select connection method (A), (B), or (C). Picture quality improves in order from (A) (standard) to (C) (HDMI).

When the TV has the digital optical or coaxial output jack, you can improve sound quality by connecting with the digital cord (B).

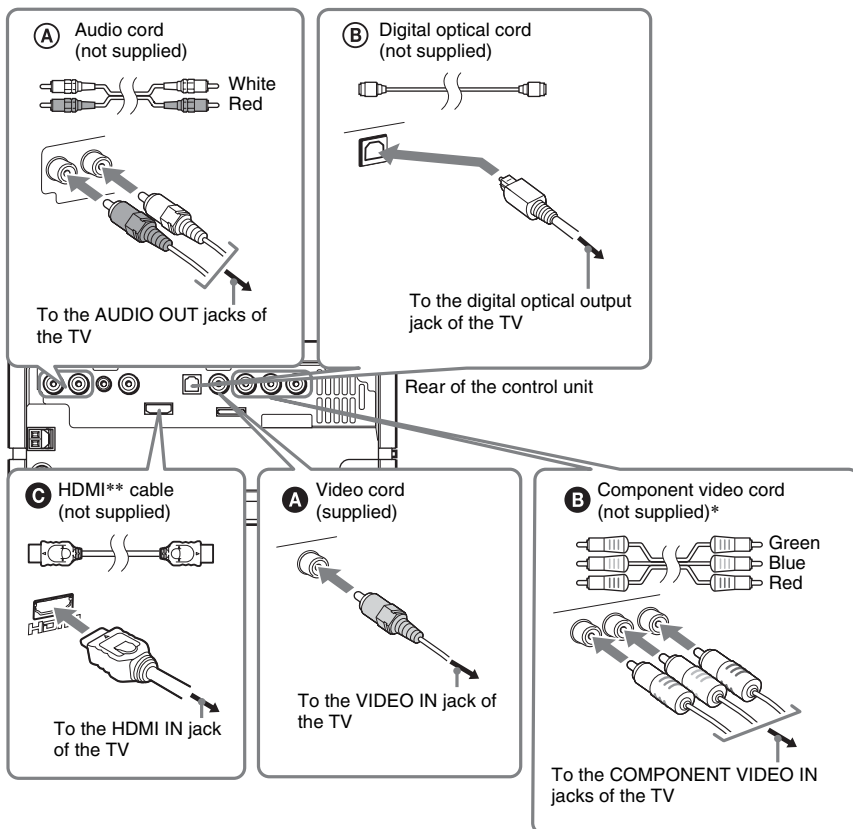

* If your TV accepts progressive format signals, use this connection and set the output signal of the system to progressive format (page 37).

** HDMI (High-Definition Multimedia Interface)

If your TV has the HDMI jack, use this connection and select the type of output signal (page 36).

Note

- During the “DMPORT” function, video signal is not output from the HDMI OUT and COMPONENT VIDEO OUT jacks.
- The system can accept both digital and analog signals. Digital signals have priority over analog signals. If the digital signal ceases, the analog signal will be processed after 2 seconds.
- When connecting the HDMI cable, make sure that the direction of jacks are the same.
- When connecting the digital optical cord, insert the connector until it clicks into place.

Tip

- You can connect another component, such as a VCR, digital satellite receiver, or PlayStation, to the TV (AUDIO IN) jacks (A) or TV (DIGITAL IN OPTICAL) jack (B) instead of the TV.

⑤ Connecting the other components

You can enjoy the connected component using the speakers of the system.

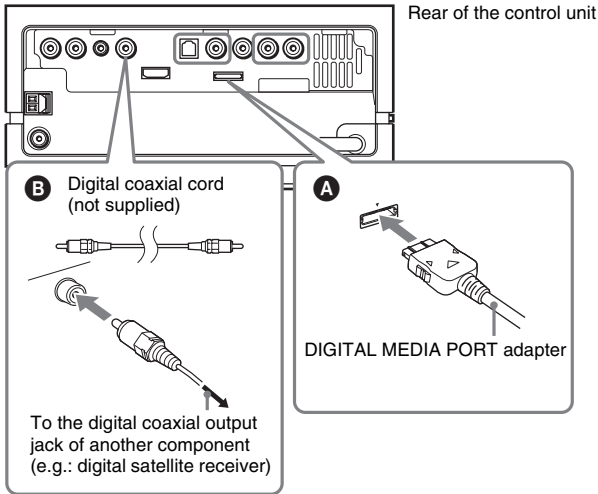

To connect the DIGITAL MEDIA PORT adapter

Connect the DIGITAL MEDIA PORT adapter to the DMPORT jack. For details, see “Using the DIGITAL MEDIA PORT Adapter” (page 73).

Note

- Connect the DIGITAL MEDIA PORT adapter so that the ▼ marks are aligned. When disconnecting, pull out while pressing **A**.
- Do not connect or disconnect the DIGITAL MEDIA PORT adapter to/from the control unit while the system is turned on.

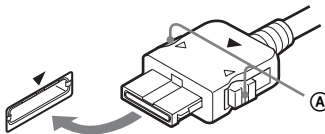

Tip

- You can assign a digital sound input corresponding with the function “TV” and “SAT/CABLE.” For details, see [DIGITAL IN] (page 95).

If your TV has multiple audio/video inputs

You can enjoy the sound with the speakers of the system through the connected TV. Connect the components as follows.

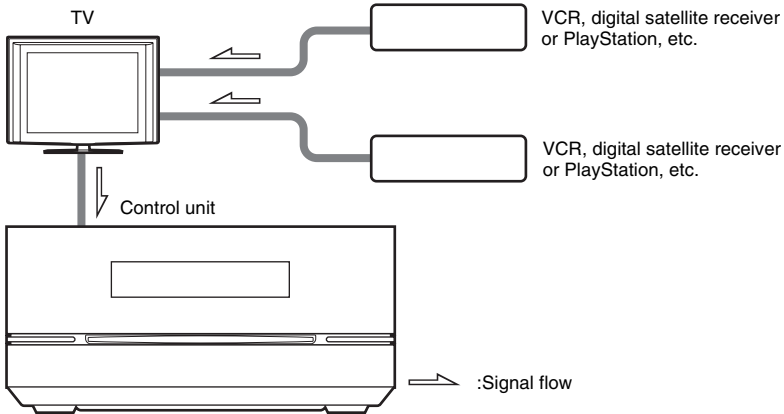

Select the component on the TV. For details, refer to the operating instructions of the TV.

If the TV does not have multiple audio/video inputs, a switcher will be necessary to receive the sound from more than two components.

⑥ Connecting the Antenna (Aerial)

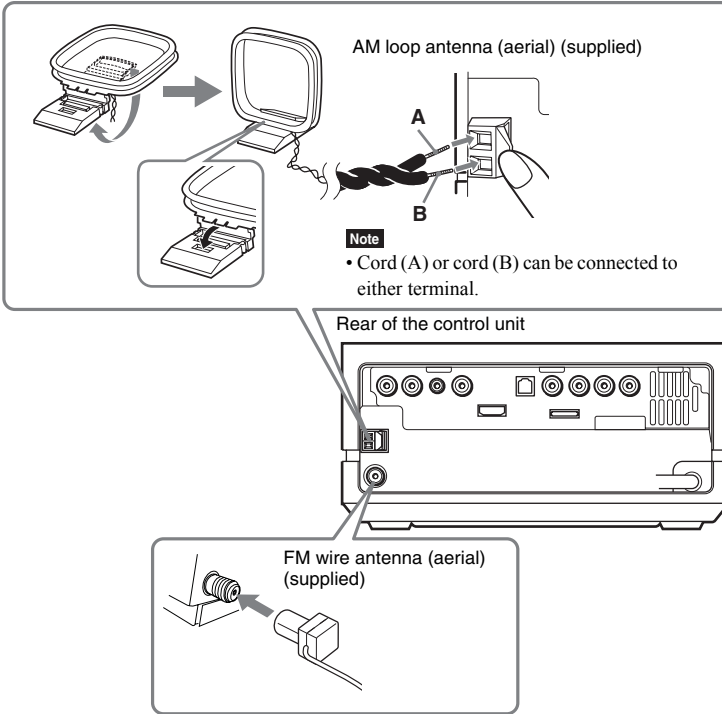

Note

- Keep the AM loop antenna (aerial) and cord away from the system or other AV components, as noise may result.
- Be sure to fully extend the FM wire antenna (aerial).
- After connecting the FM wire antenna (aerial), keep it as horizontal as possible.

Tip

- Adjust the direction of the AM loop antenna (aerial) for best AM broadcast sound.
- If you have poor FM reception, use a 75-ohm coaxial cable (not supplied) to connect the control unit to an outdoor FM antenna (aerial) as shown below.

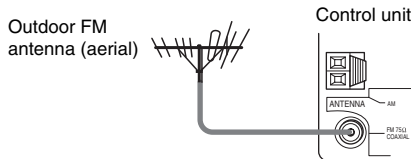

⑦ Connecting the AC power cord (mains lead)

Before connecting the AC power cords (mains lead) of the subwoofer and the surround amplifier to a wall outlet (mains), connect the front, center speakers to the subwoofer and surround speakers to the surround amplifier (page 23).

Rear of the subwoofer

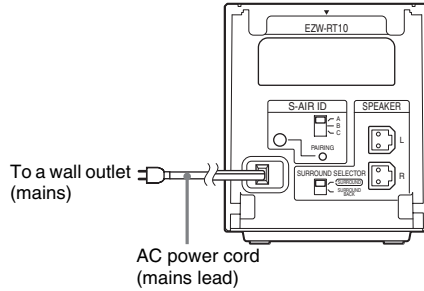
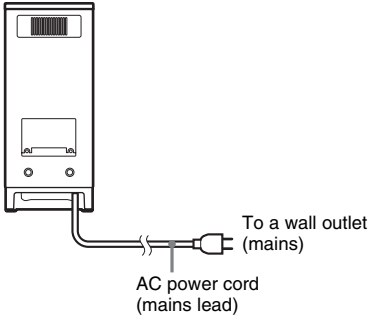

Note

- After connecting the AC power cord (mains lead), wait about 20 seconds before turning on the power by pressing .

Step 3: Setting up the Wireless System

To use the wireless system, you need to set up the surround amplifier. Before setting, make sure that the wireless transmitter and transceiver are inserted into the subwoofer and the surround amplifier correctly (page 25).

This wireless system is called “S-AIR”.

For details of the S-AIR function, see “Using an S-AIR Product” (page 74).

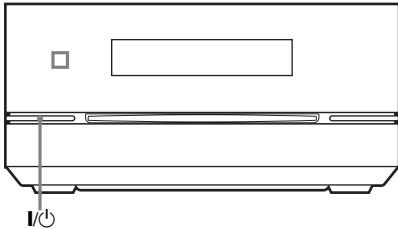

POWER / ON LINE Indicator

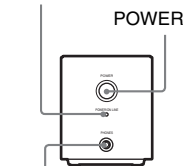

PHONES jack

POWER

S-AIR ID switch

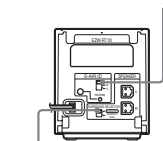

SURROUND SELECTOR switch

The subwoofer transmits sound to the surround amplifier that is connected to the surround speakers. To establish sound transmission, perform the following steps.

- 1** Press **I/⏻** on the control unit.
The system turns on.
- 2** Make sure that the **SURROUND SELECTOR** switch of the surround amplifier is set to **SURROUND**.
- 3** Set the **S-AIR ID** switch of the surround amplifier to **A**.
- 4** Press **POWER** on the surround amplifier.

The POWER / ON LINE indicator turns green. If not, check the transmission status as follows.

To check the transmission status

You can check the status of sound transmission between the subwoofer and surround amplifier by checking the POWER / ON LINE indicator of the surround amplifier.

POWER / ON LINE indicator	Status
Turns green.	Sound transmission is established.
Flashes green.	Sound transmission is not established. For details, see “Surround amplifier operation” (page 109).
Turns red.	The surround amplifier does not output sound. For details, see “Surround amplifier operation” (page 109).
Turns off.	The surround amplifier turns off or its protection is active. For details, see “Surround amplifier operation” (page 109).

To enjoy the sound by using headphones

You can enjoy the system’s sound in a place apart from the control unit by connecting the headphones to the PHONES jack on the surround amplifier.

Note

- When you connect headphones to the surround amplifier, neither the control unit nor the surround amplifier outputs sound from the system’s speakers.
- The volume of the system may become minimize if you turn off the surround amplifier while the headphones are connected to the surround amplifier, or radio reception is poor. In this case, “HP NO LINK” and “VOLUME MIN” appear alternately in the front panel display. Check radio reception, and set the volume again.

When you use the multiple S-AIR product

You can prevent miss transmission between the S-AIR products by setting a different ID for each S-AIR product. For details, see “Establishing sound transmission between the S-AIR main unit and S-AIR sub unit (ID setting)” (page 75).

To prevent the transmission by neighbours

To prevent the transmission from neighbours, you can identify the S-AIR main unit and the surround amplifier by performing the pairing operation. For details, see “Identifying the S-AIR main unit with a specific S-AIR sub unit (Pairing operation)” (page 77).

To attach the cover to the surround amplifier

After connecting and setting, you can attach the cover to the surround amplifier for organizing and storing excess speaker cords.

- 1 Attach the speaker cord cover by sliding it down along the grooves along the edges of the surround amplifier.**

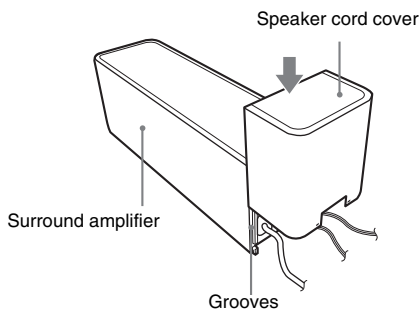

Push the speaker cord cover down until you hear a click. Turn the surround amplifier upside down, then store the cords in the speaker cord cover.

- 2 Insert the tabs of the speaker cord holder in the slots of the speaker cord cover, and press it into place.**

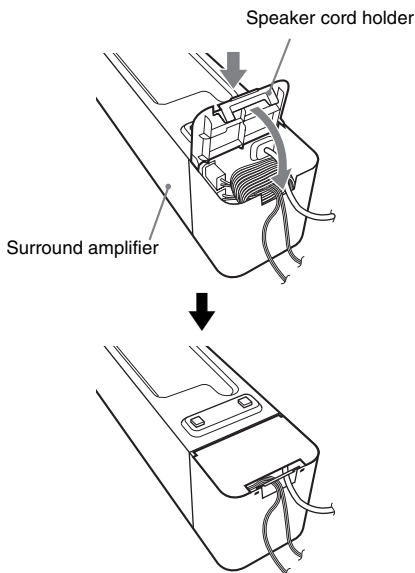

Note

- When detaching, remove the speaker cord holder, then remove the speaker cord cover. To remove the speaker cord holder, slightly press the catch of the holder and lift off. To remove the speaker cord cover, slightly splay open the edges of the cover and slide down.
- Do not use excessive force to store the cords.

Step 4: Performing the Quick Setup

Follow the steps below to make the basic adjustments for using the system.

Note

- When you connect the system and the TV with the component video cord (not supplied) or HDMI cable (not supplied), you need to set the type of video output for matching your TV. For details, see "Setting the type of video output to match your TV" (page 36).

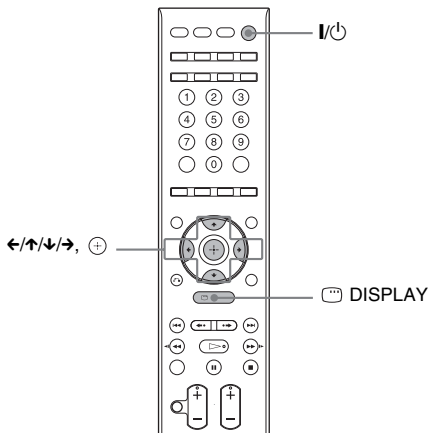

- Turn on the TV.
- Press **I/⏻** on the control unit and **POWER** on the surround amplifier.
The system turns on.

Note

- Make sure that the function is set to "DVD" (page 41).

- Switch the input selector on your TV so that the signal from the system appears on the TV screen.

[Press [ENTER] to run QUICK SETUP.] appears at the bottom of the TV screen. If this message does not appear, recall the Quick Setup display (page 36) and perform again.

- Press **+** without inserting a disc.

The Setup Display for selecting the language used in the on-screen display appears on the TV screen.

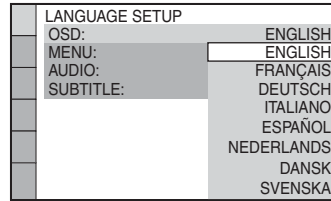

- Press **↑/↓** to select a language.

The system displays the menu and subtitles in the selected language.

- Press **+**.

The Setup Display for selecting the aspect ratio of the TV to be connected appears.

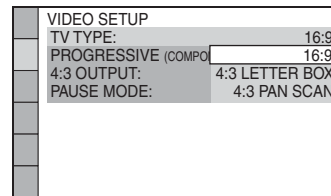

- Press **↑/↓** to select the setting that matches your TV type.

■ If you have a wide-screen TV or a 4:3 standard TV with a wide-screen mode [16:9] (page 91)

■ If you have a 4:3 standard TV [4:3 LETTER BOX] or [4:3 PAN SCAN] (page 91)

- Press **+**.

- Connect the calibration microphone to the ECM-AC2 jack on the rear of the control unit.

Set up the calibration microphone at the ear level using a tripod, etc. (not supplied). The front of each speaker should face the calibration microphone, and there should be no obstruction between the speakers and the calibration microphone.

Note

- The ECM-AC2 jack is used for the supplied calibration microphone only. Do not connect other microphones.

Rear of the control unit

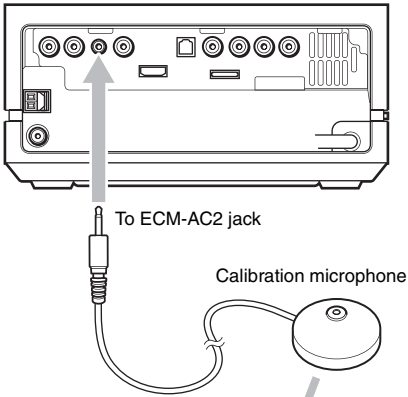
**10** Press **←/→** to select **[YES]**.**Note**

- Make sure that the headphones are not connected to the surround amplifier (page 74). You cannot operate following steps with the headphones connected.
- Before [AUTO CALIBRATION], be sure that the surround amplifier turns on and you install the surround amplifier in the appropriate location. If you install the surround amplifier in an improper location, such as another room, proper measurement will not be obtained.

11 Press **+**.

[AUTO CALIBRATION] starts. Be quiet during the measurement.

Note

- Loud test sound is output when [AUTO CALIBRATION] starts. You cannot turn the volume down. Give consideration to children and neighbours.
- Avoid being in the measurement area and making noise during the measurement (which takes about 1 minute), as it may interfere with measurement.

12 Unplug the calibration microphone and press **←/→** to select **[YES]**.**Note**

- The environment of the room in which the system is installed may affect measurements.
- If measurement fails, follow the message then retry [AUTO CALIBRATION].

13 Press **+**.

Quick Setup is finished. All connections and setup operations are complete.

To quit the Quick Setup

Press **☰** DISPLAY in any Step.

Tip

- If you cancel [AUTO CALIBRATION], perform the speaker settings in “Settings for the Speakers” (page 96).
- If you change the position of the speakers, reset the speaker settings. See “Calibrating the Appropriate Settings Automatically” (page 88).
- If you want to change any of the settings, see “Using the Setup Display” (page 90).
- For details on [AUTO CALIBRATION] and the error messages of [AUTO CALIBRATION], see “Calibrating the Appropriate Settings Automatically” (page 88).

continued

35^{GB}

To recall the Quick Setup display

- 1 Press **FUNCTION** repeatedly until "DVD" appears in the front panel display.
- 2 Press **DISPLAY** when the system is in stop mode.
The Control Menu display appears on the TV screen.
- 3 Press **↑/↓** to select **[SETUP]**, then press **+**.
The options for **[SETUP]** appear.

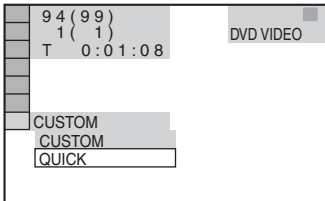

- 4 Press **↑/↓** to select **[QUICK]**, then press **+**.
The Quick Setup display appears.

Setting the type of video output to match your TV

Depending on the connection of the TV (page 26), select the type of video output of the system.

To select the type of video signal output from the HDMI OUT jack

When you connect the control unit and the TV with the HDMI cable, select the type of video signals output from HDMI OUT jack. For details, refer also to the operating instructions supplied with the TV/projector, etc.

- 1 Press **FUNCTION** repeatedly until "DVD" appears in the front panel display.
- 2 Press **DISPLAY** while the system is in stop mode.
The Control Menu display appears on the TV screen.
- 3 Press **↑/↓** to select **[SETUP]**, then press **+**.
The options for **[SETUP]** appear.
- 4 Press **↑/↓** to select **[CUSTOM]**, then press **+**.
The Setup Display appears.
- 5 Press **↑/↓** to select **[HDMI SETUP]**, then press **+**.
The options for **[HDMI SETUP]** appear.
- 6 Press **↑/↓** to select **[HDMI RESOLUTION]**, then press **+**.
- 7 Press **↑/↓** to select the desired setting, then press **+**.
 - **[AUTO(1920×1080p)]**: The system outputs the optimal video signal for the connected TV.
 - **[1920×1080i]**: The system outputs 1920 × 1080i* video signals.
 - **[1280×720p]**: The system outputs 1280 × 720p* video signals.
 - **[720×480/576p]****: The system outputs 720 × 480p* or 720 × 576p* video signals.

* i: interlace, p: progressive
** Depending on the country model, [720×480p] may appear.

Does your TV accept progressive signals?

Progressive is the method for displaying TV images which reduces flickering and sharpens the image. To use this method, you need to connect to a TV that accepts progressive signals.

- 1** Press **FUNCTION** repeatedly until **"DVD"** appears in the front panel display.
- 2** Press **DISPLAY** while the system is in stop mode.
The Control Menu display appears on the TV screen.
- 3** Press **↑/↓** to select **[SETUP]**, then press **+**.
The options for [SETUP] appear.
- 4** Press **↑/↓** to select **[CUSTOM]**, then press **+**.
The Setup Display appears.
- 5** Press **↑/↓** to select **[VIDEO SETUP]**, then press **+**.
The options for [VIDEO SETUP] appear.
- 6** Press **↑/↓** to select **[PROGRESSIVE (COMPONENT OUT)]**, then press **+**.

- 7** Press **↑/↓** to select the desired setting, then press **+**.

[OFF]: The system does not output progressive signals. Select this setting when:

- your TV does not accept progressive signals, or,
- your TV is connected to jacks other than the COMPONENT VIDEO OUT jacks.

[ON]: The system outputs progressive signals. Select this setting when:

- your TV accepts progressive signals, and,
- the TV is connected to the COMPONENT VIDEO OUT jacks.

When you select [ON], the confirmation display appears. Follow the Steps below.

- 8** Press **←/→** to select **[START]**, then press **+**.

The system outputs the progressive signal for 5 seconds. Check that the screen is displayed correctly.

- 9** Press **←/→** to select **[YES]**, then press **+**.

The system outputs the progressive signal. When you select [NO], the system does not output the progressive signal.

Basic Operations

Playing a Disc

DVD-V DVD-VR VIDEO CD C D DATA-CD DATA DVD

Depending on the DVD VIDEO or VIDEO CD, some operations may be different or restricted. Refer to the operation details supplied with your disc.

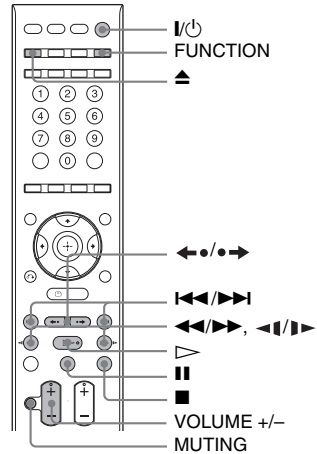
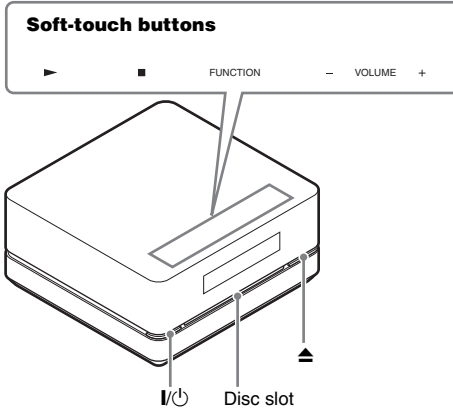

Note

- Soft-touch buttons function by touching lightly. Do not press them strongly.
- Do not place objects on the top of the control unit. Doing so may activate the soft-touch buttons or deactivate the buttons of the control unit.

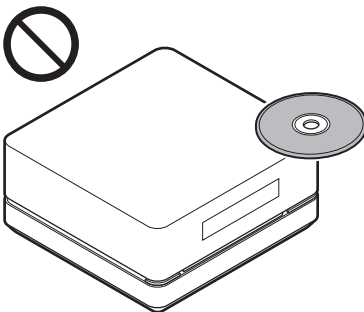

Tip

- Soft-touch buttons function when they are lit up.
- You can select the way of displaying the soft-touch buttons located on the top of the control unit (page 85).

- 1 Turn on your TV.**
- 2 Switch the input selector on the TV to this system.**
- 3 Press I/⏻.**

The system turns on.

Unless the mode of the system is set to “DVD,” press FUNCTION on the remote or FUNCTION (soft-touch button) on the control unit to select “DVD.”

“No Disc” appears in the front panel display and the system is ready for loading the disc.

- 4 Load a disc.**

Push the disc into the disc slot until the disc is pulled in automatically.

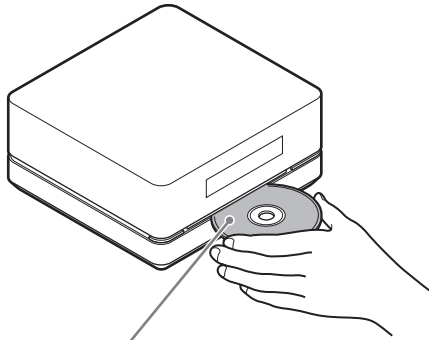

Labeled side facing to upper surface

The disc is drawn into the control unit automatically and the following indication appears in the front panel display.

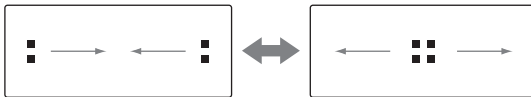

- 5 Press ▷ on the remote, or touch ► (soft-touch button) on the control unit.**

The system starts playback (continuous play).

- 6 Adjust the VOLUME +/- on the remote or touch the VOLUME +/- (soft-touch button) on the control unit.**

The volume level appears on the TV screen and in the front panel display. Depending on the system status, the volume level may not appear on the TV screen.

Note

- When you set the Control for HDMI function to on, the TV that is connected to the control unit with an HDMI cable can be sync-operated with the system. For details, see page 70.

Tip

- When you connect the system and TV with an HDMI cable, you can operate them simply using the Control for HDMI function. For details, see page 70.

To save the power in standby mode

Press **I/C** while the system turns on, then the system enters standby mode. To cancel standby mode, press **I/C** once.

To enter power standby mode, make sure that the system is in the following status.

- [CONTROL FOR HDMI] is set to [OFF] (page 71).
- “S-AIR STBY” is set to “OFF” (page 76).

Note

- When the system is turned off, do not push a disc into the control unit.

Additional operations

To	Press
Stop	■
Pause	
Resume play after pause	/ ▷ on the remote or ► (soft-touch button) on the control unit.
Go to the next chapter, track, or scene ¹⁾	▶▶
Go back to the preceding chapter, track, or scene ¹⁾	◀◀ twice in a second. When you press ◀◀ once, you can go to the beginning of the current chapter, track or scene.
Turn off the sound temporarily	MUTING. To cancel muting, press it again or VOLUME + to adjust the sound volume.
Stop play and remove the desired disc	▲
Locate a point quickly by playing a disc in fast forward or fast reverse (Scan) ¹⁾²⁾	▶▶/ ▶ or ◀◀/◀◀ while playing a disc. Each time you press ▶▶/ ▶ or ◀◀/◀◀ during scanning, the playback speed changes. To return to normal speed, press ▷. Actual speeds may differ with some discs.
Watch frame by frame (Slow-motion Play) ³⁾	▶▶/ ▶ or ◀◀/◀◀ ⁴⁾ while the system is in pause mode. Each time you press ▶▶/ ▶ or ◀◀/◀◀ ⁴⁾ during Slow-motion Play, the playback speed changes. Two speeds are available. To return to normal playback speed, press ▷.
Play one frame at a time (Freeze Frame) ³⁾⁵⁾	●▶ to go to the next frame while the system is in pause mode. Press ◀● to go to the preceding frame while the system is in pause mode (DVD VIDEO/DVD-VR/DVD-R/DVD-RW/DVD+R/DVD+RW only). To return to normal playback, press ▷.
Replay the previous scene (10 seconds before) ⁶⁾	◀● (instant replay) during playback.
Briefly fast forward the current scene (30 seconds after) ⁷⁾	●▶ (instant advance) during playback.

¹⁾Except for JPEG image files.

²⁾Scan speeds may differ with some discs.

³⁾DVD VIDEO, DVD-R, DVD-RW, VIDEO CD only.

⁴⁾Except for VIDEO CDs.

⁵⁾For a DATA CD/DATA DVD, this function works only for DivX video files.

⁶⁾DVD VIDEO/DVD-RW/DVD-R only. The button can be used except for DivX video files.

⁷⁾DVD VIDEO/DVD-RW/DVD-R/DVD+RW/DVD+R only. The button can be used except for DivX video files.

Note

- You may not be able to use the instant replay or instant advance function with some scenes.

Enjoying the Radio or Other Components

Selecting the connected component

You can use a TV, VCR, or other components connected to the TV or SAT/CABLE jacks on the rear of the control unit. Refer to the operating instructions supplied with the components for further information.

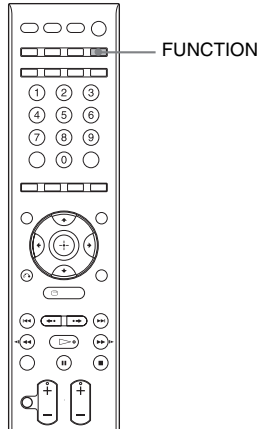

Press FUNCTION repeatedly until the desired function name appears in the front panel display.

Each time you press FUNCTION, the mode of the system changes in the following sequence.

DVD → FM → AM → TV → SAT/CABLE → DMPORT → DVD → ...

Tip

- You can assign a digital sound input corresponding with the function “TV” and “SAT/CABLE”. For details, see [DIGITAL IN] (page 95).

Note

- When you use both the TV (AUDIO IN) jacks (analog connection) and TV (DIGITAL IN OPTICAL) jack (digital connection) at the same time, the digital connection takes priority.

Changing the input level of the sound from connected components

Distortion may occur when you listen to a component connected to the TV (AUDIO IN) jacks on the rear of the control unit. This is not a malfunction and will depend on the component connected. To prevent distortion, reduce the input level on the control unit.

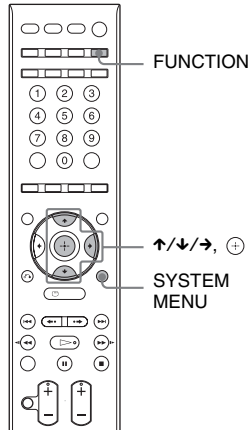

- 1** Press **FUNCTION** repeatedly until “TV” appears in the front panel display.
- 2** Press **SYSTEM MENU**.
- 3** Press **↑/↓** repeatedly until “ATTENUATE” appears in the front panel display, then press **+** or **→**.
- 4** Press **↑/↓** to select a setting.
 - “ATT ON”: You can attenuates the input level. The output level is changed.
 - “ATT OFF”: Normal input level.
- 5** Press **+**.
The setting is made.
- 6** Press **SYSTEM MENU**.
The system menu turns off.

Note

- “ATTENUATE” appears only when the function is set to the “TV” function.

Enjoying Sound from all Speakers

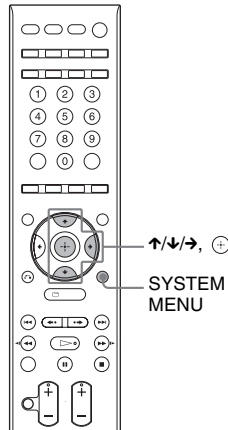

- 1 Press SYSTEM MENU.**
- 2 Press ↑/↓ repeatedly until “DEC. MODE” appears in the front panel display, then press ⊕ or →.**
- 3 Press ↑/↓ repeatedly until the decoding mode you want appears in the front panel display.**

When you want to output the TV sound or stereo sound of a 2 channel source from all speakers, select “PLII MOVIE” or “PLII MUSIC” decoding mode.

For details, see page 63.

- 4 Press ⊕.**
The setting is made.
- 5 Press SYSTEM MENU.**
The system menu turns off.

Note

- Depending on your TV, you may need to turn off your TV's speaker to enjoy surround sound of the system.

Various Functions for Playing Discs

Searching for a Title/ Chapter/Track/Scene, etc.

DVD-V

DVD-VR

VIDEO CD

CD

DATA-CD

DATA DVD

You can search a DVD VIDEO/DVD-VR by title or chapter, and you can search a VIDEO CD/CD/DATA CD/DATA DVD by track, index, or scene. For a DATA CD/DATA DVD, you can search by folder or file. As titles and tracks are assigned unique numbers on the disc, you can select the desired title or track by entering its number. Or, you can search for a scene using the time code.

1 Press **DISPLAY**. (When playing a DATA CD/DATA DVD with JPEG image files, press **DISPLAY** twice.)

The Control Menu display appears on the TV screen.

2 Press **↑/↓** to select the search method.

Example: when you select  [CHAPTER]

[** (**)] is selected (** refers to a number).

The number in parentheses indicates the total number of titles, chapters, tracks, indexes, scenes, folders or files.

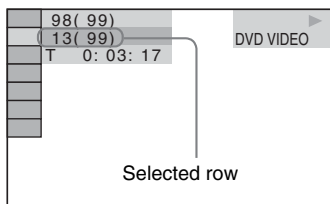

3 Press **+**.

[** (**)] changes to [-- (**)].

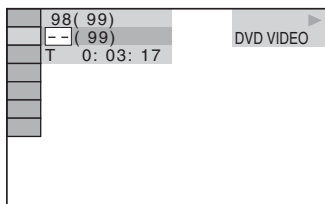

4 Press **↑/↓** or the numeric buttons to select the desired title, chapter, track, index, scene, etc.

If you make a mistake

Cancel the number by pressing CLEAR, then select another number.

5 Press **+**.

The system starts playback from the selected number.

Tip

- When the Control Menu display is turned off, you can search for a chapter (DVD VIDEO/DVD-R/DVD-RW), track (VIDEO CD/CD), or file (DATA CD/DATA DVD (DivX video file)) by pressing the numeric buttons and **+**.

To search for a scene using the time code (DVD VIDEO and DVD-VR mode only)

1 In Step 2, select [TIME].

[T **:**:**] (playing time of the current title) is selected.

2 Press **+**.

[T **:**:**] changes to [T --:--:--].

3 Input the time code using the numeric buttons.

For example, to find the scene at 2 hours, 10 minutes, and 20 seconds after the beginning, just press “2, 1, 0, 2, 0” (2:10:20).

4 Press **+**.

Note

- You cannot search for a scene on a DVD+R/DVD+RW using the time code.

Resuming Playback from the Point Where You Stopped the Disc

(Resume Play)

DVD-V DVD-VR VIDEO CD C D DATA-CD

DATA DVD

When you stop the disc, the system remembers the point where you pressed ■ and “Resume” appears in the front panel display. As long as you do not remove the disc, Resume Play will work even if the system is set to standby mode by pressing I/⏻.

1 While playing a disc, press ■ to stop playback.

“Resume” appears in the front panel display.

2 Press ▷.

The system starts playback from the point where you stopped the disc in Step 1.

Note

- Depending on where you stop the disc, the system may not resume playback from exactly the same point.
- The point where you stopped playing may be cleared when:
 - you eject the disc.
 - the system enters standby mode (DATA CD/ DATA DVD only).
 - you change or reset the settings on the Setup Display.
 - you change the function by pressing FUNCTION.
 - you disconnect the AC power cord (mains lead).
 - you change the parental control level.
- For a DVD-VR, VIDEO CD, CD, DATA CD, and DATA DVD, the system remembers the resume playback point for the current disc.
- Resume Play does not work during Program Play and Shuffle Play.
- This function may not work properly with some discs.

Tip

- To play from the beginning of the disc, press ■ twice, then press ▷.

To enjoy a disc that is played before by resume playback (Multi-disc Resume) (DVD VIDEO, VIDEO CD only)

This system recalls the point where you stopped the disc the last time it was played and resumes playback from that point the next time you insert the same disc. When the resume playback memory is full, the resume playback point for the earliest disc is deleted.

To activate this function, set [MULTI-DISC RESUME] in [SYSTEM SETUP] to [ON]. For details, see “[MULTI-DISC RESUME] (DVD VIDEO/VIDEO CD only)” (page 96).

Note

- If [MULTI-DISC RESUME] in [SYSTEM SETUP] is set to [OFF] (page 96), the resume point is cleared when you change the function by pressing FUNCTION.
- This system can store at least 10 resume playback points.

Tip

- To play from the beginning of the disc, press ■ twice, then press ▷.

Creating Your Own Program

(Program Play)

VIDEO CD CD

You can play the contents of a disc in the order you want by arranging the order of the tracks on the disc to create your own program. You can program up to 99 tracks.

1 Press DISPLAY.

The Control Menu display appears on the TV screen.

2 Press \uparrow/\downarrow to select [PROGRAM], then press \oplus .

The options for [PROGRAM] appear.

3 Press \uparrow/\downarrow to select [SET \rightarrow], then press \oplus .

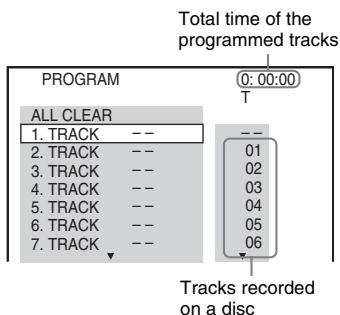

4 Press \rightarrow .

The cursor moves to the track row [T] (in this case, [01]).

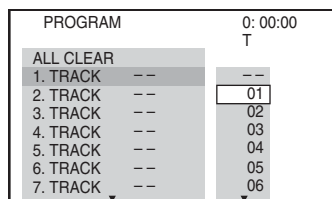

5 Select the track you want to program.

For example, select track [02].

Press \uparrow/\downarrow to select [02] under [T], then press \oplus .

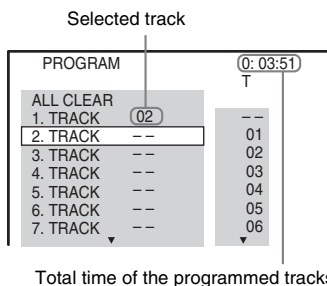

6 To program other tracks, repeat steps 4 to 5.

The programmed tracks are displayed in the selected order.

7 Press \triangleright to start Program Play.

Program Play starts.

When the program ends, you can restart the same program again by pressing \triangleright .

To return to normal play

Press CLEAR while the display for the program setting is not displayed on the TV screen, or select [OFF] in step 3. To play the same program again, select [ON] in step 3 and press \oplus .

To turn off the Control Menu display

Press DISPLAY repeatedly until the Control Menu display is turned off.

To change or cancel a program

- 1 Follow steps 1 to 3 of “Creating Your Own Program”.
- 2 Press to select the program number of the track you want to change or cancel. If you want to delete the track from the program, press CLEAR.
- 3 Follow step 5 for new programming. To cancel a program, select [-] under [T], then press .

To cancel all of the tracks in the programmed order

- 1 Follow steps 1 to 3 of “Creating Your Own Program”.
- 2 Press and select [ALL CLEAR].
- 3 Press .

Note

- When you press CLEAR to return to normal play, Shuffle Play and Repeat Play are also canceled.

Playing in Random Order

(Shuffle Play)

VIDEO CD **C D** **DATA-CD** **DATA DVD**

You can play the contents on a disc in random order. Subsequent Shuffle Play may produce a different playing order.

Note

- Same song may be played repeatedly when you are playing MP3 files.

- 1 Press **DISPLAY** during playback. The Control Menu display appears on the TV screen.
- 2 Press to select [SHUFFLE], then press .
- 3 Press to select the item to be shuffled.
 - **VIDEO CD/CD**
 - [OFF]: Off.
 - [TRACK]: You can shuffle tracks on the disc.
 - **During Program Play**
 - [OFF]: Off.
 - [ON]: You can shuffle tracks selected in Program Play.
 - **DATA CD (except for DivX video file)/ DATA DVD (except for DivX video file)**
 - [OFF]: Off.
 - [ON (MUSIC)]: You can shuffle MP3 files in the folder on the current disc. When no folder is selected, the first folder will play in random order.
- 4 Press . Shuffle Play starts.

To return to normal play

Press CLEAR or select [OFF] in step 3.

To turn off the Control Menu display

Press  DISPLAY repeatedly until the Control Menu display is turned off.

Note

- You cannot use this function with a VIDEO CD and Super VCD with PBC playback.
- When you press CLEAR to return to normal play, Program Play and Repeat Play are also canceled.

Playing Repeatedly

(Repeat Play)



You can play the contents on a disc repeatedly. You can use a combination of Shuffle Play or Program Play modes.

1 Press DISPLAY during playback.

The Control Menu display appears on the TV screen.

2 Press to select [REPEAT], then press .

The options for [REPEAT] appear.

3 Press to select the item to be repeated.

■ DVD VIDEO/DVD-VR

- [OFF]: Off.
- [DISC]: You can repeat all of the titles on the disc.
- [TITLE]: You can repeat the current title on a disc.
- [CHAPTER]: You can repeat the current chapter.

■ VIDEO CD/CD

- [OFF]: Off.
- [DISC]: You can repeats all of the tracks on the disc.
- [TRACK]: You can repeat the current track.

■ DATA CD/DATA DVD

- [OFF]: Off.
- [DISC]: You can repeat all of the folders on the disc.
- [FOLDER]: You can repeat the current folder.
- [TRACK] (MP3 files only): You can repeat the current file.
- [FILE] (DivX video files only): You can repeat the current file.

■ During Shuffle Play or Program Play

- [OFF]: Off.
- [ON]: You can repeat Shuffle Play or Program Play.

4 Press \oplus .

The item is selected.

To return to normal play

Press CLEAR or select [OFF] in step 3.

To turn off the Control Menu display

Press \square DISPLAY repeatedly until the Control Menu display is turned off.

Note

- You cannot use Repeat Play with a VIDEO CD and Super VCD with PBC playback.
- When the system is playing a DATA CD/DATA DVD which contains MP3 files and JPEG image files, and their playing time is not the same, the audio sound will not match the image.
- When [MODE (MUSIC, IMAGE)] is set to [IMAGE] (page 59), you cannot select [TRACK].
- When you press CLEAR to return to normal play, Program Play and Shuffle Play are also canceled.

Tip

- You can quickly display the [REPEAT] status. Press REPEAT on the remote.

Using the DVD's Menu

DVD-V

A DVD is divided into a lot of sections, which make up a picture or music feature. These sections are called "titles". When you play a DVD which contains several titles, you can select the title you want using DVD TOP MENU.

When you play a DVD that allows you to select items such as the language for the subtitles and the language for the sound, select these items using DVD MENU.

1 Press DVD TOP MENU or DVD MENU.

The disc's menu appears on the TV screen. The contents of the menu vary depending on the disc.

2 Press $\leftarrow/\uparrow/\downarrow/\rightarrow$ or the numeric buttons to select the item you want to play or change.**3 Press \oplus .****To display the DVD's menu on the Control Menu display****1 Press \square DISPLAY during playback.**

The Control Menu display appears on the TV screen.

2 Press \uparrow/\downarrow to select  [DISC MENU], then press \oplus .

The options for [DISC MENU] appear.

3 Press \uparrow/\downarrow to select [MENU] or [TOP MENU].**4 Press \oplus .****To turn off the Control Menu display**

Press \square DISPLAY repeatedly until the Control Menu display is turned off.

Changing the Sound

DVD-V

DVD-VR

VIDEO CD

C D

DATA-CD

DATA DVD

When the system is playing a DVD VIDEO or DATA CD/DATA DVD (DivX video file) recorded in multiple audio formats (PCM, Dolby Digital, MPEG audio, or DTS), you can change the audio format. If the DVD VIDEO is recorded with multilingual tracks, you can also change the language.

With a VIDEO CD, CD, DATA CD, or DATA DVD, you can select the sound from the right or left channel and listen to the sound of the selected channel through both the right and left speakers.

Press AUDIO repeatedly during playback to select the desired audio signal.

■ DVD VIDEO

Depending on the DVD VIDEO, the choice of language varies.

When 4 digits are displayed, they indicate a language code. See “Language Code List” (page 114) to confirm which language the code represents. When the same language is displayed two or more times, the DVD VIDEO is recorded in multiple audio formats.

■ DVD-VR

The types of sound tracks recorded on a disc are displayed.

Example:

- [1: MAIN] (main sound)
- [1: SUB] (sub sound)
- [1: MAIN+SUB] (main and sub sound)
- [2: MAIN]
- [2: SUB]
- [2: MAIN+SUB]

Note

- [2: MAIN], [2: SUB], and [2: MAIN+SUB] do not appear when one audio stream is recorded on the disc.

■ VIDEO CD/CD/DATA CD (MP3 file)/DATA DVD (MP3 file)

- [STEREO]: The standard stereo sound
- [1/L]: The sound of the left channel (monaural)
- [2/R]: The sound of the right channel (monaural)

■ DATA CD (DivX video file)/DATA DVD (DivX video file)

The choice of DATA CD or DATA DVD audio signal formats differ, depending on the DivX video file contained on the disc. The format is shown in the display.

■ Super VCD

- [1:STEREO]: The stereo sound of the audio track 1
- [1:1/L]: The sound of the left channel of the audio track 1 (monaural)
- [1:2/R]: The sound of the right channel of the audio track 1 (monaural)
- [2:STEREO]: The stereo sound of the audio track 2
- [2:1/L]: The sound of the left channel of the audio track 2 (monaural)
- [2:2/R]: The sound of the right channel of the audio track 2 (monaural)

Note

- While the system is playing a Super VCD on which the audio track 2 is not recorded, no sound will come out when you select [2:STEREO], [2:1/L], or [2:2/R].

Checking the audio signal format

(DVD VIDEO, DATA DVD, DATA CD only)

If you press AUDIO repeatedly during playback, the format of the current audio signal (PCM, Dolby Digital, DTS, etc.) appears as shown below.

■ DVD

Example:

Dolby Digital 5.1 channel

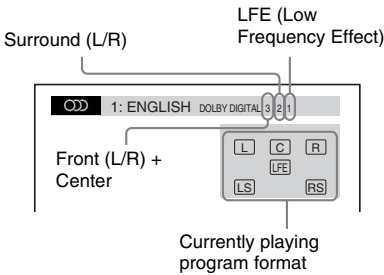

Example:

Dolby Digital 3 channel

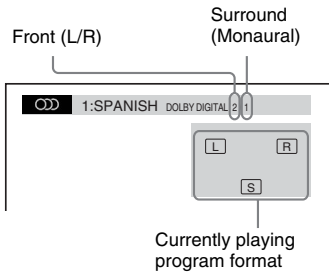

■ DATA CD (DivX video file)/DATA DVD (DivX video file)

Example:

MP3 audio



Selecting [ORIGINAL] or [PLAY LIST] on a DVD-VR

DVD-VR

This function is only available for DVD-VRs with a playlist created.

1 Press **DISPLAY** while the system is in stop mode.

The Control Menu display appears on the TV screen.

2 Press **↑/↓** to select **[ORIGINAL/PLAY LIST]**, then press **+**.

The options for [ORIGINAL/PLAY LIST] appear.

3 Press **↑/↓** to select a setting.

- [PLAY LIST]: You can play the titles created from [ORIGINAL] for editing.
- [ORIGINAL]: You can play the titles originally recorded.

4 Press **+**.

Viewing Information About the Disc

DVD-V

DVD-VR

VIDEO CD

C D

DATA-CD

DATA DVD

Viewing the playing time and remaining time in the front panel display

Press **DISPLAY** repeatedly.

Each time you press **DISPLAY** while playing the disc, the front panel display changes

① → ② → ... → ① → ...

Some displayed items may disappear after a few seconds.

■ DVD VIDEO/DVD-VR

- ① Playing time of the current title
- ② Remaining time of the current title
- ③ Playing time of the current chapter
- ④ Remaining time of the current chapter
- ⑤ Disc name
- ⑥ Title and chapter

■ VIDEO CD (without PBC functions)/CD

- ① Playing time of the current track
- ② Remaining time of the current track
- ③ Playing time of the disc
- ④ Remaining time of the disc
- ⑤ Track name
- ⑥ Track and index^{a)}

^{a)} VIDEO CD only.

■ Super VCD

- ① Playing time of the current track
- ② Track text
- ③ Track and index number

■ DATA CD (MP3 file) or DATA DVD (MP3 file)

- ① Playing time and current track number
- ② Track (file) name^{b)}

^{b)} If an MP3 file has the ID3 tag, the system will display a folder name/track (file) name from the ID3 tag information.

The system can support ID3 version 1.0/1.1/2.2/2.3. ID3 version 2.2/2.3 tag information display has priority when both ID3 version 1.0/1.1 and version 2.2/2.3 tags are used for a single MP3 file.

■ DATA CD (DivX video file)/DATA DVD (DivX video file)

- ① Playing time of the current file
- ② Current file name
- ③ Current album and file number

Note

- The system can only display the first level of the DVD/CD text, such as the disc name or title.
- If a file name of the MP3 file cannot be displayed, “*” will appear in the front panel display instead.
- The disc name or track name may not be displayed depending on the text.
- Playing time of MP3 files and DivX video files may not be displayed correctly.

Tip

- When the system is playing a VIDEO CD with PBC functions, the playing time is displayed in the front panel display.

Viewing the playing time and remaining time on the TV screen

1 Press **DISPLAY** during playback.

The following display appears on the TV screen.

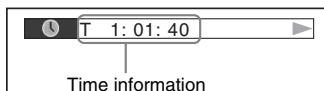

2 Press **DISPLAY** repeatedly to change the time information.

The display and the kinds of time that you can check depend on the disc you are playing.

■ DVD VIDEO/DVD-VR

- T **:*:*
Playing time of the current title
- T-**:*:*
Remaining time of the current title
- C **:*:*
Playing time of the current chapter
- C-**:*:*
Remaining time of the current chapter

■ **VIDEO CD (with PBC functions)**

- ****.****
Playing time of the current scene

■ **VIDEO CD (without PBC functions)/CD**

- **T **.****
Playing time of the current track
- **T_**.****
Remaining time of the current track
- **D **.****
Playing time of the current disc
- **D_**.****
Remaining time of the current disc

■ **DATA CD (MP3 file)/DATA DVD (MP3 file)**

- **T **.****
Playing time of the current track

■ **DATA CD (DivX video file)/DATA DVD (DivX video file)**

- ****.****
Playing time of the current file

Note

- Characters/marks may not be displayed for some languages.
- Depending on the type of disc being played, the system can only display a limited number of characters. Also, depending on the disc, not all text characters will be displayed.

Checking the play information of the disc

To check DVD/CD text

Press DISPLAY repeatedly during playback to display text recorded in the DVD/CD. The DVD/CD text appears on the TV screen only when text is recorded in the disc. You cannot change the text. If the disc does not contain text, "NO TEXT" appears.

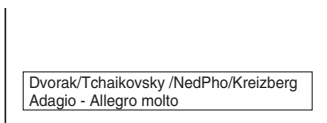

To check DATA CD/DATA DVD (MP3 file/DivX video file) text

By pressing DISPLAY while playing MP3 files or DivX video files on a DATA CD/DATA DVD, you can display the name of the folder/MP3 file/DivX video file, and the audio bit rate (the amount of data per second of the current audio) on your TV screen.

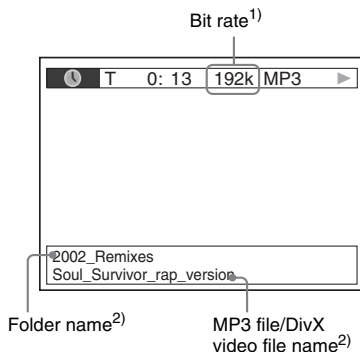

- 1) Appears when:
 - playing an MP3 file on a DATA CD/DATA DVD.
 - playing a DivX video file that contains MP3 audio signals on a DATA CD/DATA DVD.
- 2) If an MP3 file has the ID3 tag, the system will display a folder name/track (file) name from the ID3 tag information.
The system can support ID3 version 1.0/1.1/2.2/2.3. ID3 version 2.2/2.3 tag information display has priority when both ID3 version 1.0/1.1 and version 2.2/2.3 tags are used for a single MP3 file.

Checking the date information of JPEG image file

You can check the date information during playback when the Exif* tag is recorded in the JPEG image file.

Press **DISPLAY** twice during playback.

The Control Menu display appears on the TV screen.

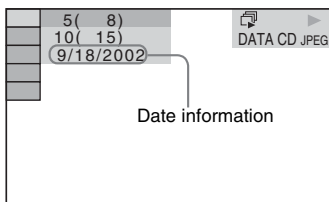

* “Exchangeable Image File Format” is a digital camera image format defined by the Japan Electronics and Information Technology Industries Association (JEITA).

Tip

- Date information is [MM/DD/YYYY].
MM: Month
DD: Day
YYYY: Year
- Date information differs depending on the area.

Changing the Angles

DVD-V

If various angles (multi-angles) for a scene are recorded on a DVD VIDEO, you can change the viewing angle.

Press **ANGLE** during playback to select the desired angle.

Note

- Depending on the DVD VIDEO, you may not be able to change the angle even if multi-angles are recorded on the DVD VIDEO.

Displaying the Subtitles

DVD-V

DVD-VR

DATA-CD

DATA DVD

If subtitles are recorded on a disc, you can turn the subtitles on or off during playback. If multilingual subtitles are recorded on the disc, you can change the subtitle language during playing, or turn the subtitles on or off whenever you want.

Press SUBTITLE during playback to select the desired subtitle language.

Note

- Depending on the DVD VIDEO, you may not be able to change the subtitles even if multilingual subtitles are recorded on the disc. You also may not be able to turn them off.
- You can change the subtitles if the DivX video file has an “.AVI” or “.DivX” extension and contains subtitle information within the same file.

Adjusting the Delay Between the Picture and Sound

(A/V SYNC)

DVD-V

DVD-VR

VIDEO CD

When the sound does not match the pictures on the TV screen, you can adjust the delay between the picture and sound.

- 1 Press SYSTEM MENU.**
- 2 Press \uparrow/\downarrow repeatedly until “A/V SYNC” appears in the front panel display, then press \oplus or \rightarrow .**
- 3 Press \uparrow/\downarrow to select a setting.**
 - “LONG”: adjusts the difference between picture and sound by 130 msec.
 - “SHORT”: adjusts the difference between picture and sound by 70 msec.
 - “OFF”: does not adjust.
- 4 Press \oplus .**

The setting is made.
- 5 Press SYSTEM MENU.**

The system menu turns off.

Note

- Depending on the input stream, “A/V SYNC” may not be effective.

Playing MP3 Files/JPEG Image Files

DATA-CD **DATA DVD**

You can play the MP3 files or JPEG image files:

- which have the extension “.MP3” (MP3 file) or “.JPG”/“.JPEG” (JPEG image file)
 - which conform to the DCF* image file format
- * “Design rule for Camera File system”: Image standards for digital cameras regulated by Japan Electronics and Information Technology Industries Association (JEITA).

Note

- The system will play any data with the extension “.MP3”, “.JPG”, or “.JPEG” even if they are not in MP3 or JPEG format. Playing these data may generate a loud noise which could damage your speaker system.
- The system does not conform to audio in MP3PRO format.
- The system can recognize up to 200 folders, and will not play any folders beyond the 200th. (Depending on the folder configuration, the number of folders that can be recognized by the system may decrease.)
- The system can recognize up to 150 MP3 files/JPEG image files in a folder.
- The system may take longer time to playback, when progressing to the following folder or jumping to other folder.
- The system may not play certain types of JPEG image files (e.g.: a JPEG image file that is less than 8 (width) × 8 (height)).

Selecting an MP3 file or folder

- 1** Load a DATA CD or DATA DVD.
- 2** Press DVD MENU.

The folders recorded on the DATA CD or DATA DVD appear on the TV screen. When a folder is being played, its title is shaded.

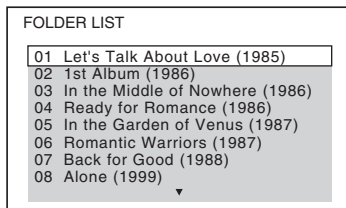

- 3** Press **↑/↓** to select a folder.

■ To play MP3 files in a folder

Press **▷** to start playing the selected folder.

■ To select an MP3 file

Press **⊕**.

A list of files contained in the folder appears.



Press **↑/↓** to select a file and press **⊕**.

The system starts playing the selected file.

You can turn the file list off by pressing DVD MENU. Pressing DVD MENU again will display the folder list.

To stop playback

Press ■.

To play the next or previous MP3 file

Press ►► to play the next MP3 file. Press ◀◀ twice to play the previous MP3 file. When you press ◀◀ once, you can go to the beginning of the current MP3 file. Note that you can select the next folder by continuing to press ►► after the last file on the current folder, but you cannot return to the previous folder by pressing ◀◀.

To return to the previous folder, select the folder from the folder list.

To return to the previous display

Press ↶ RETURN.

To turn off the display

Press DVD MENU.

Selecting a JPEG image file or folder

- 1 Load a DATA CD or DATA DVD.
- 2 Press DVD MENU.

The folder recorded on the DATA CD or DATA DVD appear on the TV screen. When a folder is being played, its title is shaded.

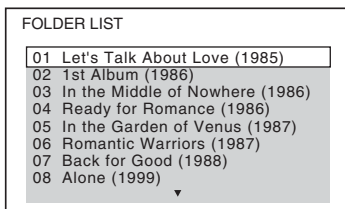

- 3 Press ↑/↓ to select a folder.

■ To play JPEG image files in a folder

Press ▷ to start playing the selected folder.

■ To select a JPEG image file by displaying the subscreens

Press PICTURE NAVI.

Images of JPEG image files in the folder appear in 16 subscreens.

1	2	3	4
5	6	7	8
9	10	11	12
13	14	15	16

Press ←/↑/↓/→ to select the JPEG image file you want to view, then press ⊕.

To return to normal screen, press ↶ RETURN.

Note

- PICTURE NAVI does not work when you set [MODE (MUSIC, IMAGE)] to [MUSIC].

Tip

- A scroll box is displayed at the right side of the TV screen. To display the additional JPEG image files, select the bottom JPEG image file and press **↓**. To return to the previous JPEG image file, select the top JPEG image file and press **↑**.

To play the next or previous JPEG image file

Press **←/→** when the Control Menu display is not displayed on the TV screen. Note that you can select the next folder by continuing to press **→** after the last image on the current folder, but that you cannot return to the previous folder by pressing **←**. To return to the previous folder, select the folder from the folder list.

To rotate a JPEG image file

When a JPEG image file is displayed on the TV screen, you can rotate the JPEG image file by 90 degrees.

Press **↑/↓** while viewing a JPEG image file.

Press **CLEAR** to return to normal view.

Note

- You cannot rotate the JPEG image file when you set [JPEG RESOLUTION] in [HDMI SETUP] to [(1920×1080i)HD] or [(1920×1080i)HD] (page 94).

To stop playback

Press **■**.

Displaying the list of MP3 files/JPEG image files/DivX video files

1 Press **⏏** **DISPLAY** during playback.

The Control Menu display appears on the TV screen.

2 Press **↑/↓** to select **[BROWSING]**, then press **⊕**.

The options for [BROWSING] appear.

3 Press **↑/↓** to select the desired list, then press **⊕**.

- [FOLDER LIST]: The list of folders appears. Follow step 3 of “Selecting an MP3 file or folder” (page 56) or “Selecting a JPEG image file or folder” (page 57).
- [PICTURE LIST]: Images of JPEG image files in the folder appear in 16 subscreens. Follow step 3 of “Selecting a JPEG image file or folder”(page 57).
If there is no JPEG image file in the selected folder, [No image data] appears. In this case, select [FOLDER LIST] to display the list of folders.

Playing MP3 Files and JPEG Image Files as a Slide Show with Sound

DATA-CD DATA DVD

You can play a slide show with sound by first placing both MP3 files and JPEG image files in the same folder on a DATA CD or DATA DVD.

- 1 Load a DATA CD or DATA DVD.**
- 2 Press  DISPLAY while the system is in stop mode.**

The Control Menu display appears on the TV screen.
- 3 Press \uparrow/\downarrow to select  [MODE (MUSIC, IMAGE)], then press \oplus .**

The options for [MODE (MUSIC, IMAGE)] appear.
- 4 Press \uparrow/\downarrow to select a setting.**
 - **[AUTO]:** You can play both the JPEG image files and MP3 files in the same folder as a slide show.
 - **[MUSIC]:** You can play only MP3 files continuously.
 - **[IMAGE]:** You can play only JPEG image files as a slide show.
- 5 Press \oplus .**
- 6 Press DVD MENU.**

The list of folder recorded on the DATA CD or DATA DVD appears.
- 7 Press \uparrow/\downarrow to select the desired folder and press \triangleright .**

The system starts playing the selected folder.

You can turn the folder list on or off by pressing DVD MENU repeatedly.

Note

- PICTURE NAVI does not work when you set [MODE (MUSIC, IMAGE)] to [MUSIC].
- If you play large MP3 file and JPEG image file at the same time, the sound may skip. Sony recommends that you set the MP3 bit rate to 128 kbps or lower when creating the file. If the sound still skips, then reduce the size of the JPEG file.

Specifying the slide show duration of JPEG image files

- 1 Press  DISPLAY twice.**

The Control Menu display appears on the TV screen.
- 2 Press \uparrow/\downarrow to select  [INTERVAL], then press \oplus .**

The options for [INTERVAL] appear.
- 3 Press \uparrow/\downarrow to select a setting.**
 - **[NORMAL]:** You can set to the standard duration.
 - **[FAST]:** You can set the duration shorter than [NORMAL].
 - **[SLOW1]:** You can set the duration longer than [NORMAL].
 - **[SLOW2]:** You can set the duration longer than [SLOW1].
- 4 Press \oplus .**

Note

- Some JPEG image files may take longer to display than the option you selected. Especially progressive JPEG image files or JPEG image files of 3,000,000 pixels or more.
- Duration of interval depends on the [JPEG RESOLUTION] setting in [HDMI SETUP] (page 94).

Selecting an effect for JPEG image files in the slide show

- 1 Press  DISPLAY twice.**

The Control Menu display appears on the TV screen.
- 2 Press \uparrow/\downarrow to select  [EFFECT], then press \oplus .**

The options for [EFFECT] appear.
- 3 Press \uparrow/\downarrow to select a setting.**
 - [MODE1]: The JPEG image file sweeps in from top to bottom.
 - [MODE2]: The JPEG image file stretches out from left to right of the TV screen.
 - [MODE3]: The JPEG image file stretches out from the center of the TV screen.
 - [MODE4]: The JPEG image file randomly cycle through the effects.
 - [MODE5]: The next JPEG image file slides over the previous image.
 - [OFF]: Off.
- 4 Press \oplus .**

Note

- The [EFFECT] setting is not effective when you set [JPEG RESOLUTION] in [HDMI SETUP] to [(1920×1080i)HD] or [(1920×1080i)HD] (page 94).

Enjoying DivX[®] Videos

DATA-CD DATA DVD

About DivX video files

DivX[®] is a video file compression technology, developed by DivX, Inc. This product is an official DivX[®] Certified product.

You can play a DATA CD or DATA DVD that contains DivX[®] video files.

A DATA CD or DATA DVD that the system can play

Playback of a DATA CD (CD-ROM/CD-R/CD-RW) or DATA DVD (DVD-ROM/DVD-R/DVD-RW/DVD+R/DVD+RW) on this system is subject to certain conditions:

- With a DATA CD/DATA DVD that contains DivX video files in addition to MP3 audio tracks or JPEG image files, the system plays only the DivX video files.

However, this system only plays a DATA CD of format ISO 9660 Level 1/Level 2 or Joliet, and a DATA DVD of Universal Disk Format (UDF). Refer to the operating instructions supplied with the disc drives and the recording software (not supplied) for details on the recording format.

About playback order of data on a DATA CD or DATA DVD

Note that the playback order may not be applicable, depending on the software used for creating the DivX video file, or if there are more than 200 folders and 150 DivX video files in each folder.

Note

- The system may not be able to play some DATA CDs/DATA DVDs created in the Packet Write format.

DivX video files that the system can play

The system can play data that is recorded in DivX format, and which has the extension “.AVI”, or “.DIVX”. The system will not play files with the extension “.AVI” or “.DIVX” if they do not contain a DivX video.

Tip

- For details about playable MP3 audio tracks or JPEG image files on a DATA CD or DATA DVD, see “Playable Discs” (page 6).

Note

- The system may not play a DivX video file when the file has been combined from two or more DivX video files.
- The system cannot play a DivX video file of size more than 720 (width) × 576 (height) or 2GB.
- Depending on the DivX video file, sound may skip or not match the pictures on the TV screen.
- The system cannot play some DivX video files that are longer than 3 hours.
- Depending on the DivX video file, the picture may pause or be unclear. In which case, it is recommended that you create the file at a lower bit rate. If the sound is still noisy, MP3 is the recommended audio format. Note, however, this system does not conform to WMA (Windows Media Audio) format for playing DivX files.
- Because of the compression technology used for DivX video files, it may take some time after you press ▷ for the picture to appear.

Selecting a folder

1 Press DVD MENU.

A list of folders on the disc appears. Only folders that contain DivX video files are listed.

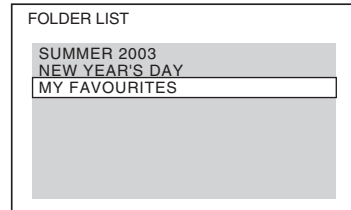

2 Press ↑/↓ to select the folder you want to play.

3 Press ▷.

The system starts playing the selected folder.

To select DivX video files, see “Selecting a DivX video file” (page 62).

To go to the next or previous page

Press ●→ / ←●.

To turn off the display

Press DVD MENU repeatedly.

To stop playback

Press ■.

Selecting a DivX video file

- 1 After step 2 of "Selecting a folder," press **+**.

The list of files in the folder appears.

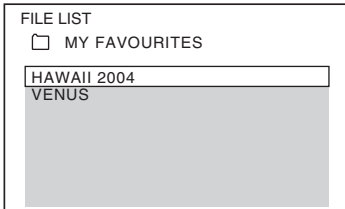

- 2 Press **↑/↓** to select a file and press **+**.
The selected file starts playing.

To go to the next or previous page

Press **→/←**.

To return to the previous display

Press **↶** RETURN.

To stop playback

Press **■**.

To play the next or previous DivX video file without turning on the above file list

You can select the next or previous DivX video file in the same folder by pressing **▶▶/◀◀**. You can also select the first file of the next folder by pressing **▶▶** during playback of the last file of the current folder. Note that you cannot return to the previous folder by pressing **◀◀**. To return to the previous folder, select it from the folder list.

Tip

- If the number of viewing times is preset, you can play the DivX video files as many times as the preset number. The following occurrences are counted:
 - when the system is turned off.
 - when another file is played.

Playing a VIDEO CD with PBC Functions (Ver.2.0)

(PBC Playback)

VIDEO CD

With PBC (Playback Control) functions, you can enjoy simple interactive operations, search functions, and other such operations. PBC playback allows you to play a VIDEO CD interactively by following the menu on the TV screen.

- 1 Start playing a VIDEO CD with PBC functions.

The menu for your selection appears on the TV screen.

- 2 Select the item number you want using the numeric buttons.

- 3 Press **+**.

- 4 Follow the instructions in the menu for interactive operations.

Refer to the operating instructions supplied with the disc, as the operating procedure may differ depending on the VIDEO CD.

To go back to the menu

Press **↶** RETURN.

Note

- Depending on the VIDEO CD, [Press ENTER] in Step 3 may appear as [Press SELECT] in the operating instructions supplied with the disc. In this case, press **▷**.

Tip

- To play without using the PBC function, press **◀◀/▶▶** or the numeric buttons while the system is in stop mode to select a track, then press **▷** or **+**. The system starts playback. You cannot play still pictures such as a menu. To return to PBC playback, press **■** twice, then press **▷**.

Sound Adjustments

Enjoying Surround Sound by Using Decoding Mode

DVD-V

DVD-VR

VIDEO CD

C D

DATA-CD

DATA DVD

You can enjoy surround sound simply by selecting one of the system's pre-programmed decoding mode. They bring exciting and powerful sound of movie theaters into your home.

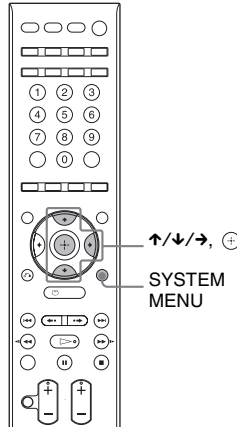

- 1** Press **SYSTEM MENU**.
- 2** Press **↑/↓** repeatedly until **"DEC. MODE"** appears in the front panel display, then press **⊕** or **→**.
- 3** Press **↑/↓** repeatedly until the decoding mode you want appears in the front panel display.

Display	Decoding mode	Effect
"A.F.D. STD"	AUTO FORMAT DIRECT STANDARD	Presents sound as it was recorded/encoded. Depending on the source, the speakers that output sound will vary.
"A.F.D. MULTI"	AUTO FORMAT DIRECT MULTI	2 channel source: Sound that is recorded in 2 channel (front left and right channel) is also assigned to the surround left and right channel. This mode outputs sound from the front left and right speakers, surround left and right speakers, and subwoofer. The center speaker does not output any sound. Multi channel source: Depending on the source, speakers that output the sound will vary.
"PLII MOVIE"	Dolby Pro Logic II MOVIE	Performs Pro Logic II movie mode decoding to the input signal and produces five full-bandwidth output channels from 2 channel sources. This setting is ideal for watching videos of overdubbed or old movies. This mode outputs sound from all the speakers and subwoofer. Sound may not be output from all speakers depending on the source.

Display	Decoding mode	Effect
“PLII MUSIC”	Dolby Pro Logic II MUSIC	Performs Pro Logic II music mode decoding to the input signal and produces five full-bandwidth output channels from 2 channel sources. This setting is ideal for normal stereo sources such as a CD. This mode outputs sound from all the speakers and subwoofer. Sound may not be output from all speakers depending on the source.
“2CH STEREO”	2 CHANNEL STEREO	Outputs the sound from the front left and right speakers and subwoofer. Multi channel surround formats are downmixed to 2 channels.
“HP THEATER”	HEADPHONE THEATER	Outputs the sound as surround from headphones left and right.
“HP 2CH”	HEADPHONE 2 CHANNEL STEREO	Outputs the sound from headphones left and right. Multi channel surround formats are downmixed to 2 channels.

4 Press \oplus .

The selected decoding mode is applied.

5 Press SYSTEM MENU.

The system menu turns off.

To turn the surround effect off

Select “A.F.D. STD” or “2CH STEREO” for “DEC. MODE” and set the sound mode (page 65) to “MOVIE” or “MUSIC”.

Note

- Depending on the disc or source, when you select “A.F.D. MULTI”, the beginning of the sound may be cut off as the optimum mode is automatically selected. To avoid cutting the sound, select “A.F.D. STD”.
- When the input signal is multi channel source, “PLII MOVIE” and “PLII MUSIC” are canceled and the multi channel source is output directly.
- When the bilingual broadcast sound is input, “PLII MOVIE” and “PLII MUSIC” are not effective.
- Depending on the input stream, the decoding mode may not be effective.
- When you select “A.F.D. MULTI”, the surround or stereo effect may not be effective. In this case, select “A.F.D. STD”, “PLII MOVIE”, or “PLII MUSIC”.
- When changing the decoding mode while using the S-AIR receiver (not supplied, page 76), sound from the S-AIR receiver may skip.

Tip

- The system memorizes the last decoding mode selected for each function mode. Whenever you select a function such as DVD or TUNER, the decoding mode that was last applied to function is automatically applied again. For example, if you listen to DVD with Dolby Pro Logic II MOVIE as the decoding mode, then change to another function, and then return to DVD, Dolby Pro Logic II MOVIE will be applied again.

Selecting the Sound Mode

DVD-V

DVD-VR

VIDEO CD

C D

DATA-CD

DATA DVD

You can choose a suitable sound mode for movies or music.

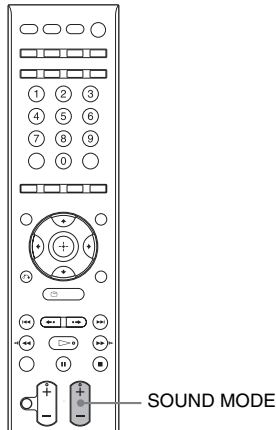

Press SOUND MODE repeatedly during playback until the desired mode appears in the front panel display.

- **“AUTO”**: The system selects “MOVIE” or “MUSIC” automatically to produce the sound effect depending on the disc or sound stream.
- **“MOVIE”**: The system provides sound suitable for movies.
- **“MUSIC”**: The system provides sound suitable for music.
- **“SPORTS”**: The system adds reverberation for the sports program.
- **“NEWS”**: The system provides the sound for the voice program, such as news.
- **“OMNI-DIR”**: The system reproduces the stereo effect everywhere surrounding by satellite speakers.

Note

- Depending on the disc or source, when you select “AUTO”, the beginning of the sound may be cut off as the system selects the optimum mode automatically. To avoid cutting the sound, select other than “AUTO”.
- When changing the sound mode while using the S-AIR receiver (not supplied, page 76), sound from the S-AIR receiver may skip.
- The system memorizes the last sound mode selected for each function mode.
- When you select “SPORTS” depending on the input stream, Pro Logic II music may be applied automatically.

Tip

- When you connect headphones to the surround amplifier, you can select “AUTO”, “MOVIE” or “MUSIC” only.

Adjusting the Bass, Middle, and Treble Level

You can adjust the bass, middle, and treble level easily.

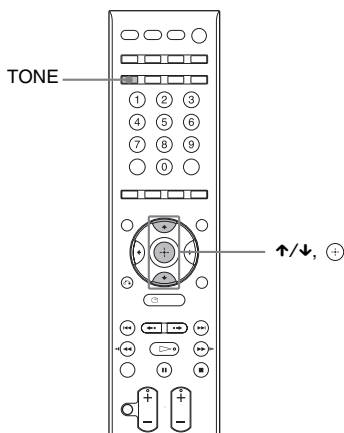

1 Press **TONE** repeatedly until “BASS,” “MIDDLE,” or “TREBLE” appears in the front panel display.

- “BASS”: adjusts the bass level (–6.0 – +6.0 dB, 0.5 dB increments).
- “MIDDLE”: adjusts the middle level (–6.0 – +6.0 dB, 0.5 dB increments).
- “TREBLE”: adjusts the treble level (–6.0 – +6.0 dB, 0.5 dB increments).

2 Press **↑/↓** to adjust.

The adjusted value appears in the front panel display.

3 Press **⊕**.

Note

- Depending on the sound mode, the sound effect may be less noticeable
- Adjustment of “MIDDLE” is not available when you connect headphones to the surround amplifier.

Tuner Functions

Presetting Radio Stations

You can preset 20 FM stations, and 10 AM stations. Before tuning, make sure to turn down the volume to minimum.

Tip

- You can operate the tuner function by observing the following display on the TV screen.

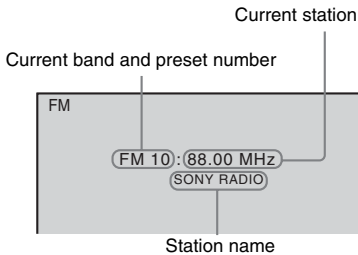

1 Press FUNCTION repeatedly until “FM” or “AM” appears in the front panel display.

2 Press and hold TUNING +/- until the auto scanning starts.

Scanning stops when the system tunes in a station. “TUNED” and “STEREO” (for stereo program) light up in the front panel display.

3 Press SYSTEM MENU.

4 Press ↑/↓ repeatedly until “MEMORY” appears in the front panel display.

5 Press ⊕ or →.

A preset number appears in the front panel display.



6 Press ↑/↓ to select the preset number you want.



Tip

- You can select the preset number directly by pressing the numeric buttons.

7 Press ⊕.

“COMPLETE” appears in the front panel display, and the station is stored.

8 Repeat steps 2 to 7 to store other stations.

9 Press SYSTEM MENU.

The system menu turns off.

To change the preset number

Select the desired preset number by pressing PRESET +/- (page 68), then perform the procedure from step 3.

Listening to the Radio

Preset radio stations in the system's memory first (see "Presetting Radio Stations" (page 67)).

- 1 Press FUNCTION repeatedly until "FM" or "AM" appears in the front panel display.**

The last received station is tuned in.

- 2 Press PRESET +/- repeatedly to select the preset station.**

Each time you press the button, the system tunes in one preset station.

Tip

- You can select the preset number directly by pressing the numeric buttons.

- 3 Adjust the volume by pressing VOLUME +/-.**

To turn off the radio

Press I/⏻ to turn off the system.

To change to another function, press FUNCTION.

To listen to non-preset radio stations

Use manual or automatic tuning in step 2.

For manual tuning, press TUNING +/- repeatedly.

For automatic tuning, press and hold TUNING +/- . The automatic tuning stops automatically when the system receives the radio station. To stop the automatic tuning manually, press TUNING +/- or ■.

To listen to radio stations when you know the frequencies

Use direct tuning in step 2.

- 1 Press D.TUNING.**
- 2 Press the numeric buttons to select the frequency number you want to listen to. For example, to input "98.0MHz," press the numeric buttons in the following order.
9 → 8 → 0**
- 3 Press ⊕.**

Tip

- To improve reception, reorient the connected antennas (aerials).

If an FM program is noisy

If an FM program is noisy, you can select monaural reception. There will be no stereo effect, but reception will improve.

- 1 Press SYSTEM MENU.**
- 2 Press ↑/↓ repeatedly until "FM MODE" appears in the front panel display, then press ⊕ or →.**
- 3 Press ↑/↓ to select "MONO".**
 - "STEREO": stereo reception.
 - "MONO": monaural reception.
- 4 Press ⊕.**

The setting is made.
- 5 Press SYSTEM MENU.**

The system menu turns off.

Naming preset stations

You can enter a name for preset stations. These names (for example, “XYZ”) appear in the front panel display when a station is selected. Only one name can be entered for each preset station.

- 1** Press **FUNCTION** repeatedly until “FM” or “AM” appears in the front panel display.
The last received station is tuned in.
- 2** Press **PRESET +/-** repeatedly to select the preset station you want to create an index name for.
- 3** Press **SYSTEM MENU**.
- 4** Press **↑/↓** repeatedly until “NAME IN” appears in the front panel display.



- 5** Press **⊕** or **→**.
- 6** Create a name by using **←/↑/↓/→**.
Press **↑/↓** to select a character, then press **→** to move the cursor to the next position.
You can input letters, numbers, and other symbols for a radio station.

If you make a mistake

Press **←/→** repeatedly until the character to be changed flashes, then press **↑/↓** to select the desired character.

To erase the character, press **←/→** repeatedly until the character to be erased flashes, then press **CLEAR**.

- 7** Press **⊕**.
“COMPLETE” appears in the front panel display, and the station name is stored.
- 8** Press **SYSTEM MENU**.
The system menu turns off.

Viewing the station name or frequency in the front panel display

When the system is set to “FM” or “AM,” you can check the frequency using the front panel display.

Press DISPLAY.

Each time you press **DISPLAY**, the front panel display changes as shown.

- ① Station name*
- ② Frequency**

* This is displayed if you have entered a name for a preset station.

** Returns to the original display when several seconds have elapsed.

Using the Radio Data System (RDS)

What is the Radio Data System?

The Radio Data System (RDS) is a broadcasting service that allows radio stations to send additional information along with the regular program signal. This tuner offers convenient RDS features, such as station name display. RDS is available only for FM stations.*

Note

- RDS may not work properly if the station you are tuned to is not transmitting the RDS signal properly, or if the signal strength is weak.
- * Not all FM stations provide RDS service, nor do they provide the same type of services. If you are not familiar with the RDS system, check with your local radio stations for details on RDS services in your area.

Receiving RDS broadcasts

Simply select a station from the FM band.

When you tune in a station that provides RDS services, the station name* appears in the front panel display.

- * If an RDS broadcast is not received, a station name will not appear in the front panel display.

Tip

- When a station name is displayed, you can check the frequency by pressing DISPLAY repeatedly.

Control for HDMI/External Audio Device

Using the Control for HDMI Function for “BRAVIA” Sync

This function is available on TVs with the “BRAVIA” Sync function only.

By connecting Sony components that are compatible with the Control for HDMI function with an HDMI cable (not supplied), operation is simplified as below:

- Theatre Mode (page 71)
- One-Touch Play (page 72)
- System Power Off (page 72)
- System Audio Control (page 72)
- Volume Limit (page 73)

Control for HDMI is a mutual control function standard used by CEC (Consumer Electronics Control) for HDMI (High-Definition Multimedia Interface).

The Control for HDMI function will not work in the following cases:

- When you connect this system to a component which is not compatible with the Control for HDMI function.
- A component does not have an HDMI jack.

There are convenient buttons on the system’s remote for operating the TV, such as THEATRE, ONE-TOUCH PLAY, TV I/O. For details, see “Controlling the TV with the Supplied Remote” (page 80) and refer to the operating instructions of the TV.

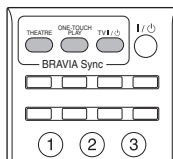

Note

- Depending on the connected component, the Control for HDMI function may not work. Refer to the operating instructions supplied with the component.
- The Control for HDMI function may not work if you connect a component other than Sony, even if the component is compatible with the Control for HDMI function.

Preparing for the Control for HDMI function

(Control for HDMI - Easy Setting)

The system is compatible with the Control for HDMI - Easy Setting function. If the TV is compatible with the Control for HDMI - Easy Setting function, you can set the system's [CONTROL FOR HDMI] function automatically by setting the TV. For details, refer to the operating instructions of the TV.

If the TV is not compatible with the Control for HDMI - Easy Setting function, set the Control for HDMI function of the system and TV manually.

Note

- Displayed items vary depending on the country model.

- 1 Make sure that the system and the TV are connected with an HDMI cable.**
- 2 Turn on the TV and press I/ON to turn on the system.**
- 3 Switch the input selector on your TV so that the signal from the system through the HDMI input appears on the TV screen.**
- 4 Set the Control for HDMI function of the system and TV.**

For details of the setting of the system, see the following steps. For details of the setting of the TV, refer to the operating instructions of the TV (depending on the TV, the default setting of the Control for HDMI function is set to off).

To set the [CONTROL FOR HDMI] function to on/off

- 1 Press FUNCTION repeatedly until "DVD" appears in the front panel display.**
- 2 Press [MENU] DISPLAY while the system is in stop mode.**
The Control Menu display appears on the TV screen.
- 3 Press \uparrow/\downarrow to select [SETUP] , then press [ENTER] .**
The options for [SETUP] appear.
- 4 Press \uparrow/\downarrow to select [CUSTOM], then press [ENTER] .**
The Setup Display appears.
- 5 Press \uparrow/\downarrow to select [HDMI SETUP], then press [ENTER] .**
The options for [HDMI SETUP] appear.
- 6 Press \uparrow/\downarrow to select [CONTROL FOR HDMI], then press [ENTER] .**
- 7 Press \uparrow/\downarrow to select the setting, then press [ENTER] .**
 - [OFF]: Off.
 - [ON]: On.

Note

- When [Please verify the HDMI connection.] appears, make sure the HDMI connection is correct.

Using the Theatre Mode

(Theatre Mode)

If your TV is compatible with the Theatre Mode, you can enjoy optimal image suited for movies and the sound is output from the system's speaker automatically by pressing THEATRE.

Watching DVD by a single button press

(One-Touch Play)

By only pressing ONE-TOUCH PLAY, the TV turns on, the TV is set for DVD input mode, and the system starts playing a disc automatically.

The One-Touch Play also works when:

- You insert the disc and ► appears in the front panel display.
- You press DVD TOP MENU/DVD MENU and ► appears in the front panel display.
- You select the “DVD” function by pressing FUNCTION and ► appears in the front panel display.

Note

- One-Touch Play does not work when you press ▷.

The system and TV work as follows (e.g.):

This system	TV
Turns on. (If not already turned on.)	Turns on. (If not already turned on.)
↓	↓
Switches to “DVD” function.	Switches to HDMI input.
↓	↓
Starts playing the disc and outputs the sound.	Minimizes sound level. (System Audio Control)

Note

- Make sure the HDMI connection is correct, and set the [CONTROL FOR HDMI] to [ON].
- Depending on the TV, the beginning of the content may not be played back.
- Depending on the disc, playback may take a while to start.

Turning the system off in sync with the TV

(System Power Off)

When you turn the TV off by using the POWER button on the TV’s remote or TV  on the system’s remote, the system turns off automatically.

Note

- Before using the System Power Off function, set the function for TV power. For details, refer to the operating instructions of the TV.
- Depending on the status of the system (e.g.: while other than “DVD” or “TV” function, or playing a CD), the system may not turn off automatically.

Enjoying TV sound from the speakers in this system

(System Audio Control)

You can enjoy TV sound in this system by easy operation.

To use this function, connect the system and the TV with an audio cord (not supplied) and an HDMI cable (not supplied) (page 27).

Depending on the TV, when you set the system to the “TV” function, the System Audio Control function is activated. TV sound is output from the system speakers, and the volume of the TV speakers is minimized automatically.

You can use the System Audio Control function as follows:

- While you are watching the TV and the function of the system is switched to “TV”, TV sound is output from the system speakers automatically.
- You can control the system’s volume by the remote of the TV.
- If you turn the system off or set the function of the system to other than “TV”, TV sound is output from the TV speakers.

You can also operate the System Audio Control function from the TV menu. For details, refer to the operating instructions of the TV.

Note

- If the TV is turned on before turning on the system, TV sound will not be output for a moment.
- While the TV is in PAP (picture and picture) mode, the System Audio Control function will not work. When the TV exits PAP mode, the output method of the TV returns to the one before PAP mode.
- If you select a TV program during DVD playback with the system, the “TV” function is automatically set to output TV sound.
- When you activate One-Touch Play during watching TV, the System Audio Control function is activated and the TV sound is muted.

Tip

- You can connect the system and the TV audio digitally. For details, see “④ Connecting the TV” (page 26).

Setting the Maximum Volume Level of the System

(Volume Limit)

If you change the output method of the TV to the system speaker on the TV menu or by pressing THEATRE, loud sound may be output depending on the volume level of the system. You can prevent this by limiting the maximum level of the volume. For details, see “[VOLUME LIMIT]” (page 93).

Using the DIGITAL MEDIA PORT Adapter

The DIGITAL MEDIA PORT (DMPORT) adapter (not supplied) is for enjoying sound from a portable audio source or computer. By connecting a DIGITAL MEDIA PORT adapter, you can enjoy sound from the connected component on the system.

Available DIGITAL MEDIA PORT adapters vary in each area.

For details on connecting the DIGITAL MEDIA PORT adapter, see “Connecting the other components” (page 28).

Note

- Do not connect an adapter other than the DIGITAL MEDIA PORT adapter.
- Do not connect or disconnect the DIGITAL MEDIA PORT adapter to/from the control unit while the system is turned on.
- Depending on the type of DIGITAL MEDIA PORT adapter, images may also be output. In this case, the system outputs only a composite video signal (see page 26, connection method **A**) regardless of the type of video signal.
- When you use the system and the Bluetooth Wireless Audio Adapter (such as TDM-BT1, not supplied) at the same time, transmission distance between the Bluetooth transmitter and Bluetooth Wireless Audio Adapter may be reduced. In this case, place the Bluetooth transmitter as far as possible from the system, or move the Bluetooth Wireless Audio Adapter closer to the Bluetooth transmitter.
- When you use the system and the Wireless Network Audio Adapter (such as TDM-NC1, not supplied) at the same time, place the Wireless Network Audio Adapter as far as possible from the system.

Playing the connected component on the system

- 1 Press **FUNCTION** repeatedly until “**DMPORT**” appears in the front panel display.
- 2 Start playback of the connected component.

The sound and images from the connected component are played on the system or connected TV.

For operation details, refer to the operating instructions of the DIGITAL MEDIA PORT adapter.

Tip

- When listening to MP3 or other compressed music using a portable audio source, you can enhance the sound. Select “A.F.D. STD” for “DEC. MODE” (page 63) and set the sound mode (page 65) to “MOVIE”, “MUSIC” or “NEWS”. To cancel, select other than “A.F.D. STD”.
- Depending on the type of DIGITAL MEDIA PORT adapter, you may be able to operate a connected component using either the buttons on the remote or the control unit. The following illustration shows an example of buttons that can be used in this case.

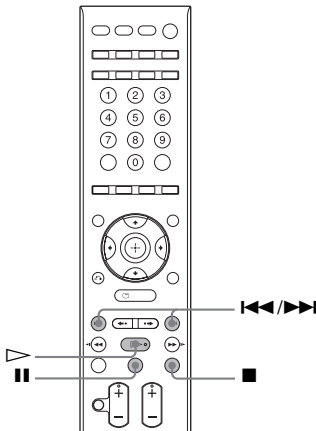

Using an S-AIR Product

The system is compatible with the S-AIR function (page 113), which allows sound transmission between S-AIR products.

About S-AIR products

There are two types of S-AIR product.

- S-AIR main unit (control unit and subwoofer in this system): This is for transmitting sound. You can use up to 3 S-AIR main unit. (The number of usable S-AIR main unit depends on the use environment.)
- S-AIR sub unit (surround amplifier in this system): This is for receiving sound.
 - Surround amplifier: You can enjoy surround speaker sound wirelessly.
 - S-AIR receiver (not supplied): You can enjoy system sound in another room.

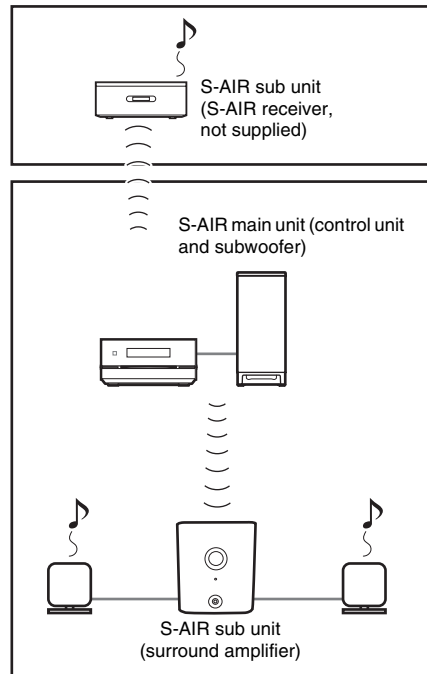

Establishing sound transmission between the S-AIR main unit and S-AIR sub unit (ID setting)

*For the surround amplifier (supplied)
For the S-AIR receiver (not supplied)*

Simply by matching the ID of the S-AIR main unit and the S-AIR sub unit, you can establish sound transmission. You can use multiple S-AIR main unit by setting a different ID for each component.

To set the ID of the S-AIR main unit

- 1** Press **I/⏻** on the S-AIR main unit.
The system turns on.
 - 2** Press **FUNCTION** repeatedly until “DVD” appears in the front panel display.
 - 3** Press **☰ DISPLAY** while the system is in stop mode.
The Control Menu display appears on the TV screen.
 - 4** Press **↑/↓** to select **[SETUP]**, then press **⊕**.
The options for [SETUP] appear.
 - 5** Press **↑/↓** to select **[CUSTOM]**, then press **⊕**.
The Setup Display appears.
 - 6** Press **↑/↓** to select **[AUDIO SETUP]**, then press **⊕**.
The options for [AUDIO SETUP] appear.
 - 7** Press **↑/↓** to select **[S-AIR SETUP →]**, then press **⊕**.
- Note**
- When the wireless transmitter is not inserted in the S-AIR main unit, [S-AIR SETUP] cannot be selected.
- 8** Press **↑/↓** to select **[ID]**, then press **⊕**.

- 9** Press **↑/↓** to select the desired ID, then press **⊕**.

You can select any ID (A, B, or C).
The confirmation display appears.

- 10** Press **⊕**.

Set the S-AIR sub unit to the same ID.
Sound transmission is established as follows (example):

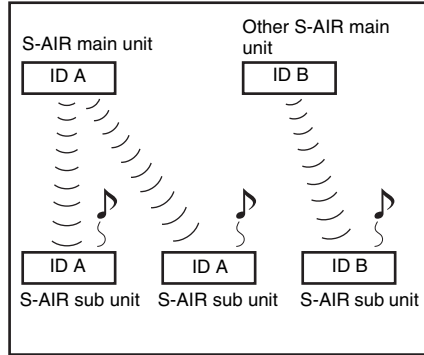

Tip

- To confirm the current ID, perform Steps 1 to 7 above. When you pair the S-AIR main unit with the S-AIR sub unit (page 77), [(PAIRING)] appears beside ID on the display for selecting ID.

To set the ID of the surround amplifier

- 1** Make sure that the **SURROUND SELECTOR** switch of the surround amplifier is set to **SURROUND**.
- 2** Set the **S-AIR ID** switch of the surround amplifier to match the ID (A, B, or C) of the S-AIR main unit.
- 3** Press **POWER** on the surround amplifier.

When sound transmission is established, the **POWER / ON LINE** indicator of the surround amplifier turns green.

For details of the **POWER / ON LINE** indicator, see “To check the transmission status” (page 32).

To set the ID of the S-AIR receiver (not supplied)

Refer to the operating instructions of the S-AIR receiver.

Note

- It is easy to set the same ID for the S-AIR main unit and S-AIR sub unit to establish sound transmission. However, neighbours may also receive your system's sound if IDs are the same, or you may receive the sound from neighbours. To prevent this, you can identify the S-AIR main unit with a specific S-AIR sub unit by performing the pairing operation (page 77).

Enjoying the system's sound in another room

For the S-AIR receiver (not supplied)

You can enjoy the system's sound by using the S-AIR receiver. The S-AIR receiver can be installed anywhere, regardless of the location of the S-AIR main unit, for enjoying the system's sound in another room.

For details of the S-AIR receiver, refer to the operating instructions of the S-AIR receiver.

1 Set the ID of the S-AIR receiver to that of the S-AIR main unit.

- To set the ID of the S-AIR main unit, see "To set the ID of the S-AIR main unit" (page 75).
- To set the ID of the S-AIR receiver, refer to the operating instructions of the S-AIR receiver.

Note

- When you are using another S-AIR sub unit, such as a surround amplifier, do not change the ID of the S-AIR main unit. Set the ID of the S-AIR receiver to the same ID as the S-AIR main unit.
- When you pair the S-AIR main unit and another S-AIR sub unit, such as a surround amplifier, by the pairing operation, you need to perform the pairing operation between the S-AIR main unit and the S-AIR receiver. For details, see "Identifying the S-AIR main unit with a specific S-AIR sub unit (Pairing operation)" (page 77).

2 Select the desired function on the S-AIR receiver.

The function changes in the same sequence as you press FUNCTION (page 41).



3 Adjust the volume on the S-AIR receiver.

Note

- When the sound is other than 2 channel stereo, multi channel sound is downmixed to 2 channel.
- The sound of the S-AIR receiver may be cut off by operation of the S-AIR main unit.
- Sound source is same with both the system and S-AIR receiver.

To control the system from the S-AIR receiver

You can control the system from the S-AIR receiver by using the following buttons.

Press	Operation
	Share the same operations on the remote and control unit.
	
S-AIR CH	Change the function of the system.

For details, refer to the operating instructions of the S-AIR receiver.

Enjoying the S-AIR receiver while the S-AIR main unit is in standby mode

For the S-AIR receiver (not supplied)

You can enjoy the S-AIR receiver while the S-AIR main unit is in standby mode by setting "S-AIR STBY" to "ON".

1 Press SYSTEM MENU.

2 Press \uparrow/\downarrow repeatedly until "S-AIR STBY" appears in the front panel display, then press \oplus or \rightarrow .

3 Press \uparrow/\downarrow to select the desired setting.

- "ON": You can enjoy the S-AIR receiver while the S-AIR main unit is in standby mode or turned on.
- "OFF": You cannot enjoy the S-AIR receiver while the S-AIR main unit is in standby mode.

4 Press \oplus .

The setting is made.

5 Press SYSTEM MENU.

The system menu turns off.

Note

- When you set “S-AIR STBY” to “ON”, the power consumption during the standby mode increases.
- When you turn the system off while “S-AIR STBY” is set to “ON,” “S-AIR” flashes (when sound transmission between the S-AIR main unit and S-AIR receiver is not established), or lights up (when sound transmission between the S-AIR main unit and S-AIR receiver is established) in the front panel display.
- When the wireless transmitter is not inserted in the S-AIR main unit, you cannot set “S-AIR STBY”.
- “S-AIR STBY” is set to “OFF” automatically when the wireless transmitter is removed from the S-AIR main unit.
- When you turn the system off while “S-AIR STBY” is set to “ON”, you cannot use any buttons other than \mathbb{I}/\mathbb{O} button.

Tip

- When there is no disc in the S-AIR main unit and “S-AIR” lights up in the front panel display, you can load a disc into the S-AIR main unit and enjoy music by the S-AIR receiver.

Identifying the S-AIR main unit with a specific S-AIR sub unit (Pairing operation)

For the surround amplifier (supplied)
For the S-AIR receiver (not supplied)

It is easy to set the same ID for the S-AIR main unit and an S-AIR sub unit, such as a surround amplifier or S-AIR receiver, to establish sound transmission. However, neighbours may also receive your system’s sound if IDs are the same, or you may receive the sound from neighbours. To prevent this, you can identify the S-AIR main unit with a specific S-AIR sub unit by performing the pairing operation.

■ Before pairing

Sound transmission is established by the ID (example).

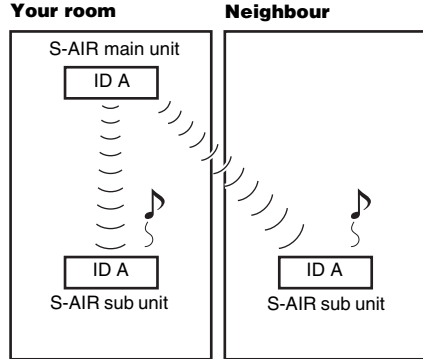

■ After pairing

Sound transmission is established between the paired S-AIR main unit and S-AIR sub unit(s) only.

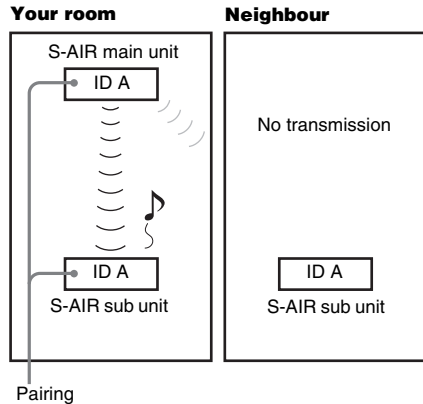

1 Place the S-AIR sub unit that you want to pair near the S-AIR main unit.

Note

- Remove headphones from the surround amplifier (if connected).

2 Match the IDs of the S-AIR main unit and the S-AIR sub unit.

- To set the ID of the S-AIR main unit, see “To set the ID of the S-AIR main unit” (page 75).
- To set the ID of the surround amplifier, see “To set the ID of the surround amplifier” (page 75).
- To set the ID of the S-AIR receiver, refer to the operating instructions of the S-AIR receiver.

3 Press FUNCTION repeatedly until “DVD” appears in the front panel display.

4 Press DISPLAY while the system is in stop mode.

The Control Menu display appears on the TV screen.

5 Press to select [SETUP], then press .

The options for [SETUP] appear.

6 Press to select [CUSTOM], then press .

The Setup Display appears.

7 Press to select [AUDIO SETUP], then press .

The options for [AUDIO SETUP] appear.

8 Press to select [S-AIR SETUP →], then press .

Note

- When the wireless transmitter is not inserted in the S-AIR main unit, [S-AIR SETUP] cannot be selected.

9 Press to select [PAIRING], then press .

The confirmation display appears.

10 Press to select [YES], then press .

The S-AIR main unit starts pairing.
To not perform pairing, select [NO].

11 Start pairing of the S-AIR sub unit.

■ For the surround amplifier

Press POWER on the surround amplifier to turn on the surround amplifier and press PAIRING on the rear panel of the surround amplifier.

The PAIRING indicator of the surround amplifier flashes red when pairing starts. When sound transmission is established, the PAIRING indicator of the surround amplifier turns red and the confirmation display appears.

Tip

- To press PAIRING on the rear panel of the surround amplifier, a slim instrument, such as a paper clip, can be used.

■ For the S-AIR receiver

Refer to the operating instructions of the S-AIR receiver.

When sound transmission is established, the confirmation display appears.

Note

- Perform the pairing within several minutes after step 10. If you do not, the pairing is canceled automatically and the confirmation display appears. To perform pairing, select [YES]. To return to the previous display, select [NO].

12 Press to select the next operation.

■ To finish pairing

Select [NO], then press .

■ To perform pairing of another S-AIR sub unit

Select [YES], then press .

Note

- If you perform the pairing operation between the S-AIR main unit and another S-AIR sub unit (page 77), sound transmission established by ID is canceled.
- When you perform pairing, [(PAIRING)] appears beside ID on the display for selecting ID.

To cancel pairing

Perform the ID setting of the S-AIR main unit according to the procedure of “To set the ID of the S-AIR main unit” (page 75). If you select a new ID (you can select the same ID as before), pairing is canceled.

If sound transmission is unstable

**For the surround amplifier (supplied)
For the S-AIR receiver (not supplied)**

If you use multiple wireless systems which sharing the 2.4 GHz band, such as wireless LAN or Bluetooth, the transmission of S-AIR products or other wireless systems may be unstable. In this case, the transmission may be improved by changing the following “RF CHANGE” setting.

- 1 Press SYSTEM MENU.**
- 2 Press \uparrow/\downarrow repeatedly until “RF CHANGE” appears in the front panel display, then press \oplus or \rightarrow .**
- 3 Press \uparrow/\downarrow to select the desired setting.**
 - “AUTO”: Normally select this. The system change “RF CHANGE” to “ON” or “OFF” automatically.
 - “ON”: The system transmits sound by searching the better channel for transmitting.
 - “OFF”: The system transmits sound by fixing the channel for transmitting.
- 4 Press \oplus .**
The setting is made.
- 5 Press SYSTEM MENU.**
The system menu turns off.
- 6 When you set “RF CHANGE” to “OFF”, select the ID so that sound transmission is most stabilized (page 75).**

Note

- When the wireless transmitter is not inserted in the S-AIR main unit, you cannot set “RF CHANGE”.
- In most cases, you will not need to change this setting.
- If “RF CHANGE” is set to “OFF,” transmission between the S-AIR main unit and S-AIR sub unit can be performed using one of the following channels.
 - S-AIR ID A: equivalent channel for Wi-Fi channel 1
 - S-AIR ID B: equivalent channel for Wi-Fi channel 6
 - S-AIR ID C: equivalent channel for Wi-Fi channel 11
- The transmission may be improved by changing the transmission channel (frequency) of the other wireless system(s). For details, refer to the operating instructions of the other wireless system(s).

Other Operations

Controlling the TV with the Supplied Remote

By adjusting the remote signal, you can control your TV with the supplied remote.

Note

- When you replace the batteries of the remote, the code number may reset itself to the default (SONY) setting. Reset the appropriate code number.

Preparing the remote for controlling the TV

Press and hold TV I/⏻ while entering your TV's manufacturer's code (see the table) using the numeric buttons. Then release TV I/⏻.

If you successfully set the manufacturer's code, the TV button flashes twice slowly. If the setting is unsuccessful, the TV button flashes five times quickly.

Code numbers of controllable TVs

If more than one code number is listed, try entering them one at a time until you find the code that works with your TV.

TV

Manufacturer	Code number
SONY	501 (default)
AIWA	501
AKAI	503
DAEWOO	503, 506, 515, 544
FISHER	508, 545
GENERAL ELECTRIC (GE)	503, 509, 510, 544
GOLDSTAR/LG	503, 515, 517, 544, 568
GRUNDIG	533
HITACHI	503, 514, 515, 517, 544, 557, 571
ITT	521, 522
JVC	516
LOEWE	515
MAGNAVOX	503, 515, 517, 518, 544, 566
MARANTZ	527
MITSUBISHI/MGA	503, 527, 544, 566, 568
NEC	503, 517, 554, 566
NOKIA	521, 522
PANASONIC	509, 553, 572
PHILIPS	515, 518, 557, 570, 571
PIONEER	509, 525, 551
RCA/PROSCAN	503, 510, 544
SABA	530, 537, 547, 549, 558
SAMPO	566
SAMSUNG	503, 515, 517, 544, 557, 566, 569, 574
SANYO	508, 545, 567
SHARP	517, 535, 565
TELEFUNKEN	530, 537, 547, 549, 558
THOMSON	530, 537, 547, 549
TOSHIBA	535, 541, 551
ZENITH	543, 567

CATV

Manufacturer	Code number
SONY	821
HAMLIN/REGAL	836, 837, 838, 839, 840
JERROLD/GI/ MOTOROLA	806, 807, 808, 809, 810, 811, 812, 813, 814
JERROLD	830, 831
OAK	841, 842, 843
PANASONIC	816, 826, 832, 833, 834, 835
PIONEER	828, 829
SCIENTIFIC ATLANTA	815, 816, 817, 844
TOCOM/PHILIPS	830, 831
ZENITH	826, 827

Controlling the TV with the remote

You can control the TV by using following buttons. To use these buttons (other than THEATRE and TV I/⏻), set the remote to the TV mode by pressing TV so that TV button lights up for 1 second.

To exit the TV mode, press TV so that the TV flashes 4 times.

Note

- During the TV mode, if you press any of the following buttons, TV button lights up. (Depending on the manufacturer setting, some buttons may not work and TV button does not light up.)
- When you press other than the following buttons during the remote is in the TV mode, TV button flashes 4 times and the remote exits the TV mode automatically.
- Depending on the TV, you may not be able to control your TV or to use some of the buttons above.
- The TV mode turns off when you do not operate the remote for 10 seconds.

By pressing	You can
TV I/⏻	Turn the TV on or off.
THEATRE	Enjoy optimal image suited for movies.
TV VOL +/-	Adjust the TV volume.
TV CH +/-	Select the TV channel.
Numeric buttons, •, ENTER	Select the TV channel.
TOOLS	Displays the operation menu for the current display.
RETURN	Return to the previous channel or layer on the menu of the TV.
MENU	Display the menu of the TV.
MUTING	Turn off the TV sound temporarily.
⏪/⏩/⏴/⏵, ⊕	Select the item on the menu.
PROG +/-, ⏴/⏵	Select the TV channel. After pressing ⏴, you can select the next (⏴) or previous (⏵) text page.
Number buttons, -/-	Select the TV channel. After pressing ⏴, you can select the text page by entering the three digit page number.
ANALOG	Switch to analogue mode.

By pressing	You can
DIGITAL	Switch to digital mode.
ⓘ / ⓘ	Display the information.
☰	Access Text.
Coloured buttons	Select the options on the menu.
☰	Display the Digital Electronic Programme Guide (EPG).
↶ / ⓘ	Switch the TV's input source between the TV and other input sources in TV mode. After pressing ☰, you can hold the current text page.

Tip

The function of these buttons are same as the remote buttons of the Sony TV. For details, refer to the operating instructions of the TV.

Enjoying Multiplex Broadcast Sound

(DUAL MONO)

You can enjoy multiplex broadcast sound when the system receives or plays the Dolby Digital multiplex broadcast signal.

Note

- To receive the Dolby Digital signal, you need to connect a TV or other components to the control unit with an optical or coaxial digital cord (pages 27, 28) and set the digital output mode of the TV or other components to Dolby Digital.

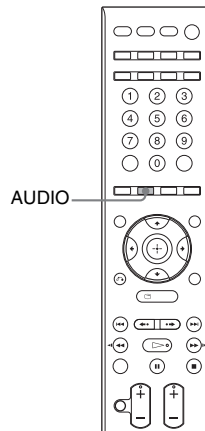

Press AUDIO repeatedly until the desired signal appears in the front panel display.

- “MAIN”: Sound of the main language will be output.
- “SUB”: Sound of the sub language will be output.
- “MAIN+SUB”: Mixed sound of both the main and sub languages will be output.

Changing the Brightness of the Front Panel Display

The brightness of the front panel display can be set to either of 2 levels.

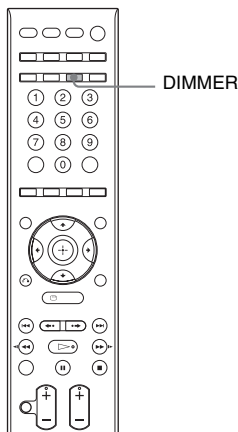

Press DIMMER.

Each time you press DIMMER, the brightness of the front panel display changes.

- “DIMMER OFF”: Bright.
- “DIMMER ON”: The front panel display becomes dark.

Changing the Display Mode

(INFORMATION MODE)

You can change the displayed information in the front panel display.

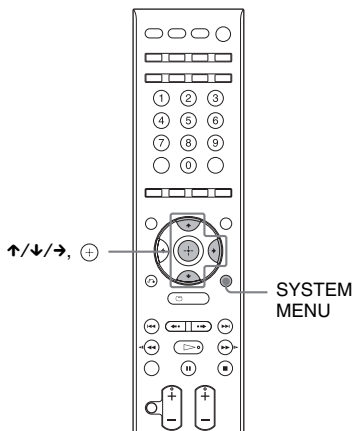

- 1 Press SYSTEM MENU.**
- 2 Press ↑/↓ repeatedly until “INFO MODE” appears in the front panel display, then press ⊕ or →.**
- 3 Press ↑/↓ to select a setting.**
 - “STANDARD”: displays information fully such as the kind of disc, track number, repeat mode information, radio frequency, etc., for the selected function. For details of the displayed information, see “Front Panel Display” (page 117).
 - “SIMPLE”: displays the selected function name only.
- 4 Press ⊕.**

The setting is made.
- 5 Press SYSTEM MENU.**

The system menu turns off.

Changing the Display Appearance of the Soft-touch Buttons

(ILLUMINATION MODE)

You can select the way of displaying the soft-touch buttons located on the top of the control unit.

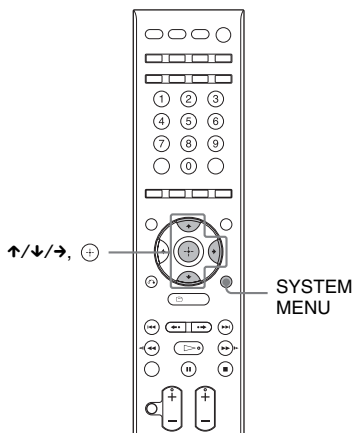

- 1** Press **SYSTEM MENU**.
- 2** Press **↑/↓** repeatedly until “**ILLUM MODE**” appears in the front panel display, then press **+** or **→**.
- 3** Press **↑/↓** to select a setting.
 - “**STANDARD**”: sets the soft-touch buttons lit up always.
 - “**SIMPLE**”: sets the soft-touch buttons lit up when you touch them. To operate the soft-touch buttons, touch them once and light them up. The soft-touch buttons turn off if you do not touch them for about 10 seconds.

- 4** Press **+**.
The setting is made.
- 5** Press **SYSTEM MENU**.
The system menu turns off.

Note

- When the soft-touch buttons turn off in “SIMPLE” mode, first touch the soft-touch button area so that the soft-touch buttons light up, then operate the system with them.

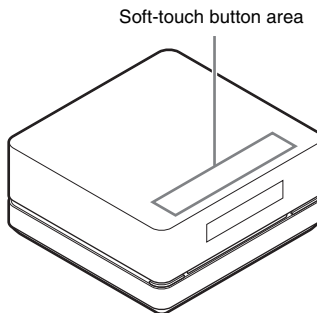

Tip

- Even if “SIMPLE” mode is set, only **▶** on the top of the control unit lights up during playback.

Advanced Settings and Adjustments

Restricting Playback of the Disc

(PARENTAL CONTROL)

DVD-V

Playback of some DVD VIDEOS can be limited according to a predetermined level such as the age of the users. Scenes may be blocked or replaced with different scenes.

You can set the playback restriction by registering a password. When you set the [PARENTAL CONTROL] function to on, you need to enter the password to play restricted discs.

1 Press **FUNCTION** repeatedly until “DVD” appears in the front panel display.

2 Press **DISPLAY** while the system is in stop mode.

The Control Menu display appears on the TV screen.

3 Press **↑/↓** to select **[SETUP]**, then press **+**.

The options for [SETUP] appear.

4 Press **↑/↓** to select **[CUSTOM]**, then press **+**.

The Setup Display appears.

5 Press **↑/↓** to select **[SYSTEM SETUP]**, then press **+**.

The options for [SYSTEM SETUP] appear.

6 Press **↑/↓** to select **[PARENTAL CONTROL →]**, then press **+**.

■ **If you have not entered a password**
The display for registering a new password appears.

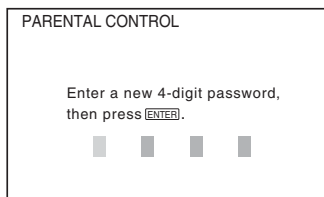

Enter a 4-digit password using the numeric buttons, then press **+**.

The display for confirming the password appears.

■ **When you have already registered a password**

The display for entering the password appears.

7 Enter or re-enter your 4-digit password using the numeric buttons, then press **+**.

The display for setting the playback limitation level appears.

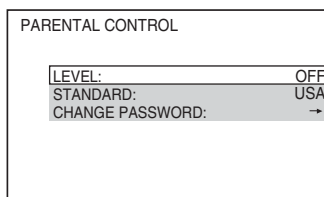

8 Press **↑/↓** to select **[STANDARD]**, then press **+**.

The selection items for [STANDARD] are displayed.

9 Press **↑/↓** to select a geographic area as the playback limitation level, then press **+**.

The area is selected.

When you select [OTHERS →], select and enter a standard code in the table of “Parental Control Area Code List” (page 114) using the numeric buttons.

10 Press \uparrow/\downarrow to select [LEVEL], then press \oplus .

The selection items for [LEVEL] are displayed.

11 Press \uparrow/\downarrow to select the desired level, then press \oplus .

[PARENTAL CONTROL] setting is complete.

The lower the value, the stricter the limitation.

To turn off the [PARENTAL CONTROL] function

Set [LEVEL] to [OFF] in Step 11.

To play a disc for which [PARENTAL CONTROL] is set

1 Load the disc and press \triangleright .

The display for entering your password appears on the TV screen.

2 Enter your 4-digit password using the numeric buttons, then press \oplus .

The system starts playback.

Note

- When you play discs which do not have the [PARENTAL CONTROL] function, playback cannot be limited on this system.
- Depending on the disc, you may be asked to change the parental control level while playing the disc. In this case, enter your password, then change the level. If the Resume Play mode is canceled, the level returns to the previous level.

Tip

- If you forget your password, remove the disc and repeat steps 1 to 7 of “Restricting Playback of the Disc” (page 86). When you are asked to enter your password, enter “199703” using the numeric buttons, then press \oplus . The display will ask you to enter a new 4-digit password. After you enter a new 4-digit password, replace the disc in the control unit and press \triangleright . When the display for entering your password appears on the TV screen, enter your new password.

Changing the password

1 Press FUNCTION repeatedly until “DVD” appears in the front panel display.

2 Press \square DISPLAY while the system is in stop mode.

The Control Menu display appears on the TV screen.

3 Press \uparrow/\downarrow to select  [SETUP], then press \oplus .

The options for [SETUP] appear.

4 Press \uparrow/\downarrow to select [CUSTOM], then press \oplus .

The Setup Display appears.

5 Press \uparrow/\downarrow to select [SYSTEM SETUP], then press \oplus .

The options for [SYSTEM SETUP] appear.

6 Press \uparrow/\downarrow to select [PARENTAL CONTROL \rightarrow], then press \oplus .

The display for entering the password appears.

7 Enter your 4-digit password using the numeric buttons, then press \oplus .

8 Press \uparrow/\downarrow to select [CHANGE PASSWORD \rightarrow], then press \oplus .

9 Enter your 4-digit password using the numeric buttons, then press \oplus .

10 Enter a new 4-digit password using the numeric buttons, then press \oplus .

11 To confirm your password, re-enter it using the numeric buttons, then press \oplus .

If you make a mistake entering your password

Press \leftarrow before you press \oplus , then input the correct number.











Calibrating the Appropriate Settings Automatically

(AUTO CALIBRATION)

D.C.A.C. (Digital Cinema Auto Calibration) can set the appropriate surround sound automatically.

Note

- The system outputs a loud test sound when [AUTO CALIBRATION] starts. You cannot turn the volume down. Give consideration to children and neighbours.
- Make sure that the headphones are not connected to the surround amplifier. You cannot operate the following steps with the headphones connected.
- Before [AUTO CALIBRATION], be sure that the surround amplifier turns on and you install the surround amplifier in the appropriate location. If you install the surround amplifier in an improper location, such as another room, proper measurement will not be obtained.

- 1 Press FUNCTION repeatedly until "DVD" appears in the front panel display.**
- 2 Press  DISPLAY while the system is in stop mode.**
The Control Menu display appears on the TV screen.
- 3 Press  to select  [SETUP], then press .**
The options for [SETUP] appear.
- 4 Press  to select [CUSTOM], then press .**
The Setup Display appears.
- 5 Press  to select [AUDIO SETUP], then press .**
The options for [AUDIO SETUP] appear.
- 6 Press  to select [AUTO CALIBRATION], then press .**
The options for [AUTO CALIBRATION] appear.

- 7 Connect the calibration microphone (supplied) to the ECM-AC2 jack on the rear of the control unit.**

Set up the calibration microphone at the ear level using the tripod, etc. (not supplied). The front of each speaker should face the calibration microphone, and there should be no obstruction between the speakers and the calibration microphone.

Note

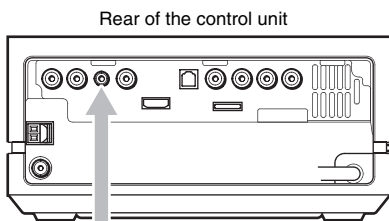

- The ECM-AC2 jack is used for the supplied calibration microphone only. Do not connect other microphones.

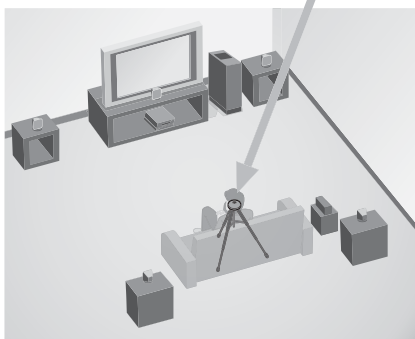

To ECM-AC2 jack

Calibration microphone



- 8 Press  to select [YES].**
- 9 Press .**
[AUTO CALIBRATION] starts.
Be quiet during the measurement.

Note

- Avoid being in the measurement area and making noise during the measurement (about 1 minute), to avoid measurement failure. During the measurement, test signals are output from the speakers.
- The environment of the room in which the system is installed may affect measurements.
- If an error message appears on the TV screen, follow the message, then select [YES].
An error message appears when:
 - the headphones are connected to the surround amplifier.
 - the calibration microphone is not connected.
 - front speakers are not correctly connected.
 - surround speakers are not correctly connected.
 - front and surround speakers are not correctly connected.
 - subwoofer is not connected.

10 Press \leftarrow/\rightarrow to select [YES] or [NO], then press \oplus .

■ The measurement is OK.

Disconnect the calibration microphone, then select [YES]. The result is implemented.

■ The measurement is not OK.

Follow the message, then select [YES] to retry.

Note

- While the Auto Calibration function works:
 - do not turn off the power.
 - do not press any button.
 - do not change the volume.
 - do not change the function.
 - do not insert or eject a disc.
 - do not connect the headphones to the surround amplifier.
 - do not disconnect the calibration microphone.
- When change the surround speakers from wireless connection to wired connection or vice versa, use D.C.A.C. function to adjust the sound setting.

Tip

- You can check the distance between the listening position and each speaker. See page 96.

About error messages for the auto calibration

If the following message appears during [AUTO CALIBRATION], check “Symptoms and remedies” and retry the auto calibration.

Error message	Symptoms and remedies
[Check calibration mic connection.]	No channel sound can be detected. Check that the calibration microphone is connected properly. If the calibration microphone is connected properly, the calibration microphone or calibration microphone cord may be damaged.
[Mic input level overloaded.]	The calibration microphone or system may be damaged. Contact your Sony dealer or local authorized Sony service facility.
[Check front speaker connection.]	Front speakers are not connected. Check that the front speakers are connected properly (page 23).
[Check surround speaker connection.]	Only one surround speaker is connected. Check that the surround speakers are connected properly (page 23).
[Check front and surround speaker connection.]	Front speakers are not connected and only one surround speaker is connected. Check that the speakers are connected properly (page 23).
[Check subwoofer connection.]	Contact your Sony dealer or local authorized Sony service facility.



Using the Setup Display

You can make various adjustments for items such as picture and sound.

Displayed items differ depending on the country model.

Note

- Playback settings stored in the disc take priority over the Setup Display settings and not all the functions described may work.

- 1 Press FUNCTION repeatedly until "DVD" appears in the front panel display.**
- 2 Press  DISPLAY when the system is in stop mode.**
The Control Menu display appears on the TV screen.
- 3 Press \uparrow/\downarrow to select  [SETUP], then press \oplus .**
The options for [SETUP] appear.
- 4 Press \uparrow/\downarrow to select [CUSTOM], then press \oplus .**
The Setup Display appears.
- 5 Press \uparrow/\downarrow to select the setup item, then press \oplus .**
 - [LANGUAGE SETUP] (page 91)
 - [VIDEO SETUP] (page 91)
 - [HDMI SETUP] (page 93)
 - [AUDIO SETUP] (page 94)
 - [SYSTEM SETUP] (page 95)
 - [SPEAKER SETUP] (page 96)

Example: [VIDEO SETUP]

Selected item

VIDEO SETUP	
TV TYPE:	16:9
PROGRESSIVE (COMPONENT OUT):	OFF
4:3 OUTPUT:	FULL
PAUSE MODE:	AUTO

Setup items

- 6 Press \uparrow/\downarrow to select an item, then press \oplus .**

The options for the selected item appear.
Example: [TV TYPE]

VIDEO SETUP	
TV TYPE:	16:9
PROGRESSIVE (COMPONENT OUT):	16:9
4:3 OUTPUT:	4:3 LETTER BOX
PAUSE MODE:	4:3 PAN SCAN

Options

- 7 Press \uparrow/\downarrow to select a setting, then press \oplus .**

The setting is selected and setup is complete.

Example: [4:3 LETTER BOX]

VIDEO SETUP	
TV TYPE:	4:3 LETTER BOX
PROGRESSIVE (COMPONENT OUT):	OFF
4:3 OUTPUT:	FULL
PAUSE MODE:	AUTO

Selected setting

Setting the Display or Sound Track Language

[LANGUAGE SETUP]

Set various languages for the on-screen display or sound track.

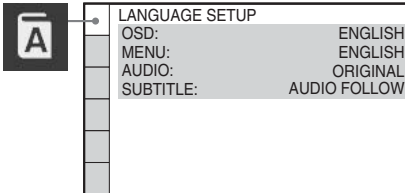

■ [OSD] (On-Screen Display)

You can switch the display language on the TV screen.

■ [MENU] (DVD VIDEO only)

You can switch the language for the disc's menu.

■ [AUDIO] (DVD VIDEO only)

You can switch the language of the sound track. When you select [ORIGINAL], the language given priority in the disc is selected.

■ [SUBTITLE] (DVD VIDEO only)

You can switch the language of the subtitle recorded on the DVD VIDEO. When you select [AUDIO FOLLOW], the language for the subtitles changes according to the language you selected for the sound track.

Note

- When you select a language in [MENU], [AUDIO], or [SUBTITLE] that is not recorded on the DVD VIDEO, one of the recorded languages will be automatically selected (depending on the disc, the language may not be selected automatically).

Tip

- If you select [OTHERS →] in [MENU], [AUDIO], and [SUBTITLE], select and enter a language code from "Language Code List" (page 114) using the numeric buttons.

Settings for the Display

[VIDEO SETUP]

Select settings according to the TV to be connected.

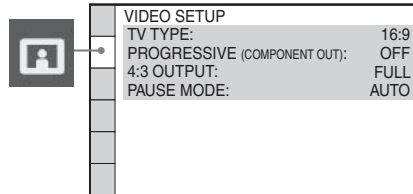

■ [TV TYPE]

You can select the aspect ratio of the connected TV.

[16:9]

Select this when you connect a wide-screen TV or a TV with a wide mode function.



[4:3 LETTER BOX]

Select this when you connect a 4:3 screen TV. Displays a wide picture with bands on the upper and lower portions of the screen.



[4:3 PAN SCAN]

Select this when you connect a 4:3 screen TV. The system automatically displays the wide picture on the entire screen and cuts off the portions that do not fit.

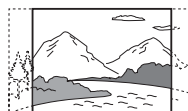

Note

- Depending on the DVD, [4:3 LETTER BOX] may be selected automatically instead of [4:3 PAN SCAN] or vice versa.

■ [PROGRESSIVE (COMPONENT OUT)]

You can set the progressive signal that is output from the COMPONENT VIDEO OUT jacks to on/off. For details, see “Does your TV accept progressive signals?” (page 37).

[ON]	The system outputs interlace signals.
-------------	---------------------------------------

[OFF]	The system outputs progressive signals. When you select [ON], follow the steps below.
--------------	---

- 1 Select [ON], then press**  .
The confirmation display appears.
- 2 Press </> to select [START].**
The system outputs the progressive signal for 5 seconds. Check that the screen is displayed correctly.
- 3 Press </> to select [YES].**
The system outputs the progressive signal. If you select [NO], the system will not output the progressive signal.

Note

- [PROGRESSIVE (COMPONENT OUT)] is effective only when you connect the control unit and TV with a component video cord (page 27).

■ [4:3 OUTPUT]

When you use a 16:9 aspect ratio TV, you can adjust the aspect ratio to watch 4:3 aspect ratio signals. If you can change the aspect ratio on your TV, change the setting on your TV, not the system.

[FULL]	Select this when you can change the aspect ratio on your TV.
---------------	--

[NORMAL]	Select this when you cannot change the aspect ratio on your TV. A 16:9 aspect ratio signal with black bands on left and right sides of the image appears.
-----------------	---

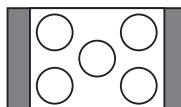

16:9 aspect ratio TV

Note

- [4:3 OUTPUT] is effective only when you set [TV TYPE] in [VIDEO SETUP] to [16:9].

■ [PAUSE MODE] (DVD VIDEO/DVD-R/DVD-RW only)

You can select the picture in pause mode.

[AUTO]	The picture, including subjects that move dynamically, is output with no jitter.
---------------	--

[FRAME]	The picture, including subjects that do not move dynamically, is output in high resolution.
----------------	---

Settings for the HDMI

[HDMI SETUP]

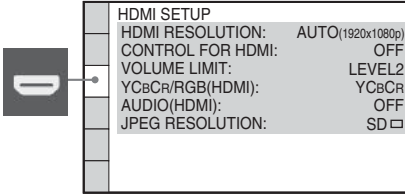

■ [HDMI RESOLUTION]

You can select the type of video signal that is output from the HDMI OUT jack. For details, see “To select the type of video signal output from the HDMI OUT jack” (page 36).

[AUTO(1920x1080p)]	The system outputs the optimal video signal for the connected TV.
[1920x1080i]	The system outputs 1920 × 1080i* video signals.
[1280x720p]	The system outputs 1280 × 720p* video signals.
[720x480/576p]	The system outputs 720 × 480p* or 720 × 576p* video signals.

* i: interlace, p: progressive

** Depending on the country model, [720 × 480p] may appear.

■ [CONTROL FOR HDMI]

You can set the [CONTROL FOR HDMI] function to on/off. This function is available when you connect the system and TV with an HDMI cable. For details, see “Using the Control for HDMI Function for “BRAVIA” Sync” (page 70).

[OFF]	Off.
[ON]	On. You can operate mutually between components that are connected with an HDMI cable.

Note

- When you set to [ON] without the HDMI connection of the TV, [Please verify the HDMI connection.] appears and you cannot set to [ON].

■ [VOLUME LIMIT]

If you change the output method of the TV to the system speaker on the TV menu or by pressing THEATRE, the System Audio Control (page 72) is activated and loud sound may be output depending on the volume level of the system. You can prevent this by limiting the maximum level of the volume.

[LEVEL3]	Maximum volume level is set to 15.
[LEVEL2]	Maximum volume level is set to 20.
[LEVEL1]	Maximum volume level is set to 30.
[OFF]	Off.

Note

- This function is available only when [CONTROL FOR HDMI] is set to [ON].

■ [YCbCr/RGB (HDMI)]

You can select the type of HDMI signal output from HDMI OUT jack.

[YCbCr]	The system outputs YCbCr signals.
[RGB]	The system outputs RGB signals.

Note

- If the playback picture becomes distorted, set [YCbCr] to [RGB].
- If the HDMI OUT jack is connected to a component with a DVI jack, [RGB] signals will be automatically output even when you select [YCbCr].

■ [AUDIO (HDMI)]

You can select the audio output status from the HDMI OUT jack.

[OFF]	The system does not output the sound from the HDMI OUT jack.
[ON]	The system outputs audio signals by converting Dolby Digital, DTS, or 96 kHz/24 bit PCM signals to 48 kHz/16 bit PCM.

Note

- When you connect the control unit and TV with an HDMI cable and [ON] is selected, [AUDIO DRC], “A/V SYNC”, TONE, “DEC. MODE”, and sound mode are not applied to the sound that is output from the TV.
- When you set the function to other than “DVD”, the system does not output the sound from the HDMI OUT jack even if you set [AUDIO (HDMI)] to [ON].

■ [JPEG RESOLUTION]

You can select the resolution of JPEG image files output from the HDMI OUT jack.

[SD <input]]<="" td="" type="checkbox"/> <td>The system outputs standard resolution with a black frame.</td>	The system outputs standard resolution with a black frame.
[HD <input]]<="" td="" type="checkbox"/> <td>The system outputs HD resolution with a black frame.</td>	The system outputs HD resolution with a black frame.
[HD]	The system outputs the HD resolution without a black frame.
[(1920×1080i)HD <input]]<="" td="" type="checkbox"/> <td>The system outputs full size HD resolution with a black frame.</td>	The system outputs full size HD resolution with a black frame.
[(1920×1080i)HD]	The system outputs full size HD resolution without a black frame.

Note

- [JPEG RESOLUTION] is effective only when you set [TV TYPE] in [VIDEO SETUP] to [16:9], and you set [HDMI RESOLUTION] in [HDMI SETUP] to other than [720×480/576p].

- You can select [(1920×1080i)HD - If you select [(1920×1080i)HD - HDMI signal will stop momentarily when the system is loading or unloading a DATA CD or DATA DVD disc.

Settings for the Audio

[AUDIO SETUP]

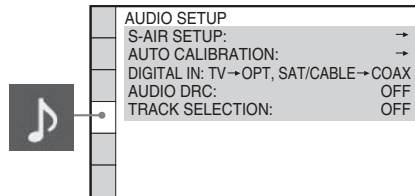

■ [S-AIR SETUP]

You can set up the S-AIR setting. For details, see “Using an S-AIR Product” (page 74).

[ID]	You can set the ID of the S-AIR main unit.
[PAIRING]	You can pair the system and S-AIR sub unit, such as surround amplifier or S-AIR receiver.

Note

- This function is available only when the S-AIR transmitter is inserted into the S-AIR main unit.

■ [AUTO CALIBRATION]

You can calibrate the appropriate settings automatically. For details, see “Calibrating the Appropriate Settings Automatically” (page 88).

■ [DIGITAL IN]

You can assign a digital sound input corresponding with the function “TV” and “SAT/CABLE.”

[TV → OPT, SAT/CABLE → COAX] Optical audio input signals are assigned to “TV” function, coaxial audio input signals are assigned to “SAT/CABLE” function.

[TV → COAX, SAT/CABLE → OPT] Coaxial audio input signals are assigned to “TV” function, optical audio input signals are assigned to “SAT/CABLE” function.

■ [AUDIO DRC] (DVD VIDEO only)

You can compress the dynamic range of the sound track. [AUDIO DRC] is useful for watching movies at low volume late at night.

[OFF] No compression of dynamic range.

[STANDARD] The system reproduces the sound track with the kind of dynamic range that the recording engineer intended.

[MAX] The system compresses dynamic range fully.

Note

- [AUDIO DRC] works only for Dolby Digital.

■ [TRACK SELECTION] (DVD VIDEO only)

You can give the sound track which contains the highest number of channels priority when you play a DVD VIDEO on which multiple audio formats (PCM, DTS, Dolby Digital, or MPEG audio) are recorded.

[OFF] Off.

[AUTO] The system selects the sound track automatically according to the priority.

Note

- When you set the item to [AUTO], the language may change. The [TRACK SELECTION] setting has higher priority than the [AUDIO] settings in [LANGUAGE SETUP] (page 91). (Depending on the disc, this function may not work.)
- If PCM, DTS, Dolby Digital sound, and MPEG audio have the same number of channels, the system selects PCM, DTS, Dolby Digital sound, and MPEG audio in this order.

Other Settings

[SYSTEM SETUP]

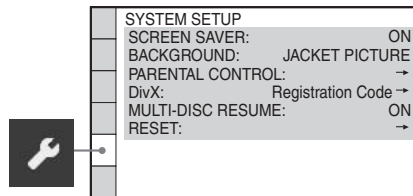

■ [SCREEN SAVER]

You can reduce the display device damages (ghosting). Press any button (e.g., ▷ button) to cancel the screen saver.

[ON] The screen saver image appears when you leave the system in pause or stop mode for about 15 minutes, or when you play back a CD, DATA CD (MP3 file), or DATA DVD (MP3 file) for more than 15 minutes.

[OFF] Off.

■ [BACKGROUND]

You can select the background colour or picture on the TV screen in stop mode or while playing a CD, DATA CD (MP3 file), or DATA DVD (MP3 file).

[JACKET PICTURE]

The jacket picture (still picture) appears, but only when the jacket picture is already recorded on the disc (CD-EXTRA, etc.). If the disc does not contain a jacket picture, the [GRAPHICS] picture appears.

[GRAPHICS]

A preset picture stored in the system appears.

[BLUE]

The background is blue.

[BLACK]

The background is black.

■ [PARENTAL CONTROL]

You can set the playback restrictions. For details, see “Restricting Playback of the Disc” (page 86).

■ [DivX]

You can display the registration code for this system. For more information, go to <http://www.divx.com> on the Internet.

■ [MULTI-DISC RESUME] (DVD VIDEO/VIDEO CD only)

You can set the [MULTI-DISC RESUME] function to on or off.

[ON]

The system stores the resume points in memory for up to 10 discs.

[OFF]

The system does not store the resume points in memory. Playback restarts at the resume point only for the current disc in the system.

■ [RESET]

You can return the [SETUP] settings other than [PARENTAL CONTROL] to the default settings. For details, see “Returning the [SETUP] settings to the default” (page 99).

Settings for the Speakers

[SPEAKER SETUP]

To obtain the best possible surround sound, set connection of the speakers and their distance from your listening position. Then use the test tone to adjust the level and the balance of the speakers to the same level.

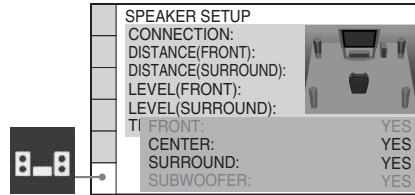

■ [CONNECTION]

If you do not connect center or surround speakers, set the parameters for [CENTER] and [SURROUND]. Since the front speaker and subwoofer setting is fixed, you cannot change them.

[FRONT] [YES]

[CENTER] [YES]: Normally select this.
[NONE]: Select this if no center speaker is used.

[SURROUND] [YES]: Normally select this.
[NONE]: Select this if no surround speaker is used.

[SUBWOOFER] [YES]

■ [DISTANCE (FRONT)]

When you move the front speakers and center speaker, be sure to set the parameters of the distance (A) from the listening position to the speakers.

You can set the parameters from 0.0 to 7.0 meters for the center speaker.

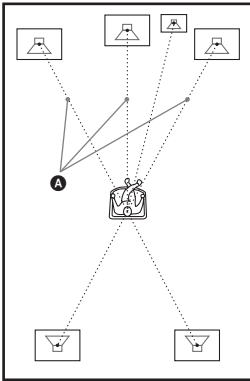

■ [DISTANCE (SURROUND)]

When you move the surround speakers, be sure to set the parameters of the distance (B) from the listening position to the speakers.

You can set the parameters from 0.0 to 7.0 meters.

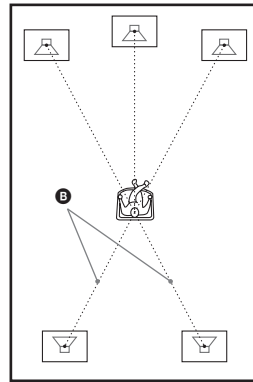

[L/R] 3.0 m¹⁾	Set the front speaker distance.
[CENTER] 3.0 m¹⁾²⁾	Set the center speaker distance.
[SUBWOOFER] 3.0 m¹⁾	Set the subwoofer distance.

- 1) When you perform the Quick Setup (page 34), the default settings are changed.
- 2) This item appears when you set [CENTER] to [YES] in the [CONNECTION] setting.

[L/R] 3.0 m³⁾⁴⁾	Set the surround speaker distance.
---	------------------------------------

- 3) When you perform the Quick Setup (page 34), the default settings are changed.
- 4) This item appears when you set [SURROUND] to [YES] in the [CONNECTION] setting.

Note

- Depending on the input stream, the [DISTANCE] setting may not be effective.
- If all front and surround speakers are not placed at an equal distance from your listening position, set the distance according to the closest speaker.
- Do not place the surround speakers farther away from your listening position than the front speakers.
- When the speaker distance setting is not in the recommended range, $\triangle \uparrow / \triangle \downarrow **$ m is displayed (** being the number). $\triangle \uparrow$ indicates over the recommended distance. $\triangle \downarrow$ indicates below the recommended distance.

■ [LEVEL (FRONT)]

You can adjust the sound level of the front speakers, center speaker, and subwoofer. Be sure to set [TEST TONE] to [ON] for easy adjustment.

[L/R] 0.0 dB	Set the front speaker level between -6.0 dB and +6.0 dB.
[CENTER] 0.0 dB⁵⁾	Set the center speaker level between -6.0 dB and +6.0 dB.
[SUBWOOFER] 0.0 dB	Set the subwoofer level between -6.0 dB and +6.0 dB.

⁵⁾ This item appears when you set [CENTER] to [YES] in the [CONNECTION] setting.

■ [LEVEL (SURROUND)]

You can adjust the sound level of the surround speakers. Be sure to set [TEST TONE] to [ON] for easy adjustment.

[L/R] 0.0 dB⁶⁾	Set the surround speaker level between -6.0 dB and +6.0 dB.
--------------------------------------	---

⁶⁾ This item appears when you set [SURROUND] to [YES] in the [CONNECTION] setting.

■ [TEST TONE]

The speakers will emit a test tone to adjust [LEVEL (FRONT)] and [LEVEL (SURROUND)].

[OFF]	The test tone is not emitted from the speakers.
[ON]	The test tone is emitted from each speaker in sequence while adjusting level. When you select one of the [SPEAKER SETUP] items, the test tone is emitted from each speaker in sequence.

Adjusting the speaker level by using the test tone

1 Press  **DISPLAY** when the system is in stop mode.

The Control Menu display appears.

2 Press \uparrow/\downarrow to select  [SETUP], then press \oplus .

The options for [SETUP] appear.

3 Press \uparrow/\downarrow to select [CUSTOM], then press \oplus .

The Setup Display appears.

4 Press \uparrow/\downarrow repeatedly to select [SPEAKER SETUP], then press \oplus or \rightarrow .

5 Press \uparrow/\downarrow repeatedly to select [TEST TONE], then press \oplus or \rightarrow .

6 Press \uparrow/\downarrow repeatedly to select [ON], then press \oplus .

You will hear the test tone from each speaker in sequence.

7 Press $\leftarrow/\uparrow/\downarrow/\rightarrow$ to adjust the value of [LEVEL (FRONT)] or [LEVEL (SURROUND)].

The test tone is emitted from only the speaker which you are adjusting.

8 Press \oplus when you have finished making adjustments.

9 Press \uparrow/\downarrow repeatedly to select [TEST TONE], then press \oplus .

10 Press \uparrow/\downarrow repeatedly to select [OFF], then press \oplus .

Note

- The test tone signals are not output from the HDMI OUT jack.

Tip

- To adjust the volume of all the speakers at one time, press VOLUME +/-.
- To return to the default setting when changing a setting, select the item, then press CLEAR. Note that only the [CONNECTION] setting does not return to the default setting.

Returning to the Default Settings

Returning the system parameters, such as preset stations, to the default settings

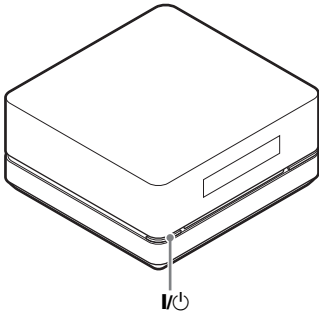

- 1 Turn off the power.**
- 2 Press and hold I/O on the control unit about 5 seconds.**

“MEMORY CLR” and “PUSH POWER” appear alternately in the front panel display about 10 seconds.
- 3 Press I/O.**

“CLEARING” appears in the front panel display and the default settings are returned. After “CLEARED!” appears, the system is turned off.

Note

- In step 3, if you do not press I/O or press any buttons other than I/O on the control unit, the system turns on. The setting is not made.
- When you turn on the system after returning to the default settings, wait about 20 seconds before turning on the power by pressing I/O.

Returning the [SETUP] settings to the default

- 1 Press FUNCTION repeatedly until “DVD” appears in the front panel display.**
- 2 Press DISPLAY when the system is in stop mode.**

The Control Menu display appears on the TV screen.
- 3 Press \uparrow/\downarrow to select [SETUP], then press \oplus .**

The options for [SETUP] appear.
- 4 Press \uparrow/\downarrow to select [CUSTOM], then press \oplus .**

The Setup Display appears.
- 5 Press \uparrow/\downarrow to select [SYSTEM SETUP], then press \oplus .**

The options for [SYSTEM SETUP] appear.
- 6 Press \uparrow/\downarrow to select [RESET], then press \oplus .**
- 7 Press \leftarrow/\rightarrow to select [YES].**

You can also quit the process and return to the Control Menu display by selecting [NO] here.
- 8 Press \oplus .**

Do not press I/O while resetting the system as it takes a few seconds to complete.

Note

- When you turn the system on after resetting and no disc is in the control unit, the guide message appears on the TV screen. To perform the Quick Setup (page 34), press \oplus , to return to normal screen, press CLEAR.
- The [MODE (MUSIC, IMAGE)], [INTERVAL] and [EFFECT] settings are also return to the default settings.

Precautions

On power sources

- Unplug the subwoofer from the wall outlet (mains) if you do not intend to use it for an extended period of time. To disconnect the cord, pull it out by the plug, never by the cord.

On placement

- Place the system in a location with adequate ventilation to prevent heat build-up in the system.
- At high volume, over long periods of time, the cabinet becomes hot to touch. This is not a malfunction. However, touching the cabinet should be avoided. Do not place the control unit in a confined space where ventilation is poor as this may cause overheating.
- Do not block the ventilation slots by putting anything on the system. The system is equipped with a high power amplifier. If the ventilation slots are blocked, the control unit can overheat and malfunction.
- Do not place the control unit on surfaces (rugs, blankets, etc.) or near materials (curtains, draperies) that may block the ventilation slots.
- Do not install the control unit near heat sources such as radiators, or air ducts, or in a place subject to direct sunlight, excessive dust, mechanical vibration, or shock.
- Do not install the control unit in an inclined position. It is designed to be operated in a horizontal position only.
- Keep the control unit and discs away from component with strong magnets, such as microwave ovens, or large loudspeakers.
- Do not place anything on the control unit and the subwoofer.
- If you use more than one set of S-AIR products, position them away from each other to avoid cross talk.
- Install this surround amplifier and S-AIR products at least 50 cm away from people.
- If you use more than one surround amplifier, do not place one on top of the other.

On operation

- If the system is brought directly from a cold to a warm location, or is placed in a very damp room, moisture may condense on the lenses inside the control unit. Should this occur, the system may not operate properly. In this case, remove the disc and leave the system turned on for about half an hour until the moisture evaporates.
- When you move the system, take out any disc. If you don't, the disc may be damaged.
- If anything falls into the cabinet, unplug the subwoofer and have it checked by qualified personnel before operating it any further.

On adjusting volume

- Do not turn up the volume while listening to a section with very low level inputs or no audio signals. If you do, the speakers may be damaged when a peak level section is suddenly played.

On cleaning

- Clean the cabinet, panel, and controls with a soft cloth slightly moistened with a mild detergent solution. Do not use any type of abrasive pad, scouring powder or solvent such as alcohol or benzene. If you have any questions or problems concerning your system, please consult your nearest Sony dealer.
- Clean the cabinets of the surround amplifier only with a soft dry cloth. Do not use any type of abrasive pad, scouring powder or solvent such as alcohol or benzene.

On cleaning discs, disc/lens cleaners

- Do not use cleaning discs or disc/lens cleaners (including wet or spray types). These may cause the apparatus to malfunction.

On your TV's colour

- If the speakers should cause the TV screen to have colour irregularity, turn off the TV then turn it on after 15 to 30 minutes. If colour irregularity should persist, place the speakers further away from the TV set.

IMPORTANT NOTICE

Caution: This system is capable of holding a still video image or on-screen display image on your television screen indefinitely. If you leave the still video image or on-screen display image displayed on your TV for an extended period of time you risk permanent damage to your television screen.

Projection televisions are especially susceptible to this.

The nameplate is located on the bottom exterior of the control unit.

On moving the system

When you carry the system, use the following procedure to protect the inner mechanism.

1 Press ▲ to remove a disc.

Make sure that the disc is removed from the control unit.

2 Press I/⏻ to turn off the power.

3 Remove the AC power cord (mains lead) from the wall outlet (mains).

About S-AIR function

- As the S-AIR function transmits sound by radio waves, sound may skip when radio waves are obstructed. This is a characteristic of radio waves and is not malfunction.
- As the S-AIR function transmits sound by radio waves, equipment that generates electromagnetic energy, such as a microwave oven, may interfere with sound transmission.
- As the S-AIR function uses the radio waves that share the same frequency as other wireless systems, such as wireless LAN or Bluetooth, interference or poor transmission may result. In this case, take the following steps:
 - Do not install the system near other wireless systems.
 - Do not use the system and the other wireless systems at the same time.
- The transmission distance differs depending on the usage environment. Find a location where transmission between the S-AIR main unit and S-AIR sub unit is most effective, and install the S-AIR main unit and S-AIR sub unit there.

About the surround amplifier

- The nameplate is located on the side exterior.

Notes about the Discs

On handling discs

- To keep the disc clean, handle the disc by its edge. Do not touch the surface.
- Do not stick paper or tape on the disc.



- Do not expose the disc to direct sunlight or heat sources such as hot air ducts, or leave it in a car parked in direct sunlight as the temperature may rise considerably inside the car.
- After playing, store the disc in its case.

On cleaning

- Before playing, clean the disc with a cleaning cloth.
- Wipe the disc from the center out.



- Do not use solvents such as benzine, thinner, commercially available cleaners, or anti-static spray intended for vinyl LPs.

This system can only play back a standard circular disc. Using neither standard nor circular discs (e.g., card, heart, or star shape) may cause a malfunction.

Do not use a disc that has a commercially available accessory attached, such as a label or ring.

Troubleshooting

If you experience any of the following difficulties while using the system, use this troubleshooting guide to help remedy the problem before requesting repairs. Should any problem persist, consult your nearest Sony dealer.

Note that if service personnel changes some parts during repair, these parts may be retained.

In the event of a problem with S-AIR function, have a Sony dealer check the entire system together (S-AIR main unit (control unit and subwoofer) and S-AIR sub unit).

Power

Symptom	Remedy
The power is not turned on.	<ul style="list-style-type: none">• Check that the AC power cord (mains lead) is connected securely.• Press I/⏻ after “STANDBY” disappear from the front panel display.• After connecting the AC power cord (mains lead), wait about 20 seconds before turning on the power by pressing I/⏻.
If “PROTECTOR” and “PUSH POWER” appear alternately in the front panel display.	<p>Press I/⏻ to turn off the system, and check the following items after “STANDBY” disappears.</p> <ul style="list-style-type: none">• Are the ⊕ and ⊖ speaker cords short-circuited?• Are you using only the specified speakers?• Is anything blocking the ventilation slots of the system? <p>Check the above items and fix any problems. After “STANDBY” disappears, wait about 20 seconds before turning on the power by pressing I/⏻. If the cause of the problem cannot be found even after checking all the above items, consult your nearest Sony dealer.</p>

Picture

Symptom	Remedy
There is no picture.	<ul style="list-style-type: none">• The video connecting cords are not connected securely.• The video connecting cords are damaged.• The control unit is not connected to the correct TV input jack (page 26).• The video input on the TV is not set so that you can view pictures from the system.• Check the output method on your system (page 36).• You have set progressive format but your TV cannot accept the signal in progressive format. In this case, return the setting to interlace format (the default setting) (page 37).• Even if your TV is compatible with progressive format (525p) signals, the image may be affected when you set progressive format. In this case, return the setting to interlace format (the default setting) (page 37).• Re-connect the connecting cord securely.• The control unit is connected to an input device that is not HDCP (high-bandwidth digital content protection) compliant ("HDMI" on the front panel display does not light up).• If the HDMI OUT jack is used for video output, change the type of video signal output from the HDMI OUT jack. It may solve the problem (page 36). Connect the TV and the control unit using a video jack other than the HDMI OUT, and switch the TV's input to the connected video input so that you can see the on-screen displays. Change the type of video signal output from the HDMI OUT jack, and switch the TV's input back to HDMI. If the picture still does not appear, repeat the steps and try other options.
Picture noise appears.	<ul style="list-style-type: none">• The disc is dirty or flawed.• If the picture output from your system goes through your VCR to get to your TV, the copy-protection signal applied to some DVD programs could affect picture quality. If you still experience problems even when you connect your control unit directly to your TV, try connecting your control unit to your TV's video input (except for the HDMI jack) (page 26).
Even though you set the aspect ratio in [TV TYPE] of [VIDEO SETUP], the picture does not fill the TV screen.	<ul style="list-style-type: none">• The aspect ratio on the disc is fixed.
Colour irregularity occurs on the TV screen.	<p>The subwoofer and the front speakers in this system are magnetically shielded to prevent magnetic leakage. However, some leakage may occur, as a high-strength magnet is employed. If this happens, check the following items:</p> <ul style="list-style-type: none">• If the speakers are used with a CRT-based TV or projector, install the speakers at least 0.3 m from the TV set.• If the colour irregularity persists, turn off the TV set once, then turn it on after 15 to 30 minutes.• If howling occurs, reposition the speakers further away from the TV set.• Make sure that no magnetic object (magnetic latch on a TV stand, health care device, toy, etc.) is placed near the speakers.

Sound

Symptom	Remedy
There is no sound.	<ul style="list-style-type: none">• The speaker cord is not connected securely.• Press MUTING on the remote if “MUTING” is displayed on the front panel display.• The system is in pause mode or in Slow-motion Play mode. Press ▷ to return to normal play mode.• Fast forward or fast reverse is performed. Press ▷ to return to normal play mode.• Check the speaker settings (page 96).• The component connected to the HDMI OUT jack does not conform to the audio signal format, in this case set [AUDIO (HDMI)] in [HDMI SETUP] to [ON] (page 94).
No sound is output from the HDMI OUT jack.	<ul style="list-style-type: none">• Set [AUDIO (HDMI)] in [HDMI SETUP] to [ON] (page 94).• The HDMI OUT jack is connected to a DVI (Digital Visual Interface) device (DVI (Digital Visual Interface) jacks do not accept audio signals).• Try the following: ① Turn the system off and on again. ② Turn the connected component off and on again. ③ Disconnect and then connect the HDMI cable again.
The left and right sounds are unbalanced or reversed.	<ul style="list-style-type: none">• Check that the speakers and components are connected correctly and securely.• Perform [AUTO CALIBRATION] (page 88).
Severe hum or noise is heard.	<ul style="list-style-type: none">• Check that the speakers and components are connected securely.• Check that the connecting cords are away from a transformer or motor, and at least 3 meters away from your TV set or a fluorescent light.• Move your TV away from the audio components.• The plugs and jacks are dirty. Wipe them with a cloth slightly moistened with alcohol.• Clean the disc.
The sound loses stereo effect when you play a VIDEO CD, a CD, or an MP3 file.	<ul style="list-style-type: none">• Set “AUDIO” to “STEREO” by pressing AUDIO (page 50).• Make sure the control unit is connected properly.
The surround effect is difficult to hear when you are playing a Dolby Digital, DTS, or MPEG audio.	<ul style="list-style-type: none">• Check the “DEC. MODE” setting (page 63).• Check the speaker connections and settings (pages 23, 96).• Depending on the DVD, the output signal may not be the entire 5.1 channel. It may be monaural or stereo even if the sound track is recorded in Dolby Digital or MPEG audio format.
The sound comes from the center speaker only.	<ul style="list-style-type: none">• Check the speaker connections.• Depending on the disc, the sound may come from the center speaker only.
No sound is heard from the center speaker.	<ul style="list-style-type: none">• Check the speaker connections and settings (pages 23, 96).• Check the “DEC. MODE” setting (page 63).• Depending on the source, the effect of the center speaker may be less noticeable.• A 2 channel source is being played.

Symptom	Remedy
No sound or only a very low-level sound is heard from the surround speakers.	<ul style="list-style-type: none"> • Check the speaker connections and settings (pages 23, 96). • Check the “DEC. MODE” setting (page 63). • Depending on the source, the effect of the surround speakers may be less noticeable. • Wireless setting of the speaker is not correct. • A 2 channel source is being played.
The beginning of the sound is cut off.	<ul style="list-style-type: none"> • Set the Sound mode to other than “AUTO” (page 65). • Set the decoding mode to other than “A.F.D. MULTI” (page 63).
No sound is heard or sound is cut off.	<ul style="list-style-type: none"> • The S-AIR main unit and/or the surround amplifier is installed in a place such as on a metal shelf. • Wireless LANs, a microwave (oven) and Bluetooth applications, etc. are placed near the surround amplifier. • Move away the other components from the surround amplifier or turn off the other components.

Operation

Symptom	Remedy
Radio stations cannot be tuned in.	<ul style="list-style-type: none"> • Check that the antenna (aerial) is connected securely. Adjust the antenna (aerial) or connect an external antenna (aerial) if necessary. • The signal strength of the stations is too weak (when tuning in with automatic tuning). Use direct tuning. • No stations have been preset or the preset stations have been cleared (when tuning by scanning preset stations). Preset the stations (page 67). • Press DISPLAY so that the frequency appears in the front panel display.
The remote does not function.	<ul style="list-style-type: none"> • There are obstacles between the remote and the control unit. • The distance between the remote and the control unit is too far. • The remote is not pointed at the remote sensor on the control unit. • The batteries in the remote are weak.
A disc does not play.	<ul style="list-style-type: none"> • There is no disc inserted. • The disc is upside down. Insert the disc with the playback side facing down. • The system cannot play CD-ROMs, etc. (page 7). • The region code on the DVD does not match the system. • Moisture has condensed inside the control unit and may cause damage to the lenses. Remove the disc and leave the control unit turned on for about half an hour. • The disc is not written properly. • The disc is dirty or flawed.

Symptom	Remedy
The MP3 file cannot be played.	<ul style="list-style-type: none"> • The DATA CD is not recorded in an MP3 format that conforms to ISO 9660 Level 1/Level 2, or Joliet. • The DATA DVD is not recorded in an MP3 format that conforms to UDF (Universal Disk Format). • The MP3 file does not have the extension “.MP3”. • The data is not formatted in MP3 even though it has the extension “.MP3”. • The data is not MPEG 1 Audio Layer 3 data. • The system cannot play audio tracks in MP3PRO format. • The [MODE (MUSIC, IMAGE)] setting has been set to [IMAGE] (page 59). • If you cannot change the [MODE (MUSIC, IMAGE)] setting, re-load the disc or turn the system off, then on. • The DATA CD/DATA DVD contains a DivX video file.
The JPEG image file cannot be played.	<ul style="list-style-type: none"> • The DATA CD is not recorded in a JPEG format that conforms to ISO 9660 Level 1/Level 2, or Joliet. • The DATA DVD is not recorded in a JPEG format that conforms to UDF (Universal Disk Format). • It has an extension other than “.JPEG” or “.JPG”. • It is larger than 3,072 (width) × 2,048 (height) in normal mode, or more than 2,000,000 pixels in Progressive JPEG image file which is mainly used on the Internet website. • It does not fit the TV screen (those images are reduced). • The [MODE (MUSIC, IMAGE)] setting has been set to [MUSIC] (page 59). • If you cannot change the [MODE (MUSIC, IMAGE)] setting, re-load the disc or turn the system off, then on. • The DATA CD/DATA DVD contains a DivX video file.
The MP3 files and JPEG image files start playing simultaneously.	<ul style="list-style-type: none"> • [AUTO] has been selected in [MODE (MUSIC, IMAGE)] (page 59).
The DivX video file cannot be played.	<ul style="list-style-type: none"> • The file is not created in DivX format. • The file has an extension other than “.AVI” or “.DIVX”. • The DATA CD/DATA DVD is not created in a DivX format that conforms to ISO 9660 Level 1/Level 2 or Joliet/UDF. • The DivX video file is larger than 720 (width) × 576 (height).
The titles of folder/file/file name are not displayed correctly.	<ul style="list-style-type: none"> • The system can only display numbers and letters of the alphabets. Other characters are displayed as [*].
A disc does not start playing from the beginning.	<ul style="list-style-type: none"> • Program Play, Shuffle Play, or Repeat Play has been selected. Press CLEAR to cancel these functions before playing a disc. • Resume Play has been selected. During stop, press ■ on the control unit or the remote and then start playback (page 45). • The title, DVD or PBC menu automatically appears on the TV screen.
The system starts playing the disc automatically.	<ul style="list-style-type: none"> • The DVD features an auto playback function.
Playback stops automatically.	<ul style="list-style-type: none"> • Some discs may contain an auto pause signal. While playing such a disc, the system stops playback at the auto pause signal.
You cannot perform some functions such as Stop, Search, Slow-motion Play, or Repeat Play.	<ul style="list-style-type: none"> • Depending on the disc, you may not be able to perform some of the operations stated. Refer to the operating instructions supplied with the disc.

Symptom	Remedy
Messages do not appear on the TV screen in the language you want.	<ul style="list-style-type: none"> In the Setup Display, select the desired language for the on-screen display in [OSD] under [LANGUAGE SETUP] (page 91).
The language for the sound track cannot be changed.	<ul style="list-style-type: none"> Multilingual tracks are not recorded on the DVD being played. The DVD prohibits changing the language for the sound track.
The subtitle language cannot be changed.	<ul style="list-style-type: none"> Multilingual subtitles are not recorded on the DVD being played. The DVD prohibits changing the subtitles.
The subtitles cannot be turned off.	<ul style="list-style-type: none"> The DVD prohibits turning off subtitles.
The angles cannot be changed.	<ul style="list-style-type: none"> Multi-angles are not recorded on the DVD being played (page 54). The DVD prohibits changing the angles.
A disc cannot be ejected and "LOCKED" appears in the front panel display.	<ul style="list-style-type: none"> Contact your Sony dealer or local authorized Sony service facility.
[Data error] appears on the TV screen when playing a DATA CD or DATA DVD.	<ul style="list-style-type: none"> The MP3 file/JPEG image file/DivX video file you want to play is broken. Data is not MPEG 1 Audio Layer 3 data. The JPEG image file format does not conform to DCF. The JPEG image file has the extension ".JPG" or ".JPEG", but is not in JPEG format. The file you want to play has the extension ".AVI" or ".DIVX" but is not in DivX format, or is in DivX format but does not conform to a DivX Certified profiles.
The system does not work normally.	<ul style="list-style-type: none"> Disconnect the AC power cord (mains lead) from the wall outlet (mains), then reconnect after several minutes.
"DEMO PLAY" appears in the front panel display.	<ul style="list-style-type: none"> Contact your Sony dealer or local authorized Sony service facility.
The Control for HDMI function does not work.	<ul style="list-style-type: none"> When "HDMI" does not light up in the front panel display, check the HDMI connection (page 27). Set the [CONTROL FOR HDMI] setting in [HDMI SETUP] to [ON] (pages 71, 93). Make sure that the connected component is compatible with the Control for HDMI function. Check that the AC power cord (mains lead) of the connected component is connected securely. Check the connected component's setting for the Control for HDMI function. Refer to the operating instructions supplied with the component. If you change the HDMI connection, connect and disconnect the AC power cord (mains lead), or have a power failure, set the [CONTROL FOR HDMI] setting in [HDMI SETUP] to [OFF], then set the [CONTROL FOR HDMI] setting in [HDMI SETUP] to [ON] (page 93). For details, see "Using the Control for HDMI Function for "BRAVIA" Sync" (page 70).
No sound is output from the system and TV while using the System Audio Control function.	<ul style="list-style-type: none"> Set the [AUDIO (HDMI)] setting in [HDMI SETUP] to [ON] (page 94). Make sure that the connected TV is compatible with the System Audio Control function. For details, see "Using the Control for HDMI Function for "BRAVIA" Sync" (page 70). Check the connections.

The S-AIR function

Symptom	Remedy
S-AIR connection is not established (sound transmission is not established), e.g., the indicator of the S-AIR sub unit does the following: <ul style="list-style-type: none">• Turns off.• Flashes.• Turns red.	<ul style="list-style-type: none">• If you use another S-AIR main unit, place it more than 8 m away from this S-AIR main unit.• Confirm the ID of the S-AIR main unit and S-AIR sub unit (page 75).• You performed pairing the S-AIR main unit and another S-AIR sub unit. Perform pairing of the desired S-AIR sub unit (page 77).• The S-AIR main unit is paired to another S-AIR sub unit. Cancel pairing.• Install the S-AIR main unit and S-AIR sub unit away from other wireless products.• Stop using another wireless product.• The S-AIR sub unit is turned off. Make sure the AC power cord (mains lead) is connected and turn on the S-AIR sub unit.
No sound is heard from the S-AIR sub unit.	<ul style="list-style-type: none">• If you use another S-AIR main unit, place it more than 8 m away from this S-AIR main unit.• Confirm the ID of the S-AIR main unit and S-AIR sub unit (page 75).• Confirm the pairing setting (page 77).• Install the S-AIR main unit and S-AIR sub unit closer together.• Avoid use of equipment that generates electromagnetic energy, such as a microwave oven.• Install the S-AIR main unit and S-AIR sub unit away from other wireless products.• Stop using another wireless product.• Change the “RF CHANGE” setting (page 79).• Change the ID settings of the S-AIR main unit and S-AIR sub unit.• Turn off the system and S-AIR sub unit, then turn on them.
There is noise or the sound skips.	<ul style="list-style-type: none">• If you use another S-AIR main unit, place it more than 8 m away from this S-AIR main unit.• Install the S-AIR main unit and S-AIR sub unit closer together.• Avoid use of equipment that generates electromagnetic energy, such as a microwave oven.• Install the S-AIR main unit and S-AIR sub unit away from other wireless products.• Stop using another wireless product.• Change the “RF CHANGE” setting (page 79).• Change the ID settings of the S-AIR main unit and S-AIR sub unit.



Surround amplifier operation

If no sound is output from the surround speakers, check the status of the POWER / ON LINE indicator on the surround amplifier. For details of the POWER / ON LINE indicator, see “Step 3: Setting up the Wireless System” (page 32).

Symptom	Remedy
The power is not turned on.	<ul style="list-style-type: none"> • Check that the AC power cord (mains lead) is connected securely.
The POWER / ON LINE indicator does not turn on.	<p>Turn off the surround amplifier and remove the AC power cord (mains lead) of the surround amplifier, then check the following items.</p> <ul style="list-style-type: none"> • Are the + and – speaker cords short-circuited? • Is anything blocking the ventilation holes of the surround amplifier? • After checking the above items and fixing any problems, connect the AC power cord (mains lead) of the surround amplifier and turn on the surround amplifier. If the cause of the problem cannot be found even after checking all the above items, consult your nearest Sony dealer.
There is no sound. Check the status of the POWER / ON LINE indicator on the surround amplifier.	<ul style="list-style-type: none"> • turns green <ul style="list-style-type: none"> – The speaker cord is not connected securely. – Check the speaker connections and settings. – The volume of the system is set to minimum. – The S-AIR main unit is in mute status. – Depending on the source or the settings of the unit, the effect of the speakers may be less noticeable. – Headphones are connected. • flashes green <ul style="list-style-type: none"> – The S-AIR main unit is not turned on. – You performed pairing the S-AIR main unit and another S-AIR sub unit. – The surround amplifier is paired to another S-AIR main unit. – Confirm the IDs of the S-AIR main unit and surround amplifier (page 75). – Pairing operation is not completed. – Sound transmission is poor. Move the surround amplifier so that the POWER / ON LINE indicator turns green. – Install the subwoofer and surround amplifier apart from another wireless product. – Stop using another wireless product. – The wireless transceiver(s) is/are not inserted correctly. • turns red <ul style="list-style-type: none"> – Change the SURROUND SELECTOR switch (SURROUND or SURROUND BACK) of the surround amplifier to match the S-AIR main unit.
“HP NO LINK” and “VOLUME MIN” appear alternately in the front panel display, and the volume of the unit becomes minimum.	<ul style="list-style-type: none"> • Volume becomes the minimum when you turn off the surround amplifier with headphones connected before you turn off the system or if radio reception is poor. In these cases, check radio reception, and set the volume again.

Self-diagnosis Function

(When letters/numbers appear in the display)

When the self-diagnosis function is activated to prevent the system from malfunctioning, a 5-character service number (e.g., C 13 50) with a combination of a letter and 4 digits appears on the TV screen or front panel display. In this case, check the following table.

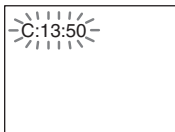

First 3 characters of the service number	Cause and/or corrective action
C 13	<ul style="list-style-type: none">• The disc is dirty. ➔ Clean the disc with a soft cloth (page 101).• The disc is a format that the system cannot play.
C 31	<p>The disc is not inserted correctly.</p> <p>➔ Restart the system, then re-insert the disc correctly.</p>
E XX (xx is a number)	<p>To prevent a malfunction, the system has performed the self-diagnosis function.</p> <p>➔ Contact your nearest Sony dealer or local authorized Sony service facility and give the 5-character service number.</p> <p>Example: E 61 10</p>

When displaying the version number on the TV screen

When you turn on the system, the version number [VER.X.XX] (X is a number) may appear on the TV screen. Although this is not a malfunction and for Sony service use only, normal system operation will not be possible. Turn off the system, and then turn on the system again to operate.



Specifications

Amplifier section

Power output (rated)	
Front L / Front R (rated):	35 W + 35 W (at 10 ohms, 1 kHz, 1 % THD)
RMS output power (reference)	
Front L / Front R*:	50 W + 50 W (at 10 ohms, 1 kHz, 10 % THD)
Center*:	50 W (at 10 ohms, 1 kHz, 10 % THD)
Surround L / Surround R*:	50 W + 50 W (at 10 ohms, 1 kHz, 10 % THD)
Subwoofer*:	100 W (at 4 ohms, 70 Hz, 10 % THD) + 100 W (at 4 ohms, 500 Hz, 10 % THD)

* Depending on the decoding mode settings and the source, there may be no sound output.

Inputs (Analog)	
TV (AUDIO IN)	Sensitivity: 450/250 mV
Inputs (Digital)	
SAT/CABLE (COAXIAL IN)	Impedance: 75 ohms

DVD system

Laser	Semiconductor laser (DVD: $\lambda = 645 - 660$ nm) (CD: $\lambda = 770 - 800$ nm) Emission duration: continuous
Signal format system	NTSC / PAL

Tuner section

System	PLL quartz-locked digital synthesizer
FM tuner section	
Tuning range	87.5 – 108.0 MHz (50 kHz step)
Antenna (aerial)	FM wire antenna (aerial)
Antenna (aerial) terminals	75 ohms, unbalanced
Intermediate frequency	10.7 MHz
AM tuner section	
Tuning range	531 – 1,602 kHz (with the interval set at 9 kHz)
Antenna (aerial)	AM loop antenna (aerial)
Intermediate frequency	450 kHz

Video section

Outputs	VIDEO: 1 Vp-p 75 ohms COMPONENT: Y: 1 Vp-p 75 ohms P _B /C _B , Pr/Cr: 0.7 Vp-p 75 ohms HDMI OUT: Type A (19 pin)
---------	---

Speakers

Front/Center/Surround (SS-IS15)

Speaker system	Full range speaker system
Speaker unit	35 mm
Rated impedance	10 ohms
Dimensions (approx.)	45 × 55 × 40 mm (w/h/d)
Mass (approx.)	0.07 kg
Speaker cords	4.5 m × 2, 3 m × 1, 12 m × 2

Subwoofer (SA-WSIS50)

Speaker system	2 Way 2 Drivers Subwoofer speaker system
Speaker unit	120 mm × 160 mm
Rated impedance	4 ohms
Dimensions (approx.)	190 × 450 × 472 mm (w/h/d)
Mass (approx.)	13.5 kg
Power requirements	220 – 240 V AC, 50/60 Hz
Power consumption	On: 130 W Standby: 0.3 W (at the Power Saving mode)

Control unit (HCD-IS50)

Dimensions (approx.)	215 × 105 × 207 mm (w/h/d)
Mass (approx.)	3.0 kg
Power output (DIGITAL MEDIA PORT)	DC OUT: 5 V, 700 mA

Surround amplifier (TA-SA100WR)

Amplifier section	
Stereo mode (rated)	80 W + 80 W (at 3 ohms, 1 kHz, 1 % THD)
Surround mode (reference)	RMS output power 143 W (per channel at 3 ohms, 1 kHz, 10 % THD)*

* Depending on the source, there may be no sound output.

Rated impedance:	3 – 16 Ω
General	
Power requirements	220 – 240 V AC, 50/60 Hz
Power consumption	On: 50 W
Dimensions (approx.)	85 × 100 × 330 mm (w/h/d) (including EZW-RT10) 85 × 100 × 345 mm (w/h/d) including speaker cord cover and speaker cord holder
Mass (approx.)	1.7 kg including speaker cord cover and speaker cord holder

Wireless transceiver (EZW-RT10)

Communication system	S-AIR Specification version 1.0
Output	12.0 mW
Frequency band	2.4000 GHz – 2.4835 GHz
Modulation method	DSSS
Power requirements	DC 3.3 V, 350 mA
Dimensions (approx.)	50 × 13 × 60 mm (w/h/d)
Mass (approx.)	24 g

Wireless transmitter (EZW-T100)

Communication system	S-AIR Specification version 1.0
Output	12.0 mW
Frequency band	2.4000 GHz – 2.4835 GHz
Modulation method	DSSS
Power requirements	DC 4 V, 550 mA DC 5 V, 15 mA
Dimensions (approx.)	52 × 24 × 95 mm (max. 77 × 24 × 95 mm) (w/h/d)
Mass (approx.)	61 g

Design and specifications are subject to change without notice.



- Standby power consumption 0.3 W.
- Halogenated flame retardants are not used in the printed wiring boards.
- Over 85 % power efficiency of amplifier block is achieved with the full digital amplifier, S-master.

Glossary

Digital Cinema Auto Calibration

Digital Cinema Auto Calibration was developed by Sony to automatically measure and adjust the speaker settings to your listening environment in a short period of time.

Dolby Digital

This movie theatre sound format is more advanced than Dolby Surround Pro Logic. In this format, the surround speakers output stereo sound with an expanded frequency range, and a subwoofer channel for deep bass is independently provided. This format is also called “5.1” with the subwoofer channel designed as the 0.1 channel (since it functions only when a deep bass effect is needed). All six channels in this format are recorded separately for superior channel separation. Furthermore, since all the signals are processed digitally, less signal degradation occurs.

Dolby Pro Logic II

Dolby Pro Logic II creates 5 full-bandwidth output channels from 2 channel sources. This is done using an advanced, high-purity matrix surround decoder that extracts the spatial properties of the original recording without adding any new sounds or tonal colourations.

■ Movie mode

The Movie mode is for use with stereo television shows and all programs encoded in Dolby Surround. The result is enhanced sound field directionality that approaches the quality of discrete 5.1-channel sound.

■ Music mode

The Music mode is for use with any stereo music recordings, and provides a wide and deep sound space.

DTS

Digital audio compression technology developed by DTS, Inc. This technology conforms to 5.1-channel surround. This format comprises of stereo rear channel and there is discrete subwoofer channel in this format. DTS provides the same 5.1 discrete channels of high quality digital audio. The good channel separation is realized due to the all channel data being recorded discretely and processed in digitally.

HDMI (High-definition multimedia interface)

HDMI is an interface that supports both video and audio on a single digital connection, allowing you to enjoy high quality digital picture and sound. The HDMI specification supports HDCP (high-bandwidth digital contents protection), a copy protection technology that incorporates coding technology for digital video signals.

Interlace format (Interlaced scanning)

The Interlace format is the NTSC standard method for displaying TV images at 30 frames per second. Each frame is scanned twice - alternately between the even numbered scanning lines and then odd numbered scanning lines, at 60 times per second.

Parental Control

A DVD function to limit playback of the disc by users of a predetermined age according to the limitation level in each country. The limitation varies from disc to disc; when it is activated, playback is completely prohibited, violent scenes are skipped or replaced with other scenes, etc.

Progressive format (Sequential scanning)

In contrast to the Interlace format, the progressive format can reproduce 50 - 60 frames per second by reproducing all scanning lines (525 lines for the NTSC system). The overall picture quality increases and still images, text and horizontal lines appear sharper.

S-AIR

(Sony Audio Interactive Radio frequency)

Recent times have seen the rapid spread of DVD media, Digital Broadcasting, and other high-quality media.

To ensure that the subtle nuances of these high-quality media are transmitted with no deterioration, Sony has developed a technology called "S-AIR" for the radio transmission of digital audio signals with no compression, and has incorporated this technology into the EZW-RT10/EZW-T100.

This technology transfers digital audio signals with no compression using the 2.4 GHz band range of ISM band (Industrial, Scientific, and Medical band), such as wireless LANs and Bluetooth applications.

Language Code List

The language spellings conform to the ISO 639: 1988 (E/F) standard.

Code Language	Code Language	Code Language	Code Language
1027 Afar	1183 Irish	1347 Maori	1507 Samoan
1028 Abkhazian	1186 Scots Gaelic	1349 Macedonian	1508 Shona
1032 Afrikaans	1194 Galician	1350 Malayalam	1509 Somali
1039 Amharic	1196 Guarani	1352 Mongolian	1511 Albanian
1044 Arabic	1203 Gujarati	1353 Moldavian	1512 Serbian
1045 Assamese	1209 Hausa	1356 Marathi	1513 Siswati
1051 Aymara	1217 Hindi	1357 Malay	1514 Sesotho
1052 Azerbaijani	1226 Croatian	1358 Maltese	1515 Sundanese
1053 Bashkir	1229 Hungarian	1363 Burmese	1516 Swedish
1057 Byelorussian	1233 Armenian	1365 Nauru	1517 Swahili
1059 Bulgarian	1235 Interlingua	1369 Nepali	1521 Tamil
1060 Bihari	1239 Interlingue	1376 Dutch	1525 Telugu
1061 Bislama	1245 Yidpiak	1379 Norwegian	1527 Tajik
1066 Bengali;	1248 Indonesian	1393 Occitan	1528 Thai
Bangla	1253 Icelandic	1403 (Afan)Oromo	1529 Tigrinya
1067 Tibetan	1254 Italian	1408 Oriya	1531 Turkmen
1070 Breton	1257 Hebrew	1417 Punjabi	1532 Tagalog
1079 Catalan	1261 Japanese	1428 Polish	1534 Setswana
1093 Corsican	1269 Yiddish	1435 Pashto;	1535 Tonga
1097 Czech	1283 Javanese	Pushto	1538 Turkish
1103 Welsh	1287 Georgian	1436 Portuguese	1539 Tsonga
1105 Danish	1297 Kazakh	1463 Quechua	1540 Tatar
1109 German	1298 Greenlandic	1481 Rhaeto-	1543 Twi
1130 Bhutani	1299 Cambodian	Romance	1557 Ukrainian
1142 Greek	1300 Kannada	1482 Kirundi	1564 Urdu
1144 English	1301 Korean	1483 Romanian	1572 Uzbek
1145 Esperanto	1305 Kashmiri	1489 Russian	1581 Vietnamese
1149 Spanish	1307 Kurdish	1491 Kinyarwanda	1587 Volapük
1150 Estonian	1311 Kirghiz	1495 Sanskrit	1613 Wolof
1151 Basque	1313 Latin	1498 Sindhi	1632 Xhosa
1157 Persian	1326 Lingala	1501 Sangho	1665 Yoruba
1165 Finnish	1327 Laothian	1502 Serbo-	1684 Chinese
1166 Fiji	1332 Lithuanian	Croatian	1697 Zulu
1171 Faroese	1334 Latvian;	1503 Singhalese	
1174 French	Lettish	1505 Slovak	
1181 Frisian	1345 Malagasy	1506 Slovenian	1703 Not specified

Parental Control Area Code List

Code Area	Code Area	Code Area	Code Area
2044 Argentina	2165 Finland	2362 Mexico	2149 Spain
2047 Australia	2174 France	2376 Netherlands	2499 Sweden
2046 Austria	2109 Germany	2390 New Zealand	2086 Switzerland
2057 Belgium	2248 India	2379 Norway	2528 Thailand
2070 Brazil	2238 Indonesia	2427 Pakistan	2184 United Kingdom
2079 Canada	2254 Italy	2424 Philippines	
2090 Chile	2276 Japan	2436 Portugal	
2092 China	2304 Korea	2489 Russia	
2115 Denmark	2363 Malaysia	2501 Singapore	

Index to Parts and Controls

For more information, refer to the pages indicated in parentheses.

Control unit (front panel)

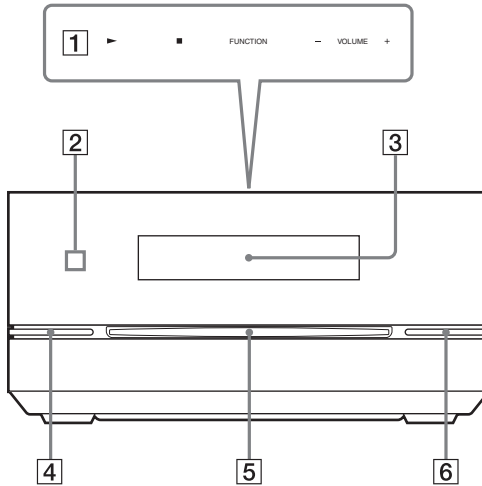

- | | |
|--|------------------------------------|
| 1 Soft-touch buttons (▶/■/FUNCTION/
VOLUME -/+) (38) | 4 I/⏻ (on/standby) (34, 99) |
| 2 Remote sensor (11) | 5 Disc slot (39) |
| 3 Front panel display (117) | 6 ▲ (eject) (40) |

Control unit (rear panel)

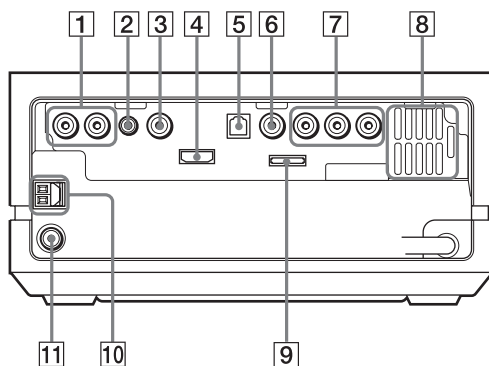

- | | |
|--|------------------------------------|
| 1 TV (AUDIO IN R/L) jacks (27) | 6 VIDEO OUT (VIDEO) jack (27) |
| 2 ECM-AC2 jack (88) | 7 VIDEO OUT (COMPONENT) jacks (27) |
| 3 SAT/CABLE (DIGITAL IN COAXIAL) jack (28) | 8 Ventilation slots |
| 4 HDMI OUT jack (27) | 9 DMPORT jack (28) |
| 5 TV (DIGITAL IN OPTICAL) jack (27) | 10 AM terminals (30) |
| | 11 FM 75Ω COAXIAL jack (30) |

Front Panel Display

About the indications in the front panel display

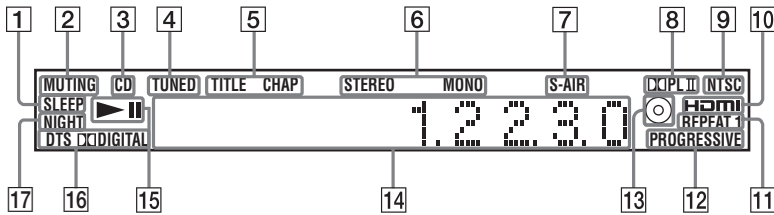

- 1 Flashes when the sleep timer is set. (83)
- 2 Lights up when muting function is activated.
- 3 Lights up when a CD or a DATA CD is loaded.
- 4 Lights up when a station is received. (Radio only) (67)
- 5 Lights up when the time information of a title or chapter appears in the front panel display. (DVD only) (52)
- 6 Stereo/Monaural effect. (Radio only) (68)
- 7 Lights up when the S-AIR transmitter (not supplied) is inserted in the subwoofer and the system transmits the sound.
- 8 Current surround format (Except for JPEG)
- 9 Lights up when the colour system is set to NTSC.
- 10 Lights up when the HDMI OUT jack is correctly connected to HDCP (high-bandwidth digital content protection) compliant device with HDMI or DVI (digital visual interface) input. (27)
- 11 Current repeat mode. (48)
- 12 Lights up when the system outputs progressive signals (DVD function only). (92)
- 13 Lights up when a disc is loaded (DVD function only).
- 14 Displays system's status such as chapter, title, or track number, time information, radio frequency, playing status, decoding mode, etc.
- 15 Playing status (DVD function only)
- 16 Current surround format (Except for JPEG)
- 17 Lights up when the night mode is on. (83)

Subwoofer

Bottom of the subwoofer

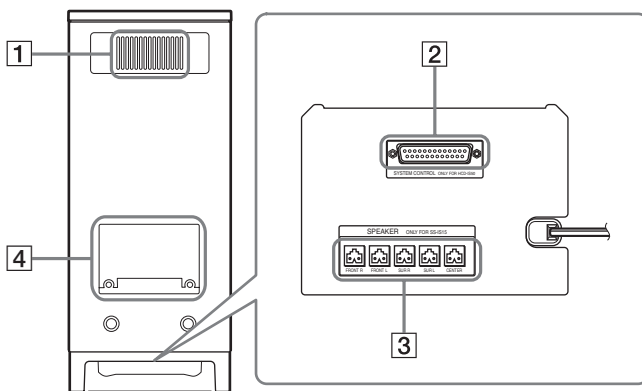

- 1 Ventilation slots
- 2 SYSTEM CONTROL jack (22)
- 3 SPEAKER jacks (23)
- 4 EZW-T100 slot (23)

⚠ CAUTION

Please do not remove the screws before installing the EZW-T100.

Surround amplifier

Front panel

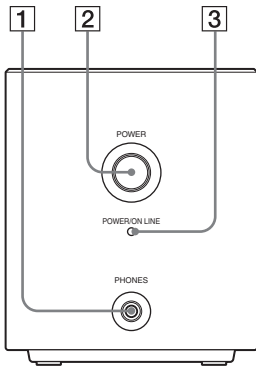

Rear panel

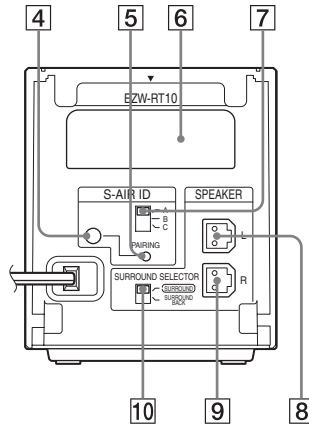

- 1 PHONES jack (32)
- 2 POWER (ON/OFF) (32)
- 3 POWER / ON LINE indicator (32)
- 4 PAIRING indicator (78)
- 5 PAIRING button (78)

- 6 Wireless transceiver (EZW-RT10) slot (26)
- 7 S-AIR ID switch (32)
- 8 SPEAKER L jack (23)
- 9 SPEAKER R jack (23)
- 10 SURROUND SELECTOR switch (32)

Remote control

ALPHABETICAL ORDER		BUTTON DESCRIPTIONS
A - O	P - Z	
ANALOG ⁴⁾ [5]	PICTURE NAVI [28]	Numeric buttons ³⁾⁴⁾ [7]
ANGLE [9]	PRESET +/- [15]	I/⏻ (on/standby) [2]
AUDIO ³⁾ [27]	PROG +/- ³⁾⁴⁾ [19]	TV I/⏻ (on/standby) [1]
CLEAR [29]	REPEAT [6]	⏪/⏩/⏴/⏵ (+) ¹⁾⁴⁾ [12]
D.TUNING [10]	SLEEP [33]	◀•/•▶ REPLAY/ADVANCE [16]
DIGITAL ⁴⁾ [6]	SOUND MODE +/- ³⁾ [19]	⏮/⏭/⏪ [15]
DIMMER [5]	SUBTITLE [10]	⏩/⏭/⏮ [23]
DISPLAY [3]	SYSTEM MENU [13]	◀/▶ [23]
DVD MENU [11]	THEATRE [34]	▷ ³⁾ [24]
DVD TOP MENU [26]	TONE [30]	■ [17]
ENTER [8]	TOOLS/OPTIONS ⁴⁾ [13]	▬ [18]
FUNCTION [4]	TUNING +/- [23]	☐ DISPLAY ²⁾ [14]
MENU/HOME ⁴⁾ [14]	TV [22]	▲ [32]
MUTING ⁴⁾ [21]	TV VOL +/- ⁴⁾ [20]	-./- ⁴⁾ [8]
NIGHT [31]	VOLUME +/- [20]	↻ RETURN ⁴⁾ [25]
ONE-TOUCH PLAY [35]		(+/?) ⁴⁾ [3]
		→/⊕ ⁴⁾ [11]
		≡ ⁴⁾ [26]
		☰ ⁴⁾ [29]
		⏪/⏩ ⁴⁾ [19]

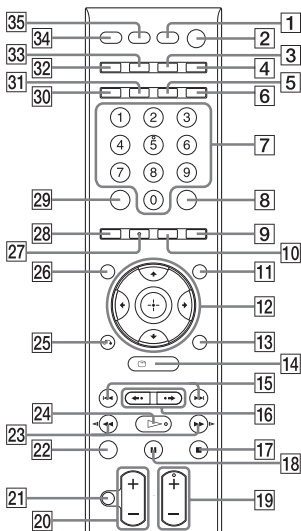

- 1) The ENTER button has the same function as the ⊕ button. When you operate the TV, the ENTER button is used for selecting a channel, and the button ⊕ is used for selecting menu items.
- 2) This button is only available for the “DVD” or “DMPORT” function. Depending on the DIGITAL MEDIA PORT adapter, this button may not work.
- 3) The 5, ▷, PROG +/SOUND MODE, and AUDIO buttons have tactile dots. Use the tactile dots as references when operating the system.
- 4) These buttons change to the TV operation buttons when the remote is in TV mode. The remote is in TV mode when TV button [22] is lights up.

Guide to the Control Menu Display

You can use the Control Menu display to select a function and to view related information.

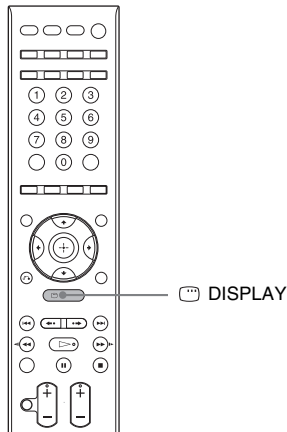

Press  **DISPLAY** repeatedly.

Each time you press  **DISPLAY**, the Control Menu display changes:

① → ② → ... → ① → ...

- ① Control Menu display 1
- ② Control Menu display 2 (appears for certain disc only)
- ③ Control Menu display off

Note

- The Control Menu Display appears only during the “DVD” function.

Control Menu display

The Control Menu display 1 and 2 will show different items depending on the disc type. For details about each item, see the pages in parentheses.

Example: Control Menu display 1 when playing a DVD VIDEO.

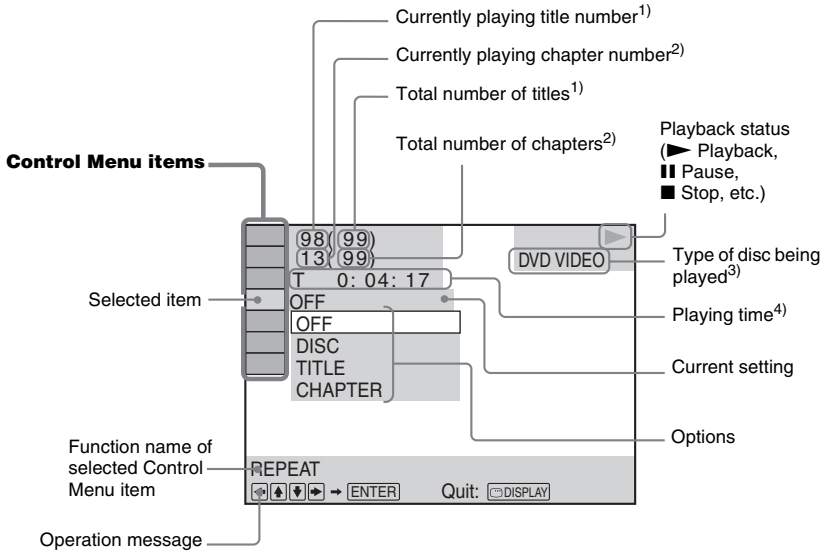

¹⁾ The scene number for a VIDEO CD (PBC is on), track number for VIDEO CD/CD, folder number for a DATA CD/DATA DVD.

²⁾ The index number for a VIDEO CD, MP3 file number or JPEG image file number for a DATA CD/DATA DVD.

³⁾ Super VCD as "SVCD".

"MP3" in the Control Menu display 1 or "JPEG" in the Control Menu display 2 for DATA CD/DATA DVD.











⁴⁾ The date is displayed for JPEG image files (for certain JPEG image files only).

To turn off the display

Press DISPLAY.

List of Control Menu items

Item	Item Name, Function, Relevant Disc Type
	[TITLE] (page 44)/[SCENE] (page 44)/[TRACK] (page 44) You can select the title, scene, or track to be played.
	[CHAPTER] (page 44)/[INDEX] (page 44) You can select the chapter or index to be played.
	[TRACK] (page 44) You can select the track to be played.
	[ORIGINAL/PLAY LIST] (page 51) You can select the type of titles (DVD-RW/DVD-R) to be played, the [ORIGINAL] one, or an edited [PLAY LIST].
	[TIME] (page 44) You can check the elapsed time and the remaining playback time. Input the time code for picture and music searching.
	[PROGRAM] (page 46) You can select the track to play in the order you want.

	[SHUFFLE] (page 47) You can play the track/file in random order. VIDEO CD C D DATA-CD DATA DVD
	[REPEAT] (page 48) You can play the entire disc (all titles/all tracks/all folders/all files) repeatedly or one title/ chapter/track/folder/file repeatedly. DVD-V DVD-VR VIDEO CD C D DATA-CD DATA DVD
	[DISC MENU] (page 49) You can display the DVD's menu. DVD-V
	[BROWSING] (page 58) You can display the list of folders/JPEG image files. DATA-CD DATA DVD
	[SETUP] (page 90) [CUSTOM] In addition to the Quick Setup setting, you can adjust various other settings. [QUICK] (page 34) You can make the basic adjustments. Use Quick Setup to select the desired language of the on-screen display, the aspect ratio of the TV, and select yes or no to start the Auto Calibration. DVD-V DVD-VR VIDEO CD C D DATA-CD DATA DVD
	[FOLDER] (page 44) You can select the folder to be played. DATA-CD DATA DVD
	[FILE] (page 44) You can select the JPEG image file or DivX video file to be played. DATA-CD DATA DVD
 *	[DATE] (page 54) You can display the date the picture was taken by a digital camera. DATA-CD DATA DVD
 *	[INTERVAL] (page 59) You can select the duration for which the slides are displayed on the TV screen. DATA-CD DATA DVD
 *	[EFFECT] (page 60) You can select the effects to be used for changing slides during a slide show. DATA-CD DATA DVD
 *	[MODE (MUSIC, IMAGE)] (page 59) You can select the data type: MP3 file, JPEG image file, or both to be played when playing a DATA CD/DATA DVD. DATA-CD DATA DVD

* These items are not listed when playing a DATA CD/DATA DVD with DivX video file.

Tip

- The Control Menu icon indicator lights up in yellow  →  when you select any item except [OFF] ([PROGRAM], [SHUFFLE] and [REPEAT] only). The [ORIGINAL/PLAY LIST] indicator lights up in yellow when you select [PLAY LIST] (default setting).

Index

Numerics

- 16:9 91
- 4:3 LETTER BOX 91
- 4:3 OUTPUT 92
- 4:3 PAN SCAN 91
- 5.1 Channel Surround 51

A

- A/V SYNC 55
- ANGLE 54
- ATTENUATE 42
- AUDIO 50
- AUDIO (HDMI) 94
- AUDIO DRC 95
- AUDIO SETUP 94
- AUTO CALIBRATION 88, 94

B

- BACKGROUND 96
- BASS 66
- Batteries 11

C

- CHAPTER 44
- CONNECTION 96
- Control for HDMI 70, 93
- Control Menu Display 121
- Control unit 115, 116
- CUSTOM 90, 99

D

- D.C.A.C. (Digital Cinema Auto Calibration) 88, 94, 112
- DATA CD 6
- DATA DVD 6
- Decoding mode 63
- DIGITAL IN 95
- DIGITAL MEDIA PORT 28, 73
- DIMMER 84
- DISPLAY 52, 69
- DISTANCE 97
- DivX 60, 96
- Dolby Digital 51, 112
- Dolby Pro Logic II 112
- DTS 113
- DUAL MONO 82
- DVD's menu 49

E

- EFFECT 60

F

- FM Mode 68
- Front panel 115
- Front panel display 84, 117

H

- HDMI (high-definition multimedia interface) 113
- HDMI SETUP 93
- HDMI YCBCR/RGB (HDMI) 93

I

- ILLUMINATION MODE 85
- INFORMATION MODE 84
- Installing the speakers on a wall 15
- Instant advance 40
- Instant replay 40
- Interlace format 113
- INTERVAL 59

J

- JPEG image file 56
- JPEG RESOLUTION 94

L

- Language Code List 114
- LANGUAGE SETUP 91
- LEVEL 98

M

- MENU 91
- MIDDLE 66
- MODE (MUSIC, IMAGE) 59
- MP3 56
- Multi Session CD 8
- MULTI-DISC RESUME 45, 96
- Multiplex broadcast sound 82
- MUTING 40

N

- Naming preset stations 69
- NIGHT MODE 83

O

- OMNI-DIRECTIONAL SOUND 65
- ORIGINAL 51
- OSD 91

P

- PARENTAL CONTROL 86, 96, 114
- Parental Control 113
- PAUSE MODE 92
- PBC Playback 62
- PICTURE NAVI 57
- PLAY LIST 51
- Playable Discs 6
- Program Play 46
- PROGRESSIVE (COMPONENT OUT) 92
- Progressive format 37, 113

Q

- Quick Setup 34

R

- RDS 70
- Rear panel 116
- Region Code 8
- Remote 11, 120
- Repeat Play 48
- RESET 96, 99
- Resume Play 45

S

- S-AIR 113
- S-AIR SETUP 94
- S-AIR STBY 76
- SCREEN SAVER 95
- SETUP 90, 99
- Shuffle Play 47
- SLEEP 83
- Slide Show 59
- Slow-motion Play 40
- Soft-touch button 38
- Sound Mode 65
- SPEAKER SETUP 96
- SUBTITLE 91
- Subwoofer 118
- SYSTEM MENU 42, 43, 63, 64, 67, 68, 69, 76, 79, 84, 85
- SYSTEM SETUP 95

T

TEST TONE 98
TRACK SELECTION 95
TREBLE 66
Troubleshooting 102
TV connection 26
TV TYPE 91

U

Unpacking 10

V

VIDEO SETUP 91
VOLUME LIMIT 93

Free Manuals Download Website

<http://myh66.com>

<http://usermanuals.us>

<http://www.somanuals.com>

<http://www.4manuals.cc>

<http://www.manual-lib.com>

<http://www.404manual.com>

<http://www.luxmanual.com>

<http://aubethermostatmanual.com>

Golf course search by state

<http://golfingnear.com>

Email search by domain

<http://emailbydomain.com>

Auto manuals search

<http://auto.somanuals.com>

TV manuals search

<http://tv.somanuals.com>